

DrayTek

Vigor167

35b Modem



USER'S GUIDE

V1.1

Vigor 167

35b Modem

User's Guide

Version: 1.1

Firmware Version: V5.1.1

Date: May 25, 2022

Intellectual Property Rights (IPR) Information

Copyrights

© All rights reserved. This publication contains information that is protected by copyright. No part may be reproduced, transmitted, transcribed, stored in a retrieval system, or translated into any language without written permission from the copyright holders.

Trademarks

The following trademarks are used in this document:

- Microsoft is a registered trademark of Microsoft Corp.
- Windows 8, 10 and Explorer are trademarks of Microsoft Corp.
- Apple and Mac OS are registered trademarks of Apple Inc.
- Other products may be trademarks or registered trademarks of their respective manufacturers.

Safety Instructions and Approval

Safety Instructions

- Read the installation guide thoroughly before you set up the modem.
- The modem is a complicated electronic unit that may be repaired only be authorized and qualified personnel. Do not try to open or repair the modem yourself.
- Do not place the modem in a damp or humid place, e.g. a bathroom.
- The modem should be used in a sheltered area, within a temperature range of +5 to +40 Celsius.
- Do not expose the modem to direct sunlight or other heat sources. The housing and electronic components may be damaged by direct sunlight or heat sources.
- Do not deploy the cable for LAN connection outdoor to prevent electronic shock hazards.
- Keep the package out of reach of children.
- When you want to dispose of the modem, please follow local regulations on conservation of the environment.

Warranty

We warrant to the original end user (purchaser) that the modem will be free from any defects in workmanship or materials for a period of two (2) years from the date of purchase from the dealer. Please keep your purchase receipt in a safe place as it serves as proof of date of purchase. During the warranty period, and upon proof of purchase, should the product have indications of failure due to faulty workmanship and/or materials, we will, at our discretion, repair or replace the defective products or components, without charge for either parts or labor, to whatever extent we deem necessary to restore the product to proper operating condition. Any replacement will consist of a new or re-manufactured functionally equivalent product of equal value, and will be offered solely at our discretion. This warranty will not apply if the product is modified, misused, tampered with, damaged by an act of God, or subjected to abnormal working conditions. The warranty does not cover the bundled or licensed software of other vendors. Defects which do not significantly affect the usability of the product will not be covered by the warranty. We reserve the right to revise the manual and online documentation and to make changes from time to time in the contents hereof without obligation to notify any person of such revision or changes.

Be a Registered Owner

Web registration is preferred. You can register your Vigor router via <https://myvigor.draytek.com>.

Firmware & Tools Updates

Due to the continuous evolution of DrayTek technology, all modems will be regularly upgraded. Please consult the DrayTek web site for more information on newest firmware, tools and documents. <https://www.draytek.com>

Table of Contents

Chapter I Installation	VII
I-1 Introduction	1
I-1-1 LED Indicators and Connectors	1
I-2 Hardware Installation	3
I-2-1 Network Connection	3
I-2-2 Wall-Mounted Installation	4
I-3 Accessing to Web User Interface	5
I-5 Changing Password	7
I-6 Dashboard	8
Chapter II Connectivity	9
II-1 Operation Mode: Modem Mode	10
II-1-1 Physical Interface	15
II-1-2 WAN	17
II-1-3 LAN	20
II-1-4 Routing	22
II-2 Operation Mode: Router Mode	24
II-2-1 Physical Interface	29
II-2-2 WAN	32
II-2-2-1 WAN Connections	32
II-2-2-2 Virtual WAN	37
II-2-2-3 Dynamic DNS	40
II-2-3 LAN	43
II-2-3-1 LAN Networks	43
II-2-3-2 Bind IP to MAC	46
II-2-3-3 DHCP Options	47
II-2-4 Routing	48
II-2-4-1 IPv4 Static Route	48
II-2-4-2 RIP	50
II-2-5 NAT	51
II-2-5-1 Port Forwarding	51
II-2-5-2 DMZ	54
II-2-5-3 Port Triggering	55
II-2-5-4 ALG	57
II-2-5-5 UPnP	58
II-2-6 IGMP	59
II-2-6-1 IGMP Setup	59
II-2-6-2 IGMP Status	60
II-2-7 Objects	60
II-2-7-1 IP Object	60
II-2-7-2 IP Group	62
II-2-7-3 Schedule	64
II-2-8 Certificates	66
II-2-8-1 Local Certificates	66
II-2-8-2 Trusted CA	69

II-2-8-3 Local Services	72
II-2-8-4 Backup & Restore	73
Chapter III Management	75
III-1 System Maintenance.....	76
III-1-1 Device Settings	76
III-1-1-1 Time	76
III-1-1-2 Device Name	78
III-1-1-3 Syslog	78
III-1-2 Management.....	79
III-1-2-1 Service Control.....	79
III-1-2-2 TR-069	81
III-1-3 Firmware	83
III-1-4 Backup and Restore.....	85
III-1-5 Accounts	87
III-1-6 System Reboot.....	89
III-1-7 Registration & Services.....	90
III-1-7-1 Registration & Services	90
III-1-7-2 Services Status	94
Chapter IV Others	97
IV-1 Monitoring.....	98
IV-1-1 DSL Status	98
IV-1-1-1 DSL Information	98
IV-1-1-2 Tone Information	99
IV-1-2 Route Table.....	100
IV-1-3 DHCP Table	100
IV-1-3-1 IPv4 DHCP Subnet	100
IV-1-3-2 IPv4 DHCP Lease.....	101
IV-1-4 ARP Table	101
IV-1-4-1 LAN	101
IV-1-4-2 WAN.....	102
IV-1-5 DNS Cache Table.....	102
IV-1-6 Session Table	102
IV-1-7 Web Syslog.....	103
IV-2 Utility	105
IV-2-1 Ping Tool.....	105
Chapter V Troubleshooting	107
V-1 Checking the Hardware Status	108
V-2 Checking the Network Connection Settings	109
V-2-1 For Windows	109
V-2-2 For Mac Os	111
V-3 Pinging the Device	112
V-3-1 For Windows	112
V-3-2 For Mac Os (Terminal)	112
V-4 Backing to Factory Default Setting.....	114
V-4-1 Software Reset.....	114
V-4-2 Hardware Reset.....	115

V-5 Contacting DrayTek 116

Chapter I Installation



I-1 Introduction

This is a generic International version of the user guide. Specification, compatibility and features vary by region. For specific user guides suitable for your region or product, please contact local distributor.

I-1-1 LED Indicators and Connectors

Before you use the Vigor modem, please get acquainted with the LED indicators and connectors first.

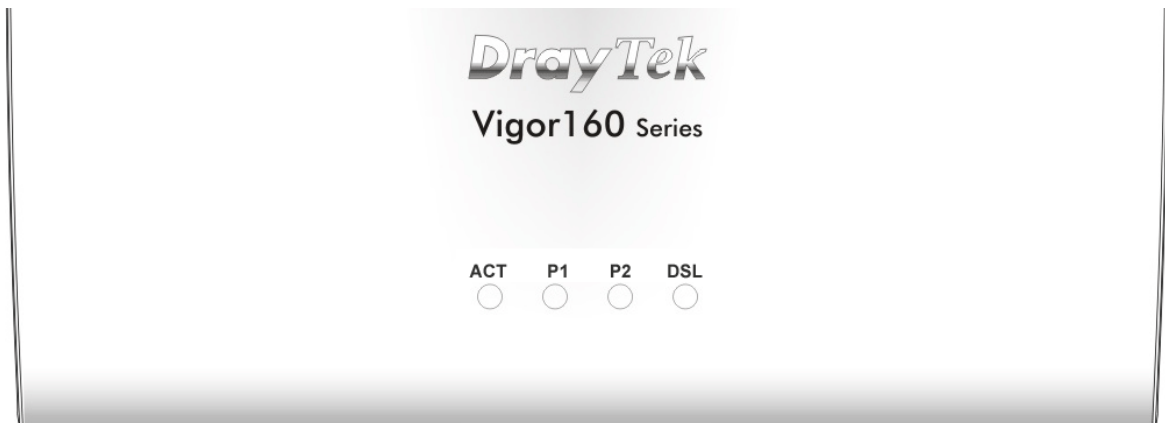

LED	Status	Explanation
ACT	Off	The system is not ready or is failed.
	Blinking	The system is ready and can work normally.
P1/P2	On	A normal connection is through its corresponding port.
	Off	LAN is disconnected.
	Blinking	Data is transmitting (sending/receiving).
DSL	On	xDSL connection synchronized.
	Blinking	xDSL connection is synchronizing.

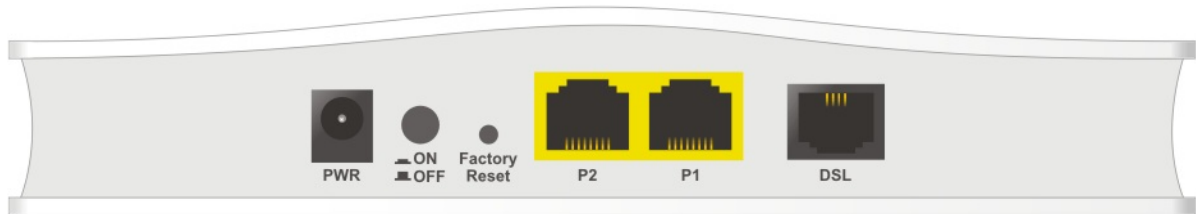

Interface	Explanation
PWR	Connector for a power adapter.
ON/OFF	ON/OFF: Power switch.
Factory Reset	Restore the default settings. Usage: Turn on the modem. Press the button and keep it for more than 10 seconds. Then the modem will restart with the factory default configuration.
P2-P1	Connector for local networked devices.
DSL	Connector for accessing the Internet through xDSL.

i Note

Remove the protective film from the router before use to ensure ventilation.

I-2 Hardware Installation

This section will guide you to install the Vigor167 through a hardware connection and configure the device's settings through the web browser.

Before starting to configure Vigor167, you have to connect your devices correctly.

I-2-1 Network Connection

1. Connect the DSL interface to the MODEM port of the external splitter with a DSL line cable.

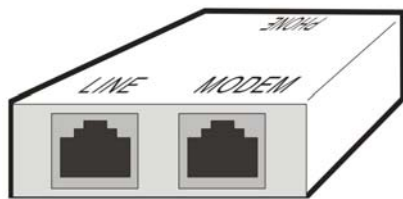

(splitter)

2. Connect the LAN port to your computer with an RJ-45 cable.
3. Connect one end of the power adapter to the Power port of this device. Connect the other end to the wall outlet of electricity.
4. Power on the modem.
5. Check the POWER, ACT, LAN, DSL, and INTERNET LEDs to assure network connections.

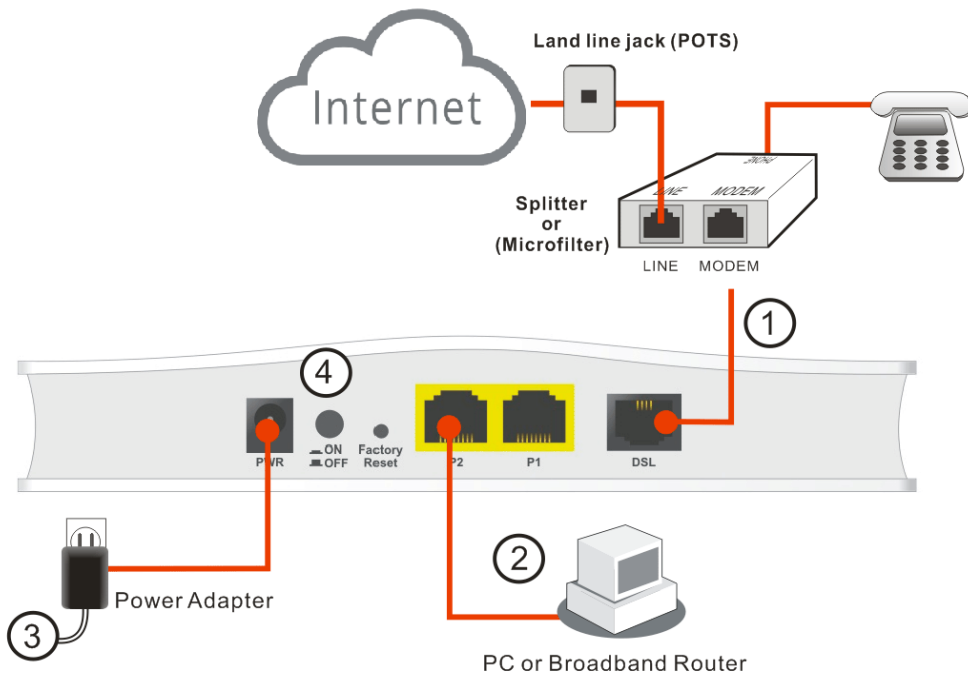

(For the detailed information of LED status, please refer to section 2.)

I-2-2 Wall-Mounted Installation

1. Drill the holes on the wall according to the recommended instruction.
2. Fit screws into the wall using the appropriate type of wall plug.

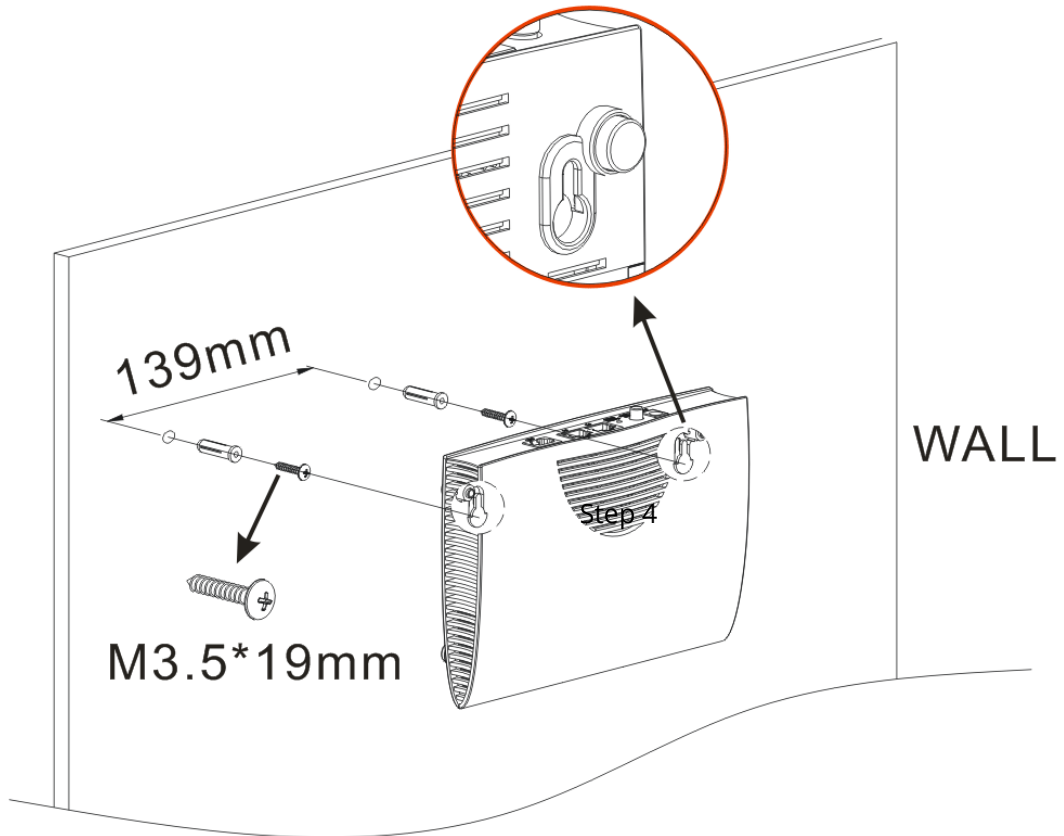

i Note

The recommended drill diameter shall be 6.5mm (1/4").

3. When you finished the above procedure, the modem has been mounted on the wall firmly.

I-3 Accessing to Web User Interface

All functions and settings of this access point must be configured via the web user interface. Please start your web browser (e.g., Firefox).

1. Make sure your PC connects to the Vigor router correctly.
2. Open a web browser on your PC and type **http://192.168.1.1**. A pop-up window will open to ask for a username and password. Please type "admin/admin" on Username/Password and click **Login**.

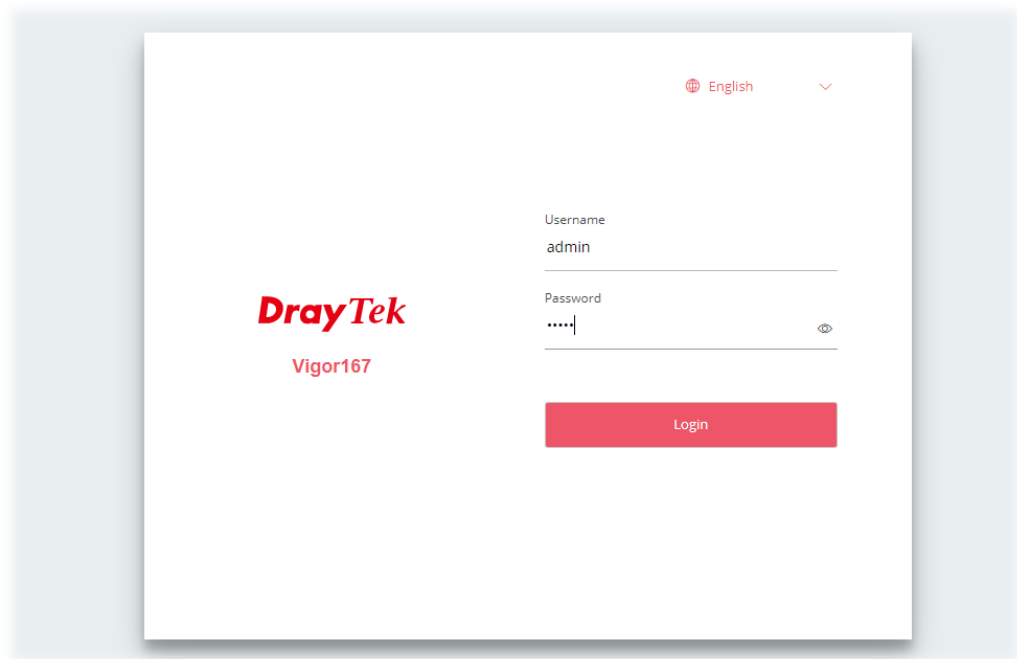

i Note:

If you fail to access the web configuration, please go to "Trouble Shooting" for detecting and solving your problem.

- Now, the **Main Screen** will appear.

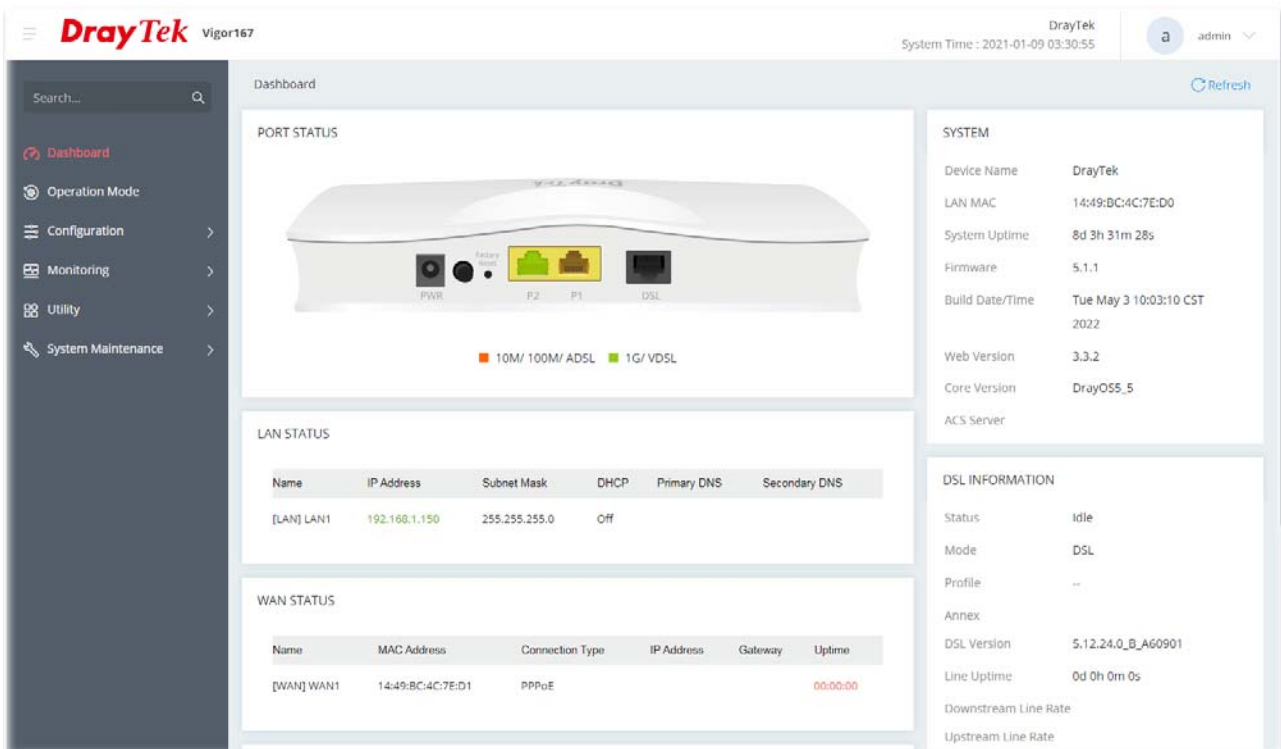

- The web page can be logged out by clicking **Log Out** on the top right of the web page. Or, logout the web user interface according to the chosen condition. The default setting is **Auto Logout**, which means the web configuration system will log out after 5 minutes without any operation. Change the setting of auto-logout if you want.

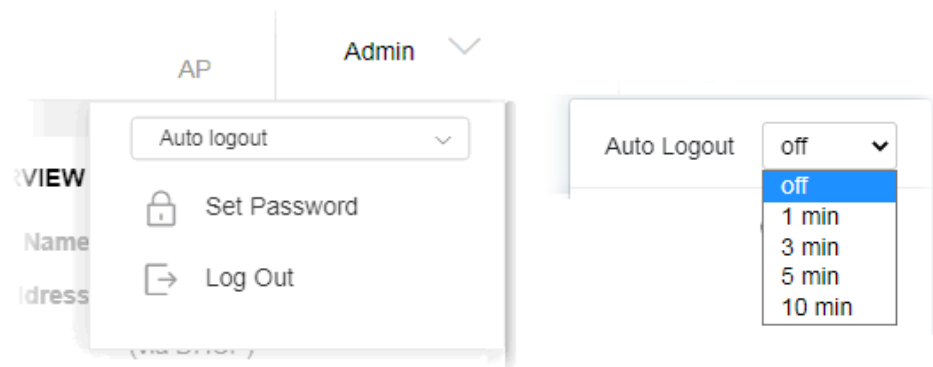

Note:

For using the device properly, it is necessary for you to change the password of web configuration for security and adjust primary basic settings.

I-5 Changing Password

1. Please change the password for the original security of the modem.
2. Go to **System Maintenance** page and choose **Account**. Click **Edit** to open the modification page.

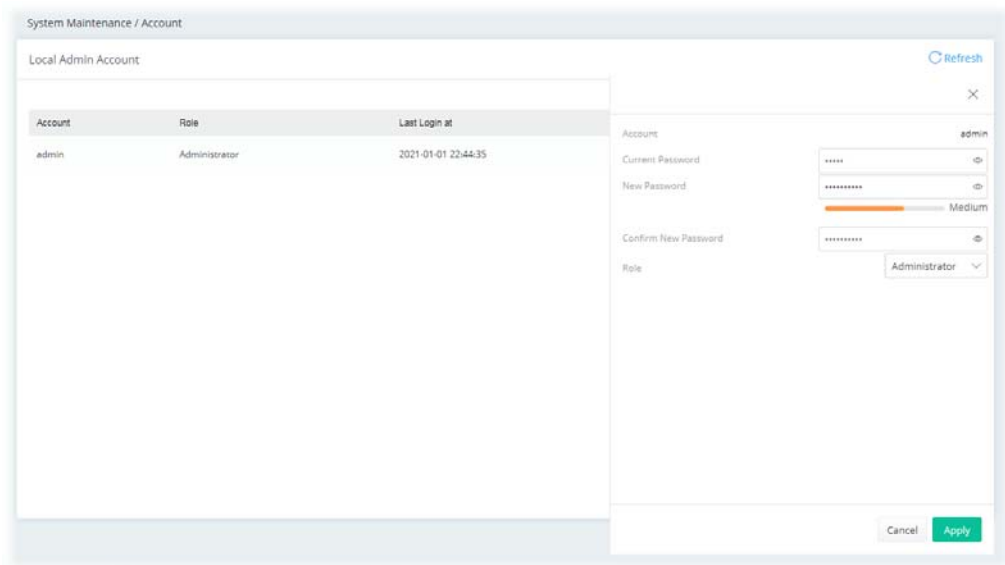

3. Enter the new login password on the fields of **New Password** and **Confirm New Password**. Then click **Apply** to continue.
4. Now, the password has been changed. Next time, use the new password to access the Web User Interface for this modem.

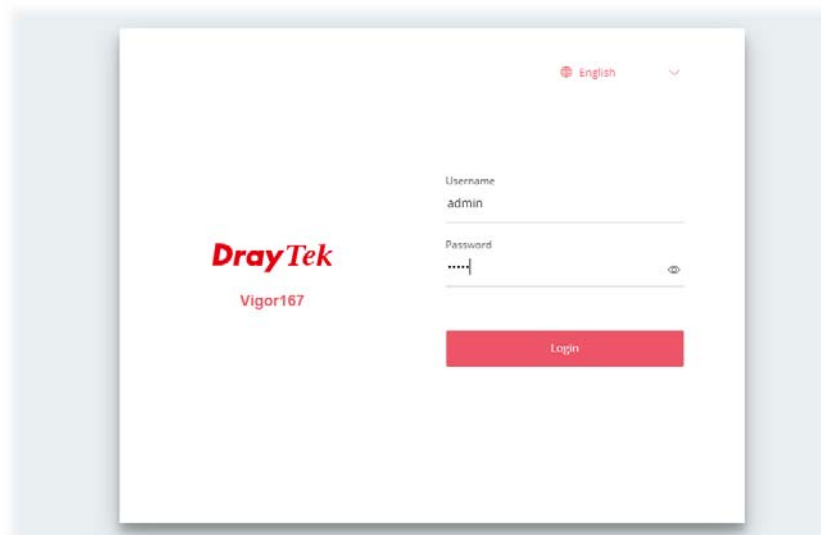

I-6 Dashboard

Dashboard shows port status, LAN status, system status, LAN/WAN Usage and DSL information. Click **Dashboard** from the main menu on the left side of the main page.

Dashboard Refresh

PORT STATUS

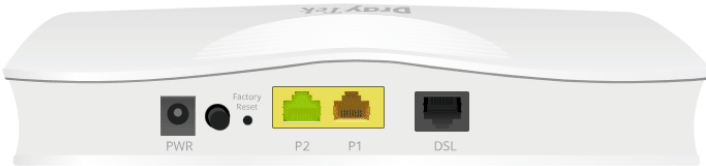

Legend: ■ 10M/ 100M/ ADSL ■ 1G/ VDSL

SYSTEM

Device Name	DrayTek
LAN MAC	14:49:BC:4C:7E:D0
System Uptime	8d 3h 31m 28s
Firmware	5.1.1
Build Date/Time	Tue May 3 10:03:10 CST 2022
Web Version	3.3.2
Core Version	DrayOS5_5
ACS Server	

LAN STATUS

Name	IP Address	Subnet Mask	DHCP	Primary DNS	Secondary DNS
[LAN] LAN1	192.168.1.150	255.255.255.0	Off		

WAN STATUS

Name	MAC Address	Connection Type	IP Address	Gateway	Uptime
[WAN] WAN1	14:49:BC:4C:7E:D1	PPPoE			00:00:00

DSL INFORMATION

Status	Idle
Mode	DSL
Profile	--
Annex	
DSL Version	5.12.24.0_B_A60901
Line Uptime	0d 0h 0m 0s
Downstream Line Rate	
Upstream Line Rate	

Chapter II Connectivity

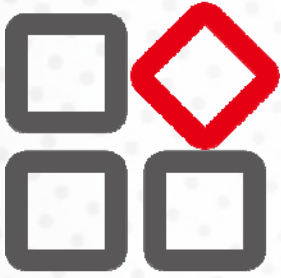

II-1 Operation Mode: Modem Mode

This page provides available modes for you to choose for different conditions. Choose the one (e.g., Modem Mode) you want. The system will configure the required settings automatically.

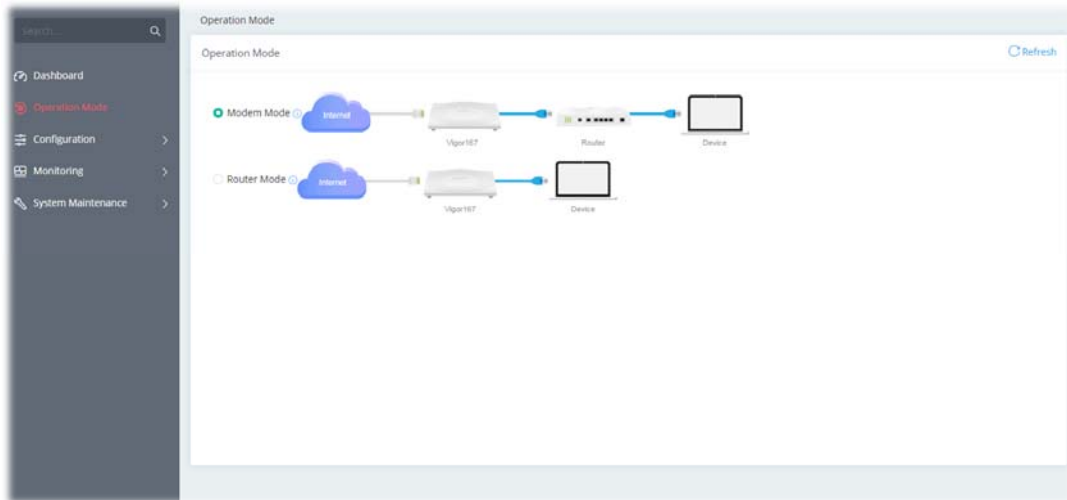

Available settings are explained as follows:

Item	Description
Modem Mode	This mode allows wireless clients to connect to the access point and exchange data with the devices connected to the wired network.
Router Mode	The built-in DHCP server can assign different IPs to the devices connecting to this router.

Click the **Modem Mode** to configure advanced settings.

Step 1: Set the System Time.

Operation Mode

1 System Time 2 Internet Connection 3 LAN 4 Apply & Reboot Refresh

Operation Mode Changing from Router to Modem

Set Time Automatically with Time Server Manually

Time Zone (UTC) Greenwi... ▾

Date 2021-01-01 📅

Time 00 ▾ : 00 ▾

Synchronize with Browser

Or,

Operation Mode

1 System Time 2 Internet Connection 3 LAN 4 Apply & Reboot Refresh

Operation Mode Changing from Modem to Router

Set Time Automatically with Time Server Manually

Time Zone (UTC) Greenwi... ▾

Time Server pool.ntp.org

Interface Auto ▾

Daylight Saving

Step 2: Configure the settings for Internet connection.

Available settings are explained as follows:

Item	Description
General	
Physical Interface	Displays the physical interface used for the network connection.
DSL Mode	Select the DSL connection mode. Auto - The router will first attempt to connect using VDSL2, and will fall back to ADSL# if VDSL2 is unavailable.
ADSL Setting	
Annex	Specifies the modulation standard used for the ADSL connection.
VPI / VCI	Set values for Virtual Path Identifier(VPI) and Virtual Channel Identifier(VCI).
Customer VLAN	Enabled - Switch the toggle to enable or disable the function. If enabled, enter the values for the tag and priority. Tag - Enter the value as the VLAN ID number. The range is from 0 to 4094. Priority - Enter the packet priority number for such VLAN. The range is from 0 to 7.
VDSL2 Setting	
Customer VLAN	Enabled - Switch the toggle to enable or disable the function. If enabled, enter the values for the tag and priority. Tag - Enter the value as the VLAN ID number. The range is from 0 to 4094.

	Priority - Enter the packet priority number for such VLAN. The range is from 0 to 7.
Service VLAN	<p>Enabled - Switch the toggle to enable or disable the function. If enabled, enter the values for the tag and priority.</p> <p>Tag - Enter the value as the VLAN ID number. The range is from 0 to 4094.</p> <p>Priority - Enter the packet priority number for such VLAN. The range is from 0 to 7.</p>
Back	Return to previous setting page.
Cancel	Discard current settings and return to the previous page.
Next	Get into the next setting page.

Step 3: Configure the LAN settings.

The screenshot displays the 'Operation Mode' configuration interface. At the top, a progress bar shows four steps: 1. System Time, 2. Internet Connection, 3. LAN (highlighted in red), and 4. Apply & Reboot. Below the progress bar, a message states 'Operation Mode Changing from Modem to Router'. The main configuration area is divided into two sections: 'Network Configuration' and 'DHCP Server Configuration'. In the 'Network Configuration' section, 'Usage' is set to 'NAT', 'IP Address' is '192.168.1.1', and 'Subnet Mask' is '255.255.255.0/...'. In the 'DHCP Server Configuration' section, the 'DHCP Server' is set to 'On', 'Start IP Address' is '192.168.1.10', 'IP Pool Counts (1-253)' is '100', 'Gateway IP Address' is '192.168.1.1', and 'Lease Time (Sec. 120-2592000)' is '86400'. At the bottom, there are three buttons: 'Back', 'Cancel', and 'Next'.

Step 4: After finishing the configuration, click **Apply & Reboot**.

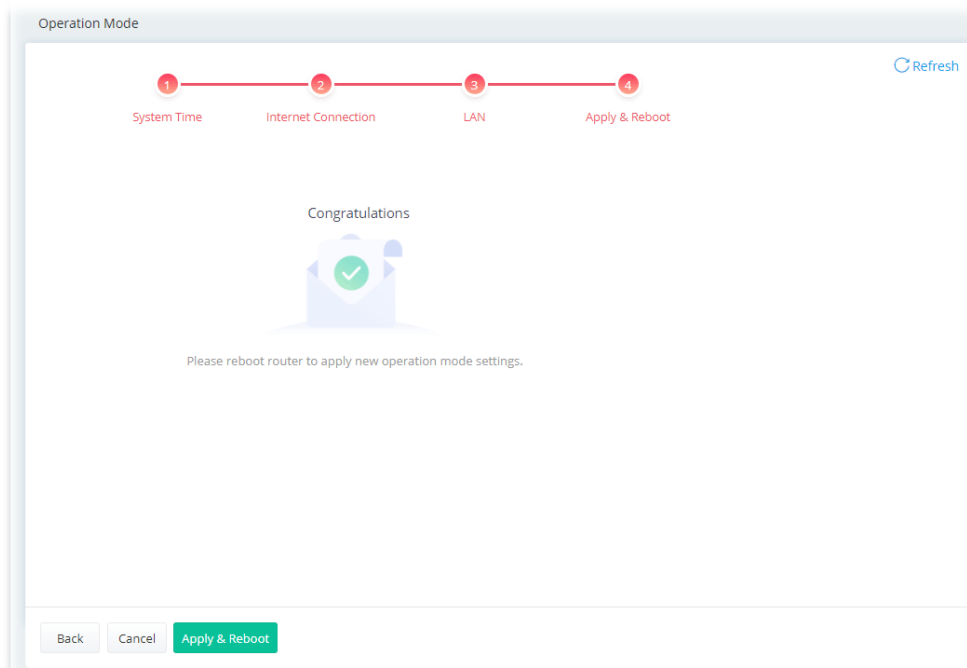

II-1-1 Physical Interface

Configure the general settings for LAN/WAN interface. Open **Configuration >> Physical Interface**.

Configuration / Physical Interface

Setup the interface

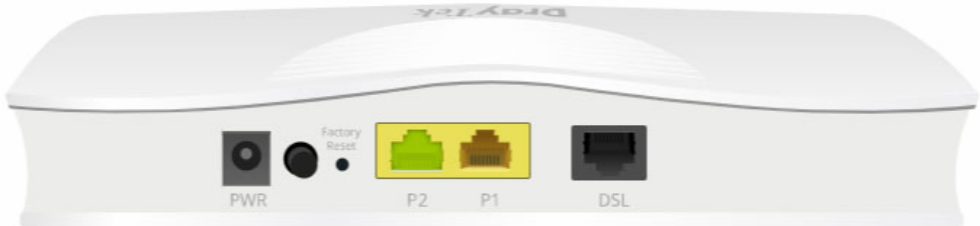

■ 10M/ 100M/ADSL
 ■ 1G/ VDSL

DSL

Interface	Function	Status	Modem Code
DSL	WAN1	<input checked="" type="checkbox"/>	Default: 5.12.24.0 ▾

Ethernet

Interface	Function	Status	Speed
P1	LAN	<input checked="" type="checkbox"/>	Auto negotiation ▾
P2	LAN	<input checked="" type="checkbox"/>	Auto negotiation ▾

Available settings are explained as follows:

Item	Description
DSL	
Interface	Displays the interface (DSL, ADSL or xDSL and etc.) used for WAN connection.
Function	Displays the WAN# of the WAN connection.
Status	Switch the toggle to enable or disable the function.
Modem Code	Use the default one. Consult your ISP to select the one matching the country in which the router is installed.

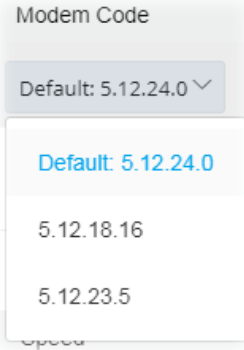
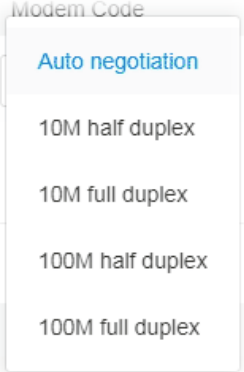
	
Ethernet	
Interface	Displays the interface (P1, P2) used for LAN connection.
Function	Displays the LAN# of the LAN connection.
Status	Switch the toggle to enable or disable the function.
Speed	<p>Set the LAN port speed capabilities:</p>  <p>Port speed capabilities:</p> <p>Auto negotiation: Auto speed with all capabilities.</p> <p>10M half duplex: Force speed with 10M ability.</p> <p>10M full duplex: Force speed with 10M ability.</p> <p>100M half duplex: Force speed with 100M ability.</p> <p>100M full duplex: Force speed with 100M ability.</p> <p>Selecting Auto (auto-negotiation) allows one port to negotiate with a peer port automatically to obtain the connection speed and duplex mode that both ends support. When auto-negotiation is turned on, a port on the switch negotiates with the peer automatically to determine the connection speed and duplex mode. If the peer port does not support auto-negotiation or turns off this feature, the switch determines the connection speed by detecting the signal on the cable and using half duplex mode. When the switch's auto-negotiation is turned off, a port uses the pre-configured speed and duplex mode when making a connection, thus requiring you to make sure that the settings of the peer port are the same in order to connect.</p>

i Note:

Switch these two icons by click the mouse cursor on them.

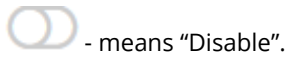
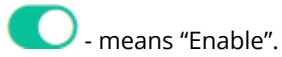

II-1-2 WAN

When the operation mode is configured as Modem Mode, the **Configuration>>WAN** page will be shown as the following page.

This page is to configure the general settings for WAN connection.

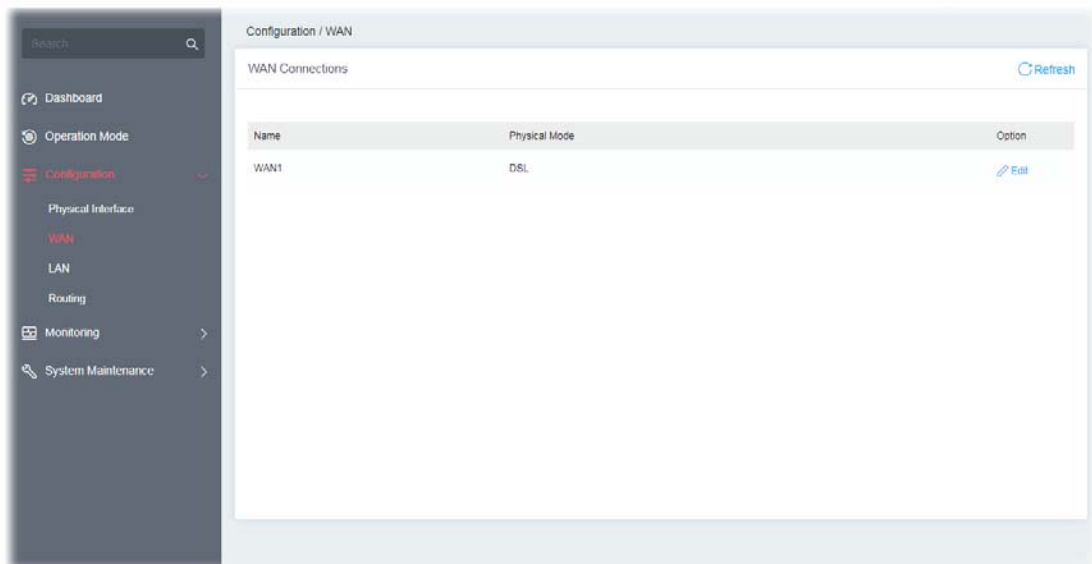

Available settings are explained as follows:

Item	Description
Name	Displays the name of the interface.
Physical Mode	Displays the physical mode (e.g., ADSL, VDSL, and etc.) used by the WAN interface.
Option	Edit - Click to modify the interface name and physical mode.

To configure the detailed settings for the selected WAN interface, click the **Edit** link to the right side of the WAN interface.

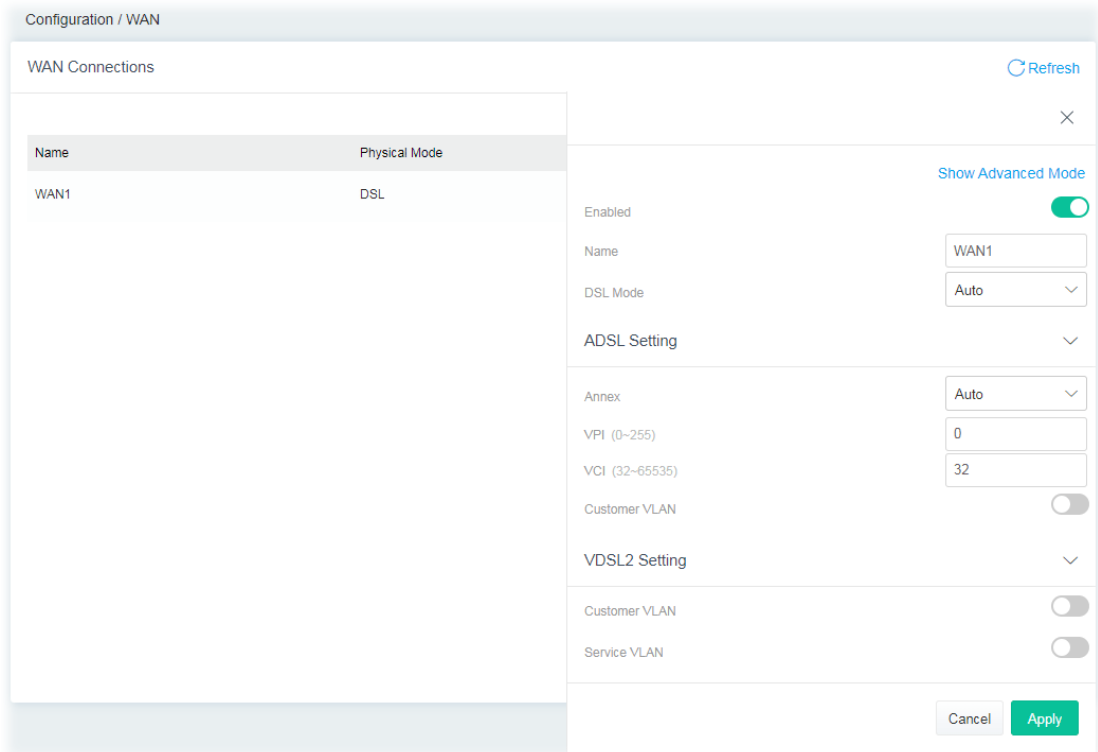

Available settings are explained as follows:

Item	Description
Show / Hide Advanced Mode	<p>Click to show or hide the advanced settings for the WAN interface. The advanced settings include Encapsulation and QoS.</p> <p>Encapsulation -</p>  <p>QoS - Be explained later.</p>
Name	Displays current WAN interface.
Enabled	Switch the toggle to enable or disable the function.
DSL Mode	<p>Specify which DSL mode (e.g., VDSL2, ADSL2, ADSL2 multimode, ADSL2+, T1.413, G.DMT) can be used for such WAN connection.</p> <p>Auto - The system will choose the suitable one automatically.</p>
ADSL Setting	
Annex	Choose the correct modem version of the device, e.g., Annex A, Annex B, Annex A/B/M, Annex A/B/J and etc.
VPI	Enter the value provided by ISP.
VCI	Enter the value provided by ISP.
Customer VLAN	Enabled - Switch the toggle to enable or disable the function of VLAN

	<p>with tag. If enabled, enter the values for the tag and priority.</p> <p>Tag - Enter the value as the VLAN ID number. The range is from 0 to 4094.</p> <p>Priority - Enter the packet priority number for such VLAN. The range is from 0 to 7.</p>
VDSL2 Setting	
Customer VLAN	<p>Switch the toggle to enable or disable the function of VLAN with tag. If enabled, enter the values for the tag and priority.</p> <p>Tag - Enter the value as the VLAN ID number. The range is from 0 to 4094.</p> <p>Priority - Enter the packet priority number for such VLAN. The range is from 0 to 7.</p>
Service VLAN	<p>Switch the toggle to enable or disable the function of VLAN with tag. If enabled, enter the values for the tag and priority.</p> <p>Tag - Enter the value as the VLAN ID number. The range is from 0 to 4094.</p> <p>Priority - Enter the packet priority number for such VLAN. The range is from 0 to 7.</p>
QoS	
ATM QoS	<p>Configure the Quality of Service (QoS) of the ATM circuit. Select a proper QoS type for the interface.</p> <div style="border: 1px solid #ccc; padding: 5px; width: fit-content; margin: 10px auto;"> <p>UBR Without PCR</p> <p>UBR With PCR</p> <p>CBR</p> <p>nrtVBR</p> <p>rtVBR</p> </div> <p>UBR Without PCR- Unspecified Bit Rate.</p> <p>UBR With PCR- Unspecified Bit Rate. Enter the value for PCR (Peak Cell Rate, 0_5500) if select UBR With PCR.</p> <p>CBR - Constant Bit Rate.</p> <p>nrtVBR - Non-real-time Variable Bit Rate.</p> <p>rtVBR - Real-time Variable Bit Rate.</p>
Cancel	Discard current settings and return to previous page.
Apply	Save the current settings and exit the page.

After finishing this web page configuration, please click **Apply** to save the settings.

i Note:

Switch these two icons by click the mouse cursor on them.

 - means "Enable".

 - means "Disable".

II-1-3 LAN

Local Area Network (LAN) is a group of subnets regulated and ruled by modem.

Open **Configuration>>LAN** to open the following page.

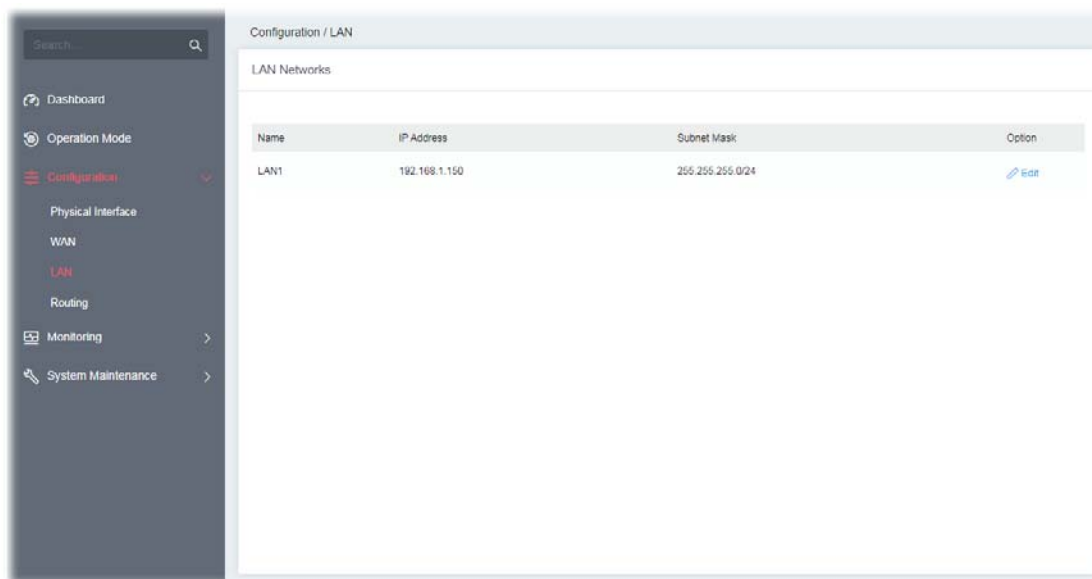

Available settings are explained as follows:

Item	Description
Name	Displays the number of LAN interface.
IP Address	Displays the IP address of the LAN interface.
Subnet Mask	Displays the subnet mask of the LAN interface.
Option	Edit - Click to modify the name, IP address, and subnet mask settings.

To configure the detailed settings for the selected WAN interface, click the **Edit** link to the right side of the LAN interface.

Configuration / LAN

LAN Networks

Name	IP Address
LAN1	192.168.1.150

Name: LAN1

IP Address: 192.168.1.150

Subnet Mask: 255.255.255.0/...

- 255.255.252.0/22
- 255.255.254.0/23
- 255.255.255.0/24
- 255.255.255.128/25
- 255.255.255.192/26

Cancel Apply

Available settings are explained as follows:

Item	Description
Name	Enter a brief comment for the LAN interface.
IP Address	Enter the IP address of the LAN interface.
Subnet Mask	Select a subnet mask of the LAN interface.
Cancel	Discard current settings and return to the previous page.
Apply	Save the current settings and exit the page.

After finishing this web page configuration, please click **Apply** to save the settings.

i Note:

Switch these two icons by click the mouse cursor on them.



- means "Enable".



- means "Disable".

II-1-4 Routing

Static routing is an alternative to dynamic routing. It is a process that the system network administrator can configure network routers with all the required information for packet forwarding.

Open **Configuration >> Routing**.

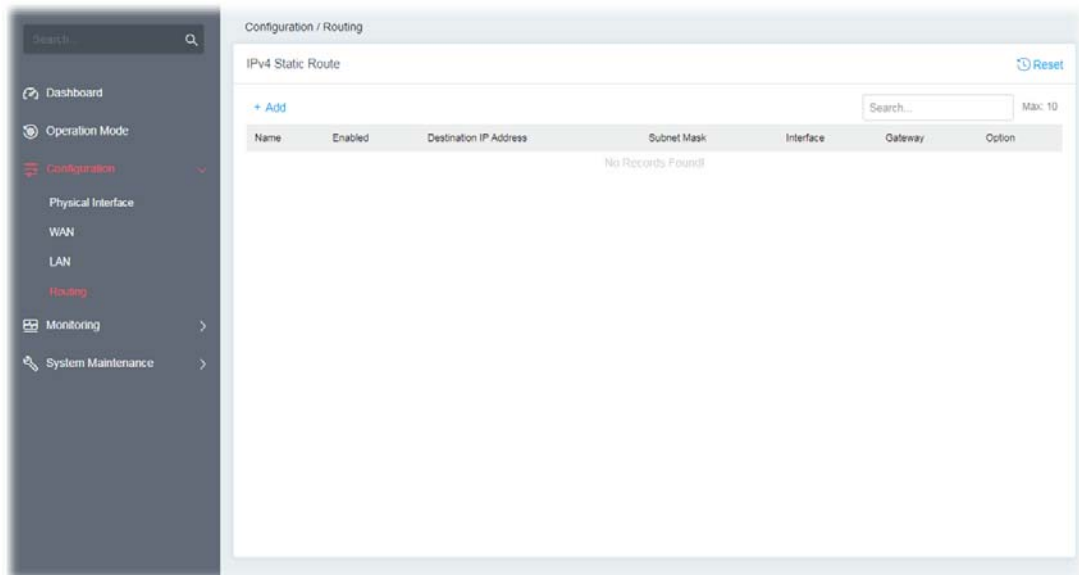

To add a new IPv4 static route, click the **+Add** link to get the following page.

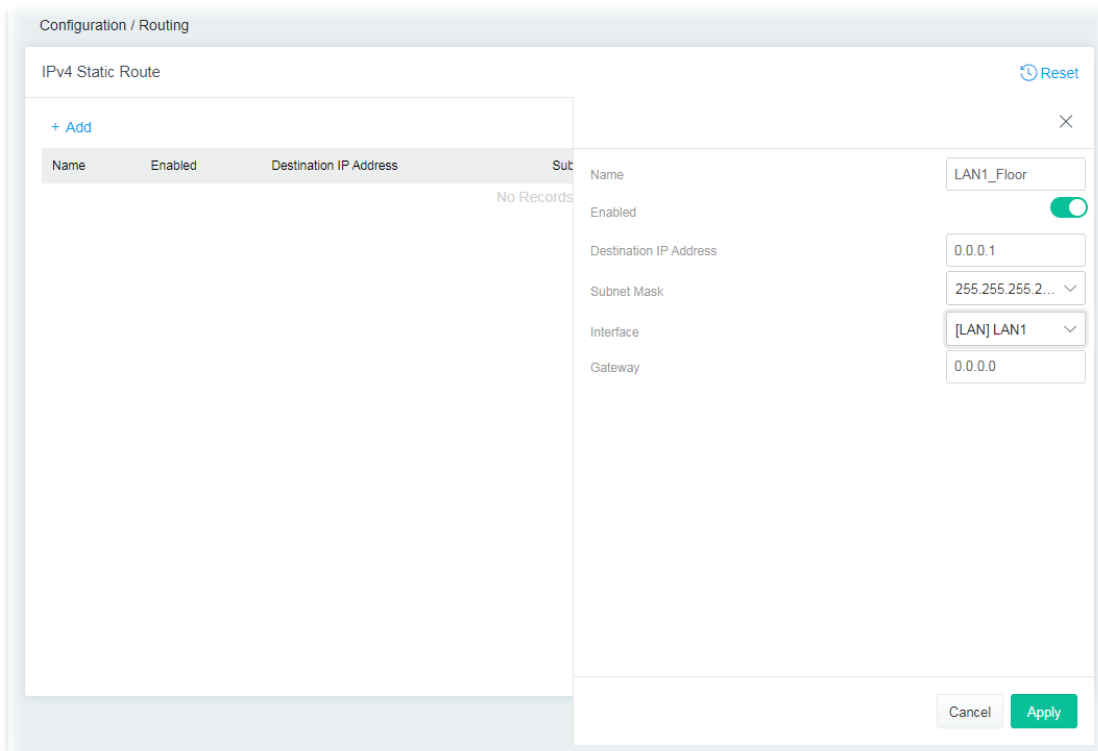

Available settings are explained as follows:

Item	Description
Name	Enter a name as the profile name.

Enabled	Switch the toggle to enable or disable the function.
Destination IP Address	Enter the IP address as the destination IP address.
Subnet Mask	Select a subnet mask of this static route.
Interface	Use the drop-down list to specify an interface for this static route.
Gateway	Enter an IP address as the gateway.
Cancel	Discard current settings and return to the previous page.
Apply	Save the current settings and exit the page.

After finishing this web page configuration, please click **Apply** to save the settings.

i Note:

Switch these two icons by click the mouse cursor on them.



- means "Enable".



- means "Disable".

II-2 Operation Mode: Router Mode

Click the **Router Mode** and click **Next** to configure advanced settings.

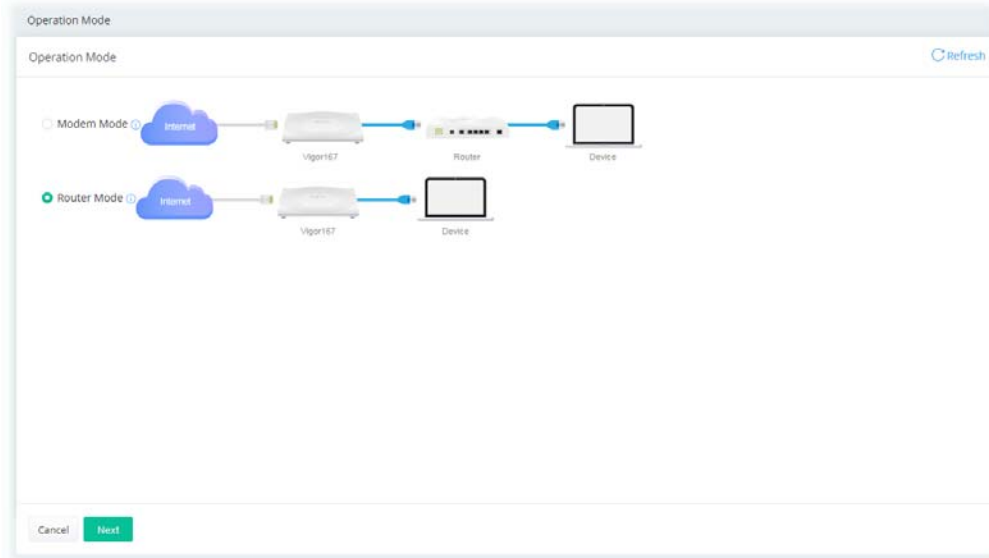

Step 1: Set the System Time.

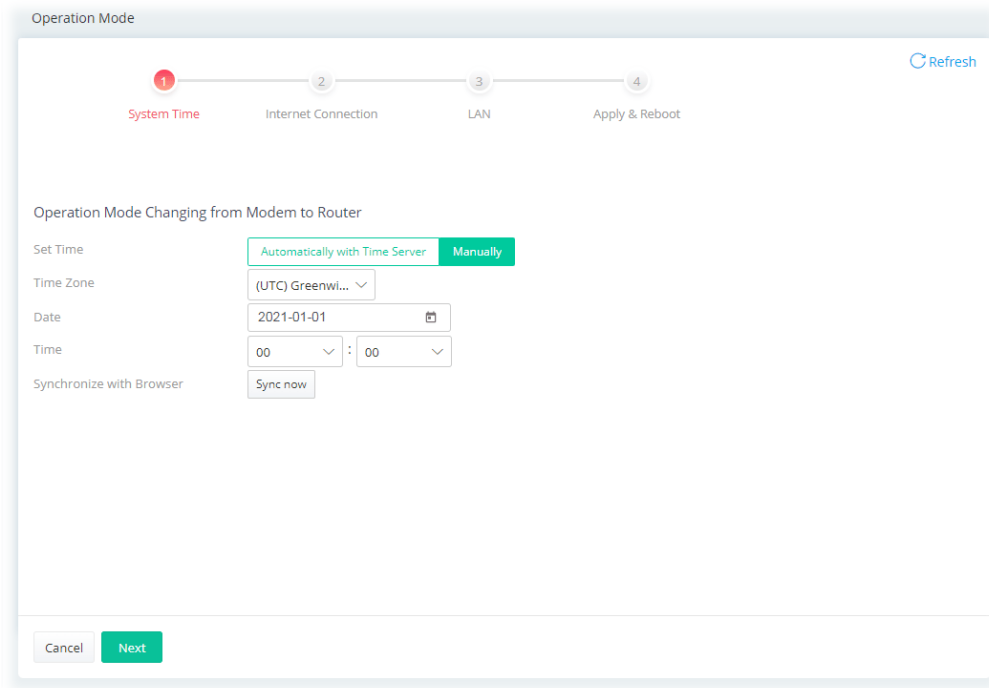

Or,

Step 2: Configure the settings for Internet connection.

Available settings are explained as follows:

Item	Description
General	
Physical Interface	Displays the physical interface used for the network connection.
DSL Mode	Select the DSL connection mode. Auto - The router will first attempt to connect using VDSL2, and will fall back to ADSL# if VDSL2 is unavailable.
ADSL Setting	

Annex	Specifies the modulation standard used for the ADSL connection.
VPI / VCI	Set values for Virtual Path Identifier(VPI) and Virtual Channel Identifier(VCI).
Customer VLAN	<p>Enabled - Switch the toggle to enable or disable the function. If enabled, enter the values for the tag and priority.</p> <p>Tag - Enter the value as the VLAN ID number. The range is from 0 to 4094.</p> <p>Priority - Enter the packet priority number for such VLAN. The range is from 0 to 7.</p>
VDLS2 Setting	
Customer VLAN	<p>Enabled - Switch the toggle to enable or disable the function. If enabled, enter the values for the tag and priority.</p> <p>Tag - Enter the value as the VLAN ID number. The range is from 0 to 4094.</p> <p>Priority - Enter the packet priority number for such VLAN. The range is from 0 to 7.</p>
Service VLAN	<p>Enabled - Switch the toggle to enable or disable the function. If enabled, enter the values for the tag and priority.</p> <p>Tag - Enter the value as the VLAN ID number. The range is from 0 to 4094.</p> <p>Priority - Enter the packet priority number for such VLAN. The range is from 0 to 7.</p>
IPv4	
IPv4 Connection Type	Specify the Internet Access Type (PPPoE, PPPoA, Static IP, DHCP).
Username	Enter the username provided by the ISP if PPPoE / PPPoA is selected as IPv4 Connection Type.
Password	Enter the password provided by the ISP if PPPoE / PPPoA is selected as IPv4 Connection Type.
IP Address	Enter the WAN IP address of the router if Static IP is selected as IPv4 Connection Type.
Subnet Mask	Enter the subnet mask of the router if Static IP is selected as IPv4 Connection Type.
Gateway IP	Enter the IP address of the remote gateway if Static IP is selected as IPv4 Connection Type.
DNS	
IPv4 Primary Server	Enter the IP address of the primary DNS server.
IPv4 Secondary Server	Enter the IP address of the secondary DNS server.
Back	Return to previous setting page.
Cancel	Discard current settings and return to the previous page.
Next	Get into the next setting page.

Step 3: Configure the LAN settings.

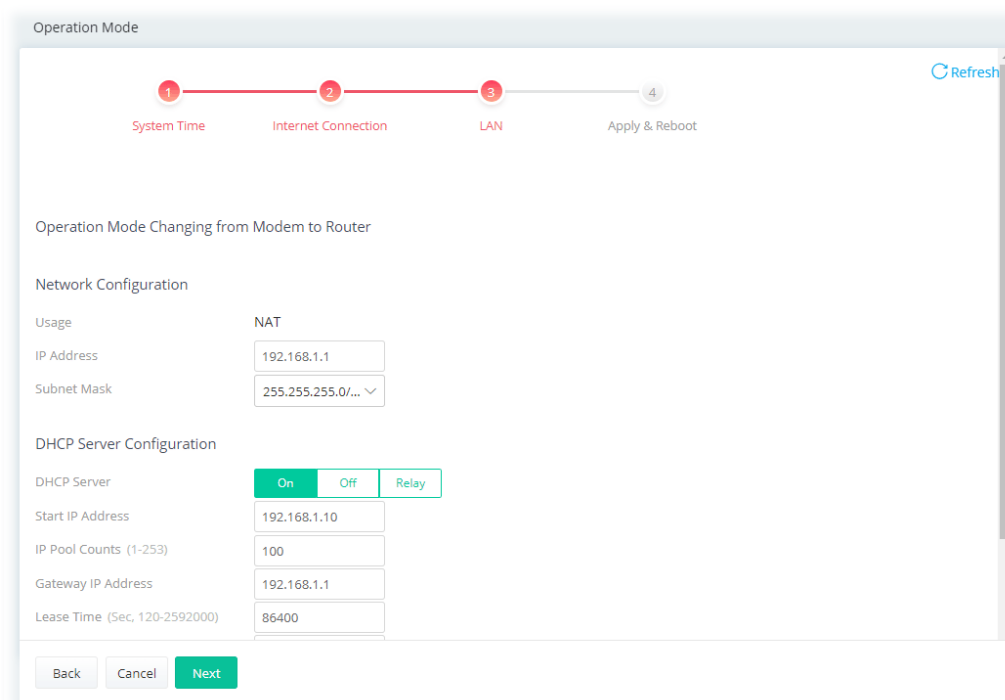

Available settings are explained as follows:

Item	Description
Network Configuration	
Usage	The current is for NAT.
IP Address	This is the IP address of the router. (Default: 192.168.1.1).
Subnet Mask	The subnet mask, together with the IP Address field, indicates the maximum number of clients allowed on the subnet. (Default: 255.255.255.0/ 24).
DHCP Server Configuration	
DHCP Server	<p>DHCP stands for Dynamic Host Configuration Protocol. The router by factory default acts a DHCP server for your network so it automatically dispatches related IP settings to any local user configured as a DHCP client. It is highly recommended that you leave the router enabled as a DHCP server if you do not have a DHCP server for your network.</p> <p>If you want to use another DHCP server in the network other than the Vigor Router's, you can let Relay Agent help you to redirect the DHCP request to the specified location.</p> <p>On - Enables the built-in DHCP server on the router.</p> <p>Off - Disables the built-in DHCP server on the router.</p> <p>Relay - When selected, all DHCP requests are forwarded to a DHCP server outside of the LAN subnet, and whose address is specified in the DHCP Server IP Address field.</p>
Start IP Address	It is available when the DHCP server is on . The beginning LAN IP address that is given out to LAN DHCP clients.
IP Pool Counts	It is available when the DHCP server is on . The maximum number of IP addresses to be handed out by DHCP.

	The default value is 100. Valid range is between 1 and 253. The actual number of IP addresses available for assignment is the IP Pool Counts, or 253 minus the last octet of the Start IP Address, whichever is smaller.
Gateway IP Address	The IP address of the gateway, which is the host on the LAN that relays all traffic coming into and going out of the LAN. It is available when the DHCP server is on .
Lease Time	The maximum duration DHCP-issued IP addresses can be used before they have to be renewed. It is available when the DHCP server is on .
Primary DNS	Specify a DNS server IP address. It is available when the DHCP server is on .
Secondary DNS	Specify secondary DNS server IP address here because your ISP often provides you more than one DNS Server. It is available when the DHCP server is on .
Interface for 1st DHCP Server	It is available when the DHCP server is set as Relay . Specify a WAN interface for the first DHCP Server.
1st DHCP Server IP Address	It is available when the DHCP server is set as Relay . Enter the IP Address of the DHCP server to which DHCP requests from LAN clients are forwarded.
Interface for 2nd DHCP Server	It is available when the DHCP server is set as Relay . The secondary DHCP server is an optional setting. If required, specify a WAN interface for the second DHCP Server as a backup server.
2nd DHCP Server IP Address	It is available when the DHCP server is set as Relay . Enter the IP Address of the DHCP server to which DHCP requests from LAN clients are forwarded.
Back	Return to previous setting page.
Cancel	Discard current settings and return to the previous page.
Next	Get into the next setting page.

Step 4: After finishing the configuration, click **Apply & Reboot**.

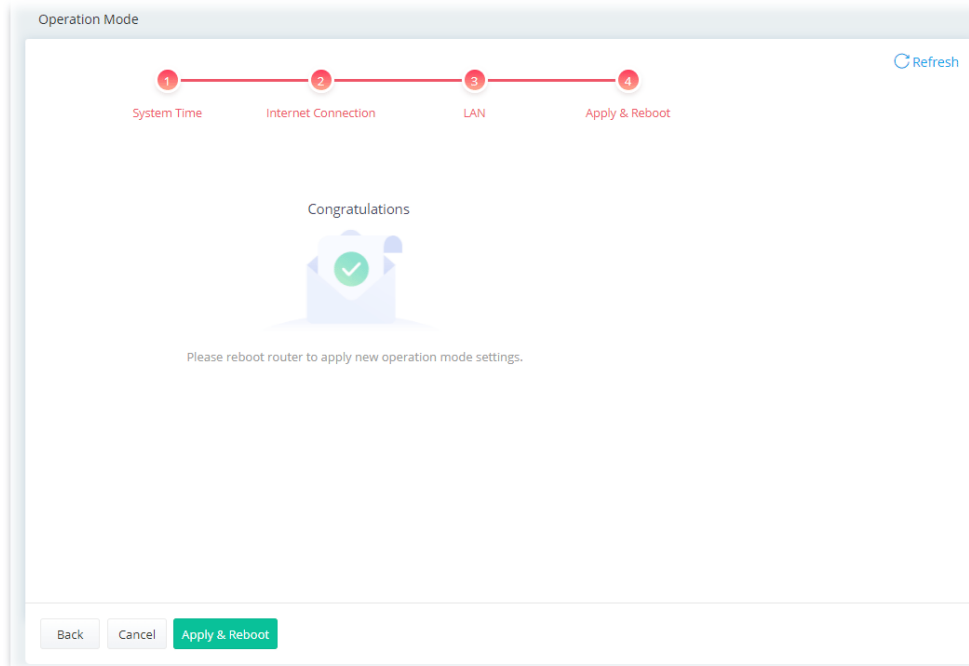

II-2-1 Physical Interface

Configure the general settings for LAN/WAN interface. Open **Configuration >> Physical Interface**.

Setup the interface

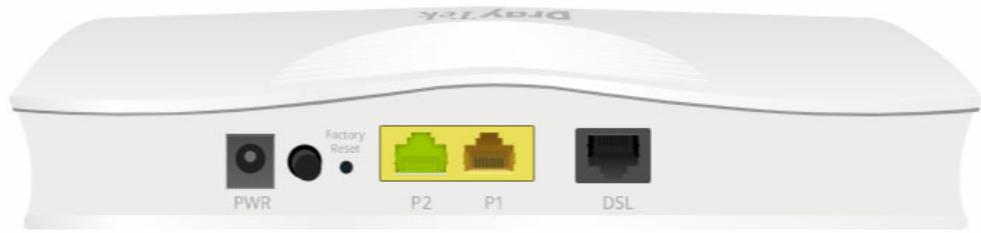

■ 10M/ 100M/ ADSL
 ■ 1G/ VDSL

DSL

Interface	Function	Status	Modem Code
DSL	WAN1	<input checked="" type="checkbox"/>	Default: 5.12.24.0 ▾

Ethernet

Interface	Function	Status	Speed
P1	LAN	<input checked="" type="checkbox"/>	Auto negotiation ▾
P2	LAN	<input checked="" type="checkbox"/>	Auto negotiation ▾

Available settings are explained as follows:

Item	Description
DSL	
Interface	Displays the interface (DSL, ADSL or xDSL and etc.) used for WAN connection.
Function	Displays the WAN# of the WAN connection.
Status	Switch the toggle to enable or disable the function.
Modem Code	Use the default one. Consult your ISP to select the one matching the country in which the router is installed.

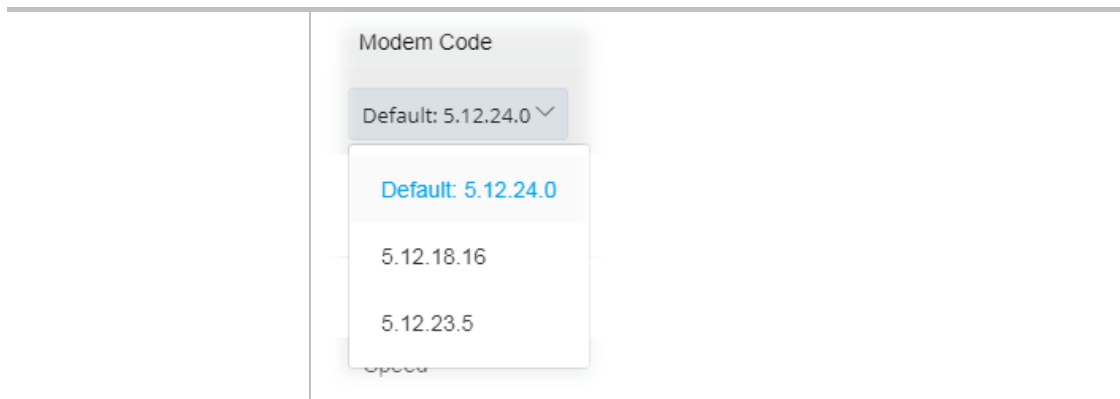

Ethernet

Interface	Displays the interface (P1, P2) used for LAN connection.
Function	Displays the LAN# of the LAN connection.
Status	Switch the toggle to enable or disable the function.
Speed	<p>Set the LAN port speed capabilities:</p>  <p>Port speed capabilities:</p> <p>Auto negotiation: Auto speed with all capabilities.</p> <p>10M half duplex: Force speed with 10M ability.</p> <p>10M full duplex: Force speed with 10M ability.</p> <p>100M half duplex: Force speed with 100M ability.</p> <p>100M full duplex: Force speed with 100M ability.</p> <p>Selecting Auto (auto-negotiation) allows one port to negotiate with a peer port automatically to obtain the connection speed and duplex mode that both ends support. When auto-negotiation is turned on, a port on the switch negotiates with the peer automatically to determine the connection speed and duplex mode. If the peer port does not support auto-negotiation or turns off this feature, the switch determines the connection speed by detecting the signal on the cable and using half duplex mode. When the switch's auto-negotiation is turned off, a port uses the pre-configured speed and duplex mode when making a connection, thus requiring you to make sure that the settings of the peer port are the same in order to connect.</p>

i Note:

Switch these two icons by click the mouse cursor on them.



- means "Enable".



- means "Disable".

II-2-2 WAN

When the operation mode is configured as Router Mode, the **Configuration>>WAN** page will be shown as the following page.

II-2-2-1 WAN Connections

This page is to configure the general settings for WAN connection.

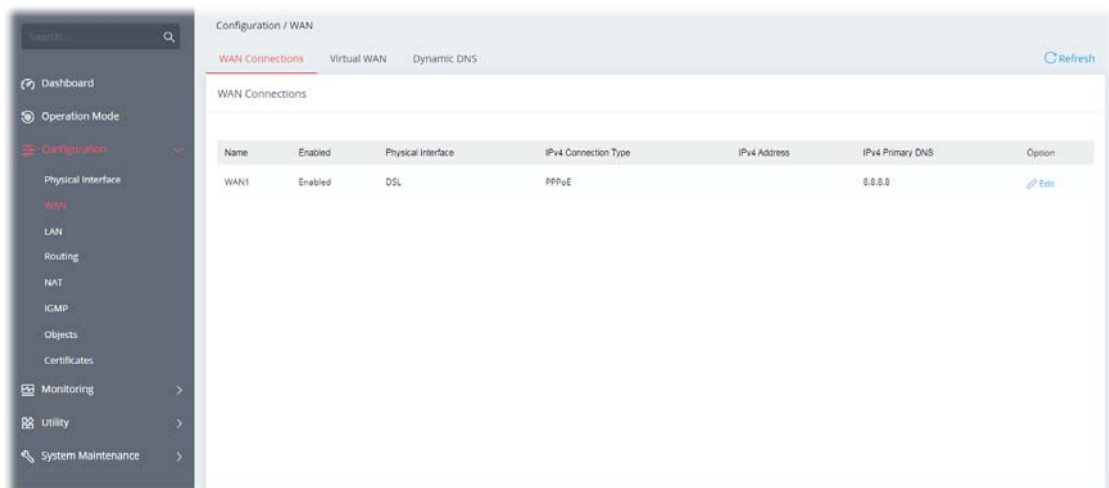

Available settings are explained as follows:

Item	Description
Name	Displays the name of the interface.
Physical Interface	Displays the physical mode (e.g., ADSL, VDSL, and etc.) used by the WAN interface.
IPv4 Connection Type	Displays the connection type (e.g., PPPoE, DHCP, and etc.).
IPv4 Address	Displays the IP address used by the WAN interface.
IPv4 Primary DNS	Displays the primary DNS server address.
Option	Edit - Click to modify the interface name and physical mode.

To configure the detailed settings for the selected WAN interface, click the **Edit** link to the right side of the WAN interface.

The screenshot shows the WAN configuration page for 'WAN1'. The 'Enabled' toggle is turned on. Under 'General Setup', 'DSL Mode' is set to 'Auto'. Under 'ADSL Setting', 'Annex' is set to 'Annex B', 'VPI' is 0, and 'VCI' is 32. 'Customer VLAN' is disabled. 'Encapsulation' is set to 'RFC 1483 Brid...'. Under 'Multiplexing', 'LLC' is selected over 'VC-Mux'. There are 'Cancel' and 'Apply' buttons at the bottom.

Available settings are explained as follows:

Item	Description
Show / Hide Advanced Mode	Click to show or hide the advanced settings for the WAN interface.
Name	Displays current WAN interface.
Enabled	Switch the toggle to enable or disable the function.
General Setup	
DSL Mode	Specify which DSL mode (e.g., VDSL2, ADSL2, ADSL2 multimode, ADSL2+, T1.413, G.DMT) can be used for such WAN connection. Auto - The system will choose the suitable one automatically.
ADSL Setting	
Annex	Choose the correct modem version of the device, e.g., Annex A, Annex B, Annex A/B/M, Annex A/B/J and etc.
VPI	Enter the value provided by ISP.
VCI	Enter the value provided by ISP.
Customer VLAN	Click to enable the function of VLAN with tag. If enabled, Tag - Enter the value as the VLAN ID number. The range is from 0 to 4094. Priority - Enter the packet priority number for such VLAN. The range is from 0 to 7.
VDSL2 Setting	
Customer VLAN	Click to enable the function of VLAN with tag. If enabled, Tag - Enter the value as the VLAN ID number. The range is from 0 to

	4094. Priority - Enter the packet priority number for such VLAN. The range is from 0 to 7.
Service VLAN	Click to enable the function of VLAN with tag. If enabled, for what? Tag - Enter the value as the VLAN ID number. The range is from 0 to 4094. Priority - Enter the packet priority number for such VLAN. The range is from 0 to 7.
IPv4	
IPv4 Connection Type	There are four types: <ul style="list-style-type: none"> ● PPPoE ● PPPoA ● DHCP ● Static IP
Username/Password	It is available when PPPoE/PPPoA is selected as IPv4 Connection Type. Enter the username and password as the primary user account for network connection.
IP Address	It means the WAN IP address assigned by the ISP. It is available when Static IP is selected as IPv4 Connection Type.
Subnet Mask	It means the WAN subnet mask. It is available when Static IP is selected as IPv4 Connection Type.
Gateway IP	It means the IP address of the WAN Gateway. It is available when Static IP is selected as IPv4 Connection Type.
DNS	
IPv4 Primary / Secondary DNS	Enter the primary IP address for the router if you want to use Static IP mode. If necessary, Enter secondary IP address for necessity in the future. Primary IP Address - IP address of primary DNS server. Secondary IP Address - IP address of secondary DNS server.
WAN Connection Detection	
Mode	Configures how the WAN connection is monitored. Choose Always On , ARP Detect or Ping Detect for the system to execute for WAN detection. ARP Detect - The router broadcasts an ARP request every 5 seconds. If no response is received within 30 seconds, the WAN connection is deemed to have failed. Ping Detect - The router sends an ICMP (Internet Control Message Protocol) echo request every second to the host, whose address is specified in the Ping IP field, to verify the WAN connection. If the remote host does not respond within 30 seconds, the WAN connection is deemed to have failed. If you choose Ping Detect as the detection mode, you have to enter required settings for the following items.
TTL	It is available when Ping Detect is selected as WAN Connection Detection Mode. Time To Live, the maximum allowed number of hops to the ping

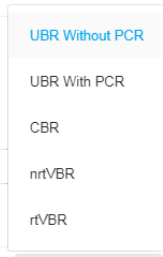
	destination. Valid values range from 1 to 255.
Ping Interval	It is available when Ping Detect is selected as WAN Connection Detection Mode. Enter the interval for the system to execute the PING operation.
Ping Retry	It is available when Ping Detect is selected as WAN Connection Detection Mode. Enter the number of times that the system is allowed to execute the PING operation before WAN disconnection is judged.
PPPoE Pass-through	
To Wired LAN	Switch the toggle to enable or disable the function. If enabled, the wired LAN clients can initiate PPPoE dial-up connections to the WAN. The router offers PPPoE dial-up connection. Besides, you also can establish the PPPoE connection directly from local clients to your ISP via the Vigor router. When PPPoA protocol is selected, the PPPoE package transmitted by PC will be transformed into PPPoA package and sent to WAN server. Thus, the PC can access Internet through such direction.
Options under the Advanced Mode	
ADSL Setting	<p>Below shows the additional options for ADSL Setting:</p> <p>Encapsulation - Encapsulating type of the ADSL connection.</p>  <p>Multiplexing - Encapsulating type of the ADSL connection. Available values are LLC (Logical Link Control) and VC-Mux (Virtual Circuit Multiplexing). Contact your ISP for the correct encapsulating type.</p>
QoS	
ATM QoS	<p>Configure the Quality of Service (QoS) of the ATM circuit. Select a proper QoS type for the interface.</p>  <p>UBR Without PCR- Unspecified Bit Rate.</p> <p>UBR With PCR- Unspecified Bit Rate. Enter the value for PCR (Peak Cell Rate, 0_5500) if select UBR With PCR.</p> <p>CBR - Constant Bit Rate.</p> <p>nrtVBR - Non-real-time Variable Bit Rate.</p>

	rtVBR - Real-time Variable Bit Rate.
IPv4 - Below shows the additional options for IPv4 Setting:	
Service Name (Optional)	It is available when PPPoA/PPPoE is selected as IPv4 Connection Type. Sets the PPP service name tag. Required by some ISPs. Leave blank unless instructed otherwise by your ISP.
Fallback Account	It is available when PPPoA/PPPoE is selected as IPv4 Connection Type. Switch the toggle to enable or disable the function. Once the primary user account fails to set a network connection, use the fallback account instead. Username - Enter a string as a username of the fallback account. Password - Enter a string as the password.
Separate Account for ADSL	It is available when PPPoA/PPPoE is selected as IPv4 Connection Type. In default, WAN1 supports VDSL2/ADSL and uses the same PPPoE account and password for connection. If ADSL mode requires a separate user name and password, enable this function and fill out the Username and Password fields below. Switch the toggle to enable or disable the function. Username - Enter a string as the username. Password - Enter a string as the password.
PPP Authentication	It is available when PPPoA/PPPoE is selected as IPv4 Connection Type. It means the protocol used for PPP authentication. Both PAP and CHAP (Challenge-Handshake Authentication Protocol) can be used for PPP authentication. Router negotiates with the PPTP or L2TP server to determine which protocol to use.
IP Assignment	It is available when PPPoA/PPPoE is selected as IPv4 Connection Type. DHCP - WAN IP address is dynamically allocated. Static IP - ISP has assigned a fixed WAN IP address. ● IP Address - Enter the IP address offered by your ISP.
IP Alias	+Add - Click to enter multiple WAN IPv4 addresses assigned by your ISP.
MTU	
MTU	Maximum Transmission Unit, the size of the largest packet, in bytes, that can be transmitted to the WAN. The maximum value is 1500. For PPPoE connections, there is always an 8-byte overhead, so the maximum valid MTU value for PPPoE is 1492.
WAN MAC Address	
Mode	Default - Use the default MAC address for the WAN Ethernet port. Customized - Select this option if your ISP authenticates by MAC addresses. ● MAC - Specify a MAC address for the WAN Ethernet port.
Cancel	Discard current settings and return to previous page.
Apply	Save the current settings and exit the page.

After finishing this web page configuration, please click **Apply** to save the settings.

i Note:

Switch these two icons by click the mouse cursor on them.



- means "Enable".



- means "Disable".

II-2-2-2 Virtual WAN

Up to five virtual WAN profiles can be set for applying to different applications.

Each profile can be specified with ATM QoS, VLAN, and binding interfaces according to the requirement of the practical network environment.

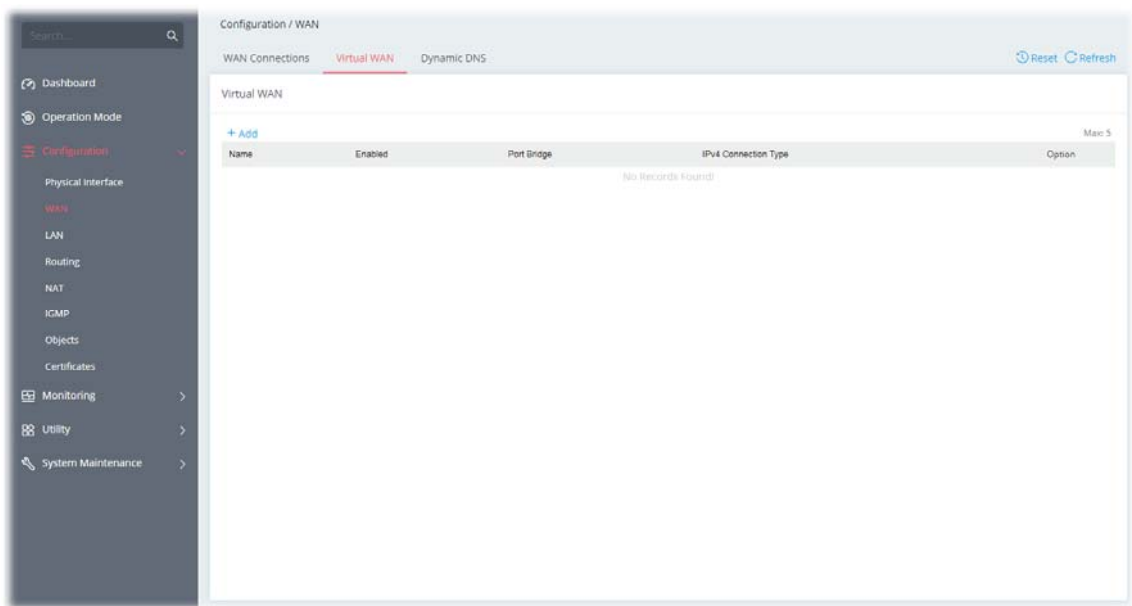

To add a new virtual WAN, click the **+Add** link to get the following page.

Configuration / WAN

WAN Connections **Virtual WAN** Dynamic DNS Reset Refresh

Close X Show Advanced Mode

Name

Enabled

General

Physical Interface

ADSL Setting

VPI (0-255)

VCI (32-65535)

Customer VLAN

VDSL2 Setting

Tag (0-4094)
Note: Tag value "0" will set the VLAN ID to "zero" instead of untagged.

Priority (0-7)

Port-Based Bridge

Cancel

Available settings are explained as follows:

Item	Description
Show / Hide Advanced Mode	Click to show or hide the advanced settings for virtual WAN.
Name	Enter a name as the profile name.
Enabled	Switch the toggle to enable or disable the function.
General	
Physical Interface	Displays the WAN type (e.g., DSL) of the physical interface.
ADSL Setting	<p>VPI - Enter the value provided by ISP.</p> <p>VCI - Enter the value provided by ISP.</p> <p>Customer VLAN - Click to enable the function of VLAN with tag. If enabled,</p> <ul style="list-style-type: none"> ● Tag - Enter the value as the VLAN ID number. The range is from 0 to 4094. ● Priority - Enter the packet priority number for such VLAN. The range is from 0 to 7.
VDSL2 Setting	<p>Tag - Enter the value as the VLAN ID number. The range is from 0 to 4094.</p> <p>Priority - Enter the packet priority number for such VLAN. The range is from 0 to 7.</p>
Port-Based Bridge	
Port Bridge	<p>Switch the toggle to enable or disable the function.</p> <p>Binding Interface - Click +Add to add an interface for binding.</p>
IPv4	

Enabled	Switch the toggle to enable or disable the function.
IPv4 Connection Type	There are four types for network connection: <ul style="list-style-type: none"> ● PPPoE ● PPPoA ● DHCP ● Static IP
Username/Password	It is available when PPPoE/PPPoA is selected as IPv4 Connection Type.
IP Address	It means the WAN IP address assigned by the ISP. It is available when Static IP is selected as IPv4 Connection Type.
Subnet Mask	It means the WAN subnet mask. It is available when Static IP is selected as IPv4 Connection Type.
Gateway IP	It means the IP address of the WAN Gateway. It is available when Static IP is selected as IPv4 Connection Type.

Options under the Advanced Mode

ADSL Setting	<p>Below shows the additional options for ADSL Setting:</p> <p>Encapsulation - Encapsulating type of the ADSL connection.</p>  <p>Multiplexing - Encapsulating type of the ADSL connection. Available values are LLC (Logical Link Control) and VC-Mux (Virtual Circuit Multiplexing). Contact your ISP for the correct encapsulating type.</p>
---------------------	---

QoS

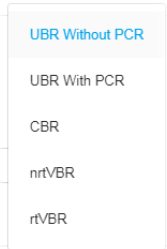
ATM QoS	<p>Configure the Quality of Service (QoS) of the ATM circuit. Select a proper QoS type for the interface.</p>  <p>UBR Without PCR- Unspecified Bit Rate.</p> <p>UBR With PCR- Unspecified Bit Rate. Enter the value for PCR (Peak Cell Rate, 0_5500) if select UBR With PCR.</p> <p>CBR - Constant Bit Rate.</p> <p>nrtVBR - Non-real-time Variable Bit Rate.</p> <p>rtVBR - Real-time Variable Bit Rate.</p>
----------------	--

Cancel	Discard current settings and return to previous page.
Apply	Save the current settings and exit the page.

After finishing this web page configuration, please click **Apply** to save the settings.

II-2-2-3 Dynamic DNS

Most ISPs assigns dynamic WAN IP addresses to their customers. Dynamic IP addresses presents challenges to users who would like to accept remote connections to their LANs from the Internet, as service could be disrupted due to the IP address changing without notice. By setting up service with a Dynamic DNS (DDNS) provider, and configuring Dynamic DNS updates on the Vigor router, you can have reliable access to your network by means of an easy-to-remember domain address that resolves to the most current WAN IP address.

The Vigor router supports a wide range of DDNS providers. Please contact the DDNS provider of your choice to set up service before configuring DDNS on the router.

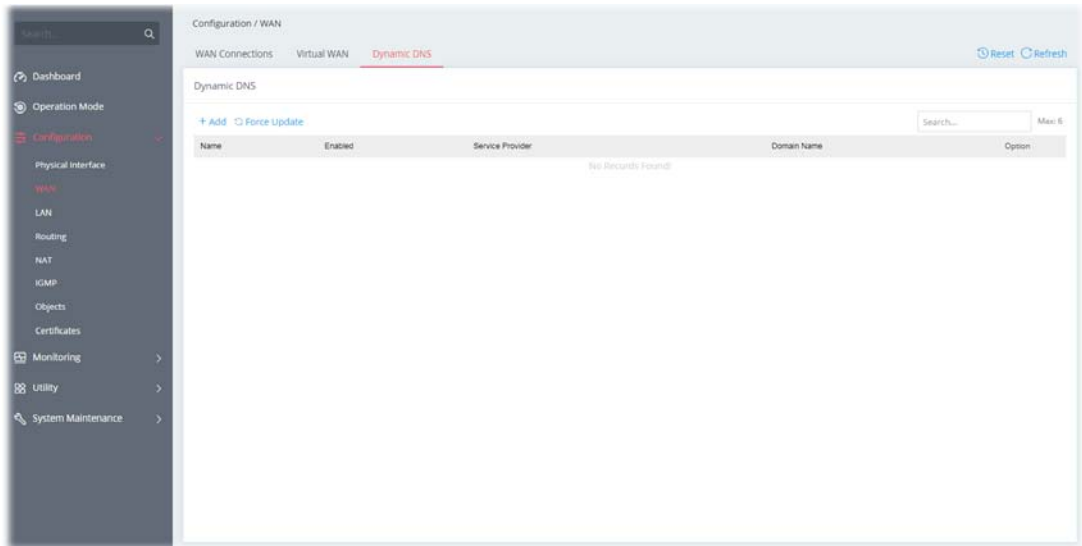

Item	Description
Reset	Click to clear all profiles to factory settings.
+Add	Click to bring up the configuration page of the DDNS profile (max. 6).
Force Update	Click to connect immediately to DDNS servers to update IP address information.

To add a new DDNS profile, click the **+Add** link to get the following page.

Available settings are explained as follows:

Item	Description
Name	Enter a name as the profile name.
Enabled	Switch the toggle to enable or disable the function.
Service Provider	Select the DDNS provider. If your DDNS provider is not listed, select User-Defined and manually configure the profile. <ul style="list-style-type: none"> ● DrayDDNS ● NO-IP ● User-Defined
If DrayDDNS is selected as Service Provider	Service Status - Click Activate to activate the service. Expire Date - Display the expired date of the service. Domain Name - Display the domain and sub-domain to be updated.
If NO-IP is selected as Service Provider	Domain Name - The domain and sub-domain to be updated. Account Name - Enter the login name of the DDNS account. Password - Enter the password of the DDNS account.
If User-Defined is selected as Service Provider	Provider Host URL - Enter the IP address or the domain name of the host which provides related service. Service API - Enter the IP address or the domain name of the host which provides related service. Server Response - Enter any text that you want to receive from the DDNS server. Account Name - Enter the login name of the DDNS account. Password - Enter the password of the DDNS account. Auth Type - Two types can be used for authentication. <ul style="list-style-type: none"> ● Basic - Username and password defined later can be shown from the packets captured. ● URL - Username and password defined later can be shown in URL.

Let's Encrypt Certificate	<p>Display the information related to Let's Encrypt certificate.</p> <p>Activate - Click it to generate a certificate issued by Let's Encrypt for applying to such DDNS account.</p>
More settings	
Update DDNS with	<p>If a Vigor router is installed behind any NAT router, you can enable such function to locate the real WAN IP.</p> <p>When the WAN IP used by Vigor router is private IP, this function can detect the public IP used by the NAT router and use the detected IP address for DDNS update.</p> <p>There are two methods offered for you to choose:</p> <ul style="list-style-type: none"> ● WAN IP - The IP address of the router's WAN interface will be used. ● Internet IP - The real public IP address will be used. Select this option if the IP address assigned to the router's WAN interface is not the actual external IP address.
Auto Update Interval	<p>The frequency, in minutes, at which the router connects to DDNS servers to update IP address information.</p> <p>The default is 14400.</p>
Cancel	Discard current settings and return to previous page.
Apply	Save the current settings and exit the page.

After finishing this web page configuration, please click **Apply** to save the settings.

II-2-3 LAN

Local Area Network (LAN) is a group of subnets regulated and ruled by modem.

II-2-3-1 LAN Networks

To configure the general settings the LAN network, select **Configuration>>LAN** to open the following page.

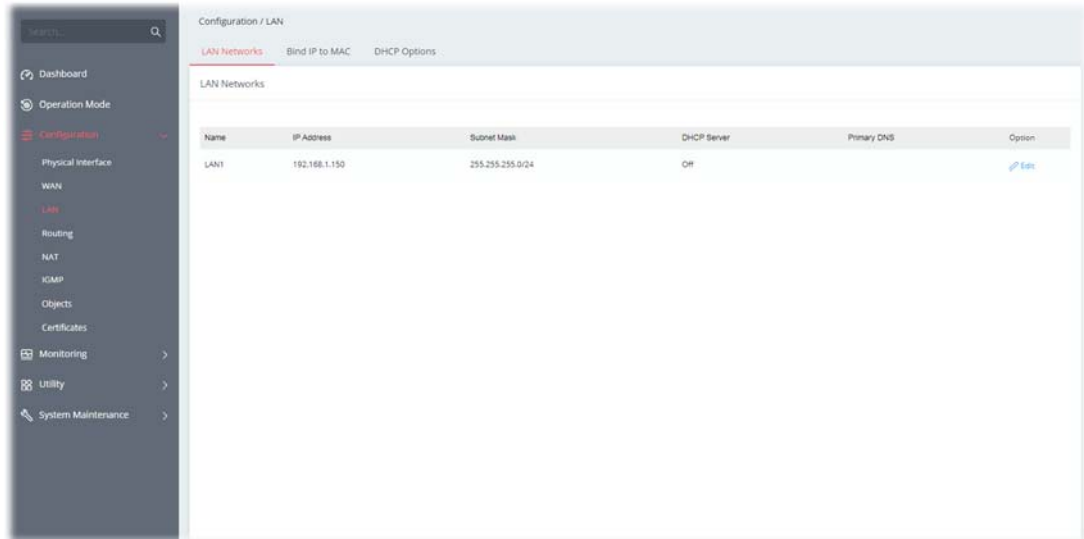

Available settings are explained as follows:

Item	Description
Name	Displays the number of LAN interface.
IP Address	Displays the IP address of the LAN interface.
Subnet Mask	Displays the subnet mask of the LAN interface.
Option	Edit - Click to modify the name, IP address, and subnet mask settings.

To configure the detailed settings for the selected WAN interface, click the **Edit** link to the right side of the LAN interface.

Available settings are explained as follows:

Item	Description
Name	Enter a brief comment for the LAN interface.
IPv4	
IP Address	Enter the IP address of the LAN interface.
Subnet Mask	Select a subnet mask of the LAN interface.
DHCP Server Configuration	
DHCP Server	<p>DHCP stands for Dynamic Host Configuration Protocol. The router by factory default acts a DHCP server for your network so it automatically dispatches related IP settings to any local user configured as a DHCP client. It is highly recommended that you leave the router enabled as a DHCP server if you do not have a DHCP server for your network.</p> <p>If you want to use another DHCP server in the network other than the Vigor Router's, you can let Relay Agent help you to redirect the DHCP request to the specified location.</p> <p>On - Enables the built-in DHCP server on the router.</p> <p>Off - Disables the built-in DHCP server on the router.</p> <p>Relay - When selected, all DHCP requests are forwarded to a DHCP server outside of the LAN subnet, and whose address is specified in the DHCP Server IP Address field.</p>
If On is selected as DHCP Server	<p>Start IP Address - The beginning LAN IP address that is given out to LAN DHCP clients.</p> <p>IP Pool Counts - The maximum number of IP addresses to be handed out by DHCP. The default value is 200. Valid range is between 1 and 1021. The actual number of IP addresses available for assignment is the IP Pool Counts, or 1021 minus the last octet of the Start IP Address, whichever is smaller.</p> <p>Gateway IP Address - The IP address of the gateway, which is the</p>

	<p>host on the LAN that relays all traffic coming into and going out of the LAN. The gateway is normally the router, and therefore the Gateway IP Address should be identical to the IP Address in the IPv4 section above.</p> <p>Lease Time - The maximum duration DHCP-issued IP addresses can be used before they have to be renewed.</p> <p>Primary DNS - DNS stands for Domain Name System. Every Internet host must have a unique IP address, also they may have a human-friendly, easy to remember name such as www.yahoo.com. The DNS server converts the user-friendly name into its equivalent IP address.</p> <p>You must specify a DNS server IP address here because your ISP should provide you with usually more than one DNS Server.</p> <p>Secondary DNS - You can specify secondary DNS server IP address here because your ISP often provides you more than one DNS Server.</p>
If Relay is selected as DHCP Server	<p>When selected, all DHCP requests are forwarded to a DHCP server outside of the LAN subnet, and whose address is specified in the DHCP Server IP Address field.</p> <p>Interface for 1st DHCP Server - Specify a WAN interface for the first DHCP Server.</p> <p>1st DHCP Server IP Address - Enter the IP Address of the DHCP server to which DHCP requests from LAN clients are forwarded.</p> <p>Interface for 2nd DHCP Server - The secondary DHCP server is an optional setting. If required, specify a WAN interface for the second DHCP Server as a backup server.</p> <p>2nd DHCP Server IP Address - Enter the IP Address of the DHCP server to which DHCP requests from LAN clients are forwarded.</p>
More settings	
Force DNS Redirection	<p>Switch the toggle to enable or disable the function.</p> <p>It allows all outgoing DNS lookups to be intercepted and redirected to the router's built-in DNS server, improving the domain lookup performance by caching DNS queries and results.</p>
Virtual Interface	<p>Switch the toggle to enable or disable the function.</p> <p>The virtual interface is a routing interface that can be used for routing packets to specified domain.</p> <p>IP Address - Enter an IP address.</p> <p>Subnet Mask - Select a subnet mask.</p> <p>After configuring this option, set a Bind IP to MAC profile (based on the IP address and subnet mask set above) or specify a static IP for the clients.</p>
Cancel	Discard current settings and return to the previous page.
Apply	Save the current settings and exit the page.

After finishing this web page configuration, please click **Apply** to save the settings.

II-2-3-2 Bind IP to MAC

This function is used to bind the IP and MAC address in LAN to have a strengthening control in network. With the Bind IP to MAC feature you can reserve LAN IP addresses for LAN clients. Each reserved IP address is associated with a Media Access Control (MAC) address.

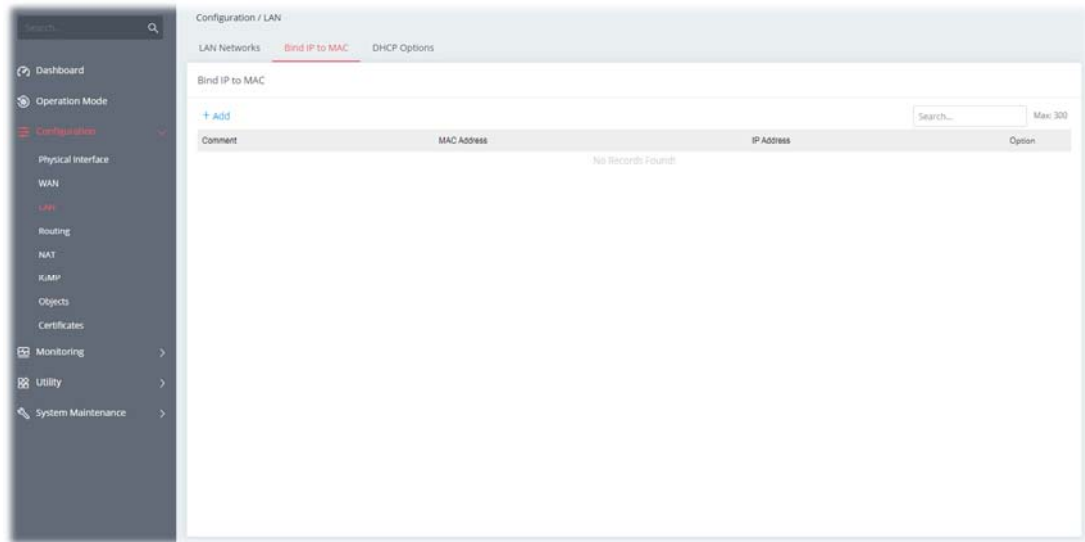

To add a new profile, click the **+Add** link to get the following page.

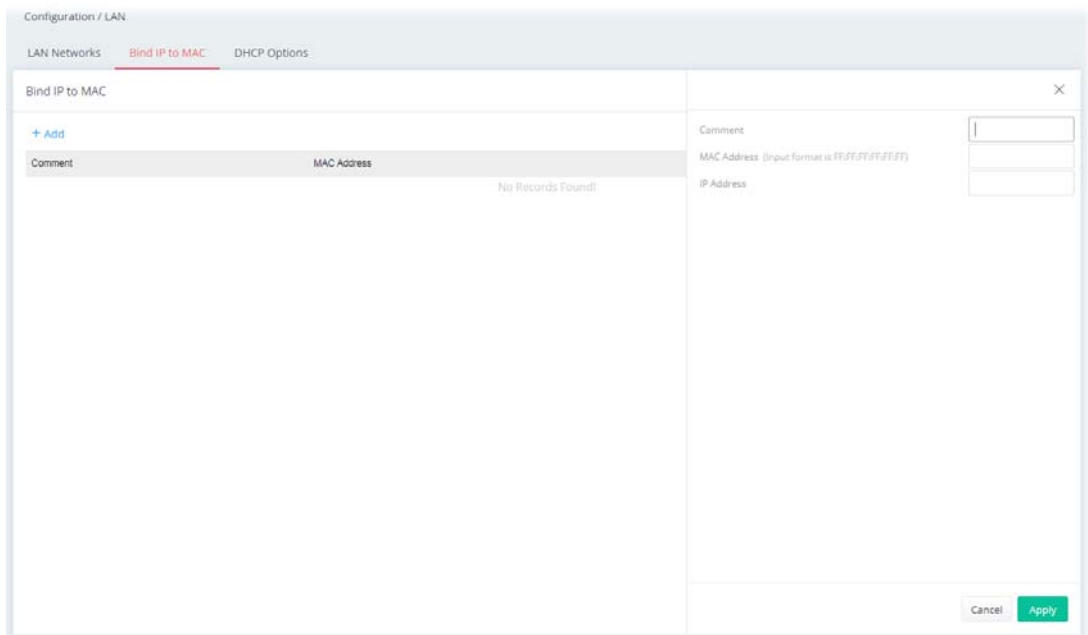

Available settings are explained as follows:

Item	Description
Comment	Enter a brief comment to identify this IP Address – MAC Address pair.
MAC Address	Enter the MAC address of the LAN client's network interface.
IP Address	Enter the IP address to be associated with a MAC address.
Cancel	Discard current settings and return to the previous page.

Apply

Save the current settings and exit the page.

After finishing this web page configuration, please click **Apply** to save the settings.

II-2-3-3 DHCP Options

DHCP packets can be processed by adding option number and data information when such function is enabled and configured.

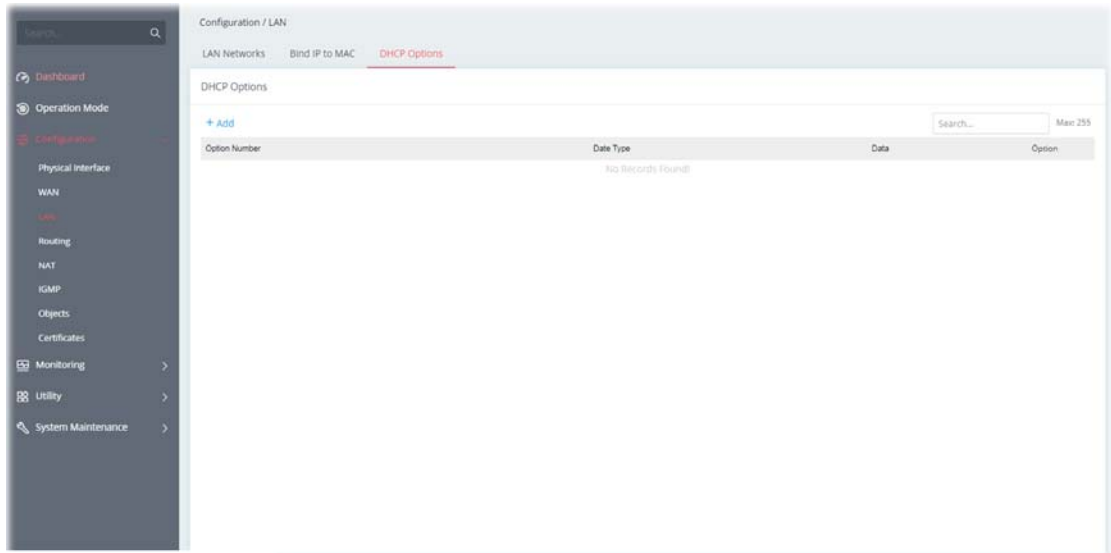

To add an option, click the **+Add** link to get the following page.

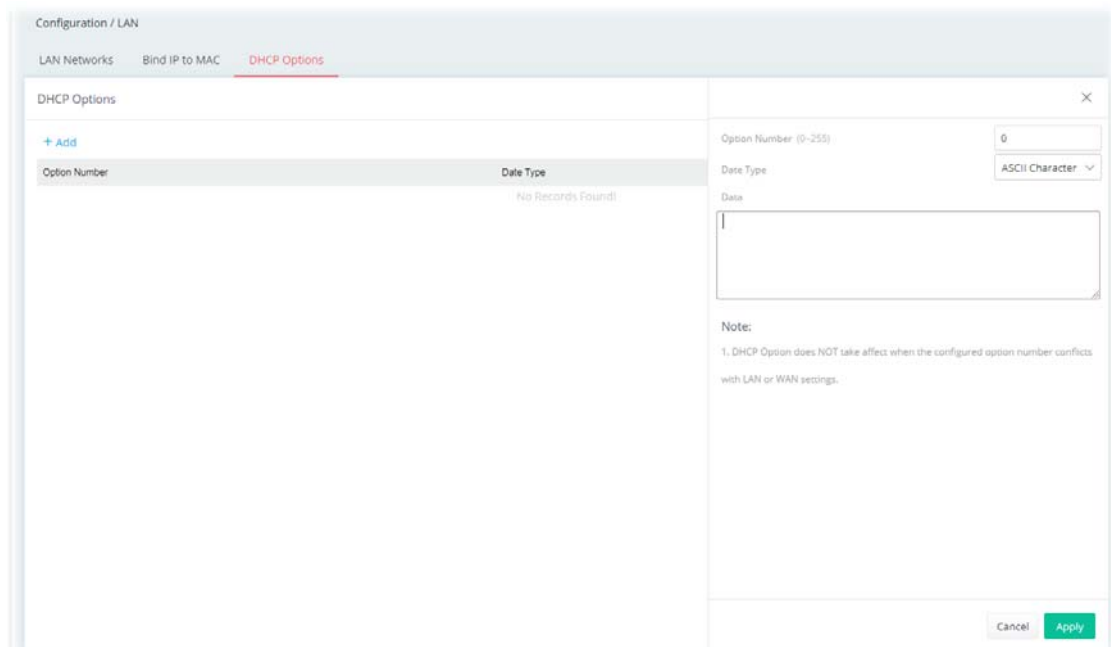

Available settings are explained as follows:

Item	Description
Option Number	Enter a number for this function.

Data Type	Choose the type (ASCII or Hex or Address List) for the data to be stored.
Data	Enter the data in the Data field based on the data type selected. ASCII Character - A text string. Example: /path. Hexadecimal Digital - A hexadecimal string. Valid characters are from 0 to 9 and from a to f. Example: 2f70617468. Address List - One or more IPv4 addresses, delimited by commas.
Cancel	Discard current settings and return to the previous page.
Apply	Save the current settings and exit the page.

After finishing this web page configuration, please click **Apply** to save the settings.

II-2-4 Routing

Static routing is an alternative to dynamic routing. It is a process that the system network administrator can configure network routers with all the required information for packet forwarding.

Open **Configuration >> Routing**.

II-2-4-1 IPv4 Static Route

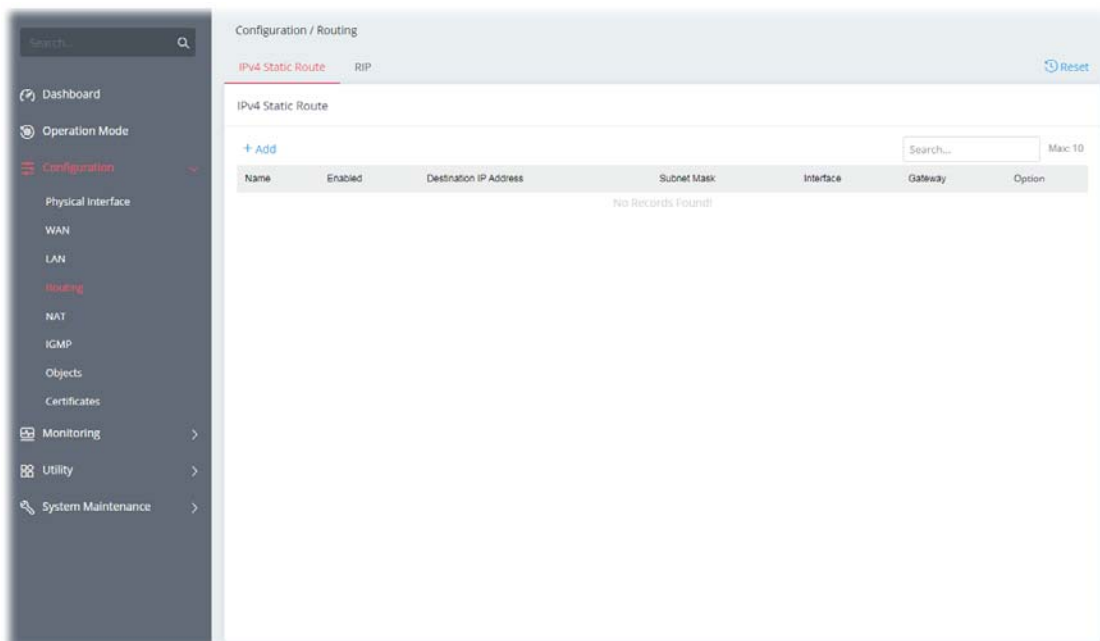

To add a new IPv4 static route, click the **+Add** link to get the following page.

Configuration / Routing

IPv4 Static Route RIP Reset

IPv4 Static Route ✕

[+ Add](#)

Name	Enabled	Destination IP Address	Subnet Mask
No Records Found			

Name

Enabled

Destination IP Address

Subnet Mask

Interface

Gateway

Available settings are explained as follows:

Item	Description
Name	Enter a name as the profile name.
Enabled	Switch the toggle to enable or disable the function.
Destination IP Address	Enter the IP address as the destination IP address.
Subnet Mask	Select a subnet mask of this static route.
Interface	Use the drop-down list to specify an interface for this static route.
Gateway	Enter an IP address as the gateway.
Cancel	Discard current settings and return to the previous page.
Apply	Save the current settings and exit the page.

After finishing this web page configuration, please click **Apply** to save the settings.

II-2-4-2 RIP

The Routing Information Protocol (RIP) is the most popular interior routing protocol used by a router.

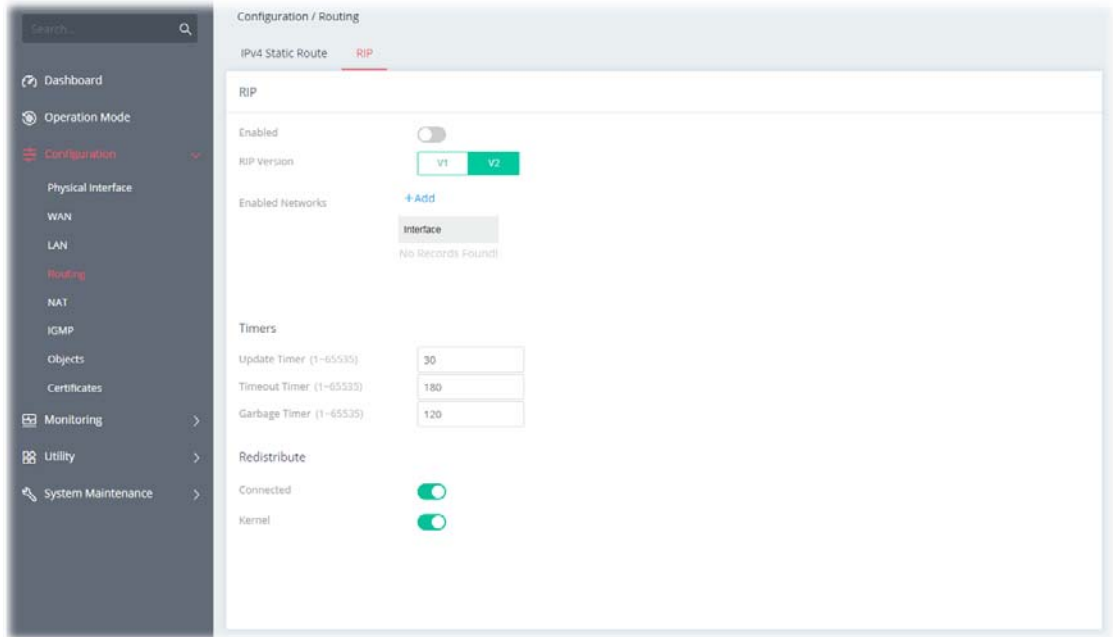

Available settings are explained as follows:

Item	Description
Enabled	When Enabled, the router will attempt to exchange routing information with neighbouring routers using the Routing Information Protocol.
RIP Version	Specify the version number (V1/V2) for RIP protocol.
Enabled Networks	+Add - Specify an interface (LAN/WAN) for applying the RIP.
Timers	
Update Timer	Enter a value as the update timer. When the time is up, the Vigor router will send a message containing the complete routing table to all neighboring routers for exchanging the routing information.
Timeout Timer	The routing information will be valid (but not removed) till the time expiration set in this field. The information will be kept in the routing table temporarily. At the same time, the neighbors will be notified that the route has been dropped.
Garbage Timer	The route will be removed from the routing table upon the expiration set in Garbage Timer.
Redistribute	
Connected	Redistribute connected routes into the RIP tables.
Kernel	Redistribute kernel routes into the RIP tables.
Apply	Save the current settings and exit the page.

After finishing this web page configuration, please click **Apply** to save the settings.

i Note:

Switch these two icons by click the mouse cursor on them.



- means "Enable".



- means "Disable".

II-2-5 NAT

Most ISPs allocate one WAN IP address to each subscriber. In order to simultaneously connect multiple devices to the Internet, a technique called Network Address Translation is employed.

Usually, the router serves as an NAT (Network Address Translation) router. NAT is a mechanism that one or more private IP addresses can be mapped into a single public one. Public IP address is usually assigned by your ISP, for which you may get charged. Private IP addresses are recognized only among internal hosts.

When the outgoing packets destined to some public server on the Internet reach the NAT router, the router will change its source address into the public IP address of the router, select the available public port, and then forward it. At the same time, the router shall list an entry in a table to memorize this address/port-mapping relationship. When the public server response, the incoming traffic, of course, is destined to the router's public IP address and the router will do the inversion based on its table. Therefore, the internal host can communicate with external host smoothly.

The benefit of the NAT includes:

- **Save cost on applying public IP address and apply efficient usage of IP address.** NAT allows the internal IP addresses of local hosts to be translated into one public IP address, thus you can have only one IP address on behalf of the entire internal hosts.
- **Enhance security of the internal network by obscuring the IP address.** There are many attacks aiming victims based on the IP address. Since the attacker cannot be aware of any private IP addresses, the NAT function can protect the internal network.

II-2-5-1 Port Forwarding

This function allows inbound traffic from specific ports on WAN interfaces to be forwarded to LAN clients.

It allows you to open a range of ports for the traffic of special applications.

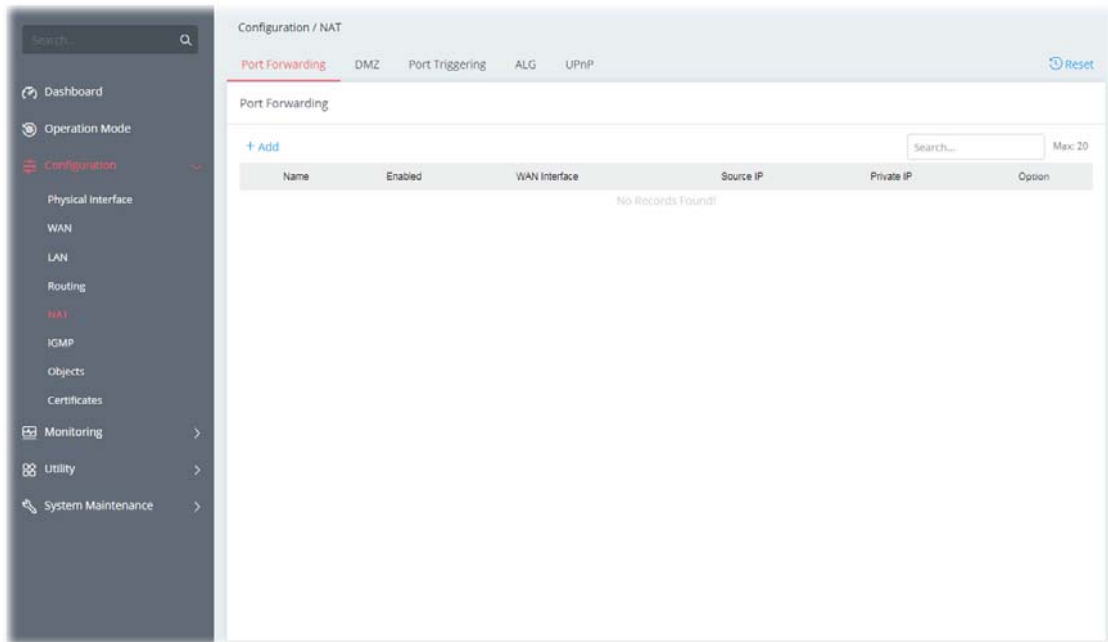

To add a new port forwarding profile, click the **+Add** link to get the following page.

Available settings are explained as follows:

Item	Description
Name	Enter a name that identifies the rule.
Enabled	Switch the toggle to enable or disable the function.
Network	
WAN Interface	The WAN port(s) whose incoming traffic will be forwarded to a LAN client. Select from a specific WAN interface WAN# to apply the rule to

	the WAN interface.
Source IP	<p>Any - Any data traffic coming from the source IP will be forwarded to a LAN.</p> <p>IP Address - Set a range of IP addresses. Any data traffic coming from the IP addresses within the range will be forwarded to a LAN.</p> <p>IP Object - Use the drop down list to specify an IP object profile.</p> <p>IP Group - Use the drop down list to specify an IP group profile.</p>
Private IP	<p>Specify a LAN IP address or a range of LAN IP addresses to which the traffic will be forwarded.</p> <p>Single - Specify a destination LAN IP address that will receive the forwarded traffic.</p> <p>Range - Specify a range of destination LAN IP addresses that will receive the forwarded traffic.</p>
Port Forwarding	
+Add	<p>Click to set port numbers for the specified protocol (TCP, UDP, or TCP/UDP) for a port forwarding profile.</p> <p>Protocol - The protocol to which this rule applies, TCP, UDP or TCP/UDP.</p> <p>Public Port Start - Specify which port can be redirected to the specified Private IP and Port of the internal host. Enter the required number as the starting port.</p> <p>Public Port End - Enter the required number as the ending port.</p> <p>Private Port Start - The port on each LAN client to which the traffic will be directed to. Enter the required number as the starting port.</p> <p>Private Port End - Enter the required number as the ending port.</p> <p>Options - Click Delete to remove the selected entry.</p>
Cancel	Discard current settings and return to the previous page.
Apply	Save the current settings and exit the page.

After finishing this web page configuration, please click **Apply** to save the settings.

II-2-5-2 DMZ

Vigor router provides a facility **DMZ Host** that maps ALL unsolicited data on any protocol to a single host in the LAN. Regular web surfing and other such Internet activities from other clients will continue to work without inappropriate interruption. **DMZ Host** allows a defined internal user to be totally exposed to the Internet, which usually helps some special applications such as Netmeeting or Internet Games etc.

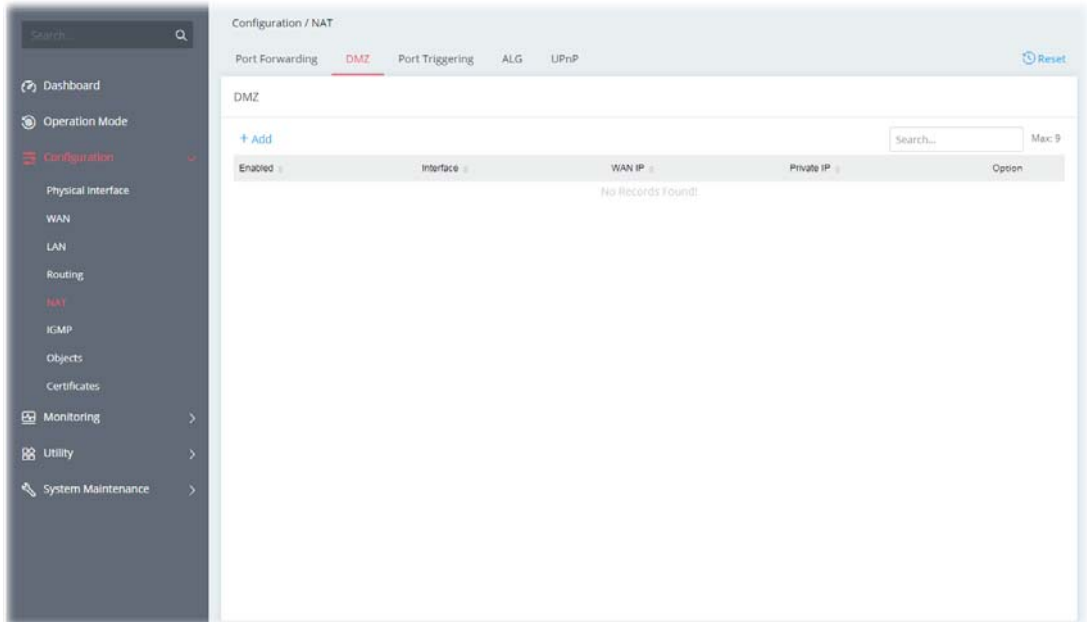

To add a new DMZ profile, click the **+Add** link to get the following page.

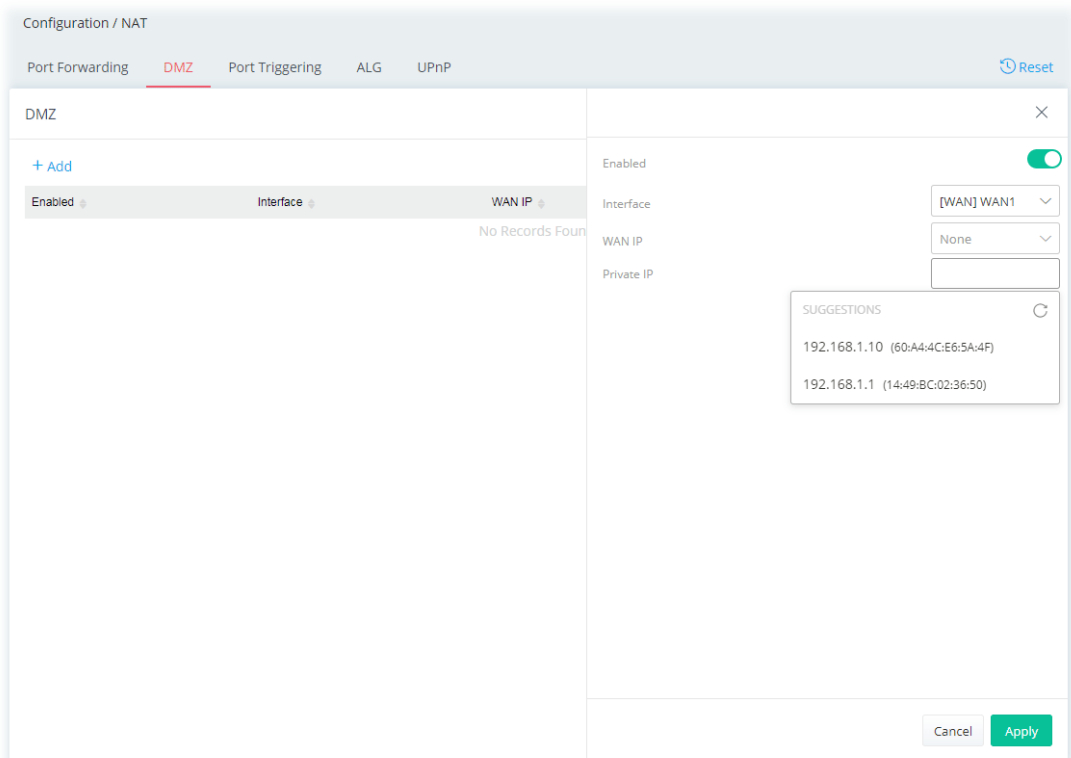

Available settings are explained as follows:

Item	Description
------	-------------

Enabled	Switch the toggle to enable or disable the function.
Interface	Allows WAN traffic to be sent to a specific LAN IP address.
WAN IP	Enable the function of applying WAN alias IP. Then, select a WAN alias IP from the available IPv4 alias settings set on Configuration >> WAN >> WAN Connections.
Private IP	Select one private IP address in the list to be the DMZ host.
Cancel	Discard current settings and return to the previous page.
Apply	Save the current settings and exit the page.

After finishing this web page configuration, please click **Apply** to save the settings.

II-2-5-3 Port Triggering

If you run programs that function as server applications where they expect to receive unsolicited traffic from the WAN, you can set up rules in Port Triggering to detect LAN-to-WAN traffic initiated by those programs, and automatically open up WAN ports to accept incoming traffic and forward it to the LAN client running the server applications.

The duration that these ports are opened depends on the type of protocol used. The "default" values are shown below and these duration values can be modified via telnet commands.

TCP: 86400 sec.

UDP: 180 sec.

IGMP: 10 sec.

TCP WWW: 60 sec.

TCP SYN: 60 sec.

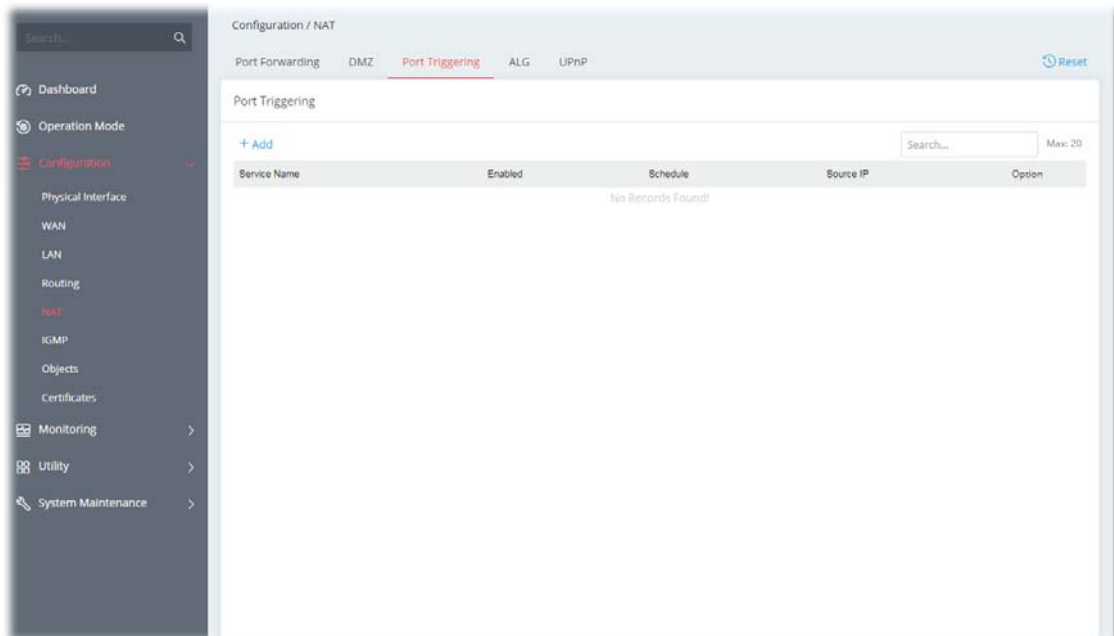

To add a new port triggering profile, click the **+Add** link to get the following page.

Configuration / NAT

Port Forwarding DMZ **Port Triggering** ALG UPnP Reset

Add Service Manually Preset

Service Name

Enabled

Schedule Always On Scheduled On

Triggering Source

Source IP

Protocol & Port +Add Max: 5

Triggering Protocol	Triggering Port Start	Triggering Port End
No Records Found!		

Incoming Services

Protocol & Port +Add Max: 5

Incoming Protocol	Incoming Port Start	Incoming Port End
-------------------	---------------------	-------------------

Cancel Apply

Available settings are explained as follows:

Item	Description
Add Service	Select from list of predefined service, or manually configure triggering and incoming protocols and ports. Manually - If selected, self-define the service name. Preset - If selected, various services will be offered for you to choose as the service name.
Enabled	Switch the toggle to enable or disable the function of port triggering.
Schedule	Vigor router can perform the port triggering all the time or on a certain date and time. Always On - The function of port triggering is running all the time. Scheduled On - The function of port triggering is activated based on the schedule profile.
Triggering Source	
Source IP	Any - Any source IP will be forwarded to a LAN. IP Address - Set a range of IP addresses forwarded to a LAN. IP Object - Use the drop down list to specify an IP object profile. IP Group - Use the drop down list to specify an IP group profile.
Protocol & Port	+Add - Click to set port numbers (start and end) for the specified protocol (TCP, UDP or TCP/UDP) for the outgoing data (that this rule monitors).
Incoming Services	
Protocol & Port	+Add - Click to set port numbers (start and end) for the specified protocol (TCP, UDP or TCP/UDP) for the incoming data. Incoming Protocol - The protocol(s) of the incoming traffic. ● TCP -open port(s) to TCP traffic.

	<ul style="list-style-type: none"> ● UDP- open port(s) to UDP traffic. ● TCP/UDP- open port(s) to both TCP and UDP traffic. <p>Select the protocol (TCP, UDP or TCP/UDP) for the incoming data of such triggering profile.</p> <p>Incoming Port - Incoming traffic from the WAN destined for these port numbers be forwarded to the LAN client that triggered the rule. Enter the port or port range for the incoming packets.</p>
Cancel	Discard current settings and return to the previous page.
Apply	Save the current settings and exit the page.

After finishing this web page configuration, please click **Apply** to save the settings.

II-2-5-4 ALG

ALG means **Application Layer Gateway**. There are two methods provided by Vigor router, RTSP (Real Time Streaming Protocol) ALG and SIP (Session Initiation Protocol) ALG, for processing the packets of voice and video.

RTSP ALG makes RTSP message, RTCP message, and RTP packets of voice and video be transmitted and received correctly via NAT by Vigor router.

However, SIP ALG makes SIP message and RTP packets of voice be transmitted and received correctly via NAT by Vigor router.

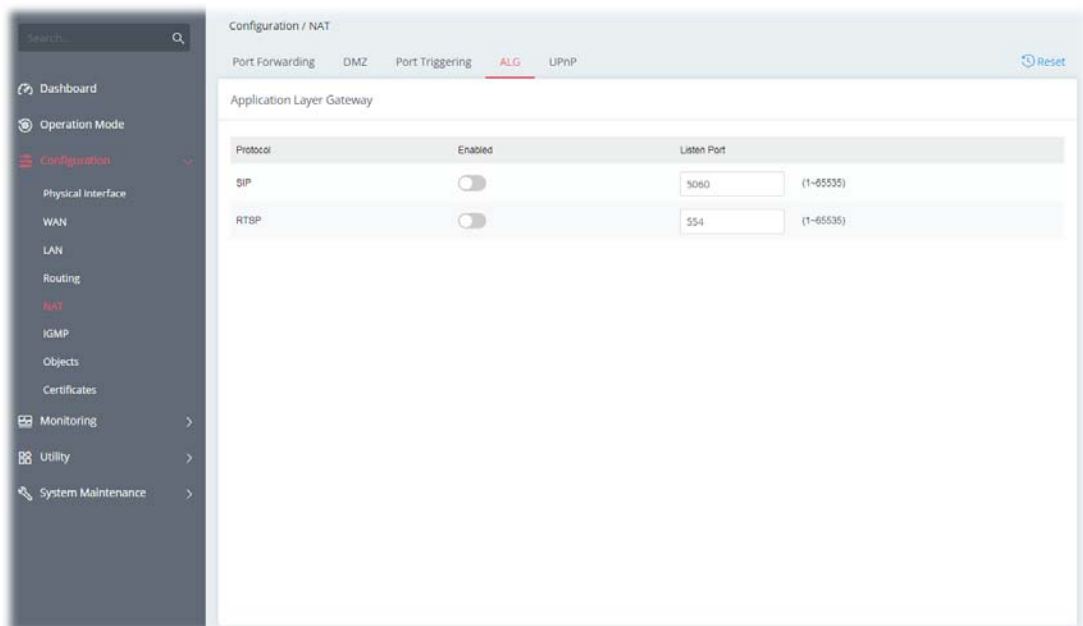

Available settings are explained as follows:

Item	Description
Enabled	Switch the toggle to enable or disable the function.
Listen Port	Enter a port number for SIP or RTSP protocol.
Apply	Save the current settings and exit the page.

After finishing this web page configuration, please click **Apply** to save the settings.

II-2-5-5 UPnP

The Vigor supports UPnP (Universal Plug and Play), which is a suite of network protocols that simplifies network configuration. Applications and network devices on the LAN, that support UPnP, may request the router to modify its settings to allow NAT Traversal, so that WAN hosts can connect to them directly.

Examples of applications and devices that support UPnP include file-sharing applications such as uTorrent, Vuze and eMule, gaming consoles such as the Sony PlayStations 3 and 4 Xbox 360 and Xbox One, media streaming applications such as Plex and XBMC, and messaging and calling applications such as Skype. To find out if a certain application or network device supports or requires UPnP, please consult its user manual or check with its vendor.

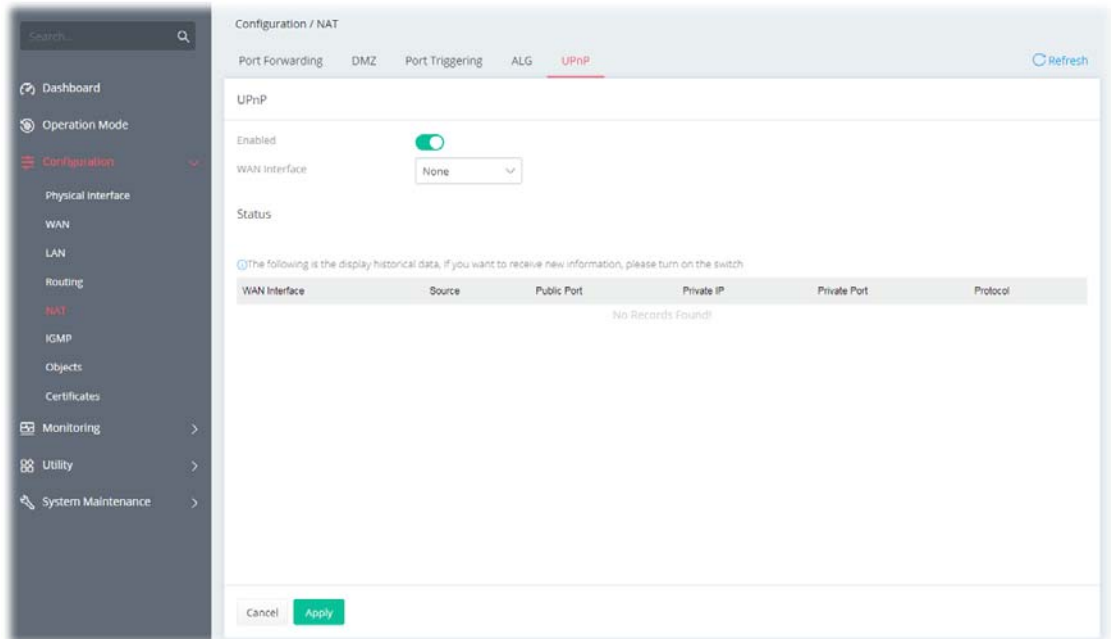

Available settings are explained as follows:

Item	Description
UPnP	
Enabled	Switch the toggle to enable or disable the function. UPnP is required for some applications such as PPS, Skype, eMule...and etc. If you are not familiar with UPnP, it is suggested to turn off this function for security.
WAN Interface	Select the WAN port on which ports will be opened in response to UPnP commands.
Status	Displays the historical data.
Cancel	Discard current settings and return to the previous page.
Apply	Save the current settings and exit the page.

After finishing this web page configuration, please click **Apply** to save the settings.

II-2-6 IGMP

Internet Group Management Protocol (IGMP) is an IPv4 communication protocol for establishing multicast group memberships.

II-2-6-1 IGMP Setup

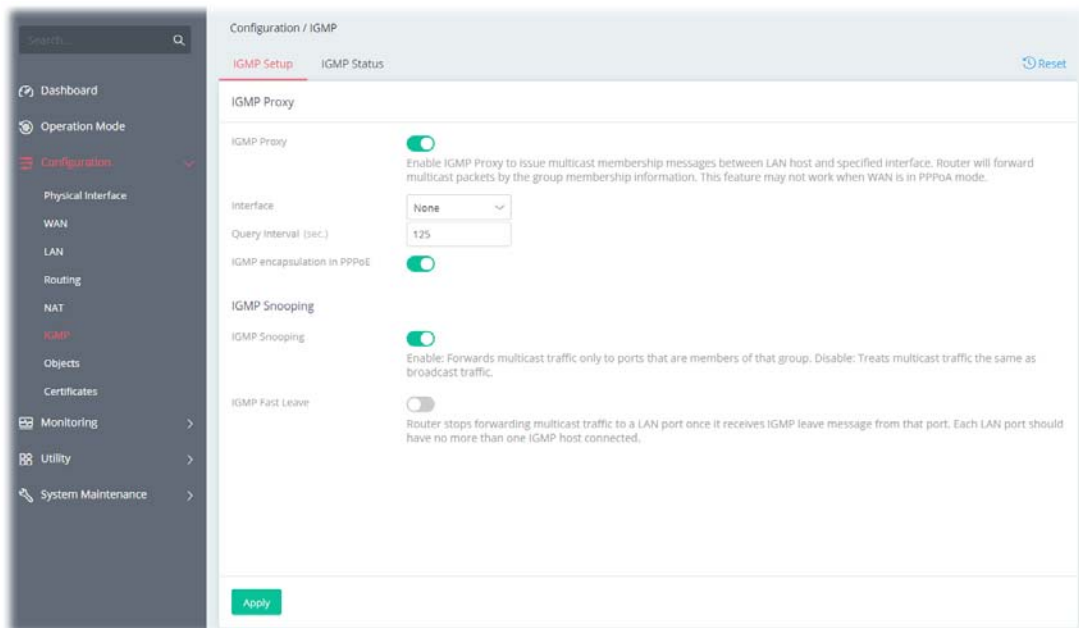

Available settings are explained as follows:

Item	Description
IGMP Proxy	
IGMP Proxy	Switch the toggle to enable or disable the function. The application of multicast will be executed through WAN /PVC/VLAN port. In addition, such function is available in NAT mode.
Interface	Specify an interface for packets passing through.
Query Interval	Vigor router will periodically check which IP obtaining IPTV service by sending query. It might cause inconvenience for client. Therefore, set a suitable time (unit: second) as the query interval to limit the frequency of query sent by Vigor router.
IGMP encapsulation in PPPoE	Enable this function if the interface type for IGMP is PPPoE. It depends on the specifications regulated by each ISP. If you have no idea to enable or disable, simply contact your ISP providers.
IGMP Snooping	
IGMP Snooping	Select to enable IGMP Snooping so that multicast traffic are forwarded to IGMP clients that have joined a multicast group.
IGMP Fast Leave	This option is shown only when IGMP Snooping is enabled. Select to enable IGMP Fast Leave. Normally when the router receives a "leave" message from an IGMP host, it will send a last member query message to see if there are still

	members within the multicast group. When Fast Leave is enabled, multicast for a group is immediately terminated when the last host in that group sends a “leave” message.
Apply	Save the current settings and exit the page.

After finishing this web page configuration, please click **Apply** to save the settings.

II-2-6-2 IGMP Status

Displays a list of active multicast groups.

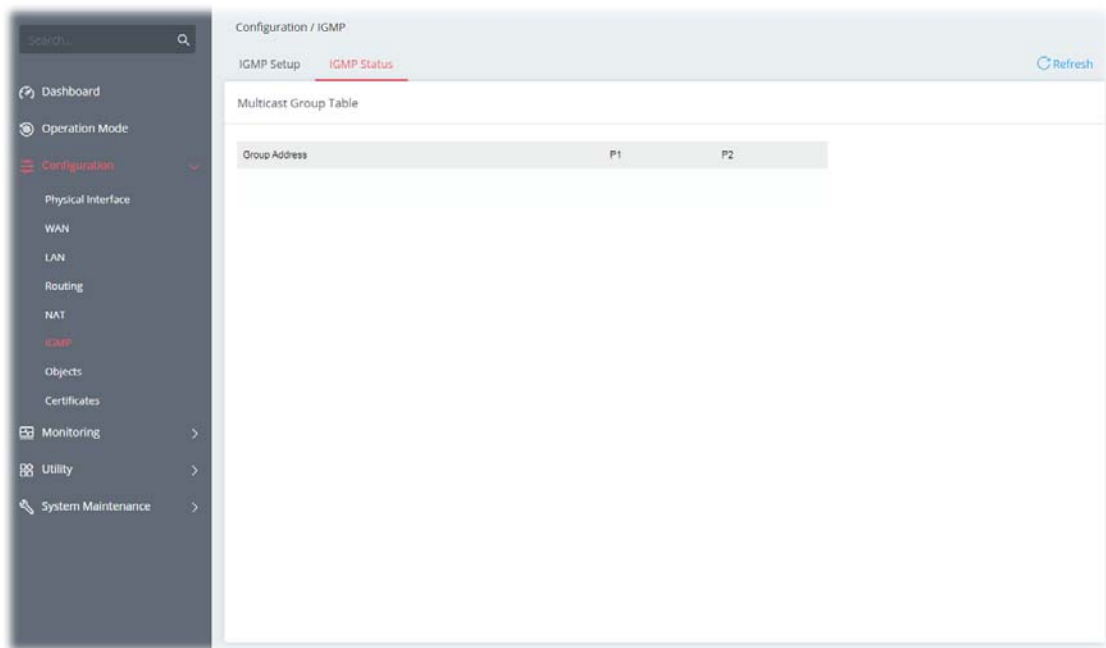

Item	Description
Group ID	ID port of the multicast group, which is within the IP range reserved for IGMP, 224.0.0.0 through 239.255.255.254.
P1 to P2	LAN ports that have IGMP hosts joined to this multicast group.

II-2-7 Objects

II-2-7-1 IP Object

For IPs in a range and service ports in a limited range usually will be applied in configuring router's settings, therefore we can define them with **objects** and bind them with **groups** for using conveniently. Later, we can select that object/group for applying it. For example, all the IPs in the same department can be defined with an IP object (a range of IP address).

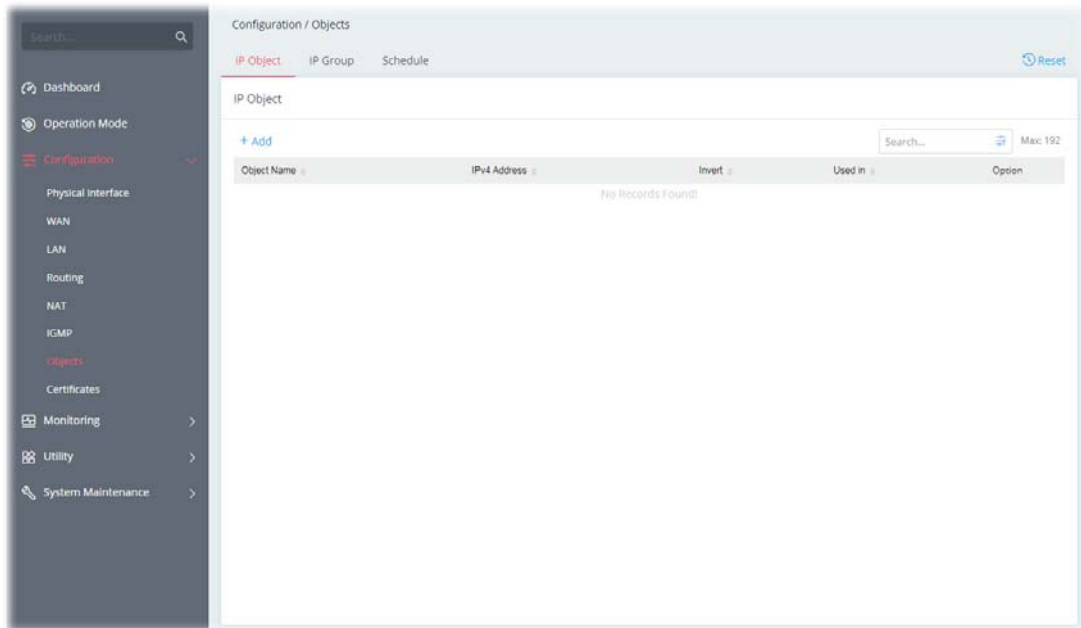

To add a new IP object profile, click the **+Add** link to get the following page.

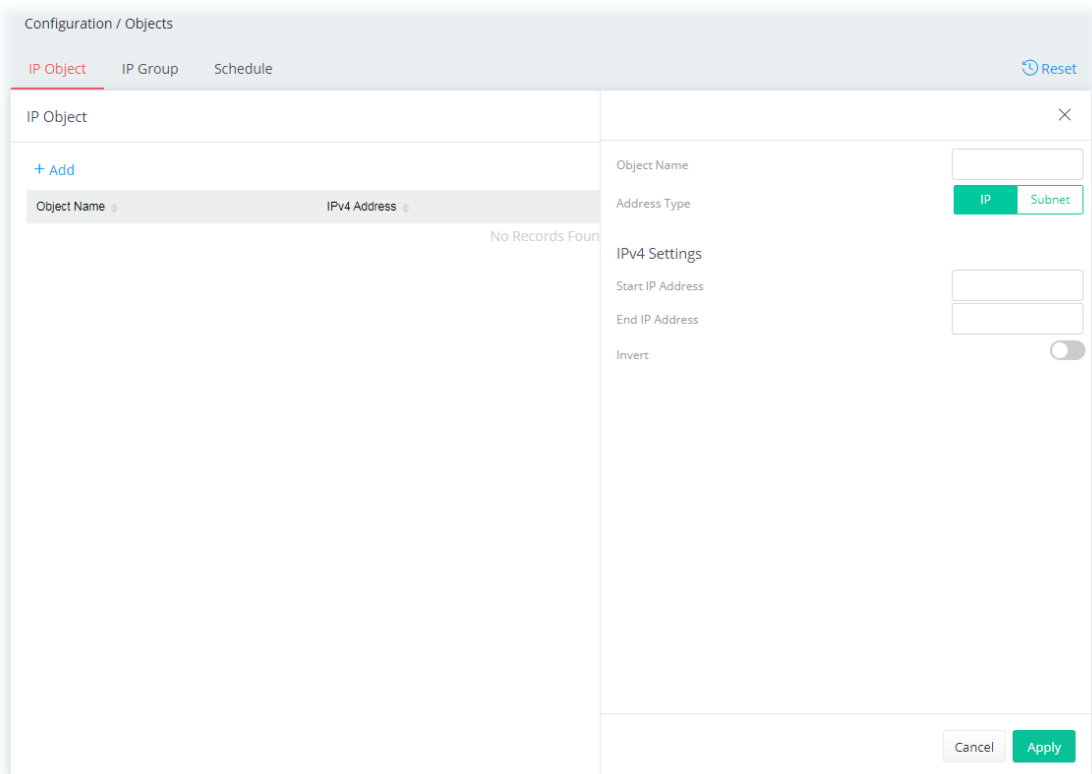

Available settings are explained as follows:

Item	Description
Object Name	Enter the name that identifies this profile.
Address Type	Select the type (IP or Subnet) of address.
IPv4 Settings	
Start IP Address	Enter the beginning IP address, if the Address Type is IP. To set a range of IP addresses, enter the different IP addresses as start IP address and end IP address.

End IP Address	Enter the ending IP address, if Address Type is IP.
IP Address	Enter an IP address if Address Type is Subnet Mask.
Subnet Mask	Enter subnet mask, if Address Type is Subnet Mask.
Invert	If enabled, all addresses except the ones entered above will be used.
Cancel	Discard current settings and return to the previous page.
Apply	Save the current settings and exit the page.

After finishing this web page configuration, please click **Apply** to save the settings.

II-2-7-2 IP Group

Multiple IP Objects can be placed into an IP Group.

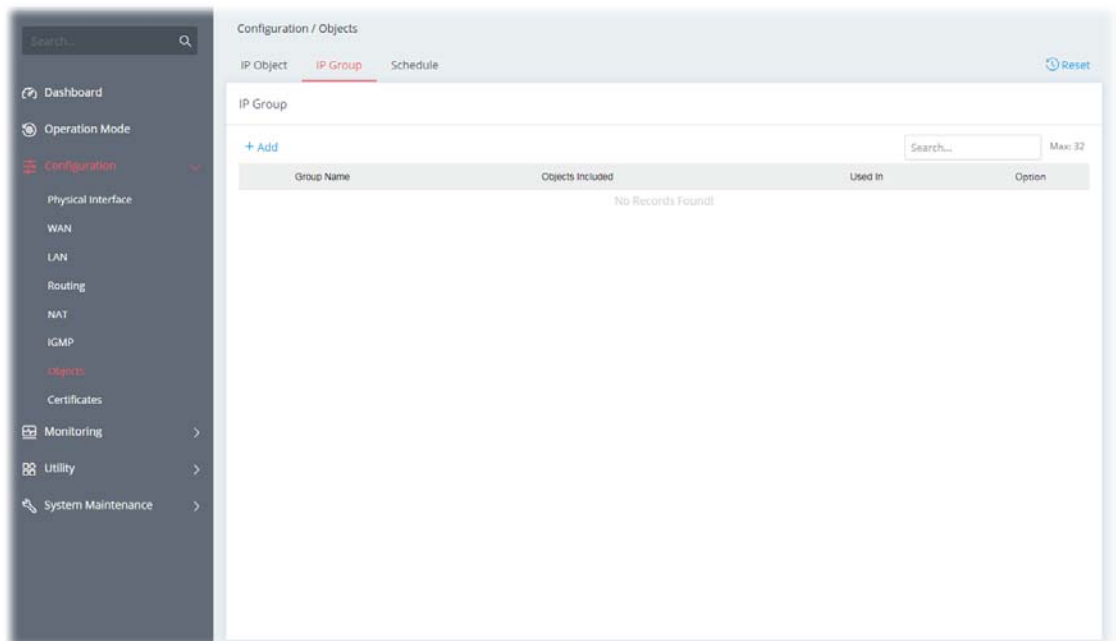

To add a new IP group profile, click the **+Add** link to get the following page.

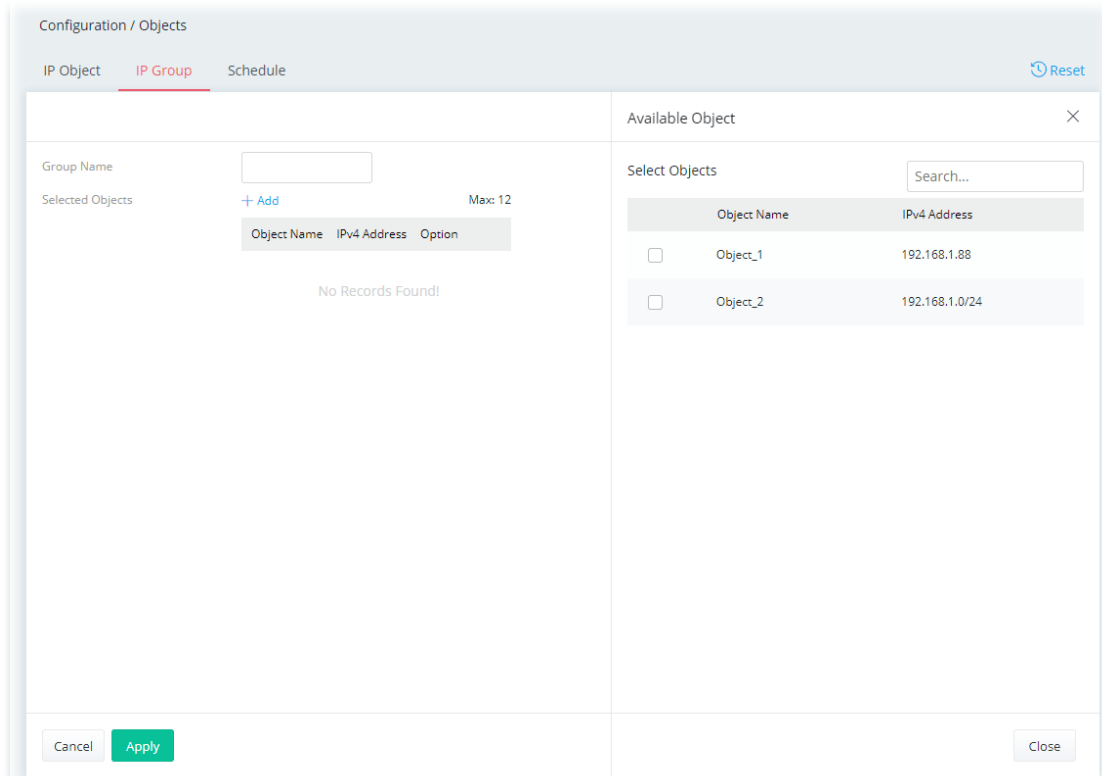

Available settings are explained as follows:

Item	Description
Group Name	Enter a name that identifies this profile.
Selected Objects	+Add - Click to open the page with available objects.
Available Object	
Selected Objects	Search - Enter the IP object name or the IPv4 address to display related information.
Object Name / IPv4 Address	Select the object(s) to be grouped under the current IP group. The selected one will be shown under the Selected Objects on the left side.
Cancel	Discard current settings and return to the previous page.
Apply	Save the current settings.

After finishing this web page configuration, please click **Apply** to save the settings.

II-2-7-3 Schedule

Time schedules can be created and used with router features that support them, so that those features can be turned on and off automatically at preconfigured times.

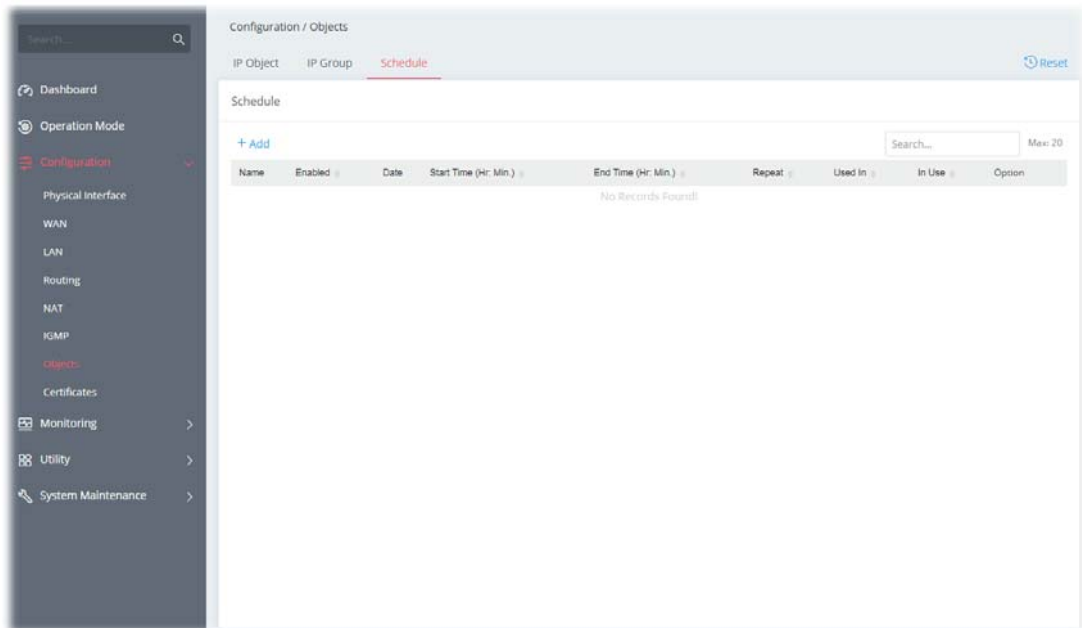

To add a new schedule profile, click the **+Add** link to get the following page.

Available settings are explained as follows:

Item	Description
Name	Enter the name of the schedule profile.
Enabled	Switch the toggle to enable or disable this schedule profile.

Date	Select the date when the entry comes into effect.
Start Time	Set the time when the schedule is triggered.
End Time	Set the time for the schedule to be ended.
Repeat	<p>Once - The schedule is triggered once based on Date, Start Time and End Time.</p> <p>Daily - The schedule is triggered everyday based on Start Time and End Time.</p> <ul style="list-style-type: none"> ● End Repeat - If enabled, the schedule will be triggered every day till the date defined in the End Repeat Date. ● End Repeat Date - The schedule will be ended on the specified date. <p>Weekly - The schedule will be triggered, starting at the Start Time and ending at the End Time, on the selected days of the week.</p> <ul style="list-style-type: none"> ● Every - Select the day for triggering the schedule. ● End Repeat - If enabled, the schedule will be triggered every week till the date defined in the End Repeat Date.. ● End Repeat Date - The schedule will be ended on the specified date. <p>Monthly - The schedule will be triggered monthly based on the Date setting. For example, choose 2022-04-27 as the date set. Later, this schedule will be triggered on the 27th of every month.</p> <ul style="list-style-type: none"> ● End Repeat - If enabled, the schedule will be triggered every month till the date defined in the End Repeat Date. ● End Repeat Date - The schedule will be ended on the specified date. <p>Cycle - Any action applied this schedule will be executed per several days.</p> <ul style="list-style-type: none"> ● Every (days) - Enter a number as cycle duration. Then, any action applied this schedule will be executed per several days. For example, "3" is set as cycle duration. That means, the action applied this schedule will be executed every three days since the date defined on the Start Date. ● End Repeat - If enabled, the schedule will be triggered every month till the date defined in the End Repeat Date. ● End Repeat Date - The schedule will be ended on the specified date.
Cancel	Discard current settings and return to the previous page.
Apply	Save the current settings and exit the page.

After finishing this web page configuration, please click **Apply** to save the settings.

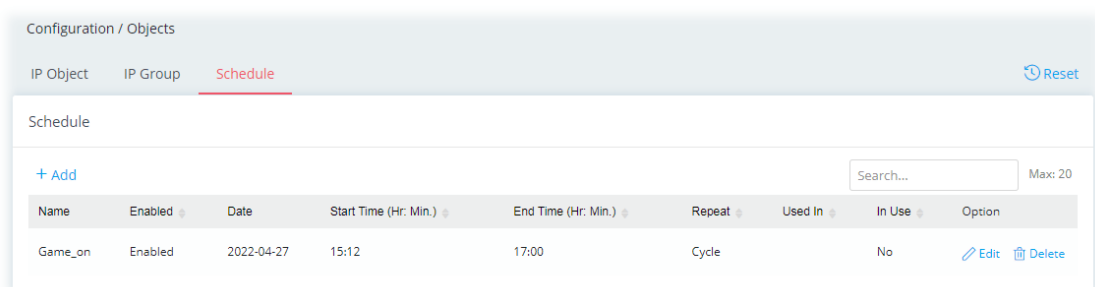

II-2-8 Certificates

A digital certificate is an electronic document issued by a certification authority (CA) to an entity to prove ownership of a public key. It contains identifying information including the issued-to party's name, a serial number, expiration dates etc., and the digital signature of the certificate-issuing authority so that a recipient can verify that the certificate is real. Vigor router supports digital certificates that conform to the X.509 standard.

In this section, you can generate and manage local digital certificates, and import trusted CA certificates. Be sure that the system time is correct on the router so that certificates will not be erroneously considered to be invalid because of an incorrect system time falling outside of the certificate's valid time period. The easiest way to accomplish this is by periodically synchronizing the system time to a Network Time Protocol (NTP) server.

II-2-8-1 Local Certificates

You can generate, import or view local certificates on this page.

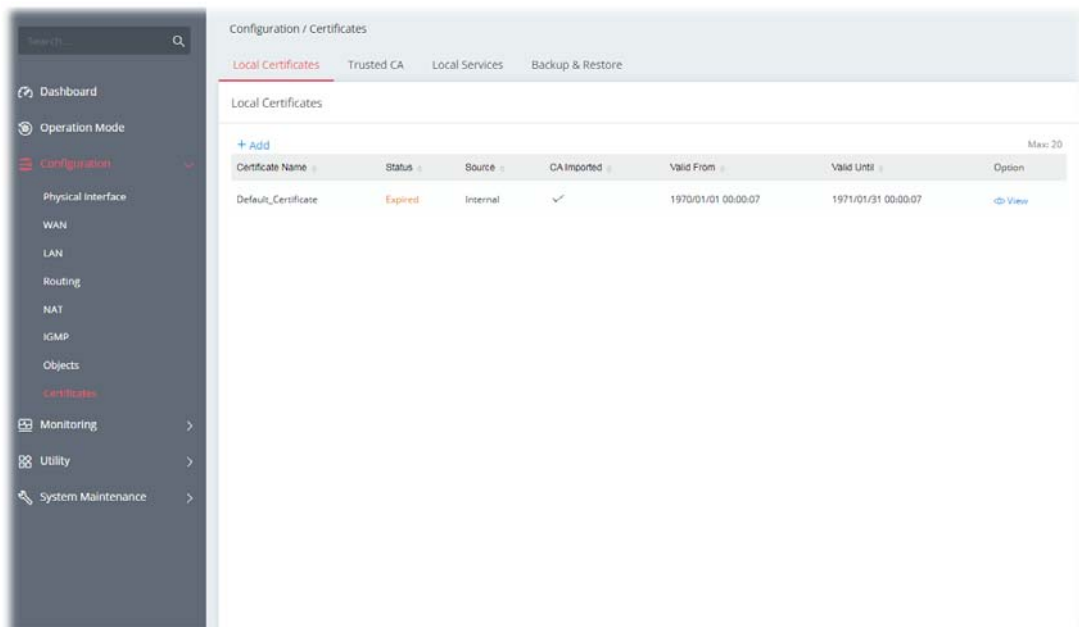

To check detailed information of the selected certificate, click **View**.

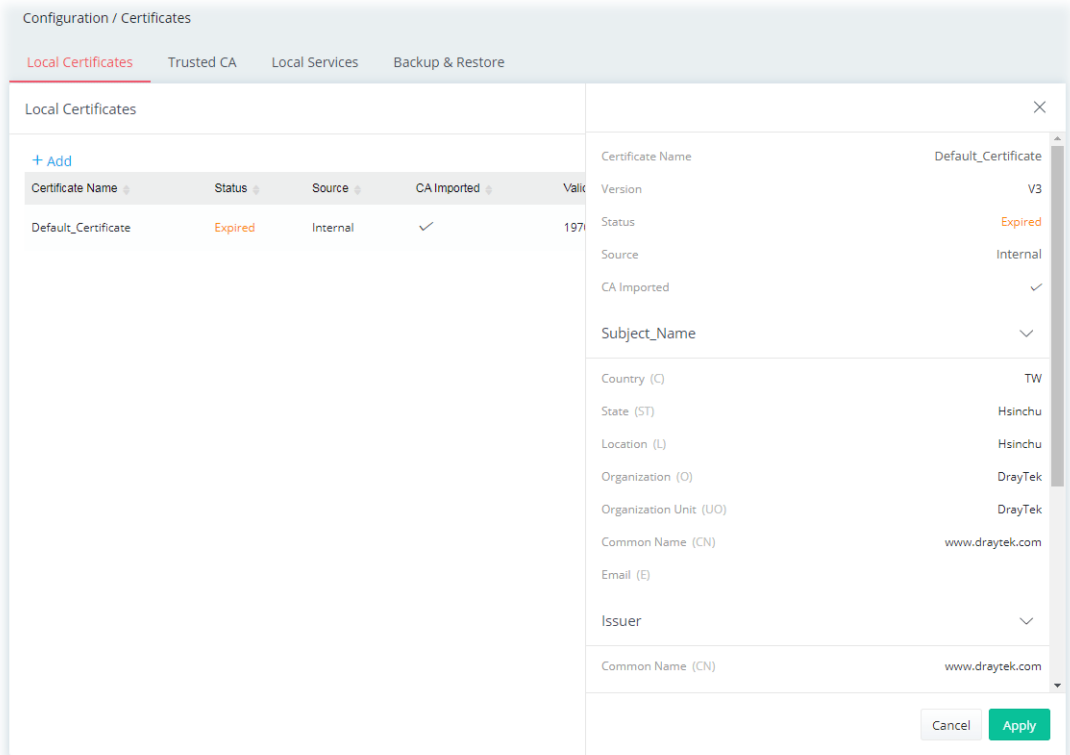

To add a new local certificate profile, click the **+Add** link to get the following page.

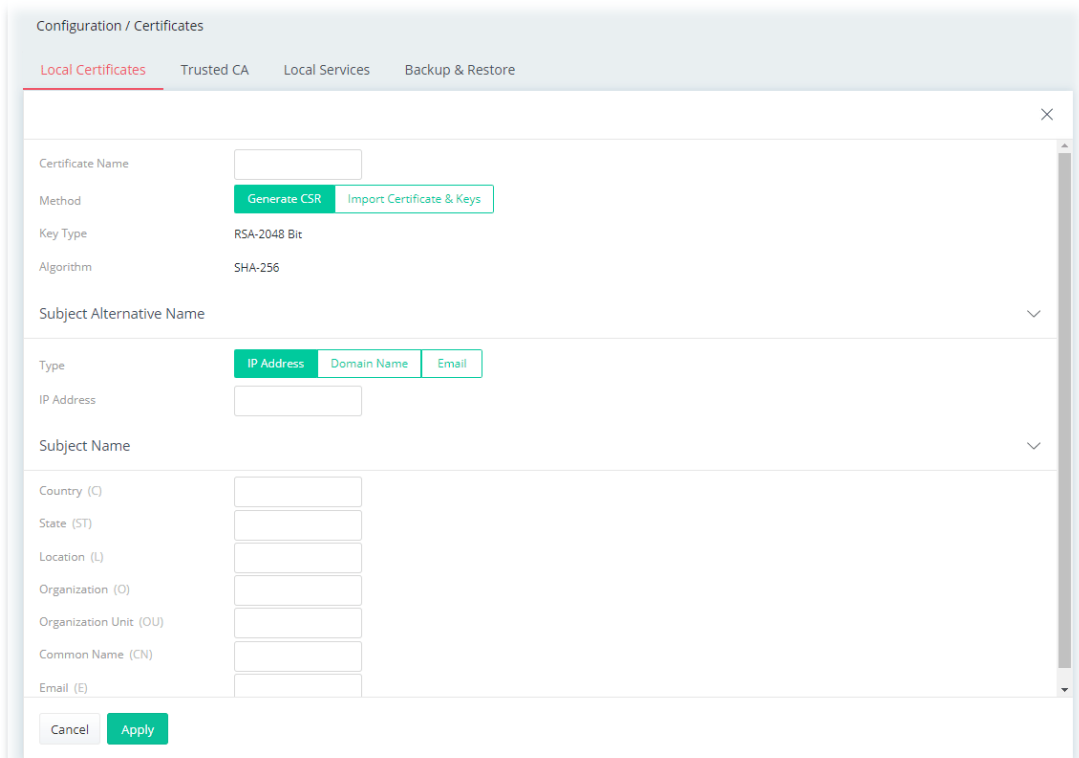

Available settings are explained as follows:

Item	Description
Certificate Name	Enter the name that identifies the certificate.
Method	Generate CSR - Generate a new local certificate. Import Certificate & Keys - Vigor router allows you to generate a

	certificate request and submit it the CA server, then import it as "Local Certificate". If you have already gotten a certificate from a third party, you may import it directly. The supported types are PKCS12 Certificate and Certificate with a private key.
Method - Generate CSR	
Key Type	Displays the key type used by the certificate.
Algorithm	Displays the algorithm for generating the certificate.
Type	Select the type of Subject Alternative Name and enter its value. <ul style="list-style-type: none"> ● IP Address ● Domain Name ● Email
Country (C)	Enter the country name (code) in which your organization is located.
State (ST)	Enter the state or province where your organization is located.
Location (L)	Enter the city where you're your organization is located.
Organization (O)	Enter the legal name of your organization.
Organization Unit (OU)	Enter the department within your organization that you wish to be associated with this certificate.
Common Name (CN)	Enter the fully-qualified domain name / WAN IP that will be used to reach your server.
Email (E)	Enter the email address of the entry.
Cancel	Discard current settings and return to the previous page.
Apply	Save the current settings and exit the page.
Method - Import Certificate & Keys	
File Type	<p>Vigor router allows you to generate a certificate request and submit it the CA server, then import it as "Local Certificate". If you have already gotten a certificate from a third party, you may import it directly. The supported types are PKCS12 Certificate and Certificate with a private key.</p> <p>Certificate Only - Local certificate.</p> <ul style="list-style-type: none"> ● Upload Certificate - Click Choose a file to select a local certificate file. <p>PKCS12 - Users can import the certificate whose extensions are usually .pfx or .p12. And these certificates usually need passwords. PKCS12 is a standard for storing private keys and certificates securely. It is used in (among other things) Netscape and Microsoft Internet Explorer with their import and export options.</p> <ul style="list-style-type: none"> ● Upload PKCS12 File - Click Choose a file to select a PKCS12 certificate file. ● Password - Enter the password associated with the certificate and key files. <p>Certificate & Keys - It is useful when users have separated certificates and private keys. And the password is needed if the private key is encrypted.</p> <ul style="list-style-type: none"> ● Upload File - Click Choose a file to select a local certificate file. ● Upload Key - Click Choose a file to select a key file. ● Password - Enter the password associated with the certificate

	and key files.
Cancel	Discard current settings and return to the previous page.
Apply	Save the current settings and exit the page.

After finishing this web page configuration, please click **Apply** to save the settings.

II-2-8-2 Trusted CA

The user can build RootCA certificates (up to three) if required.

Trusted CA certificate lists three sets of trusted CA certificate. In addition, you can build a RootCA certificate if required.

When the local client and remote client are required to make certificate authentication (e.g., IPsec X.509) for data passing through SSL tunnel and avoiding the attack of MITM, a trusted root certificate authority (Root CA) will be used to authenticate the digital certificates offered by both ends.

However, the procedure of applying digital certificate from a trusted root certificate authority is complicated and time-consuming. Therefore, Vigor router offers a mechanism which allows you to generate root CA to save time and provide convenience for general user. Later, such root CA generated by DrayTek server can perform the issuing of local certificate.

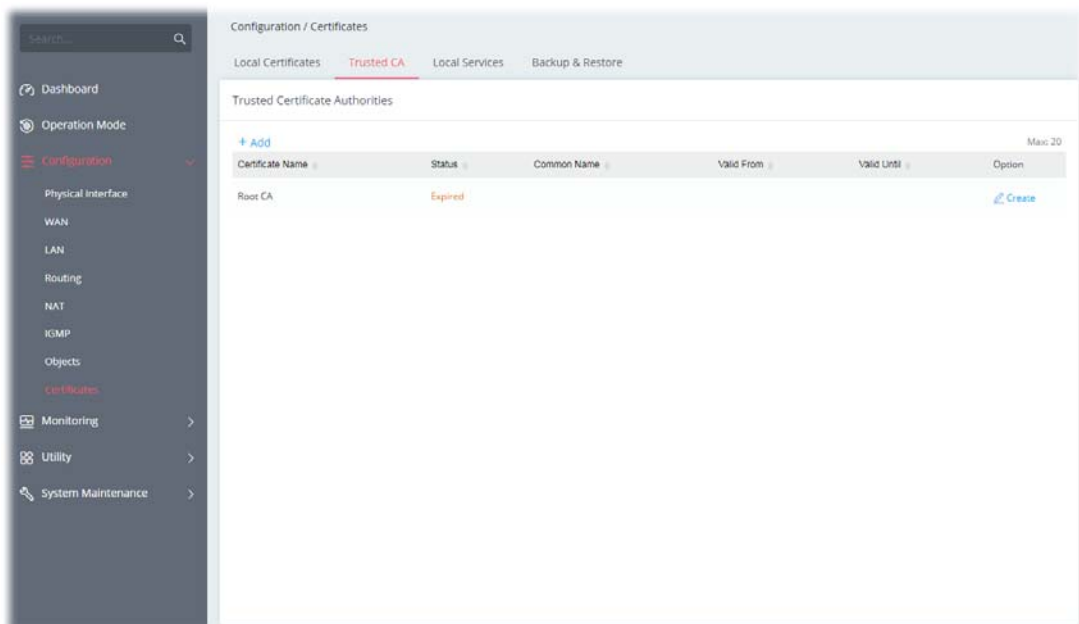

To create a new RootCA, click **Create** to get the following page.

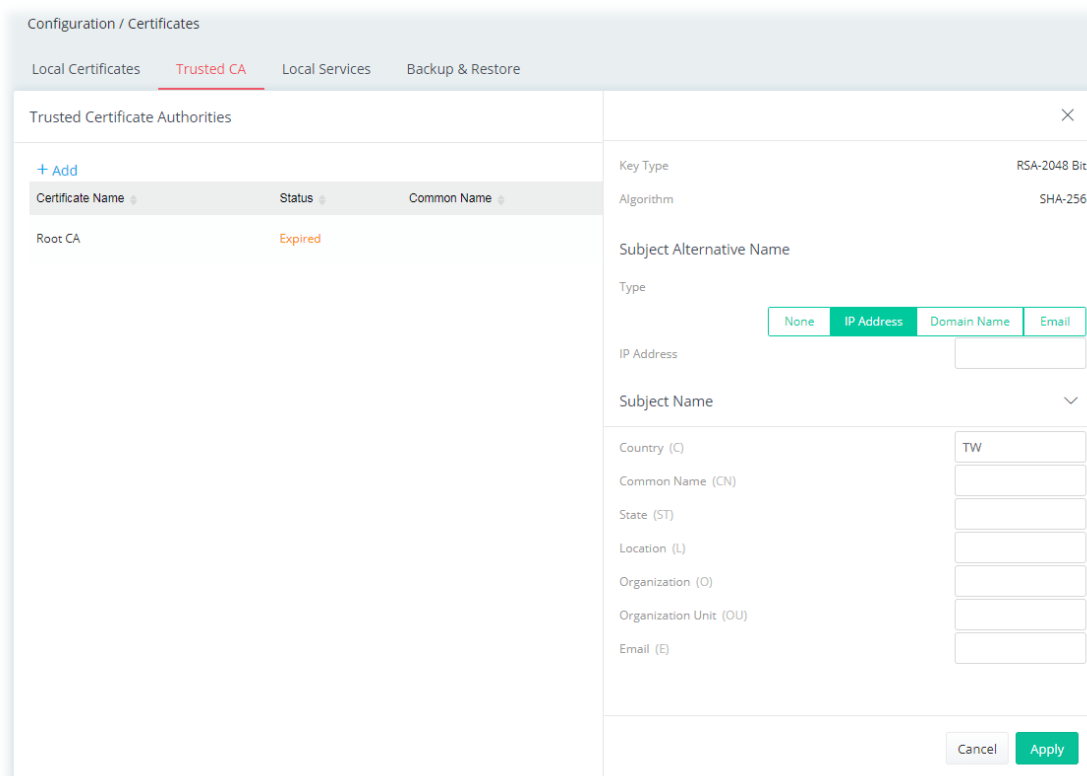

Available settings are explained as follows:

Item	Description
Key Type	Displays the key type (set to RSA).
Algorithm	Displays the algorithm.
Subject Alternative Name	
Type	Select the type of Subject Alternative Name and enter its value.
Subject Name	
Country (C)	Enter the country name (code) in which your organization is located.
Common Name (CN)	Enter the fully-qualified domain name / WAN IP that will be used to reach your server.
State (ST)	Enter the state or province where your organization is located.
Location (L)	Enter the city where you're your organization is located.
Organization (O)	Enter the legal name of your organization.
Organization Unit (OU)	Enter the department within your organization that you wish to be associated with this certificate.
Email (E)	Enter the email address of the entry.
Cancel	Discard current settings and return to the previous page.
Apply	Click to submit generate request to the CA server.

After finishing this web page configuration, please click **Apply** to save the settings.

To upload a certificate, click the **+Add** link to get the following page.

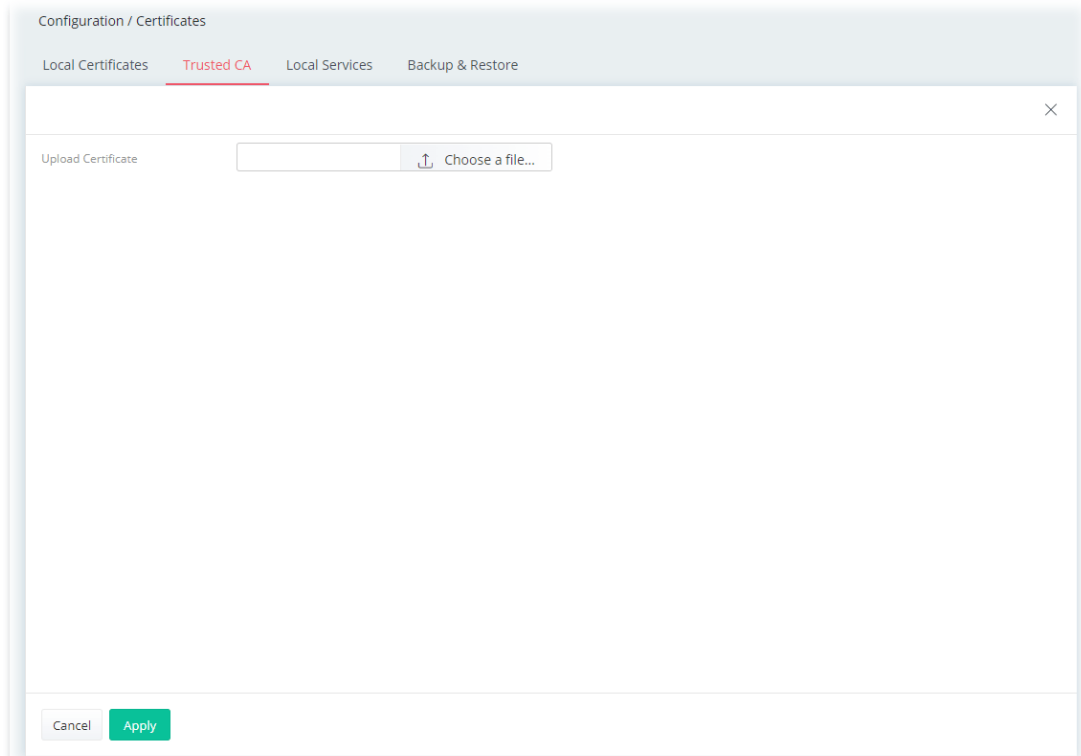

Available settings are explained as follows:

Item	Description
Upload Certificate	Choose a file - Select a local certificate file.
Cancel	Discard current settings and return to the previous page.
Apply	Click to import selected certificate file to the router.

After finishing this web page configuration, please click **Apply** to save the settings.

II-2-8-3 Local Services

This page allows you to set different categories and services for the local certificate(s) to prevent security warning messages popped up due to using different browsers.

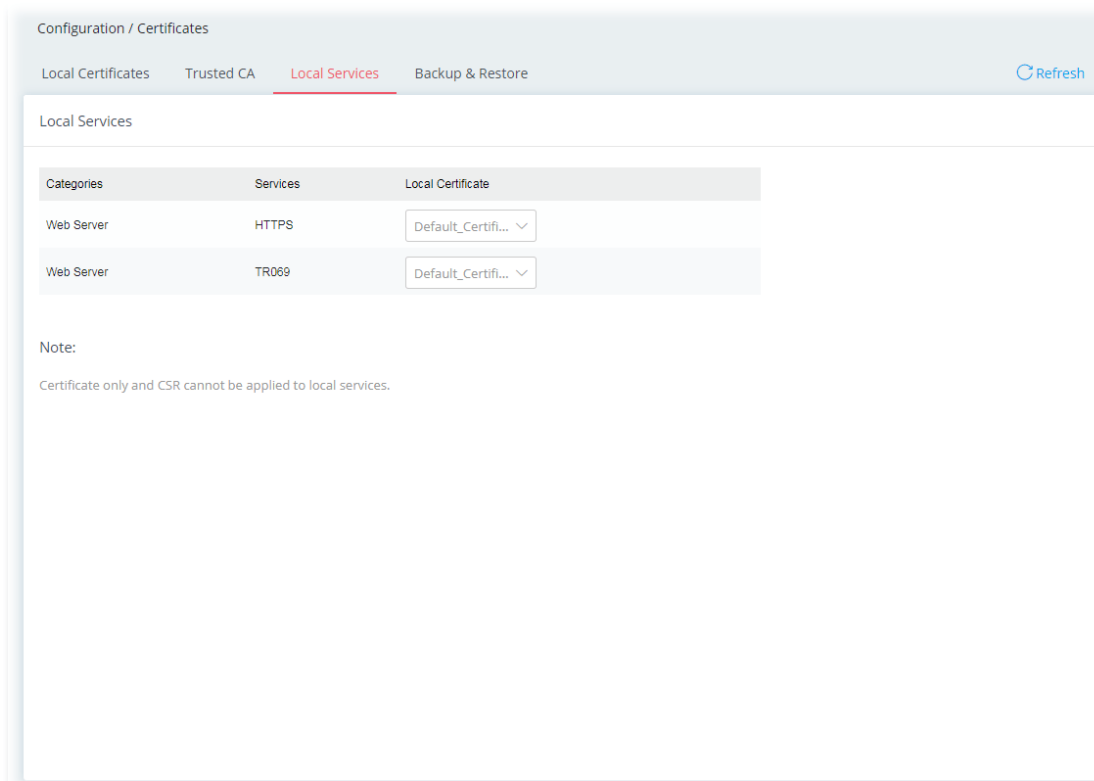

Categories	Services	Local Certificate
Web Server	HTTPS	Default_Certifi... ▾
Web Server	TR069	Default_Certifi... ▾

Note:
Certificate only and CSR cannot be applied to local services.

Available settings are explained as follows:

Item	Description
Local Certificate	Select a local certificate (has been imported to Vigor device) with full key and authentication information. Certificate without key phrase or CSR (certificate signing request) file cannot be selected as local certificate.
Cancel	Discard current settings and return to the previous page.
Apply	Save the current settings.

After finishing this web page configuration, please click **Apply** to save the settings.

II-2-8-4 Backup & Restore

You can back up or restore the Local and Trusted CA certificates on the router to a file.

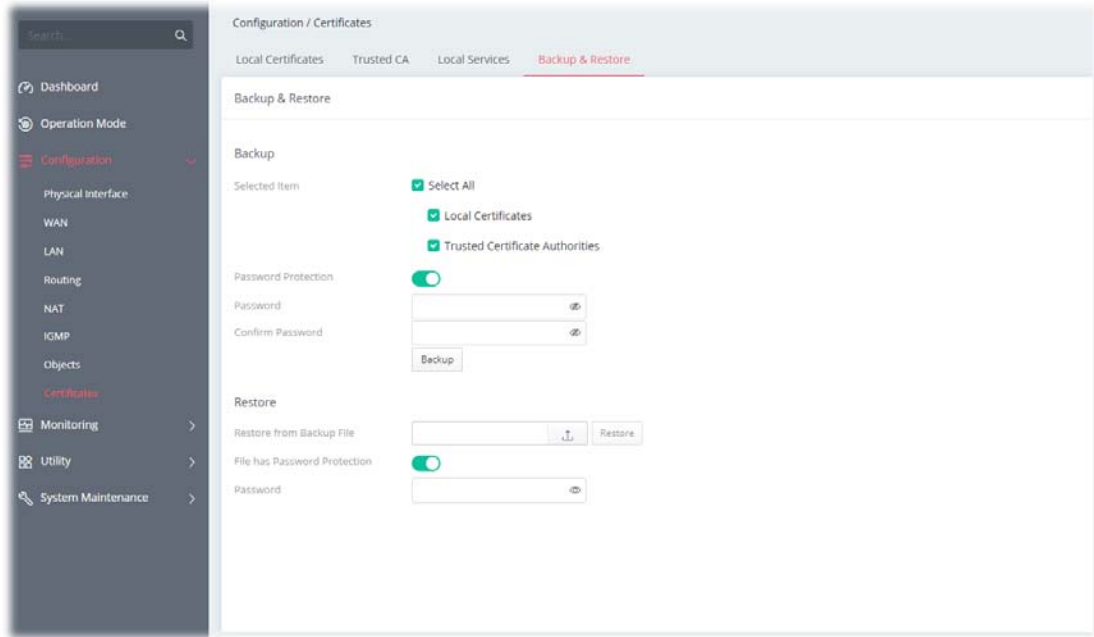

Available settings are explained as follows:

Item	Description
Backup	
Selected Item	Select the certification type (local, trusted or all certificate).
Password Protection	<p>Enabled - Switch the toggle to enable or disable the function.</p> <ul style="list-style-type: none"> Password - Enter the password with which you wish to encrypt the certificate. Confirm Password - Enter the password again. <p>Backup - Click to download the certificate.</p>
Restore	
Restore from Backup file	<p>Click to select the backup file you wish to restore.</p> <p>Restore - Click to retrieve the certificate.</p>
File has Password Protection	<p>Enabled - Switch the toggle to enable or disable the function.</p> <ul style="list-style-type: none"> Password - Enter the password that was used to encrypt the certificates.

This page is left blank.

Chapter III Management



III-1 System Maintenance

For the system setup, there are several items that you have to know the way of configuration: Device Settings, Management, Firmware, Backup & Restore, Accounts and Reboot System, and Firmware Upgrade.

III-1-1 Device Settings

The user can modify the time, device name, and Syslog for the device.

III-1-1-1 Time

Open **System Maintenance>>Device Settings** and click the **Time** tab.

It allows you to specify where the time of Vigor device should be inquired from.

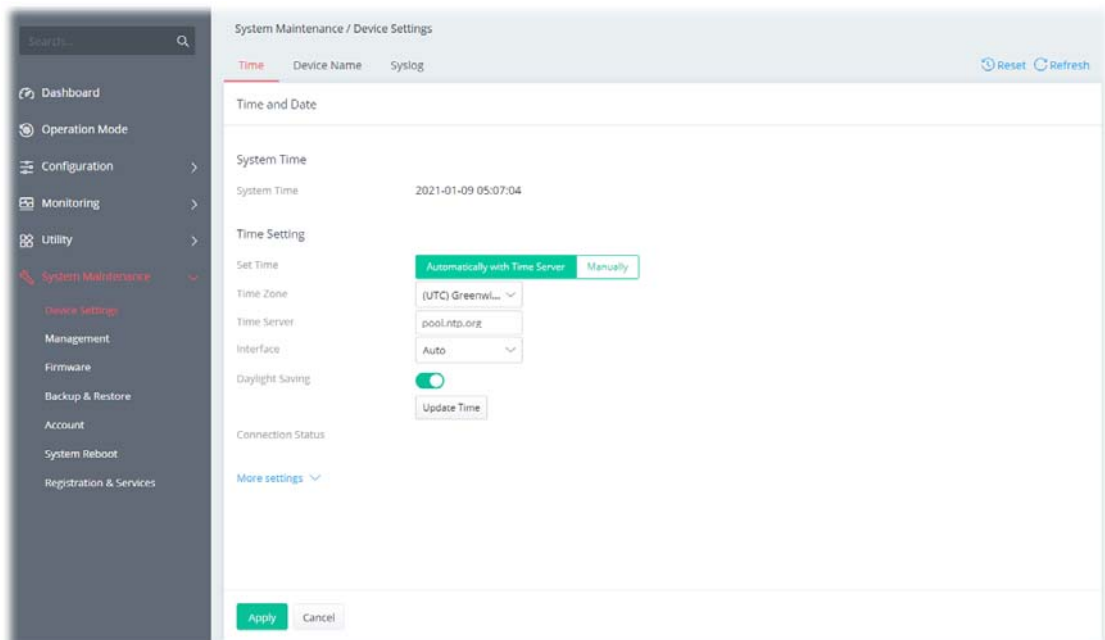

Available parameters are explained as follows:

Item	Description
System Time	
Current System Time	Display current time.
Time Setting	
Set Time	Determine the method (automatically or manually) to set the time. Automatically with Time Server - Set the system time by retrieving time information from the specified network time server using the Network Time Protocol (NTP). Manually - Set the system time using the time reported by the web browser.
When Automatically with Time Server is	Time Zone - Select the time zone where the router is located.

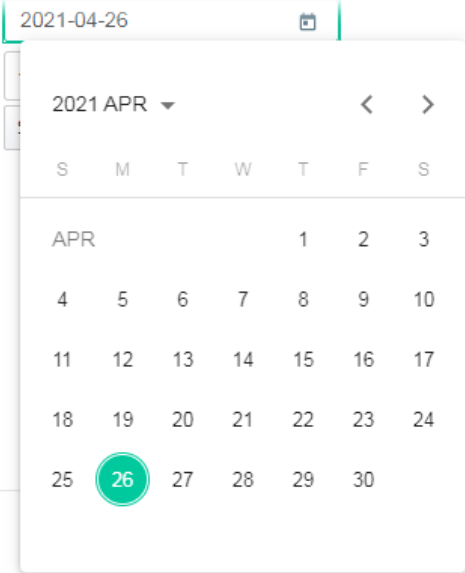
<p>selected as Set Time</p>	<p>Time Server - Enter the web site of the primary time server.</p> <p>Interface - Renew the time through the selected WAN/LAN interface. If Auto is selected, the Vigor system will renew the time through WAN or LAN.</p> <p>Daylight Saving - Enable Daylight Saving Time (DST) if it is applicable to your location.</p> <p>Update Time - Force to renew current time setting.</p> <p>Connection Status - Displays last update time status.</p> <p>More Settings - Click to open advanced settings for the time server.</p> <ul style="list-style-type: none"> ● Auto Update Interval - Select the time interval (30min or 60min) at which the router updates the system time periodically. ● Secondary Server - For having a backup time server, please enter the URL/IP address in the field of Secondary Server. ● Secondary Interface - Renew the time through the selected WAN/LAN interface. If Auto is selected, the Vigor system will renew the time through WAN or LAN. This is an optional setting and is used as the interface for the backup time server. If the primary time server fails to renew the time setting, the Vigor system will use the secondary time server instead. ● Daylight Saving Period - It is available when Daylight Saving is enabled. Enter a custom schedule to enable the DST - Default, by Week and by Date.
<p>When Manually is selected as Set Time</p>	<p>Time Zone - Select the time zone where the router is located.</p> <p>Date - Use the drop-down calendar to specify correct date.</p>  <p>Time - Set the time by specifying hours, minutes, and seconds.</p> <p>Synchronize with Browse - Click Sync now to sync the time setting with the browser.</p>
<p>Apply</p>	<p>Save the current settings and renew the system time.</p>
<p>Cancel</p>	<p>Discard current settings and return to the previous page.</p>

After finishing this web page configuration, please click **Apply** to renew the system time.

III-1-1-2 Device Name

Display the router name. Change the name if you want.

Open **System Maintenance>>Device Settings** and click the **Device Name** tab.

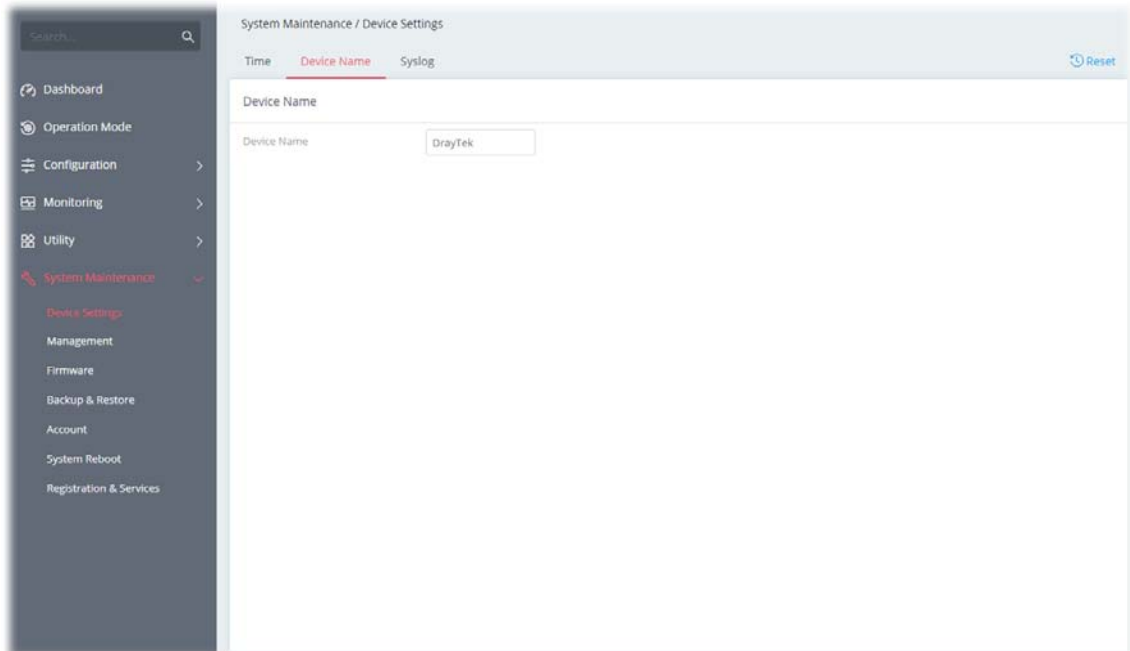

III-1-1-3 Syslog

SysLog function is provided for users to monitor the router.

Open **System Maintenance>>Device Settings** and click the **Syslog** tab.

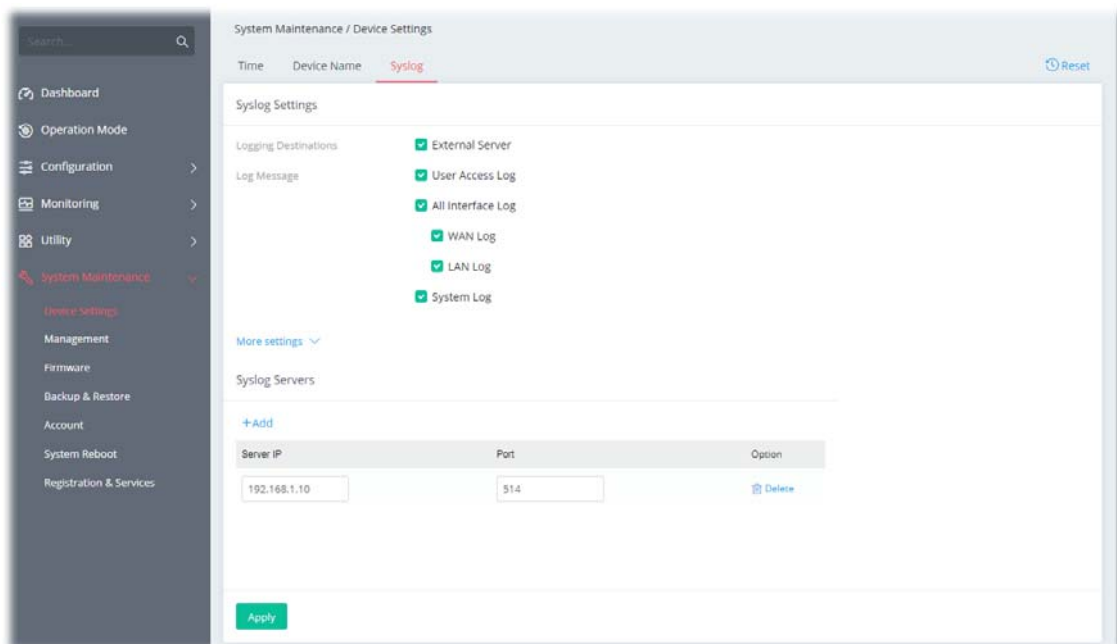

Available parameters are explained as follows:

Item	Description
Syslog Settings	

Logging Destinations	Select External Server to display Log Message and Syslog Servers for detailed configuration.
Log Message	Select to send the corresponding message of user access, interface, and system information to Syslog.
Syslog Servers	
+Add	Click to display new entry boxes for creating a new Syslog server profile. The maximum number of Syslog servers to be added is "3".
Server IP	Enter the IP address of the Syslog Server.
Port	Enter the port number of the Syslog Server.
Option	Delete - Click it to remove the selected server profile.
Apply	Save the current settings and exit the page.
Cancel	Discard current settings and return to the previous page.

After finishing this web page configuration, please click **Apply** to save the settings.

III-1-2 Management

III-1-2-1 Service Control

This page allows you to manage the general settings, management services, and TLS/SSL Encryption setup.

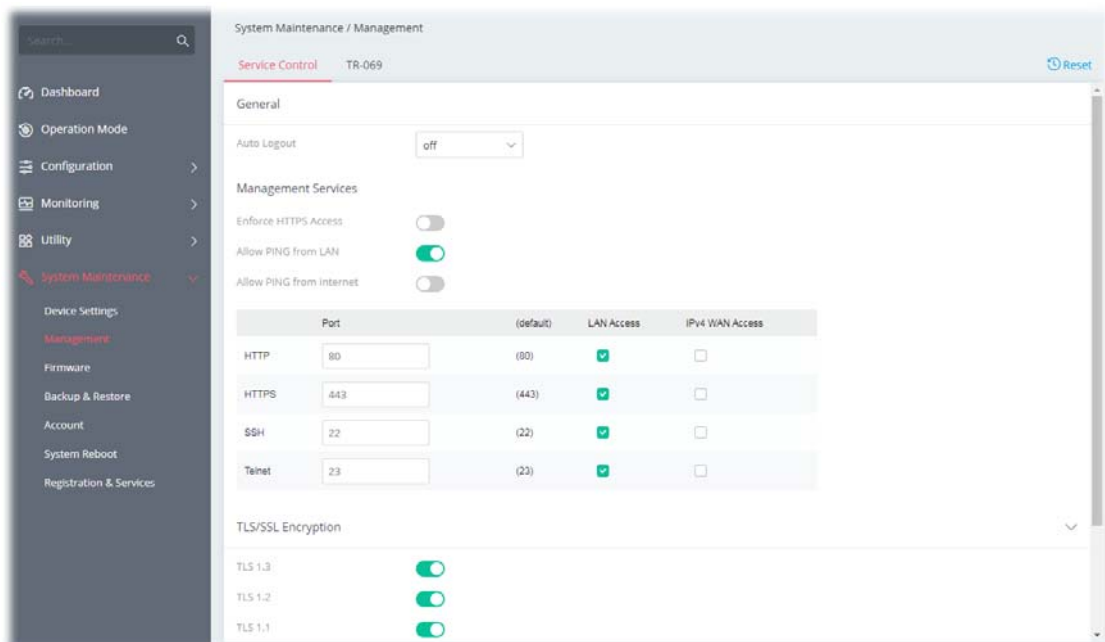

Available settings are explained as follows:

Item	Description
General	
Auto Logout	If "off" is selected, the function of auto-logout for the web user interface will be disabled. The web user interface will be open until you click the Logout icon

manually.

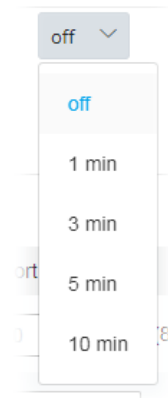

Management Services

Enforce HTTPS Access	Enable the checkbox to allow system administrators to login Vigor router via HTTPS.
Allow PING from LAN	Allow all PING packets from LAN.
Allow PING from Internet	Allow all PING packets from the Internet. For increased security, this setting is disabled by default.
Port	Specify user-defined port numbers for the HTTP, HTTPS,SSH and Telnet servers.
LAN Access	Select the checkbox to allow system administrators to login from LAN interface.
IPv4 WAN Access	Select the checkbox to allow system administrators to login from IPv4 WAN interface.

TLS/SSL Encryption

TLS 1.3/TLS 1.2/ TLS 1.1/TLS 1.0/SSL 3.0	<p>Switch the toggle to enable or disable the function.</p> <p>Enable SSL 3.0 and / or TLS 1.3/1.2/1.1/1.0 - Check the box to enable the function of SSL 3.0 and/or TLS 1.3/1.2/1.1/1.0 if required.</p> <p>Due to security consideration, the router's built-in HTTPS and SSL VPN server had upgraded to TLS1.x protocol. If you are using an old browser(eg. IE6.0) or an old SmartVPN Client, you may still need to enable SSL 3.0 to make sure you can connect, however, it's not recommended.</p>
---	---

i Note:

Switch these two icons by click the mouse cursor on them.



- means "Enable".



- means "Disable".

III-1-2-2 TR-069

Vigor device supports the TR-069 standard for remote management of customer-premises equipment (CPE) through an Auto Configuration Server, such as VigorACS.

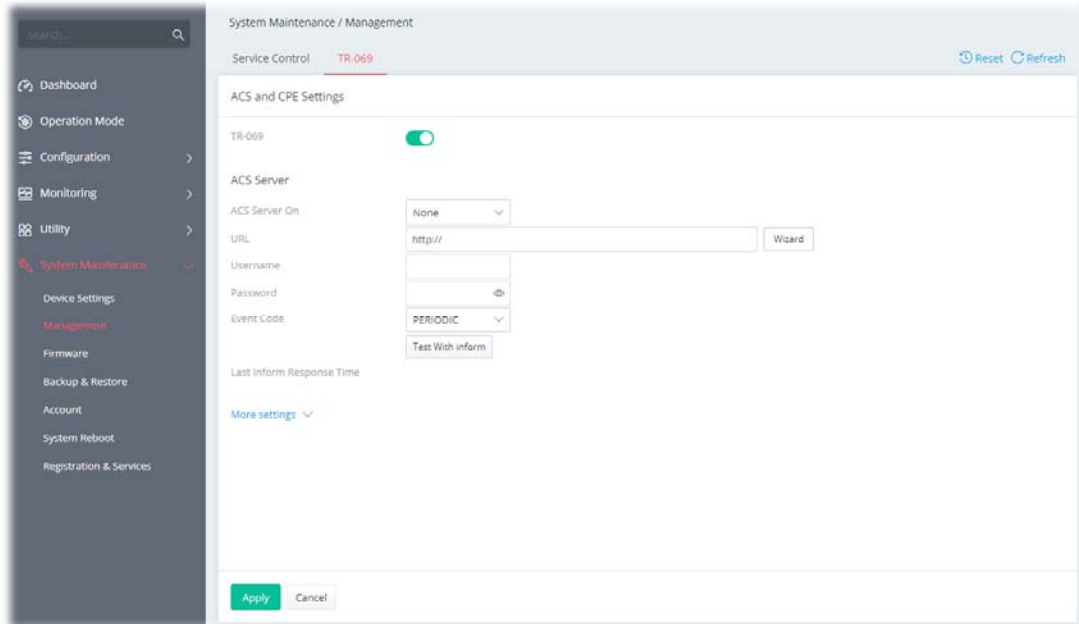

Available settings are explained as follows:

Item	Description
TR-069	Switch the toggle to enable or disable the function.
ACS Server	
ACS Server On	Choose the interface for connecting the router to the Auto Configuration Server.
URL	Enter the URL for connecting to the ACS. Wizard - Click it to enter the IP address of VigorACS server, port number and the handler.
Username/Password	Enter the credentials required to connect to the ACS server.
Event Code	Use the drop down menu to specify an event to perform the test. Test With Inform - Click it to send a message based on the event code selection to test if such CPE is able to communicate with VigorACS server.
Last Inform Response Time	Display the time that VigorACS server made a response while receiving Inform message from CPE last time.
More settings	
CPE Client	This section specifies the settings of the CPE Client. Protocol - Select Https if the connection is encrypted; otherwise select Http. Port - In the event of port conflicts, change the port number of the CPE. Username / Password - Enter the username and password that the VigorACS will use to connect to the CPE.
Periodic Inform	Enable / Disable - Switch the toggle to enable or disable the function.

Settings	<p>The default setting is Enable, which means the CPE Client will periodically connect to the ACS Server to update its connection parameters at intervals specified in the Interval Time field.</p> <p>Time Interval - Set interval time or schedule time for the router to send notification to CPE.</p>
STUN Settings	<p>Enable / Disable - Switch the toggle to enable or disable the function. The default is Disable. If select Enable, please enter the relational settings listed below:</p> <p>Server Address - Enter the IP address of the STUN server.</p> <p>Server STUN Port - Enter the port number of the STUN server.</p> <p>Minimum Keep Alive Period - If STUN is enabled, the CPE must send binding request to the server for the purpose of maintaining the binding in the Gateway. Please type a number as the minimum period. The default setting is "60 seconds".</p> <p>Maximum Keep Alive Period - If STUN is enabled, the CPE must send binding request to the server for the purpose of maintaining the binding in the Gateway. Please type a number as the maximum period. A value of "-1" indicates that no maximum period is specified.</p>
Apply	Save the current settings and exit the page.
Cancel	Discard current settings and return to the previous page.

After finishing this web page configuration, please click **Apply** to save the settings.

III-1-3 Firmware

Before firmware upgrade, please **download** the newest firmware from the DrayTeks website or FTP site **first**. The DrayTek website is www.draytek.com (or local DrayTeks website) and the FTP site is ftp.draytek.com.

Open **System Maintenance>>Firmware**. The following web page will guide you to upgrade firmware by using an example. Note that this example is running over Windows OS (Operating System).

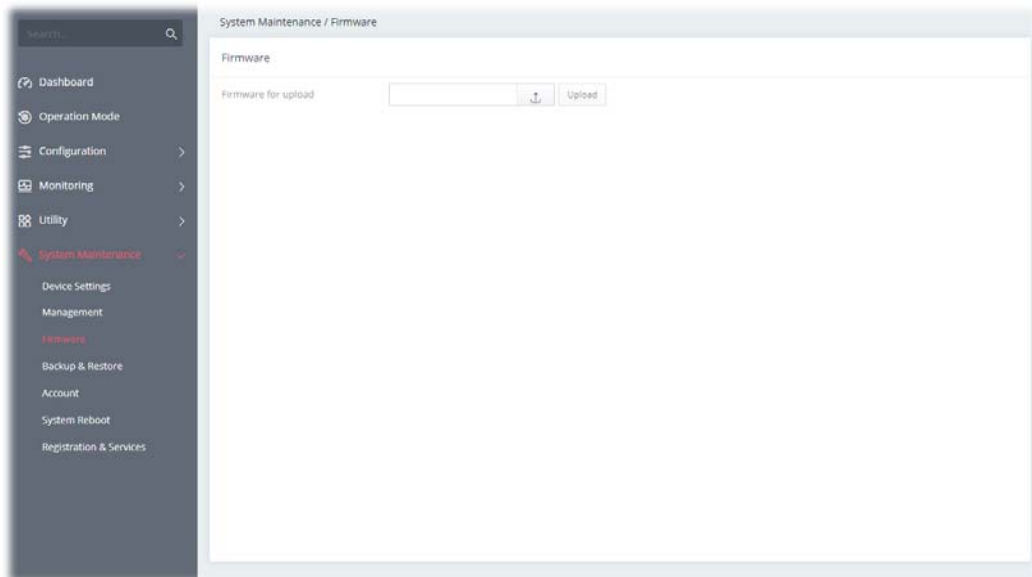

Then click **Upload** and wait for a few seconds.

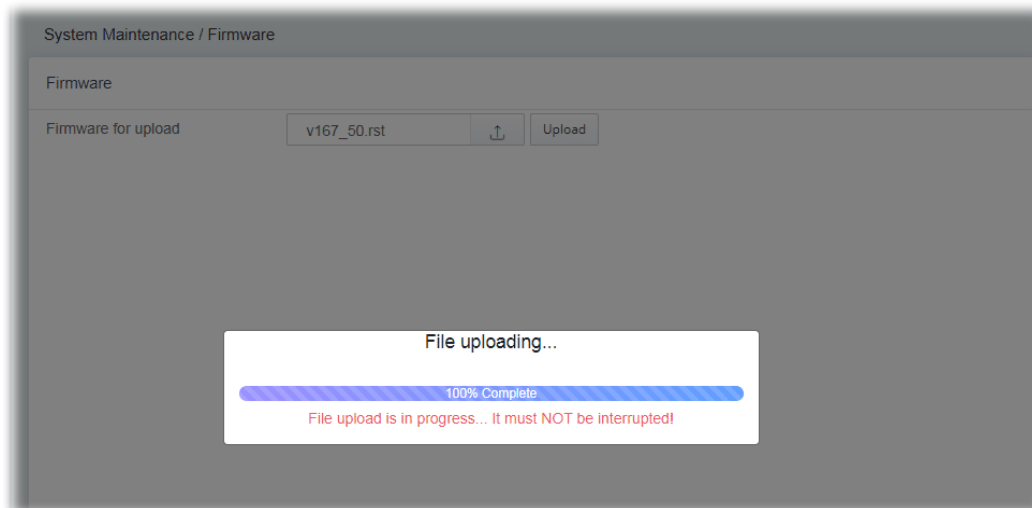

When the upload is finished, please click the **Restart** button.

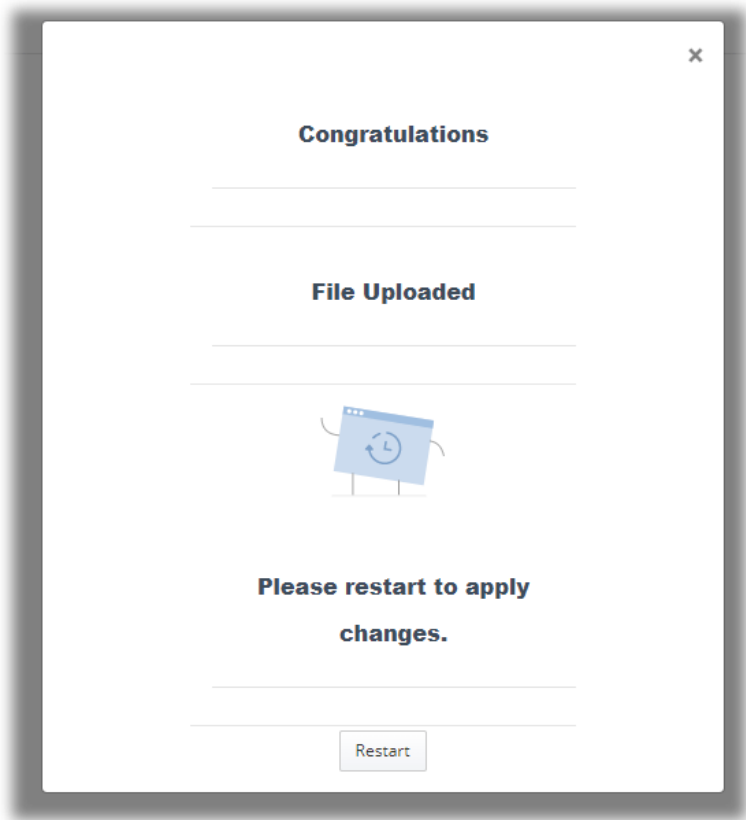

Wait for a while until the system finishes the rebooting.

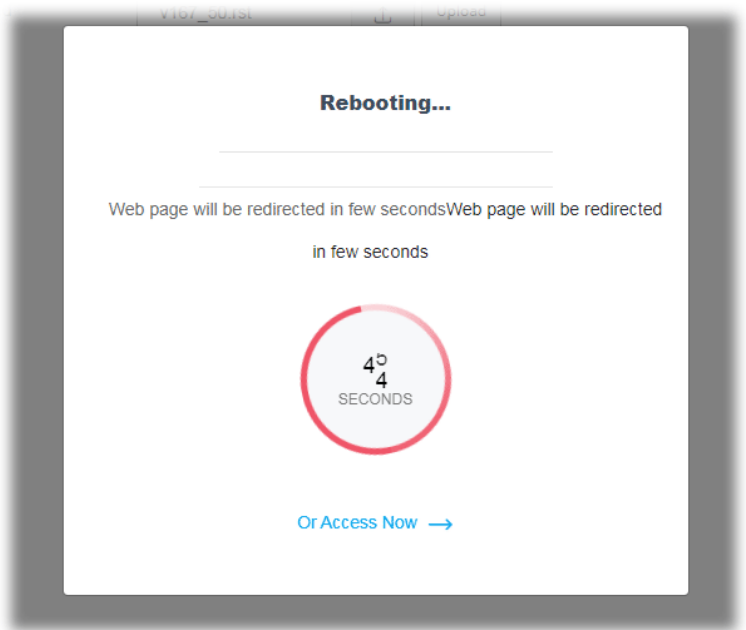

III-1-4 Backup and Restore

This function can be used to backup/restore the **Vigor167** settings.

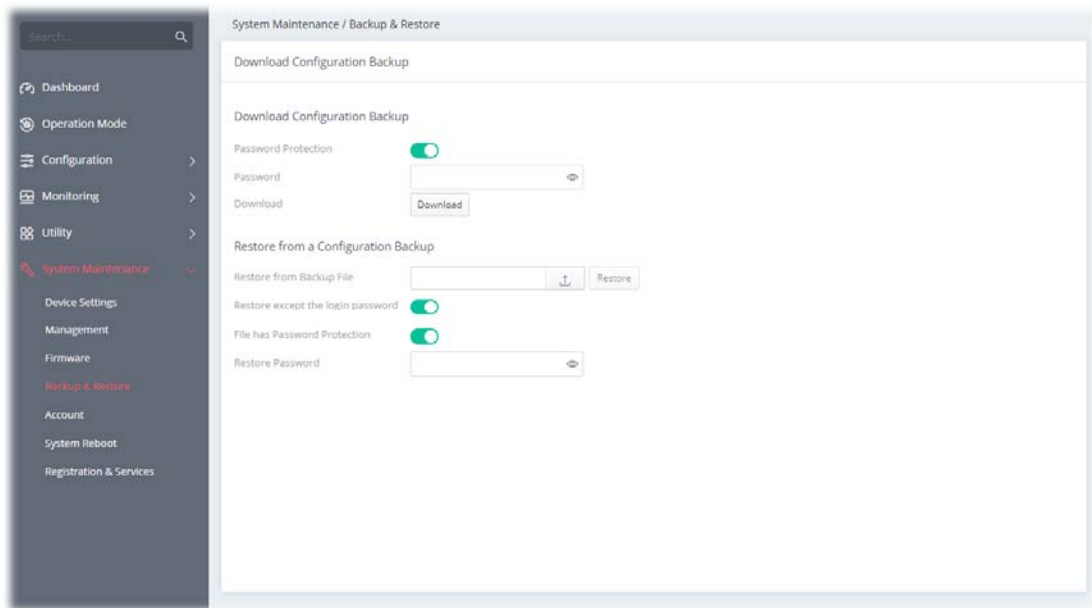



Available settings are explained as follows:

Item	Description
Download Configuration Backup	
Password Protection	For the sake of security, the configuration file for the access point can be encrypted. Switch the toggle to enable or disable the function.
Password	Enter several characters as the password for encrypting the configuration file.
Download	Click it to backup the configuration file.
Restore from a Configuration Backup	
Restore from Backup File	 - Click to locate the file for restoring. Restore - Click to execute the restoration.
Restore except the login password	Switch the toggle to enable or disable the function.
File has Password Protection	Switch the toggle to enable or disable the function. If enabled, a password will be required for restoring the configuration.
Restore Password	Enter a password for configuration restoration.

i Note:

Switch these two icons by click the mouse cursor on them.

 - means "Enable".

 - means "Disable".

III-1-5 Accounts

This page allows you to modify current administration account and password.

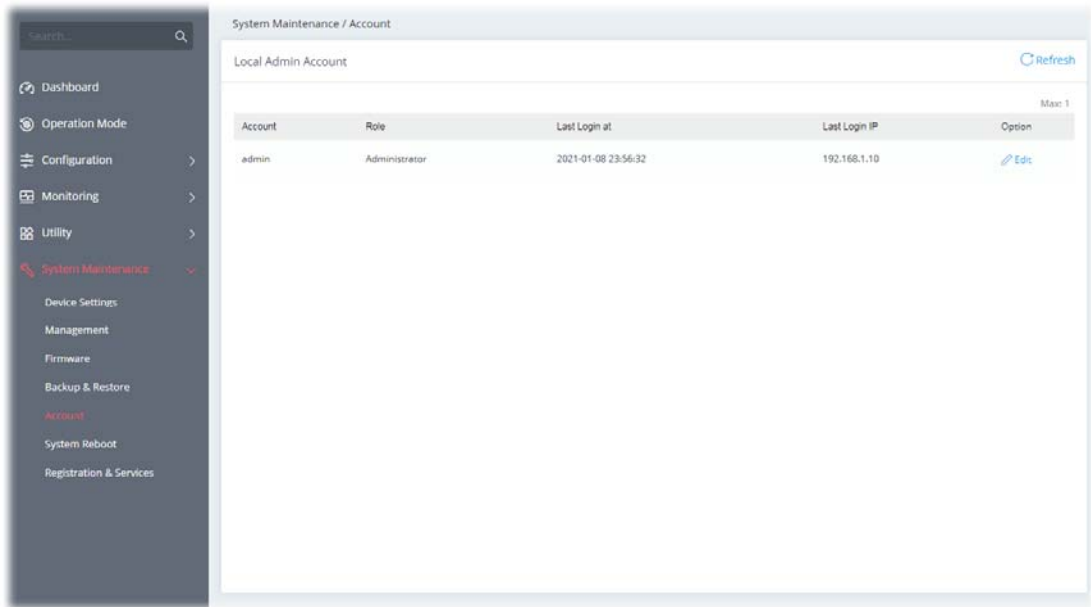

To change the administration account, click the **+Edit** link to get the following page.

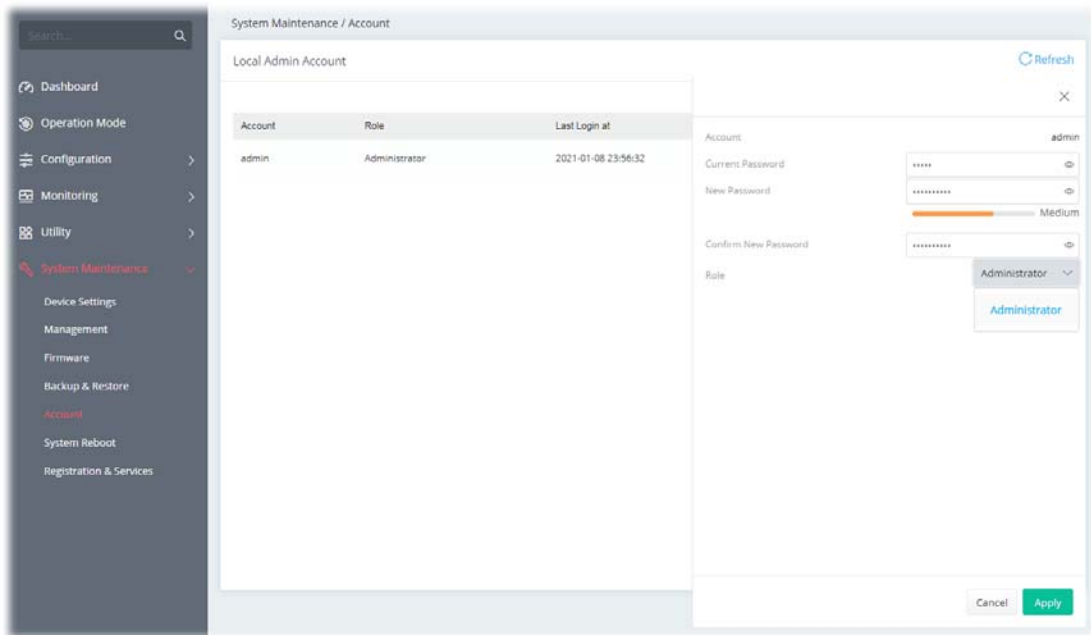

Available settings are explained as follows:

Item	Description
Local Admin Account	
Account	Display the name of the account.
Current Password	Enter the current password in this field.
New Password	Enter a new password in this field. The length of the password is limited to 31 characters.

Confirm New Password	Enter the new password again.
Role	Specify the role of the account. At present, only Administrator is available for selection.
Cancel	Discard current settings and return to the previous page.
Apply	Save the current settings and exit the page.

Click **Apply** to save the settings.

III-1-6 System Reboot

The Web user interface may be used to restart your router. Open **System Maintenance >> System Reboot** to get the following page.

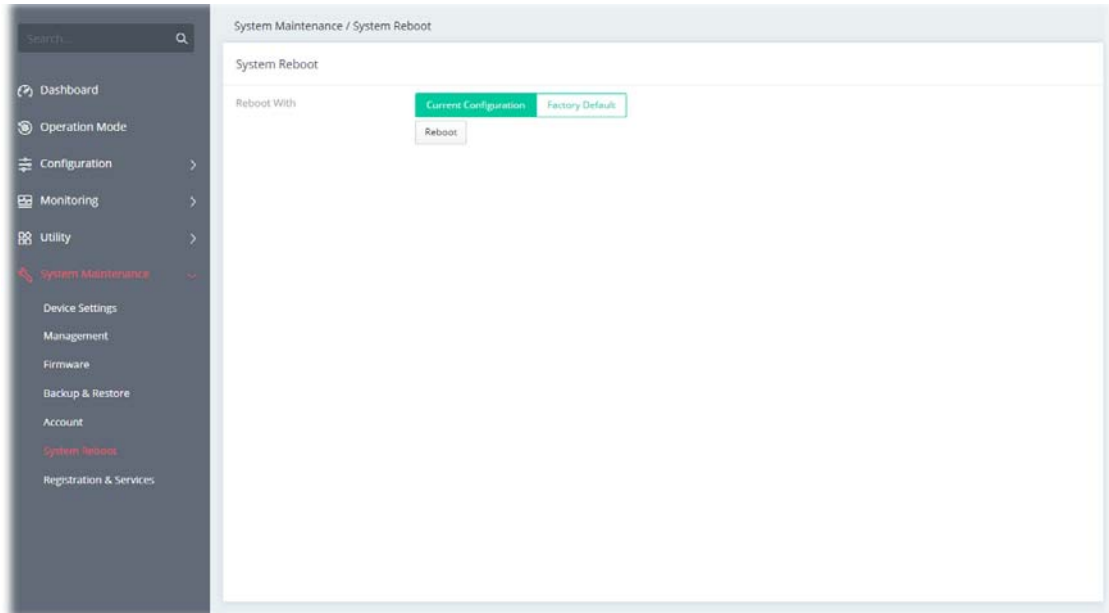

Available settings are explained as follows:

Item	Description
Reboot With	Select one of the following options, and press the Reboot button to reboot the router. Current Configuration – Select this option to reboot the router using the current configuration. Factory Default – Select this option to reset the router’s configuration to the factory defaults before rebooting.

III-1-7 Registration & Services

Register your Vigor router to MyVigor website for getting more services.

III-1-7-1 Registration & Services

1. Open **System Maintenance >> Registration & Service**.

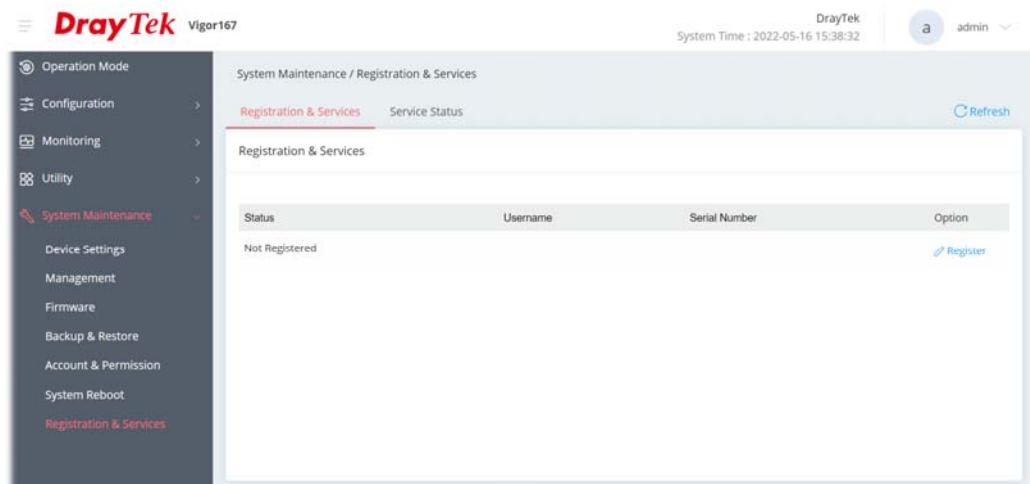

i Note:

Before registration, make sure the Vigor router has been set to access the Internet. Then, the link to **Register** will be shown under Option. If not, the link to **Login** will appear instead.

2. Click **Register**.

3. A **Login** page will be shown on the screen. Please enter the account and password that you created previously. And click **Login**.

The MyVigor website does not record any personal identifiable information with the exception of your IP Address which is recorded after login for security purposes.

ENGLISH

DrayTek
MyVigor

Username
carleni

Password

Login

Create Account / Get Help

Copyright©DrayTek Corp. Terms of Service / Privacy Policy

If you haven't an accessing account, please refer to section **Create Account** for MyVigor to create your own one. Please read the articles on the Agreement regarding user rights carefully while creating a user account.

4. The following page will be displayed after you logging in MyVigor. Type a nickname for the router, then click **Submit**.

DrayTek MyVigor

Product register (Add Device)

Device Name Vigor167

Model Vigor167

MAC 001DAA9A7D90

Serial Number 2021120616120001

Cancel Submit

- When the following page appears, your router has been registered to *myvigor* website successfully. However, the DrayDDNS service has not been activated yet.

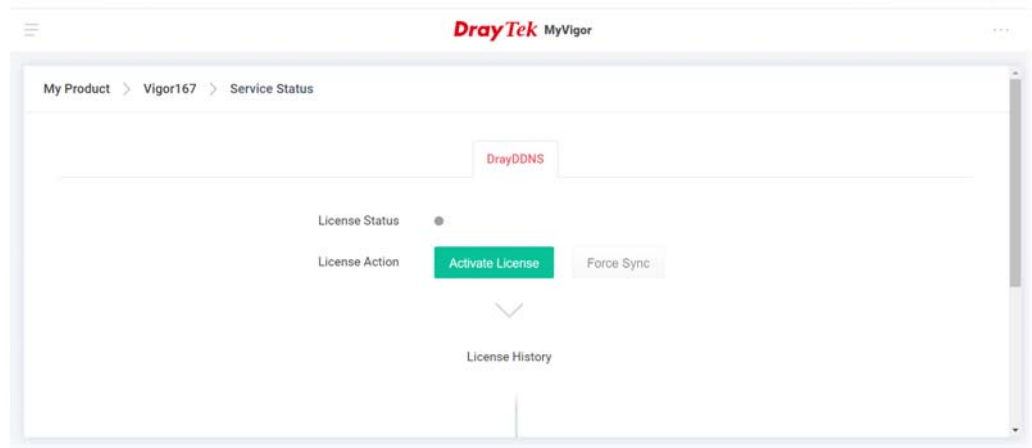

- Clicking **MY PRODUCT** for viewing the general information of the registered router on MyVigor website.

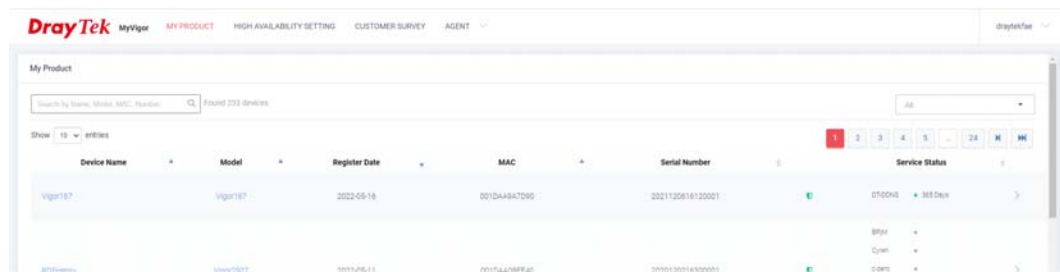

- Return to the **System Maintenance >> Registration & Service** page. Click the **Login** link under the Option to load the registration information.

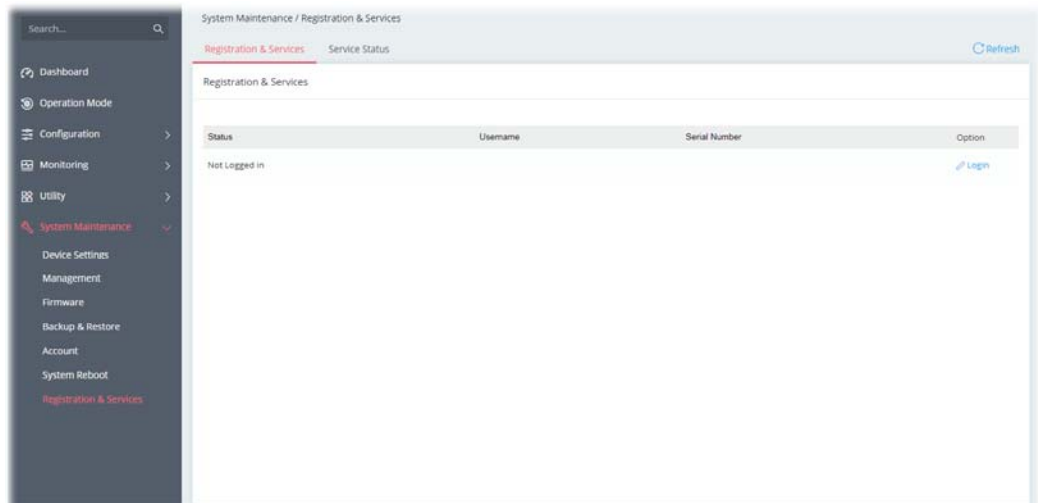

8. Now the registered information of Vigor167 has been shown on this page.

The screenshot displays the 'System Maintenance / Registration & Services' interface. On the left is a dark sidebar menu with the following items: Operation Mode, Configuration, Monitoring, Utility, System Maintenance (highlighted in red), Device Settings, Management, Firmware, Backup & Restore, Account & Permission, System Reboot, and Registration & Services (highlighted in red). The main content area has a light blue header with 'System Maintenance / Registration & Services' and a 'Refresh' button. Below the header, there are two tabs: 'Registration & Services' (active) and 'Service Status'. The 'Registration & Services' section contains a table with the following data:

Status	Username	Serial Number	Option
Registered	draytekae	2021120616120001	Logout

III-1-7-2 Services Status

This page displays the current status (including the license name, the start date, and the expiration date) for the license service.

After registering the Vigor router, the type of license (at present, only DrayDDNS) available for this router will be shown on this page.

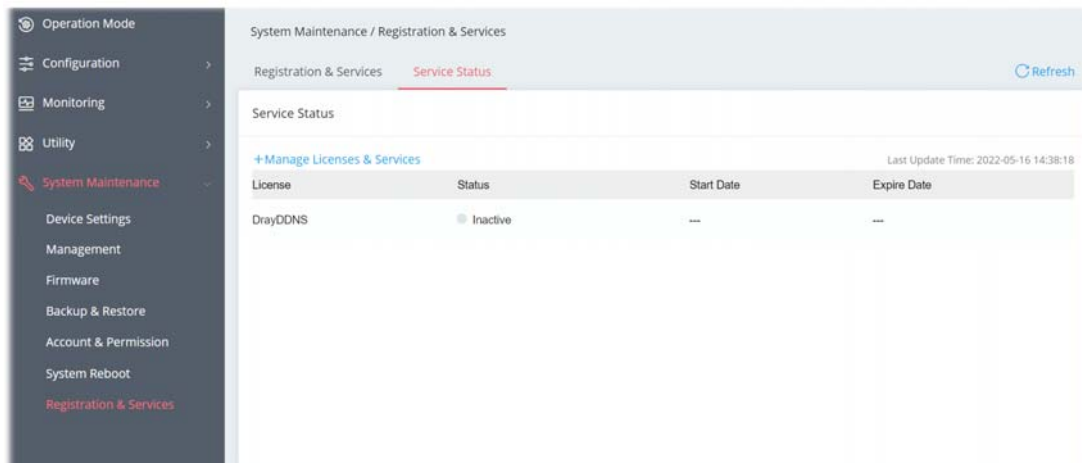

To activate the DrayDDNS service:

1. Open **Configuration>>WAN>>Dynamic DNS** to create a DrayDDNS server profile. For example, the name is defined as *mkvigor167* in this case.

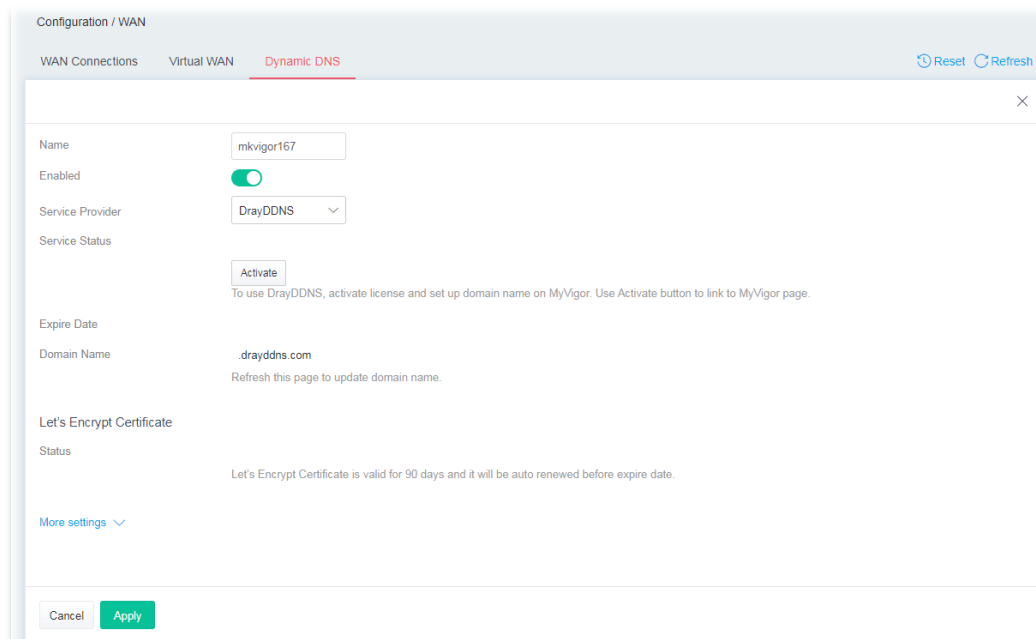

2. Open the page of **System Maintenance>>Registration & Services>>Service Status**.

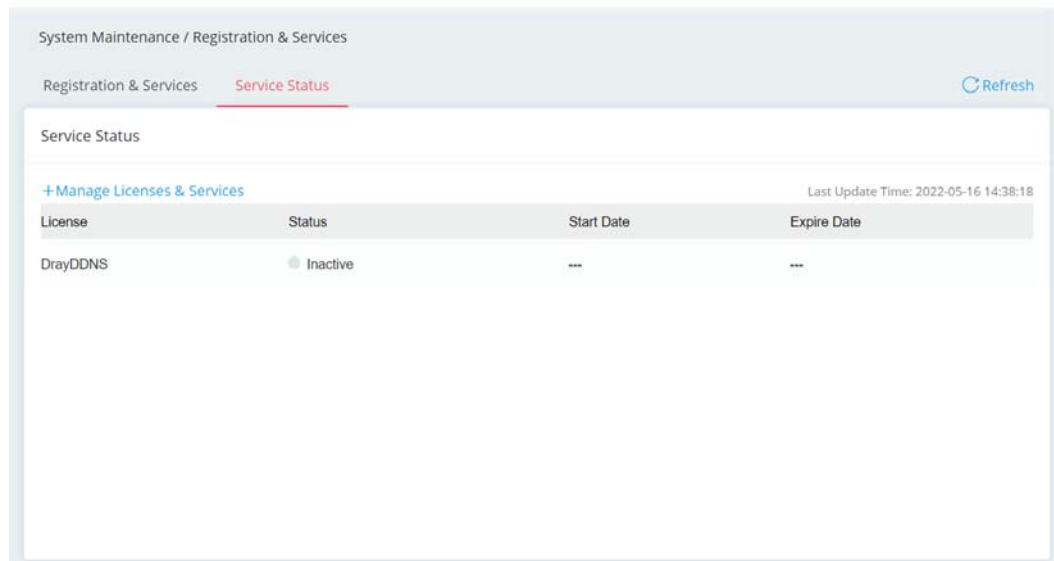

3. Click **+Manage Licenses & Services** to access MyVigor website.
4. Enter the account and password that you created previously. And click **Login**.
5. Open the **Service Status** page and click **Activate License**.

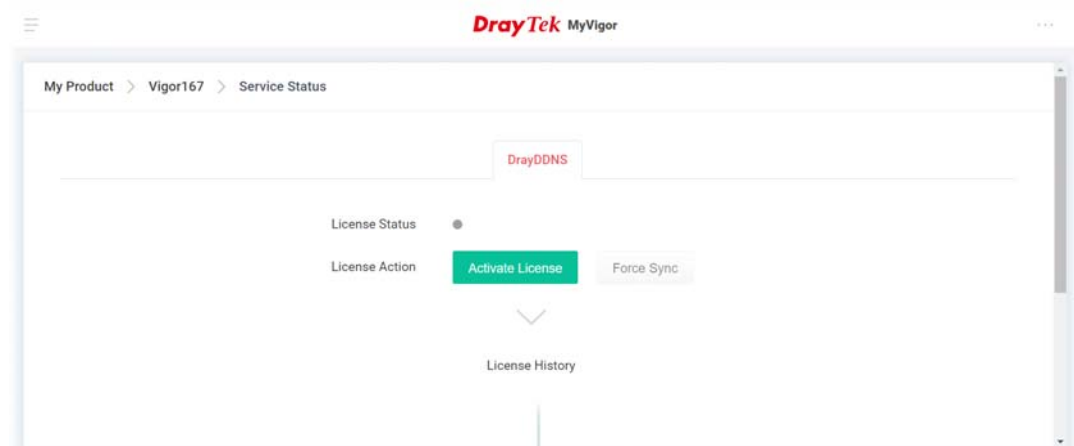

6. After the license has been activated, the following page will be shown on your screen.

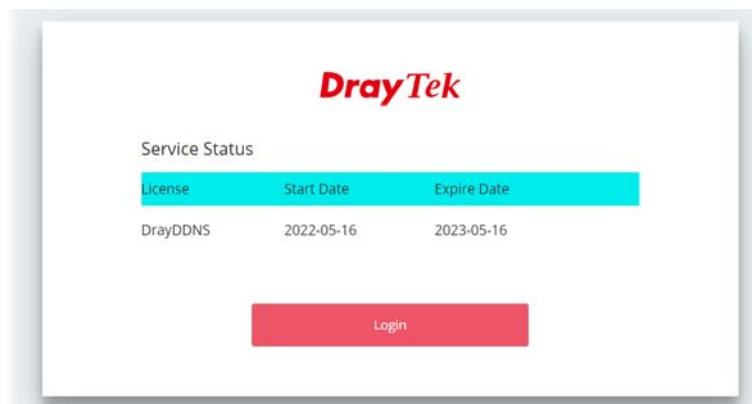

7. Click **Login**. Later, enter the DDNS domain name for DrayDDNS service.

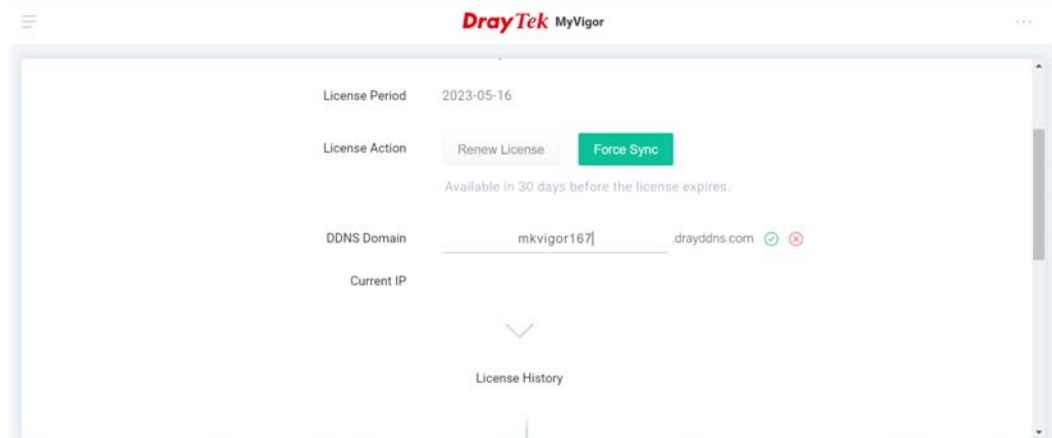

8. Return to the **System Maintenance >> Registration & Service>>Service Status** page. The activated license with start/expire date information will be shown on the screen.

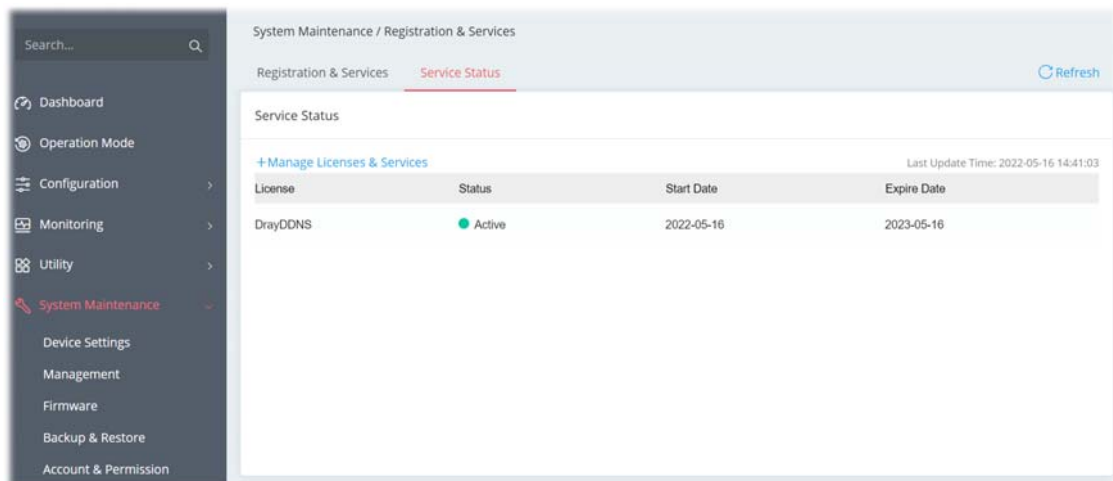

i Note:

If there is no license information, please go to **System Maintenance>>Registration & Services>>Registration & Service** and click **Login** (III-1-7-1 , step 7) to load the license information from MyVigor website.

Chapter IV Others

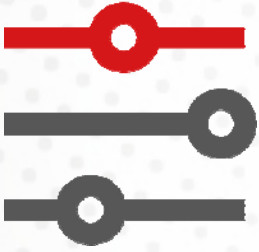

IV-1 Monitoring

IV-1-1 DSL Status

IV-1-1-1 DSL Information

The DSL information (packets) of this router can be broadcasted periodically. The information can be received by the routers under LAN.

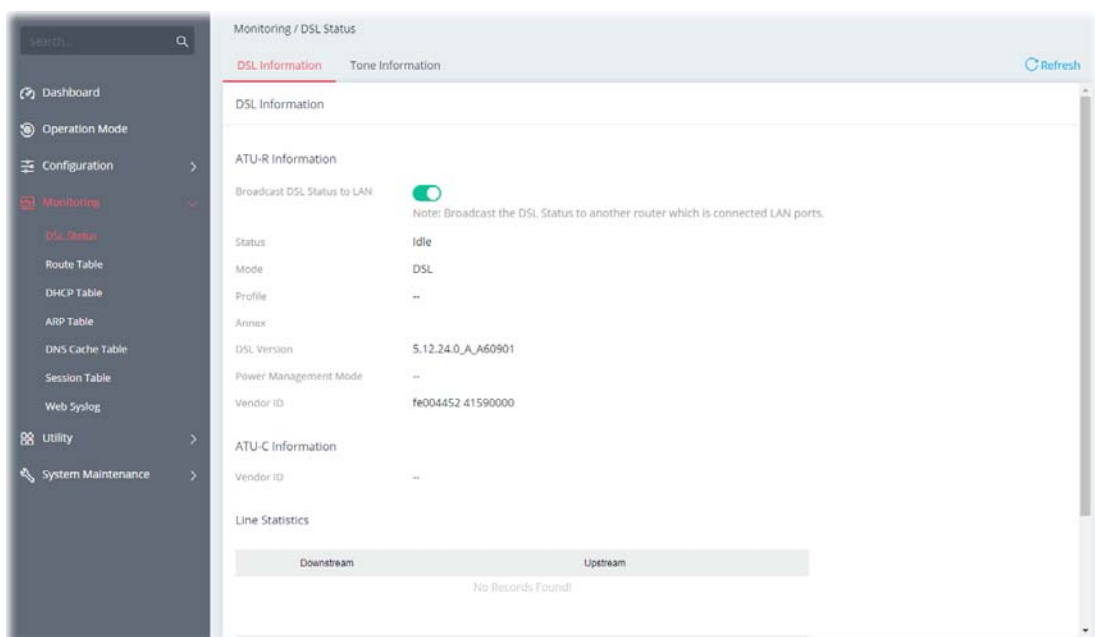

Available settings are explained as follows:

Item	Description
Broadcast DSL Status to LAN	Switch the toggle to enable or disable the function.

i Note:

Switch these two icons by click the mouse cursor on them.

 - means "Enable".

 - means "Disable".

IV-1-1-2 Tone Information

This web page displays the DSL line quality and bin usage.

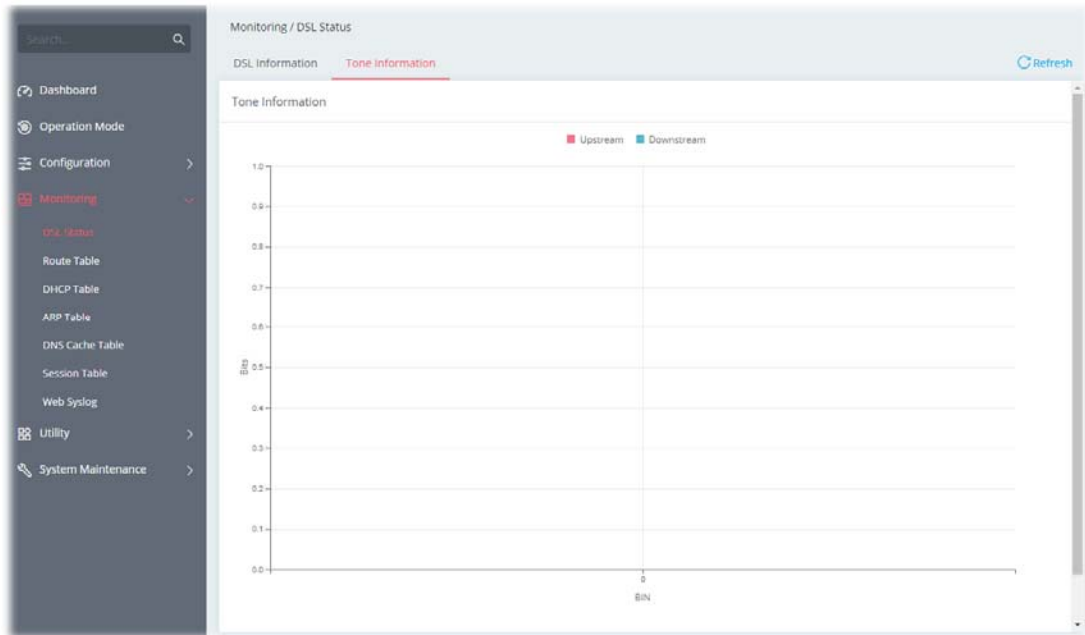

Click **Refresh** to reload this page with the most up-to-date information.

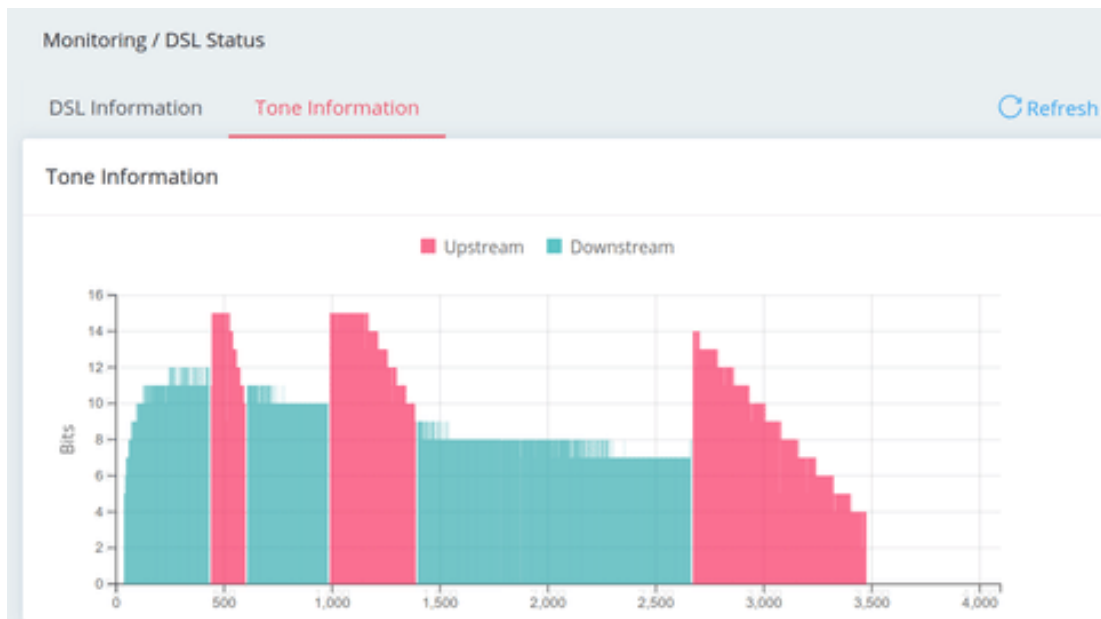

The above figure shows the bandwidth shared between Upstream (Red) and Downstream (Blue).

IV-1-2 Route Table

Click **Refresh** to reload this page with the most up-to-date information.

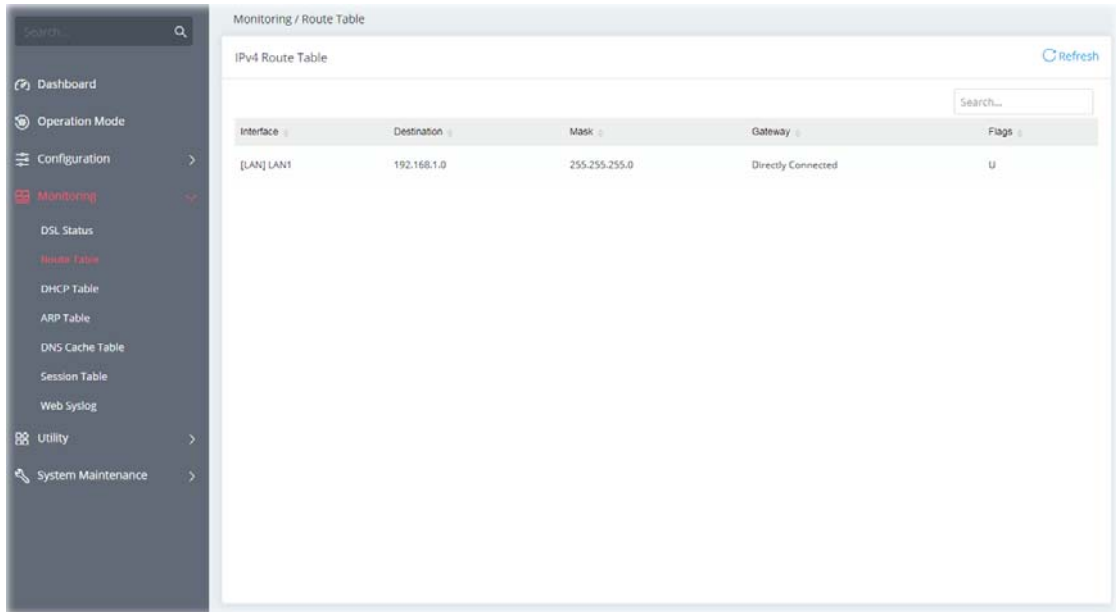

The screenshot shows the 'Monitoring / Route Table' interface. On the left is a navigation sidebar with categories: Dashboard, Operation Mode, Configuration, Monitoring (selected), DSL Status, Route Table, DHCP Table, ARP Table, DNS Cache Table, Session Table, Web Syslog, Utility, and System Maintenance. The main content area is titled 'IPv4 Route Table' and includes a search bar and a 'Refresh' button. Below is a table with the following data:

Interface	Destination	Mask	Gateway	Flags
[LAN] LAN1	192.168.1.0	255.255.255.0	Directly Connected	U

IV-1-3 DHCP Table

This page provides information on IP address assignments. This information is helpful in diagnosing network problems, such as IP address conflicts, etc.

Click **Refresh** to reload this page with the most up-to-date information.

IV-1-3-1 IPv4 DHCP Subnet

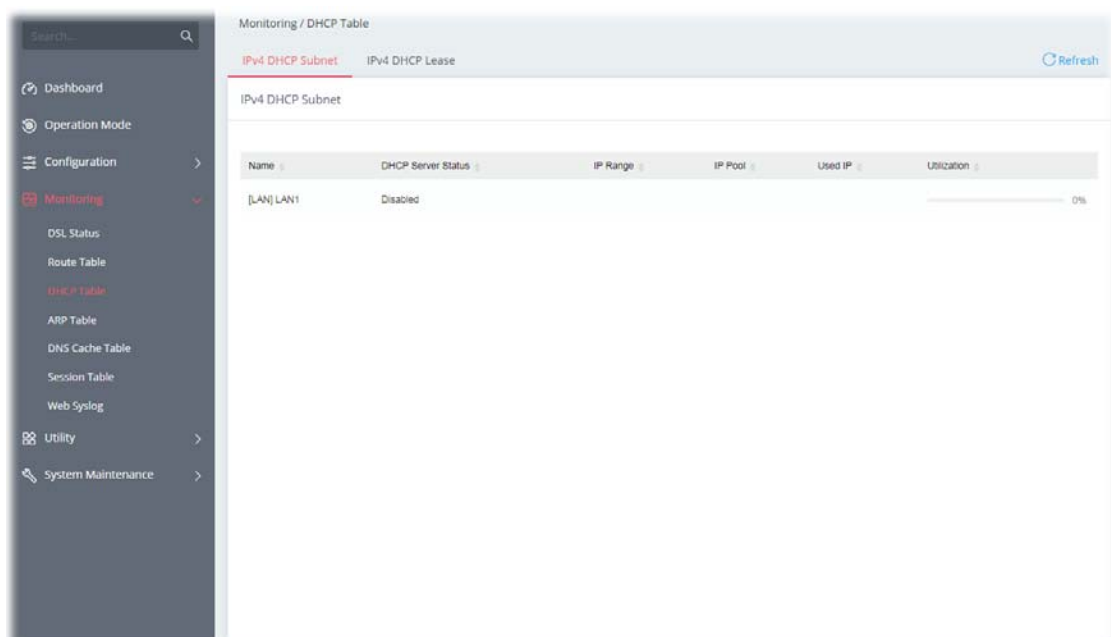

The screenshot shows the 'Monitoring / DHCP Table' interface. The left sidebar is identical to the previous screenshot. The main content area is titled 'IPv4 DHCP Subnet' and includes a search bar and a 'Refresh' button. Below is a table with the following data:

Name	DHCP Server Status	IP Range	IP Pool	Used IP	Utilization
[LAN] LAN1	Disabled				0%

IV-1-3-2 IPv4 DHCP Lease

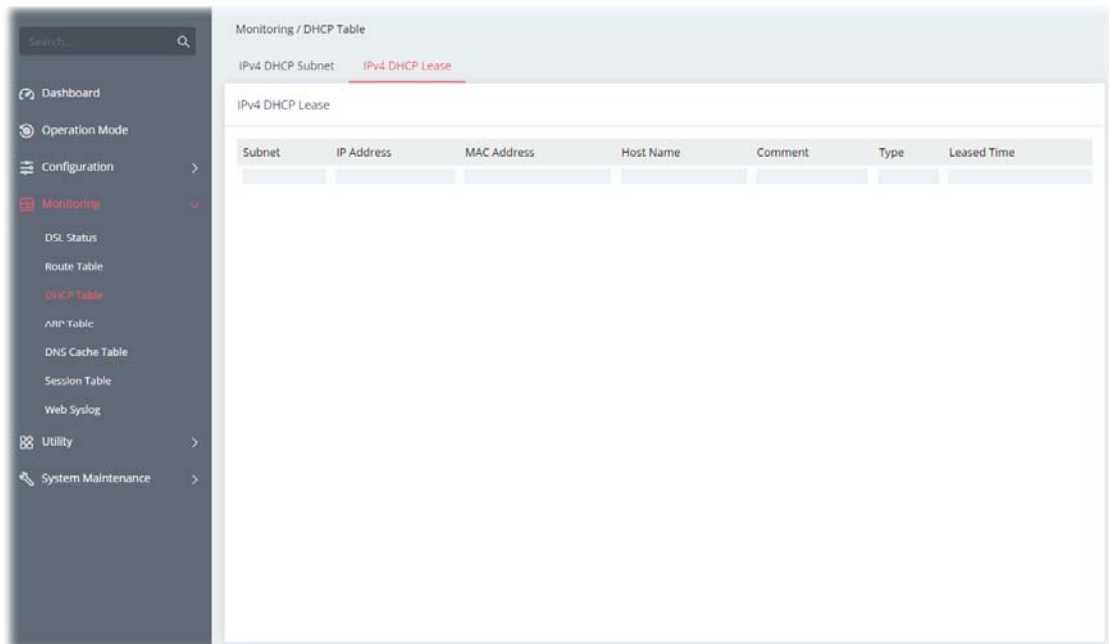

Monitoring / DHCP Table

IPv4 DHCP Subnet **IPv4 DHCP Lease**

IPv4 DHCP Lease

Subnet	IP Address	MAC Address	Host Name	Comment	Type	Leased Time
--------	------------	-------------	-----------	---------	------	-------------

IV-1-4 ARP Table

The table shows the contents of the ARP (Address Resolution Protocol) cache held in the router and shows the mappings between Ethernet hardware addresses (MAC Addresses) and IP addresses.

IV-1-4-1 LAN

Click **Refresh** to reload this page with the most up-to-date information.

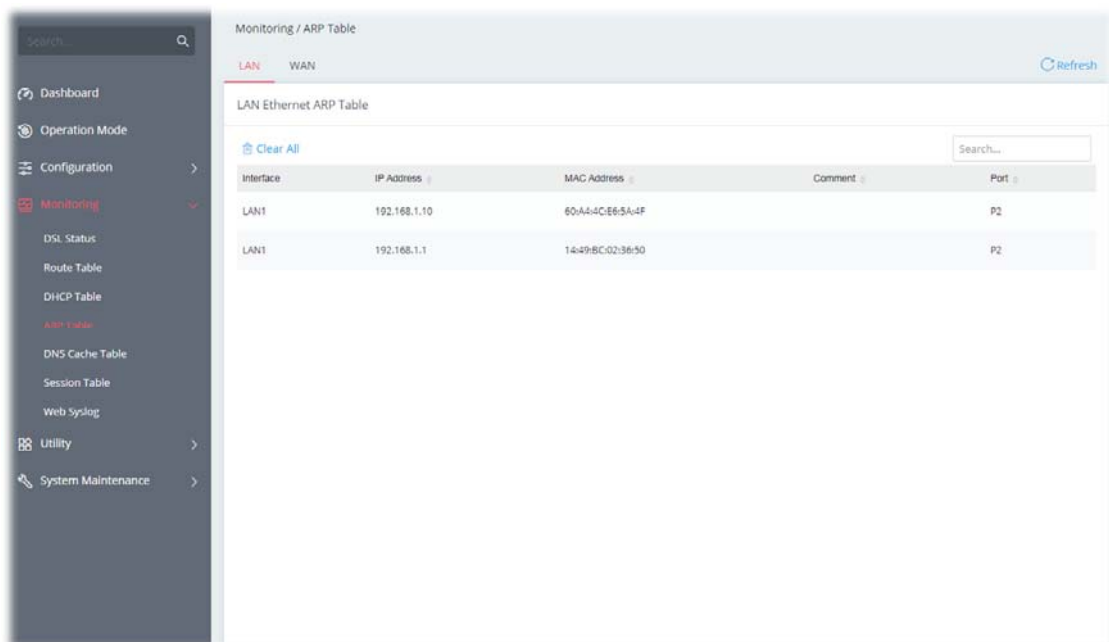

Monitoring / ARP Table

LAN WAN [Refresh](#)

LAN Ethernet ARP Table

[Clear All](#)

Interface	IP Address	MAC Address	Comment	Port
LAN1	192.168.1.10	60-AA-4C-E6-5A-4F		P2
LAN1	192.168.1.1	14-49-BC-02-36-50		P2

IV-1-4-2 WAN

Click **Refresh** to reload this page with the most up-to-date information.

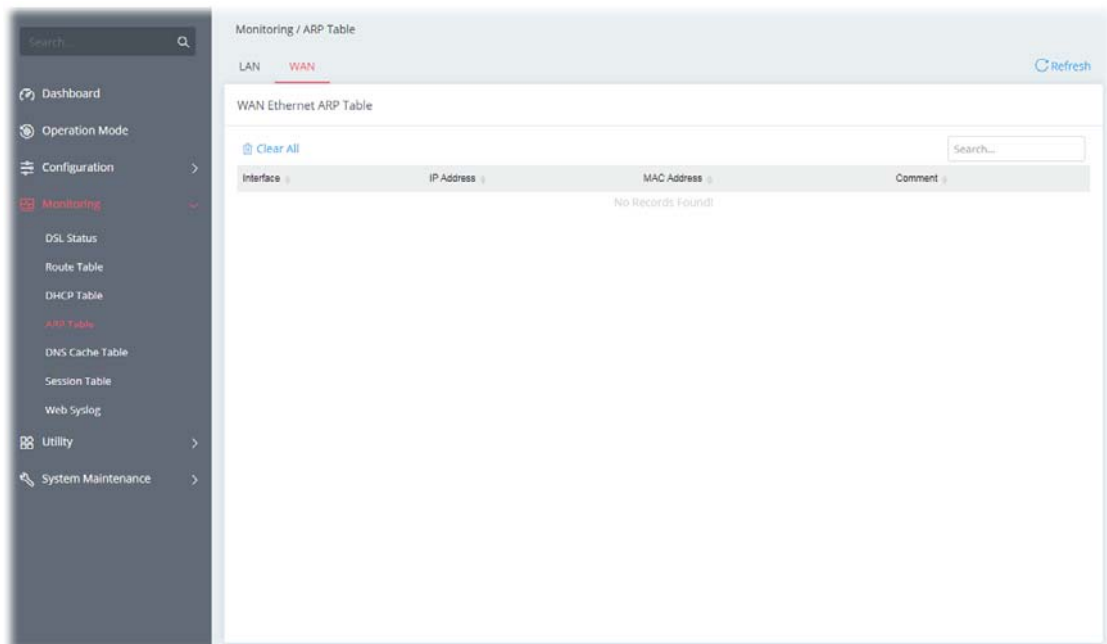

IV-1-5 DNS Cache Table

The router can function as a DNS server which allows LAN clients to look up DNS information by sending DNS requests to the router. Such DNS information is temporarily cached on the router and can be viewed on this page. Click **Refresh** to reload this page with the most up-to-date information.

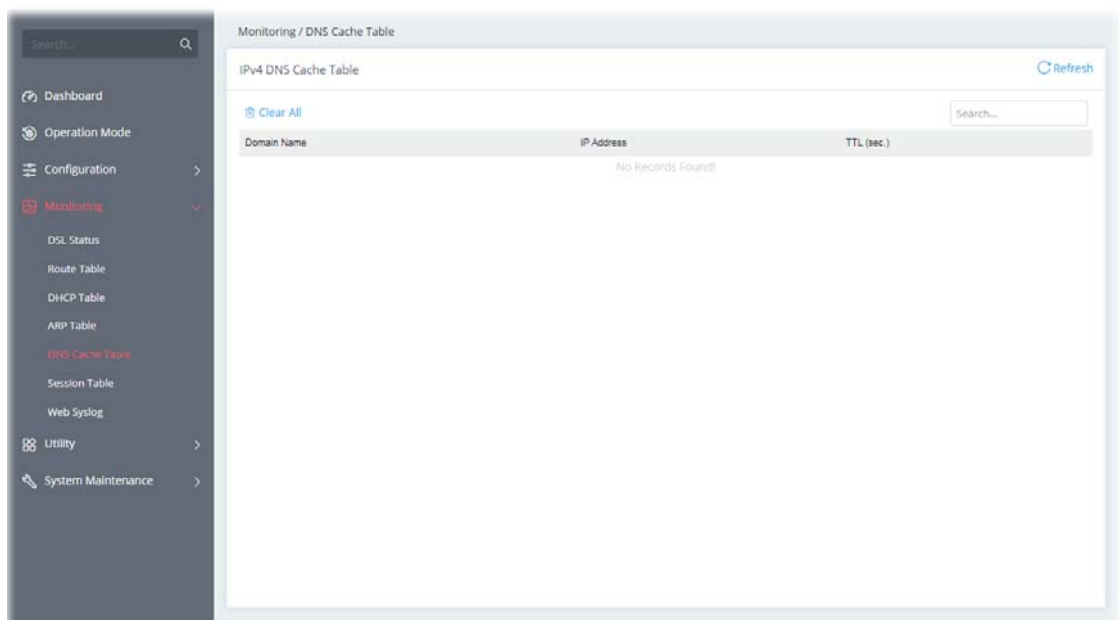

IV-1-6 Session Table

This screen shows the 200 newest entries in the NAT sessions table. Click **Refresh** to reload this page with the most up-to-date information.

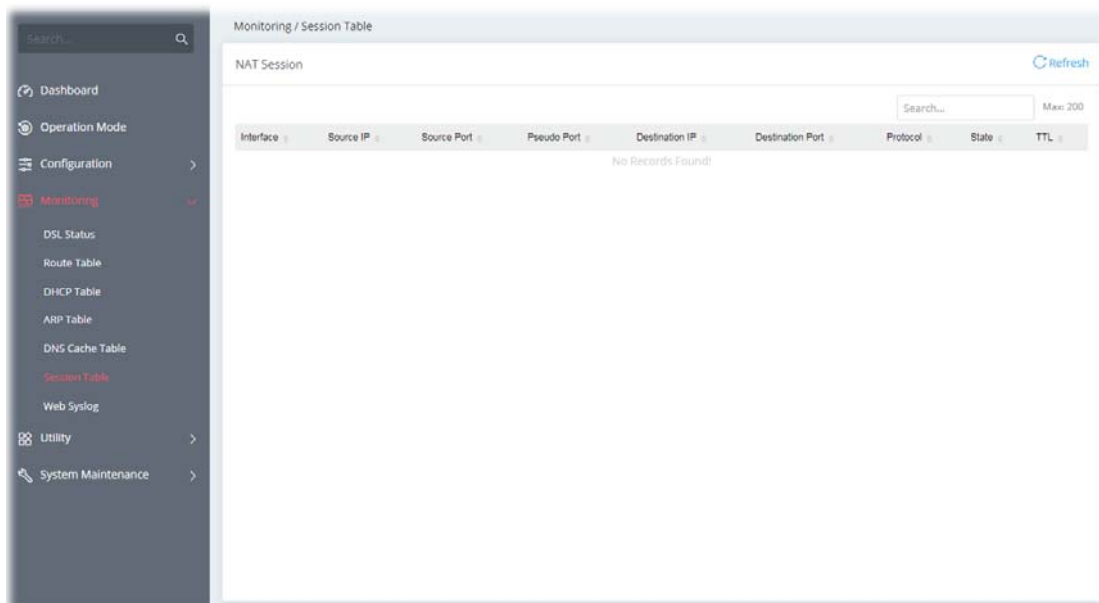

IV-1-7 Web Syslog

Log related to setting configuration and/or actions performed by this device can be stored on web Syslog.

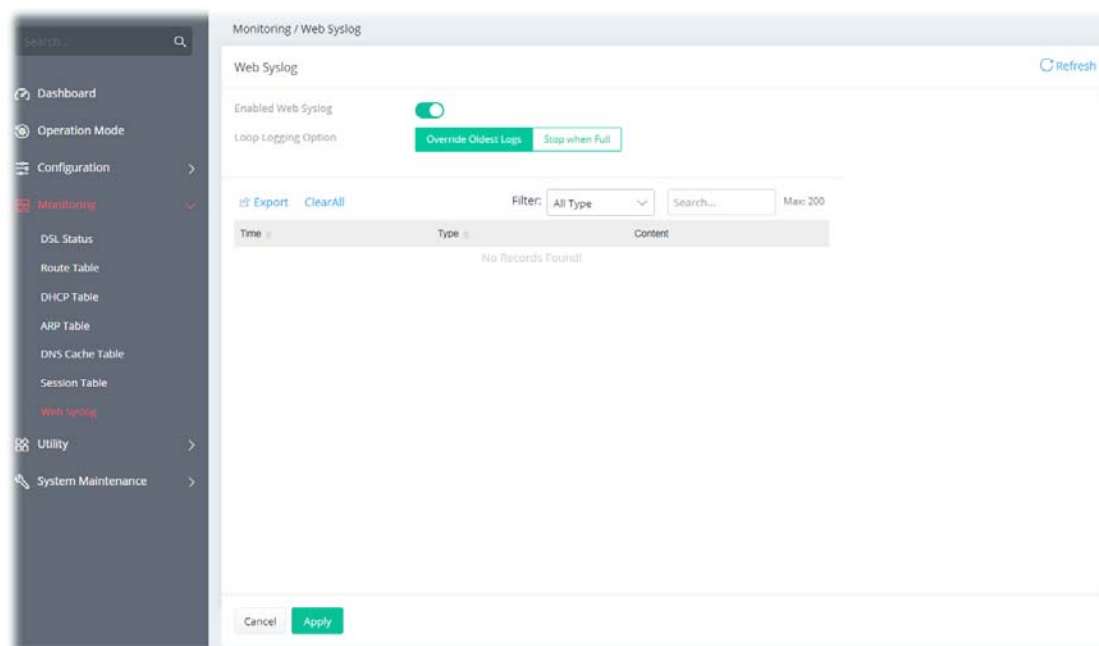

Available settings are explained as follows:

Item	Description
Enabled Web Syslog	Switch the toggle to enable or disable the function.
Loop Logging Option	<p>Override Oldest Logs - Vigor router system will backup all existed information on the USB disk onto the host and clean up the information from USB disk. Later, it will start a new record.</p> <p>Stop when Full - Vigor router system will stop to record the user information onto USB disk.</p>

Export	Click it to export the configuration as a file (.json).
Clear All	Click it to clear all settings on this page and return to the factory settings.
Filter	Select the type of log to display on this page.
Cancel	Discard current settings and return to the previous page.
Apply	Save the current settings and exit the page.

Click **Apply** to save the settings.

IV-2 Utility

IV-2-1 Ping Tool

The user can perform the ping job for specified IP (host) to diagnose if the data transmission via the Vigor system is well or not.

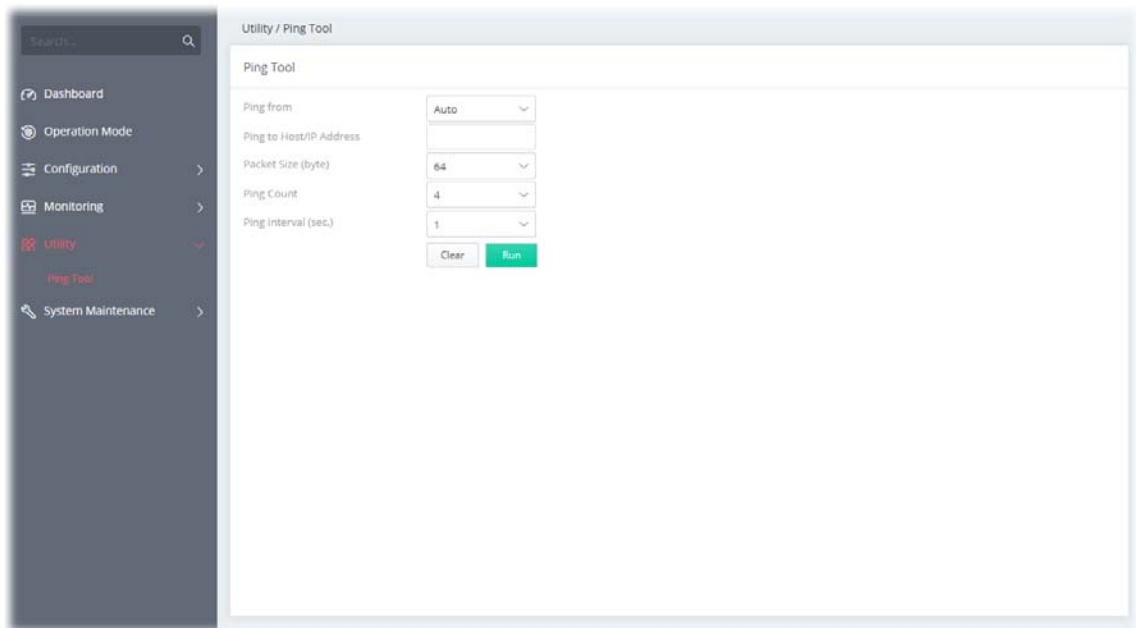

Available settings are explained as follows:

Item	Description
Ping from	Select an interface (LAN or WAN) from drop down list to through which you want to perform the ping operation, or choose Auto to be let the router select the WAN interface.
Ping to Host/IP Address	Enter the IP address of the Host/IP that you want to ping.
Packet Size (byte)	Determine the packet size for the ping job.
Ping Count	Determine the quantity of the packet being pinged.
Ping Interval (sec.)	Set a time interval (unit:second) for the system to ping the IP address specified above.
Clear	Remove the settings and return to the factory settings.
Run	Perform the ping job.

This page is left blank.

Chapter V Troubleshooting



V-1 Checking the Hardware Status

Follow the steps below to verify the hardware status.

1. Check the power line and cable connections.
Refer to "**I-2 Hardware Installation**" for details.
2. Power on the modem. Make sure the **POWER LED**, **ACT LED** and **LAN LED** are bright.
3. If not, it means that there is something wrong with the hardware status. Simply back to "**I-2 Hardware Installation**" to execute the hardware installation again. And then, try again.

V-2 Checking the Network Connection Settings

Sometimes the link failure occurs due to the wrong network connection settings. After trying the above section, if the link is still failed, please do the steps listed below to make sure the network connection settings is OK.

V-2-1 For Windows

Note:

The example is based on Windows 7 (Professional Edition). As to the examples for other operation systems, please refer to the similar steps or find support notes in www.draytek.com.

1. Open **All Programs>>Getting Started>>Control Panel**. Click **Network and Sharing Center**.



2. In the following window, click **Change adapter settings**.

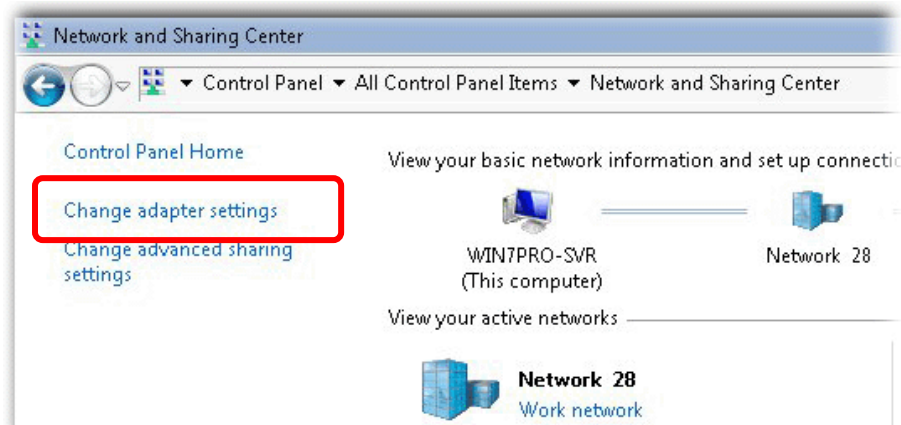

- Icons of the network connection will be shown on the window. Right-click on **Local Area Connection** and click on **Properties**.

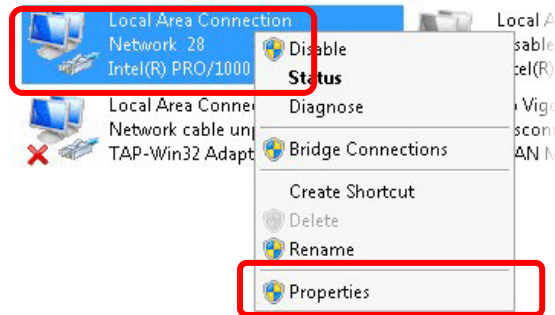

- Select **Internet Protocol Version 4 (TCP/IP)** and then click **Properties**.

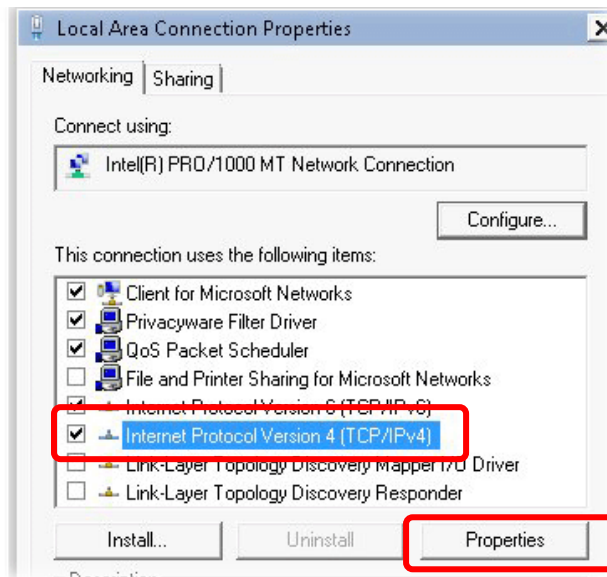

- Select **Obtain an IP address automatically** and **Obtain DNS server address automatically**. Finally, click **OK**.

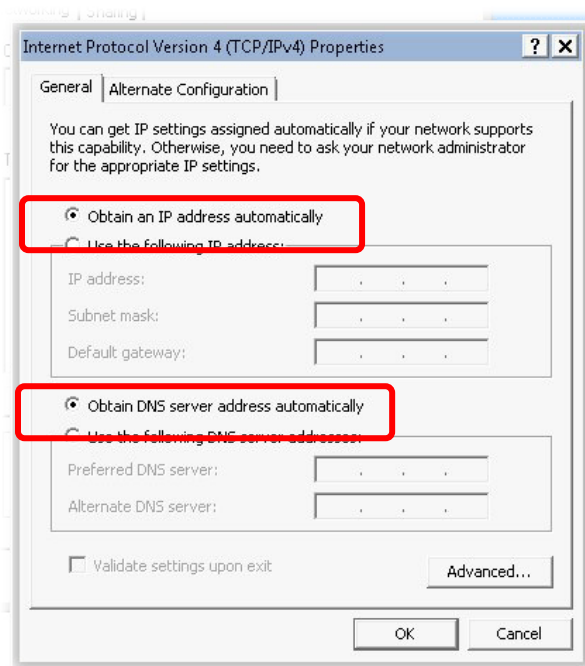

V-2-2 For Mac Os

1. Double click on the current used Mac Os on the desktop.
2. Open the **Application** folder and get into **Network**.
3. On the **Network** screen, select **Using DHCP** from the drop-down list of Configure IPv4.

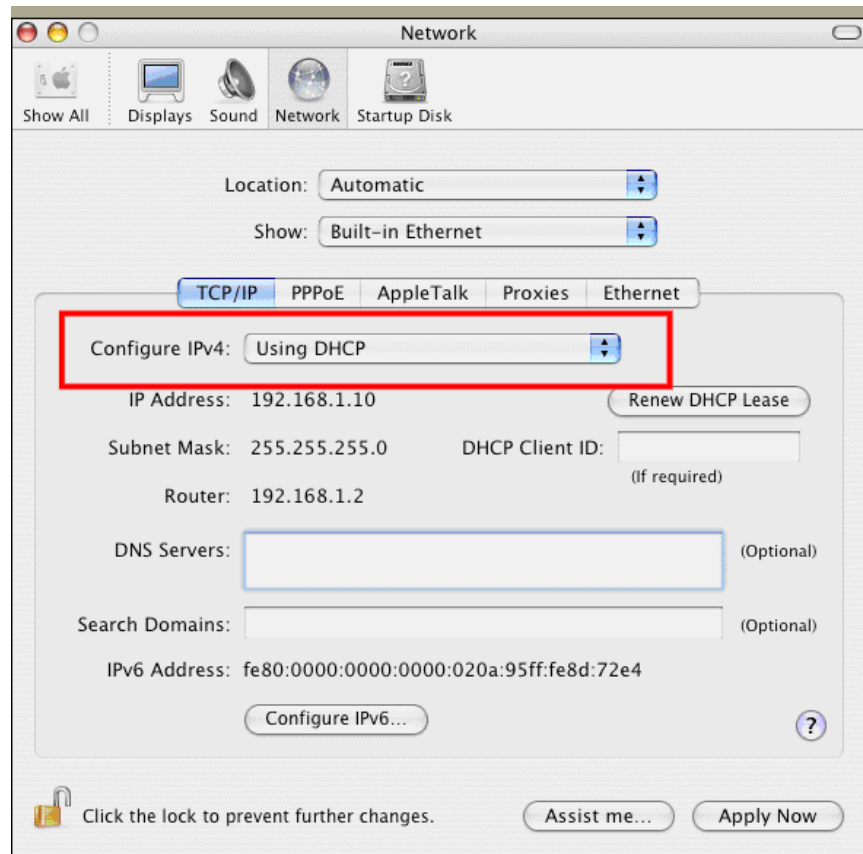

V-3 Pinging the Device

The default gateway IP address of the modem is 192.168.1.1. For some reason, you might need to use “ping” command to check the link status of the modem. **The most important thing is that the computer will receive a reply from 192.168.1.1.** If not, please check the IP address of your computer. We suggest you setting the network connection as **get IP automatically**. (Please refer to the section V-2)

Please follow the steps below to ping the modem correctly.

V-3-1 For Windows

1. Open the **Command Prompt** window (from **Start menu> Run**).
2. Type **cmd**. The DOS command dialog will appear.

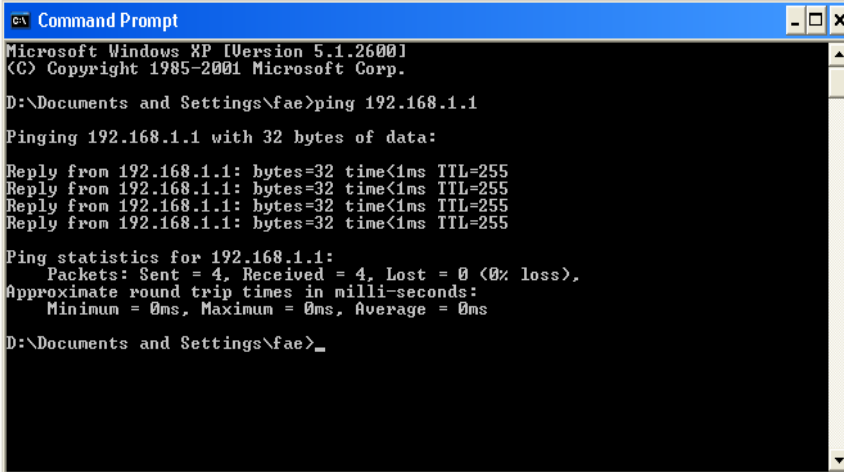

```
Microsoft Windows XP [Version 5.1.2600]
(C) Copyright 1985-2001 Microsoft Corp.

D:\Documents and Settings\fae>ping 192.168.1.1

Pinging 192.168.1.1 with 32 bytes of data:

Reply from 192.168.1.1: bytes=32 time<1ms TTL=255
Reply from 192.168.1.1: bytes=32 time<1ms TTL=255
Reply from 192.168.1.1: bytes=32 time<1ms TTL=255
Reply from 192.168.1.1: bytes=32 time<1ms TTL=255

Ping statistics for 192.168.1.1:
    Packets: Sent = 4, Received = 4, Lost = 0 (0% loss),
    Approximate round trip times in milli-seconds:
        Minimum = 0ms, Maximum = 0ms, Average = 0ms

D:\Documents and Settings\fae>_
```

3. Type ping 192.168.1.1 and press [Enter]. If the link is OK, the line of “**Reply from 192.168.1.1: bytes=32 time<1ms TTL=255**” will appear.
4. If the line does not appear, please check the IP address setting of your computer.

V-3-2 For Mac Os (Terminal)

1. Double click on the current used Mac Os on the desktop.
2. Open the **Application** folder and get into **Utilities**.
3. Double click **Terminal**. The Terminal window will appear.
4. Type **ping 192.168.1.1** and press [Enter]. If the link is OK, the line of “**64 bytes from 192.168.1.1: icmp_seq=0 ttl=255 time=xxxx ms**” will appear.

```
Terminal — bash — 80x24
Last login: Sat Jan  3 02:24:18 on ttys1
Welcome to Darwin!
Vigor10:~ draytek$ ping 192.168.1.1
PING 192.168.1.1 (192.168.1.1): 56 data bytes
64 bytes from 192.168.1.1: icmp_seq=0 ttl=255 time=0.755 ms
64 bytes from 192.168.1.1: icmp_seq=1 ttl=255 time=0.697 ms
64 bytes from 192.168.1.1: icmp_seq=2 ttl=255 time=0.716 ms
64 bytes from 192.168.1.1: icmp_seq=3 ttl=255 time=0.731 ms
64 bytes from 192.168.1.1: icmp_seq=4 ttl=255 time=0.72 ms
^C
--- 192.168.1.1 ping statistics ---
5 packets transmitted, 5 packets received, 0% packet loss
round-trip min/avg/max = 0.697/0.723/0.755 ms
Vigor10:~ draytek$
```

V-4 Backing to Factory Default Setting

Sometimes, a wrong connection can be improved by returning to the default settings. Try to reset the modem by software or hardware.

i Warning:

After using the factory default settings, you will lose all settings you did before. Make sure you have recorded all useful settings before you pressing.

V-4-1 Software Reset

You can reset the modem to factory default via Web page.

Go to **System Maintenance** and choose **System Reboot** on the web page. The following screen will appear. Choose **Factory Default** and click **Reboot**.

After few seconds, the modem will return all the settings to the factory settings.

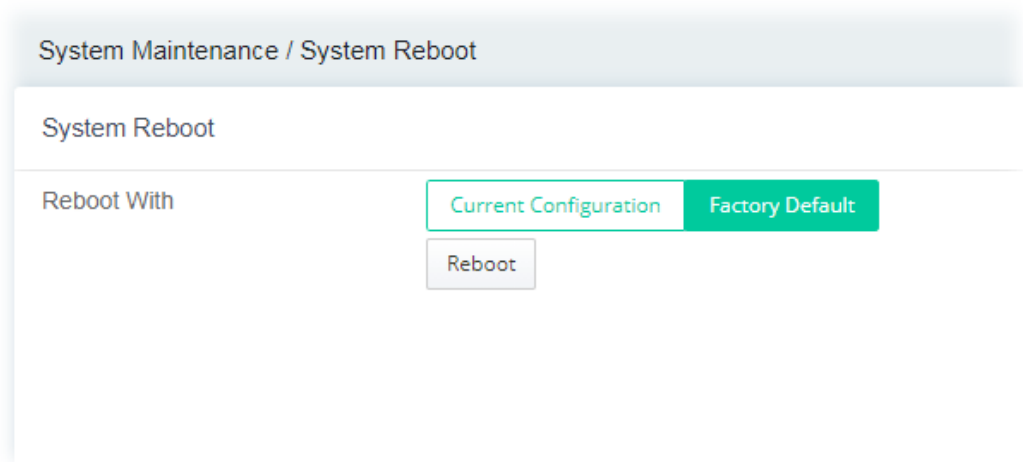

V-4-2 Hardware Reset

While the modem is running, press the **Factory Reset** button and hold for more than 5 seconds. When you see the **ACT** LED blinks rapidly, please release the button. Then, the modem will restart with the default configuration.

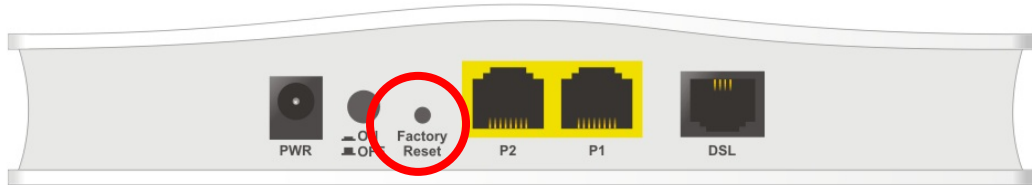

After restore the factory default setting, you can configure the settings for the modem again to fit your personal request.

V-5 Contacting DrayTek

If the modem still cannot work correctly after trying many efforts, please contact your dealer for further help right away. For any questions, please feel free to send an e-mail to support@draytek.com.