

Quick Installation Guide

Whole Home Mesh Wi-Fi AP

Connect the Hardware

The Whole Home Mesh Wi-Fi AP is designed to create a mesh wireless network throughout your home.

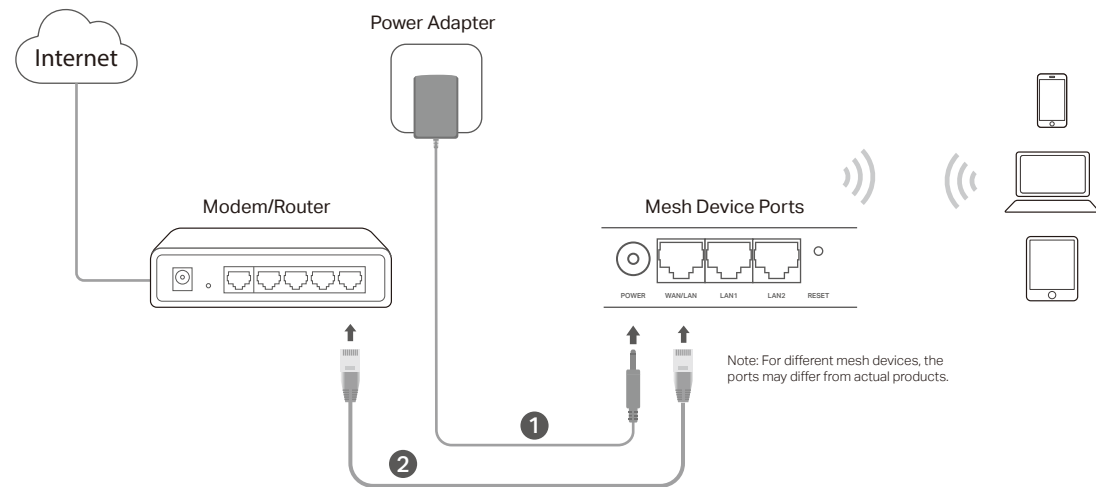

Note: For different mesh devices, the ports may differ from actual products.

- 1 Connect the power adapter to the mesh device.
- 2 Connect the WAN/LAN port of the mesh device to your modem/router's Ethernet port via an Ethernet cable.
- 3 Verify the status LED is flashing blue before continuing with the configuration.

Connect the Hardware

Set Up the Network

Method 1: Via TP-Link Aginet App

1. Download the Aginet app.

You can easily set up and manage your network through the Aginet app. Search for Aginet on the Apple app Store or Google Play, or simply scan the QR code below. Download and install the Aginet app.

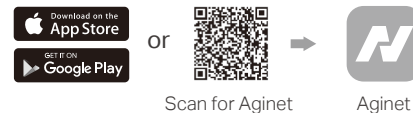

2. Open the Aginet app and log in with your TP-Link ID.

Note: This step is optional. If you don't have an account, you may choose to create a TP-Link ID, or simply manage your device without it. To enjoy a more complete service from TP-Link, bind your TP-Link ID to the mesh device.

3. Set up your network

Tap "Create a Network" in the Aginet app then choose "Connect via Ethernet Cable". Follow the steps to complete the setup and connect to the internet.

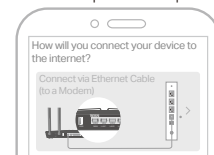

After completing the configuration of the first device, you can choose to add more mesh devices to extend Wi-Fi coverage.



Set Up the Network

Method 2: Via a Web Browser

1. Connect your Laptop/PC/Mobile phone to the mesh device wirelessly or with an Ethernet cable.

The default wireless network name (SSID) and password are printed on the product label at the bottom of the mesh device.



2. Launch a web browser, and enter <http://tplinkwifi.net> or <http://192.168.88.1> in the address bar. Create your own login password and log in to the device.

Note:

1. If the login window does not appear, please refer to **Q1 of Need Help?** in this guide.
2. For ISP customized mesh devices, the login account name and password may be printed on the product label.

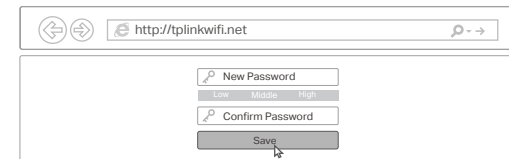

3. Follow the Quick Setup instructions to set up your network.

😊 Enjoy the internet !

LED Status

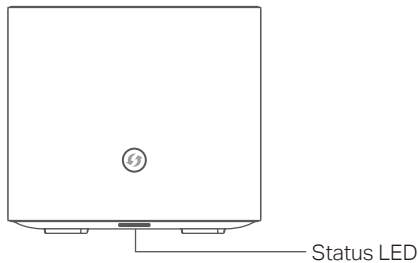

LED	Device Status
Flashing yellow	The device is starting up or resetting.
Yellow	The connection quality of the device is normal.
Flashing blue	The device is ready for setup.
Fast flashing blue	The device is establishing a WPS or mesh connection.
Blue	The device has been set up, but the internet is unavailable.
Flashing white/green	The device is upgrading firmware.
White/green	The device is all set up and connected to internet.
Flashing red	The device has lost connection.
Red	The device has an issue.

Need Help?

Q1. What should I do if I cannot access the web management page?

- If the computer is set to a static IP address, change its settings to obtain an IP address automatically.
- Make sure <http://tplinkwifi.net> is correctly entered in the web browser.
- Use another web browser and try again.
- Reboot your device and try again.
- Disable then enable the network adapter being used.

Q2. What should I do if the mesh device's status LED remains flashing red?

- Place the mesh device close to another configured mesh device until the status LED turns solid blue, white or green, then relocate the mesh device.
- Refer to Q4 to reset your mesh device, and then re-add the mesh device to the network using the Aginet app or via a web browser.

Q3. What should I do if I cannot access the internet?

- Check if the internet is working normally by connecting a computer directly to the modem or the router via an Ethernet cable. If it is not, contact your internet service provider.
- For router mode, log in to the management page of the mesh device, and go to the **Status** page to check whether the IP address is valid or not. If it is, please run the **Quick Setup** again, otherwise, recheck the hardware connection.
- Reboot your device and try again.

Q4. How do I restore the device to its factory default settings?

- While the device is powered on, press and hold the **RESET** button for at least five seconds, and then release the button.
- Log in to the web management page of the device, go to **System Tools** > **Backup & Restore** and click **Factory Restore**. The device will restore and reboot automatically.

Q5. What should I do if I forget my web management page password?

- Refer to Q4 to reset your device, and then you can set a new password.

Q6. What should I do if I forget my wireless network password?

- If you haven't changed the default wireless password, it can be found on the product label at the bottom of the mesh device.
- Connect a computer to the mesh device via an Ethernet cable. Log in to the web management page, and go to **Basic** > **Wireless** to retrieve or reset your wireless password.

Safety Information

- Keep the device away from water, fire, humidity or hot environments.
- Do not attempt to disassemble, repair, or modify the device. If you need service, please contact us.
- Do not use the device where wireless devices are not allowed.
- Do not use damaged charger or USB cable to charge the device.
- Do not use any other chargers than those recommended.
- Adapter shall be installed near the equipment and shall be easily accessible.

Please read and follow the above safety information when operating the device. We cannot guarantee that no accidents or damage will occur due to improper use of device. Please use this product with care and operate at your own risk.

EU Declaration of Conformity

TP-Link hereby declares that the device is in compliance with the essential requirements and other relevant provisions of directives 2014/53/EU, 2009/125/EC, 2011/65/EU and (EU) 2015/863.



The original EU declaration of conformity may be found at <https://www.tp-link.com/en/support/ce/>

UK Declaration of Conformity

TP-Link hereby declares that the device is in compliance with the essential requirements and other relevant provisions of the Radio Equipment Regulations 2017.

The original UK declaration of conformity may be found at <https://www.tp-link.com/support/ukca/>

Operating Frequency / max output power	2400MHz~2483.5MHz / 20dBm 5150MHz~5250MHz (Indoor use only) / 23dBm 5250MHz~5350MHz (Indoor use only) / 23dBm 5470MHz~5725MHz / 30dBm
--	--

Restrictions in:	
	AT BE BG CH CY CZ DE DK EE EL ES FI FR HR HU IE IS IT LI LT LU LV MT NL NO PL PT RO SE SI SK UK(NI)
	UK

Attention: This device may only be used indoors in all EU member states, EFTA countries and Northern Ireland.

European Union – Disposal and Recycling Information

The symbol below means that according to local regulations your product and/or its battery shall be disposed of separately from domestic waste. If this product is end of life, take it to a recycling station designated by local authorities. At the time of disposal, the separate collection of your product and/or its battery will help save natural resources and ensure that the environment is sustainable development.



GNU General Public License Notice

This product may include software code developed by third parties, including software code subject to the GNU General Public License ("GPL"). As applicable, TP-Link ("TP-Link" in this context referring to the TP-Link entity offering respective software for download or being responsible for distribution of products that contain respective code) provides, by itself or with the support of third parties (e.g. the TP-Link Corporation Limited), mail service of a machine readable copy of the corresponding GPL source code on CD-ROM upon request via email or traditional paper mail. TP-Link will charge for a nominal cost to cover shipping and media charges as allowed under the GPL. This offer will be valid for at least 3 years.

For GPL inquiries and the GPL CD-ROM information, please contact GPL@tp-link.com or write to Suite 901, New East Ocean Centre, Tsim Sha Tsui, Hong Kong. Additionally, TP-Link provides for a GPL-Code-Centre under <https://www.tp-link.com/support/gpl/> where machine readable copies of the GPL source codes used in TP-Link products are available for free download.

The GPL Code used in this product is distributed WITHOUT ANY WARRANTY and is subject to the copyrights of one or more authors. For further information about GNU General Public License please refer to the following website: <https://static.tp-link.com/resources/document/GPL%20License%20Terms.pdf>