



X12STL-F

USER'S MANUAL

Revision 1.0c

The information in this user's manual has been carefully reviewed and is believed to be accurate. The manufacturer assumes no responsibility for any inaccuracies that may be contained in this document, and makes no commitment to update or to keep current the information in this manual, or to notify any person or organization of the updates. **Please Note: For the most up-to-date version of this manual, please see our website at www.supermicro.com.**

Super Micro Computer, Inc. ("Supermicro") reserves the right to make changes to the product described in this manual at any time and without notice. This product, including software and documentation, is the property of Supermicro and/or its licensors, and is supplied only under a license. Any use or reproduction of this product is not allowed, except as expressly permitted by the terms of said license.

IN NO EVENT WILL Super Micro Computer, Inc. BE LIABLE FOR DIRECT, INDIRECT, SPECIAL, INCIDENTAL, SPECULATIVE OR CONSEQUENTIAL DAMAGES ARISING FROM THE USE OR INABILITY TO USE THIS PRODUCT OR DOCUMENTATION, EVEN IF ADVISED OF THE POSSIBILITY OF SUCH DAMAGES. IN PARTICULAR, SUPER MICRO COMPUTER, INC. SHALL NOT HAVE LIABILITY FOR ANY HARDWARE, SOFTWARE, OR DATA STORED OR USED WITH THE PRODUCT, INCLUDING THE COSTS OF REPAIRING, REPLACING, INTEGRATING, INSTALLING OR RECOVERING SUCH HARDWARE, SOFTWARE, OR DATA.

Any disputes arising between manufacturer and customer shall be governed by the laws of Santa Clara County in the State of California, USA. The State of California, County of Santa Clara shall be the exclusive venue for the resolution of any such disputes. Supermicro's total liability for all claims will not exceed the price paid for the hardware product.

FCC Statement: This equipment has been tested and found to comply with the limits for a Class A digital device pursuant to Part 15 of the FCC Rules. These limits are designed to provide reasonable protection against harmful interference when the equipment is operated in a commercial environment. This equipment generates, uses, and can radiate radio frequency energy and, if not installed and used in accordance with the manufacturer's instruction manual, may cause harmful interference with radio communications. Operation of this equipment in a residential area is likely to cause harmful interference, in which case you will be required to correct the interference at your own expense.

California Best Management Practices Regulations for Perchlorate Materials: This Perchlorate warning applies only to products containing CR (Manganese Dioxide) Lithium coin cells. "Perchlorate Material-special handling may apply. See www.dtsc.ca.gov/hazardouswaste/perchlorate".



WARNING: This product can expose you to chemicals including lead, known to the State of California to cause cancer and birth defects or other reproductive harm. For more information, go to www.P65Warnings.ca.gov.

The products sold by Supermicro are not intended for and will not be used in life support systems, medical equipment, nuclear facilities or systems, aircraft, aircraft devices, aircraft/emergency communication devices or other critical systems whose failure to perform be reasonably expected to result in significant injury or loss of life or catastrophic property damage. Accordingly, Supermicro disclaims any and all liability, and should buyer use or sell such products for use in such ultra-hazardous applications, it does so entirely at its own risk. Furthermore, buyer agrees to fully indemnify, defend and hold Supermicro harmless for and against any and all claims, demands, actions, litigation, and proceedings of any kind arising out of or related to such ultra-hazardous use or sale.

Manual Revision 1.0c

Release Date: August 12, 2022

Unless you request and receive written permission from Super Micro Computer, Inc., you may not copy any part of this document. Information in this document is subject to change without notice. Other products and companies referred to herein are trademarks or registered trademarks of their respective companies or mark holders.

Copyright © 2022 by Super Micro Computer, Inc.
All rights reserved.

Printed in the United States of America

Preface

About This Manual

This manual is written for system integrators, IT technicians and knowledgeable end users. It provides information for the installation and use of the motherboard.

About This Motherboard

The Supermicro X12STL-F motherboard supports the Intel® Xeon E-2300 Family and 10th Generation Pentium (Socket H5 - LGA 1200) series processor with up to eight cores. Built with the Intel PCH C252 chipset, the X12STL-F supports 128GB DDR4 ECC UDIMM memory with speeds of up to 3200MHz, dual 1GbE LAN (2x Intel i210) Base-T ports, and a Trusted Platform Module (TPM) header onboard. This motherboard also features superior IO expandability, including six SATA3 (6Gb/s), one M.2 in 2280/22110 (PCIe 3.0 x4), three PCIe 4.0 slots, and one PCIe 3.0 slot.

Please note that this motherboard is intended to be installed and serviced by professional technicians only. For processor/memory updates, please refer to our website at <http://www.supermicro.com/products/>.

Conventions Used in the Manual

Special attention should be given to the following symbols for proper installation and to prevent damage done to the components or injury to yourself:



Warning! Indicates important information given to prevent equipment/property damage or personal injury.



Warning! Indicates high voltage may be encountered while performing a procedure.



Important: Important information given to ensure proper system installation or to relay safety precautions.



Note: Additional Information given to differentiate various models or to provide information for proper system setup.

Contacting Supermicro

Headquarters

Address: Super Micro Computer, Inc.
980 Rock Ave.
San Jose, CA 95131 U.S.A.

Tel: +1 (408) 503-8000

Fax: +1 (408) 503-8008

Email: Marketing@supermicro.com (General Information)
Sales-USA@supermicro.com (Sales Inquiries)
Government_Sales-USA@supermicro.com (Gov. Sales Inquiries)
Support@supermicro.com (Technical Support)
RMA@supermicro.com (RMA Support)
Webmaster@supermicro.com (Webmaster)

Website: www.supermicro.com

Europe

Address: Super Micro Computer B.V.
Het Sterrenbeeld 28, 5215 ML
's-Hertogenbosch, The Netherlands

Tel: +31 (0) 73-6400390

Fax: +31 (0) 73-6416525

Email: Sales_Europe@supermicro.com (General Information)
Support_Europe@supermicro.com (Technical Support)
RMA_Europe@supermicro.com (RMA Support)

Website: www.supermicro.nl

Asia-Pacific

Address: Super Micro Computer, Inc.
3F, No. 150, Jian 1st Rd.
Zhonghe Dist., New Taipei City 235
Taiwan (R.O.C)

Tel: +886-(2) 8226-3990

Fax: +886-(2) 8226-3992

Email: Sales-Asia@supermicro.com.tw (Sales Inquiry)
Support@supermicro.com.tw (Technical Support)
RMA@supermicro.com.tw (RMA Support)

Website: www.supermicro.com.tw

Table of Contents

Chapter 1 Introduction

1.1 Checklist	8
Quick Reference	11
Quick Reference Table	12
Motherboard Features	14
1.2 Processor and Chipset Overview	17
1.3 Special Features	17
Recovery from AC Power Loss	17
1.4 System Health Monitoring	17
Onboard Voltage Monitors	17
Fan Status Monitor with Firmware Control	18
Environmental Temperature Control	18
System Resource Alert	18
1.5 ACPI Features	18
1.6 Power Supply	18

Chapter 2 Installation

2.1 Static-Sensitive Devices	19
Precautions	19
Unpacking	19
2.2 Processor and Heatsink Installation	20
Installing the LGA1200 Processor	20
Installing an Active CPU Heatsink with Fan	22
Removing the Heatsink	24
2.3 Motherboard Installation	25
Tools Needed	25
Location of Mounting Holes	25
Installing the Motherboard	26
2.4 Memory Support and Installation	27
Memory Support	27
General Guidelines for Optimizing Memory Performance	28
DIMM Installation	29
DIMM Removal	29
2.5 Rear I/O Ports	30

2.6 Front Control Panel	35
2.7 Connectors	40
Power Connections	40
Headers	42
2.7 Jumper Settings	48
How Jumpers Work	48
2.8 LED Indicators	52
Chapter 3 Troubleshooting	
3.1 Troubleshooting Procedures	55
Before Power On	55
No Power	55
System Boot Failure	56
Memory Errors	56
Losing the System's Setup Configuration	56
When the System Becomes Unstable	57
3.2 Technical Support Procedures	59
3.3 Frequently Asked Questions	60
3.4 Battery Removal and Installation	61
Battery Removal	61
Proper Battery Disposal	61
Battery Installation	61
3.5 Returning Merchandise for Service	62
Chapter 4 BIOS	
4.1 Introduction	63
Starting the Setup Utility	63
4.2 Main Setup	64
4.3 Advanced	65
4.4 Event Logs	92
4.5 IPMI	94
4.6 Security	97
4.7 Boot	104
4.8 Save & Exit	107

Appendix A BIOS Codes

BIOS POST Codes	109
-----------------------	-----

Appendix B Software

B.1 Microsoft Windows OS Installation.....	110
B.2 Driver Installation.....	112
B.3 SuperDoctor® 5.....	113

Appendix C Standardized Warning Statements

Appendix D UEFI BIOS Recovery

D.1 Overview.....	117
D.2 Recovering the UEFI BIOS Image.....	117
D.3 Recovering the BIOS Block with a USB Device	118

Chapter 1

Introduction

Congratulations on purchasing your computer motherboard from an industry leader. Supermicro boards are designed to provide you with the highest standards in quality and performance.

In addition to the motherboard, several important parts that are included with the system are listed below. If anything listed is damaged or missing, contact your retailer.

1.1 Checklist

Main Parts List (Retail Single Package)		
Description	Part Number	Quantity
Supermicro Motherboard	X12STL-F	1
I/O cables	CBL-0044L	6
I/O shield	MCP-260-00042-0N	1
Quick Reference Guide	MNL-2353-QRG	1

Important Links

For your system to work properly, follow the links below to download all necessary drivers/utilities and the user's manual for your server.

- Supermicro product manuals: <https://www.supermicro.com/support/manuals/>
- Product drivers and utilities: <https://www.supermicro.com/wdl/driver/>
- Product safety info: https://www.supermicro.com/about/policies/safety_information.cfm
- A secure data deletion tool designed to fully erase all data from storage devices can be found at our website: https://www.supermicro.com/about/policies/disclaimer.cfm?url=/wdl/utility/Lot9_Secure_Data_Deletion_Utility/
- If you have any questions, contact our support team at: support@supermicro.com

This manual may be periodically updated without notice. Check the Supermicro website for possible updates to the manual revision level.

Figure 1-1. X12STL-F Motherboard Images

Front View

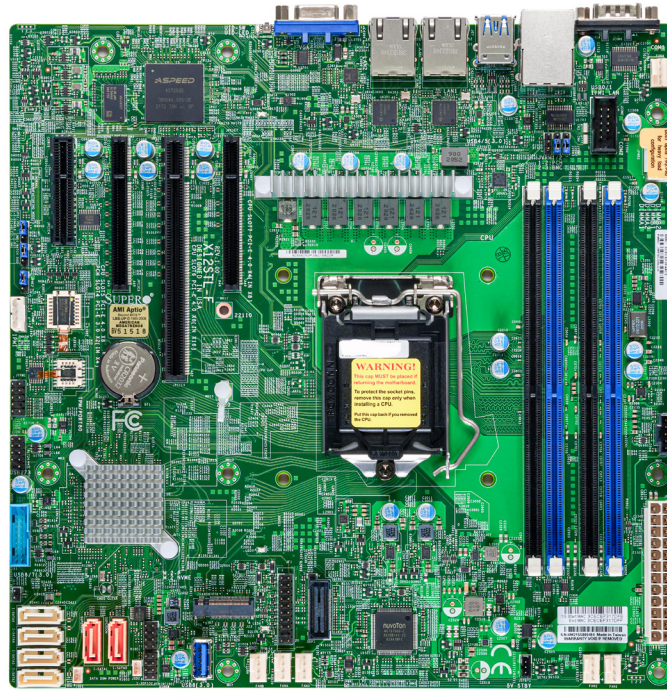

Angle View

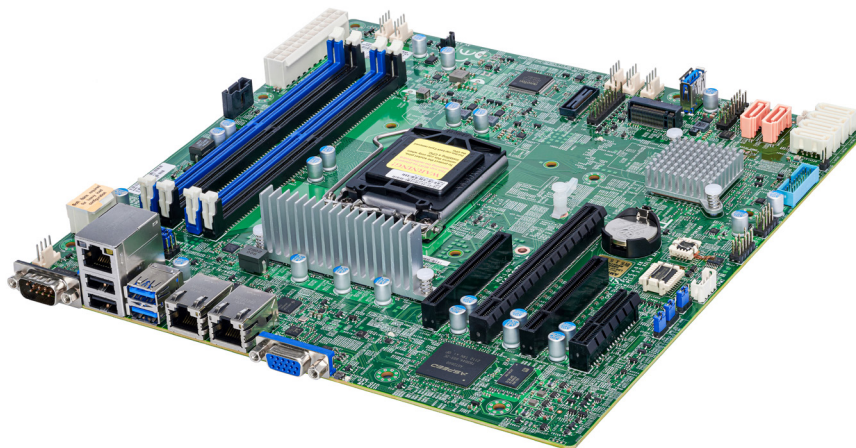

Side View





 **Note:** All graphics shown in this manual were based upon the latest PCB revision available at the time of publication of the manual. The motherboard you received may or may not look exactly the same as the graphics shown in this manual.

Figure 1-2. Motherboard Layout

(not drawn to scale)

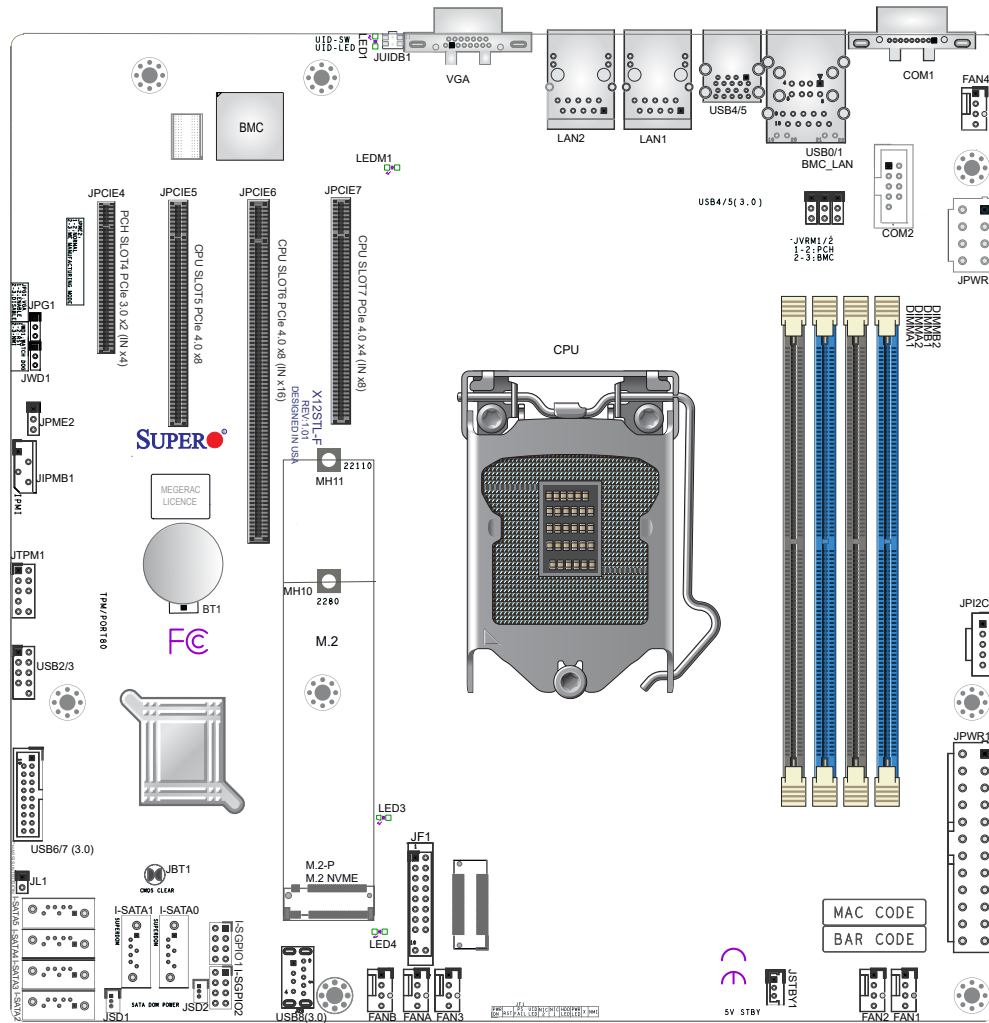

 **Note:** Components not documented are for internal testing only.

Quick Reference

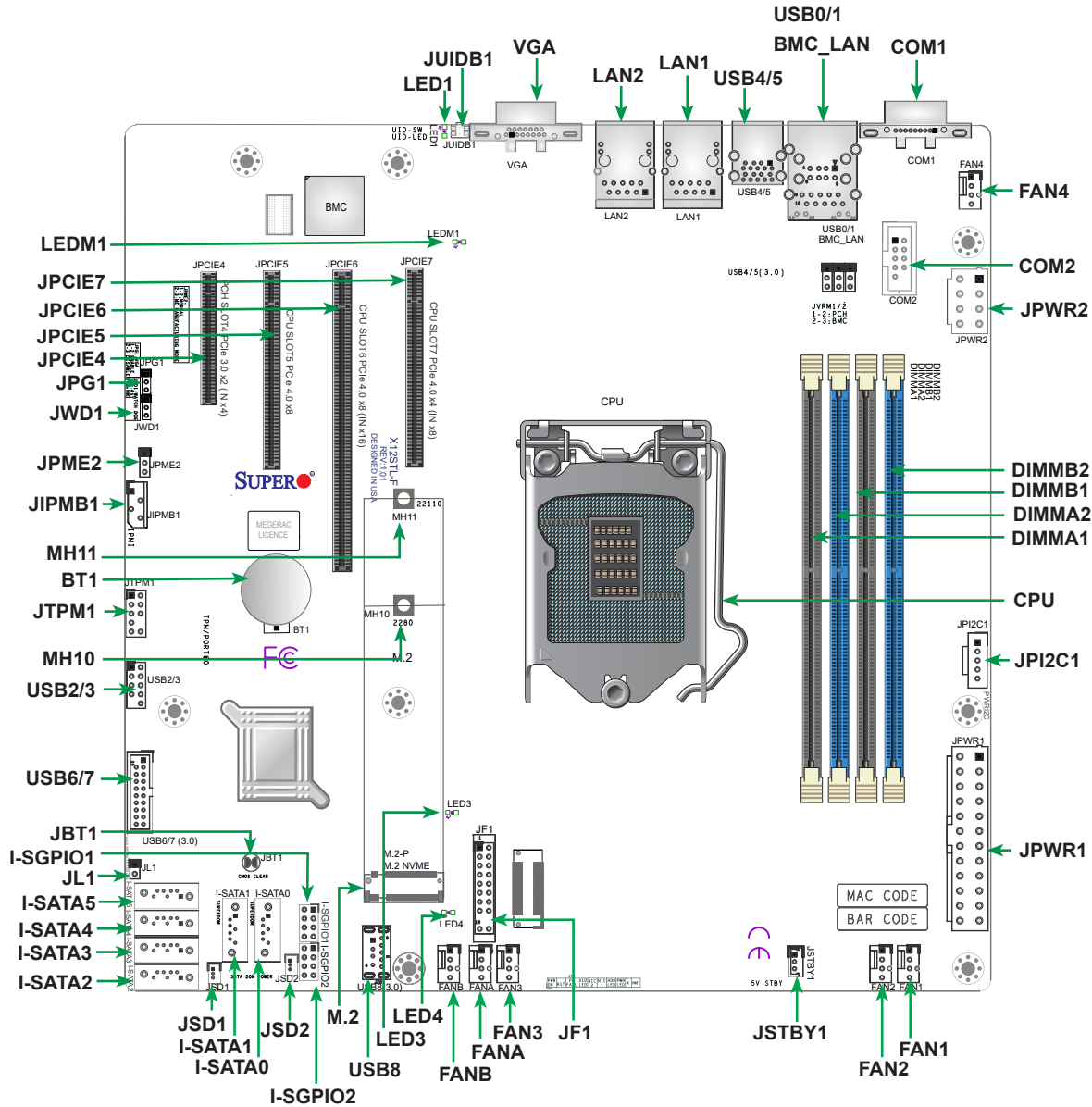

Notes:

- See [Chapter 2](#) for detailed information on jumpers, I/O ports, and JF1 front panel connections.
- "■" indicates the location of Pin 1.
- Jumpers/LED indicators not indicated are used for testing only.
- Use only the correct type of onboard CMOS battery as specified by the manufacturer. Do not install the onboard battery upside down to avoid possible explosion.

Quick Reference Table



Jumper	Description	Default Setting
JBT1	CMOS Clear	Open (Normal)
JPG1	VGA Enable/Disable	Pins 1-2 (Enabled)
JPME2	Manufacturing Mode	Pins 1-2 (Normal)
JVRM1/JVRM2	VRM SMB Clock (to BMC or PCH)	Pins 1-2 PCH (Normal) Pins 2-3 BMC (Normal)
JWD1	Watchdog Timer	Pins 1-2 (Reset)

LED	Description	Status
LED1	Unit Identifier LED	Solid Blue: Unit Identified
LED3	M.2 Activity LED	Blinking Green: Device Working
LED4	Power Status LED	Solid Green: Power On
LEDM1	BMC Heartbeat LED	Blinking Green: BMC Normal
LAN1 and LAN2 LEDs	Ethernet Ports LEDs	Green (right): Indicates Activity Link LED (left): Indicates Speed
BMC LAN LEDs	BMC LAN Ports LEDs	Green: Indicates Speed Amber: Indicates Activity

Connector	Description
BT1	Onboard Battery
COM1/COM2	COM1 (Port), COM2 (Header)
FAN1 - FAN4, FANA/FANB	System/CPU Fan Headers
I-SATA0 - I-SATA5	Intel Serial ATA (SATA 3.0) Ports (6Gb/s)
I-SGPIO1, I-SGPIO2	Serial General Purpose I/O Headers
BMC_LAN	Dedicated BMC LAN Port
JF1	Front Control Panel Header
JL1	Chassis Intrusion Header
JPCIE4	PCH SLOT4 PCIe 3.0 x2 (IN x4)
JPCIE5	CPU SLOT5 PCIe 4.0 x8 (Slot5 will run at PCIe 3.0 x8 when a Pentium processor is installed)
JPCIE6	CPU SLOT6 PCIe 4.0 x8 (IN x16) (Slot6 will run at PCIe 3.0 x8 when a Pentium processor is installed)
JPCIE7	CPU SLOT7 PCIe 4.0 x4 (IN x8) (SLOT7 will be disabled when a Pentium processor is installed)
JPWR1	24-pin ATX Main Power Connector (Required)
JPWR2	+12V 8-pin CPU Power Connector (Required)
JSD1/JSD2	SATA DOM Power Connector
JSTBY1	Standby Power Header (5V)
JIPMB1	4-pin External BMC I ² C header (for an IPMI card)
JTPM1	Trusted Platform Module/Port 80 Connector
JUIDB1	UID Switch
LAN1/LAN2	Gigabit (RJ45) Ports

Connector	Description
M.2-P, M.2 NVME	M.2 PCIe 3.0 x4 Slot (supports 22110/2280 FF)
JPI ² C1	Power System Management Bus (SMB) I ² C Header
USB0/1	Back Panel USB 2.0 Ports
USB2/3	Front Accessible USB 2.0 Ports
USB4/5	Back Panel USB 3.2 Gen1 Connector
USB6/7	Front Accessible USB 3.2 Gen1 Ports via Headers
USB8	Front Accessible USB 3.2 Gen1 Port (Type-A)
VGA	VGA Port

Motherboard Features

Motherboard Features	
CPU	<ul style="list-style-type: none"> Supports an Intel Xeon E-2300 Family and 10th Generation Pentium (Socket H5 - LGA 1200) series processor
Memory	<ul style="list-style-type: none"> Up to 128GB of ECC UDIMM DDR4 memory with speeds of up to 3200MHz in four memory slots <p> Note: Speed support is up to 2666MHz when a Pentium processor is installed. Speed support is up to 2933 MHz for 2R2R configurations.</p>
DIMM Size	<ul style="list-style-type: none"> 4GB, 8GB, 16GB, 32GB at 1.2V <p> Note: For the latest CPU/memory updates, please refer to our website at http://www.supermicro.com/products/motherboard.</p>
Chipset	<ul style="list-style-type: none"> Intel C252
Expansion Slots	<ul style="list-style-type: none"> Six SATA 6Gb/s (support RAID 0, 1, 5, 10 and DOM power) Three PCIe 4.0 slots: 2x8 (1 in x16), 1x4 (in x8) (*Note: When a Pentium processor is installed, Slot 7 will be disabled, and Slot 5 & Slot 6 will run at PCIe 3.0 x8.) One PCIe 3.0 Slot: 1x2 (in x4) One M.2 PCIe 3.0 x4 connector (Supports M-key 2280 and 22110)
Super I/O	<ul style="list-style-type: none"> AST2600
Peripheral Devices	<ul style="list-style-type: none"> Four USB 2.0 ports (two on the rear I/O panel, two via headers) Five USB 3.2 ports (two on the rear I/O panel, one Type-A, two via headers) Two SuperDOM with support for power connectors
BIOS	<ul style="list-style-type: none"> 256Mb AMI BIOS® SPI Flash BIOS ACPI 6.0, Plug and Play (PnP), BIOS rescue hot-key, and SMBIOS 3.0 or later
Power Management	<ul style="list-style-type: none"> ACPI power management Power button override mechanism Power-on mode for AC power recovery Wake-on-LAN



Note: The table above is continued on the next page.

Motherboard Features	
System Health Monitoring	
	<ul style="list-style-type: none">• Onboard voltage monitoring for +12V, +5V, +3.3V, CPU, Memory, VBAT, +3.3V stdby, CPU temperature, PCH temperature, system temperature• 6 CPU switch phase voltage regulator• CPU thermal trip support• Platform Environment Control Interface (PECI)/TSI
Fan Control	
	<ul style="list-style-type: none">• Low noise fan speed control• Dual cooling zone• Six 4-pin fan headers
System Management	
	<ul style="list-style-type: none">• Trusted Platform Module (TPM) support• SuperDoctor® 5• Chassis intrusion header and detection
LED Indicators	
	<ul style="list-style-type: none">• Unit Identifier LED (LED1)• BMC Heartbeat LED (LEDM1)• M.2 Activity LED (LED3)• Power Status LED (LED4)• BMC LAN LED
Dimensions	
	<ul style="list-style-type: none">• Dimensions: 9.6"(W) x 9.6"(L) (243.8 mm x 243.8 mm)



Note: The CPU maximum thermal design power (TDP) is subject to chassis and heatsink cooling restrictions. For proper thermal management, please check the chassis and heatsink specifications for proper CPU TDP sizing.

Figure 1-3.
System Block Diagram

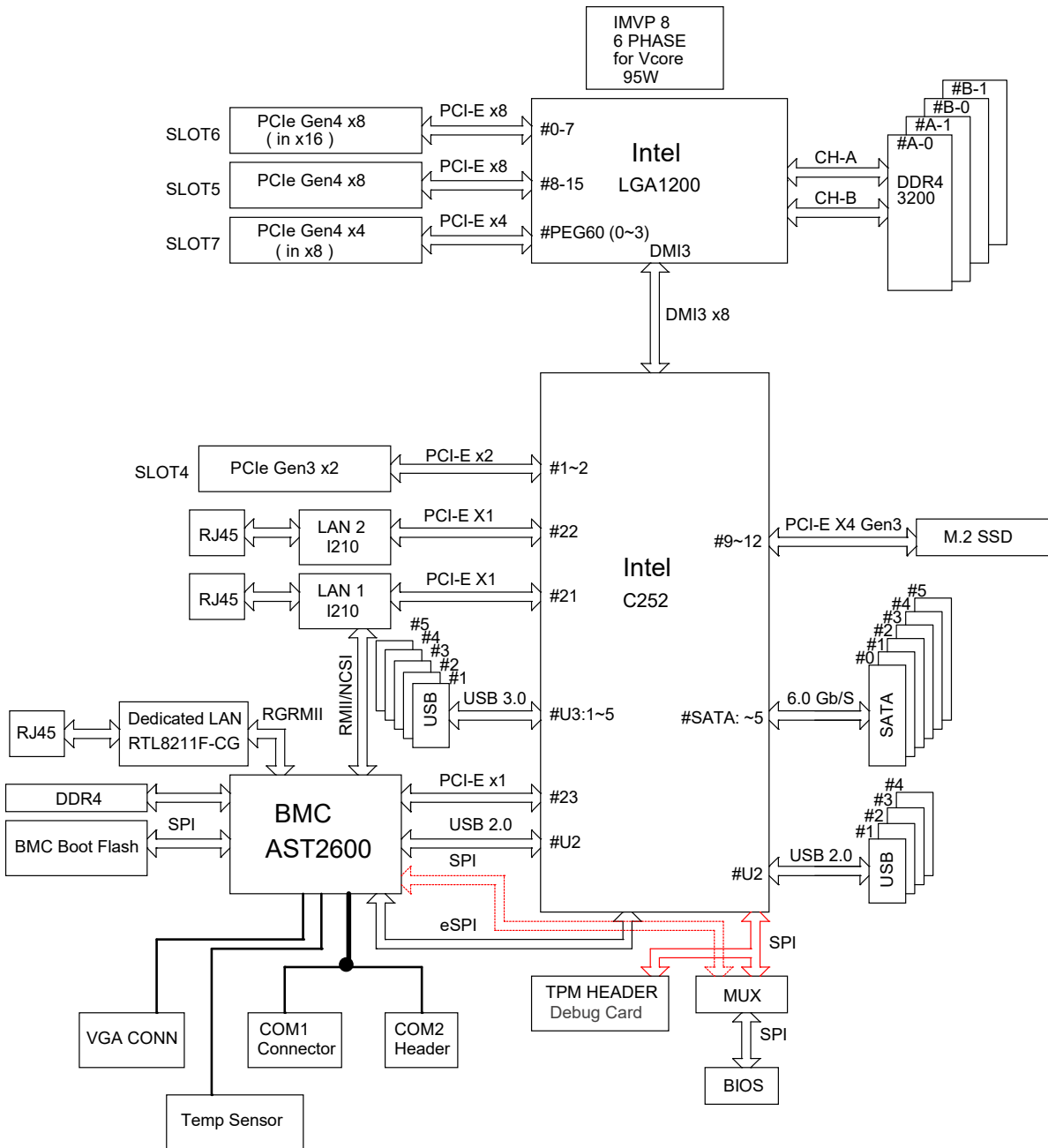

Note: This is a general block diagram and may not exactly represent the features on your motherboard. See the previous pages for the actual specifications of your motherboard.

1.2 Processor and Chipset Overview

Built upon the functionality and capability of the Intel Xeon E-2300 Family and 10th Generation Pentium (Socket H5 - LGA 1200) series processor and the Intel C252 chipset, the X12STL-F motherboard provides system performance, power efficiency, and feature sets to address the needs of next-generation computer users. It dramatically increases system performance for a multitude of server applications.

The Intel Xeon E-2300/10th Generation Pentium processor and the C252 chipset support the following features:

- Intel SPS 6.x
- Intel TXT
- Intel Virtual RAID on CPU (SATA RAID)
- IO Flex
- eSPI

 **Notes:** **1.** Intel TXT is only supported in the UEFI boot mode. Please install the UEFI OS and then enable the Intel TXT feature. **2.** For SGX, Turbo Boost Technology should be supported by CPU.

1.3 Special Features

Recovery from AC Power Loss

The Basic I/O System (BIOS) provides a setting that determines how the system will respond when AC power is lost and then restored to the system. You can choose for the system to remain powered off (in which case you must press the power switch to turn it back on), or for it to automatically return to the power-on state. See the Advanced BIOS Setup section for this setting. The default setting is **Last State**.

1.4 System Health Monitoring

With the BMC IPMI firmware built-in, the motherboard allows the user to monitor system health, including voltage, fan status, and environmental temperature.

Onboard Voltage Monitors

Warning or error messages are issued through IPMI system event log but will not be sent to the screen automatically. End users will not be able to adjust voltage thresholds. It should be defined by IPMI FW.



Notes: **1.** Warning messages will be stored in SEL. **2.** The severity X icon will display on the sensor page if it is critical.

Fan Status Monitor with Firmware Control

IPMI FW can set the fan mode to speed up or lower the fan speed.

Environmental Temperature Control

The CPU fan is always on, not dependent on any user-defined threshold. CPU fan speed is adjusted automatically according to the CPU temperature.



Note: To avoid possible system overheating, please provide adequate airflow to your system.

System Resource Alert

This feature is available when used with SuperDoctor 5® in the Windows OS or in the Linux environment. SuperDoctor is used to notify the user of certain system events. For example, you can configure SuperDoctor to provide you with warnings when the system temperature, CPU temperatures, voltages and fan speeds go beyond a predefined range.

1.5 ACPI Features

The Advanced Configuration and Power Interface (ACPI) specification defines a flexible and abstract hardware interface that provides a standard way to integrate power management features throughout a computer system, including its hardware, operating system and application software. This enables the system to automatically turn on and off peripherals such as CD-ROMs, network cards, hard disk drives and printers.

In addition to enabling operating system-directed power management, ACPI also provides a generic system event mechanism for Plug and Play, and an operating system-independent interface for configuration control. ACPI leverages the Plug and Play BIOS data structures, while providing a processor architecture-independent implementation that is compatible with appropriate Windows operating systems. For detailed information regarding OS support, please refer to the Supermicro website.

1.6 Power Supply

As with all computer products, a stable power source is necessary for proper and reliable operation. This is even more important for processors that have high CPU clock rates. In areas where noisy power transmission is present, you may choose to install a line filter to shield the computer from noise. It is recommended that you also install a power surge protector to help avoid problems caused by power surges.

Chapter 2

Installation

2.1 Static-Sensitive Devices

Electrostatic Discharge (ESD) can damage electronic components. To avoid damaging your system board, it is important to handle it very carefully. The following measures are generally sufficient to protect your equipment from ESD.

Precautions

- Use a grounded wrist strap designed to prevent static discharge.
- Touch a grounded metal object before removing the board from the antistatic bag.
- Handle the motherboard by its edges only; do not touch its components, peripheral chips, memory modules or gold contacts.
- When handling chips or modules, avoid touching their pins.
- Put the motherboard and peripherals back into their antistatic bags when not in use.
- For grounding purposes, make sure that your computer chassis provides excellent conductivity between the power supply, the case, the mounting fasteners and the motherboard.
- Use only the correct type of onboard CMOS battery. Do not install the onboard battery upside down to avoid possible explosion.

Unpacking

The motherboard is shipped in antistatic packaging to avoid static damage. When unpacking the motherboard, make sure that the person handling it is static protected.

2.2 Processor and Heatsink Installation

Warning: When handling the processor package, avoid placing direct pressure on the label area of the fan.



Important:

- Use ESD protection.
- Unplug the AC power cord from all power supplies after shutting down the system.
- Check that the plastic protective cover is on the CPU socket and none of the socket pins are bent. If they are, contact your retailer.
- When handling the processor, avoid touching or placing direct pressure on the LGA lands (gold contacts). Improper installation or socket misalignment can cause serious damage to the processor or CPU socket, which may require manufacturer repairs.
- Thermal grease is pre-applied on a new heatsink. No additional thermal grease is needed.
- Refer to the Supermicro website for updates on processor support.
- All graphics in this manual are for illustrations only. Your components may look different.

Installing the LGA1200 Processor

1. Press the load lever down to release the load plate from its locking position.

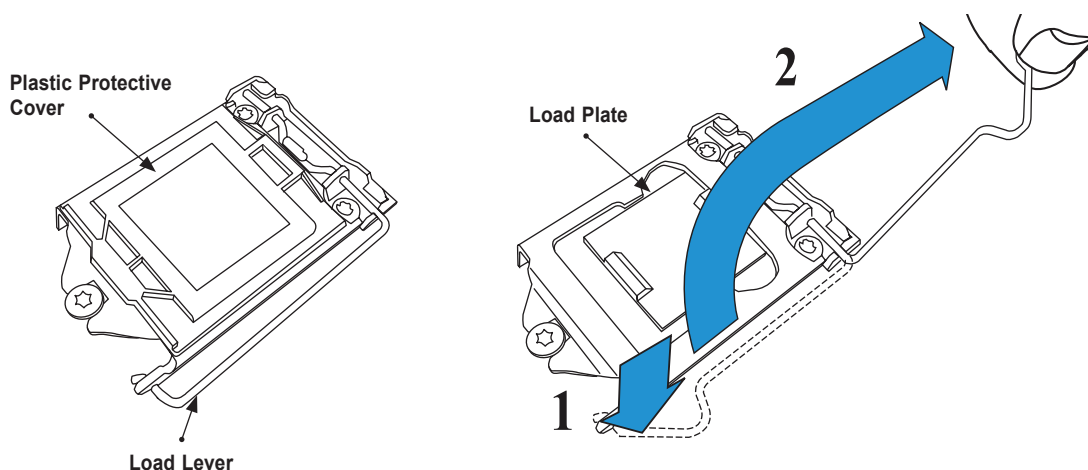

2. Gently lift the load lever to open the load plate. Remove the plastic protective cover. Do not touch the CPU socket contacts.

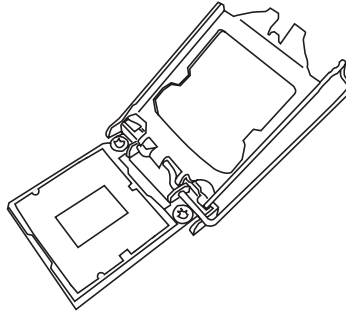

3. Locate the triangle on the CPU and CPU socket, which indicates the location of Pin 1. Holding the CPU by the edges with your thumb and index finger, align the triangle on the CPU with the triangle on the socket. The CPU keys (the semi-circle cutouts) may also be aligned against the socket keys as a guide.

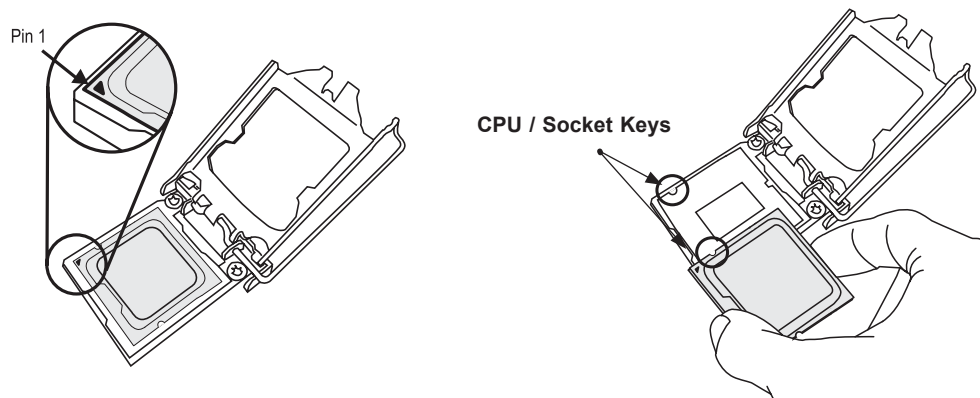

4. Carefully lower the CPU straight down into the socket. Do not drop the CPU on the socket, or move it horizontally or vertically to avoid damaging the CPU or socket. Inspect the four corners of the CPU to make sure that the CPU is properly installed.

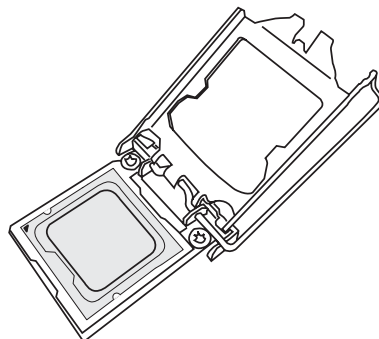

5. Close the load plate, then gently push down the load lever into its locking position.

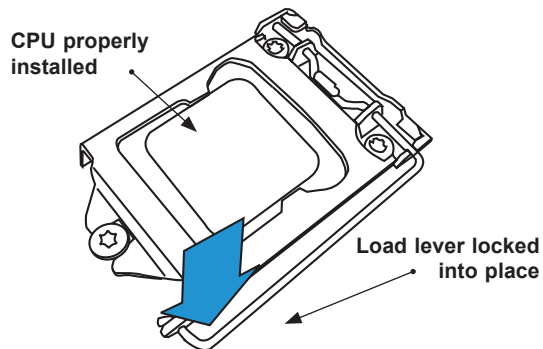

 **Note:** You can only install the CPU in one direction. Make sure it is properly inserted into the socket before closing the load plate. If it doesn't close properly, do not force it as it may damage your CPU. Instead, open the load plate again and double-check that the CPU is properly aligned.

Installing an Active CPU Heatsink with Fan

1. Locate the CPU fan header on the motherboard (FAN1: CPU FAN).
2. Position the heatsink so that the heatsink fan wires are closest to the CPU fan header and are not interfering with other components.
3. Inspect the CPU fan wires to make sure they are routed through the bottom of the heatsink.
4. Remove the thin layer of protective film from the heatsink. CPU overheating may occur if the protective film is not removed from the heatsink.
5. Apply the proper amount of thermal grease on the CPU. If your heatsink came with a thermal pad, please ignore this step.

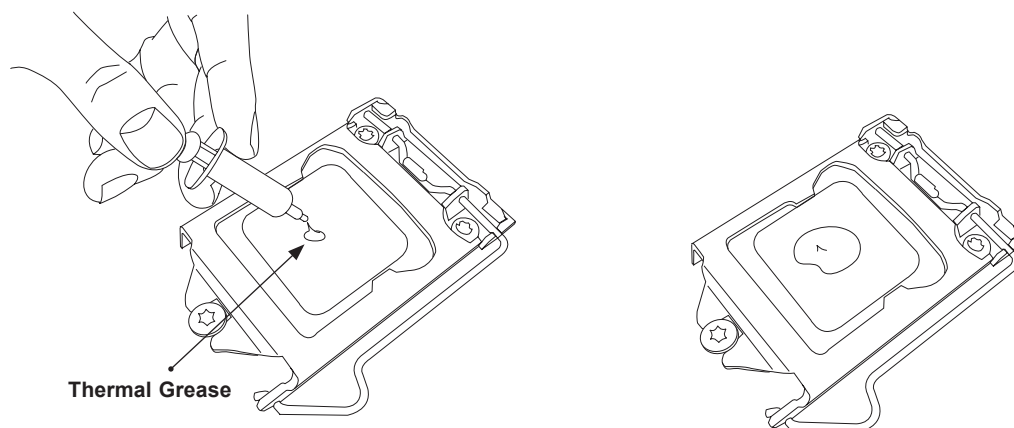

6. Align the four heatsink fasteners with the mounting holes on the motherboard. Gently push down the fasteners in a diagonal order (Example: #1 and #2, then #3 and #4) into the mounting holes until you hear a click. Then lock the fasteners by turning each one 90° clockwise.

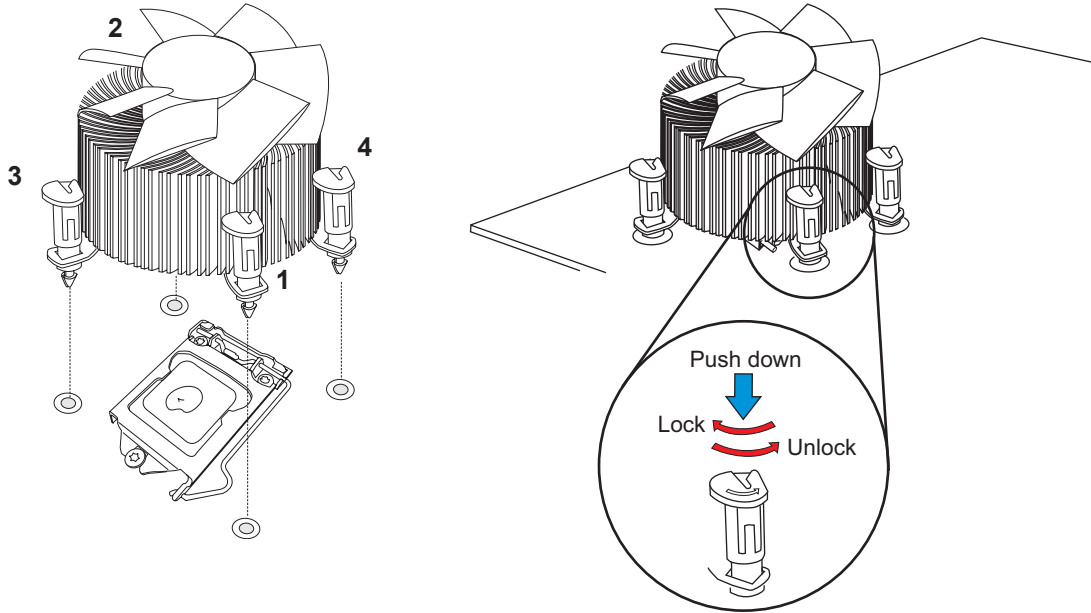

7. Once all four fasteners are secured, connect the heatsink fan wire connector to the CPU fan header.

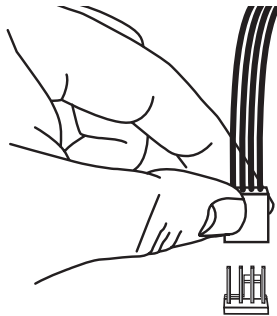

Removing the Heatsink

 **Note:** We do not recommend that the CPU or heatsink be removed. However, if you do need to remove the heatsink, please follow the instructions below to remove the heatsink and prevent damage done to the CPU or other components.

1. Unplug the power connector from the power supply.
2. Disconnect the heatsink fan connector from the CPU fan header.
3. Gently press down each fastener cap and turn them 90° counter clockwise, then pull the fasteners upwards to loosen them.
4. Remove the heatsink from the CPU.

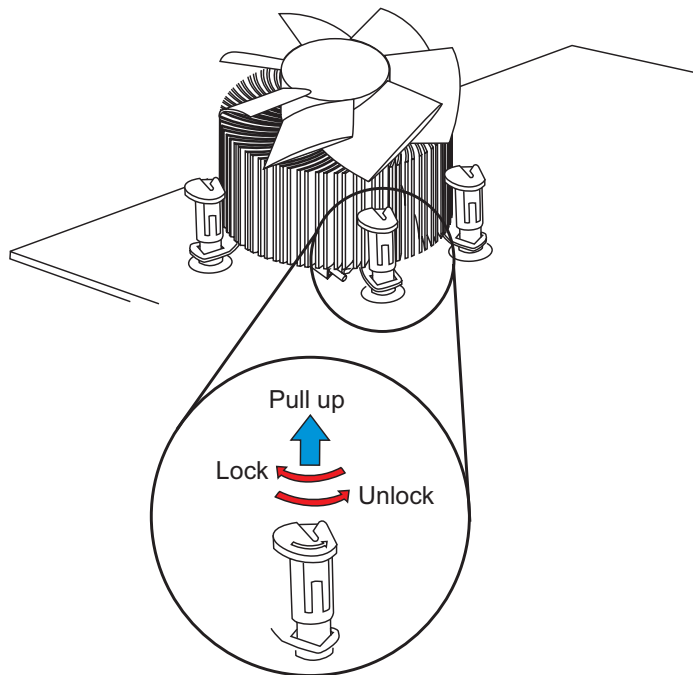

2.3 Motherboard Installation

All motherboards have standard mounting holes to fit different types of chassis. Make sure that the locations of all the mounting holes for both the motherboard and the chassis match. Although a chassis may have both plastic and metal mounting fasteners, metal ones are highly recommended because they ground the motherboard to the chassis. Make sure that the metal standoffs click in or are screwed in tightly.

Tools Needed

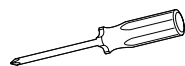

**Phillips
Screwdriver
(1)**



**Phillips Screws
(8)**



**Standoffs (8)
Only if Needed**

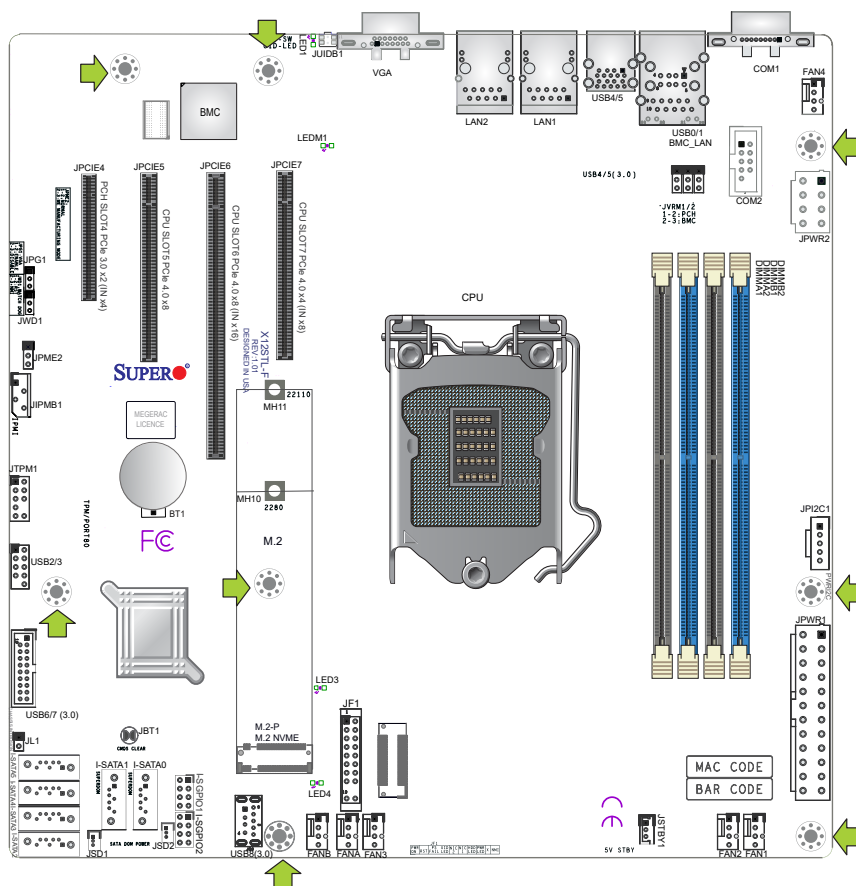

Location of Mounting Holes



Note: 1) To avoid damaging the motherboard and its components, please do not use a force greater than 8 lbf-in on each mounting screw during motherboard installation. 2) Some components are very close to the mounting holes. Please take precautionary measures to avoid damaging these components when installing the motherboard to the chassis.

Installing the Motherboard

1. Locate the mounting holes on the motherboard and the mounting tray. Refer to the previous page for the mounting holes.
2. Install the standoffs on the mounting tray. Align the mounting holes on the motherboard against the mounting holes on the tray.

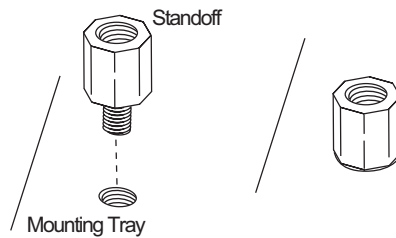

3. Using the Phillips screwdriver, insert a Phillips head #6 screw into a mounting hole on the motherboard and its matching hole on the tray.

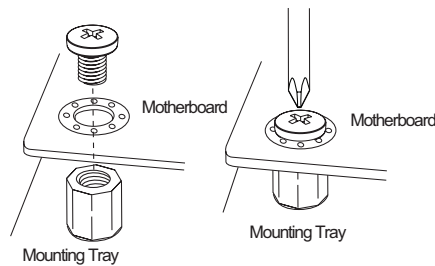

4. Repeat step 2 to insert #6 screws to all mounting holes located on the motherboard and tray and securely install the motherboard onto the tray.

2.4 Memory Support and Installation



Note: Check the Supermicro website for recommended memory modules.



Important: Exercise extreme care when installing or removing DIMM modules to prevent any possible damage.

Memory Support

The X12STL-F supports up to 128GB of ECC UDIMM memory with speeds of up to 3200MHz in four memory slots. Speed support is up to 2666MHz when a Pentium processor is installed. Speed support is up to 2933 MT/s for 2R2R configurations. Refer to the table below for the recommended DIMM population order.

Recommended Population (Balanced)				
DIMMA1	DIMMB1	DIMMA2	DIMMB2	Total System Memory
		4GB	4GB	8GB
4GB	4GB	4GB	4GB	16GB
		8GB	8GB	16GB
8GB	8GB	8GB	8GB	32GB
		16GB	16GB	32GB
16GB	16GB	16GB	16GB	64GB
		32GB	32GB	64GB
32GB	32GB	32GB	32GB	128GB

General Guidelines for Optimizing Memory Performance

- The blue slots must be populated first.
- Always use DDR4 memory of the same type, size, and speed.
- The motherboard will support odd-numbered modules (one or three modules installed). However, to achieve the best memory performance, a balanced memory population is recommended.

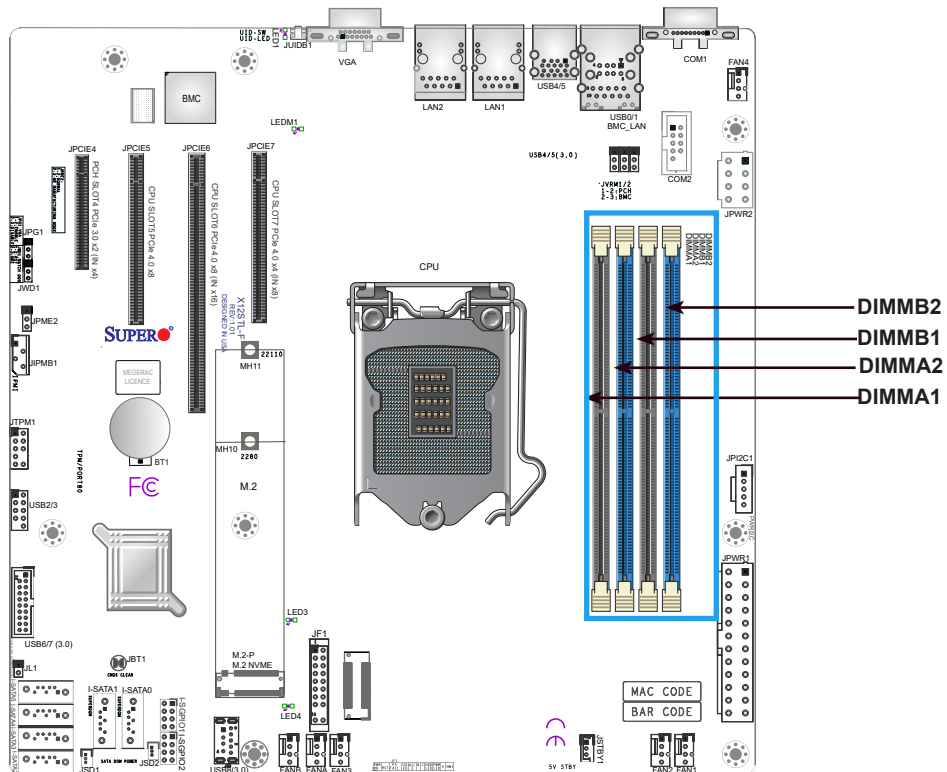

DIMM Installation

1. Insert DIMM modules in the following order: DIMMB2, DIMMA2, then DIMMB1, DIMMA1. For the system to work properly, please use memory modules of the same type and speed.
2. Push the release tabs outwards on both ends of the DIMM slot to unlock it.
3. Align the key of the DIMM module with the receptive point on the memory slot.
4. Align the notches on both ends of the module against the receptive points on the ends of the slot.
5. Push both ends of the module straight down into the slot until the module snaps into place.
6. Press the release tabs to the lock positions to secure the DIMM module into the slot.

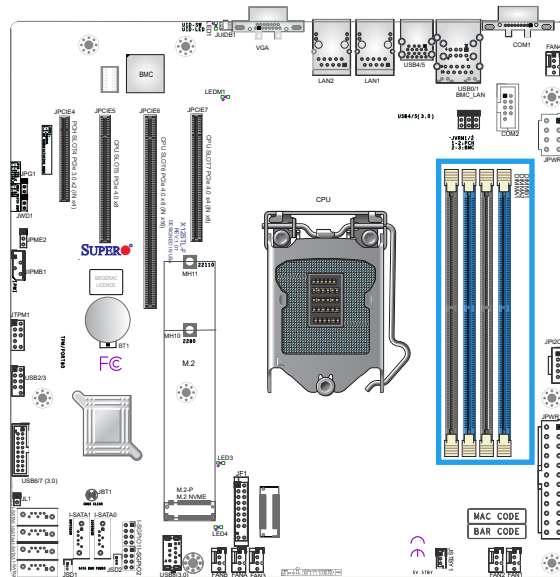

DIMM Removal

Press both release tabs on the ends of the DIMM module to unlock it. Once the DIMM module is loosened, remove it from the memory slot.

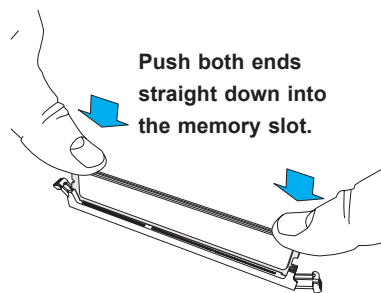
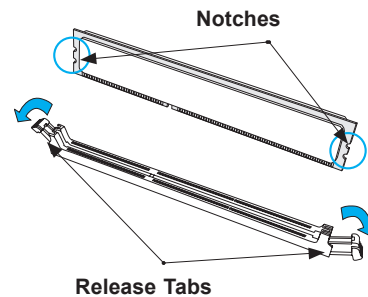
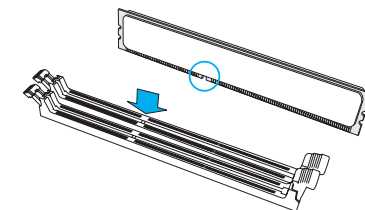

2.5 Rear I/O Ports

See Figure 2-1 below for the locations and descriptions of the various I/O ports on the rear of the motherboard.

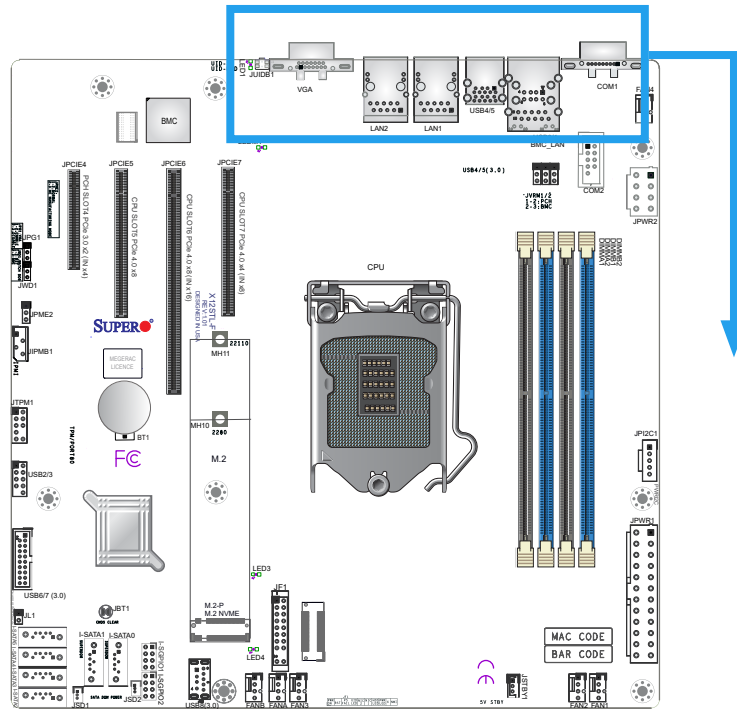
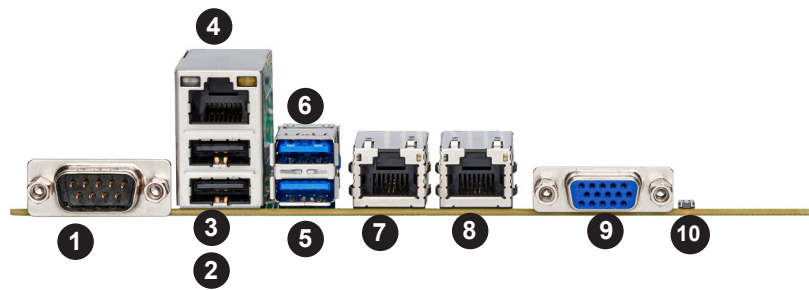

Figure 2-1. Rear I/O Port Locations and Definitions



Rear I/O Ports			
#	Description	#	Description
1	COM Port 1	6	USB5 (3.2 Gen1)
2	USB0 (2.0)	7	LAN1
3	USB1 (2.0)	8	LAN2
4	Dedicated BMC LAN	9	VGA Port
5	USB4 (3.2 Gen1)	10	UID Switch

VGA Port

A video (VGA) port is located next to LAN2 on the I/O back panel. Refer to the board layout below for the location.

COM Ports

There are two COM connections on this motherboard. COM1 is located on the I/O back panel. COM2 is located next to MH1.

COM Port Pin Definitions			
Pin#	Definition	Pin#	Definition
1	DCD	6	DSR
2	RXD	7	RTS
3	TXD	8	CTS
4	DTR	9	RI
5	Ground	10	N/A

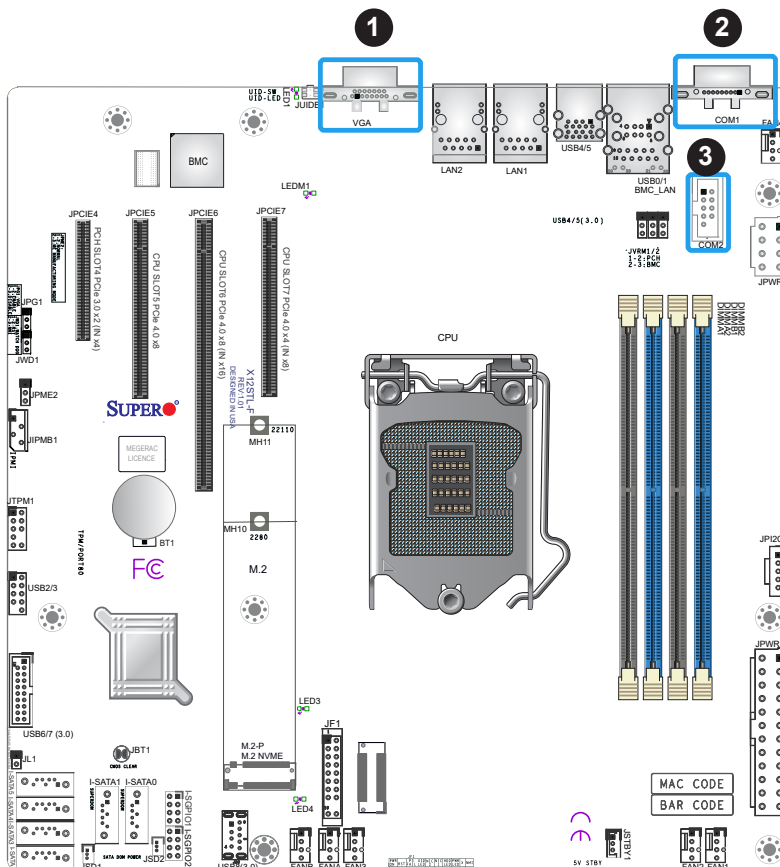

1. VGA Port
2. COM1
3. COM2

LAN Ports

Two Gigabit Ethernet ports (LAN1, LAN2) are located on the I/O back panel. In addition to the LAN ports, a dedicated BMC LAN is located next to the USB0/1 ports on the back panel. All these ports accept RJ45 cables. Please refer to the LED Indicator section for LAN LED information.

LAN Port Pin Definition			
Pin#	Definition	Pin#	Definition
1	TRD1P	11	TRD4N
2	TRD1N	12	TRCT4
3	TRCT1	13	TRD5P
4	TRD2P	14	TRD5N
5	TRD2N	15	L1-GRE-
6	TRCT2	16	L1-GRE+
7	TRD3P	17	L2-YEL-
8	TRD3N	18	COMMON
9	TRCT3	19	L2-GRE-
10	TRD4P	20	CG1
		21	CG2

BMC LAN Pin Definition			
Pin#	Definition	Pin#	Definition
9		19	GND
10	TD0+	20	Act LED (Yellow)
11	TD0-	21	Link 100 LED (Green)
12	TD1+	22	Link 1000 LED (Amber)
13	TD1-	23	SGND
14	TD2+	24	SGND
15	TD2-	25	SGND
16	TD3+	26	SGND
17	TD3-		
18	GND		

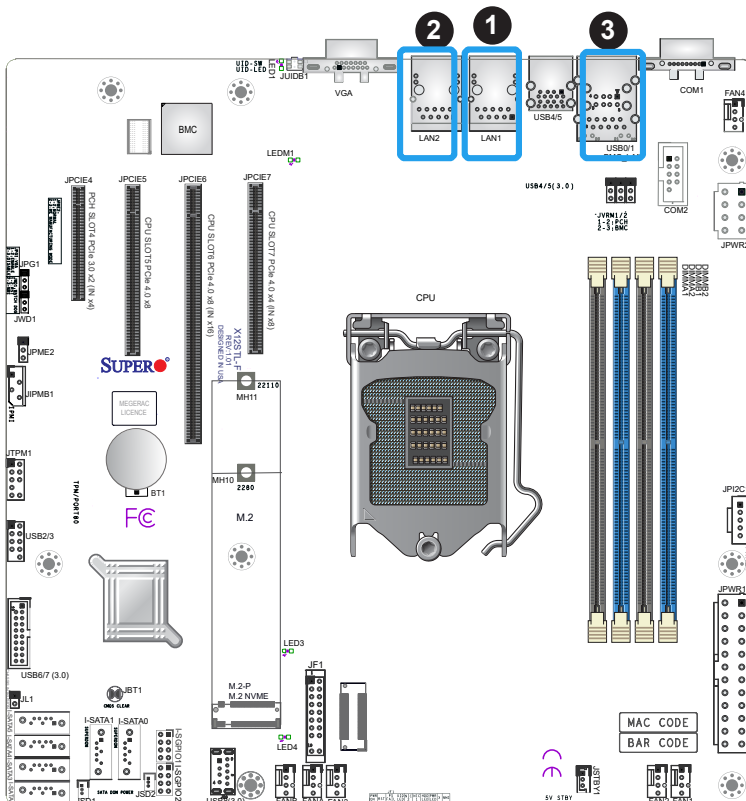

1. LAN1
2. LAN2
3. BMC LAN

Universal Serial Bus (USB) Ports

The motherboard has four USB 2.0 ports: two on the back panel (USB0/1) and two via headers (USB2/3), along with five USB 3.2 Gen1 connectors: two on the back panel (USB4/5), one Type-A (USB8) and two front accessible ports via headers (USB6/7).

Back Panel USB0/1 (2.0) Pin Definitions			
Pin#	Definition	Pin#	Definition
1	+5V	5	+5V
2	USB_N	6	USB_N
3	USB_P	7	USB_P
4	Ground	8	Ground

Back Panel USB2/3 (2.0) Header Pin Definitions			
Pin#	Definition	Pin#	Definition
1	+5V	2	+5V
3	USB_N	4	USB_N
5	USB_P	6	USB_P
7	GND	8	GND
9	Key	10	NC

Type A USB8 (3.2 Gen 1) Pin Definitions			
Pin#	Definition	Pin#	Definition
1	VBUS	5	SSRX-
2	USB_N	6	SSRX+
3	USB_P	7	GND
4	GND	8	SSTX-
		9	SSTX+

Back Panel USB4/5 (3.2 Gen 1) Pin Definitions			
Pin#	Definition	Pin#	Definition
A1	VBUS	B1	Power
A2	D-	B2	USB_N
A3	D+	B3	USB_P
A4	GND	B4	GND
A5	Stda_SSRX-	B5	USB3_RN
A6	Stda_SSRX+	B6	USB3_RP
A7	GND	B7	GND
A8	Stda_SSTX-	B8	USB3_TN
A9	Stda_SSTX+	B9	USB3_TP

Front Panel USB6/7 (3.2 Gen 1) Header Pin Definitions			
Pin#	Definition	Pin#	Definition
1	VBUS		
2	Stda_SSRX-	19	VBUS
3	Stda_SSRX+	18	Stda_SSRX-
4	GND	17	Stda_SSRX+
5	Stda_SSRX-	16	GND
6	Stda_SSRX+	15	Stda_SSRX-
7	GND	14	Stda_SSRX+
8	USB_N	13	GND
9	USB_P	12	USB_N
10	GND	11	USB_P

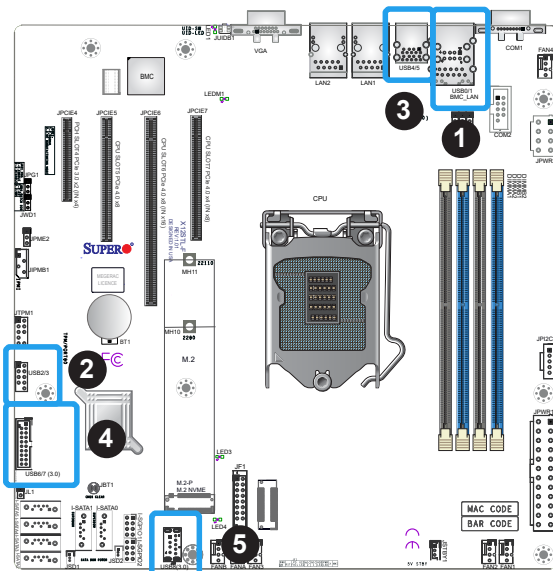

1. USB0/1 (2.0)
2. USB2/3 (USB 2.0)
3. USB4/5 (3.2)
4. USB6/7 (3.2)
5. USB8 (3.2 Type-A)

Unit Identifier Switch/UID LED Indicator

A Unit Identifier (UID) switch and an LED indicator are located on the motherboard. The UID switch is located at UID SW. The UID switch is located at JUIDB1, which is next to the VGA port on the back panel. The UID LED (LED1) is located next to the UID switch. When you press the switch, the LED will be turned on, which provides easy identification of a system unit that may be in need of service. Press the switch again to turn off the LED indicator.

 **Note:** UID can also be triggered via BMC on the motherboard. For more information on BMC, please refer to the BMC User's Guide posted on our website at <http://www.supermicro.com/support/manuals/>.

UID LED	
Pin Definitions	
Color	Status
Blue: On	Unit Identified

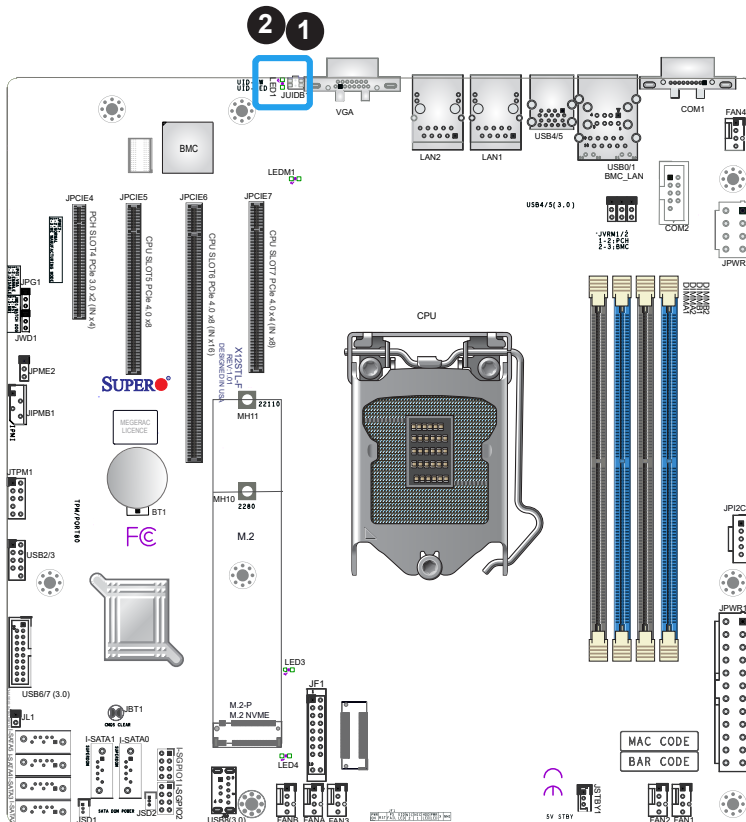

1. UID Switch
2. UID LED

2.6 Front Control Panel

The front control panel header (JF1) contains header pins for various buttons and indicators that are normally located on a control panel at the front of the chassis. These connectors are designed specifically for use with Supermicro chassis. See the figure below for the descriptions of the front control panel buttons and LED indicators.

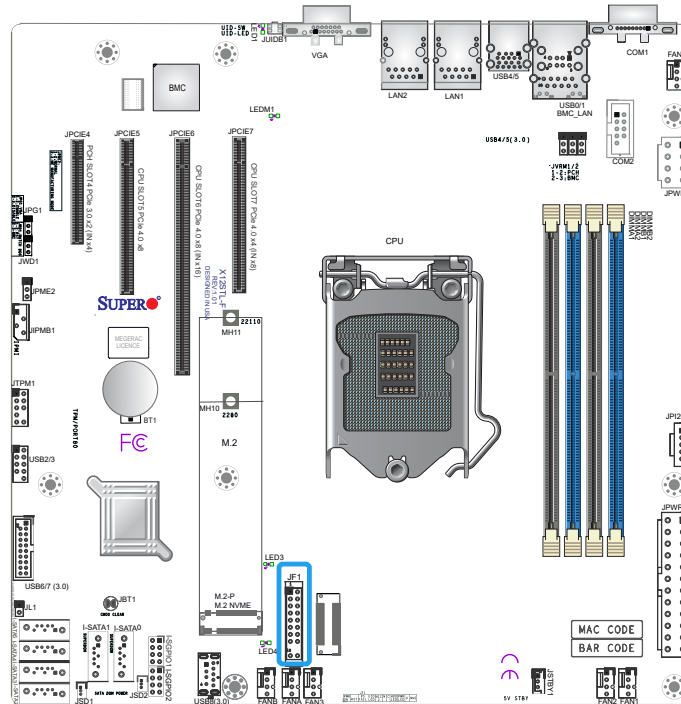

Figure 2-2. JF1 Header Pins

	1	2	
PWR } Power Button	○	○	Ground
Reset } Reset Button	○	○	Ground
3.3V	○	○	Power Fail LED
UID LED	○	○	OH/Fan Fail/PWR Fail LED
3.3V Stby	○	○	NIC2 Active LED
3.3V Stby	○	○	NIC1 Active LED
3.3V Stby	○	○	HDD LED
3.3V Stby	○	○	PWR LED
X	○	○	X
NMI	○	○	Ground
	19	20	

Power Button

The Power Button connection is located on pins 1 and 2 of JF1. Momentarily contacting both pins will power on/off the system. Refer to the table below for pin definitions.

Power Button Pin Definitions (JF1)	
Pin#	Definition
1	Signal
2	Ground

Reset Button

The Reset Button connection is located on pins 3 and 4 of JF1. Momentarily contacting both pins will reset the system. Refer to the table below for pin definitions.

Reset Button Pin Definitions (JF1)	
Pin#	Definition
3	Reset
4	Ground

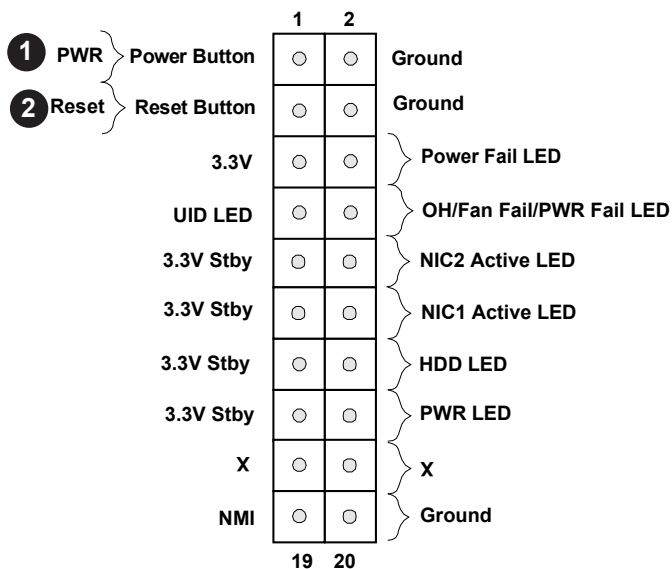

1. PWR Button
2. Reset Button

Power Fail LED

The Power Fail LED connection is located on pins 5 and 6 of JF1. Refer to the table below for pin definitions.

Power Fail LED Pin Definitions (JF1)	
Pin#	Definition
5	3.3V
6	PWR Supply Fail

Information LED (OH/Fan Fail/PWR Fail/UID LED)

The Information LED (OH/Fan Fail/PWR Fail/UID LED) connection is located on pins 7 and 8 of JF1. The LED on pin 7 is active when the UID switch on the rear I/O panel is pressed. The LED on pin 8 provides warnings of overheat, power failure, or fan failure. Refer to the tables below for more information.

Information LED-UID/OH/PWR Fail/Fan Fail LED Pin Definitions (Pin 7 & Pin 8 of JF1)	
Status	Description
Solid red	An overheat condition has occurred. (This may be caused by cable congestion).
Blinking red (1Hz)	Fan failure: check for an inoperative fan.
Blinking red (0.25Hz)	Power failure: check for a non-operational power supply
Solid blue	Local UID is activated. Use this function to locate a unit in a rack mount environment that might be in need of service.
Blinking blue (300 msec)	Remote UID is on. Use this function to identify a unit from a remote location that might be in need of service.

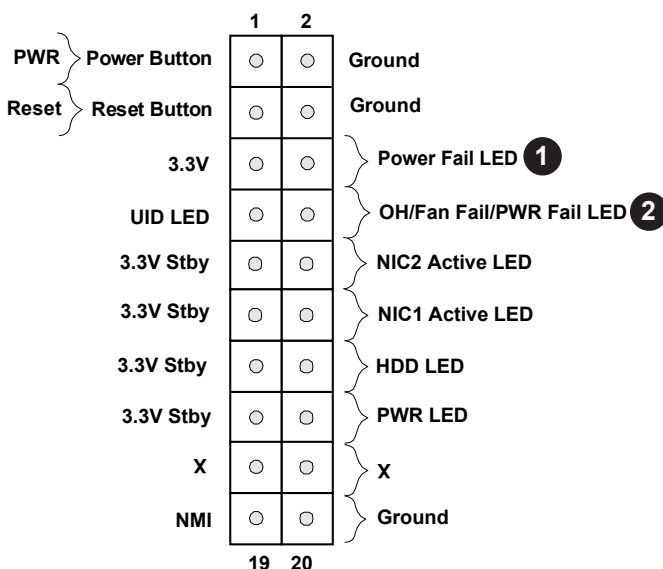

1. Power Fail LED
2. Information LED

NIC1/NIC2 (LAN1/LAN2)

The Network Interface Controller (NIC) LED connection for LAN port 1 is located on pins 11 and 12 of JF1, and LAN port 2 is on pins 9 and 10. Attach the NIC LED cables here to display network activity. Refer to the table below for pin definitions.

LAN1/LAN2 LED Pin Definitions (JF1)	
Pin#	Definition
9	NIC 2 Activity LED
11	NIC 1 Activity LED

HDD LED

The HDD LED connection is located on pins 13 and 14 of JF1. Attach a cable to pins 13 and 14 to show hard drive activity status. Refer to the table below for pin definitions.

HDD LED Pin Definitions (JF1)	
Pins	Definition
13	3.3V Stdby
14	HDD Active

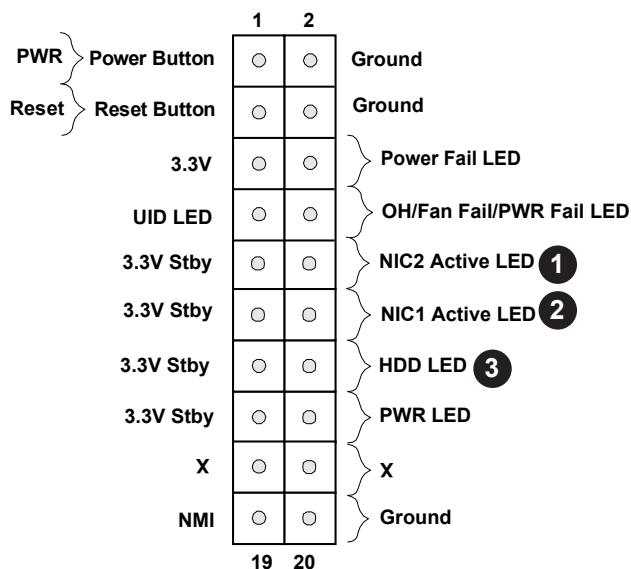

1. NIC2 LED
2. NIC1 LED
3. HDD LED

Power LED

The Power LED connection is located on pins 15 and 16 of JF1. Refer to the table below for pin definitions.

Power LED Pin Definitions (JF1)	
Pins	Definition
15	3.3V
16	PWR LED

NMI Button

The non-maskable interrupt (NMI) button header is located on pins 19 and 20 of JF1. Refer to the table below for pin definitions.

NMI Button Pin Definitions (JF1)	
Pins	Definition
19	Control
20	Ground

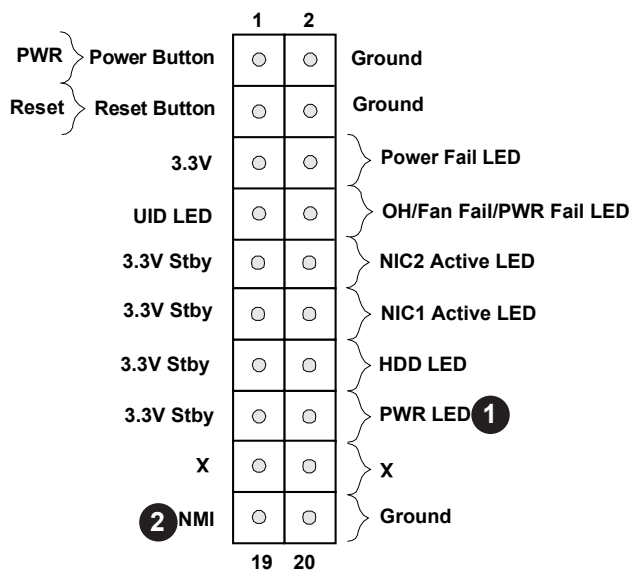

1. PWR LED
2. NMI

2.7 Connectors

Power Connections

ATX Power Supply Connector

The 24-pin power supply connector (JPWR1) meets the ATX SSI EPS 12V specification. You must also connect the 8-pin (JPWR2) processor power connector to the power supply.

ATX Power 24-pin Connector Pin Definitions			
Pin#	Definition	Pin#	Definition
13	+3.3V	1	+3.3V
14	-12V	2	+3.3V
15	Ground	3	Ground
16	PS_ON	4	+5V
17	Ground	5	Ground
18	Ground	6	+5V
19	Ground	7	Ground
20	Res (NC)	8	PWR_OK
21	+5V	9	5VSB
22	+5V	10	+12V
23	+5V	11	+12V
24	Ground	12	+3.3V

Required Connection

8-pin Power Pin Definitions	
Pin#	Definition
1 - 4	Ground
5 - 8	P12V (12V Power)

Required Connection

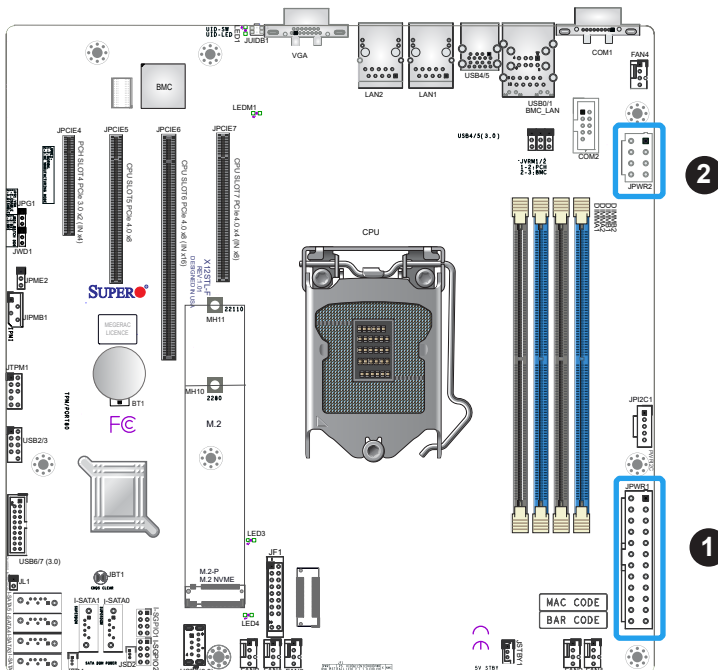

1. 24-Pin ATX PWR
2. 8-Pin PWR

Disk-On-Module Power Connector

There are two power connector for SATA DOM (Disk-On-Module) devices located at JSD1 and JSD2. Connect appropriate cables here to provide power support for your Serial Link DOM devices.

DOM Power Pin Definitions	
Pin#	Definition
1	5V
2	Ground
3	Ground

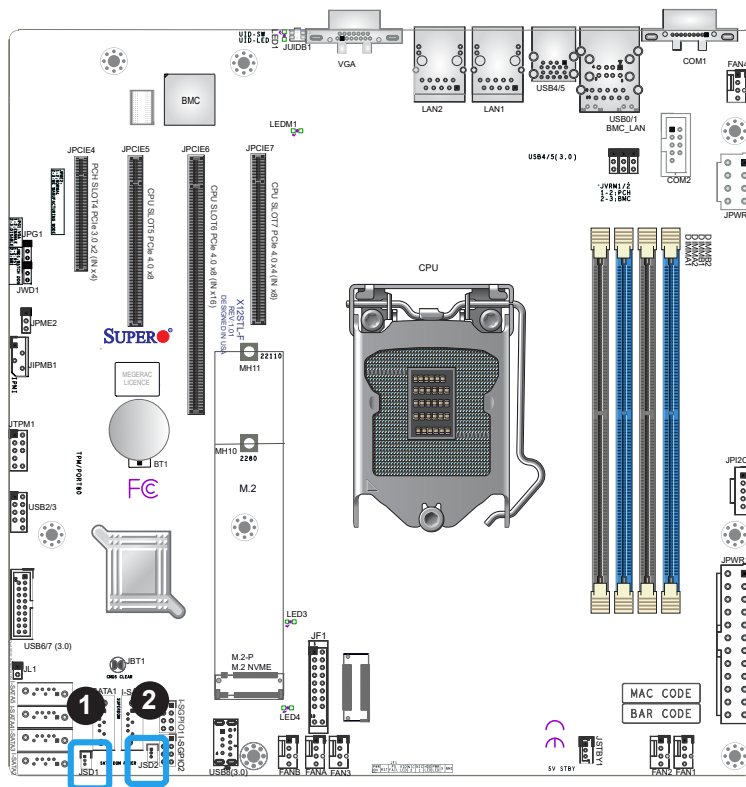

1. SATA DOM (JSD1)
2. SATA DOM (JSD2)

Headers

Fan Headers

There are six 4-pin fan headers (FAN1 ~ FAN4, FANA/B) on the motherboard. All these 4-pin fan headers are backwards compatible with the traditional 3-pin fans. However, fan speed control is available for 4-pin fans only by the Thermal Management via the IPMI 2.0 interface. Refer to the table below for pin definitions.

Fan Header Pin Definitions	
Pin#	Definition
1	Ground (Black)
2	2.5A/+12V (Red)
3	Tachometer
4	PWM_Control

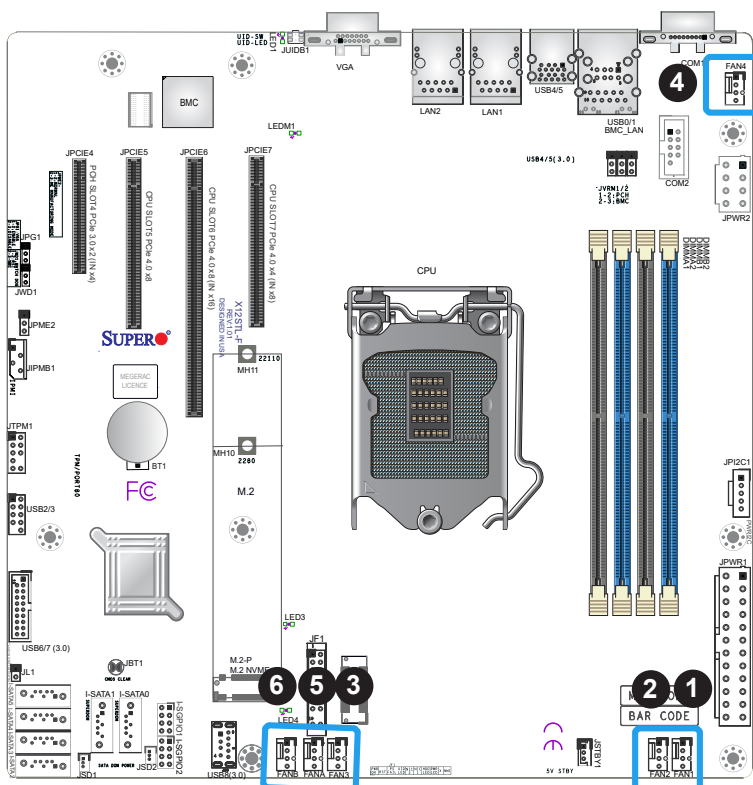

1. FAN1
2. FAN2
3. FAN3
4. FAN4
5. FANA
6. FANB

TPM Header

The JTPM1 header is used to connect a Trusted Platform Module (TPM)/Port 80, which is available from a third-party vendor. A TPM/Port 80 connector is a security device that supports encryption and authentication in hard drives. It allows the motherboard to deny access if the TPM associated with the hard drive is not installed in the system. Go to the following link for more information on the TPM: <http://www.supernmicro.com/manuals/other/TPM.pdf>.

Trusted Platform Module Header Pin Definitions			
Pin#	Definition	Pin#	Definition
1	+3.3V	2	SPI_CS#
3	RESET#	4	SPI_MISO
5	SPI_CLK	6	GND
7	SPI_MOSI	8	
9	+3.3V Stby	10	SPI_IRQ#

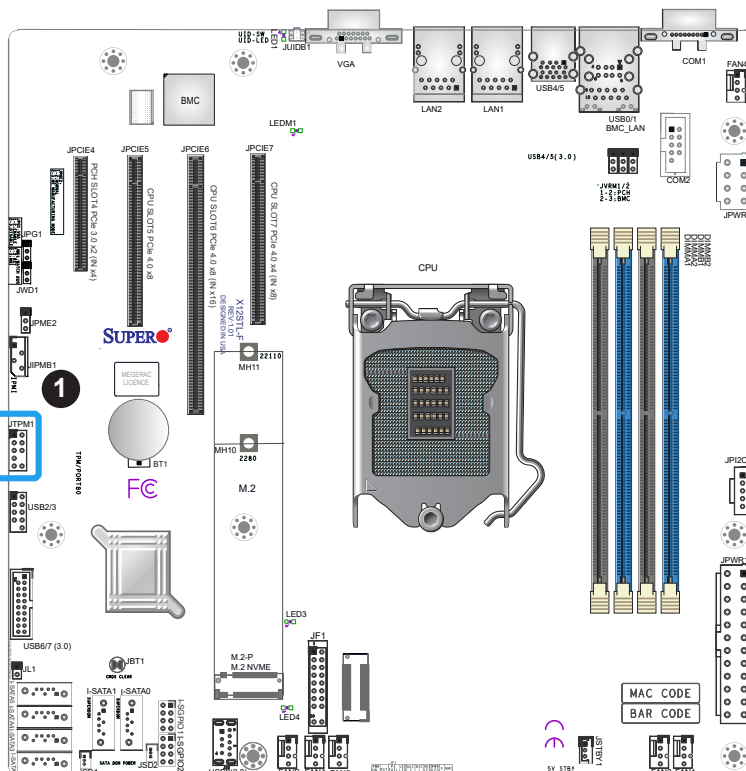

1. TPM Header

Standby Power

The Standby Power header is located at JSTBY1 on the motherboard. You must have a card with a Standby Power connector and a cable to use this feature. Refer to the table below for pin definitions.

Standby Power Pin Definitions	
Pin#	Definition
1	+5V Standby
2	Ground
3	No Connection

4-pin BMC External I²C Header

A system Management Bus header for IPMI 2.0 is located at JIPMB1. Connect the appropriate cable here to use the IPMB I²C connection on your system. Refer to the table below for pin definitions.

External I ² C Header Pin Definitions	
Pin#	Definition
1	Data
2	Ground
3	Clock
4	P3V3 STBY

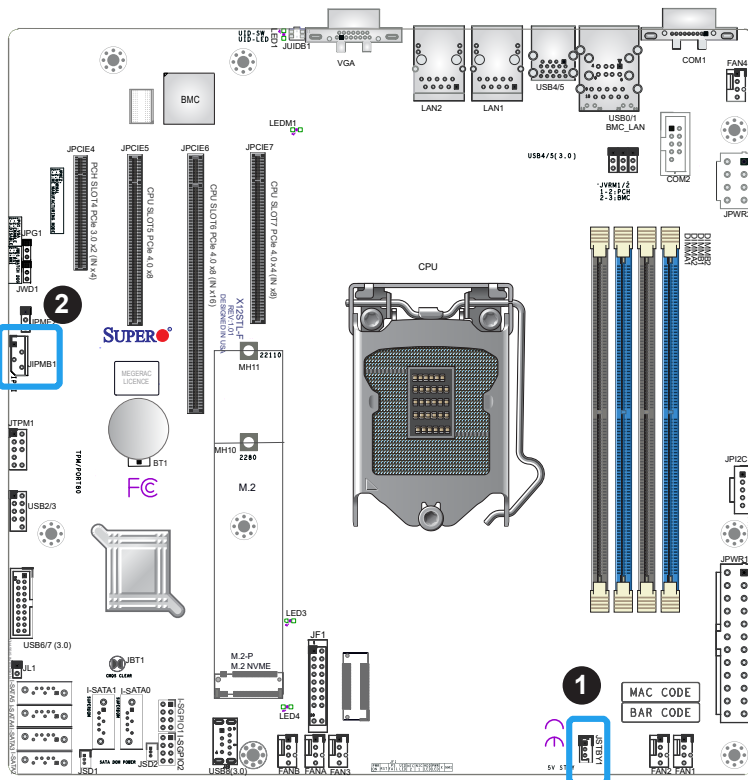

1. Standby Power
2. BMC External Header

Chassis Intrusion

A Chassis Intrusion header is located at JL1 on the motherboard. Attach the appropriate cable from the chassis to inform you of a chassis intrusion when the chassis is opened. Refer to the table below for pin definitions.

Chassis Intrusion Pin Definitions	
Pin#	Definition
1	Intrusion Input
2	Ground

SGPIO Headers

Two Serial Link General Purpose Input/Output headers (I-SGPIO1, I-SGPIO2) are located on the motherboard. They are used to communicate with the enclosure management chip on the backplane support the onboard I-SATA 3.0 ports. Refer to the table below for pin definitions.

S-SGPIO Header Pin Definitions			
Pin#	Definition	Pin#	Definition
1	NC	2	NC
3	Ground	4	Data
5	Load	6	Ground
7	Clock	8	NC

NC = No Connection

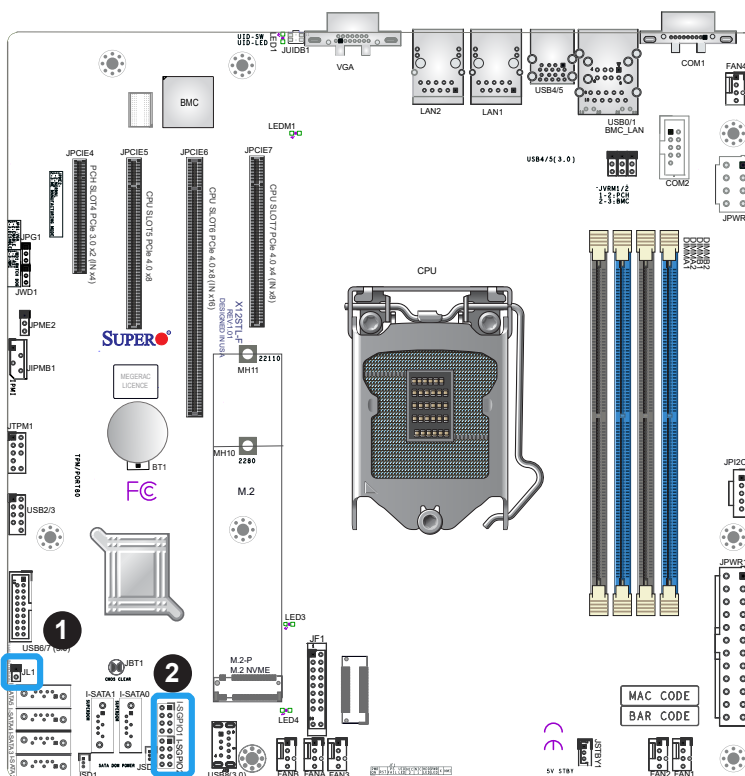

1. Chassis Intrusion
2. I-SGPIO1/2

M.2 Slot

This motherboard has one M.2 connector. M.2 was formerly known as Next Generation Form Factor (NGFF) and serves to replace mini PCIe. M.2 allows for a variety of card sizes, increased functionality, and spatial efficiency. The M.2 slot on this motherboard supports PCIe 3.0 x4 in the 2280 and 22110 form factors.

SATA Ports

Six Serial ATA (SATA) 3.0 connectors (I-SATA0-5) are located on the motherboard. These I-SATA 3.0 ports are supported by the Intel C252 PCH chip (supports RAID 0, 1, 5, and 10). SATA ports provide serial-link signal connections, which are faster than legacy Parallel ATA. Refer to the table below for pin definitions.

 **Note:** For more information on the SATA HostRAID configuration, refer to the Intel SATA HostRAID user's guide posted at <https://www.supermicro.com/support/manuals/>.

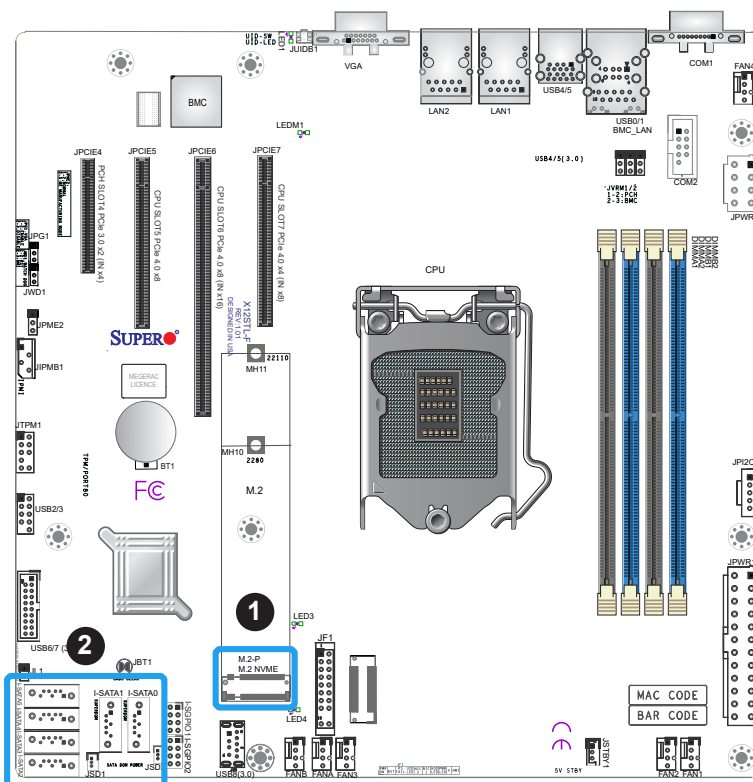

1. M.2 Slot
2. I-SATA0~5

Power SMB (I²C) Header

The Power System Management Bus (I²C) connector (JPI²C1) monitors the power supply, fan, and system temperatures. Refer to the table below for pin definitions.

Power SMB Header Pin Definitions	
Pin#	Definition
1	Clock
2	Data
3	PMBUS_Alert
4	Ground
5	+3.3V

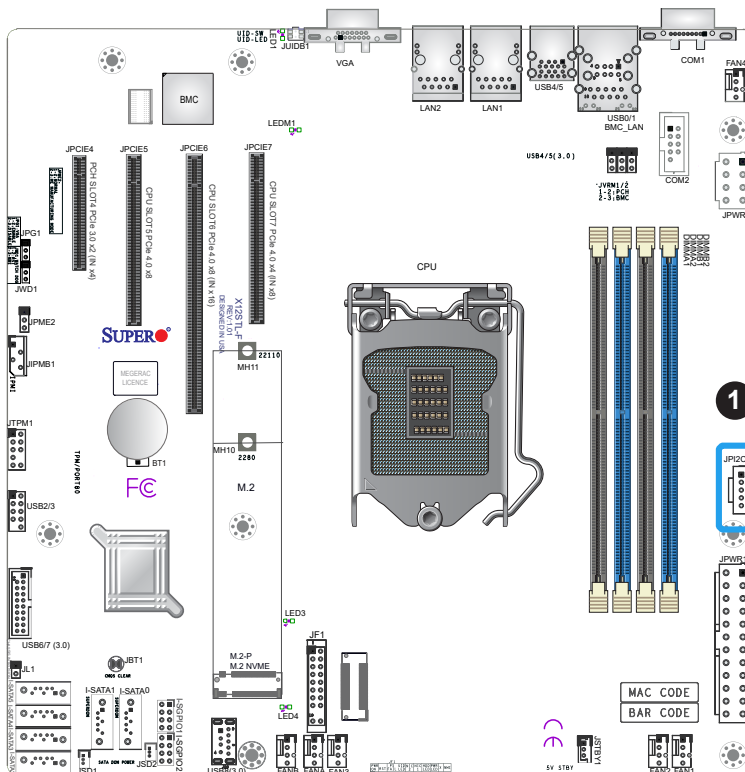

1. Power SMB Header

2.7 Jumper Settings

How Jumpers Work

To modify the operation of the motherboard, jumpers can be used to choose between optional settings. Jumpers create shorts between two pins to change the function of the connector. Pin 1 is identified with a square solder pad on the printed circuit board. See the diagram below for an example of jumping pins 1 and 2. Refer to the motherboard layout page for jumper locations.

 **Note:** On two-pin jumpers, Closed means the jumper is on the pins and Open means the jumper is off.

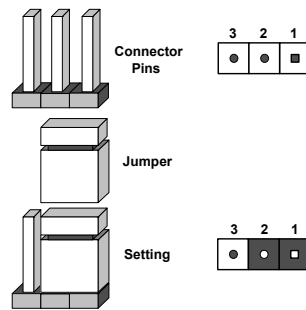

CMOS Clear

JBT1 is used to clear CMOS. Instead of pins, this jumper consists of contact pads to prevent accidentally clearing the contents of CMOS.

To Clear CMOS

1. First power down the system and unplug the power cord(s).
2. Remove the cover of the chassis to access the motherboard.
3. Remove the onboard battery from the motherboard.
4. Short the CMOS pads with a metal object such as a small screwdriver for at least four seconds.
5. Remove the screwdriver (or shorting device).
6. Replace the cover, reconnect the power cord(s), and power on the system.



Note: Clearing CMOS will also clear all passwords.



JBT1 contact pads

1. CMOS Clear

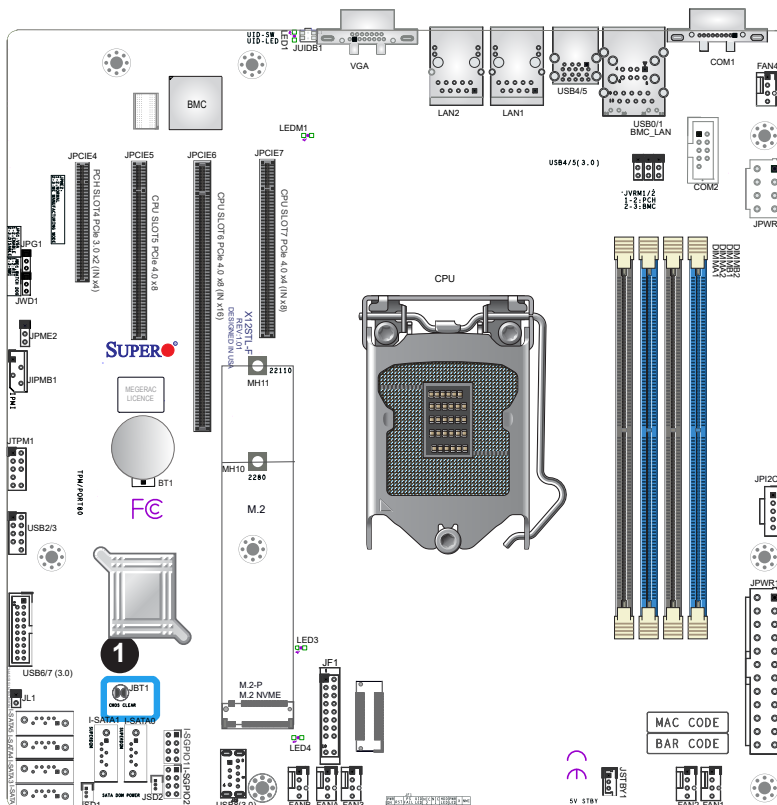

Watchdog

Watchdog (JWD1) is a system monitor that can reboot the system when a software application hangs. Close pins 1-2 to reset the system if an application hangs. Close pins 2-3 to generate a non-maskable interrupt (NMI) signal for the application that hangs. Refer to the table below for jumper settings. The Watchdog must also be enabled in the BIOS.

Watchdog Jumper Settings	
Jumper Setting	Definition
Pins 1-2	Reset (Default)
Pins 2-3	NMI
Open	Disabled

1. Watch Dog

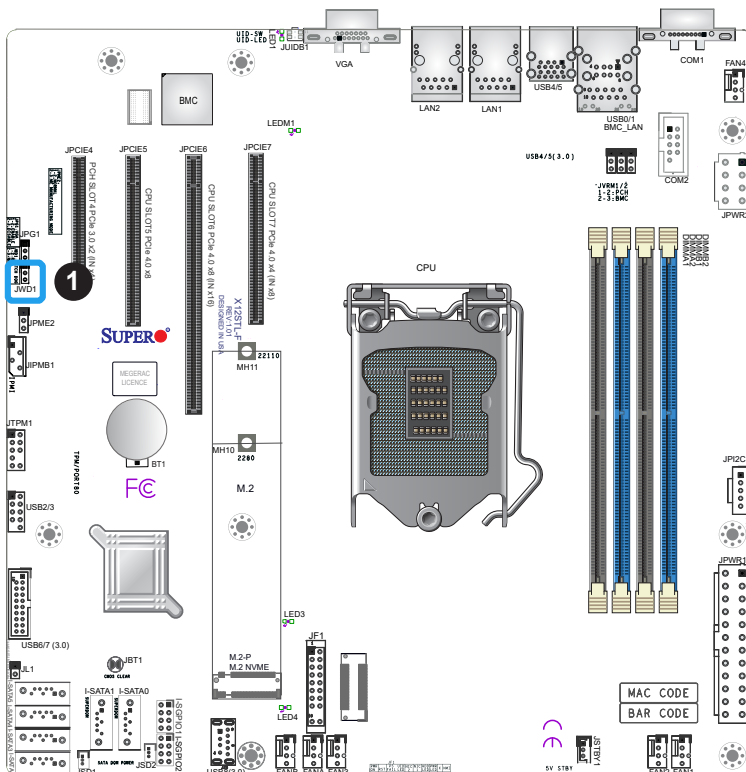

ME Manufacturing Mode

Close pins 2-3 of jumper JPME2 to bypass SPI flash security and force the system to operate in the manufacturing mode, which will allow the user to flash the system firmware from a host server for system setting modifications. Refer to the table below for jumper settings.

Manufacturing Mode Jumper Settings	
Jumper Setting	Definition
Pins 1-2	Normal (Default)
Pins 2-3	Manufacturing Mode

VGA Enable/Disable

Use jumper JPG1 to enable or disable the VGA port using the onboard graphics controller.

VGA Enable/Disable Jumper Settings	
Jumper Setting	Definition
Pins 1-2	Enabled (Default)
Pins 2-3	Disabled

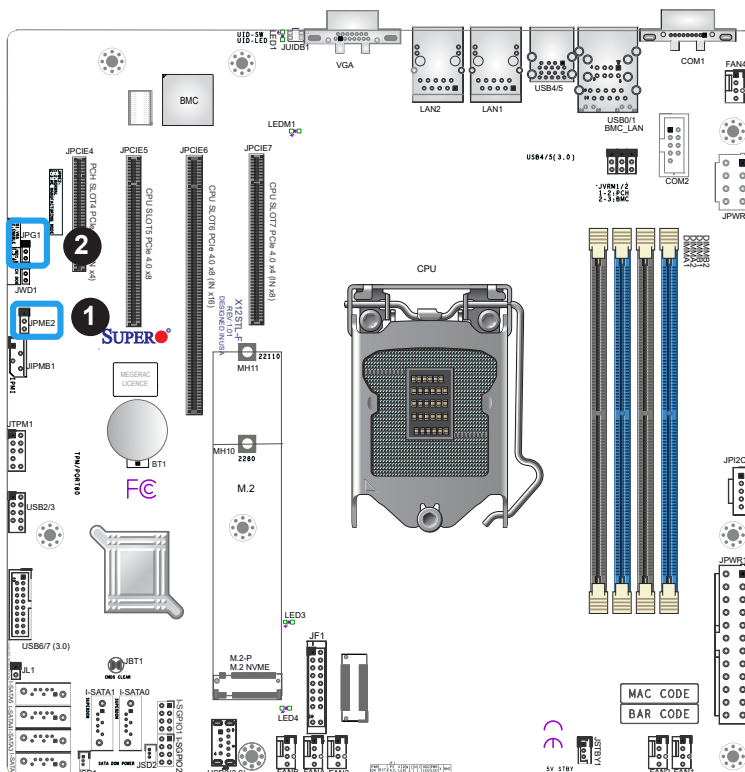

1. Manufacturing Mode
2. VGA Enable/Disable

2.8 LED Indicators

Onboard Power LED

LED4 is the onboard Power LED. When this LED is on, the system is on. Turn off the system and unplug the power cord before removing or installing components. Refer to the table below for more information.

Onboard Power LED Indicator	
LED Color	Definition
Off	System Off (power cable not connected)
Green	System On

BMC Heartbeat LED

LEDM1 is the BMC Heartbeat LED. When the LED is blinking green, BMC is working. Refer to the table below for the LED status.

BMC Heartbeat LED	
LED Color	Definition
Green: Blinking	BMC Normal

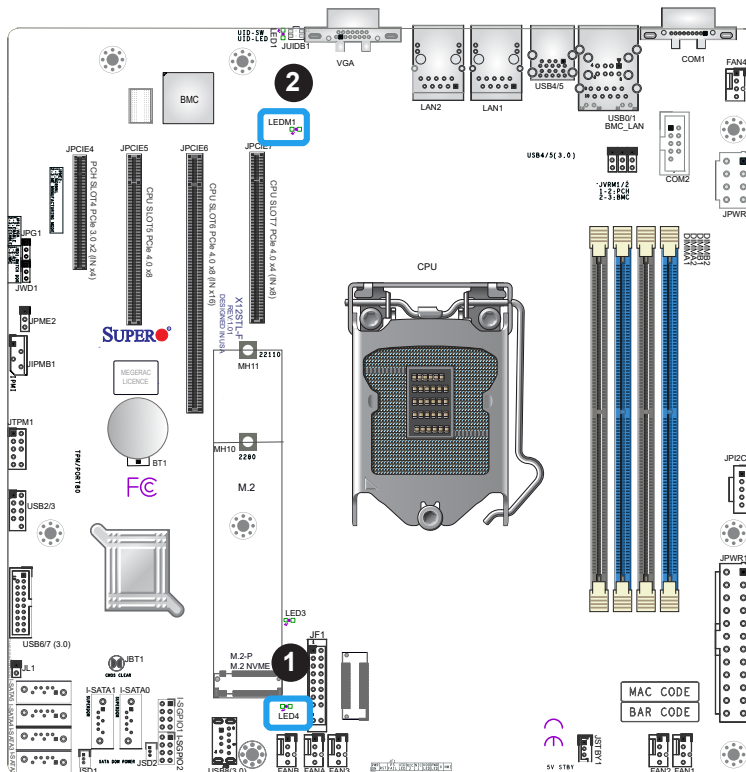

1. Onboard Power LED
2. BMC Heartbeat LED

Unit ID LED

A rear UID LED indicator (LED1) is located next to the UID switch on the motherboard. This UID indicator provides easy identification of a system unit that may need service.

UID LED LED Indicator	
LED Color	Definition
Blue: On	Unit Identified

M.2 LED

An M.2 LED is located at LED3 on the motherboard. When LED3 is blinking green, M.2 functions normally. Refer to the table below for more information.

M.2 LED State	
LED Color	Definition
Green: Blinking	Device Working

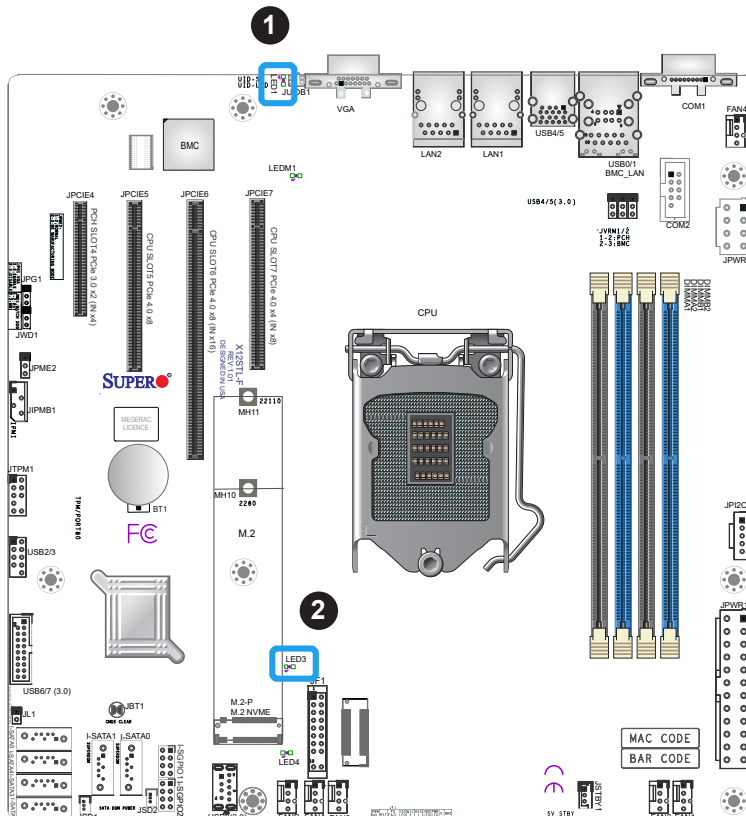

1. UID LED

2. M.2 LED

LAN LEDs

Two LAN ports (LAN 1 and LAN 2) are located on the rear I/O panel of the motherboard. Each Ethernet LAN port has two LEDs. The green LED indicates activity, while the other Link LED may be green, amber, or off to indicate the speed of the connection. Refer to the tables below for more information.

LAN1/2 Activity LED (Right)		
LED State		
Color	Status	Definition
Green	Flashing	Active

LAN1/2 Link LED (Left)	
LED State	
LED Color	Definition
Yellow/Amber	1Gbps

BMC LAN LEDs

In addition to LAN1 and LAN2, a BMC LAN is also located on the rear I/O panel. The amber LED on the right indicates activity, while the green LED on the left indicates the speed of the connection. Refer to the table below for more information.

BMC LAN LEDs		
	Color/State	Definition
Link (left)	Green: Solid Amber: Solid	100 Mbps 1Gbps
Activity (Right)	Amber: Blinking	Active

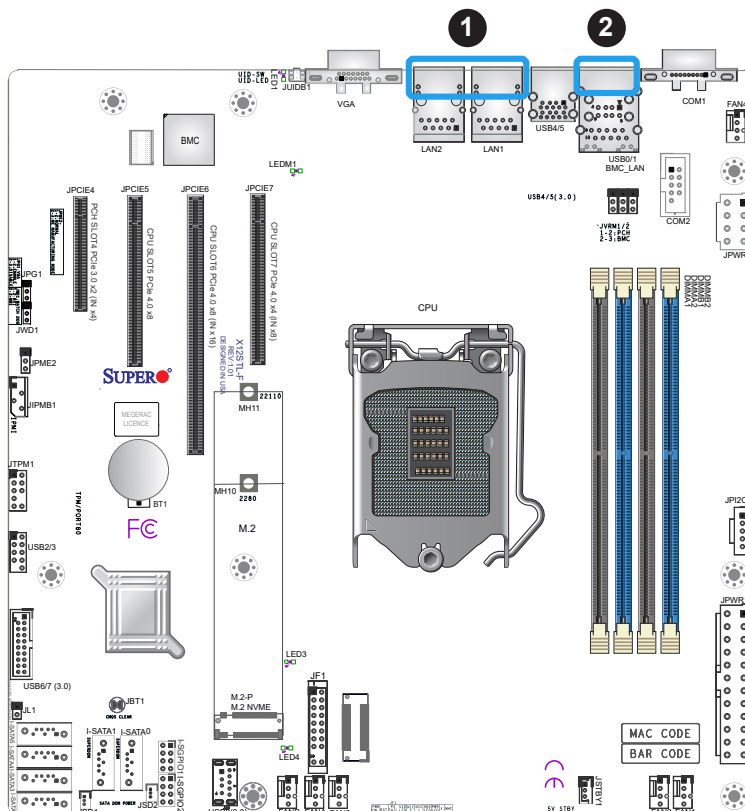
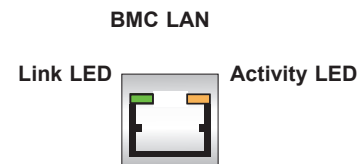

Chapter 3

Troubleshooting

3.1 Troubleshooting Procedures

Use the following procedures to troubleshoot your system. If you have followed all of the procedures below and still need assistance, refer to the 'Technical Support Procedures' and/or 'Returning Merchandise for Service' section(s) in this chapter. Always disconnect the AC power cord before adding, changing or installing any non hot-swap hardware components.

Before Power On

1. Make sure that there are no short circuits between the motherboard and chassis.
2. Disconnect all ribbon/wire cables from the motherboard, including those for the keyboard and mouse.
3. Remove all add-on cards.
4. Install the CPU (making sure it is fully seated) and connect the front panel connectors to the motherboard.

No Power

1. Make sure that there are no short circuits between the motherboard and the chassis.
2. Make sure that the ATX power connectors are properly connected.
3. Check that the 115V/230V switch, if available, on the power supply is properly set.
4. Turn the power switch on and off to test the system, if applicable.
5. The battery on your motherboard may be old. Check to verify that it still supplies ~3VDC. If it does not, replace it with a new one.

System Boot Failure

If the system does not display Power-On-Self-Test (POST) or does not respond after the power is turned on, check the following:

1. Check if any LEDs are lit.
2. Check if any fans are spinning.
3. If the LEDs are not lit or the fans are not spinning, then check the power supply connection or change the power supply. Clear the CMOS by shorting the JBT1 solder pads with a flathead screw driver for 20 seconds after unplugging the AC power.
4. If the BMC Heartbeat LED is lit, then verify if JPG1 is set to pins 1-2 to enable the VGA.
5. Check to make sure there are no bent pins in the CPU socket.
6. Verify the board outside the chassis to make sure there is no chassis short.
7. If all the steps above fail, then submit an RMA request.

Memory Errors

When suspecting faulty memory is causing the system issue, check the following:

1. Make sure that the memory modules are compatible with the system and are properly installed. See Chapter 2 for installation instructions. (For memory compatibility, refer to the "Tested Memory List" link on the motherboard's product page to see a list of supported memory.)
2. Check if different speeds of DIMMs have been installed. It is strongly recommended that you use the same RAM type and speed for all DIMMs in the system.
3. Make sure that you are using the correct type of ECC DDR4 modules recommended by the manufacturer.
4. Check for bad DIMM modules or slots by swapping a single module among all memory slots and check the results.

Losing the System's Setup Configuration

1. Make sure that you are using a high-quality power supply. A poor-quality power supply may cause the system to lose the CMOS setup information. Refer to Chapter 2 for details on recommended power supplies.
2. The battery on your motherboard may be old. Check to verify that it still supplies ~3VDC. If it does not, replace it with a new one.

3. If the above steps do not fix the setup configuration problem, contact your vendor for repairs.

When the System Becomes Unstable

A. If the system becomes unstable during or after OS installation, check the following:

1. CPU/BIOS support: Make sure that your CPU is supported and that you have the latest BIOS installed in your system.
2. Memory support: Make sure that the memory modules are supported by testing the modules using memtest86 or a similar utility.



Note: Click on the "Tested Memory List" link on the motherboard's product page to see a list of supported memory.

3. HDD support: Make sure that all hard disk drives (HDDs) work properly. Replace the bad HDDs with good ones.
4. System cooling: Check the system cooling to make sure that all heatsink fans and CPU/system fans, etc., work properly. Check the hardware monitoring settings in the BIOS to make sure that the CPU and system temperatures are within the normal range. Also check the front panel Overheat LED and make sure that it is not on.
5. Adequate power supply: Make sure that the power supply provides adequate power to the system. Make sure that all power connectors are connected. Please refer to our website for more information on the minimum power requirements.
6. Proper software support: Make sure that the correct drivers are used.

B. If the system becomes unstable before or during OS installation, check the following:

1. Source of installation: Make sure that the devices used for installation are working properly, including boot devices such as USB flash or media drives.
2. Cable connection: Check to make sure that all cables are connected and working properly.
3. Use the minimum configuration for troubleshooting: Remove all unnecessary components (starting with add-on cards first), and use the minimum configuration (but with the CPU and a memory module installed) to identify the trouble areas. Refer to the steps listed in Section A above for proper troubleshooting procedures.

4. Identify bad components by isolating them: If necessary, remove a component in question from the chassis, and test it in isolation to make sure that it works properly. Replace a bad component with a good one.
5. Check and change one component at a time instead of changing several items at the same time. This will help isolate and identify the problem.
6. To find out if a component is good, swap this component with a new one to see if the system will work properly. If so, then the old component is bad. You can also install the component in question in another system. If the new system works, the component is good and the old system has problems.

3.2 Technical Support Procedures

Before contacting Technical Support, please take the following steps. Also, please note that as a motherboard manufacturer, Supermicro also sells motherboards through its channels, so it is best to first check with your distributor or reseller for troubleshooting services. They should know of any possible problems with the specific system configuration that was sold to you.

1. Please go through the Troubleshooting Procedures and Frequently Asked Questions (FAQ) sections in this chapter or see the FAQs on our website (<http://www.supermicro.com/FAQ/index.php>) before contacting Technical Support.
2. BIOS upgrades can be downloaded from our website (http://www.supermicro.com/ResourceApps/BIOS_IPMI_Intel.html).
3. If you still cannot resolve the problem, include the following information when contacting Supermicro for technical support:
 - Motherboard model and PCB revision number
 - BIOS release date/version (This can be seen on the initial display when your system first boots up.)
 - System configuration
4. An example of a Technical Support form is on our website at <https://webpr3.supermicro.com/SupportPortal/>.
5. Distributors: For immediate assistance, please have your account number ready when placing a call to our Technical Support department. We can be reached by email at support@supermicro.com.

3.3 Frequently Asked Questions

Question: What type of memory does my motherboard support?

Answer: The motherboard supports up to 128GB of ECC UDIMM DDR4 memory with speeds of up to 3200MHz in four memory slots. To enhance memory performance, do not mix memory modules of different speeds and sizes. Please follow all memory installation instructions given on Section 2-4 in Chapter 2.

Question: How do I update my BIOS?

Answer: It is recommended that you do not upgrade your BIOS if you are not experiencing any problems with your system. Updated BIOS files are located on our website at http://www.supermicro.com/ResourceApps/BIOS_IPMI_Intel.html. Please check our BIOS warning message and the information on how to update your BIOS on our website. Select your motherboard model and download the BIOS file to your computer. Also, check the current BIOS revision to make sure that it is newer than your BIOS before downloading. Please unzip the BIOS file onto a bootable USB device. Run the batch file using the format FLASH.BAT filename.rom from your bootable USB device to flash the BIOS. Then, your system will automatically reboot.

Warning: Do not shut down or reset the system while updating the BIOS to prevent possible system boot failure!



Note: The SPI BIOS chip used on this motherboard cannot be removed. Send your motherboard back to our RMA Department at Supermicro for repair. For BIOS Recovery instructions, please refer to the AMI BIOS Recovery Instructions posted at <http://www.supermicro.com/support/manuals/>.

3.4 Battery Removal and Installation

Battery Removal

To remove the onboard battery, follow the steps below:

1. Power off your system and unplug your power cable.
2. Locate the onboard battery as shown below.
3. Using a tool such as a pen or a small screwdriver, push the battery lock outwards to unlock it. Once unlocked, the battery will pop out from the holder.
4. Remove the battery.

Proper Battery Disposal

Warning: Please handle used batteries carefully. Do not damage the battery in any way; a damaged battery may release hazardous materials into the environment. Do not discard a used battery in the garbage or a public landfill. Please comply with the regulations set up by your local hazardous waste management agency to dispose of your used battery properly.

Battery Installation

1. To install an onboard battery, follow steps 1 and 2 above and continue below:
2. Identify the battery's polarity. The positive (+) side should be facing up.
3. Insert the battery into the battery holder and push it down until you hear a click to ensure that the battery is securely locked.

Warning: When replacing a battery, be sure to only replace it with the same type.

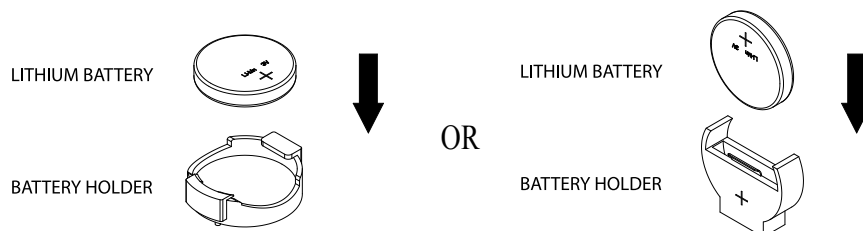

3.5 Returning Merchandise for Service

A receipt or copy of your invoice marked with the date of purchase is required before any warranty service will be rendered. You can obtain service by calling your vendor for a Returned Merchandise Authorization (RMA) number. When returning the motherboard to the manufacturer, the RMA number should be prominently displayed on the outside of the shipping carton, and the shipping package is mailed prepaid or hand-carried. Shipping and handling charges will be applied for all orders that must be mailed when service is complete. For faster service, you can also request a RMA authorization online (<http://www.supermicro.com/RmaForm/>).

This warranty only covers normal consumer use and does not cover damages incurred in shipping or from failure due to the alternation, misuse, abuse or improper maintenance of products.

During the warranty period, contact your distributor first for any product problems.

Chapter 4

BIOS

4.1 Introduction

This chapter describes the AMIBIOS™ Setup utility for the X12STL-F motherboard. The BIOS is stored on a chip and can be easily upgraded using a flash program.



Note: Due to periodic changes to the BIOS, some settings may have been added or deleted and might not yet be recorded in this manual. Refer to the Manual Download area of our website for any changes to BIOS that may not be reflected in this manual.

Starting the Setup Utility

To enter the BIOS Setup Utility, hit the <Delete> key while the system is booting-up. (In most cases, the <Delete> key is used to invoke the BIOS setup screen. There are a few cases when other keys are used, such as <F1>, <F2>, etc.) Each main BIOS menu option is described in this manual.

The Main BIOS screen has two main frames. The left frame displays all the options that can be configured. "Grayed-out" options cannot be configured. The right frame displays the key legend. Above the key legend is an area reserved for a text message. When an option is selected in the left frame, it is highlighted in white. Often a text message accompanies it. (Note that BIOS has default text messages built in. We retain the option to include, omit, or change any of these text messages.) Settings printed in **Bold** are the default values.

A " ►" indicates a submenu. Highlighting such an item and pressing the <Enter> key opens the list of settings within that submenu.

The BIOS setup utility uses a key-based navigation system called hot keys. Most of these hot keys (<F1>, <F10>, <Enter>, <ESC>, <Arrow> keys, etc.) can be used at any time during the setup navigation process.

4.2 Main Setup

When entering the AMI BIOS setup utility, you start the Main setup screen. You can always return to the Main setup screen by selecting the Main tab on the top of the screen. The Main BIOS setup screen is shown below. The following Main menu items are displayed:

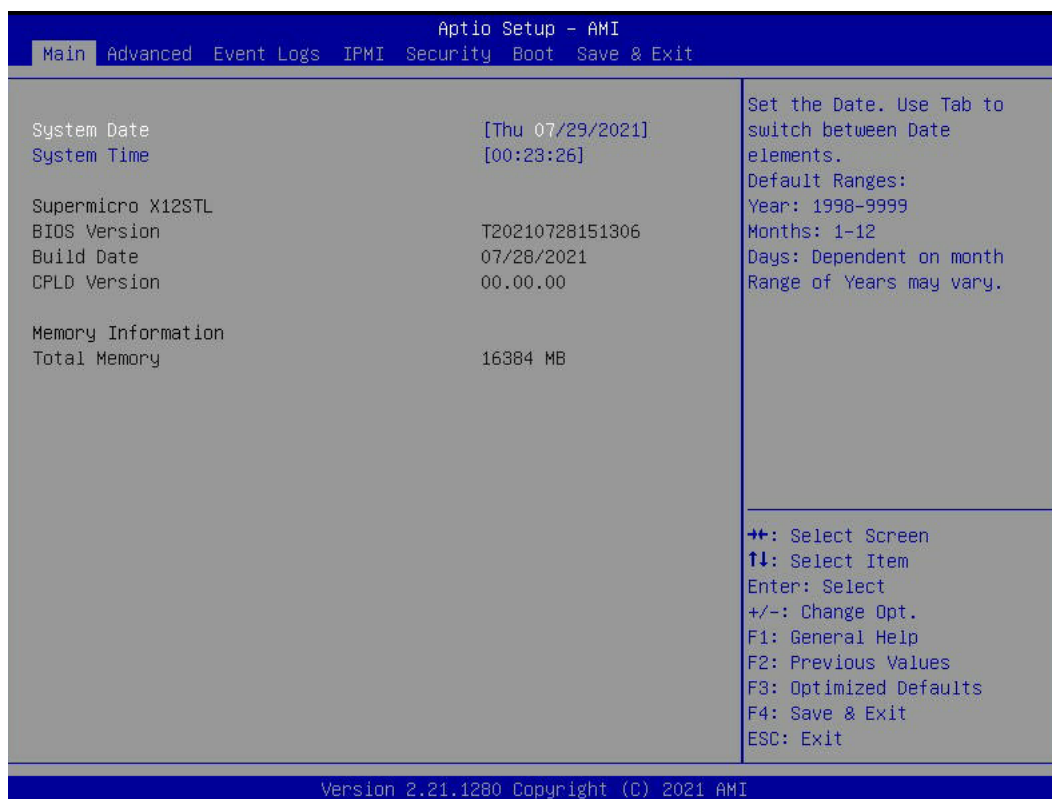

System Date/System Time

Use this option to change the system date and time. Highlight *System Date* or *System Time* using the arrow keys. Enter new values using the keyboard. Press the <Tab> key or the arrow keys to move between fields. The date must be entered in MM/DD/YYYY format. The time is entered in HH:MM:SS format.



Note: The time is in the 24-hour format. For example, 5:30 P.M. appears as 17:30:00.

Supermicro X12STL

BIOS Version: T20210728151306

Build Date: 07/28/2021

CPLD Version: This displays the CPLD version of the system.

Memory Information

Total Memory: This displays the total size of memory available in the system.

4.3 Advanced

Use the arrow keys to select Advanced setup and press <Enter> to access the submenu items:

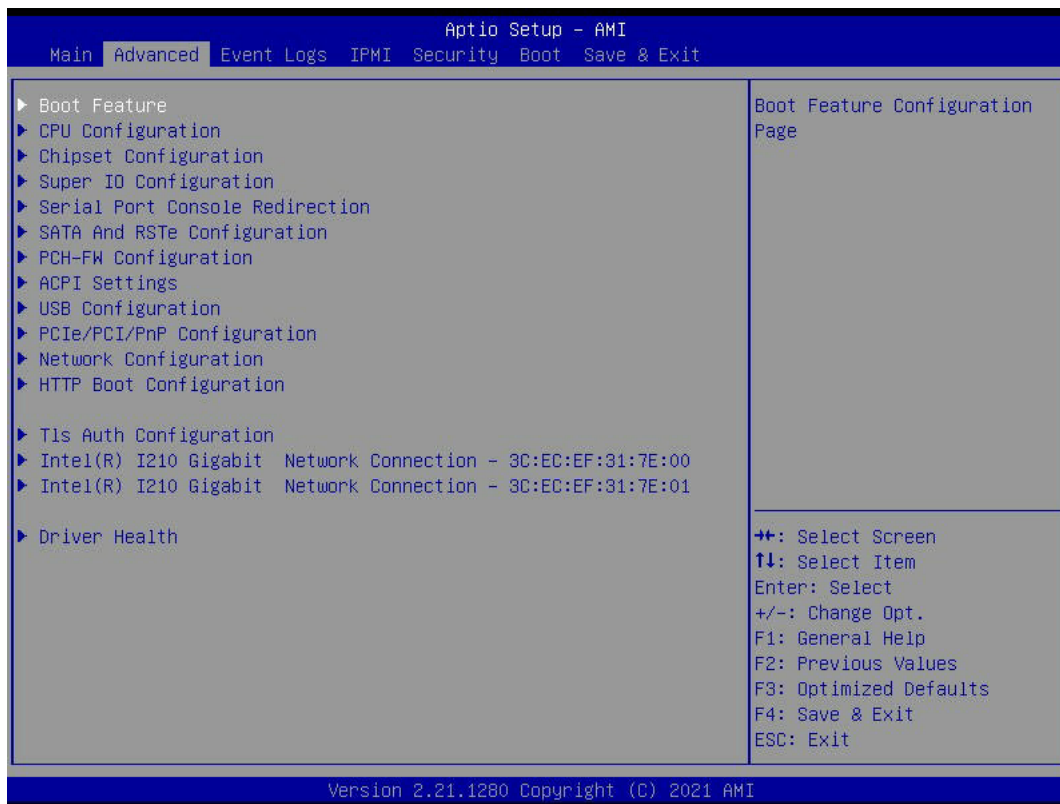

Warning: Take caution when changing the Advanced settings. An incorrect value, a very high DRAM frequency or an incorrect BIOS timing setting may cause the system to malfunction. When this occurs, restore the setting to the manufacture default setting.

► Boot Feature

Quiet Boot

Use this feature to select the screen display between the POST messages and the OEM logo upon bootup. Select Disabled to display the POST messages. Select Enabled to display the OEM logo instead of the normal POST messages. The options are Disabled and **Enabled**.

Option ROM Messages

Use this feature to set the display mode for the Option ROM. Select Keep Current to display the current AddOn ROM setting. Select Force BIOS to use the Option ROM display set by the system BIOS. The options are **Force BIOS** and Keep Current.

Bootup NumLock State

This feature selects the Power-on state for the Numlock key. The options are **On** and Off.

Wait For "F1" If Error

This feature forces the system to wait until the F1 key is pressed if an error occurs. The options are Disabled and **Enabled**.

INT19 Trap Response

Interrupt 19 is the software interrupt that handles the boot disk function. When this feature is set to Immediate, the ROM BIOS of the host adapters will "capture" Interrupt 19 at boot up immediately and allow the drives that are attached to these host adapters to function as bootable disks. If this feature is set to Postponed, the ROM BIOS of the host adapters will not capture Interrupt 19 immediately and allow the drives attached to these adapters to function as bootable devices at boot up. The options are **Immediate** and Postponed.

Re-try Boot

If this feature is enabled, the BIOS automatically reboots the system from a specified boot device after its initial boot failure. The options are **Disabled**, Legacy Boot, and EFI Boot.

Power Configuration

Watch Dog Function

If enabled, the Watch Dog Timer allows the system to reset or generate NMI based on jumper settings when it is expired for more than five minutes. The options are **Disabled** and Enabled.

Restore on AC Power Loss

Use this feature to set the power state after a power outage. Select Stay Off for the system power to remain off after a power loss. Select Power On for the system power to be turned on after a power loss. Select Last State to allow the system to resume its last power state before a power loss. The options are Stay Off, Power On, and **Last State**.

Power Button Function

This feature controls how the system shuts down when the power button is pressed. Select 4 Seconds Override to power off the system after pressing and holding the power button for four seconds or longer. Select Instant Off to instantly power off the system as soon as you press the power button. The options are **Instant Off** and 4 Seconds Override.

► CPU Configuration

The following CPU information is displayed:

- Type
- CPU Signature
- Microcode Revision
- CPU Speed
- L1 Data Cache
- L1 Instruction Cache
- L2 Cache
- L3 Cache
- VMX
- SMX/TXT

CPU Flex Ratio Override

Use this feature to enable or disable CPU Flex Ratio Prgraming. The options are **Disabled** and **Enabled**.

****If the feature above is set to Enabled, the following feature is available for configuration:***

CPU Core Flex Ratio

Use this feature to set the non-turbo mode processor core ratio multiplier. The default value is **34**.

Hardware Prefetcher

If this feature is set to Enable, the hardware prefetcher prefetches streams of data and instructions from the main memory to the Level 2 (L2) cache to improve CPU performance. The options are **Disabled** and **Enabled**.

Adjacent Cache Line Prefetch

Select **Enabled** for the CPU to prefetch both cache lines for 128 bytes as comprised. Select **Disable** for the CPU to prefetch both cache lines for 64 bytes. The options are **Disabled** and **Enabled**.

Intel® (VMX) Virtualization Technology

Select **Enabled** to use Intel Virtualization Technology to allow one platform to run multiple operating systems and applications in independent partitions, creating multiple virtual systems in one physical computer. The options are **Disabled** and **Enabled**.

PECI

Use this feature to enable or disable Platform Environment Control Interface (PECI). The options are Disabled and **Enabled**.

AVX

Use this feature to enable or disable the AVX 2/3 instructions. The options are **Enabled** and Disabled.

AVX3

Use this feature to enable or disable the AVX 3 instructions. The options are **Enabled** and Disabled.

Active Processor Cores

This feature determines how many CPU cores are activated for each CPU. When All is selected, all cores in the CPU are activated. Refer to Intel's website for more information. The options are **All**, 1, 2, and 3.

Hyper-Threading

Select Enabled to support Intel Hyper-threading Technology to enhance CPU performance. The options are Disabled and **Enabled**.

BIST

Use this feature to enable or disable the built-in self-test during boot up. The options are **Disabled** and Enabled.

AP threads Idle Manner

Use this feature to select the AP threads Idle manner. The options are HALT Loop, **MWAIT Loop**, and RUN Loop.

AES

Select Enabled for Intel CPU Advanced Encryption Standard (AES) instructions support to enhance data integrity. The options are Disabled and **Enabled**.

MachineCheck

Use this feature to enable or disable Machine Check. The options are Disabled and **Enabled**.

Monitor Mwait

Select Enabled to enable the Monitor/Mwait instructions. The Monitor instruction monitors a region of memory for writes, and MWait instruction instructs the CPU to stop until the monitored region begins to write. The options are Disabled and **Enabled**.

► Power & Performance Configuration

CPU - Power Management Control

Boot Performance Mode

This feature allows you to select the performance state that the BIOS will set before the operating system handoff. The options are Power Saving, Max Non-Turbo Performance and **Turbo Performance**.

Intel® SpeedStep™

Intel SpeedStep Technology allows the system to automatically adjust processor voltage and core frequency to reduce power consumption and heat dissipation. The options are Disabled and **Enabled**.

Intel® Speed Shift Technology

Use this feature to enable or disable Intel Speed Shift Technology support. When this feature is enabled, the Collaborative Processor Performance Control (CPPC) version 2 interface will be available to control CPU P-States. The options are **Disabled**, Native Mode, and Out of Band Mode.

Per Core P State OS control mode

Use this feature to enable or disable Per Core P State OS control mode. The options are Disabled and **Enabled**.

HWP Autonomous Per Core P State

Disabling Autonomous PCPS will request the same value for all cores all the time. The options are Disabled and **Enabled**.

HWP Autonomous EPP Grouping

Enabling EPP grouping autonomous will request the same values for all cores with EPP. Disabling EPP grouping autonomous will not necessarily request the same values for all cores with EPP. The options are Disabled and **Enabled**.

Turbo Mode

Select Enabled for processor cores to run faster than the frequency specified by the manufacturer. The options are Disabled and **Enabled**.

Power Limit 1

Use this feature to enable or disable Platform Power Limit 1 programming. If enabled, it activates the PL1 value to be used by the processor to limit the average power of the given time window. The options are **Disabled** and Enabled.

Power Limit 2

Use this feature to enable or disable Platform Power Limit 2 programming. If disabled, BIOS will program the default values for Platform Power Limit 2. The options are **Disabled** and **Enabled**.

Power Limit 3 Override

Use this feature to enable or disable Power Limit 3 override. Power Limit 3 Lock needs to be disabled for power Limit 3 override. If disabled, BIOS will leave the hardware default values for Power Limit 3. The options are **Disabled** and **Enabled**.

Power Limit 4 Override

Use this feature to enable or disable Platform Power Limit 4 programming. If disabled, BIOS will program the default values for Platform Power Limit 4. The options are **Disabled** and **Enabled**.

C States

Use this feature to enable or disable CPU power management and allows the CPU to go to C states when it is not 100% utilized. The options are **Disabled** and **Enabled**.

Enhanced C-states

Use this feature to enable the enhanced C-State of the CPU. The options are **Disabled** and **Enabled**.

C-State Auto Demotion

Use this feature to prevent unnecessary excursions into the C-states to improve latency. The options are **Disabled** and **C1**.

C-State Un-Demotion

This feature allows you to enable or disable the un-demotion of C-State. The options are **Disabled** and **C1**.

Package C-State Demotion

Use this feature to enable or disable the Package C-State demotion. The options are **Disabled** and **Enabled**.

Package C-State Un-Demotion

Use this feature to enable or disable the Package C-State un-demotion. The options are **Disabled** and **Enabled**.

C-State Pre-Wake

This feature allows you to enable or disable the C-State Pre-Wake. The options are **Disabled** and **Enabled**.

IO MWait Redirection

When set, it will map IO_read instructions to IO registers PMG_IO_BASE_ADDRBASE+offset to MWAIT (offset). The options are **Disabled** and Enabled.

Package C-State Limit

Use this feature to set the Package C-State limit. The options are **C0/C1**, C2, C3, C6, C7, C7s, C8, C9, C10, Cpu Default, and Auto.

ACPI T-States

Use this feature to enable or disable ACPI T-States. The options are Disabled and **Enabled**.

▶ SGX settings**Software Guard Extensions (SGX)**

Use this feature to enable or disable software guard extensions. The options are **Disabled**, Enabled, and Software Controlled.

► Chipset

Warning: Setting the wrong values in the following sections may cause the system to malfunction.

► System Agent (SA) Configuration

- VT-d Supported

► Memory Configuration

- Memory RC Version
- Memory Frequency
- Memory Timings (tCL-tRCD-tRP-tRAS)
- DIMMA1
- DIMMA2
 - Number of Ranks
 - Manufacturer
- DIMMB1
- DIMMB2

DDR Speed Control

Use this feature to set the DDR speed. The options are **Auto** and Manual.

****If the feature above is set to manual, Maximum Memory Frequency and SA GV High Gear are available for configuration:***

Maximum Memory Frequency

Use this feature to set the maximum memory frequency for onboard memory modules. The options are **Auto**, 1067, 1200, 1333, 1400, 1600, 1800, 1867, 2000, 2133, 2200, 2400, 2600, 2667, 2800, 2933, 3000, and 3200.

ECC Support

Use this feature to enable or disable DDR ECC support. The options are Disabled and **Enabled**.

Max TOLUD

This feature sets the maximum TOLUD value, which specifies the "Top of Low Usable DRAM" memory space to be used by internal graphics devices, GTT Stolen Memory, and TSEG, respectively, if these devices are enabled. The options are **Dynamic**, 1 GB, 1.25 GB, 1.5 GB, 1.75 GB, 2 GB, 2.25 GB, 2.5 GB, 2.75 GB, 3 GB, 3.25 GB, and 3.5 GB.

SA GV High Gear

Use this feature to select the gear for SA GV. The options are Gear1 and **Gear2**.

Retrain on Fast Fail

This feature restarts MRC in Cold mode if SW MemTest fails during Fast flow. The options are Disabled and **Enabled**.

Enable RH Prevention

Use this feature to prevent row hammer. The options are **Disabled** and Enabled.

Power Down Mode

Use this feature to select the power down mode. The options are **Auto**, No Power Down, APD, and PPD-DLLoff.

Power Down Idle Timer

Use this feature to set the power down idle timer. The default setting is **0**.

Memory Scrambler

Use this feature to enable or disable memory scrambler support. The options are Disabled and **Enabled**.

Force ColdReset

Use this feature to enable or disable a cold boot during a MRC execution. The options are Enabled and **Disabled**.

Force Single Rank

Select enabled to use only Rank 0 in each DIMM. The options are **Disabled** and Enabled.

Fast Boot

Use this feature to enable or disable fast path through the memory reference code. The options are Disabled and **Enabled**.

Train on Warm Boot

Use this feature to enable or disable training on warm boot. The options are **Disabled** and Enabled.

Memory Test on Warm Boot

Use this feature to enable or disable base memory test run on warm boot. The options are **Disabled** and Enabled.

REFRESH_2X_MODE

Use this feature to enable 2x memory refresh support to enhance memory performance. The options are **Disabled**, 1- Enabled for WARM or HOT, and 2- Enabled HOT only.

► DMI Configuration

DMI Max Link Speed

Use this feature to select DMI Max Link Speed. The options are Gen1, Gen2, and **Gen3**.

DMI Gen3 ASPM Control

Use this feature to set the Active State Power Management (ASPM) state on the System Agent (SA) side of the DMI Link. The options are Disable, **Auto**, ASPM L0s, ASPM L1, and ASPM L0sL1.

DMI De-emphasis Control

Use this feature to configure the De-emphasis control on DMI. The options are -6 dB and **-3.5 dB**.

► PEG Port Configuration

PCI Express Root Port 1/ Port 2/ Port3/ Port4

Use this feature to control the PCIe Root Port. The options are Disabled and **Enabled**.

ASPM

Use this feature to set the Active State Power Management (ASPM) level for a PCIe device. Select Auto for the system BIOS to automatically set the ASPM level based on the system configuration. Select Disabled to disable ASPM support. The options are Disabled, L0s, **L1**, and L0sL1.

PCIe Speed

Use this to configure PCIe speed. The options are **Auto**, Gen1, Gen2, Gen3 and Gen4

PEG 0:1:0 Not present

PEG 0:1:1 X4 Gen3

PEG 0:1:2 Not present

PEG 0:6:0 Not present

Stop Grant Configuration

This feature controls automatic/manual Stop Grant configuration. The options are Manual and **Auto**.

****If the above option is set to Manual, Number of Stop Grant Cycles will be available for configuration.***

Number of Stop Grant Cycles

This feature allows you to select the number of Stop-Grant cycles. The default setting is **1**.

VT-d

Select Enabled to activate Intel Virtualization Technology support for Direct I/O VT-d by reporting the I/O device assignments to VMM through the DMAR ACPI Tables. This feature offers fully-protected I/O resource-sharing across the Intel platforms with greater reliability, security and availability in networking and data-sharing. The options are Disabled and **Enabled**.

X2APIC Opt Out

Use this feature to enable or disable X2APIC_OPT_Out bit. The options are Enabled and **Disabled**.

DMA Control Guarantee

Use this feature to enable or disable DMA_Control_Guarantee bit. The options are Enabled and **Disabled**.

IGD VTD Enable

Use this feature to enable or disable IGD VTD. The options are **Enabled** and Disabled.

IOP VTD Enable

Use this feature to enable or disable IOP VTD. The options are **Enabled** and Disabled.

Thermal Device (B0:D4:F0)

Use this feature to enable or disable SA thermal device. Always enable for ICL A0 stepping. The options are Enabled and **Disabled**.

GNA Device (B0:D8:F0)

Use this feature to enable or disable SA GNA device. The options are **Enabled** and Disabled.

► PCH-IO Configuration

PCH-IO Configuration

► PCI Express Configuration

Peer Memory Write Enable

Use this feature to enable or disable peer memory write. The options are **Disabled** and Enabled.

► PCI Express Root Port (1 ~ 24)

This submenu allows you to configure each PCIe Root port. Click on each available port and configure the settings accordingly.

ASPM

Use this feature to activate the Active State Power Management (ASPM) level for a PCIe device. Select Auto for the system BIOS to automatically set the ASPM level based on the system configuration. Select Disabled to disable ASPM support. The options are Disabled, L0s, L1, L0sL1, and **Auto**.

L1 Substates

Use this feature to configure the L1 substates . The options are Disabled, L1.1, and **L1.1 & L1.2**.

PCIe Speed

Use this feature to select the PCIe speed. The options are **Auto**, Gen1, Gen2, and Gen3.

Port 61h Bit-4 Emulation

Use this feature to enable or disable emulation of Port 61fh bit-4 toggling in SMM. The options are **Disabled** and Enabled.

PCIe PLL SSC

Use this feature to enable or disable PCIe PLL spread spectrum clocking. The options are **Enabled** and Disabled.

► Super IO Configuration

Super IO Configuration

Super IO Chip: AST2600

► Serial Port 1 Configuration

Serial Port 1 Configuration

Select Enabled to enable the selected onboard serial port. The options are Disabled and **Enabled**.

Device Settings

This feature displays the base I/O port address and the Interrupt Request address of the selected serial port.

Change Settings

This feature specifies the base I/O port address and the Interrupt Request address of Serial Port 1. Select Auto to allow the BIOS to automatically assign the base I/O and IRQ address to a serial port specified. The options are **Auto**, (IO=3F8h; IRQ=4;), (IO=2F8h; IRQ=4;), (IO=3E8h; IRQ=4;), and (IO=2E8h; IRQ=4;).

► Serial Port 2 Configuration

Serial Port 2 Configuration

Select Enabled to enable the selected onboard serial port. The options are Disabled and **Enabled**.

Device Settings

This feature displays the base I/O port address and the Interrupt Request address of the selected serial port.

Change Port Settings

This feature specifies the base I/O port address and the Interrupt Request address of Serial Port 2. Select Auto to allow the BIOS to automatically assign the base I/O and IRQ address to a serial port specified. The options are **Auto**, (IO=3F8h; IRQ=3;), (IO=2F8h; IRQ=3;), (IO=3E8h; IRQ=3;), and (IO=2E8h; IRQ=3;).

Serial Port 2 Attribute

Select SOL to use COM Port 2 as a Serial Over LAN (SOL) port for console redirection. The options are **SOL** and COM.

► Serial Port Console Redirection

COM1

Console Redirection

Select Enabled to enable console redirection support for the selected serial port. The options are **Disabled** and Enabled.

**If the feature above is enabled, the following features are available for configuration:*

► Console Redirection Settings

This feature allows you to specify how the host computer exchanges data with the client computer.

Terminal Type

This feature allows you to select the target terminal emulation type for Console Redirection. Select VT100 to use the ASCII Character set. Select VT100+ to add color and function key support. Select ANSI to use the Extended ASCII Character Set. Select VT-UTF8 to use UTF8 encoding to map Unicode characters into one or more bytes. The options are VT100, **VT100+**, VT-UTF8, and ANSI.

Bits per second

Use this feature to set the transmission speed for a serial port used in Console Redirection. Make sure that the same speed is used in the host computer and the client computer. A lower transmission speed may be required for long and busy lines. The options are 9600, 19200, 38400, 57600, and **115200** (bits per second).

Data Bits

Use this feature to set the data transmission size for Console Redirection. The options are 7 and **8**.

Parity

A parity bit can be sent along with regular data bits to detect data transmission errors. Select Even if the parity bit is set to 0, and the number of 1's in data bits is even. Select Odd if the parity bit is set to 0, and the number of 1's in data bits is odd. Select None if you do not want to send a parity bit with your data bits in transmission. Select Mark to add a mark as a parity bit to be sent along with the data bits. Select Space to add a Space as a parity bit to be sent with your data bits. The options are **None**, Even, Odd, Mark, and Space.

Stop Bits

A stop bit indicates the end of a serial data packet. Select 1 Stop Bit for standard serial data communication. Select 2 Stop Bits if slower devices are used. The options are **1** and 2.

Flow Control

Use this feature to set the flow control for Console Redirection to prevent data loss caused by buffer overflow. Send a "Stop" signal to stop sending data when the receiving buffer is full. Send a "Start" signal to start sending data when the receiving buffer is empty. The options are **None** and Hardware RTS/CTS.

VT-UTF8 Combo Key Support

Select Enabled to enable VT-UTF8 Combination Key support for ANSI/VT100 terminals. The options are Disabled and **Enabled**.

Recorder Mode

Select Enabled to capture the data displayed on a terminal and send it as text messages to a remote server. The options are **Disabled** and Enabled.

Resolution 100x31

Select Enabled for extended-terminal resolution support. The options are Disabled and **Enabled**.

Putty KeyPad

This feature selects the settings for Function Keys and KeyPad used for Putty, which is a terminal emulator designed for the Windows OS. The options are **VT100**, LINUX, XTERMR6, SCO, ESCN, and VT400.

SOL/COM2

Console Redirection

Select Enabled to enable console redirection support for the selected serial port. The options are **Enabled** and Disabled.

**If the feature above is enabled, the following features are available for configuration:*

► Console Redirection Settings

Use this feature to specify how the host computer exchanges data with the client computer. The options are Enabled and **Disabled**.

Terminal Type

Use this feature to select the target terminal emulation type for Console Redirection. Select VT100 to use the ASCII Character set. Select VT100+ to add color and function key support. Select ANSI to use the Extended ASCII Character Set. Select VT-UTF8 to use UTF8 encoding to map Unicode characters into one or more bytes. The options are VT100, **VT100+**, VT-UTF8, and ANSI.

Bits per second

Use this feature to set the transmission speed for a serial port used in Console Redirection. Make sure that the same speed is used in the host computer and the client computer. A lower transmission speed may be required for long and busy lines. The options are 9600, 19200, 38400, 57600, and **115200** (bits per second).

Data Bits

Use this feature to set the data transmission size for Console Redirection. The options are 7 and **8**.

Parity

A parity bit can be sent along with regular data bits to detect data transmission errors. Select Even if the parity bit is set to 0, and the number of 1's in data bits is even. Select Odd if the parity bit is set to 0, and the number of 1's in data bits is odd. Select None if you do not want to send a parity bit with your data bits in transmission. Select Mark to add a mark as a parity bit to be sent along with the data bits. Select Space to add a Space as a parity bit to be sent with your data bits. The options are **None**, Even, Odd, Mark and Space.

Stop Bits

A stop bit indicates the end of a serial data packet. Select 1 Stop Bit for standard serial data communication. Select 2 Stop Bits if slower devices are used. The options are **1** and 2.

Flow Control

Use this feature to set the flow control for Console Redirection to prevent data loss caused by buffer overflow. Send a "Stop" signal to stop sending data when the receiving buffer is full. Send a "Start" signal to start sending data when the receiving buffer is empty. The options are **None** and Hardware RTS/CTS.

VT-UTF8 Combo Key Support

Select Enabled to enable VT-UTF8 Combination Key support for ANSI/VT100 terminals. The options are Disabled and **Enabled**.

Recorder Mode

Select Enabled to capture the data displayed on a terminal and send it as text messages to a remote server. The options are **Disabled** and Enabled.

Resolution 100x31

Select Enabled for extended-terminal resolution support. The options are Disabled and **Enabled**.

Putty KeyPad

This feature selects Function Keys and KeyPad settings for Putty, which is a terminal emulator designed for the Windows OS. The options are **VT100**, LINUX, XTERMR6, SCO, ESCN, and VT400.

Legacy Console Redirection

► Legacy Console Redirection Settings

Redirection COM Port

Use this feature to select the COM port to display redirection of Legacy OS OPROM messages. The options are **COM1** and SOL/COM2.

Legacy OS Redirection Resolution

Use this feature to select the number of rows and columns used in Console Redirection for legacy OS support. The options are **80x24** and 80x25.

Redirection After BIOS POST

Use this feature to enable or disable legacy Console Redirection after BIOS POST. When set to Bootloader, legacy Console Redirection is disabled before booting the OS. When set to Always Enable, legacy Console Redirection remains enabled when booting the OS. The options are **Always Enable** and BootLoader.

Serial Port for Out-of-Band Management/Windows Emergency Management Services (EMS)

The submenu allows you to configure Console Redirection settings to support Out-of-Band Serial Port management.

Console Redirection EMS

Select Enabled to use a selected COM port for EMS Console Redirection. The options are **Disabled** and Enabled.

**If the feature above is enabled, the following items are available for configuration:*

► Console Redirection Settings

This feature allows you to specify how the host computer exchanges data with the client computer.

Out-of-Band Mgmt Port EMS

The feature selects a serial port in a client server to be used by the Microsoft Windows Emergency Management Services (EMS) to communicate with a remote host server. The options are **COM1** and SOL/COM2.

Terminal Type EMS

Use this feature to select the target terminal emulation type for Console Redirection. Select VT100 to use the ASCII character set. Select VT100+ to add color and function key support. Select ANSI to use the extended ASCII character set. Select VT-UTF8 to use UTF8 encoding to map Unicode characters into one or more bytes. The options are VT100, VT100+, **VT-UTF8**, and ANSI.

Bits Per Second EMS

This feature sets the transmission speed for a serial port used in Console Redirection. Make sure that the same speed is used in the host computer and the client computer. A lower transmission speed may be required for long and busy lines. The options are 9600, 19200, 57600, and **115200** (bits per second).

Flow Control EMS

Use this feature to set the flow control for Console Redirection to prevent data loss caused by buffer overflow. Send a "Stop" signal to stop sending data when the receiving buffer is full. Send a "Start" signal to start sending data when the receiving buffer is empty. The options are **None**, Hardware RTS/CTS, and Software Xon/Xoff.

Data Bits EMS: 8 **Parity EMS:** None **Stop Bits EMS:** 1

► SATA And RSTe Configuration

SATA Controller(s)

This feature enables or disables the onboard SATA controller supported by the Intel PCH chip. The options are **Enabled** and Disabled.

SATA Mode Selection

Select AHCI to configure an sSATA drive specified as an AHCI drive. Select RAID to configure an sSATA drive specified as a RAID drive. The options are **AHCI** and Intel RSTe Premium With Intel Optane System Acceleration.

**If the feature above is set to Intel RSTe Premium With Intel Optane System Acceleration, the SATA Interrupt Selection is available for configuration:*

SATA Interrupt Selection

Use this feature to select the interrupt that will be available to the operating system. The options are **MSI-x**, MSI, and Legacy.

Aggressive LPM Support

When this feature is set to Enabled, the SATA AHCI controller manages the power usage of the SATA link. The controller will put the link in a low power mode during extended periods of I/O inactivity, and will return the link to an active state when I/O activity resumes. The options are Disabled and **Enabled**.

Serial ATA Port 0~7

This feature displays the information detected on the installed SATA drive on the particular SATA port.

Port 0-7 Hot Plug

Set this feature to Enable for hot plug support, which allows you to replace a SATA drive without shutting down the system. The options are Disabled and **Enabled**.

Port 0-7 Spin Up Device

Set this feature to enable or disable the PCH to initialize the device. The options are **Disabled** and **Enabled**.

Port 0-7 SATA Device Type

Use this feature to specify if the SATA port specified should be connected to a Solid State Drive or a Hard Disk Drive. The options are **Hard Disk Drive** and **Solid State Drive**.

► PCH-FW Configuration

Click on this menu and the following firmware information will display:

General ME Configuration

Operation Firmware Version

Backup Firmware Version

Recovery Firmware Version

ME Firmware Status #1

ME Firmware Status #2

 Current State

 Error Code

► ACPI Settings**High Precision Event Timer**

Select **Enabled** to activate the High Precision Event Timer (HPET) that produces periodic interrupts at a much higher frequency than a Real-time Clock (RTC) does in synchronizing multimedia streams, providing smooth playback and reducing the dependency on other timestamp calculation devices, such as an x86 RDTSC Instruction embedded in the CPU. The High Performance Event Timer is used to replace the 8254 Programmable Interval Timer. The options are **Disabled** and **Enabled**.

Native PCIE Enable

Enable this feature to grant control of PCI Express Native hot plug, PCI Express Power Management Events, and PCI Express Capability Structure Control. The options are **Disabled** and **Enabled**.

Native ASPM

Select **Enabled** for the operating system to control the ASPM or **Disabled** for the BIOS to control the ASPM. The options are **Auto**, **Enabled**, and **Disabled**.

► USB Configuration

USB Configuration

USB Module Version: 25

USB Controllers: 1 XHCI

USB Devices: 1 keyboard, 1 Mouse, 1 Hub

Legacy USB Support

Select Enabled to support onboard legacy USB devices. Select Auto to disable legacy support if there are no legacy USB devices present. Select Disable to have all USB devices available for EFI applications only. The options are **Enabled**, Disabled, and Auto.

XHCI Hand-off

This is a work-around solution for operating systems that do not support Extensible Host Controller Interface (XHCI) hand-off. The XHCI ownership change should be claimed by the XHCI driver. The settings are **Enabled** and Disabled.

USB Mass Storage Driver Support

Select Enabled for USB mass storage device support. The options are Disabled and **Enabled**.

USB hardware delays and time-outs:

USB transfer time-out

Use this feature to set the time out value for Control, Bulk, and Interrupt transfers. The options are 1 sec, 5 sec, 10 sec, and **20 sec**.

USB reset time-out

Use this feature to set the USB mass storage device Start Unit command time out. The options are 10 sec, **20 sec**, 30 sec, and 40 sec.

Device power-up delay

Use this feature to set the maximum time the device will take before it reports itself to the host controller. The options are **Auto** and Manual.

****If the above option is set to Manual, Device power-up delay in seconds will be available for configuration.***

Device power-up delay in seconds

Use this option to set the maximum time the device will take before it reports itself to the host controller. The default setting is **5** (seconds).

► PCIe/PCI/PnP Configuration

Option ROM Execution

Onboard Video Option ROM

Use this feature to select the onboard video firmware type. The options are Disabled and **EFI**.

Above 4GB MMIO BIOS Assignment (Available if the system supports 64-bit PCI decoding)

Select Enabled to decode a PCI device that supports 64-bit in the space above 4G Address. The options are **Enabled** and Disabled.

NVMe Firmware Source

The feature determines which type of NVMe firmware should be used in your system. The options are **Vendor Defined Firmware** and AMI Native Support.

Storage Option ROM/UEFI Driver

Select UEFI to load the EFI driver for system boot. Select Legacy to load a legacy driver for system boot. The options are Do not Launch, **UEFI**, and Legacy.

PCIe/PCI/PnP Configuration

CPU SLOT7 PCI-E 4.0 x4 (IN x8) OPROM

Use this feature to select which firmware type to be loaded for the add-on card in this slot. The options are Disabled and **EFI**.

CPU SLOT6 PCI-E 4.0 x8 (IN x16) OPROM

Use this feature to select which firmware type to be loaded for the add-on card in this slot. The options are Disabled and **EFI**.

CPU SLOT5 PCI-E 4.0 x8 PROM

Use this feature to select which firmware type to be loaded for the add-on card in this slot. The options are Disabled and **EFI**.

CPU SLOT4 PCI-E 3.0 x2 (IN x4) OPROM

Use this feature to select which firmware type to be loaded for the add-on card in this slot. The options are Disabled and **EFI**.

Onboard LAN1 Option ROM

Use this feature to select which firmware function to be loaded for LAN Port 1 used for system boot. The options are Disabled and **EFI**.

Onboard LAN2 Option ROM

Use this feature to select which firmware function to be loaded for LAN Port 1 used for system boot. The options are **Disabled** and EFI.

► Network Configuration

Network Configuration

Network Stack

Select Enabled to enable Preboot Execution Environment (PXE) or Unified Extensible Firmware Interface (UEFI) for network stack support. The options are Disabled and **Enabled**.

IPv4 PXE Support

Select Enabled to enable IPv4 PXE boot support. The options are Disabled and **Enabled**.

IPv4 HTTP Support

Select Enabled to enable IPv4 HTTP boot support. The options are **Disabled** and Enabled.

IPv6 PXE Support

Select Enabled to enable IPv6 PXE boot support. The options are Disabled and **Enabled**.

IPv6 HTTP Support

Select Enabled to enable IPv6 HTTP boot support. The options are **Disabled** and Enabled.

PXE Boot Wait Time

Use this option to specify the wait time to press the ESC key to abort the PXE boot. Press "+" or "-" on your keyboard to change the value. The default setting is **0**.

Media Detect Count

Use this option to specify the number of times media is checked. Press "+" or "-" on your keyboard to change the value. The default setting is **1**.

► MAC:3CECEF317E00-IPv4 Network Configuration ► MAC:3CECEF317E01-IPv4 Network Configuration

Configured

Use this feature to specify whether the network address is configured successfully or not. The options are **Disabled** and Enabled.

Save Changes And Exit

Use this feature to save changes and exit.

► MAC:3CECEF317E00-IPv6 Network Configuration ► MAC:3CECEF317E01-IPv6 Network Configuration

► Enter Configuration Menu

- Interface Name

- Interface Type
- MAC address
- Host addresses
- Route Table
- Gateway addresses
- DNS addresses

Interface ID

This feature shows the interface ID for the specified network device.

DAD Transmit Count

This feature sends Neighbor Solicitation messages while performing a Duplicate Address Detection (DAD) to make sure there is no IP address duplication. A value of zero means a DAD has not been performed. The default setting is **1**.

Policy

Use this feature to select an automatic or manual policy. The options are **Automatic** and **Manual**.

****If the above option is set to Manual, Advanced Configuration will be available for configuration.***

► Advanced Configuration

New IPv6 address

Use this option to manually configure IP address. Separate the IP address with blank space to configure more than one address.

New Gateway address

Use this option to manually configure Gateway IP address. Separate the IP address with blank space to configure more than one address.

New DNS address

Use this option to manually configure the DNS address. Separate the IP address with blank space to configure more than one address.

Commit Changes and Exit

Use this feature to save all changes and exit.

Discard Changes and Exit

Use this feature to discard all changes and exit.

Save Changes and Exit

When you have completed the changes for this section, select this option to save all changes made and exit.

► HTTP Boot Configuration

HTTP BOOT Configuration

HTTP Boot Policy

Use this feature to select the HTTP boot policy. The options are Apply to all LANs, **Apply to each LAN**, and Boot Priority #1 instantly.

HTTP Boot Checks Hostname

Use this feature to select whether HTTPS Boot checks the hostname of TLS certificates matches the hostname provided by the remote server. The options are **Enabled** and Disabled (Warning: Security Risk!!).

Priority of HTTP Boot

Instance of Priority 1:

Enter a value to set the rank target port. The default is **1**.

Select IPv4 or IPv6

Use this feature to select the targeted LAN port to boot from. The options are **IPv4** and IPv6.

Boot Description

Highlight the feature and press enter to create a description.

Boot URI

Highlight the feature and press enter to create a boot URI.

Instance of Priority 2:

Enter a value to set the rank target port. The default is **0**.

▶ **Tls Auth Configuration**

This submenu allows you to configure Transport Layer Security (TLS) settings.

▶ **Server CA Configuration**

▶ **Enroll Cert**

Enroll Cert Using File

Use this feature to enroll certification from a file.

Cert GUID

Use this feature to input the certification GUID.

Commit Changes and Exit

Use this feature to save all changes and exit TLS settings.

Discard Changes and Exit

Use this feature to discard all changes and exit TLS settings.

▶ **Delete Cert**

Use this feature to delete certification.

▶ **Client Cert Configuration**

► Intel I210 Gigabit Network Connection - OC:25:90:5E:E2:D4

► NIC Configuration

Link Speed

This feature allows you to specify the port speed used for the selected boot protocol. The options are **Auto Negotiated**, 10 Mbps Half, 10 Mbps Full, 100 Mbps Half, and 100 Mbps Full.

Wake On LAN

Select Enabled for Wake_On_LAN support, which will allow the system to "wake up" when an onboard device receives an incoming signal. The options are Disabled and **Enabled**.

Blink LEDs

Use this feature to identify the physical network port by blinking the associated LED. Use the keyboard to select a value. The default setting is **0**.

UEFI Driver

This feature displays the UEFI driver version.

Adapter PBA

This feature displays the Processor Bus Adapter (PBA) model number. The PBA number is a nine-digit number (i.e., 010B00-000) located near the serial number.

Device Name

This feature displays the adapter device name.

Chip Type

This feature displays the network adapter chipset name.

PCI Device ID

This feature displays the device ID number.

PCI Address

This feature displays the PCI address for this computer. PCI addresses are three two-digit hexadecimal numbers.

Link Status

This feature displays the connection status.

MAC Address

This feature displays the MAC address for this computer. Mac addresses are 6 two-digit hexadecimal numbers.

Virtual MAC Address

This feature displays the Virtual MAC address for this computer. Mac addresses are six two-digit hexadecimal numbers.

▶ Driver Health

This submenu provides the health status for the network drivers and controllers, and all UEFI drivers detected by the system.

▶ Intel(R) PRO/1000 6.5.01 PCI-E

The following Information is displayed if a controller is detected.

- Controller 9493EB18 Child 0 Healthy
- Intel I210 Gigabit Network Connection Healthy
- Controller 9493E118 Child 0 Healthy
- Intel I210 Gigabit Network Connection Healthy

▶ Intel(R) Gigabit 0.0.29

Information is displayed if a controller is detected.

4.4 Event Logs

Use this menu to configure Event Log settings.

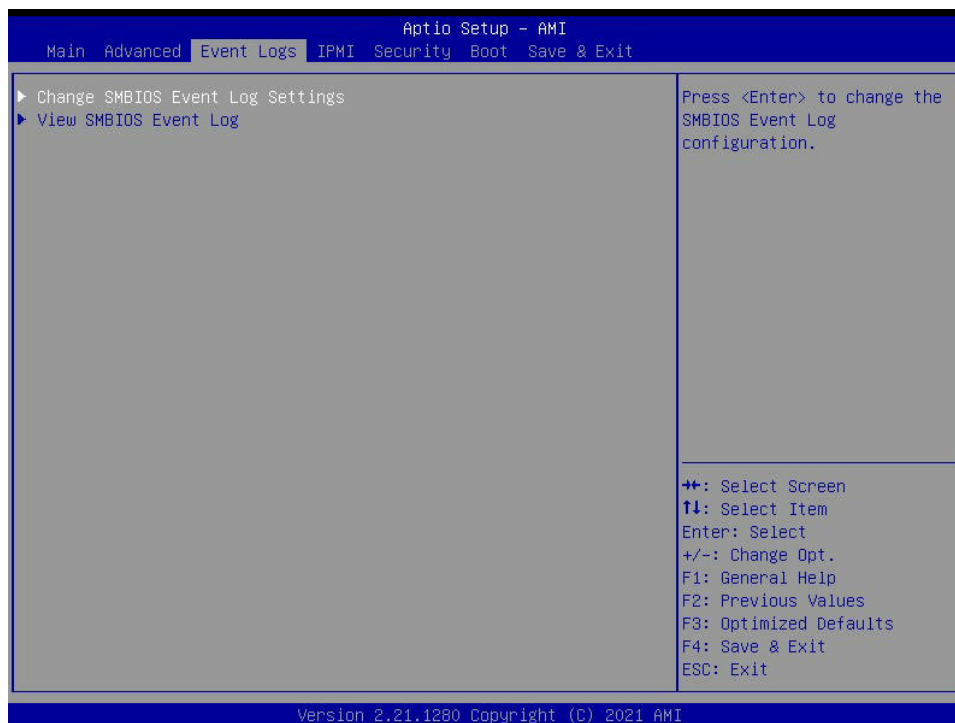

► Change SMBIOS Event Log Settings

Enabling/Disabling Options

SMBIOS Event Log

Change this feature to enable or disable all features of the SMBIOS Event Logging during system boot. The options are Disabled and **Enabled**.

Erasing Settings

Erase Event Log

If No is selected, data stored in the event log will not be erased. Select Yes, Next Reset, data in the event log will be erased upon next system reboot. Select Yes, Every Reset, data in the event log will be erased upon every system reboot. The options are **No**, Yes, Next reset, and Yes, Every reset.

When Log is Full

Select Erase Immediately for all messages to be automatically erased from the event log when the event log memory is full. The options are **Do Nothing** and Erase Immediately.

SMBIOS Event Log Standard Settings

Log System Boot Event

Select Enabled to log system boot events. The options are Enabled and **Disabled**.

MECI

Enter the increment value for the multiple event counter. Enter a number between 1 to 255. The default setting is **1**.

METW

This feature is used to determine how long (in minutes) the multiple event counter should wait before generating a new event log. Enter a number between 0 to 99. The default setting is **60**.



Note: All values changed here do not take effect until the computer is restarted.

► View SMBIOS Event Log

This feature allows you to view the event in the system event log. Select this feature and press <Enter> to view the status of an event in the log. The following information will be displayed:

Date/Time/Error Code/Severity

4.5 IPMI

Use this menu to configure Intelligent Platform Management Interface (IPMI) settings.

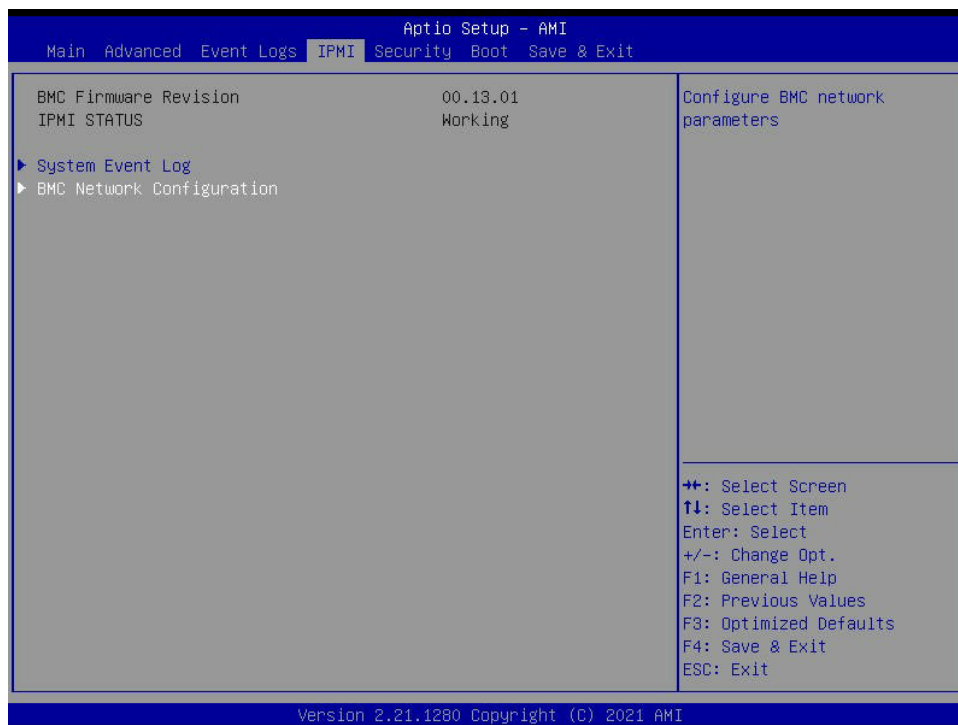

When you select this submenu and press <Enter>, the following information will display:

- **BMC Firmware Revision:** This displays the firmware revision of the Baseboard Management Controller (BMC) used in your system.
- **IPMI Status:** This displays the status of IPMI used in your system.

▶ System Event Log

Enabling/Disabling Options

SEL Components

Select Enabled for all system event logging at boot up. The options are Disabled and **Enabled**.

Erasing Settings

Erase SEL

Select Yes, On next reset to erase all system event logs upon next system reboot. Select Yes, On every reset to erase all system event logs upon each system reboot. Select No to keep all system event logs after each system reboot. The options are **No**, Yes, On next reset, and Yes, On every reset.

When SEL is Full

This feature allows you to decide what the BIOS should do when the system event log is full. Select Erase Immediately to erase all events in the log when the system event log is full. The options are **Do Nothing** and Erase Immediately.



Note: All values changed here do not take effect until the computer is restarted.

► BMC Network Configuration

--BMC Network Configuration--

Update IPMI LAN Configuration

Select Yes for the BIOS to implement all IP/MAC address changes at the next system boot. The options are **No** and **Yes**.

****If the feature above is set to Yes, Configuration Address Source, VLAN, and IPv6 Support are available for configuration:***

Configure IPv4 Support

IPMI LAN Selection

Use this feature to select the type of the IPMI LAN. The default setting is **Failover**.

IPMI Network Link Status

This feature displays the status of the IPMI network link for this system. The default setting is **Dedicated LAN**.

Configuration Address Source

Use this feature to select the IP address source for this computer. If Static is selected, you will need to know the IP address of this computer and enter it to the system manually in the field. If DHCP is selected, AMI BIOS will search for a Dynamic Host Configuration Protocol (DHCP) server attached to the network and request the next available IP address for this computer. The options are **DHCP** and **Static**.

****If the feature above is set to Static, the following features are available for configuration:***

Station IP Address: This feature displays the Station IP address for this computer. This should be in decimal and in dotted quad form (i.e., 172.29.176.131).

Subnet Mask: This feature displays the sub-network that this computer belongs to. The value of each three-digit number separated by dots should not exceed 255.

Station MAC Address: This feature displays the Station MAC address for this computer. Mac addresses are six two-digit hexadecimal numbers.

Gateway IP Address: This feature displays the Gateway IP address for this computer. This should be in decimal and in dotted quad form (i.e., 172.29.0.1).

VLAN: This feature displays the status of VLAN support. The default setting is **Disable**.

Configure IPv6 Support

IPv6 Address Status: (This feature displays the status of IPv6 addresses).

IPv6 Support: IPv6 is supported in BMC. The options are **Enabled** and Disabled.

Configuration Address Source

Use this feature to select the IP address source for this computer. If Static is selected, you will need to know the IP address of this computer and enter it to the system manually in the field. If DHCP is selected, AMI BIOS will search for a Dynamic Host Configuration Protocol (DHCP) server attached to the network and request the next available IP address for this computer. The options are **DHCP** and Static.

Station IPv6 Address: This feature displays the station IPv6 address.

Prefix Length: This feature displays the prefix length.

IPv6 Router1 IP Address: This feature displays the IP address of the IPv6 router.

4.6 Security

Use this menu to configure Security settings.

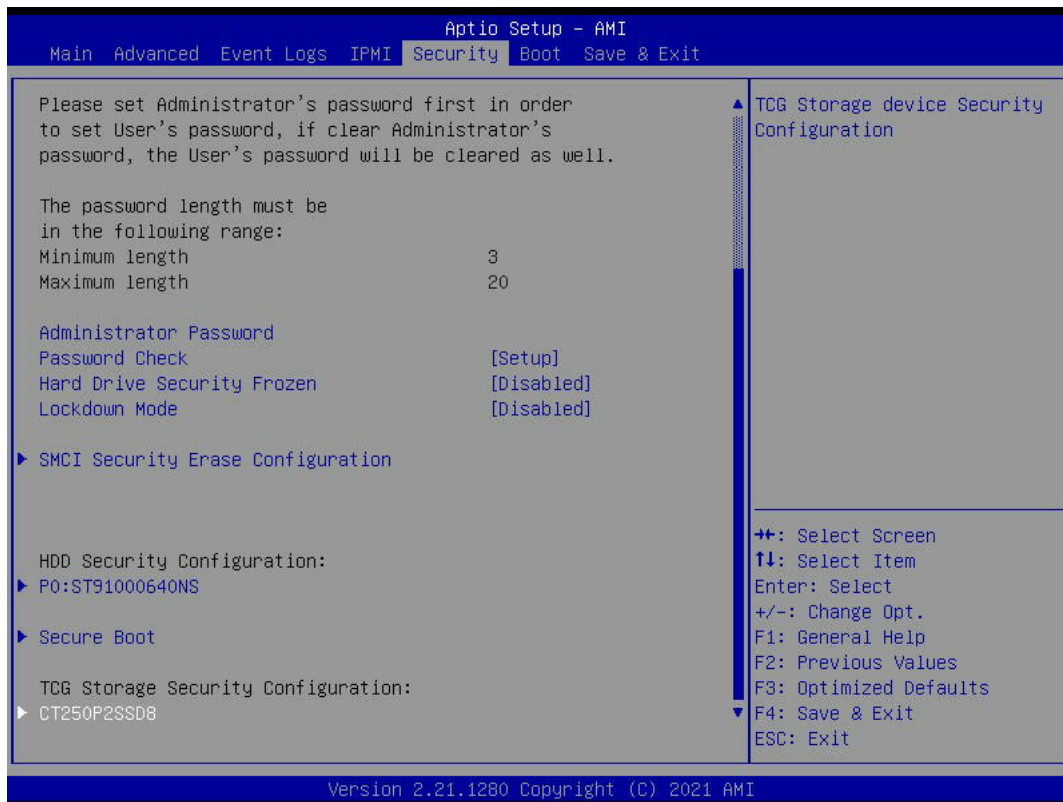

Please set Administrator's password first in order to set User password. If the Administrator password is cleared, the User password will be cleared as well. The length of the password should be from three to 20 characters long.

Administrator Password

Use this feature to set the administrator password, which is required to enter the BIOS setup utility.

Password Check

Use this feature to determine when a password entry is required. Select Setup to require the password only when entering setup. Select Always to require the password when entering setup and at each bootup. The options are **Setup** and Always.

Hard Drive Security Frozen

Use this feature to enable or disable the BIOS security frozen command for SATA and NVMe devices. The options are Enabled and **Disabled**.

Lockdown Mode

Use this feature to enable or disable the Lockdown Mode. The options are **Disabled** and Enabled. (This feature is grayed out when the DCMS Key is not installed).

► **SMCI Security Erase Configuration**

This section displays the following information if a storage device is detected by the system.

- HDD Name
- HDD Serial Number
- Security Mode
- Estimated Time
- Admin Pwd Status

Security Function

Select Password to set an HDD/SATA password, which will allow you to configure the security settings of the HDD/SATA device. Select Security Erase - Password to enter a SATA user password to erase the password and the contents previously stored in the HDD/SATA device. Select Security Erase - Without Password to use the manufacturer default password "11111111" as the SATA user password and to erase the contents of the HDD/SATA device by using this default password. The options are **Disable**, Set Password, Security Erase-Password, and Security Erase-Without Password.

Password

Use this feature to set the SATA user password, which will allow you to configure the SMCI Security Erase settings by using the SATA user password.

HDD Security Configuration:

► **P0: ST9100064ONS**

HDD Password Description:

Use this feature to set, modify, and clear both HDD User Password and HDD Master Password. An installed HDD User Password is required to enable HDD security features.

HDD Master Password can be modified only when it is successfully unlocked in POST. If 'Set HDD Password' options is grayed out, do power cycle to enable it.

HDD PASSWORD CONFIGURATION:

Security Supported: Yes

Security Enabled: No

Security Locked: No

Security Frozen: No

HDD Password Pwd Status: Not INSTALLED

HDD Master Pwd Status: INSTALLED

Set User Password

This option allows you to set up HDD User Password. It is advisable to Power Cycle System after Setting Hard Disk Password.

Set Master Password

This option allows you to set up Master Password.

▶ Secure Boot

- System Mode
- Secure Boot

Secure Boot

Select Enable for secure boot support to ensure system security at bootup. The options are **Disabled** and Enabled.

Secure Boot Mode

Select the desired secure boot mode for the system. The options are Standard and **Custom**.

CSM Support

This feature is used to enable or disable CSM support. The options are Disabled and **Enabled**.

****If Secure Boot Mode is set to Standard, Restore Factory Keys, Reset to Setup Mode, Exit Deployed Mode, and Key Management will be grayed out.***

▶ Restore Factory Keys

Select Yes to restore all factory keys to the default settings. The options are Yes and No.

▶ Reset to Setup Mode

This feature deletes all Secure Boot key databases from NVRAM.

▶ Enter Audit Mode

This feature allows you to enter the Audit Mode workflow. Please note that changing from User Mode to Audit Mode will erase Platform Key (PK) variables.

▶ Exit Deployed Mode

This feature allows you to transition between Deployment and User Modes.

▶ Key Management

This submenu allows you to configure the following Key Management settings.

Vendor Keys

Provision Factory Key

Select Enabled to install the default Secure Boot keys set by the manufacturer. The options are **Disabled** and Enabled.

**If the feature above is enabled, the following items are available for configuration:*

▶ Restore Factory Keys

Select Yes to restore Secure Boot keys to factory default. The options are Yes and No.

▶ Reset to Setup Mode

Select Yes to delete NVRAM content from all of UEFI Secure Boot key databases. The options are Yes and No.

▶ Export Secure Boot variables

Select Yes to copy NVRAM content to a file in the root folder. The options are Yes and No.

▶ Enroll Efi Image

This feature allows the image to run in Secure Boot mode.

Device Guard Ready

▶ Remove 'UEFI CA' from DB

Select Yes to remove UEFI CA from the list of Microsoft Certified DB database. The options are Yes and No.

▶ Restore DB defaults

Select Yes to restore DB variables to factory default. The options are Yes and No.

Secure Boot variable | Size | Keys | Key Source

▶ Platform Key (PK)

Use this menu to configure the setting for platform keys.

Details

Select this feature to view PK information.

Export

Select this feature to export the PK from a file system.

Update

Select Yes to load the PK from factory default or No to load from a file or external media.

Delete

Select ok to remove the PK. Reset the system for it to enter Setup/Audit Mode.

▶ Key Exchange Keys

Use this menu to configure the setting for key exchange keys.

Details

Select this feature to view KEK information.

Export

Select this feature to export the KEK from a file system.

Update

Select Yes to load the KEK from factory default or No to load from a file or external media.

Append

Select Yes to load the KEK from factory default or No to load from a file or external media.

Delete

Select Yes to delete the variable or No to delete a certificate from the key database.

▶ Authorized Signatures

Use this menu to configure the setting for db keys.

Details

Select this feature to view authorized signatures information.

Export

Select this feature to export the db from a file system.

Update

Select Yes to load the db from factory default or No to load from a file or external media.

Append

Select Yes to load the db from factory default or No to load from a file or external media.

Delete

Select Yes to delete the variable or No to delete a certificate from the key database.

▶ Forbidden Signatures

Use this menu to configure the setting for dbx keys.

Details

Select this feature to view forbidden signatures information.

Export

Select this feature to export the dbx from a file system.

Update

Select Yes to load the dbx from factory default or No to load from a file or external media.

Append

Select Yes to load the dbx from factory default or No to load from a file or external media.

Delete

Select Yes to delete the variable or No to delete a certificate from the key database.

▶ **Authorized TimeStamps**

Use this feature to configure the setting for dbt keys.

Details

Select this feature to view authorized time stamp information.

Export

Select this feature to export the dbt from a file system.

Update

Select Yes to load the dbt from factory default or No to load from a file or external media.

Append

Select Yes to load the dbt from factory default or No to load from a file or external media.

Delete

Select Yes to delete the variable or No to delete a certificate from the key database.

▶ **OsRecovery Signature**

Use this feature to configure the setting for dbr keys.

Details

Select this feature to view authorized time stamp information.

Export

Select this feature to export the dbr from a file system.

Update

Select Yes to load the dbr from factory default or No to load from a file or external media.

Append

Select Yes to load the dbr from factory default or No to load from a file or external media.

Delete

Select Yes to delete the variable or No to delete a certificate from the key database.TCG Storage Security Configuration:

▶CT250P2SSD8**TCG Storage Password Description:**

Use this feature to set, modify, and clear both TCG Storage device Admin and User passwords. An installed Admin Password is required to enable TCG Storage security features and to create the User Password.

Using Admin Password alone can lock and unlock the TCG storage device while User Password acts as an optional credential to unlock the device in POST.

The options, 'Set Admin Password' and 'Set User Password', are grayed out when the system detects a security freeze lock caused by the boot failure.

Perform a cold boot (power off and then power on) on the system and press the hot key to enter BIOS.

PASSWORD CONFIGURATION:

Security Subsystem Class: Pyrite 1.0

Security Supported: Yes

Security Enabled: No

Security Locked: No

Security Frozen: No

User Pwd Status: Not INSTALLED

Admin Pwd Status: INSTALLED

Set Admin Password

This feature allows you to set the administrator password, which is required to enter the BIOS setup utility. The length of the password should be three to 20 characters.

Set User Password

This feature allows you to set up the user password, which is required to enter the BIOS setup utility. It is grayed out by default but will be available for setup when the admin password is entered. The length of the password should be three to 20 characters.

Device Reset

This feature allows you to reset the device to the Original Factory State and it will completely erases the user data from the hard drive.

4.7 Boot

Use this menu to configure Boot settings:

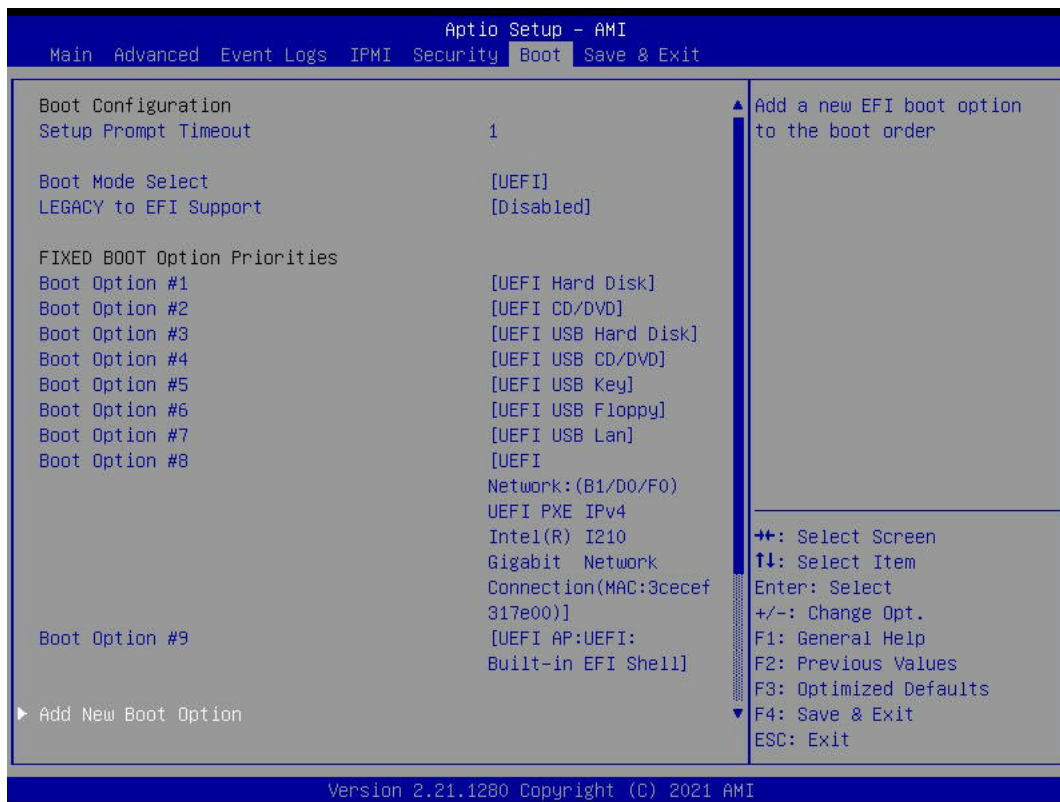

Boot Configuration

Setup Prompt Timeout

Number of seconds to wait for the setup activation key. 65535(0xFFFF) means indefinite waiting. The default setting is **1**.

Boot Mode Select

Use this feature to select the type of device that the system is going to boot from. The options are Legacy, **UEFI**, and Dual.

Legacy to EFI Support

Select Enabled to boot EFI OS support after Legacy boot order has failed. The options are **Disabled** and Enabled.

Fixed Boot Option Priorities

This feature prioritizes the order of bootable devices that the system can boot from. Press <Enter> on each entry from top to bottom to select devices.

- Boot Option #1
- Boot Option #2
- Boot Option #3

- Boot Option #4
- Boot Option #5
- Boot Option #6
- Boot Option #7
- Boot Option #8
- Boot Option #9

► Add New Boot Option

This option allows you to add a new boot option to the boot priority features for system boot.

Add Boot Option

This feature allows you to specify the name for the new boot option.

Path for Boot Option

Use this feature to enter the path for the new boot option in the format fsx:\path\filename.efi.

Boot Option File Path

This feature allows you to specify the file path for the new boot option.

Create

After the name and the file path for the boot option are set, press <Enter> to create the new boot option in the boot priority list.

► Delete Boot Option

Click on this menu to delete a boot device from the boot priority list.

Delete Boot Option

Use this feature to remove an EFI boot option from the boot priority list.

► Add New Driver Option

This feature allows you to select a new driver to add to the boot priority list.

Add Driver Option

This feature allows you to specify the name of the driver to be added to the boot priority list.

Path for Driver Option

This feature allows you to specify the path to the driver that will be added to the boot priority list.

Driver Option File Path

This feature allows you to specify the file path of the driver that will be added to the boot priority list.

Create

After the driver option name and the file path are set, press <Enter> to enter to submenu and click OK to create the new boot option drive.

► Delete Driver Option

This feature allows you to remove an EFI driver option from the driver order.

Delete Driver Option

Use this feature to remove an EFI driver option from the driver order.

► UEFI NETWORK Drive BBS Priorities

This feature allows you to specify which network drives are boot devices.

- Boot Option #1
- Boot Option #2
- Boot Option #3
- Boot Option #4

► UEFI Application Boot Priorities

This feature allows you to specify which UEFI application devices are boot devices.

- Boot Option #1

4.8 Save & Exit

Select the Exit tab from the BIOS setup utility screen to enter the Exit BIOS Setup screen.

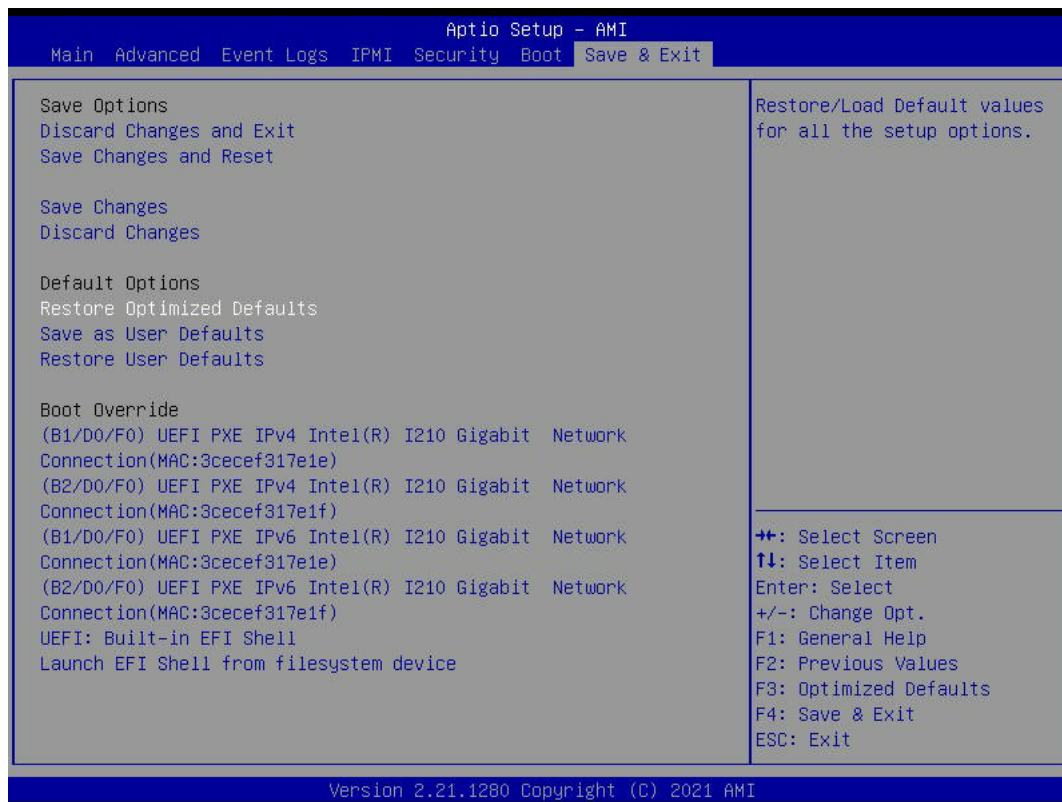

Save Options

Discard Changes and Exit

Select this feature to exit the BIOS without saving any changes.

Save Changes and Reset

When you have completed the system configuration changes, select this option to save all changes made and reset the system.

Save Changes

When you have completed the system configuration changes, select this option to save all changes made. This does not reset (reboot) the system.

Discard Changes

Select this feature and press <Enter> to discard all the changes and return to the AMI BIOS Utility Program.

Default Options

Restore Optimized Defaults

To set this feature, select Restore Defaults from the Exit menu and press <Enter>. These are factory settings designed for maximum system performance but not for maximum stability.

Save as User Defaults

To set this feature, select Save as User Defaults from the Exit menu and press <Enter>. This enables you to save any changes to the BIOS setup for future use.

Restore User Defaults

To set this feature, select Restore User Defaults from the Exit menu and press <Enter>. Use this feature to retrieve user-defined settings that were saved previously.

Boot Override

This feature allows you to override the Boot priorities sequence in the Boot menu, and immediately boot the system with a device specified by the user instead of the one specified in the boot list. This is a one-time override.

**(B1/D0/F0) UEFI PXE IPv4 Intel(R) I210 Gigabit Newtwork Connection
(MAC:3cecef317e00)**

**(B2/D0/F0) UEFI PXE IPv4 Intel(R) I210 Gigabit Newtwork Connection
(MAC:3cecef317e01)**

**(B1/D0/F0) UEFI PXE IPv6 Intel(R) I210 Gigabit Newtwork Connection
(MAC:3cecef317e00)**

**(B2/D0/F0) UEFI PXE IPv6 Intel(R) I210 Gigabit Newtwork Connection
(MAC:3cecef317e01)**

UEFI: Built-in EFI Shell

Launch EFI Shell from filesystem device

Appendix A

BIOS Codes

BIOS POST Codes

The AMI BIOS supplies additional checkpoint codes, which are documented online at <http://www.supermicro.com/support/manuals/> ("AMI BIOS POST Codes User's Guide").

When BIOS performs the Power On Self Test, it writes checkpoint codes to I/O port 0080h. If the computer cannot complete the boot process, a diagnostic card can be attached to the computer to read I/O port 0080h (Supermicro p/n AOC-LPC80-20).

For information on AMI updates, please refer to <http://www.ami.com/products/>.

Appendix B

Software

After the hardware has been installed, you can install the Operating System (OS), configure RAID settings and install the drivers.

B.1 Microsoft Windows OS Installation

If you will be using RAID, you must configure RAID settings before installing the Windows OS and the RAID driver. Refer to the RAID Configuration User Guides posted on our website at www.supernmicro.com/support/manuals.

Installing the OS

1. Create a method to access the MS Windows installation ISO file. That USB flash or media drive.
2. Retrieve the proper RST/RSTe driver. Go to the Supermicro web page for your motherboard and click on "Download the Latest Drivers and Utilities", select the proper driver, and copy it to a USB flash drive.
3. Boot from a bootable device with Windows OS installation. You can see a bootable device list by pressing **F11** during the system startup.

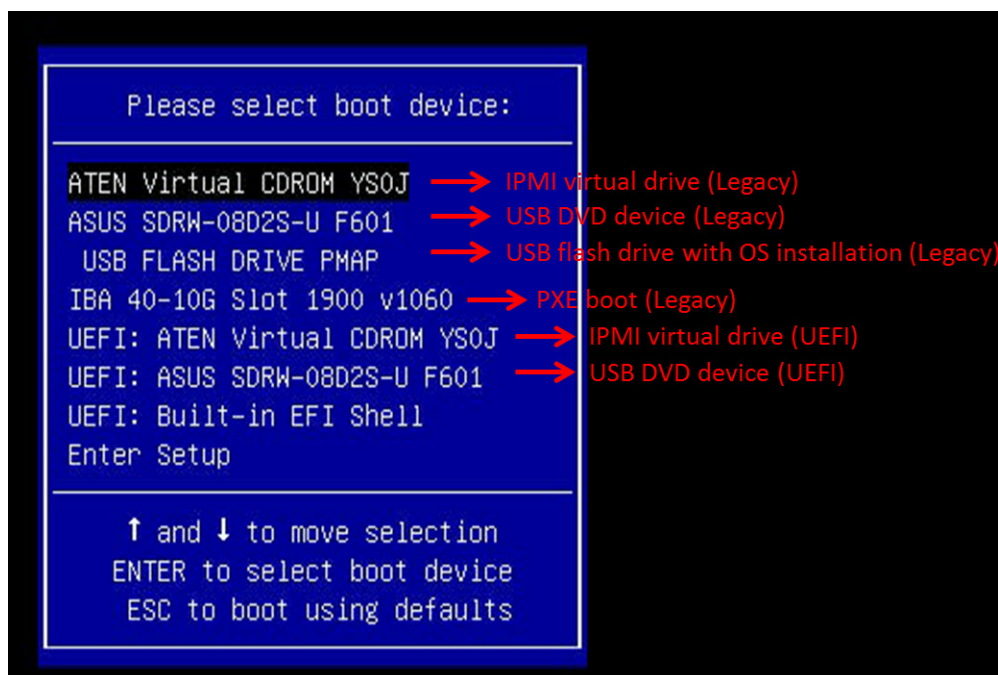

Figure B-1. Select Boot Device

4. During Windows Setup, continue to the dialog where you select the drives on which to install Windows. If the disk you want to use is not listed, click on “Load driver” link at the bottom left corner.

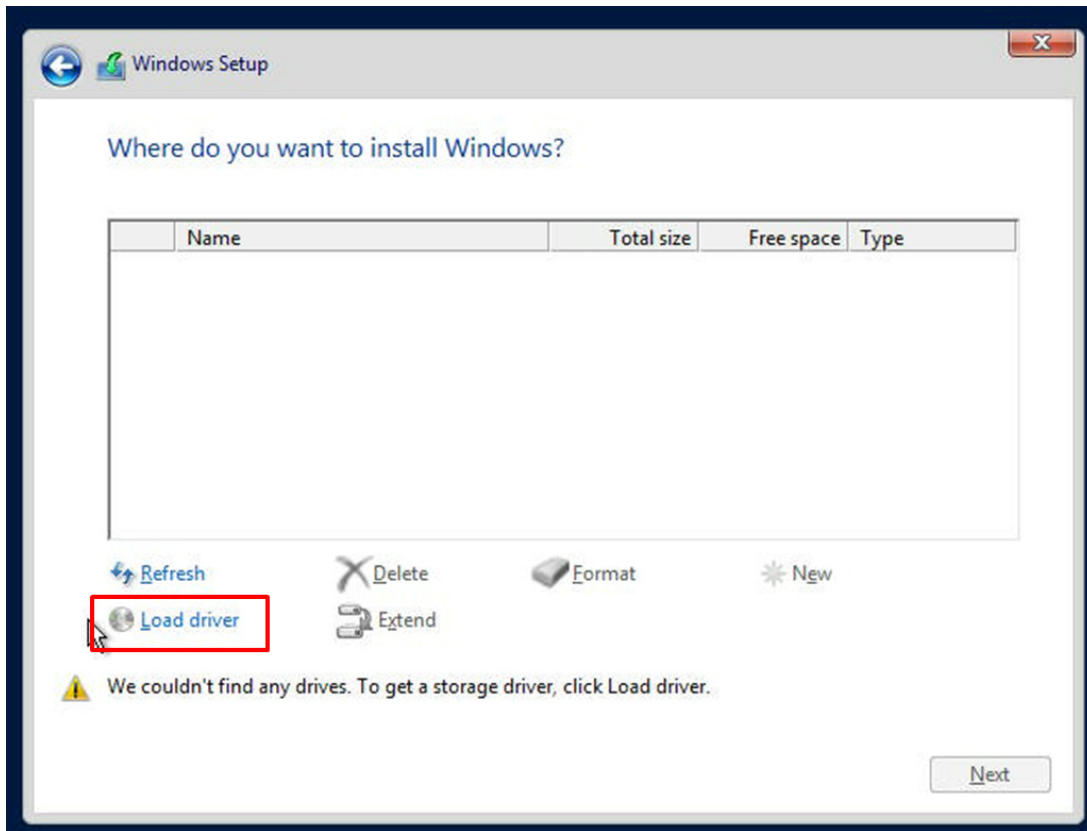

Figure B-2. Load Driver Link

To load the driver, browse the USB flash drive for the proper driver files.

- For RAID, choose the SATA/sSATA RAID driver indicated then choose the storage drive on which you want to install it.
 - For non-RAID, choose the SATA/sSATA AHCI driver indicated then choose the storage drive on which you want to install it.
5. Once all devices are specified, continue with the installation.
 6. After the Windows OS installation has completed, the system will automatically reboot multiple times.

B.2 Driver Installation

The Supermicro website that contains drivers and utilities for your system is at <https://www.supermicro.com/wdl/driver/>. Some of these must be installed, such as the chipset driver.

After accessing the website, go to https://www.supermicro.com/wdl/CDR_Images/CDR-X12-UP/ to locate the ISO file for your motherboard. Download this file to a USB flash or media drive. You may also use a utility to extract the ISO file if preferred.

Another option is to go to the Supermicro website and search for the motherboard. Find the product page for your motherboard and download the latest drivers and utilities.

Insert the flash drive or disk and the screenshot shown below should appear.

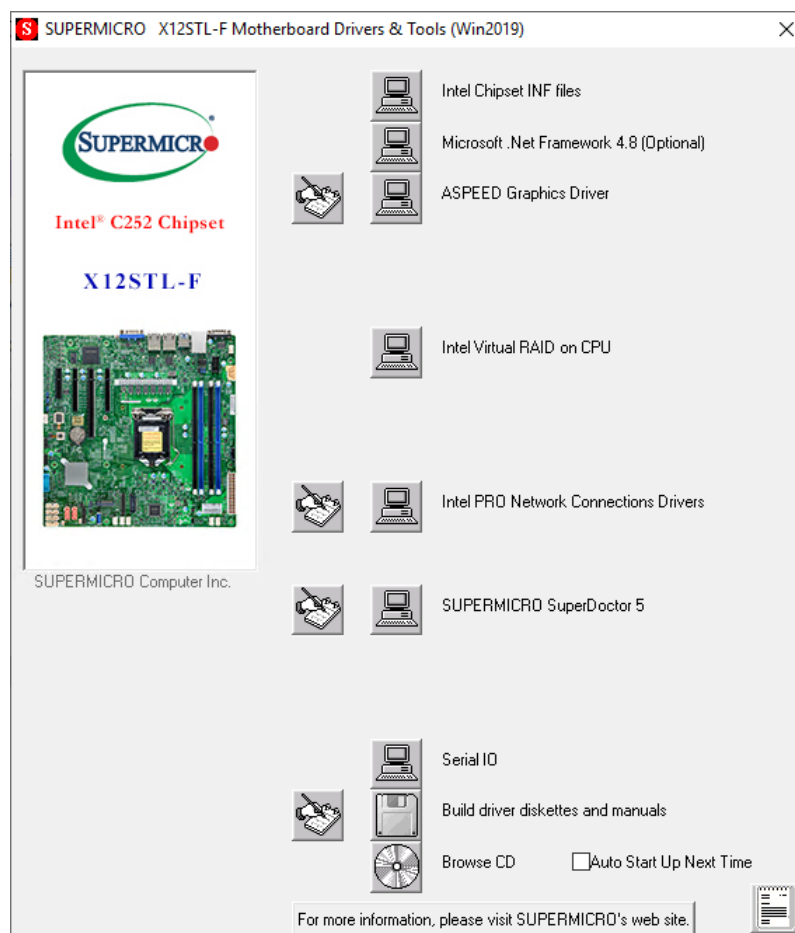

Figure B-3. Driver & Tool Installation Screen



Note: Click the icons showing a hand writing on paper to view the readme files for each item. Click the computer icons to the right of these items to install each item (from top to bottom) one at a time. **After installing each item, you must reboot the system before moving on to the next item on the list.** The bottom icon with a CD on it allows you to view the entire contents.

B.3 SuperDoctor® 5

The Supermicro SuperDoctor 5 is a program that functions in a command-line or web-based interface for Windows and Linux operating systems. The program monitors such system health information as CPU temperature, system voltages, system power consumption, fan speed, and provides alerts via email or Simple Network Management Protocol (SNMP).

SuperDoctor 5 comes in local and remote management versions and can be used with Nagios to maximize your system monitoring needs. With SuperDoctor 5 Management Server (SSM Server), you can remotely control power on/off and reset chassis intrusion for multiple systems with SuperDoctor 5. SuperDoctor 5 Management Server monitors HTTP, FTP, and SMTP services to optimize the efficiency of your operation.

Note: The default User Name and Password for SuperDoctor 5 is ADMIN / ADMIN.

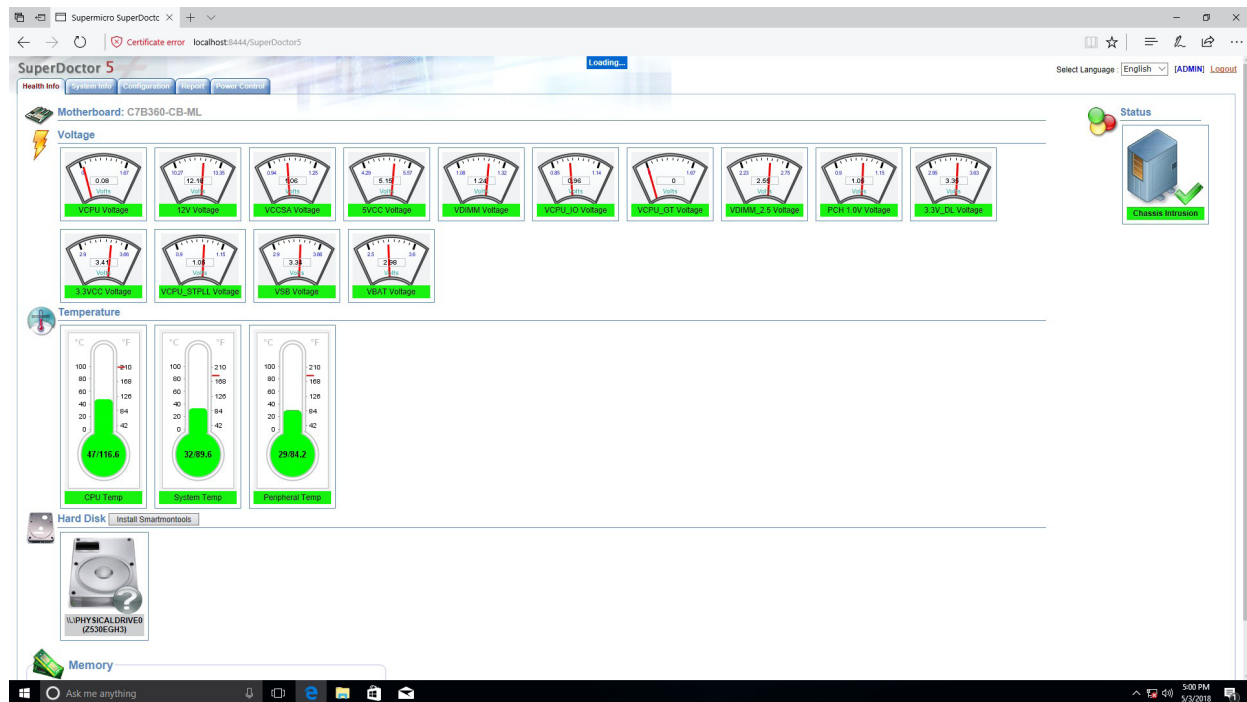

Figure B-4. SuperDoctor 5 Interface Display Screen (Health Information)

Appendix C

Standardized Warning Statements

The following statements are industry standard warnings, provided to warn the user of situations which have the potential for bodily injury. Should you have questions or experience difficulty, contact Supermicro's Technical Support department for assistance. Only certified technicians should attempt to install or configure components.

Read this section in its entirety before installing or configuring components.

These warnings may also be found on our website at http://www.supermicro.com/about/policies/safety_information.cfm.

Battery Handling



Warning! There is the danger of explosion if the battery is replaced incorrectly. Replace the battery only with the same or equivalent type recommended by the manufacturer. Dispose of used batteries according to the manufacturer's instructions

電池の取り扱い

電池交換が正しく行われなかった場合、破裂の危険性があります。交換する電池はメーカーが推奨する型、または同等のものを使用下さい。使用済電池は製造元の指示に従って処分して下さい。

警告

電池更換不當會有爆炸危險。請只使用同類電池或制造商推薦的功能相當的電池更換原有電池。請按製造商的說明處理廢舊電池。

警告

電池更換不當會有爆炸危險。請使用製造商建議之相同或功能相當的電池更換原有電池。請按照製造商的說明指示處理廢棄舊電池。

Warnung

Bei Einsetzen einer falschen Batterie besteht Explosionsgefahr. Ersetzen Sie die Batterie nur durch den gleichen oder vom Hersteller empfohlenen Batterietyp. Entsorgen Sie die benutzten Batterien nach den Anweisungen des Herstellers.

Attention

Danger d'explosion si la pile n'est pas remplacée correctement. Ne la remplacer que par une pile de type semblable ou équivalent, recommandée par le fabricant. Jeter les piles usagées conformément aux instructions du fabricant.

¡Advertencia!

Existe peligro de explosión si la batería se reemplaza de manera incorrecta. Reemplazar la batería exclusivamente con el mismo tipo o el equivalente recomendado por el fabricante. Desechar las baterías gastadas según las instrucciones del fabricante.

אזהרה!

קיימת סכנת פיצוץ של הסוללה במידה והוחלפה בדרך לא תקינה. יש להחליף את הסוללה בסוג התואם מחברת יצרן מומלצת. סילוק הסוללות המשומשות יש לבצע לפי הוראות היצרן.

هناك خطر من انفجار في حالة اسبدال البطارية بطريقة غير صحيحة فعلي
اسبدال البطارية فقط بنفس النوع أو ما يعادلها مما أوصت به الشركة المصنعة
جخلص من البطاريات المسحمة وفقا لعمليات الشركة الصانعة

경고!

배터리가 올바르게 교체되지 않으면 폭발의 위험이 있습니다. 기존 배터리와 동일하거나 제조사에서 권장하는 동등한 종류의 배터리로만 교체해야 합니다. 제조사의 안내에 따라 사용된 배터리를 처리하여 주십시오.

Waarschuwing

Er is ontploffingsgevaar indien de batterij verkeerd vervangen wordt. Vervang de batterij slechts met hetzelfde of een equivalent type die door de fabrikant aanbevolen wordt. Gebruikte batterijen dienen overeenkomstig fabrieksvoorschriften afgevoerd te worden.

Product Disposal



Warning! Ultimate disposal of this product should be handled according to all national laws and regulations.

製品の廃棄

この製品を廃棄処分する場合、国の関係する全ての法律・条例に従い処理する必要があります。

警告

本产品的废弃处理应根据所有国家的法律和规章进行。

警告

本產品的廢棄處理應根據所有國家的法律和規章進行。

Warnung

Die Entsorgung dieses Produkts sollte gemäß allen Bestimmungen und Gesetzen des Landes erfolgen.

¡Advertencia!

Al deshacerse por completo de este producto debe seguir todas las leyes y reglamentos nacionales.

Attention

La mise au rebut ou le recyclage de ce produit sont généralement soumis à des lois et/ou directives de respect de l'environnement. Renseignez-vous auprès de l'organisme compétent.

סילוק המוצר

אזהרה!

סילוק סופי של מוצר זה חייב להיות בהתאם להנחיות וחוקי המדינה.

عند التخلص النهائي من هذا المنتج ينبغي التعامل معه وفقا لجميع القوانين واللوائح الوطنية

경고!

이 제품은 해당 국가의 관련 법규 및 규정에 따라 폐기되어야 합니다.

Waarschuwing

De uiteindelijke verwijdering van dit product dient te geschieden in overeenstemming met alle nationale wetten en reglementen.

Appendix D

UEFI BIOS Recovery

Warning: Do not upgrade the BIOS unless your system has a BIOS-related issue. Flashing the wrong BIOS can cause irreparable damage to the system. In no event shall Supermicro be liable for direct, indirect, special, incidental, or consequential damages arising from a BIOS update. If you need to update the BIOS, do not shut down or reset the system while the BIOS is updating to avoid possible boot failure.

D.1 Overview

The Unified Extensible Firmware Interface (UEFI) provides a software-based interface between the operating system and the platform firmware in the pre-boot environment. The UEFI specification supports an architecture-independent mechanism that will allow the UEFI OS loader stored in an add-on card to boot the system. The UEFI offers clean, hands-off management to a computer during system boot.

D.2 Recovering the UEFI BIOS Image

A UEFI BIOS flash chip consists of a recovery BIOS block and a main BIOS block (a main BIOS image). The recovery block contains critical BIOS codes, including memory detection and recovery codes for the user to flash a healthy BIOS image if the original main BIOS image is corrupted. When the system power is first turned on, the boot block codes execute first. Once this process is completed, the main BIOS code will continue with system initialization and the remaining Power-On Self-Test (POST) routines.



Note 1: Follow the BIOS recovery instructions below for BIOS recovery when the main BIOS block crashes.

Note 2: When the BIOS recovery block crashes, you will need to follow the procedures to make a Returned Merchandise Authorization (RMA) request. (For a RMA request, please see section 3.5 for more information).

D.3 Recovering the BIOS Block with a USB Device

This feature allows the user to recover the main BIOS image using a USB-attached device without additional utilities used. A USB flash or media drive can be used for this purpose. However, a USB Hard Disk drive cannot be used for BIOS recovery at this time.

The file system supported by the recovery block is FAT (including FAT12, FAT16, and FAT32), which is installed on a bootable or non-bootable USB-attached device. However, the BIOS might need several minutes to locate the SUPER.ROM file if the media size becomes too large due to the huge volumes of folders and files stored in the device.

To perform UEFI BIOS recovery using a USB-attached device, follow the instructions below:

1. Using a different machine, copy the "Super.ROM" binary image file into the disc Root "\\" directory of a USB flash or media drive.

 **Note 1:** If you cannot locate the "Super.ROM" file in your driver disk, visit our website at www.supermicro.com to download the BIOS package. Extract the BIOS binary image into a USB flash device and rename it "Super.ROM" for the BIOS recovery use.



 **Note 2:** Before recovering the main BIOS image, confirm that the "Super.ROM" binary image file you download is the same version or a close version meant for your motherboard.

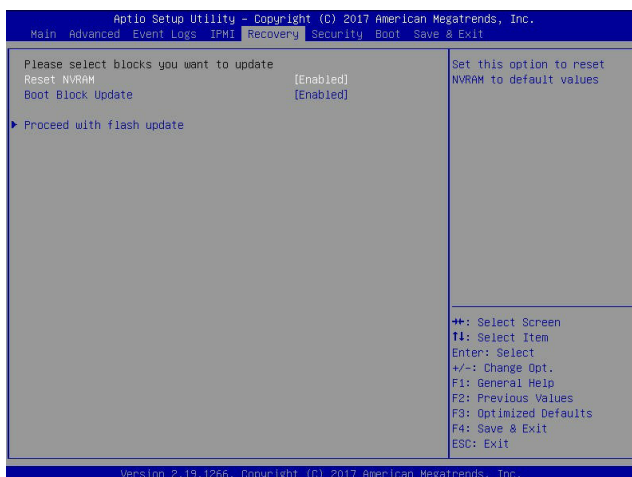

2. Insert the USB device that contains the new BIOS image ("Super.ROM") into your USB port and reset the system until the following screen appears:
3. After locating the new BIOS binary image, the system will enter the BIOS Recovery menu as shown below:

 **Note:** At this point, you may decide if you want to start the BIOS recovery. If you decide to proceed with BIOS recovery, follow the procedures below.

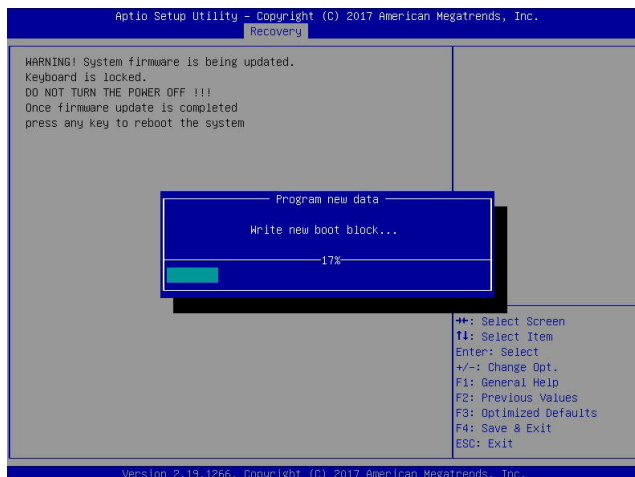

- When the screen as shown above displays, use the arrow keys to select the item "Proceed with flash update" and press the <Enter> key. You will see the BIOS recovery progress as shown in the screen below:

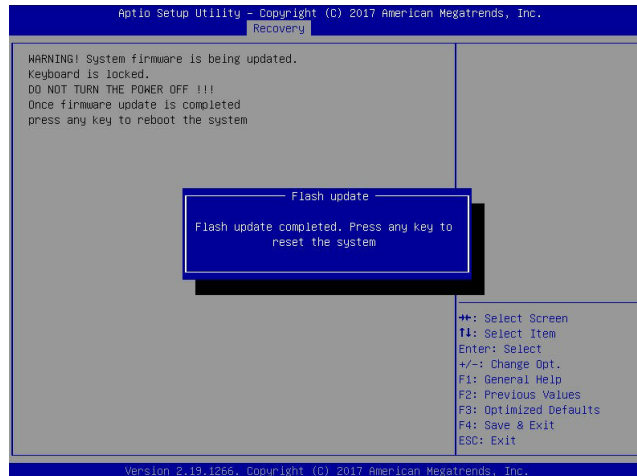

Note: Do not interrupt the BIOS flashing process until it has completed.

- After the BIOS recovery process is completed, press any key to reboot the system.
- Using a different system, extract the BIOS package into a USB flash drive.
- Press during system boot to enter the BIOS Setup utility. From the top of the tool bar, select Boot to enter the submenu. From the submenu list, select Boot Option #1 as shown below. Then, set Boot Option #1 to [UEFI AP:UEFI: Built-in EFI Shell]. Press <F4> to save the settings and exit the BIOS Setup utility.

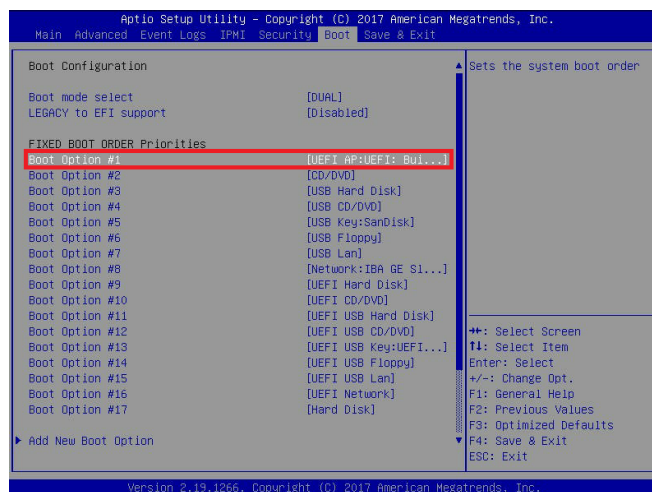

8. When the UEFI Shell prompt appears, type `fs#` to change the device directory path. Go to the directory that contains the BIOS package you extracted earlier from Step 6. Enter `flash.nsh BIOSname.###` at the prompt to start the BIOS update process.

```

UEFI Interactive Shell v2.1
EDK II
UEFI v2.50 (American Megatrends, 0x0005000C)
Mapping Table
  FS0: Alias(s):HD0:0B:BLK1:
      PciRoot(0x0)/Pci(0x14,0x0)/USB(0x11,0x0)/HD(1,MBR,0x37901D72,0x800,0x1
DR3592)
  BLK0: Alias(s):
      PciRoot(0x0)/Pci(0x14,0x0)/USB(0x11,0x0)
Press F8P in 1 seconds to skip startup.nsh or any other key to continue.
Shell> fs0:
FS0:\> cd AFUDOS
FS0:\AFUDOS> cd SKJPM2_03162017
FS0:\AFUDOS\SKJPM2_03162017> flash.nsh X110PU7_314

```



Note: Do not interrupt this process until the BIOS flashing is complete.

```

Done.
[ Access Cmos Port Ex ]
<Read>
Index 0x51: 0x10

Done.
*****
*
* Program BIOS and ME (including FDT) regions...
*
*****
| AMT Firmware Update Utility v5.09.01.1917
| Copyright (C)2017 American Megatrends Inc. All Rights Reserved.
|-----|
CPUID = 50652

Reading flash ..... done
- ME Data Size checking - ok
- FFS checksums ..... ok
- Check RomLayout ..... Ok
Erasing Boot Block ..... done
Updating Boot Block ..... done
Verifying Boot Block ..... done
_Erasing Main Block ..... 0x00132000 (0x)

```

```

Verifying NCB Block ..... done
- Update success for FDR
- Update success for IE
- Successful Update Recovery Loader to OPRx11
- Successful Update MFSB11-
- Successful Update FTPR11-
- Successful Update MFS, IMB1 and IMB211
- Successful Update FLOS and UTRx11
- ME Entire Image update success !!

WARNING : System must power-off to have the changes take effect!
Moving FS0:\AFUDOS\SKJPM2_03162017\Fdtx64.efi -> FS0:\AFUDOS\SKJPM2_03162017\F
dt.smc
- [ok]
Moving FS0:\AFUDOS\SKJPM2_03162017\afuef1x64.efi -> FS0:\AFUDOS\SKJPM2_0316201
7\afuef1.smc
- [ok]
*****
* Please ignore this "Shell: Cannot read from file - Device Error"
* warning message due to it does not impact flashing process.
*
*****
Deleting "afuef1.smc"
Delete successful.
FS0:\>

```

9. The screen above indicates that the BIOS update process is complete. When you see the screen above, unplug the AC power cable from the power supply, clear CMOS, and plug the AC power cable in the power supply again to power on the system.
10. Press `` to enter the BIOS Setup utility.
11. Press `<F3>` to load the default settings.
12. After loading the default settings, press `<F4>` to save the settings and exit the BIOS Setup utility.