

# Let's Get Started

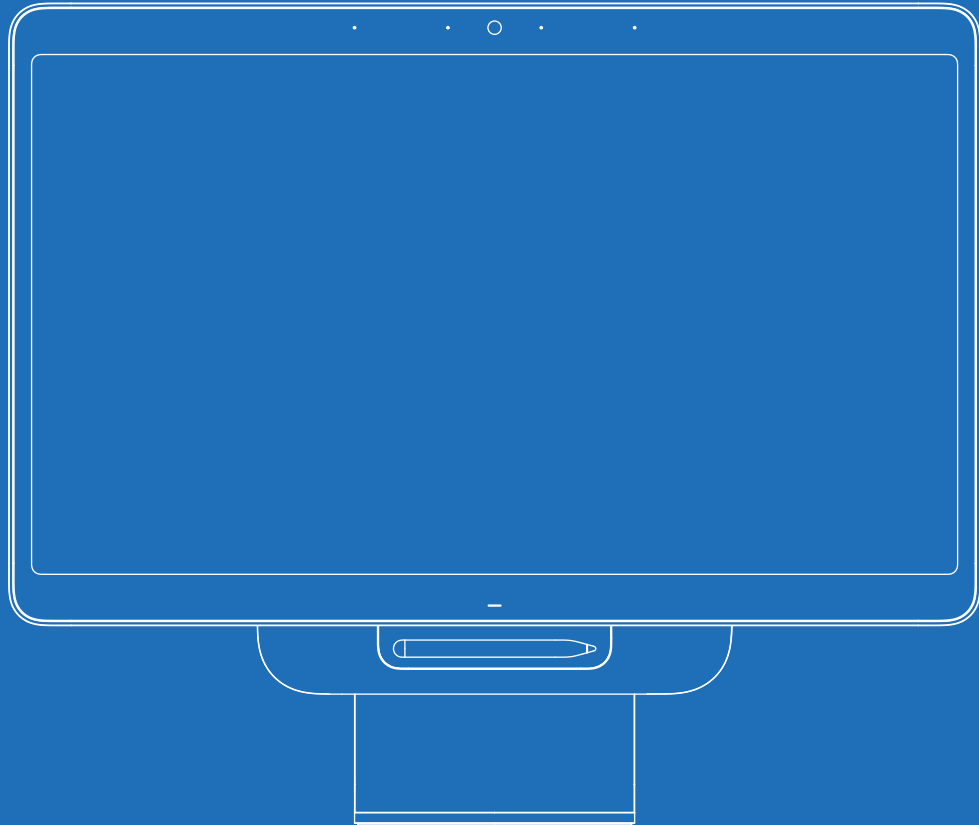

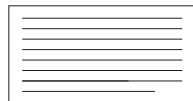

1

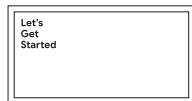
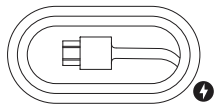
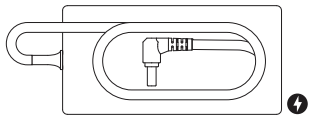
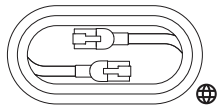
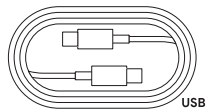
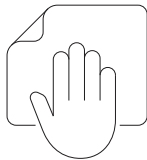
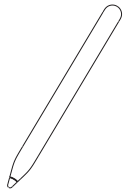
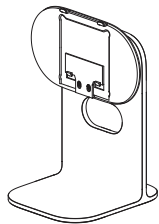
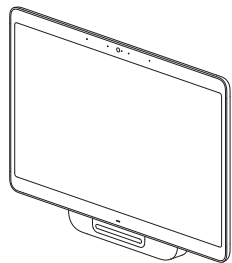
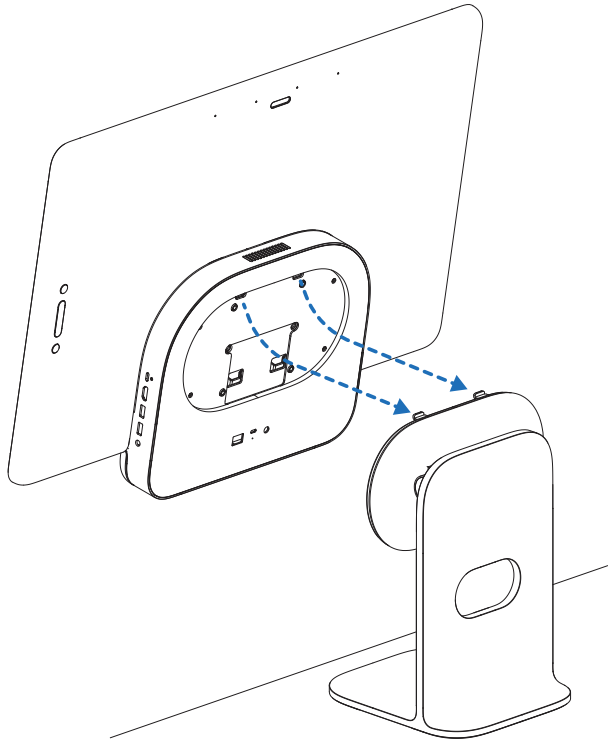

2

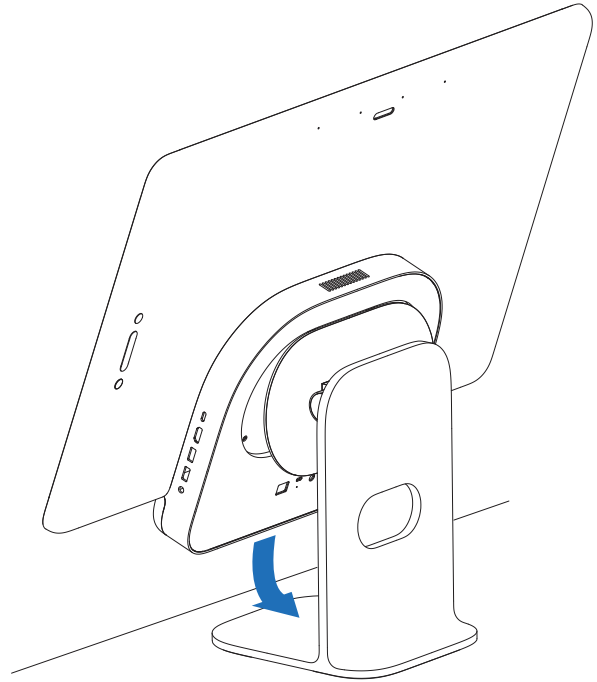

3

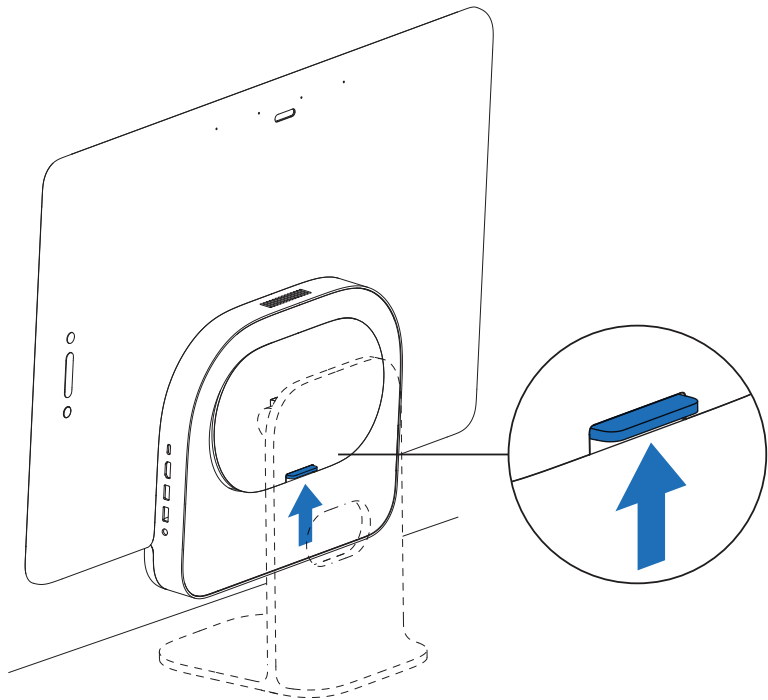

4

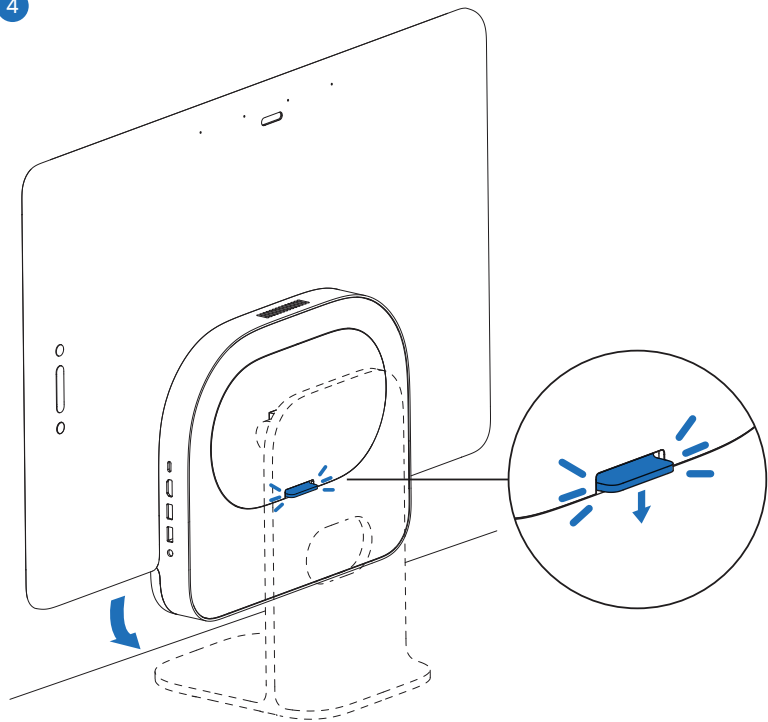

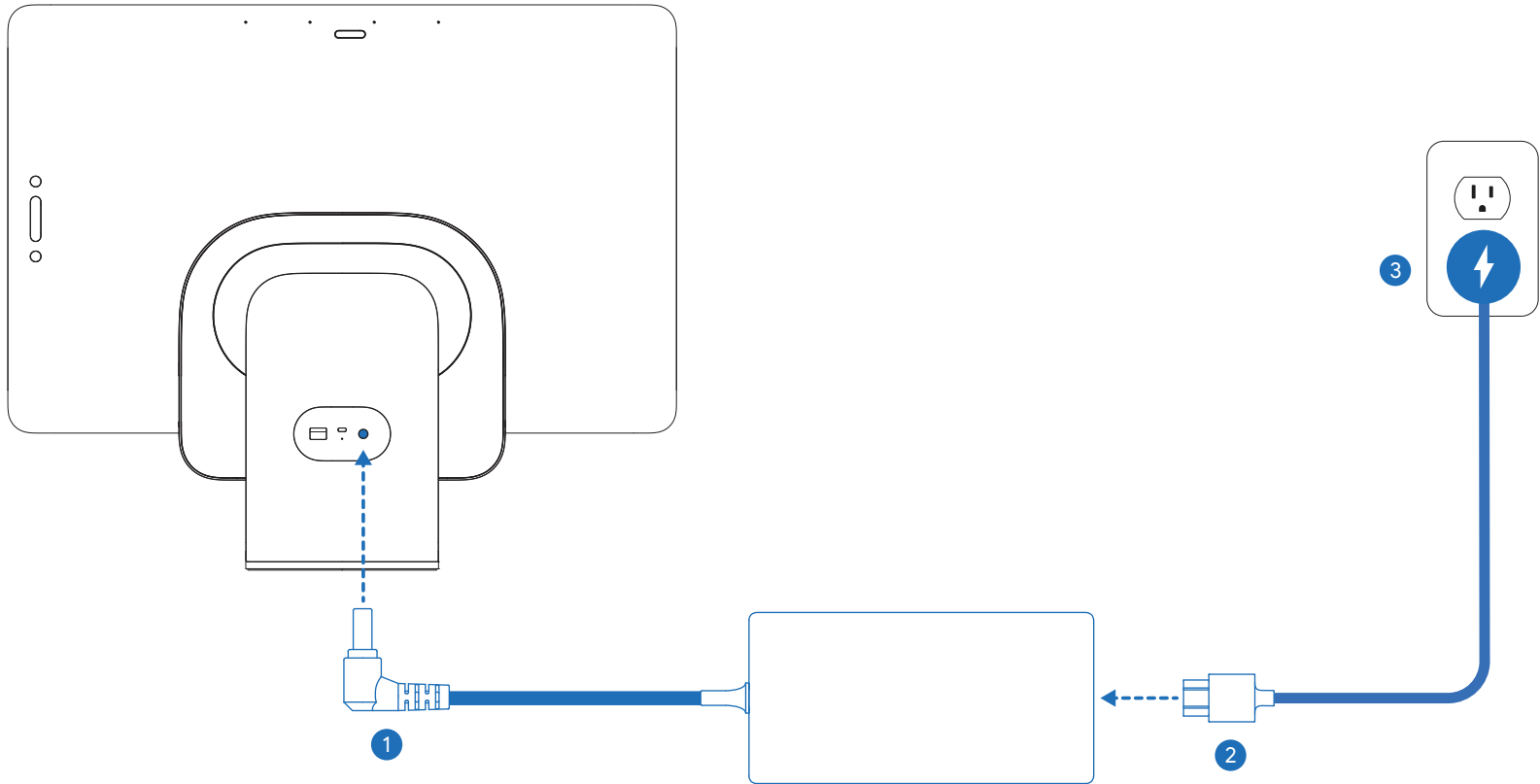

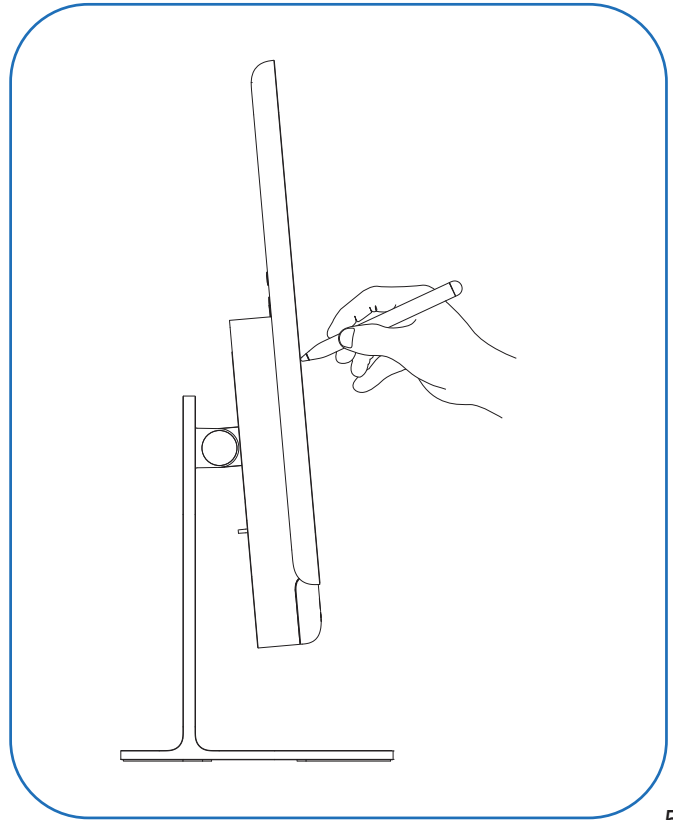
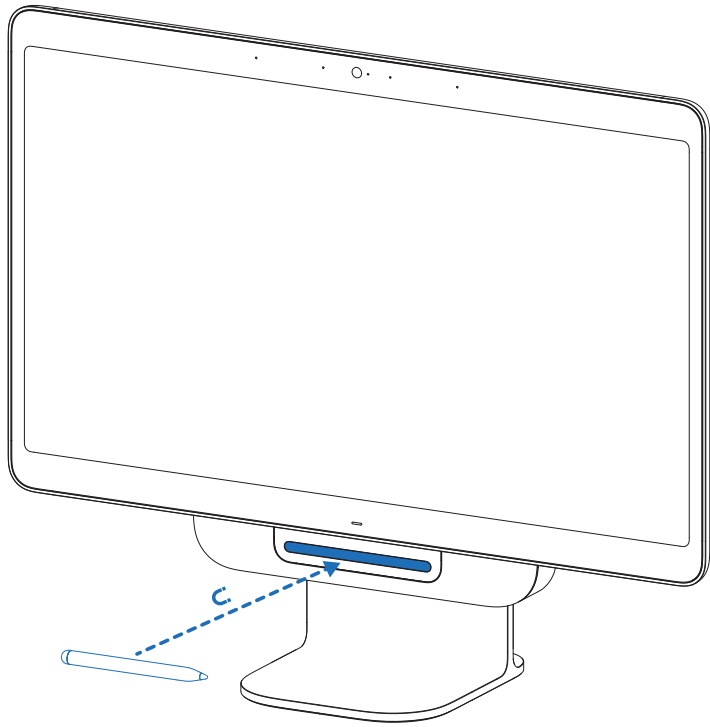

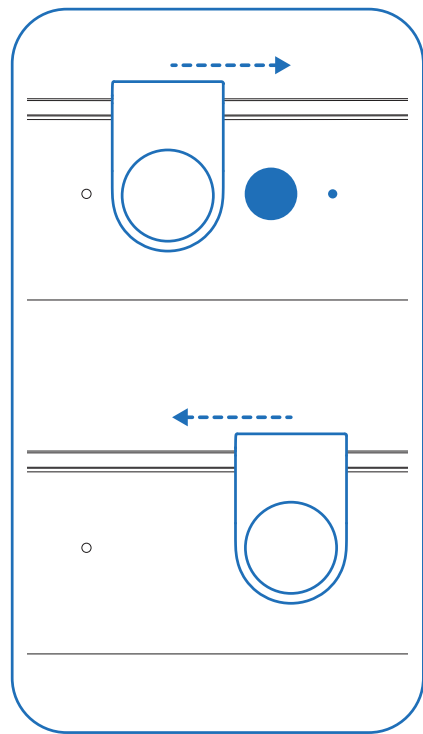
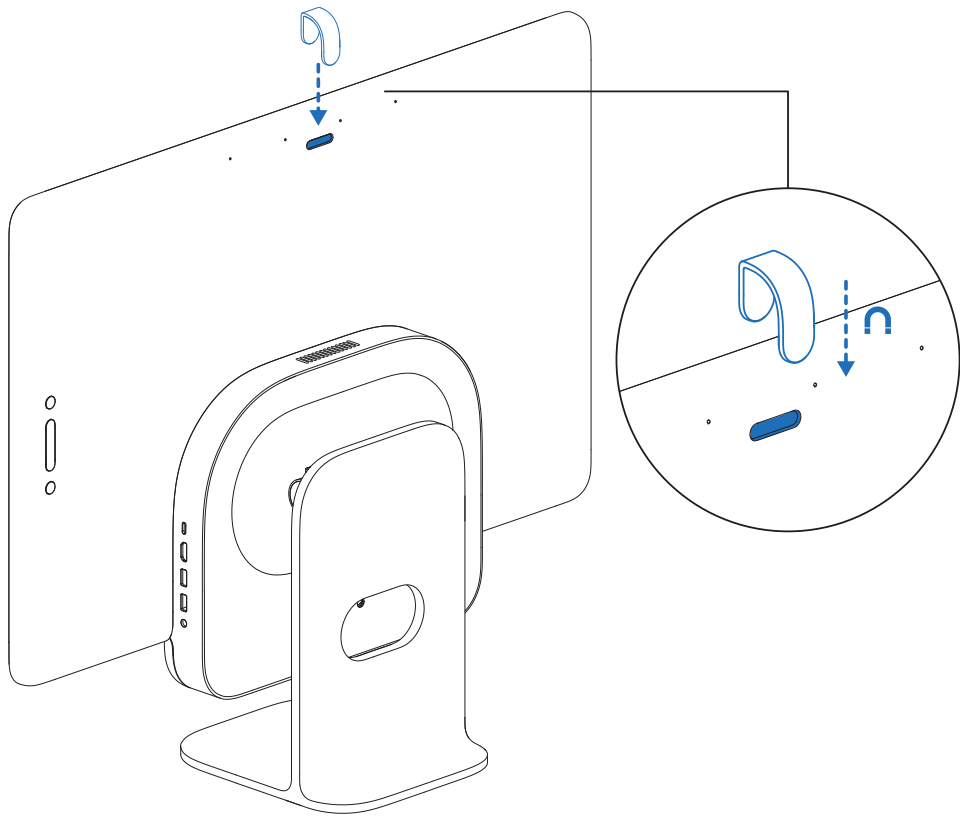

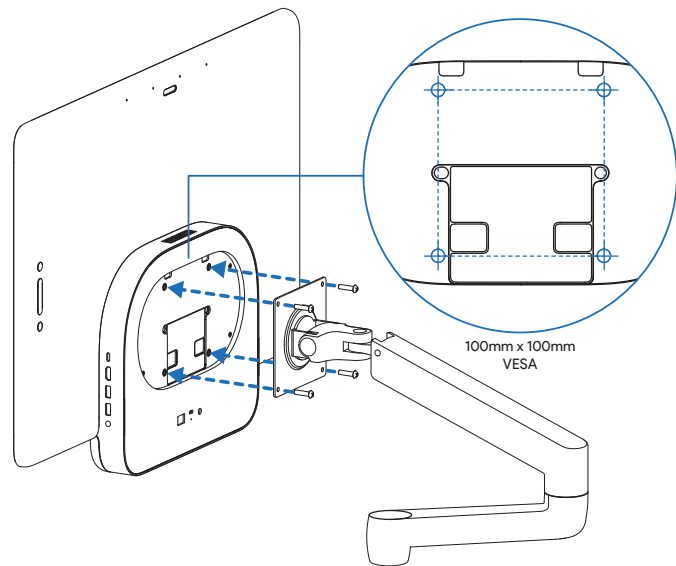
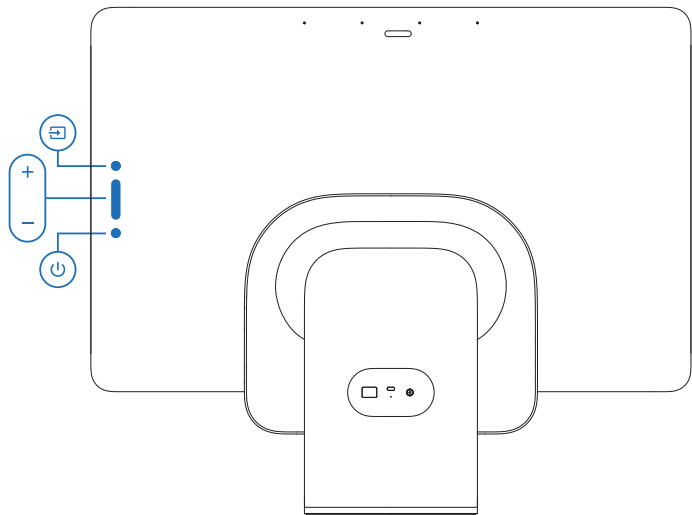



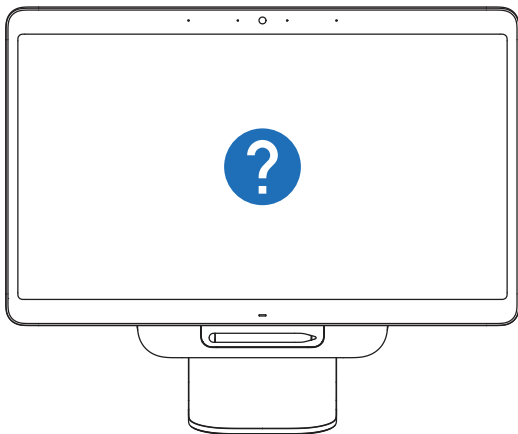

[hardware.meet/start](https://hardware.meet/start)

