

# C455HD IP Phone

Microsoft Teams Application

Version 1.17



## Notice

Information contained in this document is believed to be accurate and reliable at the time of printing. However, due to ongoing product improvements and revisions, AudioCodes cannot guarantee accuracy of printed material after the Date Published nor can it accept responsibility for errors or omissions. Updates to this document can be downloaded from <https://www.audiocodes.com/library/technical-documents>.

This document is subject to change without notice.

Date Published: November-22-2022

## WEEE EU Directive

Pursuant to the WEEE EU Directive, electronic and electrical waste must not be disposed of with unsorted waste. Please contact your local recycling authority for disposal of this product.

## Customer Support

Customer technical support and services are provided by AudioCodes or by an authorized AudioCodes Service Partner. For more information on how to buy technical support for AudioCodes products and for contact information, please visit our website at <https://www.audiocodes.com/services-support/maintenance-and-support>.

## Documentation Feedback

AudioCodes continually strives to produce high quality documentation. If you have any comments (suggestions or errors) regarding this document, please fill out the Documentation Feedback form on our website at <https://online.audiocodes.com/documentation-feedback>.

## Stay in the Loop with AudioCodes



## Related Documentation

Document Name
C455HD IP Phone for Microsoft Teams Release Notes
C455HD IP Phone for Microsoft Teams Quick Guide
Device Manager Administrator's Manual

Document Name
Device Manager Deployment Guide
<a href="https://docs.microsoft.com/en-us/MicrosoftTeams/phones-for-teams">https://docs.microsoft.com/en-us/MicrosoftTeams/phones-for-teams</a>

---

## Table of Contents

---

<b>1</b>	<b>Overview</b>	<b>1</b>
	Specifications	1
	Allowing URLs, Ports (Security)	4
	Security Guidelines for Android-based Native Teams Devices	5
	Android-Level Security Hardening	5
	Google Play Services	6
	Running Android in Kiosk Mode	6
	Screen Lock	7
	AudioCodes Private Key	7
	Android Debug Bridge (ADB)	7
	App Signing	7
	Web Browser	7
	Remote Configuration Management	7
	AudioCodes Device Manager Validation	8
	Sandboxing	8
	Device File System	8
	Keystore	8
	Device Certificate	8
	Data Protection	9
	Debugging Interface	9
	SSH Access: Reduced File System Privileges	9
	Android Security Updates	9
	AudioCodes Root CA Certificate	9
<b>2</b>	<b>Setting up the Phone</b>	<b>12</b>
	Unpacking	12
	Device Description	13
	Front View	13
	Rear View	16
	Cabling	17
	Mounting the Phone	17
	Desktop Mounting	17
	Wall Mounting	17
	Installing the Expansion Module (Sidecar)	18
	Before Using AudioCodes Devices	19
<b>3</b>	<b>Starting up</b>	<b>20</b>
	Configuring Device Settings	20
	Configuring Wi-Fi	34
	Restoring the Phone to Default Settings	36
	Performing a Hard Restore	36
	Performing a Soft Restore	36
	Recovery Mode	37

Locking and Unlocking the Phone .....	37
Automatic Lock .....	37
Unlock .....	37
<b>4 Teams Application .....</b>	<b>39</b>
Signing In .....	39
Multi-Cloud Sign-in .....	43
Remote Provisioning and Sign-in from Teams Admin Center .....	43
Getting Acquainted with the Phone Screen .....	48
Enabling Google Talkback .....	50
Opting in or out of Call Queues .....	51
Setting Status .....	51
Hot Desking .....	52
Changing Presence Status .....	53
Enabling Voicemail Support on CAP Users .....	54
Configuring Teams Application Settings .....	55
Setting up a Meeting .....	58
Using the People Screen .....	59
Accessing Voicemail .....	59
Using Audio Devices .....	60
Transferring Calls and Meetings across Devices .....	60
Signing Out .....	60
<b>5 Performing Teams Call Operations .....</b>	<b>63</b>
Making a Call .....	63
Redialing .....	64
Dialing a Missed Call .....	64
Select to Dial .....	64
Making an Emergency Call .....	64
Answering Calls .....	65
Ending an Established Call .....	66
Managing Calls .....	66
Parking a Call .....	66
Managing Teams Meetings .....	67
Using Live Captions .....	69
Raising a Hand During a Meeting .....	70
Hiding Names and Meeting Titles for Individual Devices .....	70
Transferring a Call to Frequent Contacts .....	70
Transferring a Call to Work Voicemail .....	70
Viewing and Playing Voicemail Messages .....	71
Rejecting an Incoming Call, Sending it Directly to Voicemail .....	71
Adjusting Volume .....	71
Adjusting Ring Volume .....	72
Adjusting Tones Volume .....	72
Adjusting Handset Volume .....	72

Adjusting Speaker Volume .....	72
Adjusting Headset Volume .....	72
Playing Incoming Call Ringing through USB Headset .....	73
Using the Phone as a USB Speaker .....	73
Viewing and Joining Meetings .....	73
Better Together over Bluetooth .....	74
Adding a Speed Dial .....	77
<b>6 Performing Administrator-Related Operations .....</b>	<b>80</b>
Setting up an E911 Emergency Location using TAC .....	80
Updating Phone Firmware Manually .....	86
Downloading Certificates .....	88
AudioCodes Android Phone Utility .....	88
Manually Performing Recovery Operations .....	89
Removing Devices from Intune Management .....	90
Configuring Audio-Related Parameters for Noisy Environments .....	97
Updating Microsoft Teams Devices Remotely .....	98
Applying Firmware to a Phone from a USB Disk .....	98
Managing Phones with the Device Manager .....	98
Configuring a Periodic Provisioning Cycle .....	99
Configuring TimeZone and Daylight Savings .....	100
Managing Devices with HTTPS .....	101
Supported Parameters .....	101
<b>7 Troubleshooting .....</b>	<b>103</b>
DSCP .....	103
Users .....	104
Network Administrators .....	105
Android Phone Utility .....	105
Capturing the Phone Screen .....	107
Running Tcpdump .....	107
Getting Information about Phones .....	108
Remote Logging (Syslog) .....	110
Getting Diagnostics .....	111
Activating DSP Recording .....	113
Deactivating DSP Recording .....	114
SSH .....	114
Getting the Phone IP Address .....	115
Installing the APK using SSH .....	115
Updating Phones using SSH Commands .....	115
Microsoft Teams Admin Center .....	116
Collecting Logs .....	117
Getting Audio Debug Recording Logs .....	119
Collecting Media Logs (*.blog) from the Phone .....	120
Capturing Traffic Using 'rpcapd' .....	120

Port Mirroring Network Monitoring ..... 121

# 1 Overview

The AudioCodes C455HD IP phone is a high-end, native Microsoft Teams executive IP phone with a large, color 5" touch screen, integrated Bluetooth and Wi-Fi, and optional connectivity to a color touch screen Expansion Module.

Feature highlights:

- Full duplex speakerphone and headset connectivity
- Graphical 5" color capacitive touch screen (1280 X 720 resolution)
- Multi-lingual support
- Dual GbE support
- PoE or external power supply
- USB port for USB headset
- Applicable to part number **C455HD-DBW**:
  - Integrated Bluetooth and Wi-Fi (contact your local AudioCodes representative for more information about regional availability of Wi-Fi / Bluetooth)
  - Optional Expansion Module support with a graphical 5" color capacitive touch screen, 480 X 854 resolution (the Expansion Module is purchased separately)

See [here](#) for video blogs and blogs about AudioCodes' Teams phones.

See [here](#) for videos and webinars about AudioCodes' Teams phones.

See [here](#) marketing material related to all AudioCodes' Teams phones.

## Specifications

The following table summarizes the phone's software specifications.

**Table 1-1: Software Specifications**

Feature	Details
Media Processing	<ul style="list-style-type: none"> <li>■ Voice Coders: G.711, G.729, G.722, SILK, Opus</li> <li>■ Acoustic Echo Cancelation: G.168-2004 compliant, 64-msec tail length</li> <li>■ Ambient noise block</li> <li>■ Adaptive Jitter Buffer</li> <li>■ Voice Activity Detection</li> <li>■ Comfort Noise Generation</li> <li>■ Packet Lost Concealment</li> </ul>



Feature	Details
	<ul style="list-style-type: none"> <li>■ RTP/RTCP Packetization (RFC 3550, RFC 3551), SRTP (RFC 3711)</li> </ul>
Microsoft Teams phones feature set	<ul style="list-style-type: none"> <li>■ Authentication (Sign in with user credentials; Sign in using PC/Smartphone; Modern Authentication; Phone lock/unlock)</li> <li>■ Calling (Incoming/Outgoing P2P calls; In-call controls via UI (Mute, hold/resume, transfer, end call); PSTN calls; Visual Voicemail; 911 support)</li> <li>■ Calendar and Presence (roadmap feature) (Calendar Access and Meeting Details; Presence Integration; Exchange Calendar Integration; Contact Picture Integration; Corporate Directory Access)</li> <li>■ Meetings (roadmap feature) (One-click Join for Meetings; Join Skype for Business meetings; Meeting Call controls [Mute/unmute, hold/resume, hang up, add/remove participant]; Meeting Details. See also <a href="#">here</a> for related Microsoft documentation.</li> </ul>
Configuration and Management	<ul style="list-style-type: none"> <li>■ Teams admin center (TAC)</li> <li>■ OVOC / Device Manager</li> </ul>
Debugging Tools	<ul style="list-style-type: none"> <li>■ AudioCodes' Android Phone Utility (see <a href="#">Android Phone Utility</a> on page 105)</li> <li>■ Log upload to Microsoft server (certification for 3rd party Skype for Business clients)</li> <li>■ Remote logging via Syslog</li> <li>■ SSH Access</li> <li>■ Capturing the phone screen</li> <li>■ TCPdump</li> <li>■ Audio Debug recording logs</li> <li>■ Media logs (*.blog)</li> <li>■ Port mirroring network monitoring</li> <li>■ Remote Packet Capture network sniffer application</li> </ul>
Localization Support	<ul style="list-style-type: none"> <li>■ Multi-lingual support; the language pack list is not yet final and is subject to modification.</li> </ul>
Hardware	<ul style="list-style-type: none"> <li>■ Five-inch color capacitive touch screen, 1280 x 720 resolution, with an intuitive user interface.</li> </ul>

Feature	Details
	<ul style="list-style-type: none"> <li>■ Wired connectivity: <ul style="list-style-type: none"> <li>✓ Two RJ-45 [Gigabit Ethernet (GbE)] (10/100/1000BaseT Ethernet) ports: LAN and PC port</li> <li>✓ USB port for USB headset</li> </ul> </li> <li>C455HD with DBW suffix flavor: <ul style="list-style-type: none"> <li>● <b>White USB port</b> - host port for USB headset</li> <li>● <b>Black USB port</b> - default port but can be configured to host port. To configure device / host port: <ul style="list-style-type: none"> <li><b>setup_usbport2_mode.sh host</b> (from device to host)</li> <li><b>setup_usbport2_mode.sh device</b> (from host to device)</li> </ul> </li> </ul> </li> <li>It can alternatively be configured by setting the configuration file parameter 'management/usbport2/mode' to the value of <b>USB_HOST_MODE/USB_DEVICE_MODE</b></li> <li>✓ RJ-11 interface</li> <li>✓ Survivable Branch Appliance (SBA)</li> <li>■ Wireless connectivity (applies to PNs <b>TEAMS-C455HD-DBW</b> and <b>TEAMS-C455HDPS-DBW</b>): <ul style="list-style-type: none"> <li>✓ Dual band 2.4GHz/5GHz, 802.11b/g/n Wi-Fi support</li> <li>✓ Wi-Fi supported protocols: WEP, WPA-PSK/WPA2-PSK and WPA/WPA2 Enterprise (802.1X) PEAP only</li> </ul> </li> <li>■ Integrated optional Bluetooth support for (applies to PNs <b>TEAMS-C455HD-DBW</b> and <b>TEAMS-C455HDPS-DBW</b>): <ul style="list-style-type: none"> <li>✓ Bluetooth headsets</li> <li>✓ Microsoft Better Together for device pairing</li> </ul> </li> <li>■ Bluetooth Wideband Speech (WBS) supported for headsets</li> <li>■ Expansion Module (optional)</li> <li>■ Mounting: <ul style="list-style-type: none"> <li>✓ Wall and desktop mounting options</li> <li>✓ One angle for desktop mount, another angle for wall mount</li> </ul> </li> <li>■ Power: <ul style="list-style-type: none"> <li>✓ DC jack adapter 12V</li> <li>✓ Power supply AC 100 ~ 240V</li> </ul> </li> </ul>

Feature	Details
	<ul style="list-style-type: none"> <li>✓ PoE Class 3: IEEE802.3af (optional)</li> <li>■ Keys: <ul style="list-style-type: none"> <li>✓ VOICE MAIL message hotkey (including LED)</li> <li>✓ 4-way navigation button with OK key</li> <li>✓ MENU</li> <li>✓ HOLD</li> <li>✓ MUTE (including LED)</li> <li>✓ TRANSFER</li> <li>✓ VOLUME control key</li> <li>✓ HEADSET (including LED)</li> <li>✓ SPEAKER (including LED)</li> <li>✓ BACK</li> <li>✓ CONTACTS</li> <li>✓ AC key – for future use – currently used as home key</li> </ul> </li> </ul>

## Allowing URLs, Ports (Security)

This section shows network administrators which URLs/Ports to allow when deploying Teams phones (security).

From the device point of view, the following table summarizes the ports the phone uses. See also [Microsoft's guide to the ports the phone uses](#).

**Table 1-2: URLs / Ports to Allow when Deploying Teams Phones (Security)**

Server Role	Service Name	Port	Protocol	Notes
DNS Server	All	53	DNS	-
AudioCodes Device Manager	AudioCodes DM	443	HTTPS	AudioCodes device management server
AudioCodes Redirect service	AudioCodes DM	443	HTTPS	AudioCodes redirect service <a href="https://redirect.audiocodes.com">redirect.audiocodes.com</a>
NTP timeserver	Android NTP	123	UDP	-

Server Role	Service Name	Port	Protocol	Notes
Time Zone Database	Time Zones	443	HTTPS	Time Zone Database (often called tz or zoneinfo)
Microsoft Apps Artifacts server	Package manager	-	-	Microsoft will be requested for the protocol and port and FQDN. These URLs are provided by the Admin agent.

## Security Guidelines for Android-based Native Teams Devices

AudioCodes' Android-based Native Teams devices are purpose-built and customized for Microsoft Teams calling and meeting. Customers might perceive Android-based products as vulnerable to security issues but security is *less* of an issue on devices purpose-built and customized for Microsoft Teams calling and meeting. Security is in fact *enhanced* on these devices *as part of their default use*.

When analyzing device security, two levels must be addressed:

- Authentication and security with respect to Teams connectivity and use
- Android level / system of the device

AudioCodes recommends the following:

- Use the sign-in mode **Sign-in with other device option**. In this mode, users do not type the password on the device but instead obtain a code on their PC / laptop to be used to sign-in; the phone obtains a private token that enables it to access Teams cloud; this token, unlike a password, allows only that device which obtained it to reuse it. The token is stored on the secured file system.
- Leverage Multi-Factor-authentication (MFA) to improve sign-in security.
- Reduce the expiration time of the sign-in for devices which are connected remotely (outside the organization's network) versus devices inside the organization's premises.

AudioCodes recommends visiting Microsoft's technical pages for more security guidelines and policies for Microsoft Teams adoption:

- [Overview of security and compliance - Microsoft Teams | Microsoft Docs](#)
- [Identity models and authentication for Microsoft Teams - Microsoft Teams | Microsoft Docs](#)
- [Sign in to Microsoft Teams - Microsoft Teams | Microsoft Docs](#)

## Android-Level Security Hardening

Major Android-level system-level developments have been incorporated into AudioCodes' devices to improve security:

- See [Google Play Services](#) on the next page

- See [Running Android in Kiosk Mode](#) below
- See [Screen Lock](#) on the next page
- See [AudioCodes Private Key](#) on the next page
- See [Android Debug Bridge \(ADB\)](#) on the next page
- See [App Signing](#) on the next page
- See [Web Browser](#) on the next page
- See [Remote Configuration Management](#) on the next page
- See [AudioCodes Device Manager Validation](#) on page 8
- See [Sandboxing](#) on page 8
- See [Device File System](#) on page 8
- See [Keystore](#) on page 8
- See [Device Certificate](#) on page 8
- See [Data Protection](#) on page 9
- See [Debugging Interface](#) on page 9
- See [SSH Access: Reduced File System](#)
- See [Android Security Updates](#) on page 9

### Google Play Services

Google Play services were removed from AudioCodes devices software. Access to any Google store or Play service is not allowed.

- Updating the AudioCodes device's Android software and application is performed via special software components that either connect to the Teams Admin Center or to AudioCodes' Device Manager over a secured channel.

### Running Android in Kiosk Mode

Android Kiosk Lockdown software 'locks down' Android devices to only allow essential apps by disabling access to the Home / Launcher. Using Android Kiosk Lockdown software, Android devices can be converted into public kiosk terminals or secured work devices.

- Only specific Microsoft apps and AudioCodes-signed apps that were certified and approved in the certification process can run in Kiosk mode; even if a malicious user manages to install a new unauthorized app on the file system, the launcher on the device will only run those specific approved apps and this cannot be changed in run time (only with a new software code provided by AudioCodes).

## Screen Lock

AudioCodes devices use a screen lock mechanism to prevent any malicious user/users from gaining access to Calendar information and / or Active Directory list of employees and / or triggering unauthorized calls from the device. After enabling screen lock, the device automatically locks after a preconfigured period; a code is required to unlock the device and resume full operation.

## AudioCodes Private Key

The system software on AudioCodes devices is signed with AudioCodes' private key. Users can replace the complete software only with new software that is also signed by AudioCodes' private key.

This prevents users from replacing the complete over-the-air (OTA) package of the device with any new system software, unless the software is fully signed by AudioCodes.

## Android Debug Bridge (ADB)



The device does not allow access to ADB.

AudioCodes disabled the Android Debug Bridge (ADB) application and keeps the Teams app running in the front all the time. As a result, it's impossible to install other apps from unknown sources, and to sideload apps.

## App Signing

Android requires all apps to be digitally-signed with a developer key before installation; currently, the AudioCodes devices verify that apps are signed by Microsoft.

App signing prevents malicious user/users from replacing a Microsoft-signed app with an app that "pretends" to be Microsoft but which lacks the private key that is known only to Microsoft.

## Web Browser

The AudioCodes device does not include a Web browser. Users cannot browse to the public internet or internal intranet. All Web services are customized to connect to Office 365 services and AudioCodes' managed services such as the One Voice Operations Center (OVOC).

Without a Web browser, malicious user/users will not be able to access the device and browse from it as a trusted device into the customer network.

## Remote Configuration Management

AudioCodes devices do not have an embedded Web server. Configuration and management are performed using one of the following remote interfaces:

- Microsoft Teams Admin Center (for Native Teams devices) over HTTPS protocols, enabled after a successful sign-in authentication process.

- AudioCodes Device Manager (part of AudioCodes' OVOC suite) over HTTPS.
- Debugging interface over SSH. Note that SSH must be disabled by default and enabled only per specific case for debugging purposes only.

### AudioCodes Device Manager Validation

The AudioCodes Native Teams devices validate the AudioCodes Device Manager identity using a known Root CA:

- The device is shipped with known Root CAs installed. See [AudioCodes Root CA Certificate on the next page](#).
- For the initial connection, the AudioCodes Device Manager accesses devices using a known CA.
- Once a successful secured connection has been established between the device and the Device Manager, the user can replace the Root CA on the Device Manager and on the phone, and re-establish the connection leveraging any Private Root CA.

### Sandboxing

AudioCodes devices use Android Application Sandbox so that each application can access its own data and is isolated from other applications. This prevents a malicious app from accessing the code or the data of other applications in the system.

### Device File System

The AudioCodes device's file system is encrypted on 455HD devices. Customers may enforce a policy of device encryption via Microsoft's cloud-based Intune service.

### Keystore

With AudioCodes devices, the certificate keys are encrypted on the device file system.

### Device Certificate

AudioCodes devices are shipped with a unique certificate which is signed by AudioCodes Root CA. Network administrators can install a third-party certificate on the phone in the customer's trusted environment. Network administrators should follow the following guidelines when replacing the existing trusted CAs:

- The device certificate URL will only be valid if no SCEP server URL is present
- Use the following two parameters to set the device certificate in the phone's configuration file:
  - security/device\_certificate\_url=http://<server-ip>/device.crt
  - security/device\_private\_key\_url=http://<server-ip>/device.key

## Data Protection

AudioCodes devices run Android which has integral procedures for protecting and securing user data.

## Debugging Interface

- AudioCodes devices leverage SSH as a debugging interface.
- AudioCodes recommends that customers disable SSH on devices via AudioCodes' Device Manager (OVOC).
- AudioCodes recommends changing the Admin password from the default, via the Teams Admin Center or AudioCodes' Device Manager (OVOC).
- When a device - or multiple devices - needs to be debugged, users can enable SSH on it / them, access SSH with the new Admin password for the debugging phase, and disable SSH once debugging is finished.



SSH is by default disabled and can be enabled with Administrator permissions in the phone screen (Device Administration > Debugging > SSH).

## SSH Access: Reduced File System Privileges

Administrator users who access SSH have reduced file system privileges. For example, files cannot be deleted, and some parts of the file system cannot be reviewed. This prevents malicious actions or unintended errors that might cause damage to the device.

## Android Security Updates

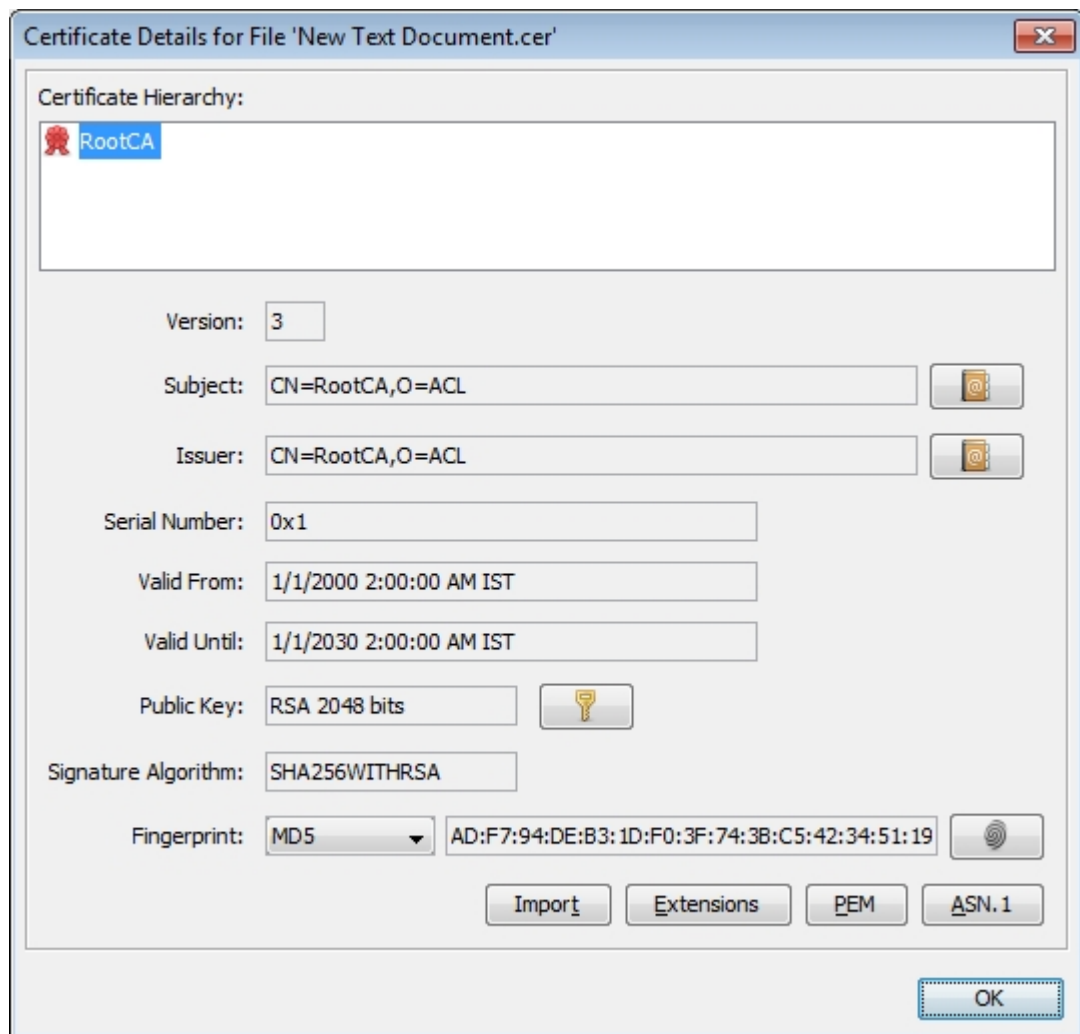
AudioCodes regularly adopts and integrates Android security updates.

For reference, see [here](#).

## AudioCodes Root CA Certificate

The following figure shows the AudioCodes Root CA Certificate.





-----BEGIN CERTIFICATE-----

MIIDMTCCAhmGAWIBAgIBATANBgkqhkiG9w0BAQsFADAFMQwwCgYDVQQKEwNBQ0wx

DzANBgNVBAMTBiJvb3RDQTAeFw0wMDAxMDEwMDAwMDBaFw0zMDAxMDEwMDAwMDBa

MB8xDDAKBgNVBAoTA0FDTDEPMA0GA1UEAxMGUm9vdENBMIIBIjANBgkqhkiG9w0B

AQEFAAOCAQ8AMIIBCgKCAQEA6GK495KUCXAm/UE17G4/cjnZN4LNaxYEYzbfZL0a

EhgSKYt/LQ+iUcDhojsneusNgrcGkpwKkIKsGsvGWmSRNULV01CW+TX2VJN73+hh

V0uzhyOIYAUhbDaoqNM6Kp5b7sJ1ew4lg9kfd/ma9Czl5koESLlw/inLj/r+rD96

mUcPEIWkKspv7Qy4I14fsK/yMArixRopTL1munVVPpSFM9Jh8IY3JHyr5CQJXKK  
S

EhGAJsnHaRqsR2Su3X/WtslgEF+cvP34pxhIhFL29nMfnaFATSS3rgGaFISvl1ZS

esLMqkWjp9cqGYrvt7K61sYnvMMb+o/KbWqVokXb+Fr7bwIDAQABo3gwdjAMB  
gNV

HRMEBTADAQH/MB0GA1UdDgQWBBQDXySn9hz15IDraZ+iXddZGReB+zBHB  
gNVHSME

QDA+gBQDXySn9hz15IDraZ+iXddZGReB+6EjpCEwHzEMMAoGA1UEChMDQU  
NMMQ8w

DQYDVQQDEwZSb290Q0GCAQEwDQYJKoZIhvcNAQELBQADggEBAI0rUywo  
mmWWJnH3

JOfKiS3+VnX5hJITZymvWanMXUz/6FonHccPXEBYTrUYwhiWx3dwELAFXDFK  
kxMp

0KKWZ4F39cAOLRjqhzya+xUeeJ9HQZCXAJ6XgvTfN2BtyZk9Ma8WG+H1hNv  
vTZY

QLbWsjQdu4eFniEufeYDke1jQ6800LwMIFlc59hMQCeJTEnRx4HdJbJV86k1gBU  
E

A7fJT1ePrRnXNDRz6QtADWoX3OmN7Meqen/roTwwLpEP22nYwvB28dq3JetlQ  
Kwu

XC4gwl/o8K2wo3pySLU9Y/vanxXCr0/en5I3RDz1YpYWmQwHA8jJlu8rxdhr+VNQ  
Zv6R/Ys=

-----END CERTIFICATE-----

## 2 Setting up the Phone

The instructions following show how to set up the phone.

### Unpacking

When unpacking, make sure the items listed in the phone's *Quick Guide* are present and undamaged.

If anything appears to be missing or broken, contact the distributor from whom you purchased the phone for assistance.

For detailed information, see the phone's *Quick Guide* shipped with the device or available from AudioCodes.

## Device Description

Use the following graphics to identify and familiarize yourself with the device's hardware functions.

### Front View

The front view of the phone is shown in the figure and described in the table.

Figure 2-1: Front View

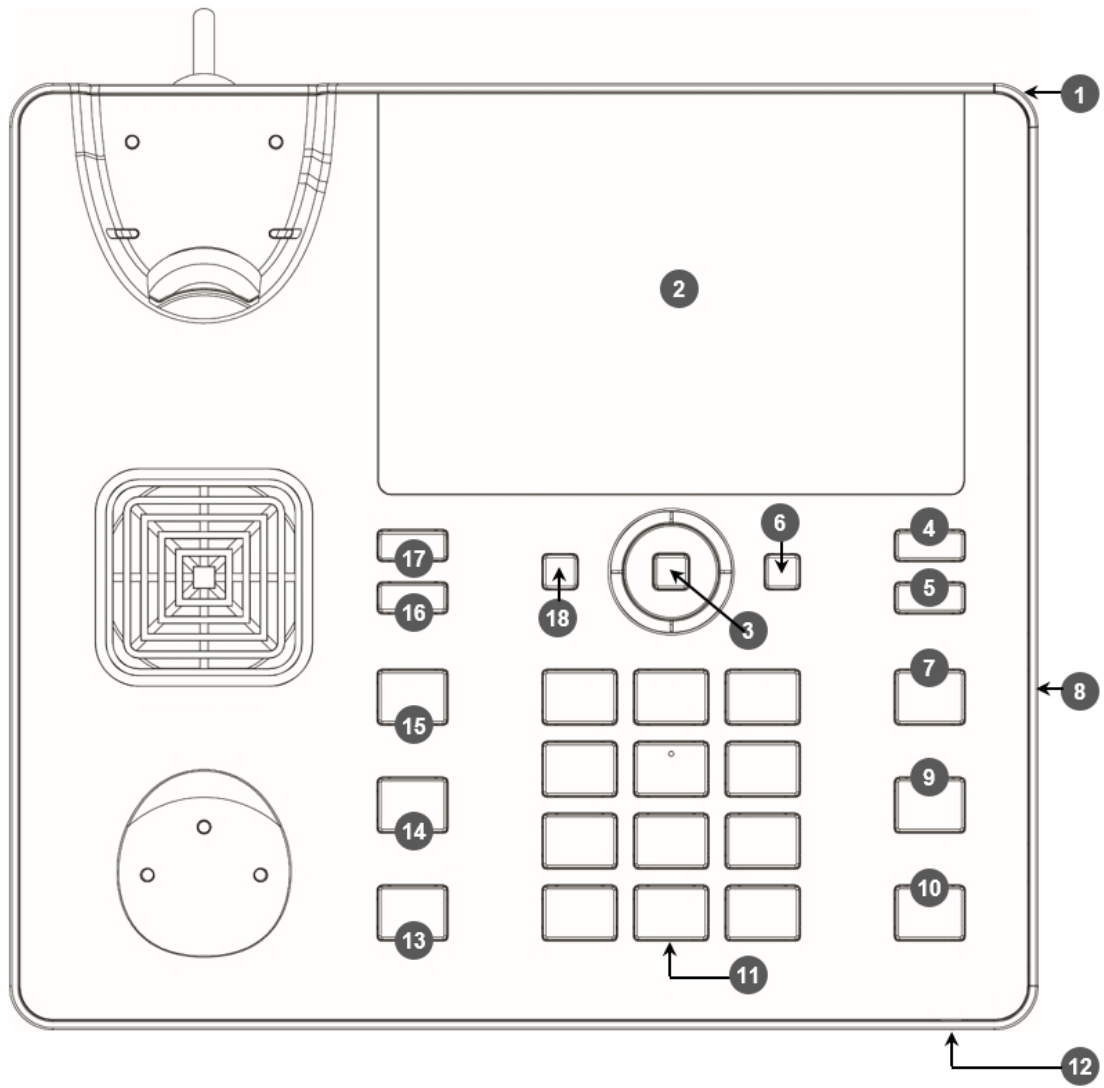


Table 2-1: Front View Description

Item #	Label/Name	Description
1	Ring LED	Indicates phone status: <ul style="list-style-type: none"> <li><span style="display: inline-block; width: 10px; height: 10px; background-color: green; margin-right: 5px;"></span> Green: Idle state</li> <li><span style="display: inline-block; width: 10px; height: 10px; background-color: red; margin-right: 5px;"></span> Flashing red: Incoming call (ringing)</li> </ul>

Item #	Label/Name	Description
		<ul style="list-style-type: none"> <li>■ Red: Answered call</li> </ul>
2	TFT touch screen	Thin Film Transistor touch screen, a type of LCD (Liquid Crystal Display) interactive screen which displays calling information and lets you configure phone features by touching the glass.
3	Navigation Control / OK	<ul style="list-style-type: none"> <li>■ Press the button's upper rim to scroll up menus/items.</li> <li>■ Press the button's lower rim to scroll down.</li> <li>■ Press the button's left or right rim to move the cursor left or right (when editing a contact number for example).</li> <li>■ Press <b>OK</b> to select a menu/item/option.</li> </ul>
4	Voicemail	Retrieves voicemail messages.
5	CONTACTS	Accesses the People screen.
6	MENU	Accesses the Settings screen.
7	AC	AC key – for future use – currently used as home key. Returns you to the home (idle) screen from any screen.
8	Kensington lock	Allows locking the device.
9	TRANSFER	Transfers a call.
10	HOLD	Places an active call on hold.
11	Alphanumerical Keypad	Keys for entering numbers, alphabetical letters and symbols (e.g., colons)
12	Microphone	Allows talking and listening. The network administrator can disable it if required.
13	Speaker	Activates the speaker, allowing a hands-free conversation.
14	Headset	Activates a call using an external headset.
15	Mute	Mutes a call.
16	▲ VOL	Increases or decreases the volume of the handset, headset, speaker, ring tone and call progress tones.
17	▼ VOL	

Item #	Label/Name	Description
18	'Back' key	Returns you to the previous screen.

## Rear View

The ports located on the rear of the phone are described in the table.

Figure 2-2: Rear View

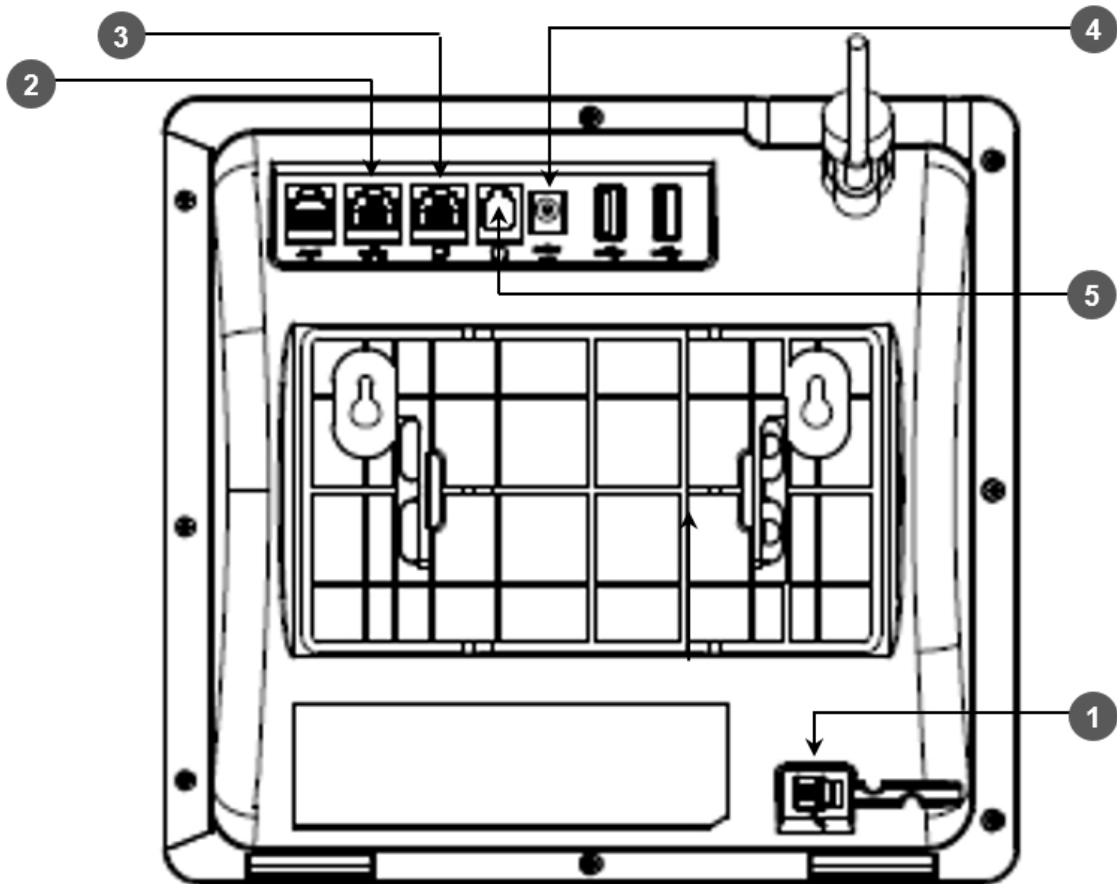







Table 2-2: Rear View Description

#	Label	Description
1		Handset jack, i.e., port RJ-9, to connect the handset.
2		RJ-45 port to connect to the Ethernet LAN cable for the LAN connection (uplink - 10/100/1000 Mbps). If you're using Power over Ethernet (PoE), power to the phone is supplied from the Ethernet cable (draws power from either a spare line or a signal line).
3		RJ-45 port to connect the phone to a PC (10/100/1000 Mbps downlink).
4		12V DC power jack that connects to the AC power adapter.
5		Headset jack, i.e., RJ-9 port that connects to an external headset.

## Cabling

See the phone's *Quick Guide* shipped with the device and also available from AudioCodes for detailed information on how to cable the phone.

## Mounting the Phone

The phone can be mounted on a:

- Desk (see [Desktop Mounting](#) below)
- Wall (see [Wall Mounting](#) below)

See the phone's *Quick Guide* shipped with the device and also available from AudioCodes for detailed information on how to mount the phone.

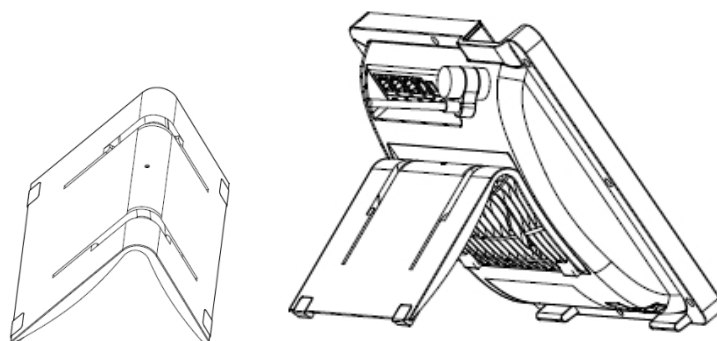
See also [here](#) for a clip showing *the principle* of how to mount an AudioCodes IP phone. The principle is the same across all AudioCodes IP phones.

### Desktop Mounting

The following instructions show how to mount the phone on a flat surface like a desk.

➤ **To mount the phone on a flat surface like a desk:**

1. Off-hook the handset (if on-hook) and place the phone upside down, i.e., base-up, on your desktop.
2. On the phone's stand, identify outer notches.
3. On the phone's base, identify outer rails.
4. Invert the stand and align its outer notches with the base's outer rails.
5. Insert the stand's outer notches into the base's outer rails and slide the notches along the rails until the stand click-locks into the base.
6. Revert the phone and stand it on the desktop.



### Wall Mounting

The following documentation shows how to mount the phone on a wall.

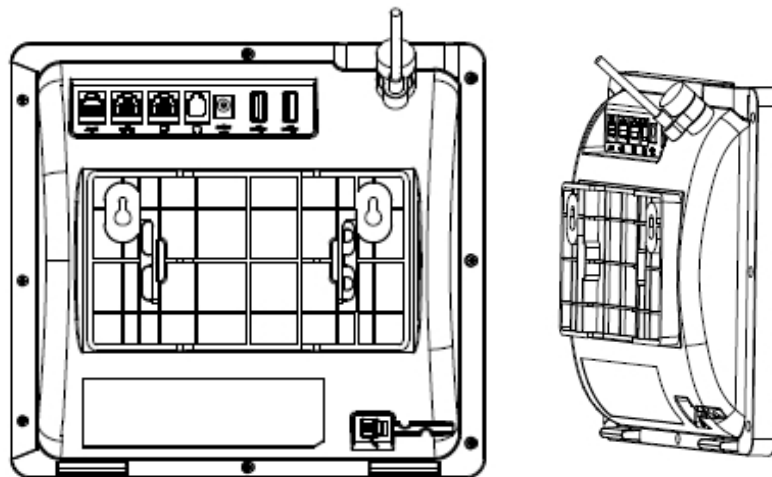




If the phone model you have has an Expansion Module attached, wall mounting isn't supported.

➤ **To mount the phone on a wall:**

1. Attach the stand of the phone for the purpose of a wall mounting:
  - a. Detach the base.



- b. Attach it again as you did for a desktop mounting (see [Desktop Mounting](#) on the previous page) only now make sure that it's flatly aligned to lie flush against the wall, i.e., slide the inner rails of the phone stand onto the phone base's inner notches.
2. Connect the AC power adapter, LAN and PC/laptop cords.
3. In the wall, drill two horizontal holes at a distance of 4 7/8 inches (123.8 mm) from one another, in line with the template.
4. Insert two masonry anchors into the holes if necessary.
5. Thread two screws (not supplied) into the two masonry anchors; ensure that the heads extend sufficiently (about 3/16 inch or 5 mm from the wall) for the phone stand's keyhole slots to hang on.
6. Hang the phone stand's keyhole slots on these screws.

## Installing the Expansion Module (Sidecar)

See [here](#) for a tutorial | demo on how to install the phone's Expansion Module (sidecar).

The video tutorial | demo relates to the C450HD phone but the C455HD phone installation is identical.

## Before Using AudioCodes Devices

AudioCodes recommends frequently cleaning devices' screens especially screens on devices in common use areas such as conference rooms and lobbies.

➤ **To clean a device's screen:**

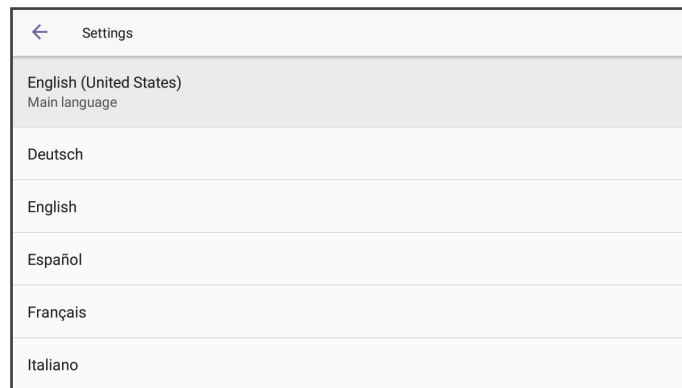
1. Disconnect all cables.
2. Spray onto a clean, dry, microfiber duster a medicinal isopropyl alcohol and water solution of 70:30. Don't oversaturate the duster. If it's wet, squeeze it out.
3. Lightly wipe the screen of the device.
4. Wait for the screen to dry before reconnecting cables.

## 3 Starting up

Here's how to start up the phone.

➤ **To start up:**

1. Connect the phone to the network (or reset it); the language selection screen is displayed by default.



2. Select the language of your choice and then configure device settings to suit specific requirements.



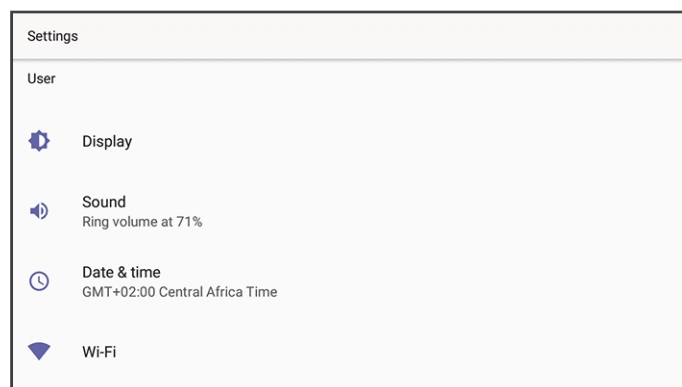
It will be necessary to repeat this only if the phone is restored to default settings.

## Configuring Device Settings

The section familiarizes you with the phone's settings. Phones are delivered to customers configured with their default settings. Customers can customize these settings to suit specific personal or enterprise requirements.


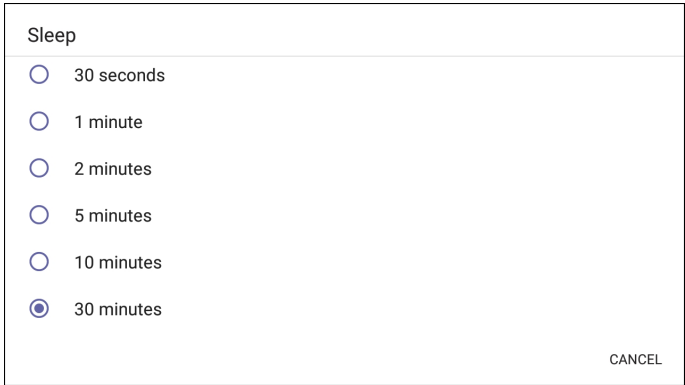
➤ **To access device settings:**

1. Press the MENU key on the phone.

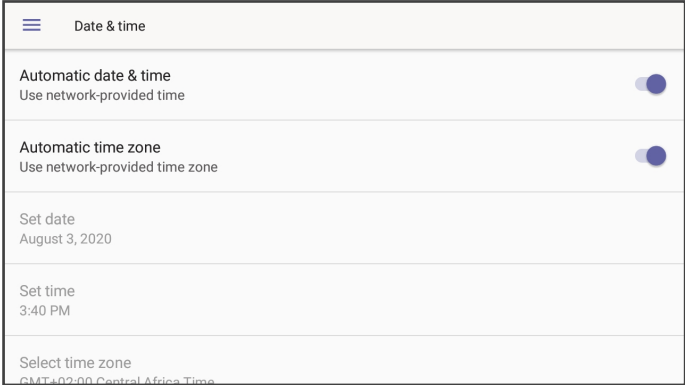



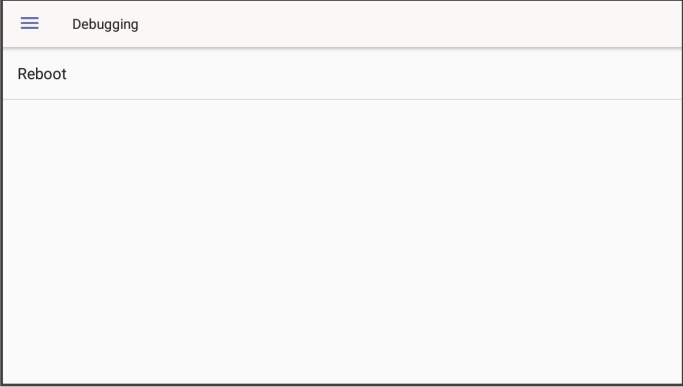
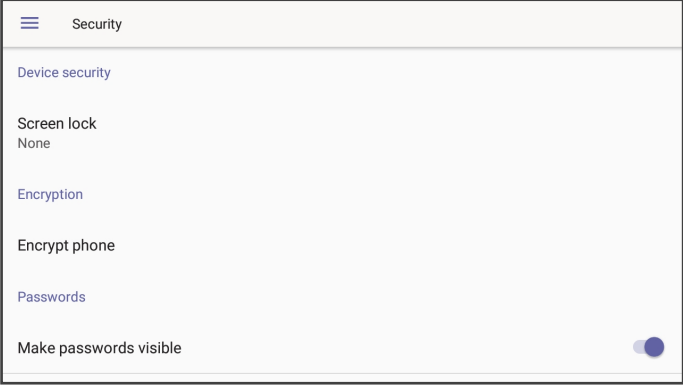
- View the settings under 'User'. Select a setting to open it. Use the table following as reference. [To view settings related to the network administrator, scroll down and open 'Device administration'].

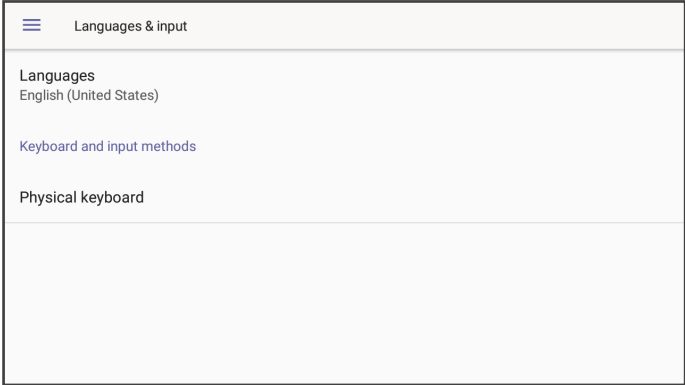


**Table 3-1: Device Settings**

Setting	Description
<b>User</b>	
Display	<p data-bbox="555 528 1086 562">Opens the 'Display' screen [Brightness level].</p> <div data-bbox="628 571 1315 954" style="border: 1px solid black; padding: 5px;">  </div> <p data-bbox="555 987 1358 1059">The phone's screen supports different brightness levels. Choose the level that suits your requirements.</p> <ul style="list-style-type: none"> <li data-bbox="555 1084 667 1117">■ Sleep</li> </ul> <div data-bbox="628 1135 1315 1518" style="border: 1px solid black; padding: 5px;">  </div> <ul style="list-style-type: none"> <li data-bbox="555 1559 751 1592">■ Screen saver</li> </ul>

Setting	Description
	<div data-bbox="628 264 1315 647"> </div> <p data-bbox="596 674 754 705">■ Font size</p> <div data-bbox="628 723 1315 1106"> </div>
<p data-bbox="312 1160 387 1191">Sound</p>	<p data-bbox="557 1160 1257 1229">Allows you to customize phone volume for a friendlier user experience.</p> <p data-bbox="557 1238 786 1270"><b>Ring volume at n%</b></p> <div data-bbox="628 1281 1315 1664"> </div>
<p data-bbox="312 1715 456 1747">Date &amp; time</p>	<p data-bbox="557 1715 1390 1785">Date and time are automatically retrieved from the deployed Network Time Protocol (NTP) server.</p>

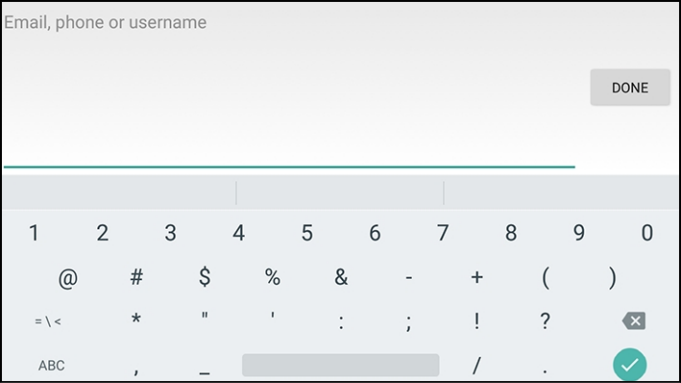
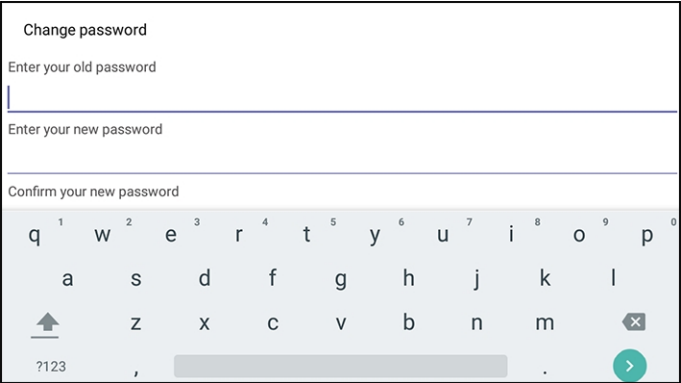
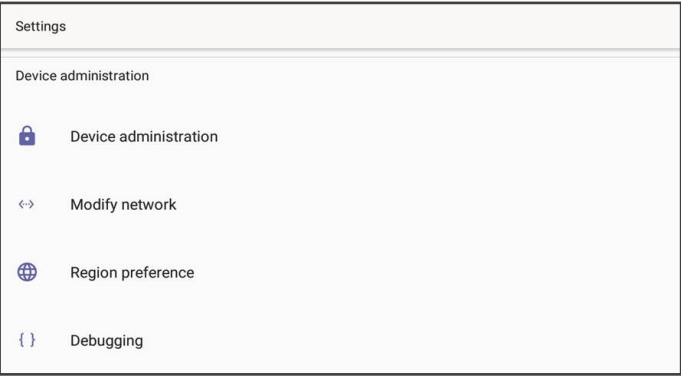
Setting	Description
	 <p>Use 24-hour format [Allows you to select the Time format]</p> <p>Also supported is a simplified version of NTP called Simple Network Time Protocol (SNTP). Both can be used to synchronize device clocks. SNTP is typically used if full implementation of NTP is not required.</p>
Wi-Fi	<p>The phone can connect to an Access Point via Wi-Fi. See the phone's <i>Quick Guide</i> for detailed information on setting up Wi-Fi. See also <a href="#">Configuring Wi-Fi</a> on page 34 in this document for information about configuring the feature.</p>
Accessibility	<p>Allows making the screen reader-friendlier. See also <a href="#">Enabling Google Talkback</a> on page 50.</p>
Bluetooth	<p>Hands free profile where the phone is able to connect to Bluetooth headset or speaker.</p> <p>See the phone's <i>Quick Guide</i> for detailed information on setting up Bluetooth.</p>
Power Saving	 <p>Enable power saving</p> <p>Start time [The device consumes minimal energy before the user arrives at the office]</p>

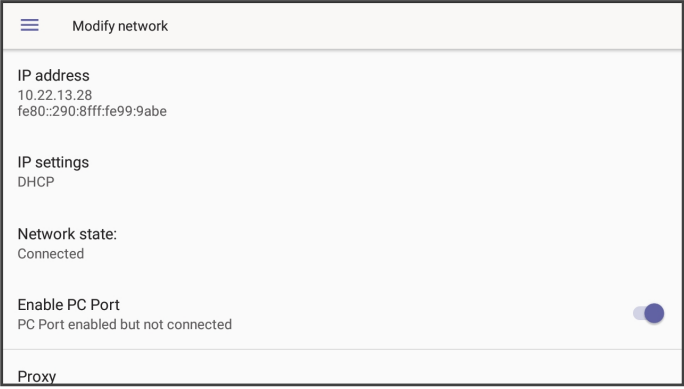
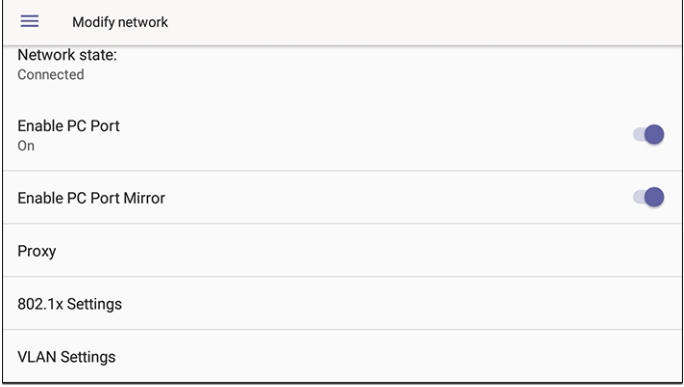
Setting	Description
	<p>End time [The device consumes minimal energy after the user leaves the office]</p>
<p>Debugging</p>	<p>Enables users to reboot the device.</p>  <p>Log in as Administrator for more debugging settings to be available.</p>
<p>Security</p>	<p>Helps secure the enterprise telephony network against breaches.</p>  <p>Screen lock [The phone automatically locks after a configured period to secure it against unwanted use. If left unattended for 10 minutes (default), it automatically locks and is inaccessible to anyone who doesn't know its lock code.] Make passwords available</p>
<p>Touch screen</p>	<p>Allows users to disable the phone's touch screen.</p>
<p>Languages &amp; input</p>	<p>Allows users to customize inputting to suit personal requirements.</p>

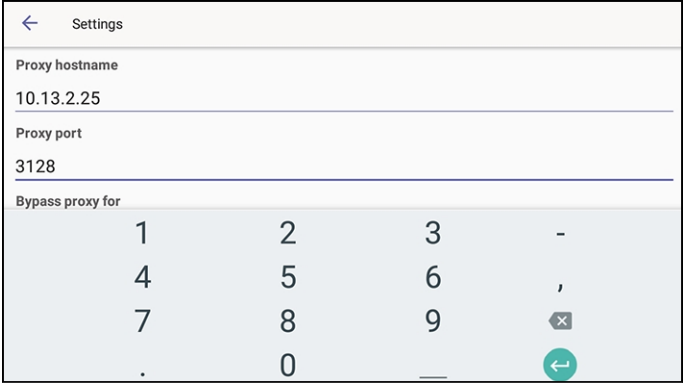
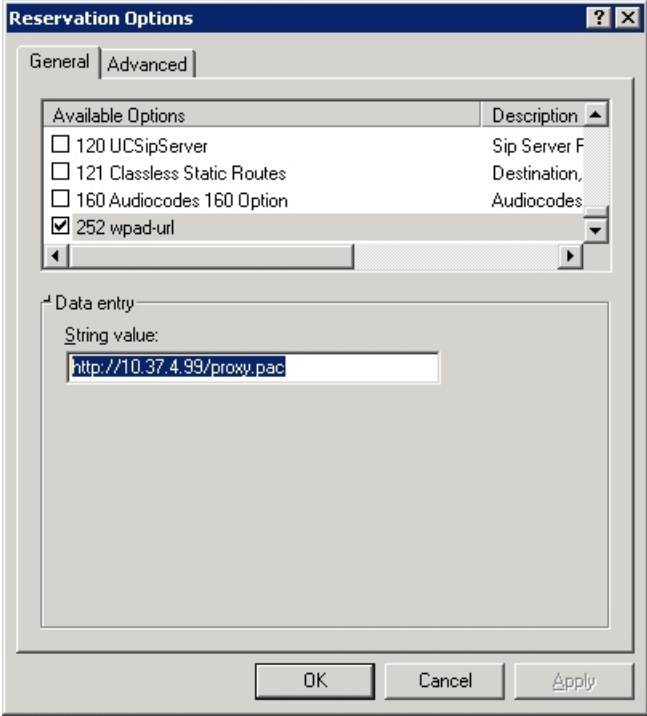
Setting	Description
	 <p>The screenshot shows the 'Languages &amp; input' settings menu. It includes sections for 'Languages' (with 'English (United States)' listed), 'Keyboard and input methods', and 'Physical keyboard'.</p>
<p>About [Android 7.1.2]</p>	<p>Enables users to determine device information.</p>  <p>The screenshot shows the 'Phone status' settings menu with the following items: Status, Model (C450HD), Android version (7.1.2), Android security patch level (July 1, 2017), and Version info.</p> <p>To determine the device's IP address, select the 'Status' option.</p>  <p>The screenshot shows the 'Settings' menu with the following items: IP address (10.22.13.28, fe80::290:8fff:fe99:9abe), Wi-Fi MAC address (80:5e:4f:7a:32:78), MAC address (00:90:8F:99:9A:BE), Bluetooth address (80:5e:4f:7a:59:88), and Serial number.</p> <p>To get information about the version, select 'Version info'.</p>




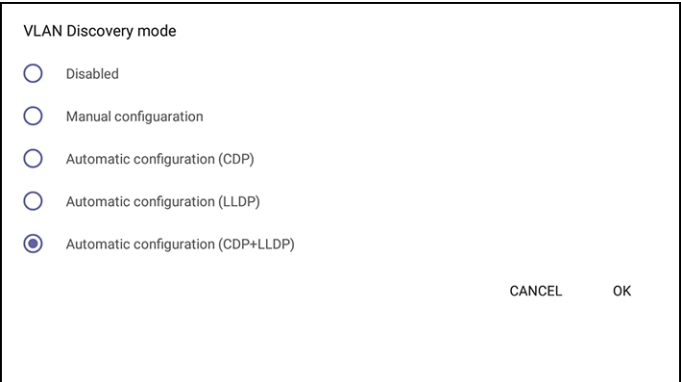
Setting	Description
	<div style="border: 1px solid black; padding: 5px; margin-bottom: 10px;"> <p>← Settings</p> <p><b>Firmware version</b> TEAMS_1.5.165</p> <p><b>Firmware code</b> 1005165</p> <p><b>DSP version</b> 720.67</p> <p><b>Bootloader</b> 1.1.18</p> <p><b>Microsoft Teams version</b> Version name: 1449/1.0.94.2020071702</p> </div> <div style="border: 1px solid black; padding: 5px; margin-bottom: 10px;"> <p>← Settings</p> <p><b>Microsoft Teams version</b> Version name: 1449/1.0.94.2020071702 Version code: 2020564020</p> <p><b>Company Portal version</b> Version name: 5.0.4867.0 Version code: 4265286</p> <p><b>Admin Agent version</b> Version name: 1.0.0.202006290446.product Version code: 216</p> <p><b>Partner Agent version</b> Version name: 1.0.48 Version code: 71</p> </div> <p>To get information about the Android version, select 'Android version'.</p>
<b>Device administration</b>	
<p>Device administration</p>	<p>Allows the user to log in as Administrator, necessary for some of the debugging options. It is password protected. Default password: 1234 (or 1111 in early versions). After logging in as an Administrator, the user can log out   change password.</p> <div style="border: 1px solid black; padding: 5px; margin-bottom: 10px;"> <p>☰ Device administration</p> <p>Login</p> </div> <p>Select <b>Login</b> and then in the Login screen that opens, select the 'Enter password' field and use the virtual keyboard to enter the password (<b>1234</b> or <b>1111</b>). Note that the virtual keyboard pops up for all 'Settings' fields to allow inputting characters and / or numbers. Two virtual keyboard types can be displayed: Numeric or QWERTY.</p>

Setting	Description
	  <p>The virtual keyboard is also displayed when the network administrator needs to enter an IP address to debug, or when they need to enter their PIN lock for the security tab.</p> <p>After logging in, scroll down in the Settings screen to the section 'Device administration'.</p> 
Modify network	Enables the Admin user to determine network information and to modify network settings.

Setting	Description
	<div style="border: 1px solid black; padding: 5px; margin-bottom: 10px;">  </div> <div style="border: 1px solid black; padding: 5px;">  </div> <p>IP Address [Read Only]                      IP Settings [DHCP or Static IP]                      Network state [Read Only]                      Enable PC port                      Enable PC port mirror                      Proxy                      802.1x Settings                      VLAN Settings. Allows you to configure the VLAN mode <b>Manual</b>, <b>CDP only</b> or <b>LLDP only</b>.</p>
Proxy	<p>The phone can be configured with an HTTP Proxy server by an Admin user in two ways:</p> <ul style="list-style-type: none"> <li>■ <b>Manually.</b> The Admin user can use this method to configure HTTP proxy server parameters through the Teams application:                             <ol style="list-style-type: none"> <li>a. Log in as Administrator and select <b>Modify network</b>.</li> <li>b. Select the <b>Proxy</b> option and then configure the proxy host name and port:</li> </ol> </li> </ul>

Setting	Description																
	 <p>← Settings</p> <p>Proxy hostname 10.13.2.25</p> <p>Proxy port 3128</p> <p>Bypass proxy for</p> <table border="1"> <tr> <td>1</td> <td>2</td> <td>3</td> <td>-</td> </tr> <tr> <td>4</td> <td>5</td> <td>6</td> <td>,</td> </tr> <tr> <td>7</td> <td>8</td> <td>9</td> <td>✕</td> </tr> <tr> <td>.</td> <td>0</td> <td>_</td> <td>←</td> </tr> </table>	1	2	3	-	4	5	6	,	7	8	9	✕	.	0	_	←
1	2	3	-														
4	5	6	,														
7	8	9	✕														
.	0	_	←														
	<p>■ <b>Over DHCP with Option 252.</b> It's recommended that the Admin user uses this method when provisioning multiple phones. Option 252 provides a DHCP client with a URL to use to configure its proxy settings:</p>  <p><b>Reservation Options</b> [?] [X]</p> <p>General   <b>Advanced</b></p> <table border="1"> <thead> <tr> <th>Available Options</th> <th>Description</th> </tr> </thead> <tbody> <tr> <td><input type="checkbox"/> 120 UCSipServer</td> <td>Sip Server F</td> </tr> <tr> <td><input type="checkbox"/> 121 Classless Static Routes</td> <td>Destination,</td> </tr> <tr> <td><input type="checkbox"/> 160 Audiocodes 160 Option</td> <td>Audiocodes</td> </tr> <tr> <td><input checked="" type="checkbox"/> 252 wpad-url</td> <td></td> </tr> </tbody> </table> <p>Data entry</p> <p>String value:  <input type="text" value="http://10.37.4.99/proxy.pac"/></p> <p>OK Cancel Apply</p>	Available Options	Description	<input type="checkbox"/> 120 UCSipServer	Sip Server F	<input type="checkbox"/> 121 Classless Static Routes	Destination,	<input type="checkbox"/> 160 Audiocodes 160 Option	Audiocodes	<input checked="" type="checkbox"/> 252 wpad-url							
Available Options	Description																
<input type="checkbox"/> 120 UCSipServer	Sip Server F																
<input type="checkbox"/> 121 Classless Static Routes	Destination,																
<input type="checkbox"/> 160 Audiocodes 160 Option	Audiocodes																
<input checked="" type="checkbox"/> 252 wpad-url																	
	<p>The proxy setting is provided in a Proxy Auto-Configuration (PAC) file that contains a set of rules coded in JavaScript which allows a web browser to determine whether to send web traffic directly to the Internet or to be sent via a proxy server. PAC files control how the phone handles HTTP, HTTPS and FTP traffic.</p> <p>Example of a basic PAC file:</p> <pre>function FindProxyForURL(url, host) { return "PROXY 10.13.2.40:3128";</pre>																

Setting	Description
	<pre> }  If the enterprise features a proxy server that requires user authentication, the network administrator can use the PAC file and DHCP Option 252 to configure it. Alternatively, the administrator can configure it using the following parameters: http_client/fwd_proxy/ip=0.0.0.0 http_client/fwd_proxy/password= http_client/fwd_proxy/port=8080 http_client/fwd_proxy/username= </pre>
802.1x Settings	<p>802.1X Authentication is the IEEE Standard for Port-based Network Access Control (PNAC). See <a href="https://1.ieee802.org/security/802-1x/">https://1.ieee802.org/security/802-1x/</a> for more information.</p> <p><b>To configure an 802.1X Authentication method:</b></p> <ol style="list-style-type: none"> <li>From the 'Modify Network' screen (as an Admin), access the 802.1x Settings screen.</li> </ol> <div data-bbox="632 976 1315 1361" data-label="Image"> </div> <ol style="list-style-type: none"> <li>From the 'EAP method' drop-down, select the method: MD5 or TLS (for example).</li> <li>Enter this information: <ul style="list-style-type: none"> <li>✓ Identity: User ID</li> <li>✓ Password</li> <li>✓ root certificate (not required for every method)</li> <li>✓ device certificate (not required for every method)</li> </ul> </li> <li>Select the <b>Save</b> softkey</li> </ol> <p>The 802.1x settings are not only available via the phone screen, they're also supported in the device Configuration File, enabling network administrator's to perform pre-staging configuration for</p>

Setting	Description
	<p>802.1x. The 802.1x settings available in the Configuration File are:</p> <ul style="list-style-type: none"> <li>■ Enable/Disable</li> <li>■ EAP method</li> <li>■ Identity</li> <li>■ Password</li> </ul>
<p>VLAN Settings</p>	<p>Select the menu option <b>VLAN Settings</b>.</p>  <p>Select <b>VLAN Discovery mode</b>.</p>  <ul style="list-style-type: none"> <li>■ Cisco Discovery Protocol (<b>CDP</b>) is a Cisco proprietary Data Link Layer protocol</li> <li>■ Link Layer Discovery Protocol (<b>LLDP</b>) is a standard, layer two discovery protocol</li> </ul> <p>Select the mode you require and then select <b>OK</b>. If you select <b>Manual configuration</b>, this screen opens:</p>

Setting	Description
	<div data-bbox="632 264 1315 645"> </div> <p data-bbox="552 685 799 712">Select <b>VLAN Interval</b>.</p> <div data-bbox="632 736 1315 1120"> </div> <p data-bbox="552 1160 1315 1305">The 'VLAN interval' refers to CDP/LLDP advertisements' periodic interval. Default: 30 seconds. You can increase or decrease the intervals between the CDP/LLDP packets that are sent, based on network traffic and topology.</p>
<p data-bbox="312 1350 443 1417">Region preference</p>	<p data-bbox="552 1350 1070 1377">Select the menu option <b>Region preference</b>.</p> <div data-bbox="632 1391 1315 1774"> </div> <p data-bbox="552 1805 1378 1951">This option allows you to define the country in which the phone is located. The setting determines which regional tone the phone will use. Call Progress Tones (CPTs) are country-specific; the behavior and parameters of analog telephones lines vary from country to country.</p>

Setting	Description
	<p>Select <b>Regional Tone Settings</b> and select the country in which the phone is located.</p> <div data-bbox="630 349 1315 732" style="border: 1px solid black; padding: 5px;"> <p>Regional Tones</p> <ul style="list-style-type: none"> <li><input checked="" type="radio"/> United States</li> <li><input type="radio"/> Canada</li> <li><input type="radio"/> Japan</li> <li><input type="radio"/> Great Britain</li> <li><input type="radio"/> Australia</li> <li><input type="radio"/> CEPT</li> </ul> <p style="text-align: right;">CANCEL</p> </div>
<p>Debugging</p>	<p>Allows the Admin user to perform debugging for troubleshooting purposes. Available after logging in as Admin.</p> <div data-bbox="630 864 1315 1505" style="border: 1px solid black; padding: 5px;"> <div style="border-bottom: 1px solid black; padding-bottom: 5px;"> <p>☰ Debugging</p> <ul style="list-style-type: none"> <li>Log settings</li> <li>Remote Logging</li> <li>Diagnostic Data</li> <li>Reset configuration</li> <li>Restart Teams app</li> <li>Company portal login</li> </ul> </div> <div style="border-bottom: 1px solid black; padding-bottom: 5px;"> <p>Debug Recording</p> <ul style="list-style-type: none"> <li>Switch to Teams Compatible</li> <li>Factory data reset</li> <li>ADB <span style="float: right;"><input checked="" type="checkbox"/></span></li> <li>Screen Capture <span style="float: right;"><input checked="" type="checkbox"/></span></li> </ul> </div> </div> <p>Log settings</p> <p>Remote Logging (see under <a href="#">Remote Logging (Syslog)</a> on page 110 for more information)</p> <p>Diagnostic Data (see under <a href="#">Getting Diagnostics</a> on page 111 for more information)</p> <p>Reset configuration</p> <p>Restart Teams app</p> <p>Company portal login</p> <p>Debug Recording (for Media/DSP debugging) (see under <a href="#">Remote Logging (Syslog)</a> on page 110 for more information)</p>



Setting	Description
	<p>Factory data reset (the equivalent of restore to defaults; including logout and device reboot)</p> <p>ADB (Android Debug Bridge command-line tool used to debug the Teamsapp); the setting is disabled by default. The device does not allow access to ADB.</p> <p>Screen Capture. By default, this setting is enabled. If it's disabled, the phone won't allow its screens to be captured.</p>

## Configuring Wi-Fi

[Applies to devices whose PN indicates **DBW**] Network administrators can configure Wi-Fi parameters for the phone. The parameters are concealed from the user's view.

Additionally, network administrators can configure Wi-Fi settings via the Configuration File. The Wi-Fi settings application on the device and the Configuration Database are synchronized.

Use the following table as reference.

**Table 3-2: Wi-Fi Parameters**

Parameter	Description	Values
network/wifi_enabled	Enables/disables the Wi-Fi feature.	0 (disable, default) 1 (enable)
network/wifi_pc_bridge	Enables network connectivity for the PC behind the phone; for debugging purposes.	0 (disable, default) 1 (enable)
network/wifi_ipv4_method	Defines the Dynamic or Static IP address for Wi-Fi.	DHCP (default) STATIC
network/wifi_channel_mode	Enables the Wi-Fi channel mode: <ul style="list-style-type: none"> <li>■ 2.4G only</li> <li>■ 5G only</li> <li>■ 2.4G+5G</li> </ul>	5G_2_4G (default) 2_4G_ONLY 5G_ONLY

The following table shows the parameters per index. The phone can currently store 16 connected SSIDs.

**Table 3-3: Wi-Fi Parameters per Index**

Parameter	Description	Values
network/wifi/[0-15]/ssid	Saves the Access Point's SSID.	-
network/wifi/[0-15]/password	Saves the password for some authentication methods which need it, e.g., WPAPERSONAL, WPA2PERSONAL	-
network/wifi/[0-15]/security	Saves the Access Point's authentication method: WPAPERSONAL, WPA2PERSONAL, WPAENTERPRISE, WPA2ENTERPRISE	-
network/wifi/[0-15]/auto_reconnect	Configure this parameter to reconnect this SSID automatically.	1 (default, enable) 0 (disable)
network/wifi/[0-15]/identity	Saves the identity for some authentication methods that need it, e.g., WPAPERSONAL, WPA2PERSONAL	-
network/wifi/[0-15]/anonymous_identity	Saves the anonymous identity for some authentication methods that need it, e.g., WPAENTERPRISE, WPA2ENTERPRISE, etc.	-
network/wifi/[0-15]/phase2_authentication	Phase 2 authentication for WPAENTERPRISE, WPA2ENTERPRISE. The phone supports PAP, MSCHAP, MSCHAPV2, CHAP, MD5, GTC	-
network/wifi/[0-15]/pin_code	Defines the PIN code for the WPS PIN code authentication method.	String of up to 64 characters
network/wifi/[0-15]/wps_method	Defines the WPS method. The phone supports PIN and push button.	None ALL (default) PIN AUTH PBC

## Restoring the Phone to Default Settings

Users can restore the device to factory default settings at any time. The feature can be used if a user forgets their Admin password, for example. Two kinds of restore are available:

- [Performing a Hard Restore](#) below
- [Performing a Soft Restore](#) below

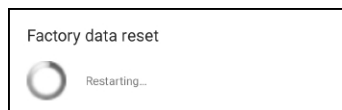
### Performing a Hard Restore

You can either:

- perform a hard restore while the phone is up and running (see below)
- restore the phone's settings to their defaults when the phone is not connected (see below)

#### ➤ To perform a hard restore while the phone is up and running:

1. Long-press the HOLD key on the phone (more than 15 seconds); the screen shown below is displayed and the device performs a restore to default factory settings.



After the restore, the phone automatically reboots and goes through the Wizard and sign-in process.

2. Select **OK**; the sign-in screen is displayed (see [Signing In](#) on page 39 for more information).

#### ➤ To restore the phone's settings to their defaults when the phone is not connected:

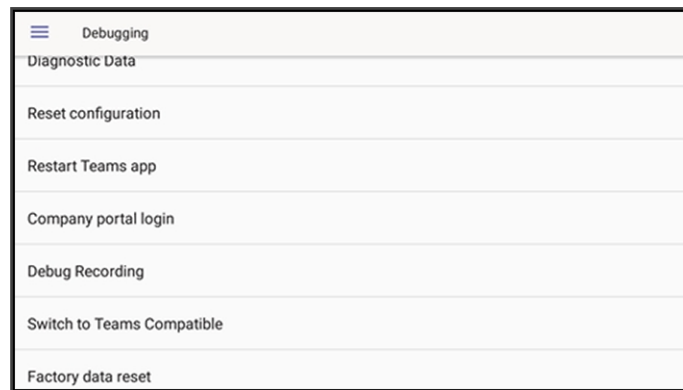
1. Press the OK + MENU keys simultaneously and keeping them pressed, unplug the power cable.
2. Plug the power cable back into the phone continuing to press the OK + MENU keys for +-5 seconds.
3. Release the OK + MENU keys; the phone's settings are restored to their defaults.

### Performing a Soft Restore

Users must log in as Administrator (**Settings > Device Administration > Login** and then use the virtual keyboard to enter the default password of **1234**) in order to perform a soft restore. The soft restore is then performed in the Debugging screen.

#### ➤ To perform a soft restore:

1. After logging in as Administrator, you'll have Admin privileges to configure settings. Under Device Admin Settings, select the **Debugging** option.



2. Select the **Factory data reset** option; the device performs a restore to default factory settings.

## Recovery Mode

If a phone goes into recovery mode, you can boot it using its hard keys as shown in [Performing a Hard Restore](#) on the previous page.

## Locking and Unlocking the Phone


As a security precaution, the phone can be locked and unlocked. The feature includes:

- Unlock (see [Unlock](#) below)
- Automatic lock ([Automatic Lock](#) below)

### Automatic Lock

Users can lock their phones as a security precaution. Configure the phone with any of the lock options before attempting to lock it. If an option isn't configured, the action won't function.

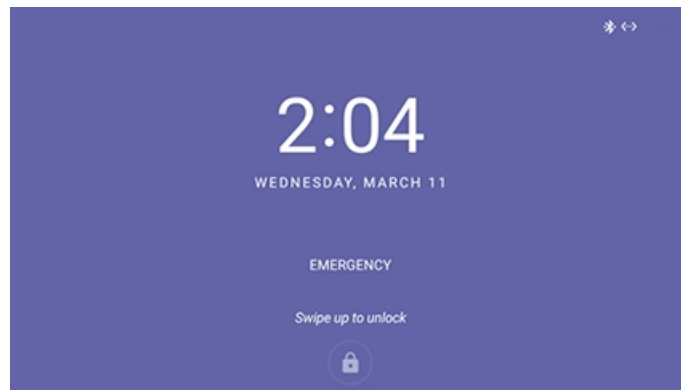
#### ➤ To lock the phone:

- Press the back key  on the phone for at least three seconds for the device to automatically lock.

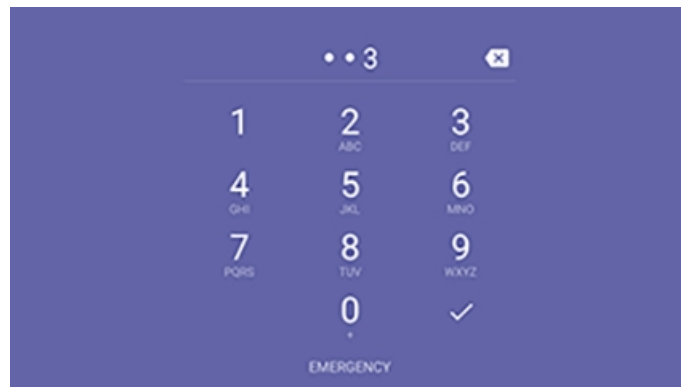
### Unlock

#### ➤ To unlock the phone:

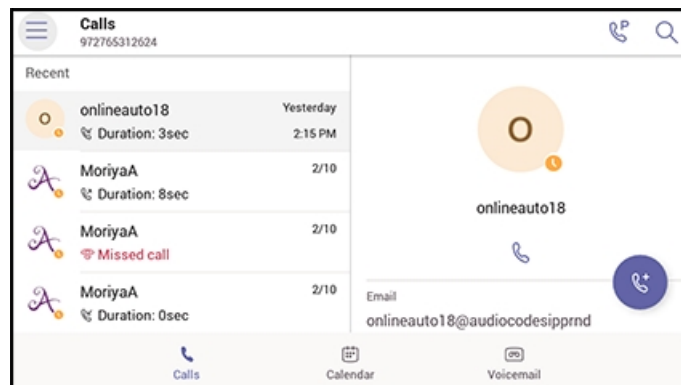
1. When the screen shown in the figure below is displayed, start typing your unlock PIN code.



2. View the digits displayed as you type:



3. When the phone detects the unlock code, it unlocks.



## 4 Teams Application

The following describes functions related to the phone's Microsoft Teams application.

### Signing In



Using TeamsIPPhonePolicy, network administrators can create the following users who can then sign in to the phone:

- UserSignIn: All features are available, i.e., calls, meetings and voicemail
- MeetingSignIn: Only meetings are available
- Common Area Phone (CAP) users who can sign in to the device with a CAP account (as a CAP user) using TeamsIPPhonePolicy as follows:
  - ✓ CAP SignIn (SearchOnCommonAreaPhoneMode=Enabled): The user has calling and searching capability
  - ✓ CAP SignIn (SearchOnCommonAreaPhoneMode=Disabled): The user has calling capability

Before using the phone (after setting it up), you need to sign in for security purposes. You can sign-in with user credentials locally on your IP phone, or remotely with your PC / smart phone.

'Modern Authentication' is also supported.

Before signing in, the network administrator must make sure the phone gets the local time, using either:

- **DHCP Option 42 (NTP)**. If DHCP Option 42 (NTP) is opted for, the network administrator must specify the server providing NTP for the network.
- **time.android.com**. NTP server option for Android phones.
- **time.windows.com**. The phones' default NTP server is sometimes not configured in DHCP Option 42. If not, the phones will attempt the Google NTP server. If DHCP Option 42 is not configured and the Google NTP server is blocked (for example), the phones will use this server and if it's unavailable, the server **time.nist.gov**, described next.
- **time.nist.gov**. The phones' default NTP server is sometimes not configured in DHCP Option 42. If not, the phones will attempt the Google NTP server. If DHCP Option 42 is not configured and the Google NTP server is blocked (for example), the phones will use this server (**time.nist.gov**) if the server **time.windows.com** described previously is unavailable.

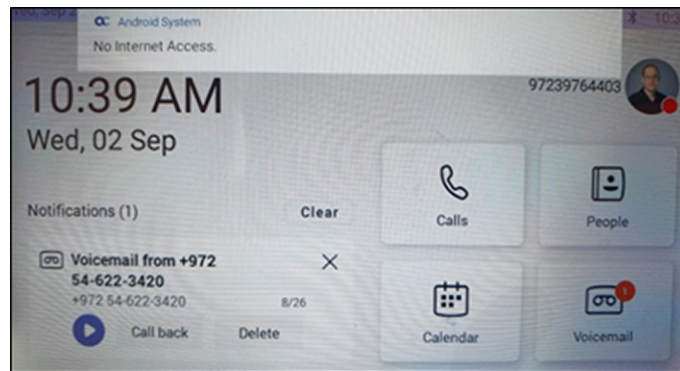
In most regions, Daylight Saving Time changes the regional time twice a year. DST Validation allows maintaining accurate time. Two options for phones to get the correct time are:

- [Recommended] If the DHCP server offers Timezone Options (100/101), the phone will set the obtained time zone and display the correct time on the screen; the time will be calculated based on an embedded Time Zone database, factoring in DST.
- If the DHCP server offers Time Offset Option only (2), the phone will assign the obtained time offset to the first matched region in the list but there is a good chance it won't reflect

the actual geographical location, therefore the displayed time might be incorrect in some cases. For example, if the given time offset is GMT-5 and the phone is located in Mexico, the phone will get the time (and the DST setting) from central time and not from Mexico because in GMT-5 there is also Central Daylight Time.

If the internet connectivity check fails, a 'No Internet Access' warning pops up on the phone screen.

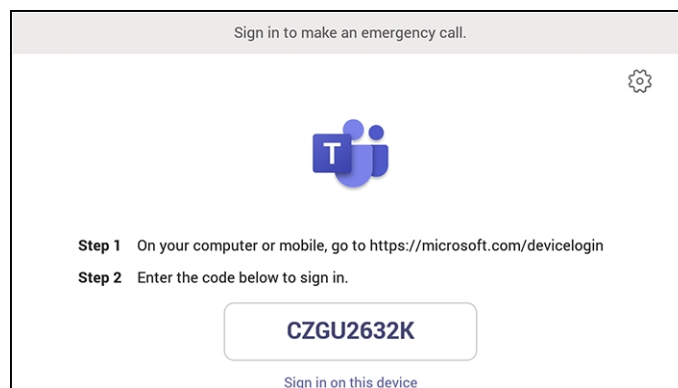
**Figure 4-1: Internet Connectivity Check - No Internet Access**



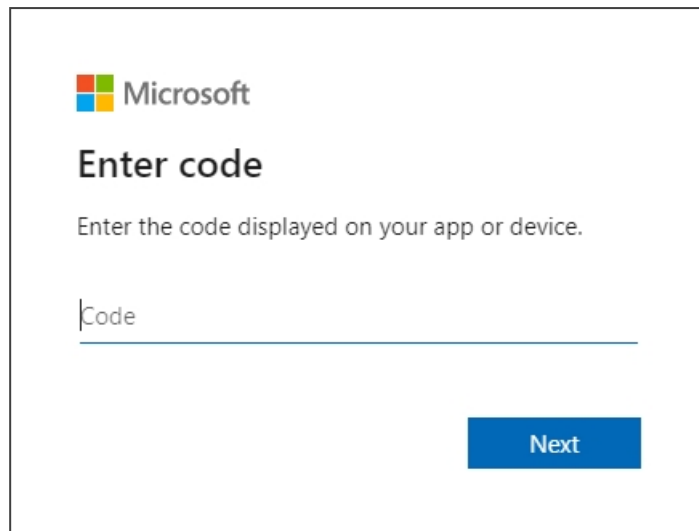
This can point to a problem that is preventing the phone from fully functioning in a Teams environment. The user can ignore the message if the Teams application is fully functioning, or can report a problem if the Teams application is not fully functioning.

➤ **To sign in:**

1. Connect the device to the network; this screen is then displayed:

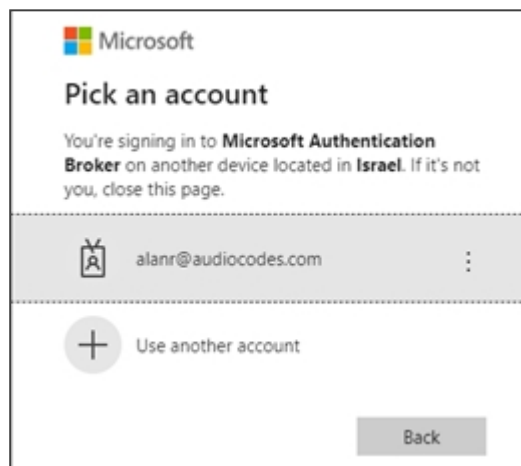


2. Open your browser and point it to **https://microsoft.com/devicelogin** as instructed in the preceding screen.



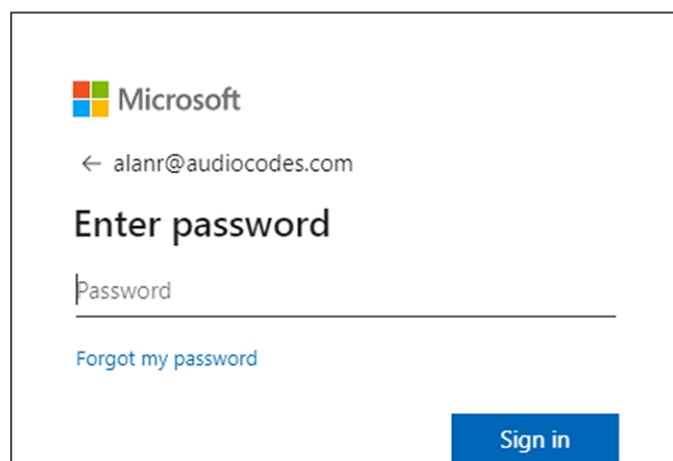
The screenshot shows the Microsoft 'Enter code' screen. At the top left is the Microsoft logo. Below it, the text 'Enter code' is displayed in a large, bold font. Underneath, a smaller line of text reads 'Enter the code displayed on your app or device.' Below this is a text input field with the placeholder text 'Code'. At the bottom right of the screen is a blue button labeled 'Next'.

3. Enter the code and then click **Next**.



The screenshot shows the Microsoft 'Pick an account' screen. At the top left is the Microsoft logo. Below it, the text 'Pick an account' is displayed in a large, bold font. Underneath, a smaller line of text reads 'You're signing in to Microsoft Authentication Broker on another device located in Israel. If it's not you, close this page.' Below this is a list of accounts. The first account is 'alanr@audiocodes.com' with a small icon to its left and a vertical ellipsis to its right. Below the list is a button with a plus sign and the text 'Use another account'. At the bottom right of the screen is a grey button labeled 'Back'.

4. Click the account.



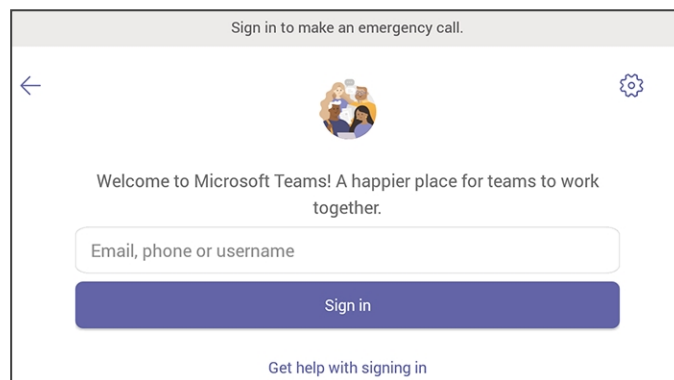
The screenshot shows the Microsoft 'Enter password' screen. At the top left is the Microsoft logo. Below it, the text 'alanr@audiocodes.com' is displayed with a back arrow to its left. Below this, the text 'Enter password' is displayed in a large, bold font. Underneath is a text input field with the placeholder text 'Password'. Below the input field is a link that reads 'Forgot my password'. At the bottom right of the screen is a blue button labeled 'Sign in'.

5. Enter your password (it's the same password as the Windows password on your PC) and then click **Sign in**.



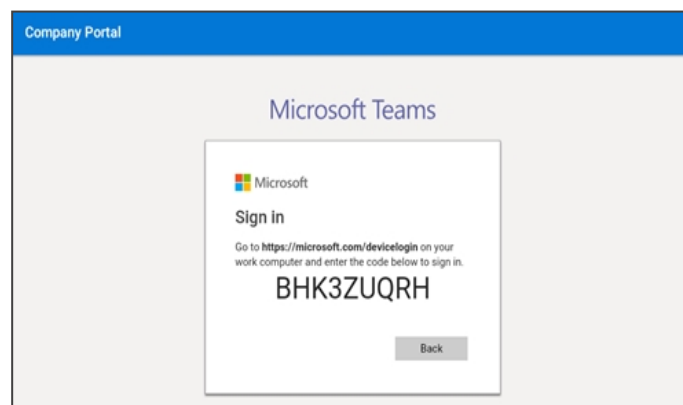


6. Close the window shown in the preceding figure.
7. Observe that the phone returns to the initial code screen. In that screen, select **Sign in on this device**.



8. Select the 'Email, phone or username' field; a virtual keyboard pops up. Enter one of them and then choose **Sign in**. The 'home' screen opens.
  - If you opt to **Sign in from another device**, complete authentication from your PC or smart phone. This is recommended if you're using Multi Factor Authentication (MFA).

**Figure 4-2: Sign-in from PC / Smart Phone**



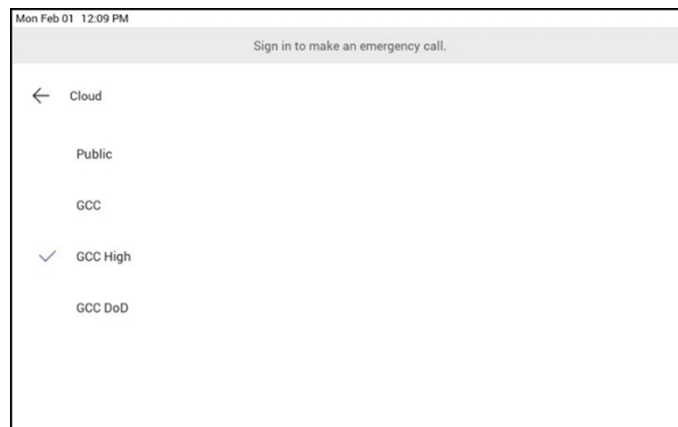
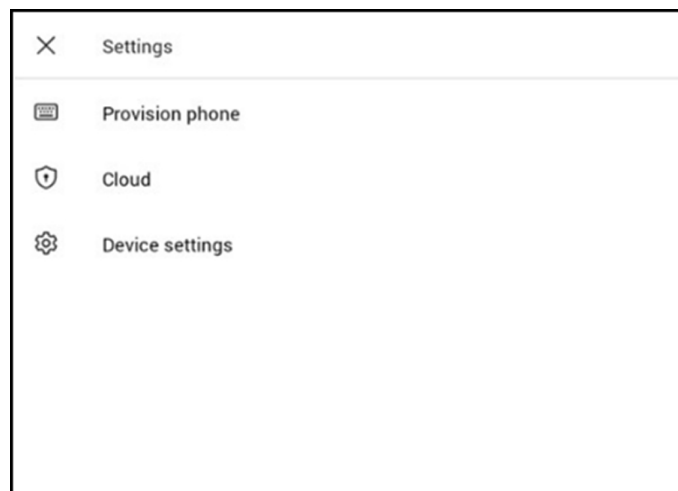
- ◆ In the browser on your PC or smart phone, enter the URL indicated in the preceding screen and then in the phone's Web interface that opens, perform sign-in (as noted previously, this option is recommended if using MFA).



LLDP-MED (Link Layer Discovery Protocol – Media Endpoint Discovery) is a standard link layer protocol used by network devices to advertise their identity, capabilities, and neighbors on a local area network based on IEEE802 technology, principally wired Ethernet. Teams devices connected to the network via Ethernet will dynamically update location information for emergency calling services based on changes to network attributes including chassis ID and port ID.

## Multi-Cloud Sign-in

For authentication into specialized clouds, users can choose the 'Settings' gear icon on the sign-in page to see the options that are applicable to their tenant.



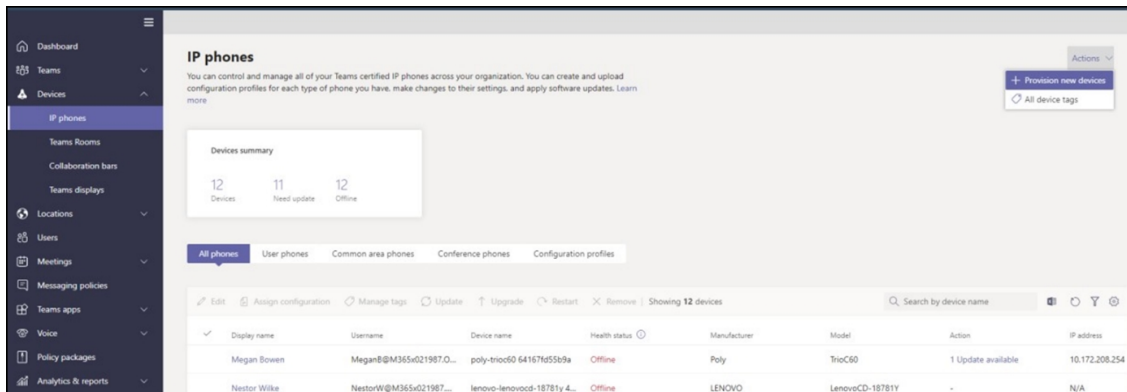
## Remote Provisioning and Sign-in from Teams Admin Center

Network administrators can remotely provision and sign in to a Teams device. To provision a device remotely, the admin needs to upload the MAC IDs of the devices being provisioned and create a verification code. The entire process can be completed remotely from the Teams admin center.

### ➤ Step 1: Add a device MAC address

**Provision the device by imprinting a MAC address on it.**

1. Sign in to the Teams admin center.
2. Expand **Devices**.
3. Select **Provision new device** from the **Actions** tab.



In the 'Provision new devices' window, you can either add the MAC address manually or upload a file.

#### Manually add a device MAC address

1. From the **Awaiting Activation** tab, select **Add MAC ID**.
2. Enter the MAC ID.
3. Enter a location, which helps technicians identify where to install the devices.
4. Select **Apply** when finished.

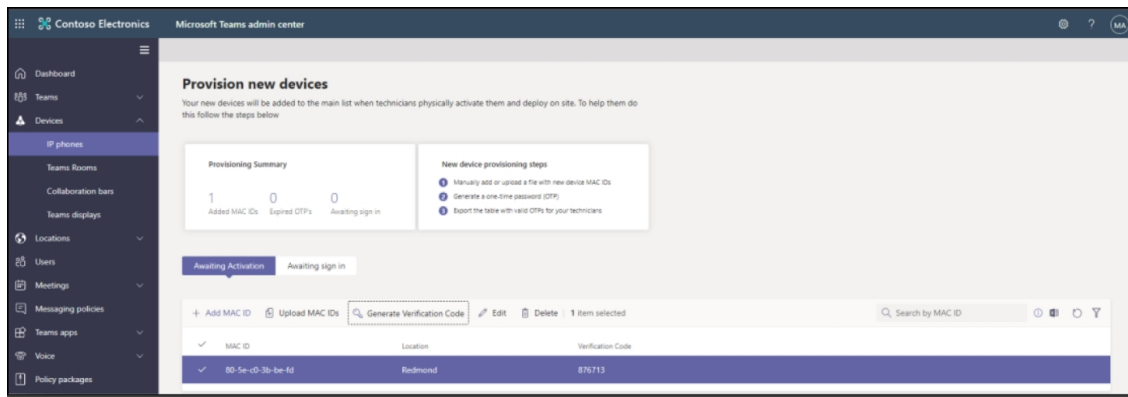
#### Upload a file to add a device MAC address

1. From the **Awaiting Activation** tab, select **Upload MAC IDs**.
2. Download the file template.
3. Enter the MAC ID and location, and then save the file.
4. Select the file, and then select **Upload**.

#### ➤ Step 2: Generate a verification code

You need to generate a verification code for the devices. The verification code is generated in bulk or at the device level and is valid for 24 hours.

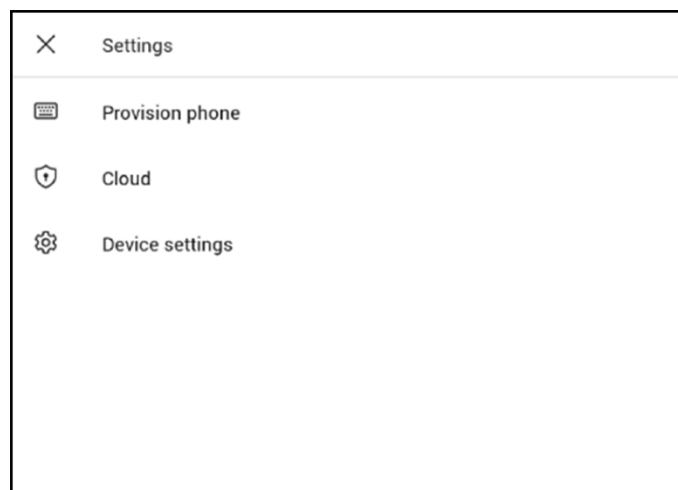
From the **Awaiting Activation** tab, select an existing MAC ID. A password is created for the MAC address and is shown in the **Verification Code** column.



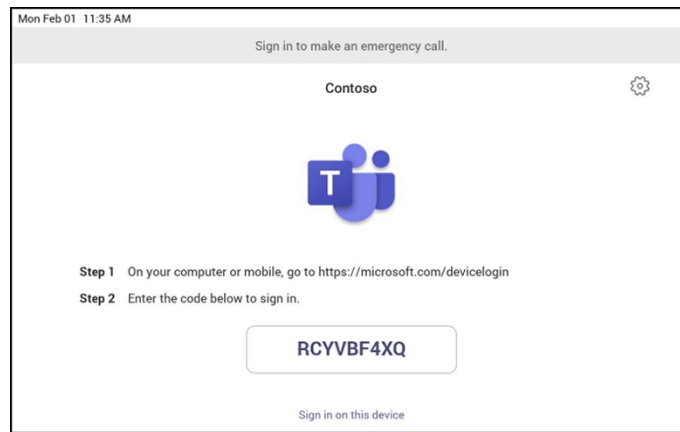
You'll need to provide the list of MAC IDs and verification codes to the field technicians. You can export the detail directly in a file and share the file with the technician who is doing the actual installation work.

### ➤ Step 3: Provisioning on the device

Once the device is powered up and connected to the network, the technician provisions the device by choosing the 'Settings' gear on the top right of the new 'Sign in' page and selecting **Provision phone**.



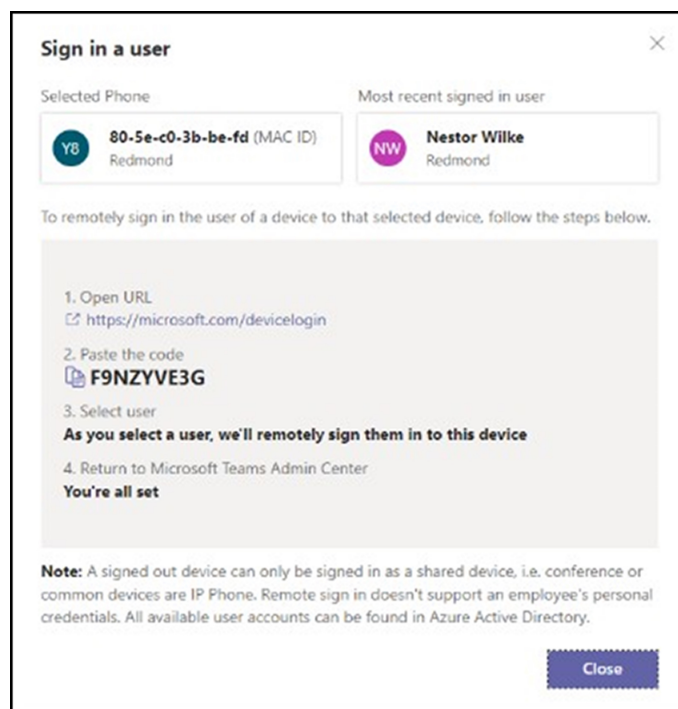
The technician is then expected to enter the device-specific Verification code that was provided in the Teams admin center on the phone's user interface. Once the device is provisioned successfully, the tenant name will be available on the sign in page.



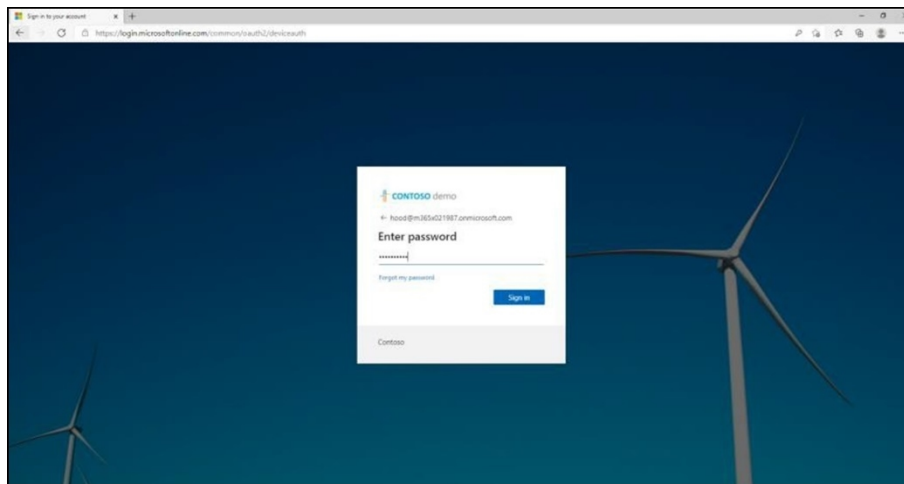
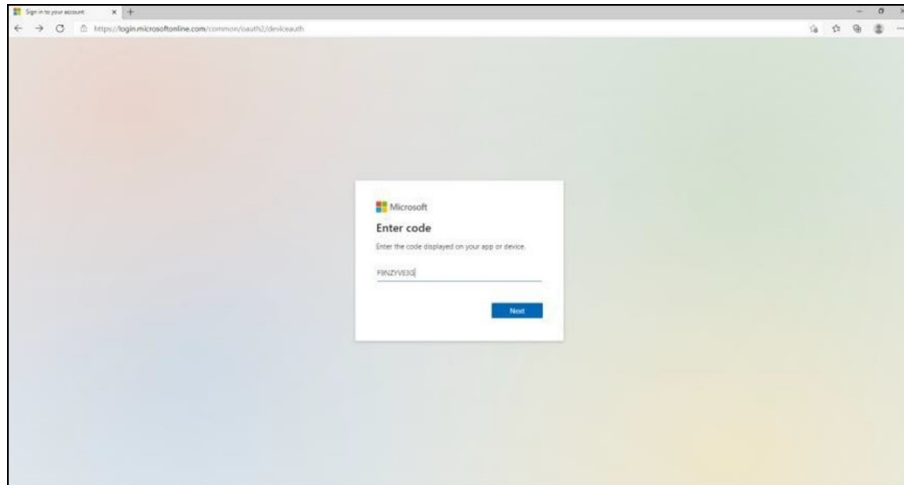
#### ➤ Step 4: Sign in remotely

The provisioned device appears in the Awaiting sign in tab. Initiate the remote sign-in process by selecting the individual device.

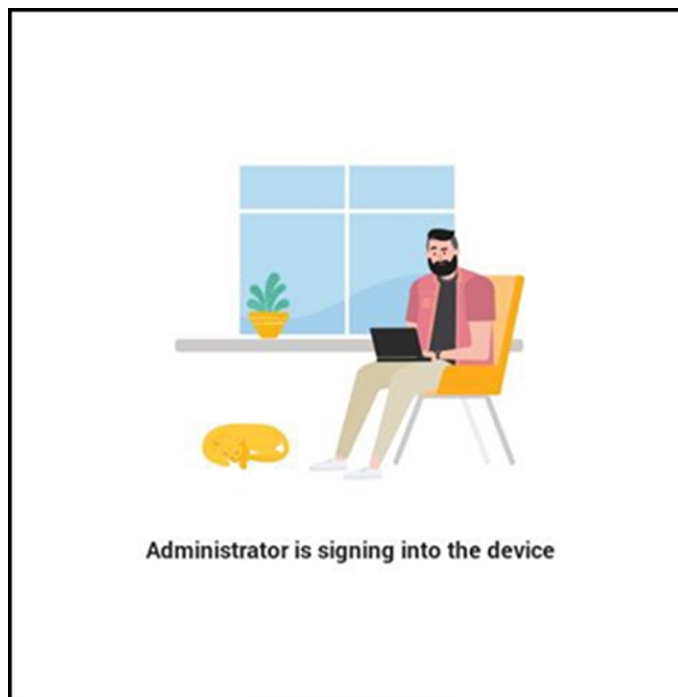
1. Select a device from the **Awaiting sign in** tab.
2. Follow the instructions in **Sign in a user**, and then select **Close**.



The tenant admin is expected to complete authentication on the device from any browser or smartphone.

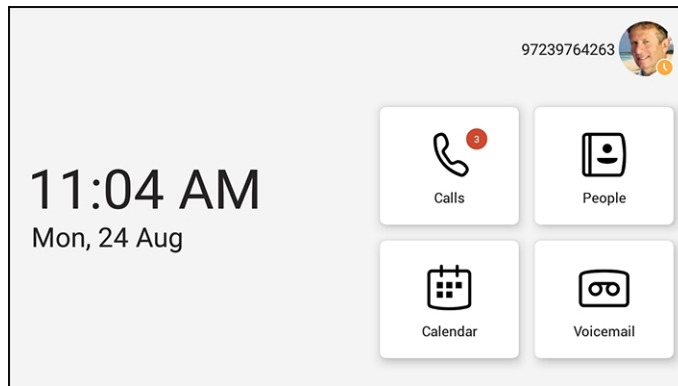


When the tenant admin is signing in from Teams Admin Center, the user interface on the device is blocked to prevent other actions on the phone.

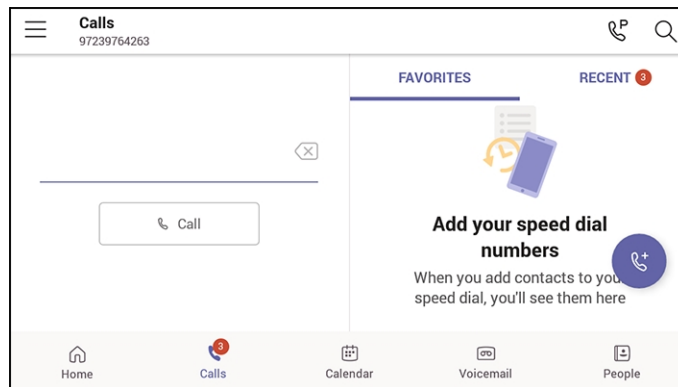


## Getting Acquainted with the Phone Screen

The following gets you acquainted with the phone's user interface. The figure below shows the phone's home screen, aka the phone's idle screen.




The following figure shows the phone's Calls screen.

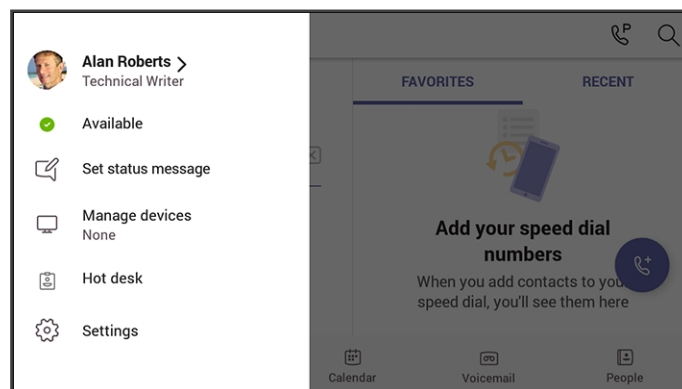


The following table describes the phone's home screen.

**Table 4-1: Calls Screen**

Item	Description
	The phone menu. Select it to open the menu shown in the figure following this table.
Calls	Select the tab to open the Calls screen. The screen shown in the figure preceding this table opens.
People	Select the tab to open the People, shown under <a href="#">Using the People Screen</a> on page 59 opens. Allows you to easily connect and collaborate with teammates, colleagues, friends and family. Through this screen, you can see all your contacts and create and manage contact groups to organize your contacts. The screen provides a simple user experience and aligns with the contacts on the Teams desktop client.  If a contact has multiple numbers, the phone screen allows the user to select from a drop-down menu the intended contact method.
Calendar	Select to open the Calendar screen, shown under <a href="#">Setting up a Meeting</a> on page 58 opens.
Voicemail	Select the tab to open the Voicemail screen, shown under <a href="#">Accessing Voicemail</a> on page 59 opens.

The following figure shows the user's presence status screen.



Use this table as reference.

**Table 4-2: Menu Item Descriptions**

Item	Description
Presence status	See <a href="#">Changing Presence Status</a> on page 53 for more information.
Set status message	See <a href="#">Setting Status</a> on page 51 for more information.



Item	Description
Connect a device	See Connecting a Device for more information.
Hot desk	See <a href="#">Hot Desking</a> on page 52 for more information.
Settings	See <a href="#">Configuring Teams Application Settings</a> on page 55 for more information.
Sign Out	See <a href="#">Signing Out</a> on page 60 for more information.

## Enabling Google Talkback

AudioCodes' Native Teams Android devices feature Google TalkBack, an accessibility service that allows blind and low-vision users to interact with their devices by giving them spoken feedback so they can use their devices without looking at the screen.

The feature improves the experience of these users.

### ➤ To enable the feature:

1. Open the Accessibility screen (**Settings > Device settings > Accessibility**).
2. Select the **TalkBack** option shown in the preceding figure.
3. Click **OK** to switch the feature on as shown in the preceding figures. Listen to the audio tutorial that begins playing. The tutorial explains how to interact with the device.



- After TalkBack is switched on, operations are performed by *touching to select* and then *double-touching to activate*.
- To turn up the volume, touch the **+** key on the phone and in the volume pop-up shown in the figure below, touch the slider to select it; audio announces what level you're at. Double-touch the slider at the level you want.
- To switch off TalkBack, re-access the Accessibility screen and then switch the feature off the same way.

4. After the tutorial, from the 'home' screen open (for example) the Calls screen; audio announces what you did; the Calls screen opens.

### ➤ To interact with the Calls screen:

1. In the Calls screen shown in the preceding figure, select the **Recent** tab; audio informs you what you selected.
2. Select a listed call as shown in the preceding figure; audio informs you whether the call was outgoing or incoming and to / from whom it was made and the day on which it was made.
3. Double-touch the listed call; three icons below it appear.

4. Select the phone icon; audio informs you that you can activate the person's profile. Double-touch the icon; the person's profile screen opens displaying their name, position, email, hyperlinked work phone number and hyperlinked mobile phone number.
5. Select the star icon; audio informs you that you can add to Favorites; double-touch to activate it.

## Opting in or out of Call Queues

Call queue agents can opt out of call queues or opt in based on settings available on the Teams phones.

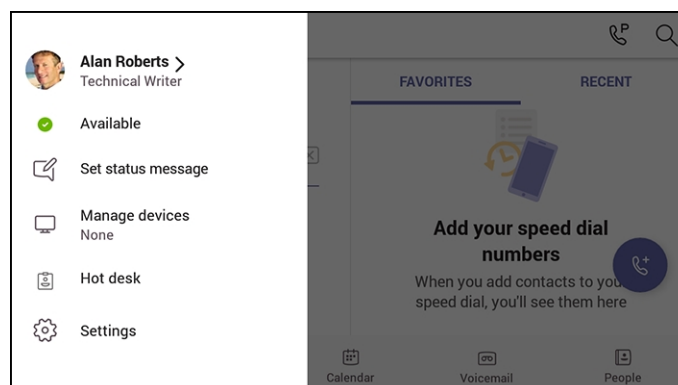


## Setting Status

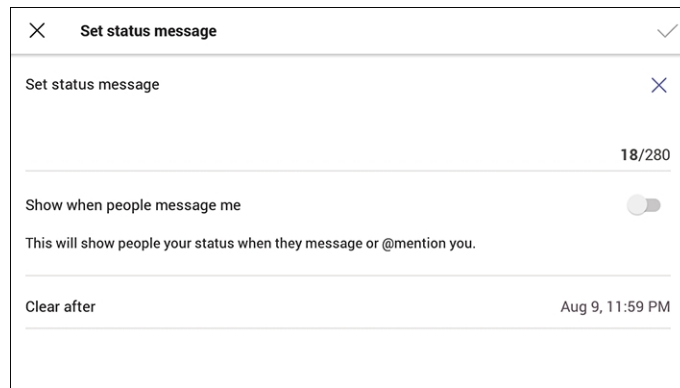
You can set a status message to add more substance to your presence status. For example, a status message such as 'Working from home' adds more substance to the presence status of 'Available'.

### ➤ To set presence status:

1. In the home screen, select the user (avatar) picture.



2. Select **Set status message**.




3. Select the field under 'Set status message' and in the Virtual Keypad that pops up, type in the message you want to show other people, for example, 'Working from home'. The text you type in will replace 'Set status message' in the screen shown in the preceding figure.
4. Optionally, switch on 'Show when people message me'. When people message or @mention you, they'll view the status message you set.
5. Select 'Clear after' and choose when you want the message to stop displaying. Options are:
  - Never clear
  - 1 hour
  - 4 hours
  - Today
  - This week
  - Custom (set a date and time in the calendar that pops up)

## Hot Desking

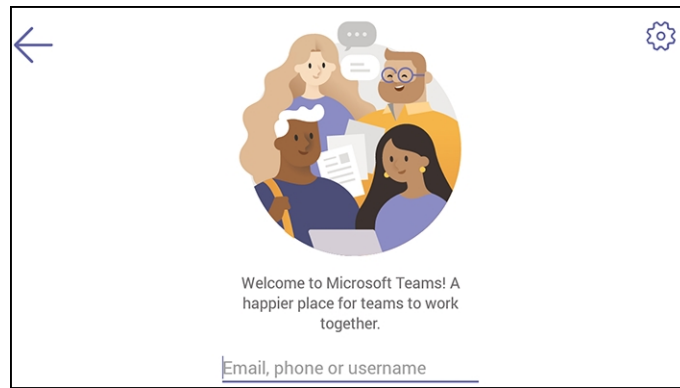
The hot desk feature allows a user to sign in to a phone that is already signed in to by another user without signing out the original user to whom the phone was assigned for primary use.

Any phone in the enterprise network that is enabled with this feature allows any user in the enterprise to temporarily sign into it, make calls, attend meetings and access their calendar and call log. After finishing using these phone functions, the user can sign out to end their hot desk session; call logs and history will automatically be removed from the device.

### ➤ To set up a phone as a shared device for hot desking:

1. Select the user's photo or avatar picture, and then from the menu, select the **Hot desk** option. Alternatively, in the Calls screen (or People screen, Calendar screen or Voicemail screen), select the phone menu  and then select **Hot desk**.

**Figure 4-3: Hot desk**



2. Touch the field 'Email, phone or username'.

**Figure 4-4: Email, phone or username**

3. Use the Virtual Keyboard to type in your email, phone or user name and then select **Done**; the phone is enabled for hot desk.


### Changing Presence Status

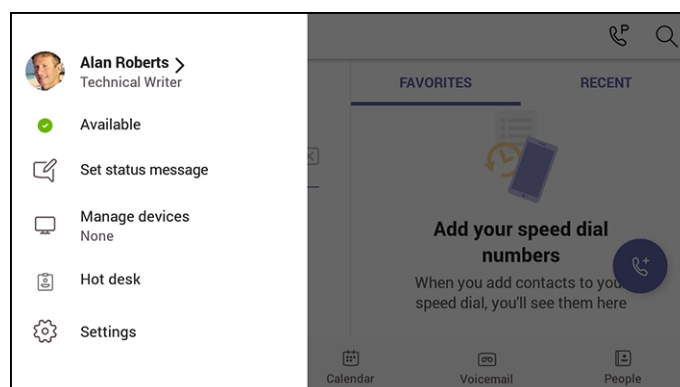
You can assign a presence status to control whether you want people to contact you or not. By default, your status is based on your Microsoft Teams server.



- After *n* minutes (configured in the Teams server by your administrator), presence status automatically changes to 'Inactive'.
- *n* minutes after this (also configured in the Teams server by your administrator), presence status automatically changes to 'Away'; all calls are then automatically forwarded to the Response Group Service (RGS) if it is configured.








➤ **To change presence status:**

1. In the home screen, select the user (avatar) picture or in the Calls and Calendar screen, select .



2. Select the current status displayed and from the drop-down list of statuses then displayed, select the status to change to. Use this table as reference.

Table 4-3: Presence Statuses

Icon	Presence Status	Description
	Available	You're online and available for other contacts to call.
	Busy	You're busy and don't want to be interrupted.
	Do not disturb	You don't want to be disturbed. Stops the phone from ringing when others call you. If DnD is activated, callers hear a tone indicating that your phone is busy; the call is blocked and your phone's screen indicates 'Missed Calls'.
	Be Right Back	You'll be away briefly and you'll return shortly.
	Away	You want to hide your status and appear to others you're currently away.
	Offline	You're going on vacation (for example).
	Reset status	Resets the status.

## Enabling Voicemail Support on CAP Users

The instructions here show how to enable voicemail on common area phone users. Voicemail can be enabled from the phone or from the TAC. The **Advanced calling** setting must be enabled.

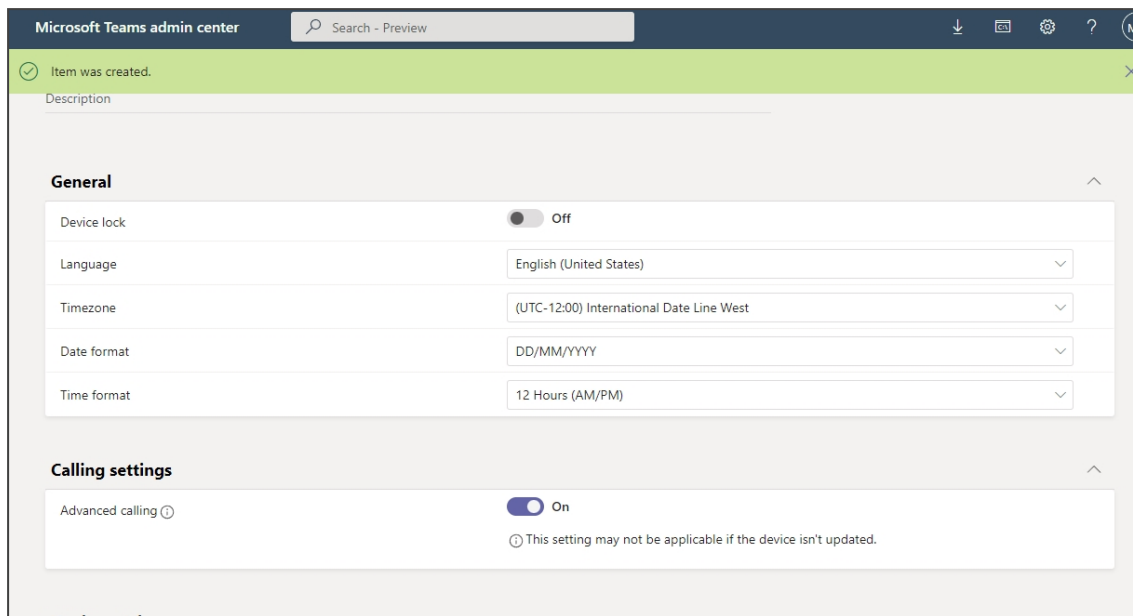
### ➤ To enable voicemail from the phone:

1. In the phone screen, select the avatar.
2. Navigate to **Device Settings > Device administration**.
3. Enter the password **1234**.
4. Access 'Teams Admin Settings' and select **Calling**.
5. Enable **Advanced calling**.
6. Restart the Teams app as prompted.


### ➤ To enable voicemail from the TAC:

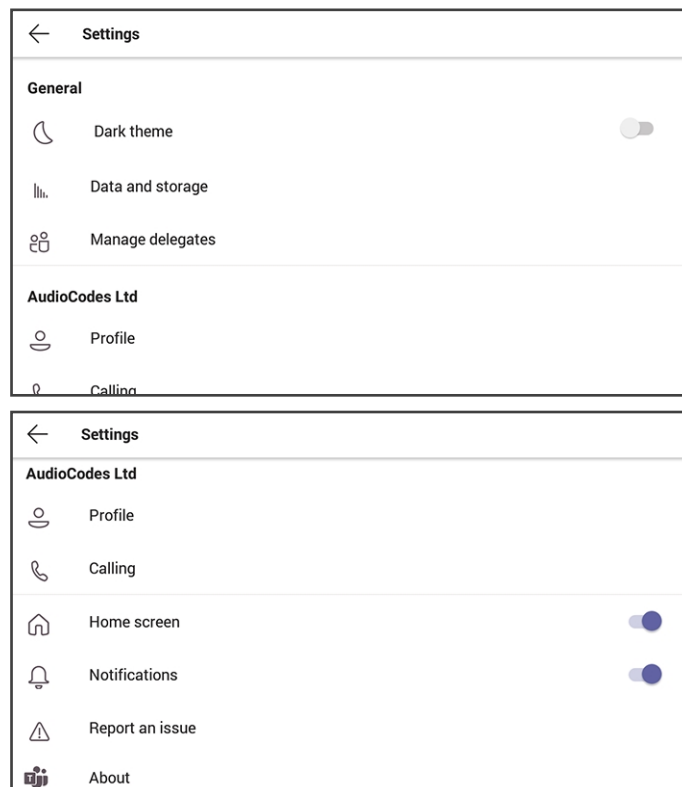
1. Under 'Teams Devices' in the Microsoft Teams admin center, select **Phones**.

2. Go to **Configuration Profiles**; in the profiles there is an option under 'Calling settings' to enable **Advanced calling**.



## Configuring Teams Application Settings

The following describes the Teams application's settings. In the home screen, select the user picture / avatar. Alternatively, in the Calls screen (or People screen, Calendar screen or Voicemail screen), select the phone menu  and then the **Settings** option.



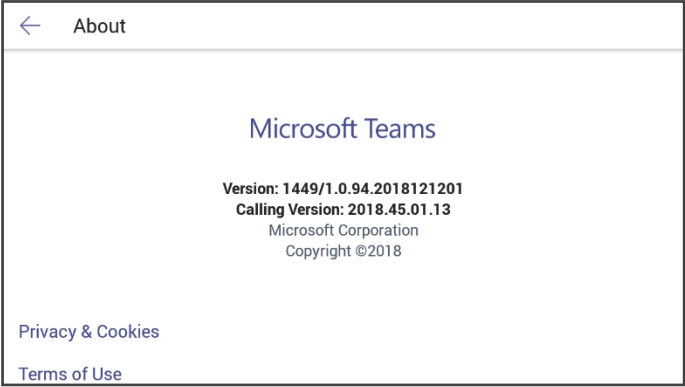
Use this table as reference:

**Table 4-4: Idle Screen Description**

Item	Description
Dark Theme	<p>Dark Theme can be enabled to suit user preference. To enable Dark Theme:</p> <ol style="list-style-type: none"> <li>1. Drag the 'Dark Theme' setting slider to the 'on' position; the following prompt is displayed:                     <div data-bbox="758 510 1204 607" style="border: 1px solid black; padding: 5px; margin: 10px 0; text-align: center;">                         You'll need to restart the app to switch themes.  <span style="float: right;">CANCEL    RESTART</span> </div> </li> <li>2. Choose <b>Restart</b> and then verify after the Teams application restarts that all screens (Teams application and Device Settings) are dark themed:</li> </ol> <div data-bbox="636 775 1321 1550" style="background-color: #121212; padding: 10px; margin: 10px 0;"> <p>The image shows two screenshots of the Teams application and Android Settings in dark theme. The top screenshot is the Teams 'Meetings' screen, which is dark with white text and icons. It shows a meeting card with a profile picture, a name, and a phone number. Below the card are two smiley face emojis and a 'Join Scheduled Meetings' button. At the bottom, there are three navigation icons: 'Calls', 'Meetings', and 'Voicemail'. The bottom screenshot is the Android 'Settings' screen, also in dark theme. It lists several settings: 'Touch screen', 'Languages &amp; input' (English (United States)), 'About' (Android 7.1.2), and 'Device administration' (Device administration).</p> </div>
Profile	Opens the user's email address and photo / avatar picture.
Calling	Opens the Calls screen.

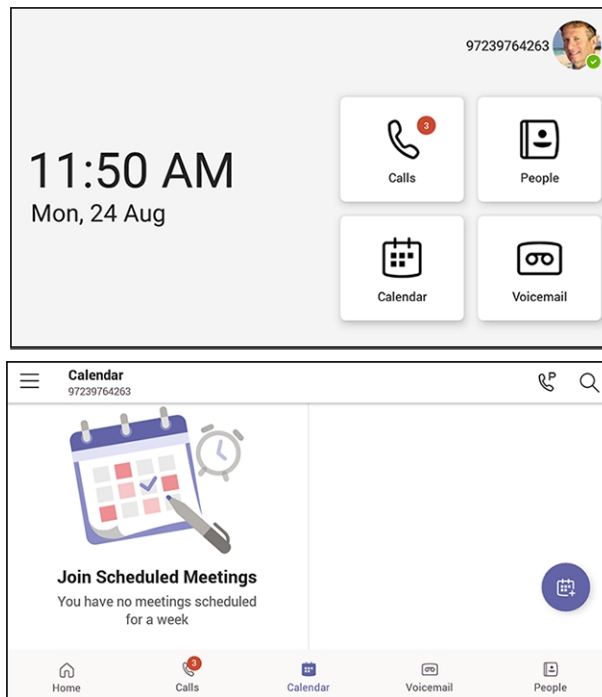
Item	Description
	<div data-bbox="636 262 1326 647" style="border: 1px solid black; padding: 5px; margin-bottom: 10px;"> </div> <p><b>Incoming Calls</b></p> <ul style="list-style-type: none"> <li>■ <b>Call forwarding.</b> Enables automatically redirecting an incoming call to another destination.</li> <li>■ <b>Forward to.</b> Only displayed if the previous setting is enabled. Defines the destination to which to forward incoming calls.</li> <li>■ <b>Also ring.</b> Only displayed if 'Call forwarding' is disabled. Select either <b>Off</b>, <b>Contact or number</b>, or <b>Call group</b>.</li> <li>■ <b>If unanswered.</b> Only displayed if 'Call forwarding' is disabled. Defines the destination to which to forward unanswered incoming calls. Select either <b>Off</b>, <b>Voicemail</b>, <b>Contact or number</b>, or Call group.</li> </ul> <p><b>Caller ID</b></p> <ul style="list-style-type: none"> <li>■ Hide your phone number when dialing people who are outside of Microsoft Teams</li> </ul> <p><b>Block Calls</b></p> <p><b>Block calls with no caller ID.</b> Enables blocking calls that do not have a Caller ID.</p>
Home screen	Default: On (enabled). Slide left to switch off (disable) and block the home screen from view; the Calendar screen takes its place.
Notifications	Default: On (enabled). Allows notifications to be displayed. Slide left to switch off (disable); notifications will not be displayed.
Report an issue	Opens the Send Feedback screen.
About	Opens the About screen.




Item	Description
	
Sign out	Lets you sign out of the phone application as one user and optionally sign in again as another user. See <a href="#">Signing Out</a> on page 60 for detailed information.
Device Settings	Opens the [Device] Settings screen. See <a href="#">Configuring Device Settings</a> on page 20 for detailed information.

## Setting up a Meeting

From the phone's home screen, select **Calendar**.



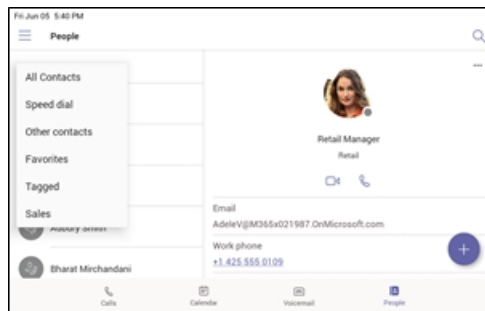
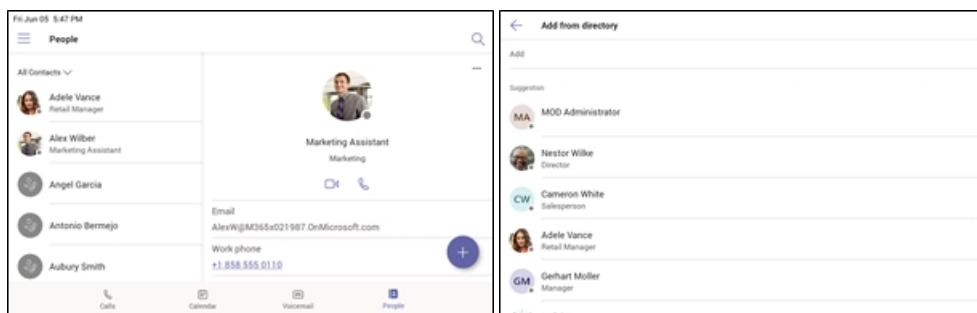
You can join calendar meetings and / or you can select  to add a new event to the calendar.

## Using the People Screen

The People screen allows users to easily connect and collaborate with teammates, colleagues, friends and family. Through the screen, users can see all their contacts and create and manage contact groups to organize their contacts. The screen provides a simple user experience and aligns with the contacts on the Teams desktop client. In addition to accessing the People screen from the menu, the screen can also be accessed from the hard CONTACTS button on the phone.

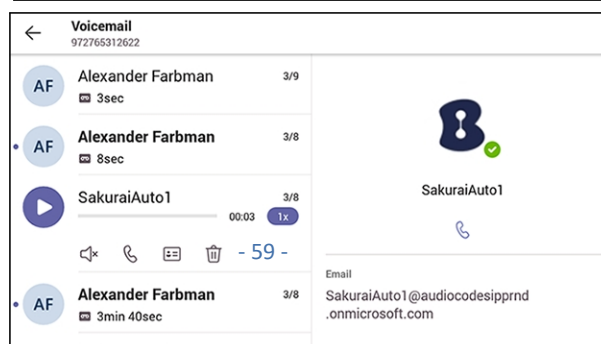
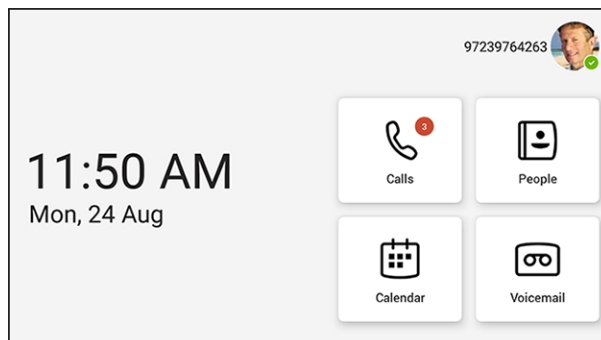


If a user creates a contact within Microsoft Outlook, their information appears under the People app on the phone screen. Contacts in Microsoft Outlook are available in read-only mode. While only phone numbers currently appear, users can search on the phone for contacts and easily call the people they may email or meet with, using Outlook.



## Accessing Voicemail

From the phone's home screen, select the **Voicemail** tab.



## Using Audio Devices

Use one of the following audio devices on the phone for speaking and listening:

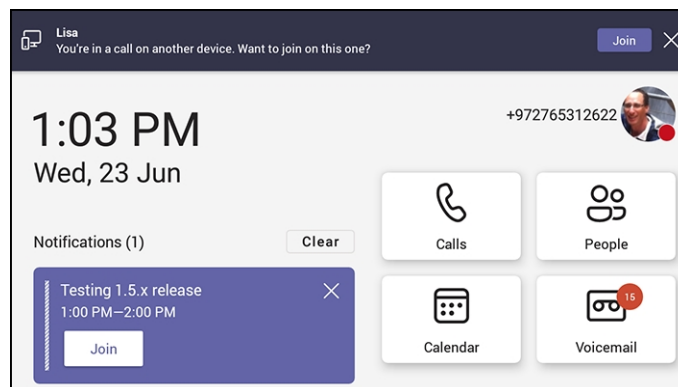
- **Handset:** To make a call or answer a call, lift the handset off the cradle.
- **Speaker** (hands-free mode)
  - To activate it, press the speaker key during a call or when making a call.
  - To deactivate it, press the speaker key again.
- **Headset** (hands-free mode). When talking on the phone, you can relay audio to a connected headset.
  - To enable it, press the headset key.
  - To disable it, press it again.

You can easily change audio device during a call.

- **To change from speaker/headset to handset:** Activate speaker/headset and pick up the handset; the speaker/headset is automatically disabled.
- **To change from handset to speaker/headset:** Off-hook the handset and press the speaker/headset key to activate the speaker/headset. Return the handset to the cradle; the speaker/headset remains activated.

## Transferring Calls and Meetings across Devices

If a user joins a meeting on their PC, they'll view a prompt suggesting adding their Teams device to split the audio and video, or transferring completely.



The feature enables the user to move away from their PC while seamlessly staying connected. The phone recognizes the user is in a call on another device and prompts them to transfer or add, letting them start their call from elsewhere and transfer to their desk phone.


## Signing Out

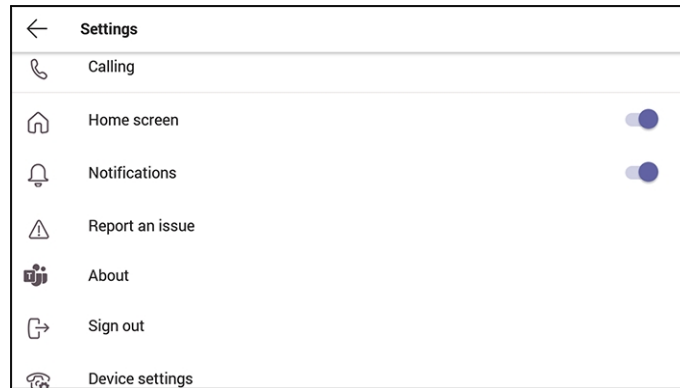
You can optionally sign out of the phone application and sign in as another user.

➤ **To sign out:**

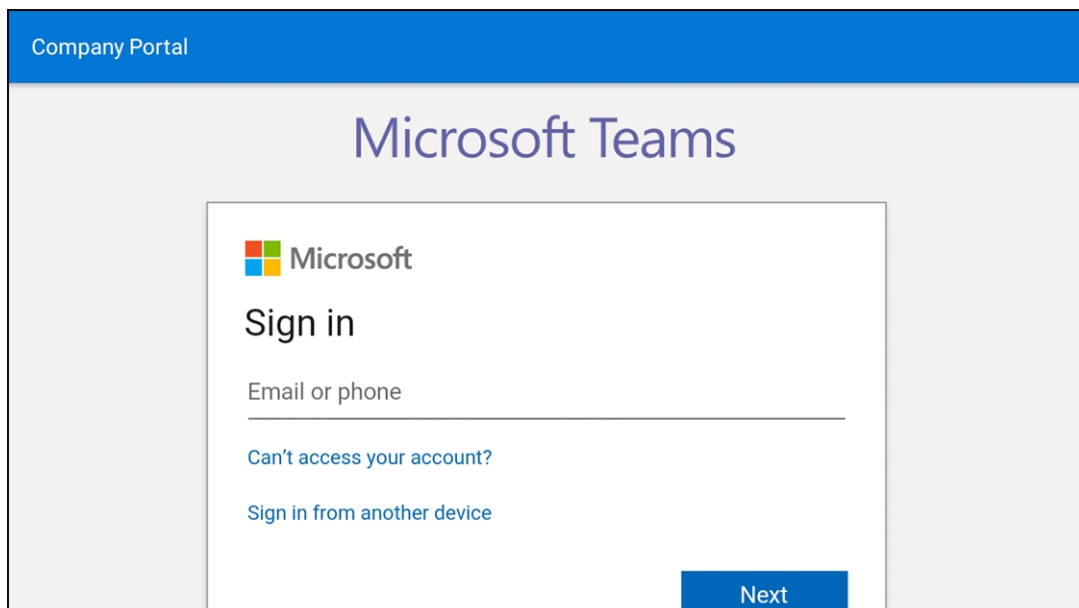
1. Under **Settings**, navigate to and select the **Sign out** option.



Alternatively, in the Calls screen (or People screen, Calendar screen or Voicemail screen), select the phone menu , select the **Settings** option.

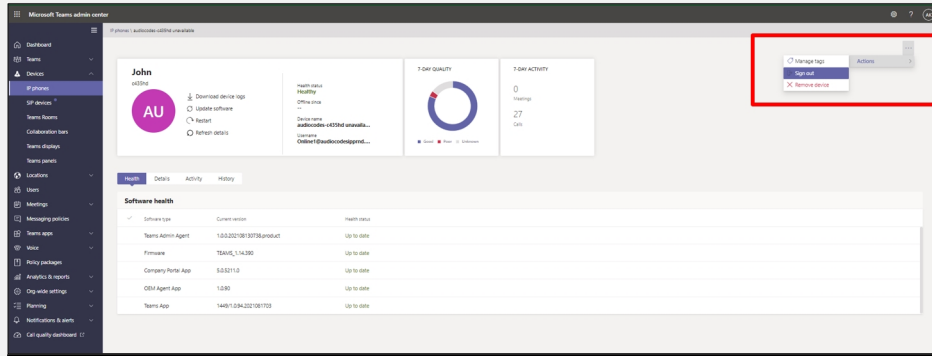


2. After selecting the **Sign out** option, you're prompted 'Are you sure you want to sign out?' Select **OK**; you're signed out and returned to the **Sign in** screen.





Network administrators can alternatively sign out from devices using Microsoft Teams admin center (TAC). Network administrators can also remotely sign in and provision devices from Microsoft's TAC.





## 5 Performing Teams Call Operations

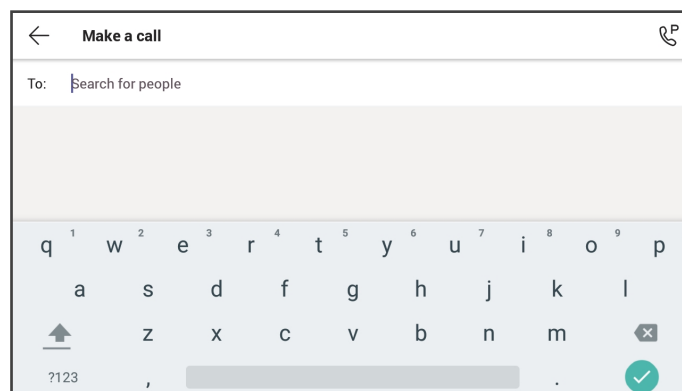
The following documentation shows how to perform basic operations with the phone.

### Making a Call


Calls can be made in multiple ways, for example, you can press the digit keys on the phone's dial pad to enter the phone number or URL.

Alternatively, select a call listed in the Calls screen, and then touch .

Touching  in the Calls screen allows you to make a call by entering the name of a contact.



- You need to touch the 'To: Search for people' field to launch the soft keyboard.
- If you decide to nonetheless dial a destination number rather than the name of a contact, touch **?123** in the lower left corner of the screen.

Touching  located in the upper right corner of the screen shown in the preceding figure allows you to park a call. For more information about parking calls, see [Parking a Call](#) on page 66.

After dialing a destination number, the phone displays the Calling screen while playing a ring-back tone.

#### ➤ To toggle between mute and unmute

- Touch . Touch it again to revert.

You can mute the microphone of the handset, headset, or speaker during a call so that the other party cannot hear you. While the call is muted you can still hear the other party. Muting calls can also be used during conference calls.

#### ➤ To toggle between device and speaker

- Touch .

➤ **To end a call before it's answered at the other end**

- Touch 

➤ **To dial a URL:**

1. Press the speaker key or lift the handset and then touch the 'Place call' field.
2. Enter a URL address. To delete (from right to left), touch the clear key.

## Redialing

You can redial a number you previously dialed.


➤ **To redial:**

- Press the REDIAL hard key on the phone; the first call listed in the Calls screen is redialled.

## Dialing a Missed Call

The phone logs all missed calls. The screen in idle state displays the number of missed calls adjacent to the Calls softkey.

➤ **To dial a missed call:**

- Select the **Calls** softkey and then in the Calls screen, navigate to the missed call to dial if there is more than one listed.
- Select  adjacent to the missed call.

## Select to Dial

All phone numbers that are part of meeting invites or user contact cards can be dialed out directly by selecting them via the phone screen.

## Making an Emergency Call

The phone features an emergency call service. The idle lock screen displays an **Emergency** key.



➤ **To dial the service from the locked idle screen either:**

- Select the **EMERGENCY** softkey shown in the preceding figure of the locked idle screen and then enter the emergency number.



-OR-

- Dial from the locked idle screen without needing to use the **EMERGENCY** key:
  - a. Dial **911**.



- b. Activate the speaker button on the phone.
- c. View the 'Emergency call' screen displaying the dialed emergency number.



When the phone detects that 911 was requested, it automatically dials that number.

## Answering Calls

The phone indicates an incoming call by ringing and displaying **Caller X is calling you**. The LED located in the upper right corner of the phone flashes red, alerting you to the incoming call.



➤ **To answer:**

- Pick up the handset -OR- activate the headset key on the phone (make sure the headset is connected to the phone) -OR- activate the speaker key on the phone -OR- select the **Accept** softkey (the speaker is automatically activated).

## Ending an Established Call

You can end an established call in a few ways.

➤ **To end an established call:**

- Return the handset to the phone cradle if it was used to take the call -or- activate the headset key on the phone -or - activate the speaker key on the phone -or- select the **End** softkey.

## Managing Calls

You can view a history of missed, received and dialed calls.




Each device reports every call from | to that user to the server. All devices that a user signs into are synchronized with the server. The Calls screen is synchronized with the server.

➤ **To manage calls:**

1. Select **Calls** and in the Calls screen, select **Recent**.




- Calls are listed from newest to oldest.
- **Missed call** indicates a call that was not answered.
- Incoming and outgoing calls are differentiated by their icon.

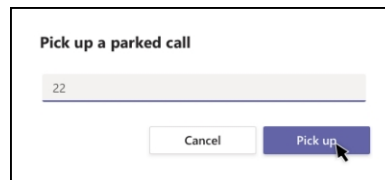
2. Select a call in the list and then select  to call someone back.

## Parking a Call

The phone allows a user to park a call, i.e., transfer a call to a "parking lot" for it to be picked up on any other phone in the enterprise by a party who must enter a code to retrieve it.

➤ **To park a call:**

1. Put the call on hold and park it; you'll receive a unique code from the Teams application.
2. Communicate the code to another user who can then pick up the call on their device. The user on the other device selects the call park icon  displayed in their device's Calls screen.



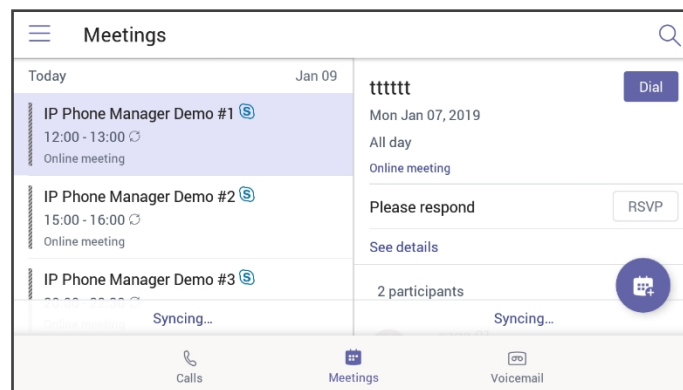
- The user on the other device enters the code communicated to them and then selects the **Pick up** button to pick up the call.

## Managing Teams Meetings

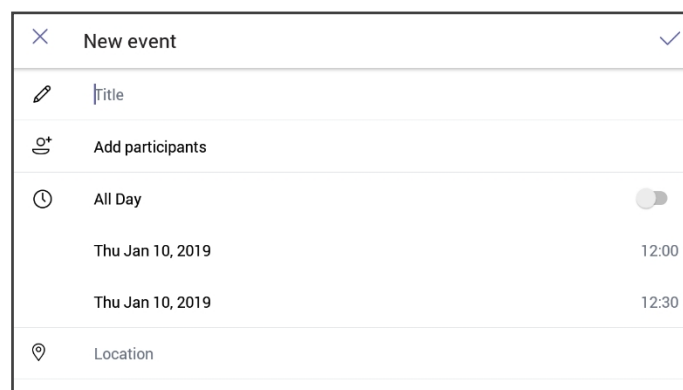
Multi-party conference meetings based on the Teams server (remote conference) can be calendered and initiated from the phone.

### ➤ To manage conference meetings:

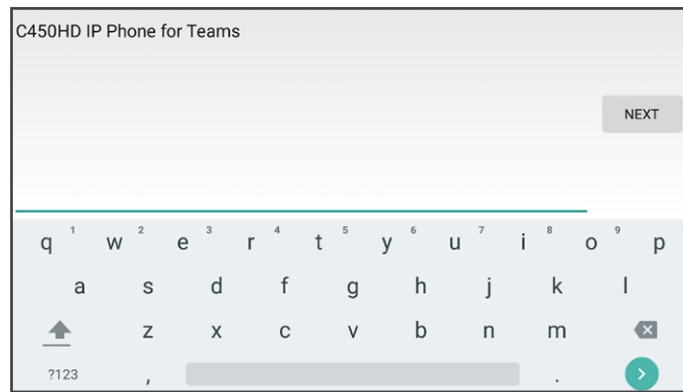
- In the phone's idle screen, select the **Meetings** softkey.



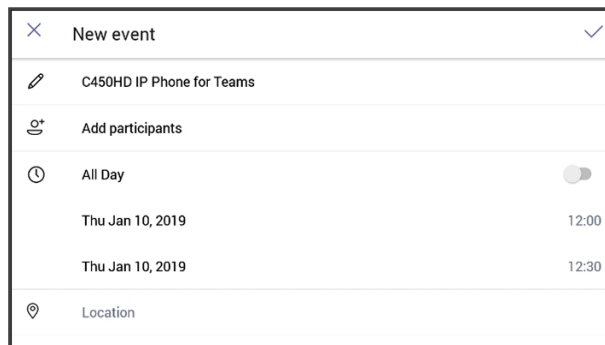
- Touch the + icon.



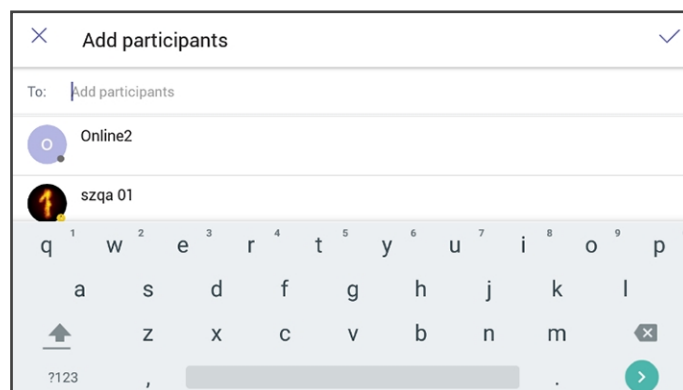
- Touch the 'Title' field. Use the soft keyboard that launches to enter a title for the meeting.



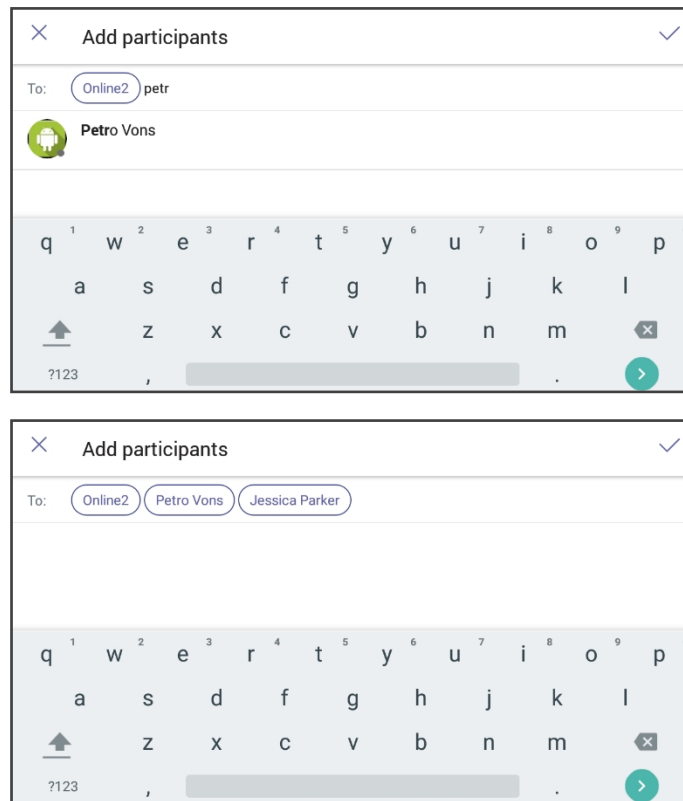
4. Touch NEXT.



5. Touch **Add participants**.



6. Touch the 'To' field and then use the soft keyboard to enter the first letter of the name of the participant to add. If you're searching for **Alex** (for example), touch the letter **A** on the soft keyboard, then l, etc.; the name you're searching for will be promoted to the top of the list of Corporate Directory entries displayed.



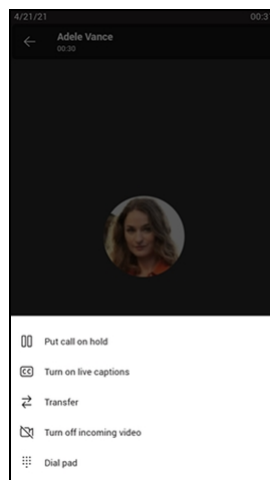
The feature lets you quickly and easily navigate to any employee listed in the Corporate Directory.

## Using Live Captions

The phone can detect what's said in a meeting, group call or 1:1 call, and presents the text on the screen in real-time (live) captions.



- Captions are currently only available in English (US).
- Captions are currently unavailable for phones within government clouds.



For more information, see [here](#).

## Raising a Hand During a Meeting

During a meeting, you can raise a virtual hand from your phone to let people know you want to contribute without interrupting the conversation. Everyone in the meeting will see that you've got your hand up.

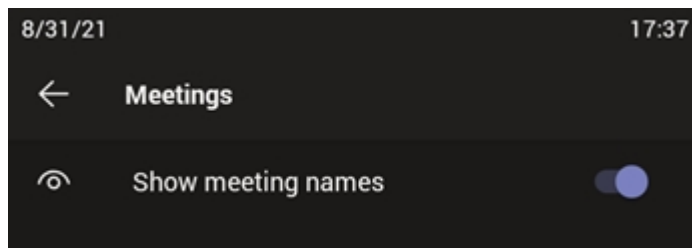
For more information, see [here](#).

## Hiding Names and Meeting Titles for Individual Devices

Names and meeting titles can be hidden for individual devices.

➤ **To hide names and meeting titles per device:**

1. Access the Meetings screen (**More > Settings > Meetings**) (the figure is for illustrative purposes only).



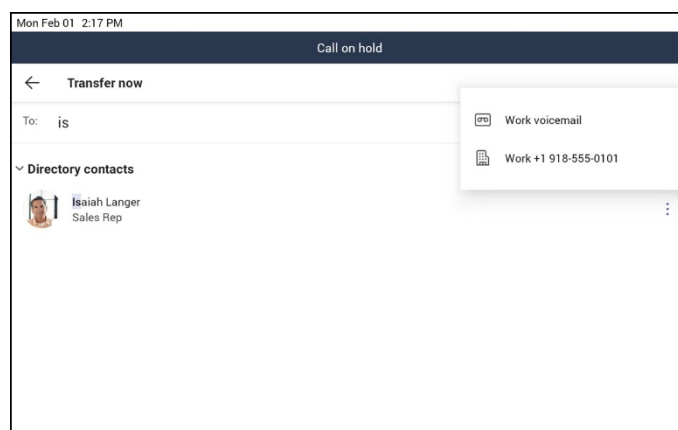
2. Switch off the **Show meeting names** option.

## Transferring a Call to Frequent Contacts

To transfer your calls efficiently to frequent contacts, the phone presents frequent contacts in the transfer screen for a single operation transfer. Contacts not shown in the list can be searched for using the search bar.

## Transferring a Call to Work Voicemail

Users can directly transfer a call into someone's work voicemail without needing to ring the far-end user. This allows them to discreetly leave voicemails for users without interrupting them.

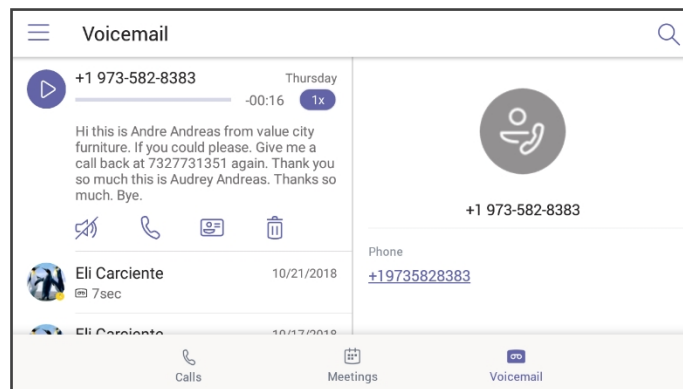


## Viewing and Playing Voicemail Messages

If you hear a stutter dial tone when you pick up the handset, new messages are in your voicemail box. The phone also provides a visual indication of voicemail messages.

➤ **To view a list of your voicemail messages:**

1. Activate the voicemail key on the phone (indicated by the icon of an envelope) which will be illuminated if you have voicemail, or select the Voicemail softkey in the idle screen.



2. Scroll down to select from the list of messages (if there are voicemail messages in your box) which message to **Play**, **Call** or **Delete**.


3. You'll view the following screen if you don't yet have any voicemail messages:

For more information, see [here](#).

## Rejecting an Incoming Call, Sending it Directly to Voicemail

You can send an incoming call directly to voicemail if time constraints (for example) prevent you from answering it. The caller hears a busy tone from your phone.

➤ **To send an incoming call directly to voicemail:**

- When the phone rings to alert to a call, select ; if you have voicemail, the call will go into voicemail; the Microsoft Teams server performs this functionality.

## Adjusting Volume

The phone allows

- [Adjusting Ring Volume](#) on the next page
- [Adjusting Tones Volume](#) on the next page (e.g., dial tone)
- [Adjusting Handset Volume](#) on the next page
- [Adjusting Speaker Volume](#) on the next page
- [Adjusting Headset Volume](#) on the next page

For more information about sound and volume, see [here](#).

## Adjusting Ring Volume

The volume of the phone's ring alerting you to an incoming call can be adjusted to suit personal preference.

➤ **To adjust ring volume:**

1. When the phone is in idle state, select the VOL ▲ or VOL ▼ key on the phone.
2. After adjusting, the volume bar disappears from the screen.

## Adjusting Tones Volume

The phone's tones, including dial tone, ring-back tone and all other call progress tones, can be adjusted to suit personal preference.

➤ **To adjust tones volume:**

1. Off-hook the phone (using handset, speaker or headset).
2. Select the VOL ▲ or VOL ▼ key to adjust the volume.
3. After adjusting, the volume bar disappears from the screen.

## Adjusting Handset Volume

Handset volume can be adjusted to suit personal preference. The adjustment is performed during a call or when making a call. The newly adjusted level applies to all subsequent handset use.

➤ **To adjust handset volume:**

1. During a call or when making a call, make sure the handset is off the cradle.
2. Press the VOL ▲ or VOL ▼ key; the volume bar is displayed on the screen. After adjusting, the volume bar disappears from the screen.

## Adjusting Speaker Volume

The volume of the speaker can be adjusted to suit personal preference. It can only be adjusted *during a call*.



➤ **To adjust the speaker volume:**

1. During a call, activate the speaker key on the phone.
2. Press the VOL ▲ or VOL ▼ key; the volume bar is displayed on the screen. After adjusting the volume, the volume bar disappears from the screen.

## Adjusting Headset Volume

Headset volume can be adjusted *during a call* to suit personal preference.

➤ **To adjust the headset volume:**

1. During a call, activate the headset key on the phone.
2. Press the VOL  or VOL  key; the volume bar is displayed on the screen.

## Playing Incoming Call Ringing through USB Headset

The phone features the capability to ring via a USB headset in addition to via the phone speaker.

➤ **To play the ringing of incoming calls via the USB headset:**

- Configure the following parameter:

audio/stream/ringer/0/audio\_device=**BOTH** (default), **BUILTIN\_SPEAKER** or **TYPE\_USB**

- **BOTH:** Incoming calls play through both the USB headset and the phone's speaker.
- **BUILTIN\_SPEAKER:** Incoming calls play through the phone's speaker.
- **TYPE\_USB:** Incoming calls play through the USB headset.

## Using the Phone as a USB Speaker

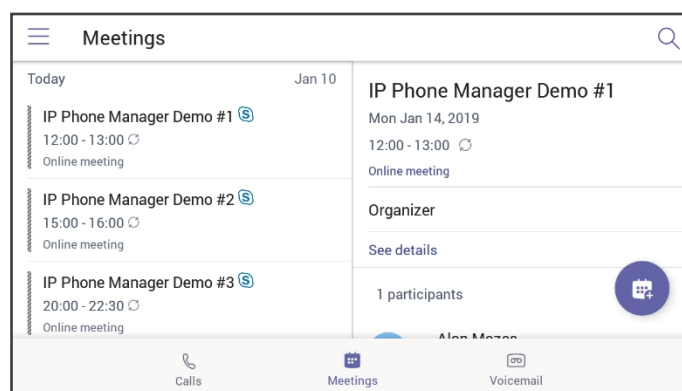
The Device Duo feature enables the phone to be configured as a paired audio device. The feature allows users to use their phone not only as a standalone desk phone but also as a smart audio device for all kinds of UC applications running on the PC. From the Teams app perspective, the phone is like any USB speaker with all controls available in the Teams app on the USB speaker interface.



For more information, see the *Device Duo Application Note for Personal Use*.

## Viewing and Joining Meetings

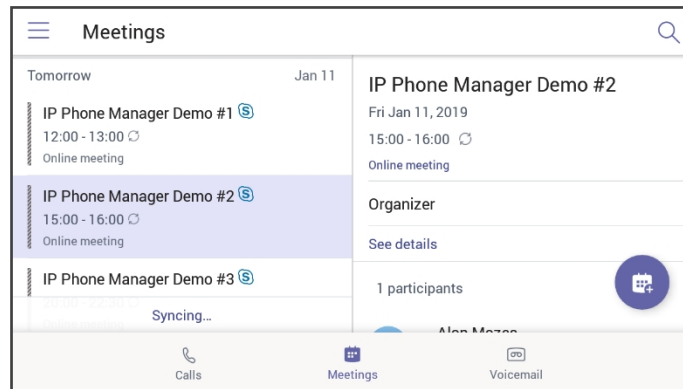
Scheduled meetings can be viewed and joined by selecting the **Meetings** tab.





➤ **To view the details of a meeting:**

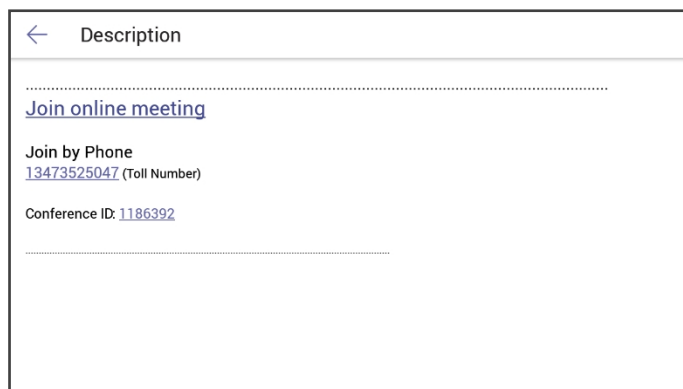
1. Scroll down if necessary to the meeting whose details you want to view and select it.



2. Select **See details** and view in the right pane the details of the meeting.

➤ **To join a meeting:**

- In the meeting you want to join, select the **See details** link and then select **Join online meeting**.



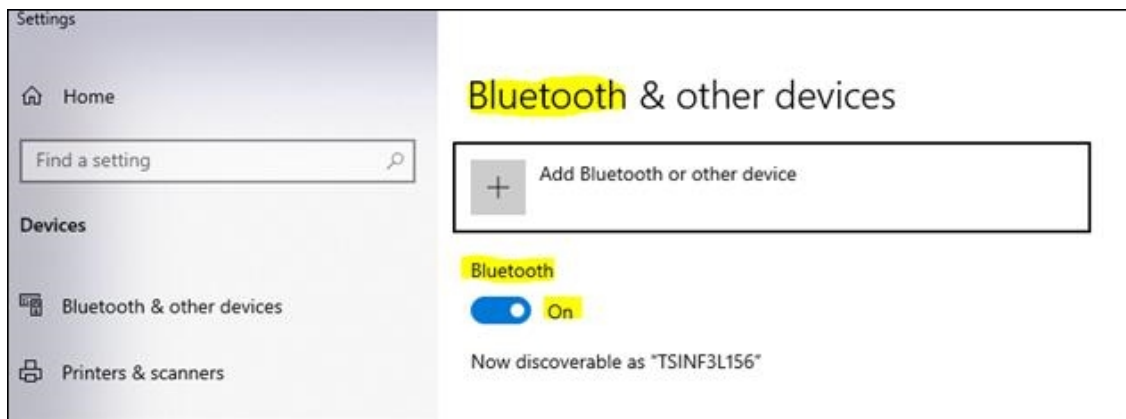
## Better Together over Bluetooth

Read here about how to configure Better Together over Bluetooth with support for:

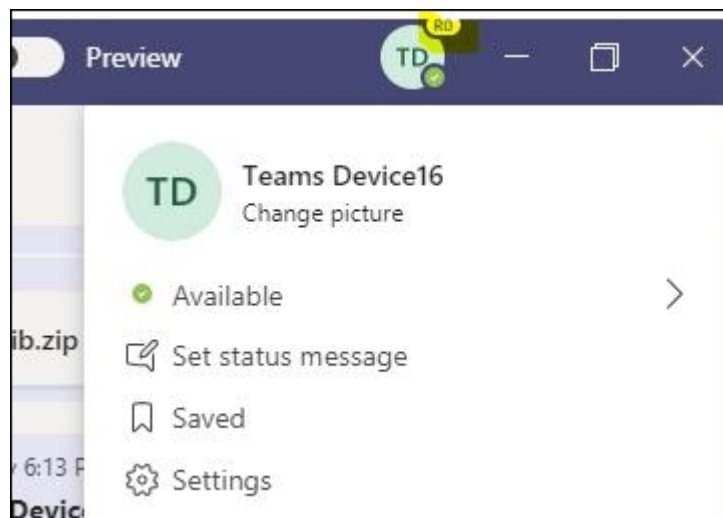
- Pairing with the Teams PC Client
- Lock/unlock synchronization
- [As a feature in preview] Use of the phone as the Teams audio device for calls / meetings

➤ **To set up Bluetooth on the PC side:**

1. Enable Bluetooth on your PC.

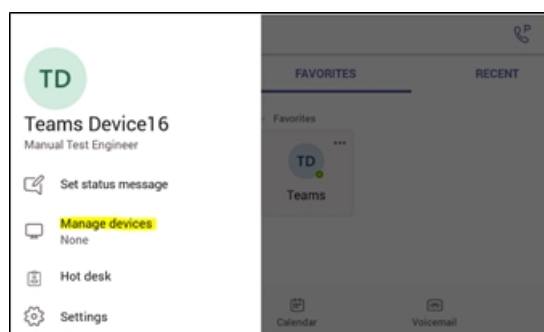


2. Install Teams PC Client on the PC.
3. Sign in to the Teams PC Client with your account (it's necessary to sign in with the same accounts to both the Teams PC Client and to the device).

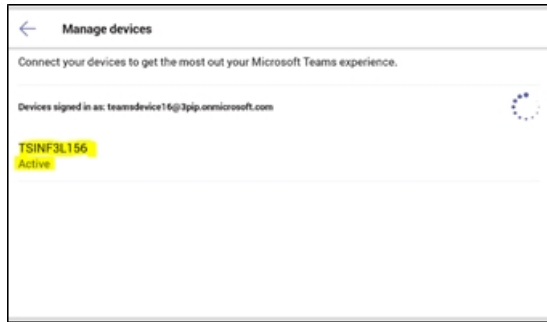


➤ **To set up Bluetooth on the device side:**

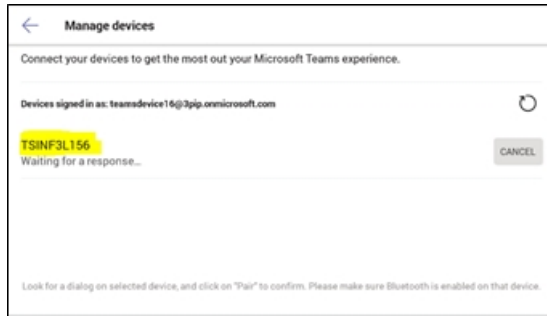
1. Sign in to the Teams application with your account (it's necessary to sign in with the same accounts to both the Teams PC Client and to the device).
2. Go to the hamburger menu on the device and click **Manage devices**.



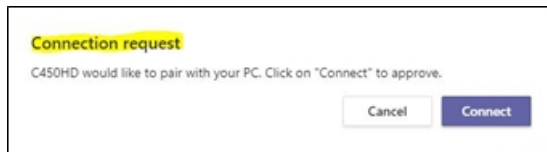
3. View the displayed available device to connect to.



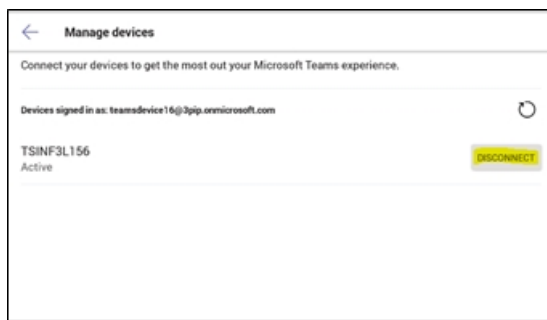
4. Pair the device with your PC.



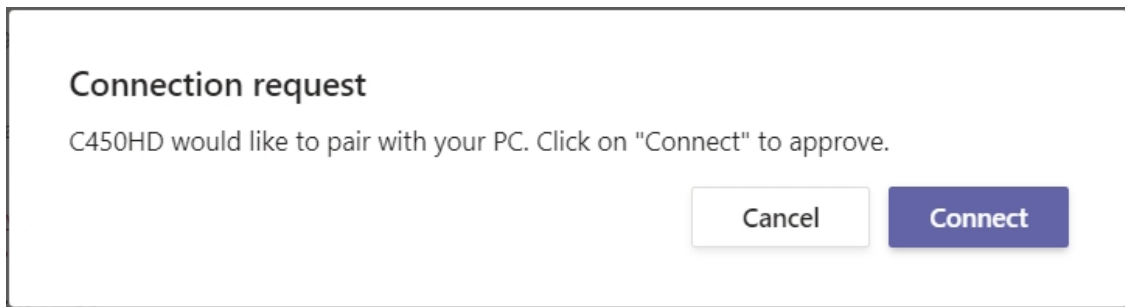
5. View on your PC a notification it gets to accept the connection:



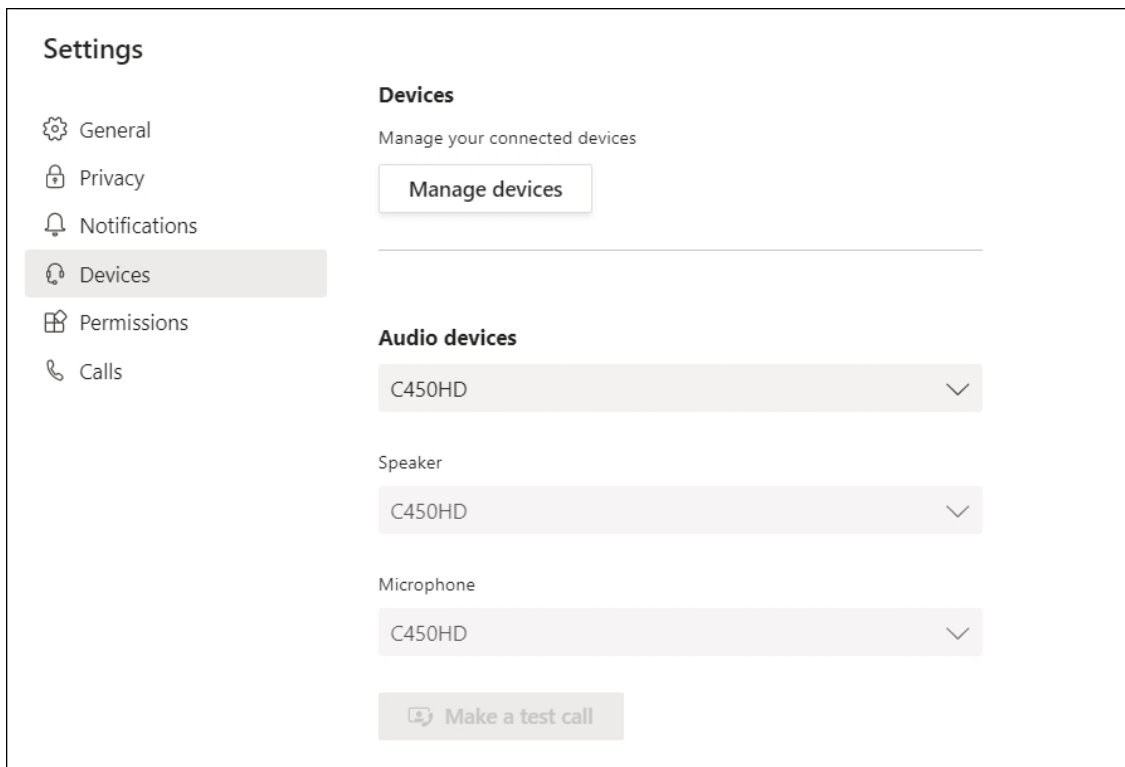
6. Accept the notification from PC.
7. Check the device and make sure pairing was successful:



8. When pairing the phone with the PC Client, the PC Client presents the following request for approval:



Once connected, the phone will be presented as a default Teams PC Client Audio device:



## Adding a Speed Dial



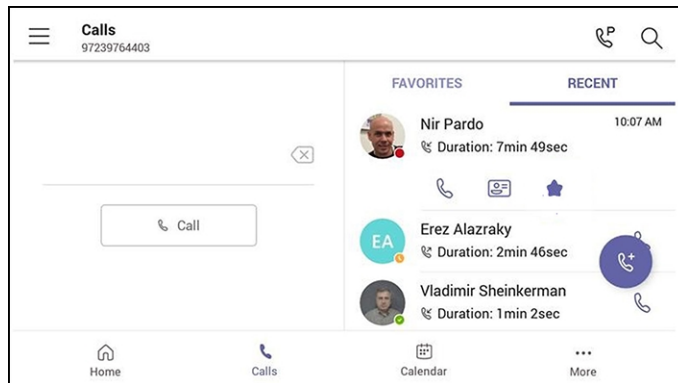
- Applies only to the C455HD phone with Expansion Module (sidecar).
- The feature expands the phone's functional capabilities.
- Users can configure speed dials in the sidecar's BLFs to speed dial frequently-used contacts with the press of a button, determine contacts' presence status from BLF button LEDs, and manage contacts quickly.
- The feature also allows the user to easily transfer a call to a speed dial contact.
- The feature increases user productivity in the workplace.

### ➤ To add a speed dial:

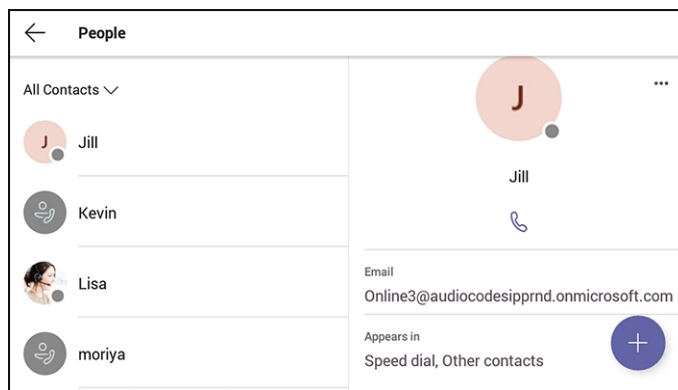
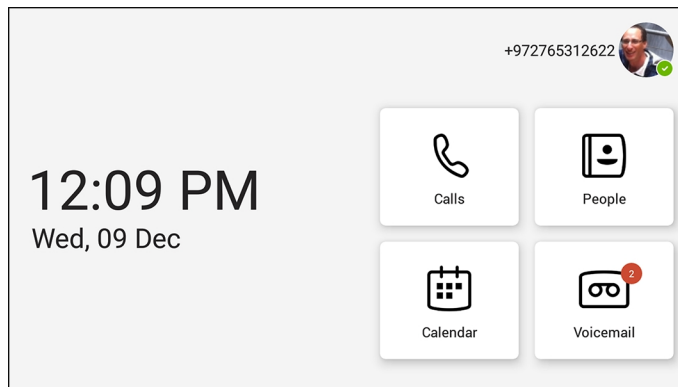
- Add it from the Teams PC client; adding a speed dial from the PC client will be reflected on the sidecar as well.

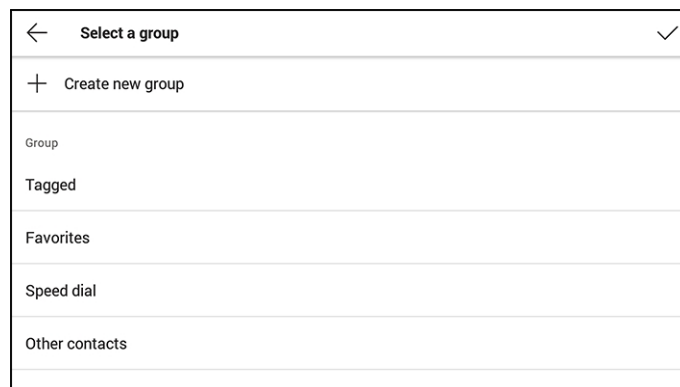
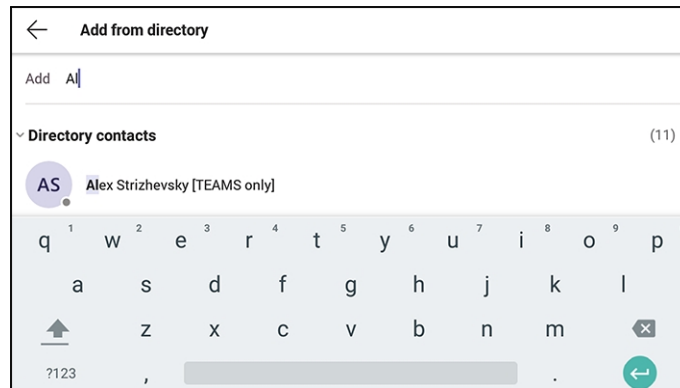
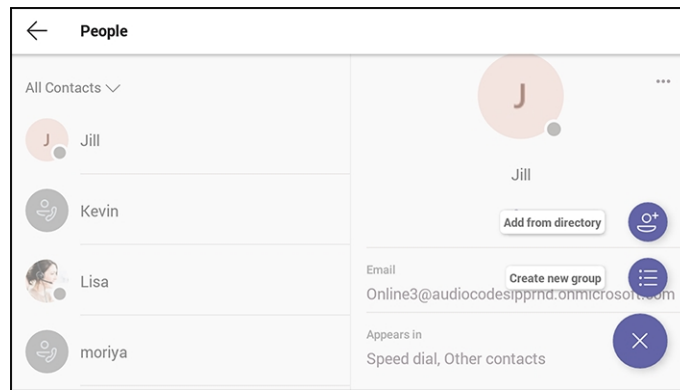
-OR-


- Add it from the C455HD phone using one of the following options:
  - a. Via the **Calls > Recent** tab. Select a user and then select the 'star' icon to add them to the speed dial list:



- b. Via the **People** tab using **+ > Add from Directory** and then add the users to the speed dial.





 The sidecar displays the user's speed dial list. The list is synchronized on all devices under the same user account. The order on the sidecar corresponds to the order of the speed dial list.

## 6 Performing Administrator-Related Operations

Network administrators can:

Update phone firmware manually (see [Updating Phone Firmware Manually](#) on page 86)

Manually perform recovery operations (see [Manually Performing Recovery Operations](#) on page 89)

Remove devices from Intune management (see [Removing Devices from Intune Management](#) on page 90)

Update Microsoft Teams devices remotely (see [Updating Microsoft Teams Devices Remotely](#) on page 98)

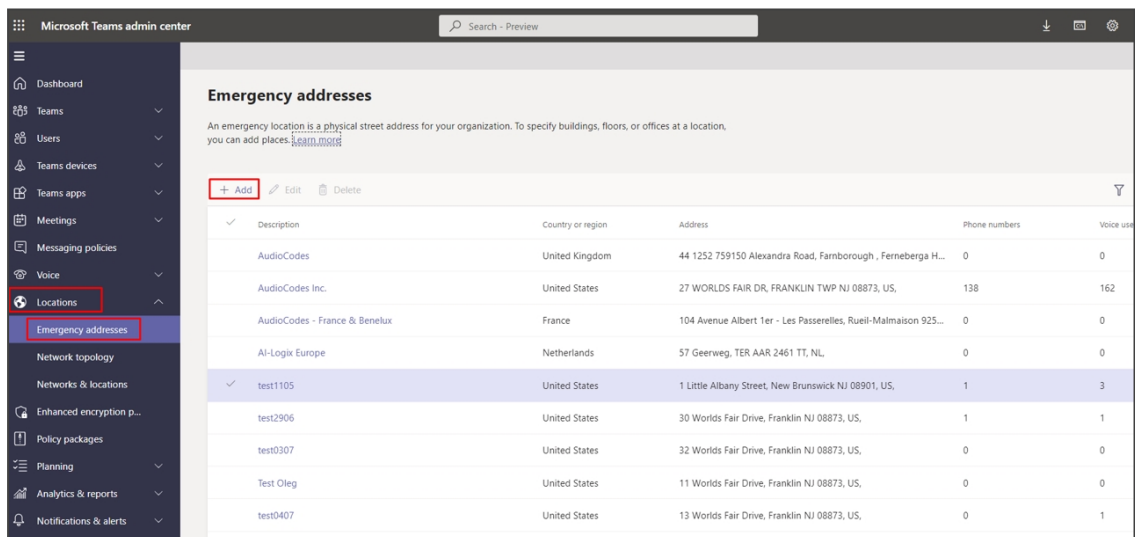
Manage phones with the Device Manager (see [Managing Phones with the Device Manager](#) on page 98)

### Setting up an E911 Emergency Location using TAC

An E911 emergency location can be set up using the Microsoft Teams admin center.

#### ➤ To set up an E911 emergency location:

1. In the TAC, go to **Locations** and in the 'Emergency addresses' page, set a new location by clicking **+ Add**.




2. Enter a name for the location, enable **insert address manually**, make sure that all data is filled in correctly and then click **Save**.

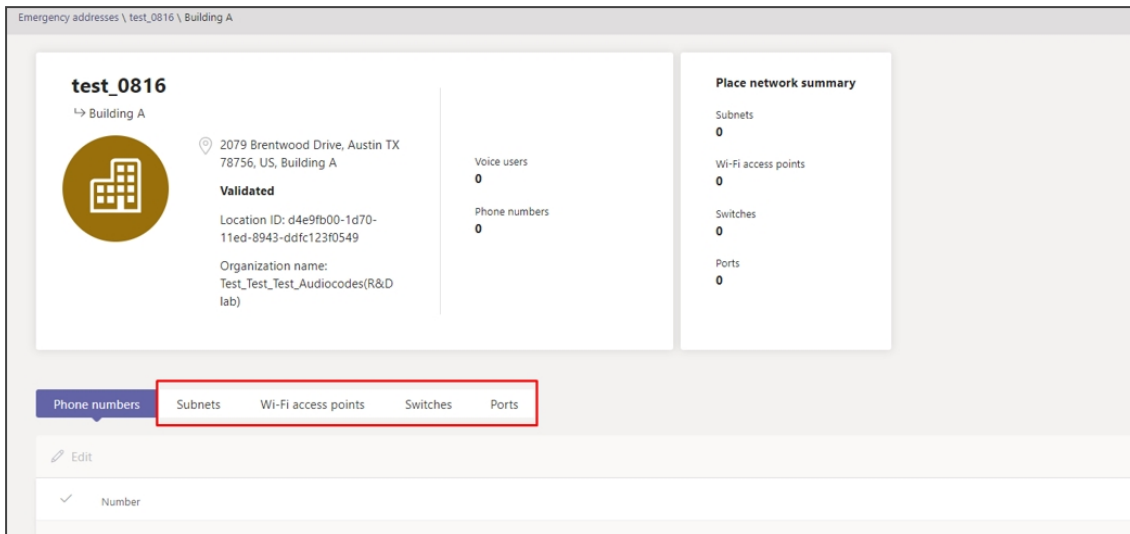
3. After the location has been set, click on the location and add a place (building, etc.). Make sure to maintain the hierarchy. Click **Apply** and verify the place has been set.

4. Enter the place you've set and define how to determine the emergency location. It can be determined by these values:

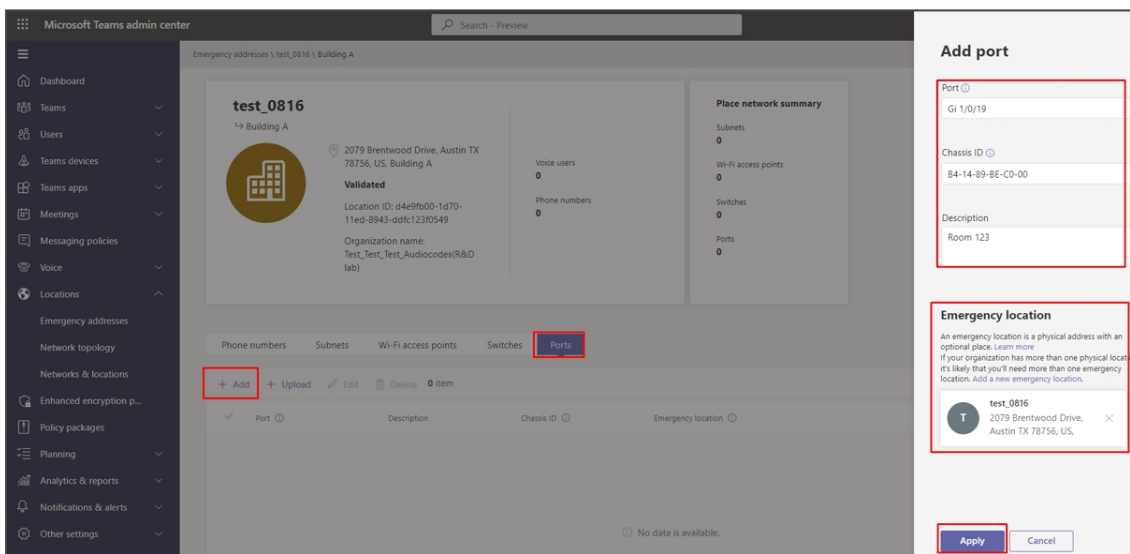
- Port ID
- Switch (Chassis) ID
- BSSID (Wi-Fi access points)
- Subnet
- User predefined location (see below for more details).



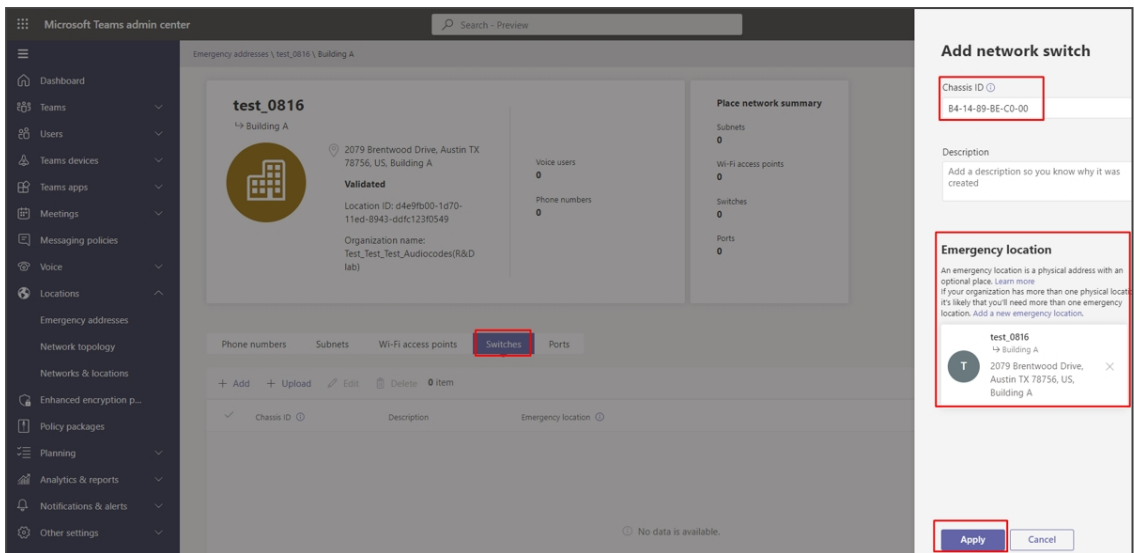
 The hierarchy of displaying a location is determined in the same order as above.



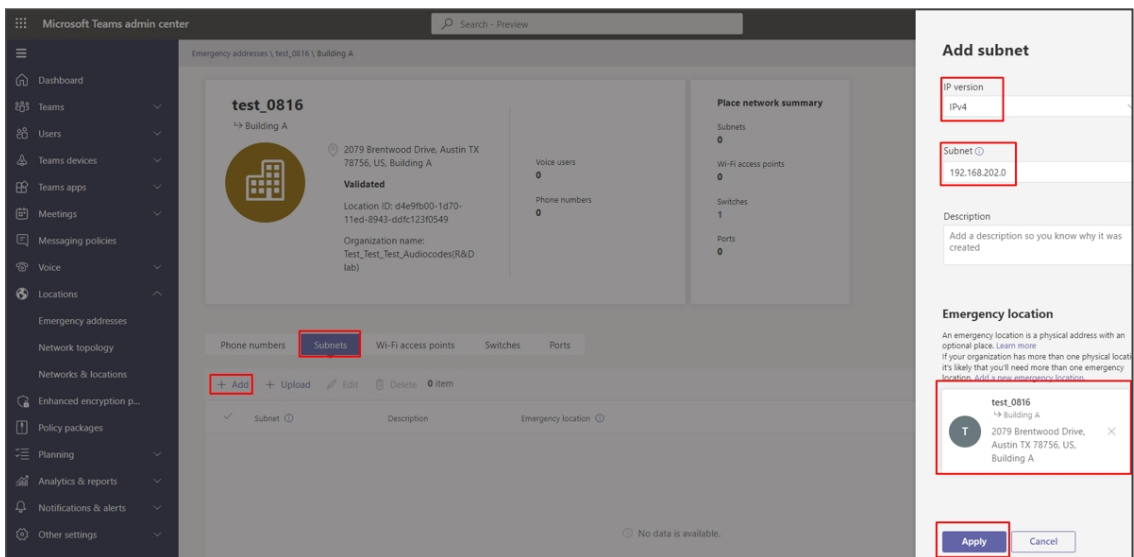
5. Enter a location defined by a specific port ID. Make sure to enter the port description correctly, as delivered from your switch (\* the switch must allow LLDP transmit and receive and provide LLDP information).



6. Define a location defined by switch (Chassis) ID. The location can be the same since a room defined in the previous step can reflect a room in a building using the same switch).



7. Define a location by subnet. The location can be defined like switch ID (if in charge of several buildings, since it reflects a perimeter or an area).



8. Verify all settings have been implemented correctly, under the **Networks & locations** tab.

## Networks & locations

**Subnets** Wi-Fi access points Switches Ports

Each subnet must be associated with a specific network site. A client's location is determined based on the network subnet and the associated network site. You can associate multiple subnets with the same network site but you can't associate multiple sites with the same subnet. [Learn more](#)

**Subnets summary**  
**3** Subnets      **3** Emergency locations

+ Add + Upload Edit Delete 3 items

Subnet ⓘ	Description	Emergency location ⓘ
192.168.202.0		test_0816
192.168.1.0	Oleg's Wifi	test1105
172.17.178.0	Lucky	test0407

Subnets Wi-Fi access points **Switches** Ports

A network switch is a device that connects multiple local area network (LAN) devices, like desktops running the Teams app, using Ethernet connections. The devices use this connection to receive and transfer data to each other. Each network switch is stamped with a chassis ID, which identifies the switch on the network. [Learn more](#)

**Switches summary**  
**3** Switches      **2** Emergency locations

+ Add + Upload Edit Delete 3 items

Chassis ID ⓘ	Description	Emergency location ⓘ
B4-14-89-BE-C0-00		test_0816

9. Verify all settings have been implemented correctly, under the **Networks & locations** tab.

Subnets Wi-Fi access points Switches **Ports**

A network port is a physical Ethernet connection that connects multiple LAN (local area network) devices like a desktop computer that is running the Teams app. For each port, you need to enter the chassis ID of the network switch that connects the port to a switch in Teams. [Learn more](#)

**Ports summary**

**1** Port      **1** Emergency location

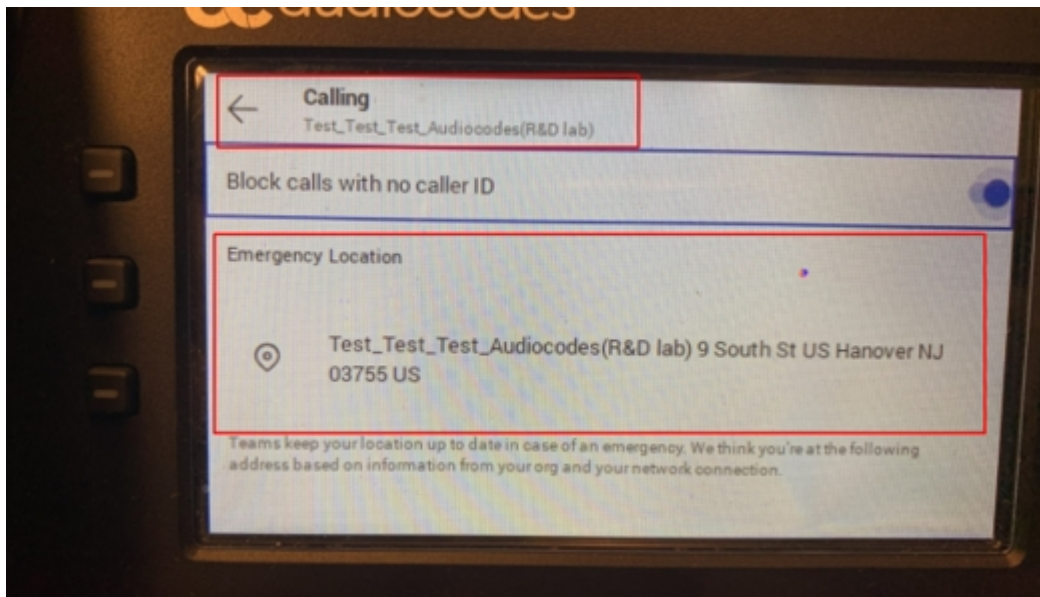
+ Add + Upload Edit Delete 1 item

✓	Port ⓘ	Description	Chassis ID ⓘ	Emergency location ⓘ
✓	Gi 1/0/19		B4-14-89-BE-C0-00	test_0816



After a location has been defined, make sure that:

- AudioCodes' phone runs the latest firmware released.
- AudioCodes' phone runs the Teams app issued June 2022 and later (U3-A and higher).
- E911 information is displayed on the phone screen 30-120 minutes after the location is set (time estimated under laboratory conditions).
- To trigger information to be shown before that time period, you can:
  - ✓ Dial a 933-test call and check if the location has been accepted, displayed and vocalized by the announcer.
  - ✓ Enter the 'Calling' menu from the phone's home screen and verify the location is presented there (entering the 'Calling' menu triggers the information to be pulled from MS servers).

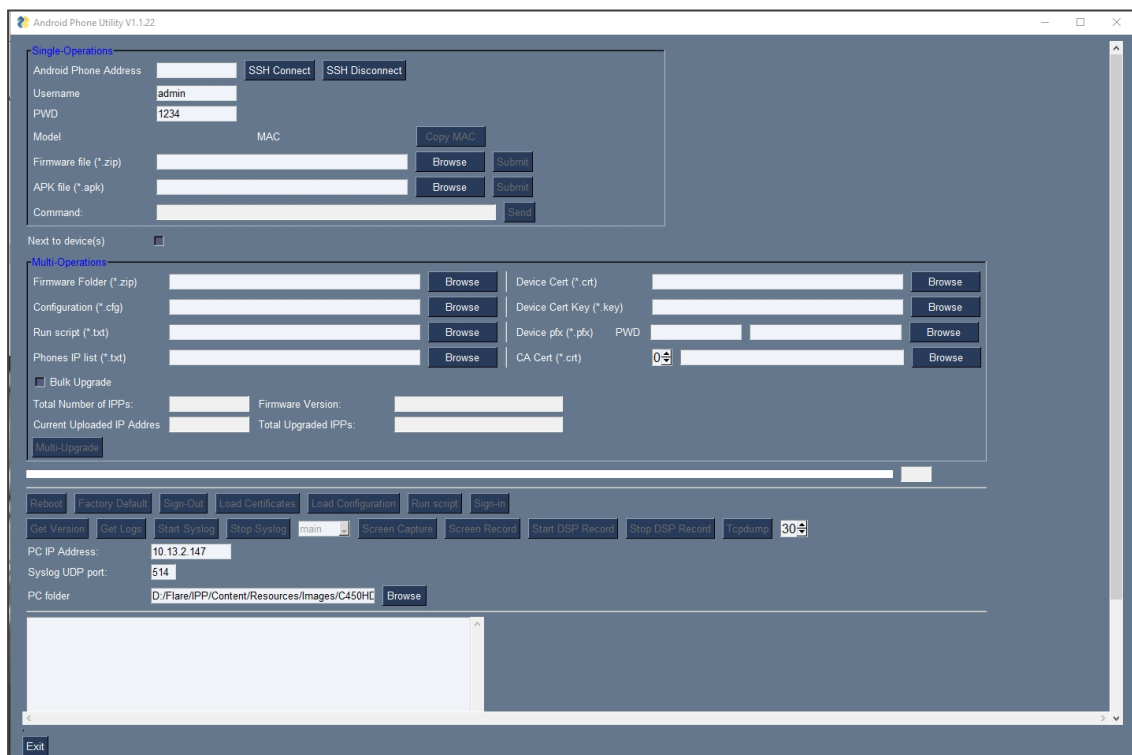


## Updating Phone Firmware Manually

AudioCodes' Android Phone Utility allows network administrators to manually update a phone's firmware.

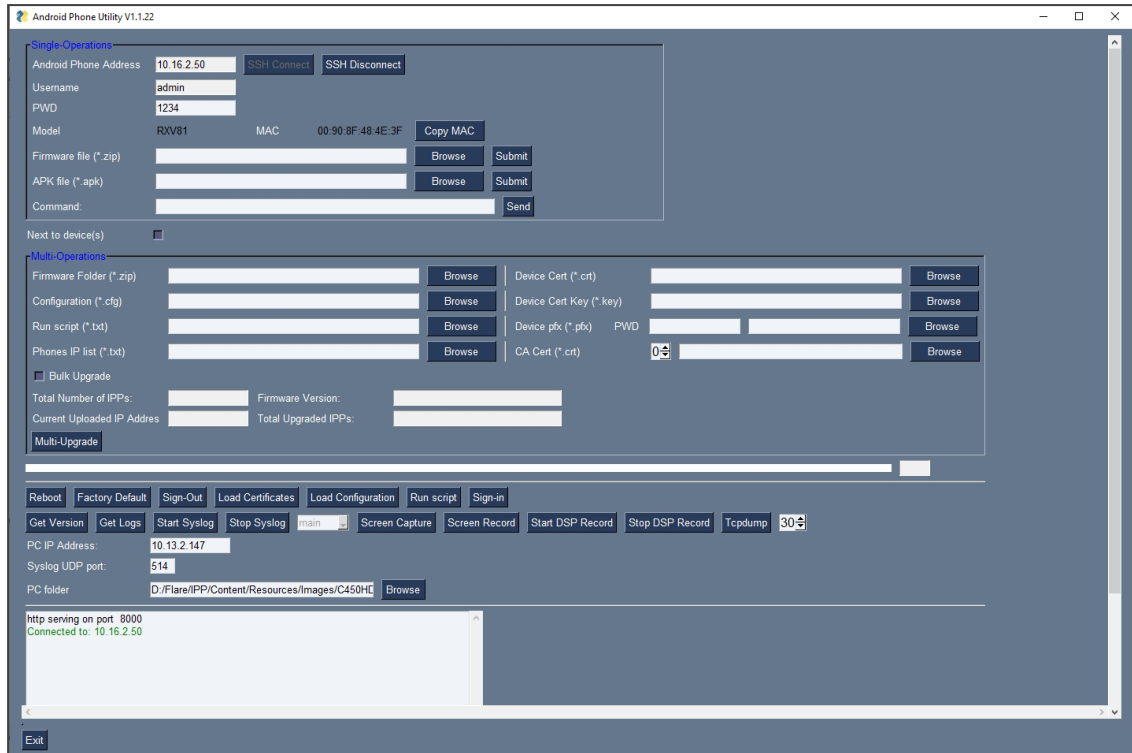
### ➤ To manually update a phone's firmware:

1. From the PC's **Start** menu, select the app icon or click the application's exe file in the folder in which you saved it.

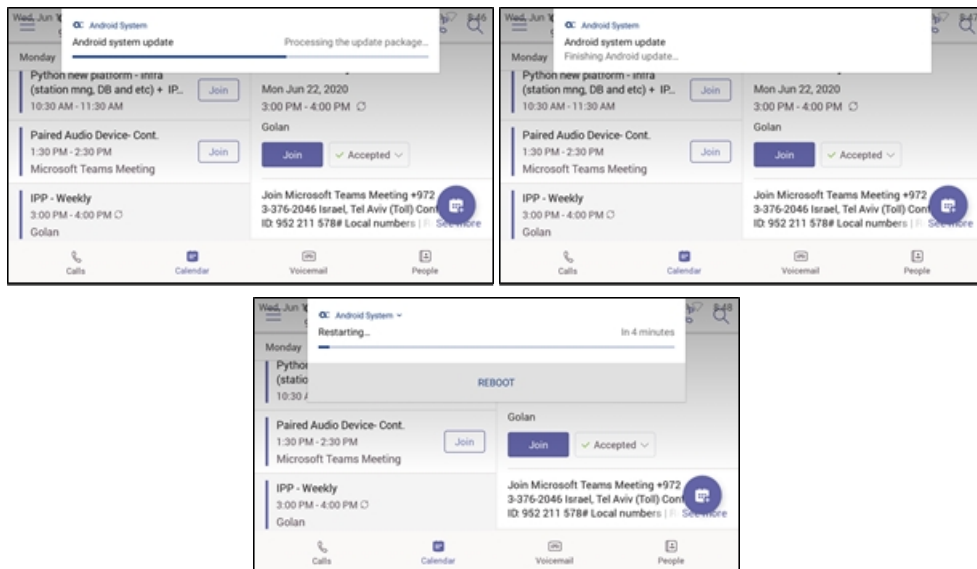


2. In the 'Android Phone Address' field, enter the IP address of the device .

3. Click **SSH Connect**; a connection with the device is established.



4. Under the 'Single Operations' section of the screen next to the field 'Firmware file', click the **Browse** button and navigate to and select the candidate image file.
5. Click the **Submit** button; a firmware upgrade process starts; the phone is automatically rebooted; a notification pops up when the process finishes. The phone notifies you that it's being updated and rebooted.



The above is also displayed when the phone is upgraded remotely from Microsoft Admin Portal or from AudioCodes' Device Manager.

## Downloading Certificates

The following shows how to load user certificates to a single device and to multiple devices. Before loading certificates, put the certificate files in a designated folder.

Certificates can be downloaded using:

- Device Manager (see the *Device Manager Administrator's Manual*)
- Android Phone Utility



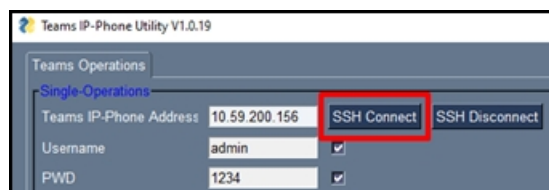
- The extension of the device certificate file must be **.crt**
- The extension of the private key must be **.key**
- The extension of the CA certificate file must be **.crt**. It's possible to load up to 5 CA certificates to the phone using the placement selector (0-4) (Default: 0).

## AudioCodes Android Phone Utility

Certificates can be loaded to a phone or to multiple phones using AudioCodes' Android Phone Utility.

### ➤ To load certificates to a single device:

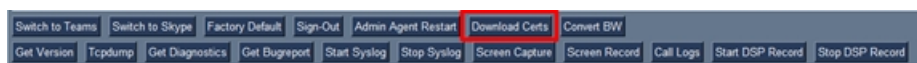
1. In the Android Phone Utility (see [Android Phone Utility](#) on page 105 for detailed information about the application), enter the phone's IP address and click **SSH Connect**.



2. Click the **Browse** button next to the field 'Certs Folder' and navigate to and select the certificate file to download.



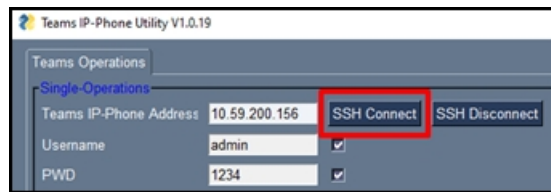
3. Click **Download Certs** to add the certificate.



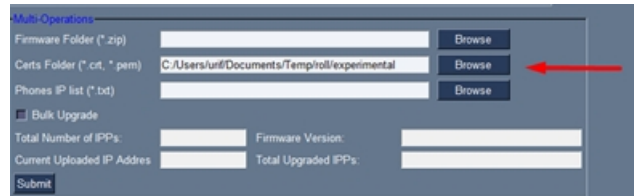
4. After a short period, view in the results pane 'Certs Successfully Installed'.

### ➤ To load certificates to multiple devices:

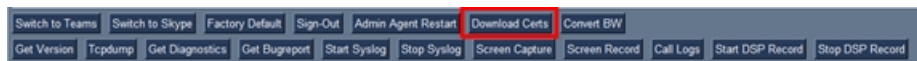
1. In the Android Phone Utility (see [Android Phone Utility](#) on page 105 for more information), enter the phone's IP address and click **SSH Connect**.



2. Click the **Browse** button next to the field 'Certs Folder' under Multi Operations and then navigate to and select the certificate files to download.



3. Click the **Browse** button next to the field 'Phones IP List' under 'Multi Operations' and then navigate to and select the txt file listing the IP addresses of the phones to which to download the certificates. The IP addresses are listed one under the other. Each occupies its own line. No notation between them is required.
4. Click the now activated **Download Certs** button to add the certificates to the phones.



5. After a short period, view in the results pane 'Certs Successfully Installed'.

## Manually Performing Recovery Operations



Besides manual recovery options, the Android phones also feature an independent, automatic problem detection and recovery attempt capability that can culminate in recovery mode or in switching image slots. Android phones also feature a 'hardware watchdog'. This feature resets the phone if Android is stacked and doesn't respond (though Android stacking is unlikely); there's no recovery process; the phone is only reset.

All AudioCodes devices have a reset key or a combination of keys on the keypad to reset it.



While a device is powering up, you can perform recovery operations by using a two-key combination. When using a two-key combination, the device's main LED changes color after every *n* seconds; each color is aligned with a recovery operation option.

When?	Action	Press key combination	LED flashes 3x after release
Start pressing immediately after	Recovery mode (you	Back key +	Red



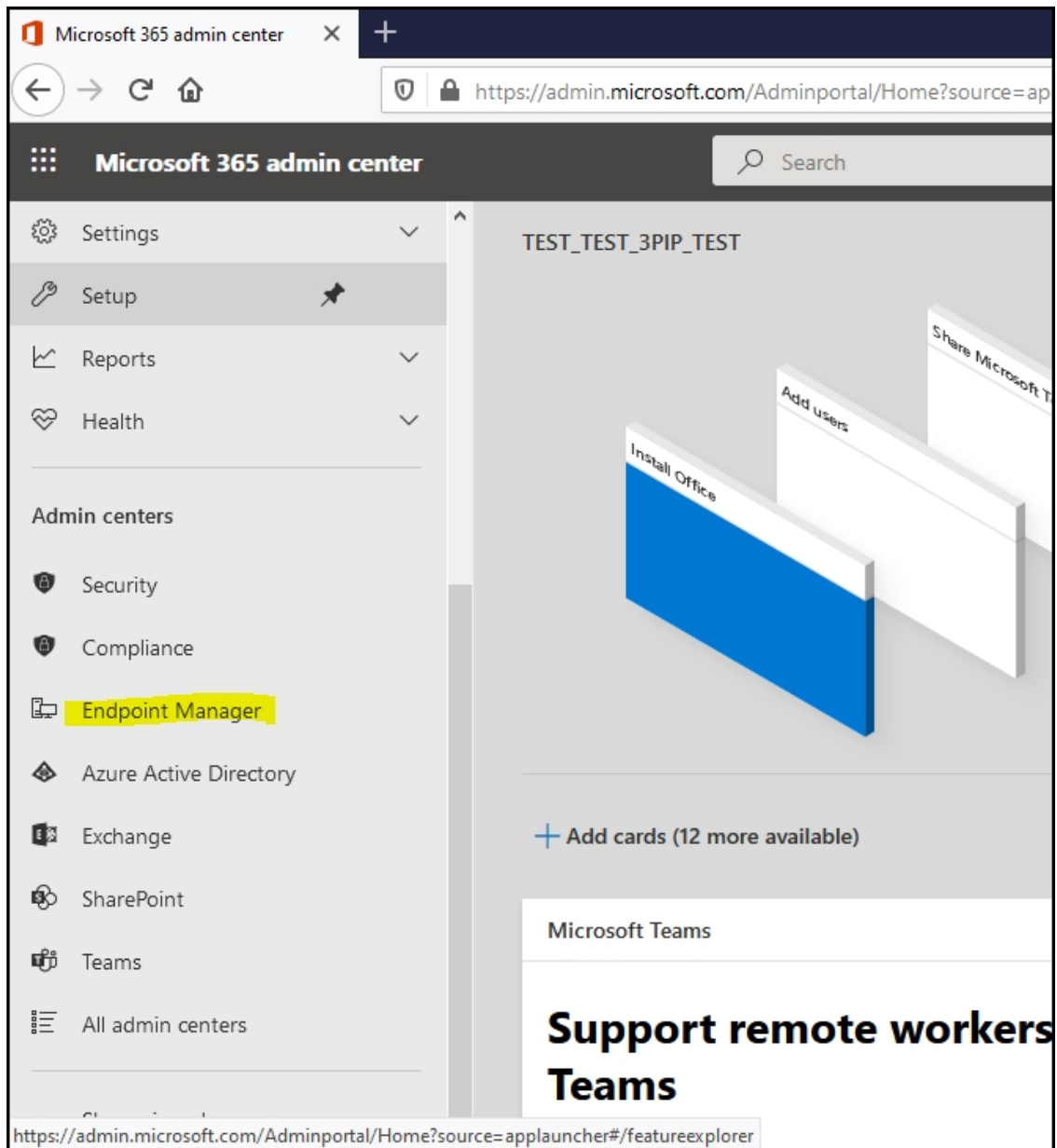
When?	Action	Press key combination	LED flashes 3x after release
power up (on U-Boot / Universal Boot Loader)	can restore defaults from there)	<b>MENU</b> key (3 seconds)	
	Switch slots A / B	<b>4</b> key + <b>6</b> key (3 seconds)	Green
	Loader	<b>1</b> key + <b>3</b> key (3 seconds)	Blue / Yellow
	Switch Skype for Business to Android (and vice versa)	Back key + <b>OK</b> key (3 seconds)	Red + Green
	Restore defaults	<b>OK</b> key + <b>MENU</b> key (3 seconds)	Green + blue / Green + yellow
When successfully booted (on Android)	Reboot	From the 'Admin' menu	-
	Restore defaults	Long-press <b>Hold</b> key for ~15 seconds	-

## Removing Devices from Intune Management

You can remove from Intune devices that are no longer needed, that are being repurposed, or that have gone missing.

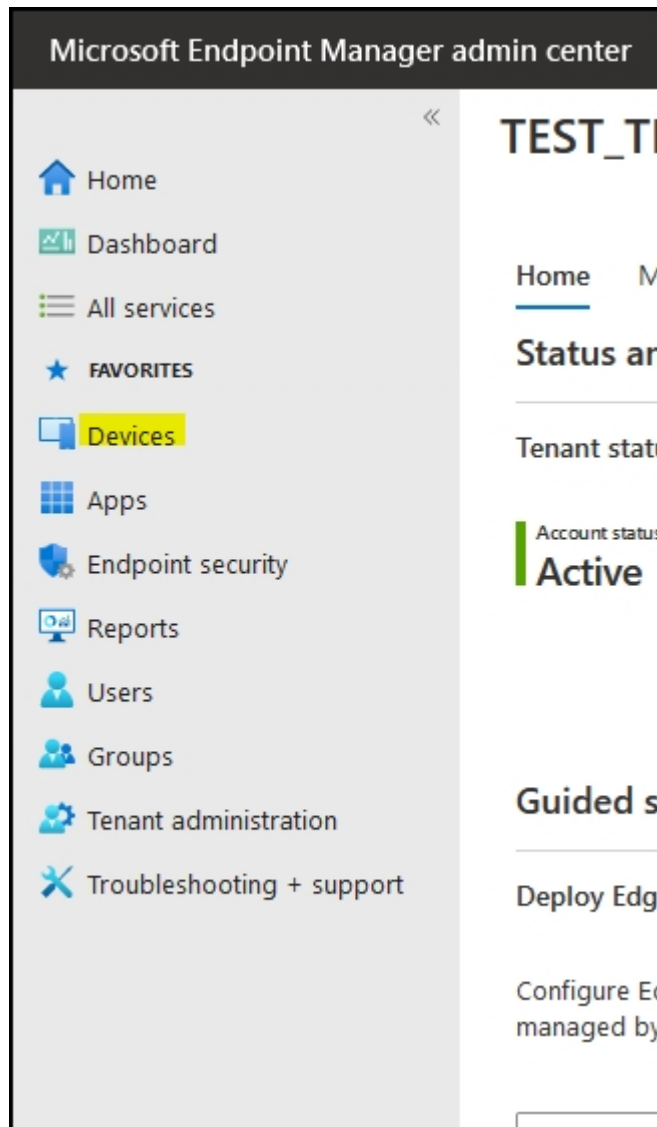
### ➤ To remove devices from Intune:

1. Go to Microsoft 365 Admin Centre [portal.office.com] and log in with an Administration account.
2. Navigate to **Endpoint Manager**.

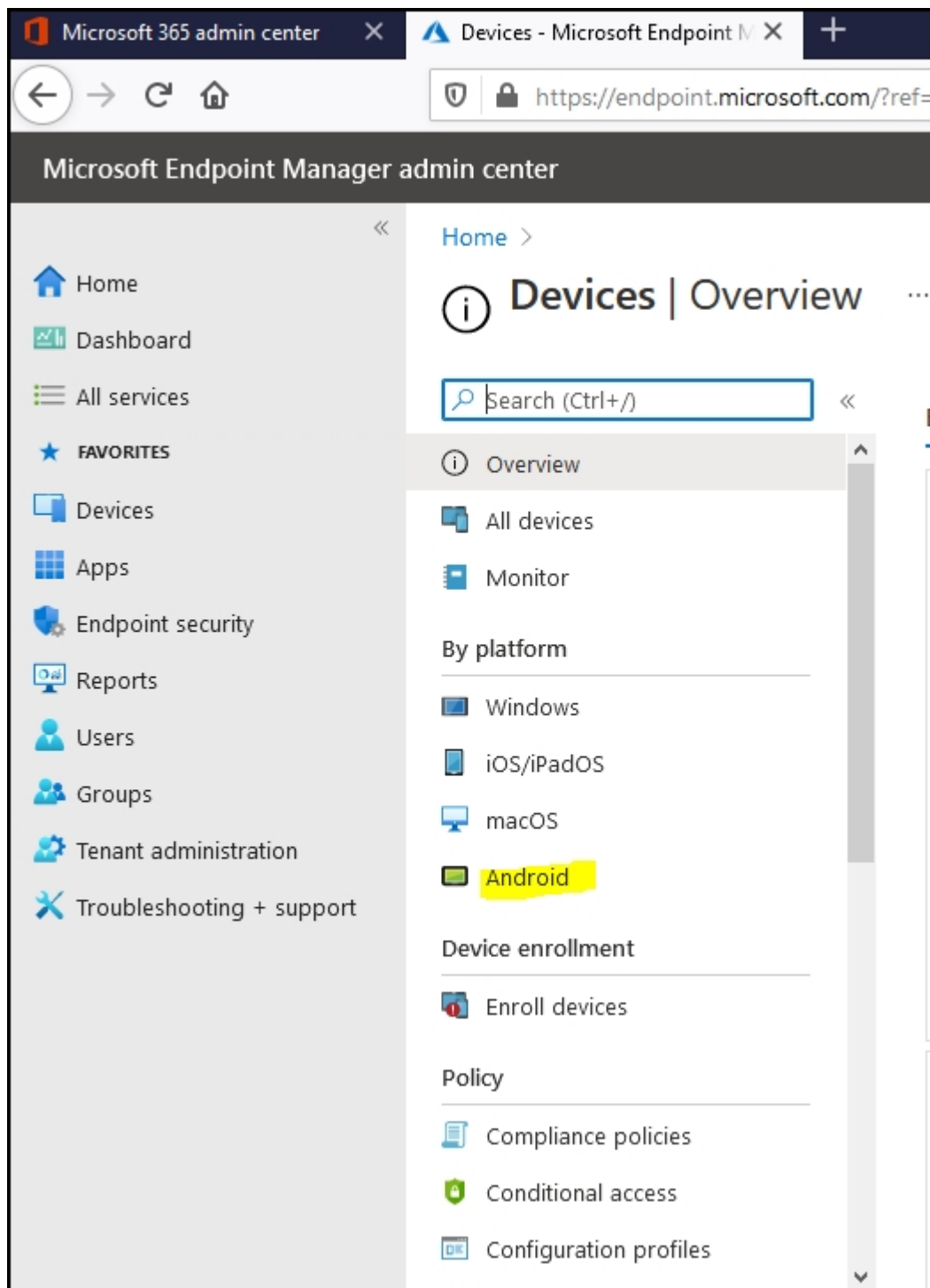


The Endpoint Manager service is licensed according to individual terms. Consequently, not all network administrators will be able to navigate to it. Check if the license you're using includes the service or not.

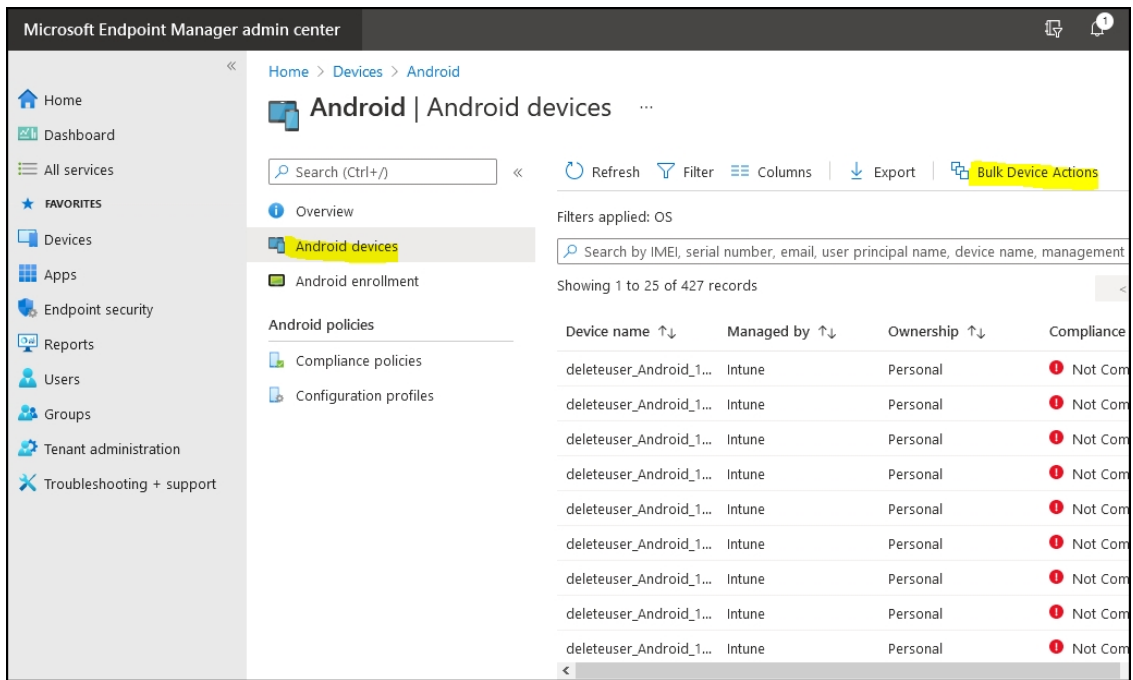
3. Click **Devices**.



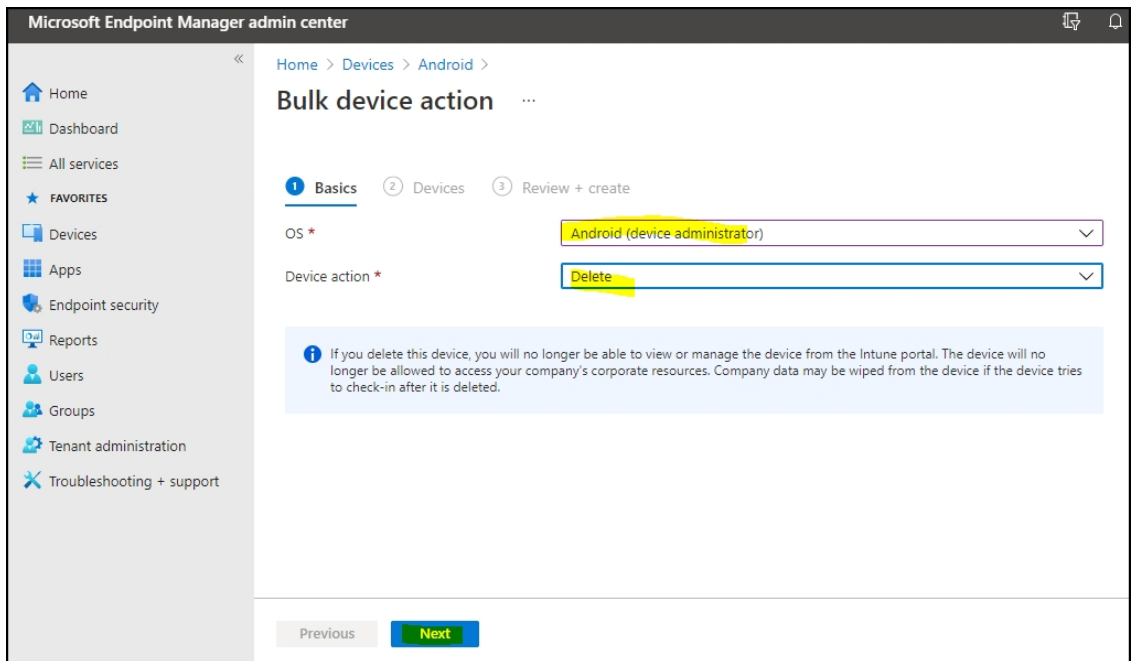
4. Click **Android**.



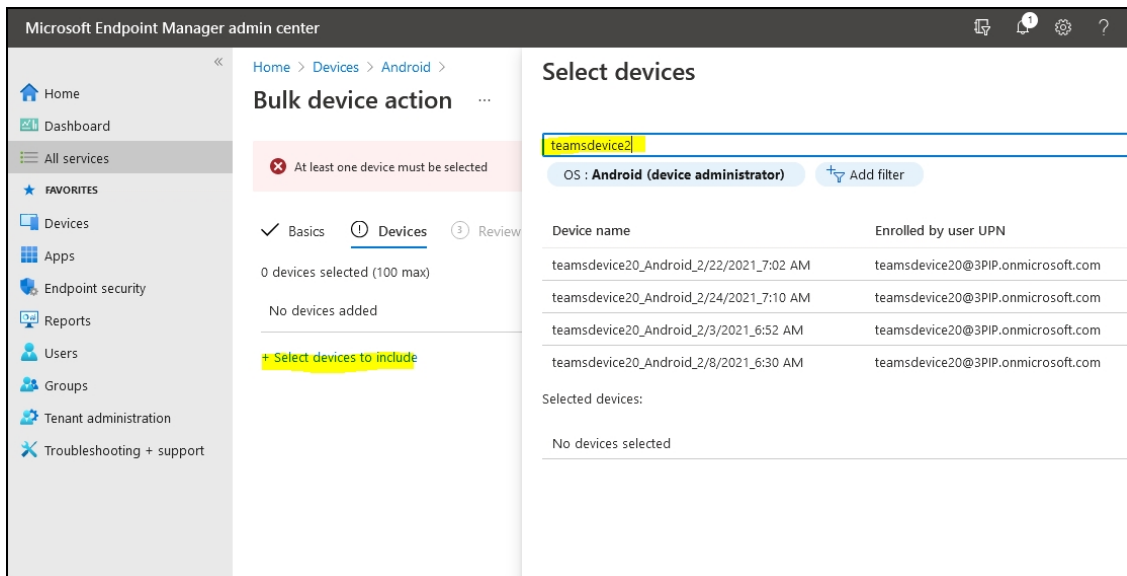
5. Click **Android Devices > Bulk Device Actions**.



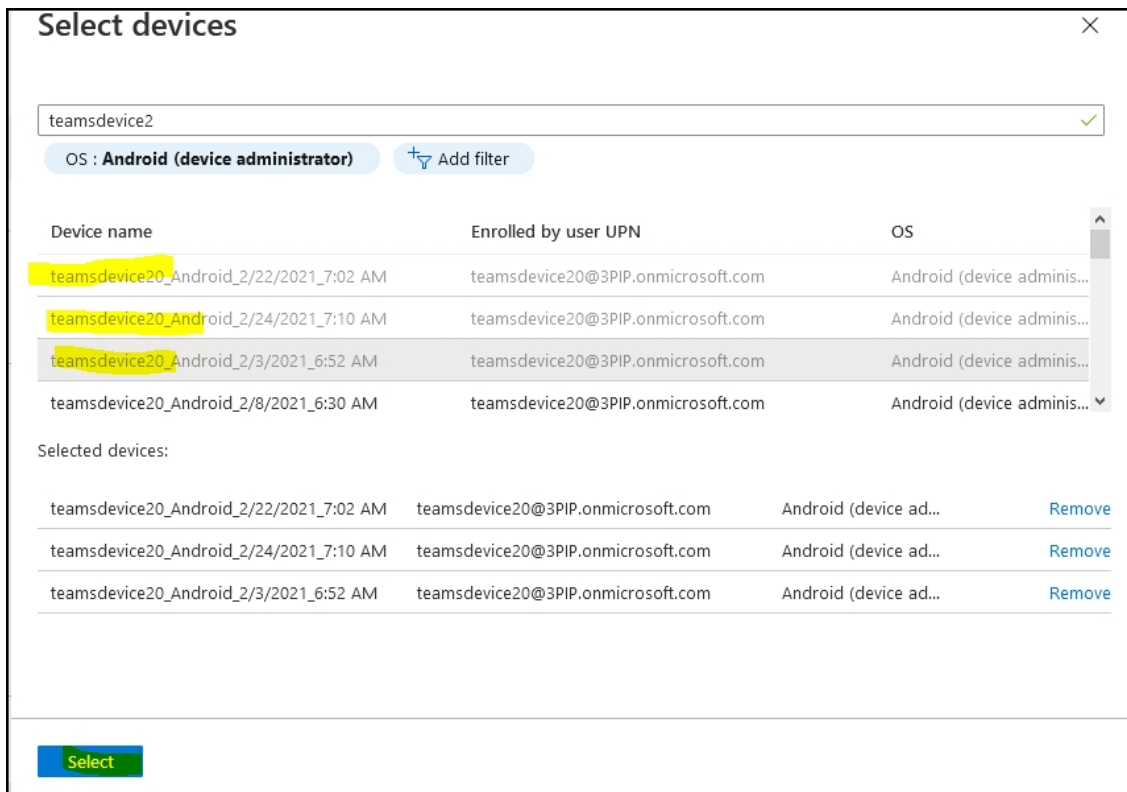
6. Select: **OS > Android (Device Administrator) Device Action > Delete** and then **Next**.



7. Select **Devices to include** and search for the user for which enrolled devices are to be removed.



8. Select all the devices to be removed and click **Select icon**.



9. After the devices are selected, click **Next**.

Microsoft Endpoint Manager admin center

Home > Devices > Android >

## Bulk device action

✓ Basics   **2** Devices   ③ Review + create

9 devices selected (100 max)

Device name	Enrolled by use
teamsdevice20_Android_2/22/2021...	teamsdevice20@
teamsdevice20_Android_2/24/2021...	teamsdevice20@
teamsdevice20_Android_2/3/2021_...	teamsdevice20@
teamsdevice20_Android_2/8/2021_...	teamsdevice20@
teamsdevice20_Android_8/17/2020...	teamsdevice20@
teamsdevice20_Android_9/15/2020...	teamsdevice20@
teamsdevice20_Android_9/15/2020...	teamsdevice20@
teamsdevice20_Android_9/22/2020...	teamsdevice20@
teamsdevice21_Android_2/2/2021_...	teamsdevice21@

Previous   **Next**

10. Click **Create**; a task to delete all the selected devices enrolled with a particular account is created.

Microsoft Endpoint Manager admin center

Home > Devices > Android >

## Bulk device action

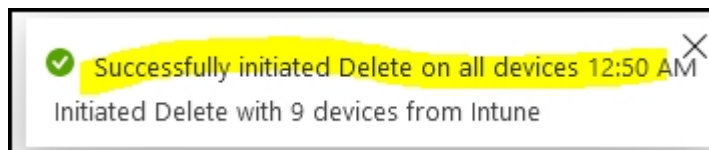
Devices

9 devices selected (100 max)

Device name	Enrolled by us
teamsdevice20_Android_2/22/2021_7:0...	teamsdevice20
teamsdevice20_Android_2/24/2021_7:1...	teamsdevice20
teamsdevice20_Android_2/3/2021_6:52 ...	teamsdevice20
teamsdevice20_Android_2/8/2021_6:30 ...	teamsdevice20
teamsdevice20_Android_8/17/2020_1:5...	teamsdevice20
teamsdevice20_Android_9/15/2020_9:0...	teamsdevice20
teamsdevice20_Android_9/15/2020_9:0...	teamsdevice20
teamsdevice20_Android_9/22/2020_5:4...	teamsdevice20
teamsdevice21_Android_2/2/2021_10:5...	teamsdevice21

Previous **Create**

11. Once the action is created, the admin receives notification.



It may take some time to completely sync the devices with the account so after deleting the devices wait for 30 minutes before signing in.

## Configuring Audio-Related Parameters for Noisy Environments

Network administrators can configure audio-related parameters to support the phone in special environments (such as noisy environments). To use the capability, contact AudioCodes Support.



## Updating Microsoft Teams Devices Remotely

For instructions on how to update Microsoft Teams devices remotely, see [here](#).

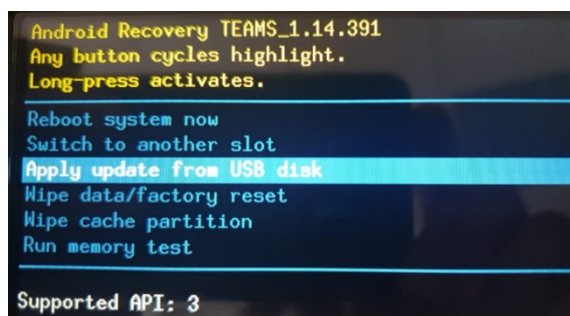
## Applying Firmware to a Phone from a USB Disk

For recovery purposes, firmware can be applied to a phone from a USB disk.

### ➤ To apply the firmware from the USB disk:

1. Enter recovery mode by simultaneously pressing the 'back' key + the MENU key; the device's LED lights up red.
2. Insert the USB disk with the target firmware.

Figure 6-1: Apply update from a USB disk



3. Select the 'Apply update from USB disk' option and then choose the correct firmware image from the disk.

## Managing Phones with the Device Manager

AudioCodes' Device Manager manages Android-based Teams phones in a similar way to UC-type phones. Teams phones' configuration parameters are in the same format as UC phones. A .cfg configuration file is defined for each device. Device Manager version 7.8.2000 and later supports Android-based Teams devices.

Zero Touch Provisioning is supported in a non-tenant aware manner; each local DHCP Option 160 must be configured with a fully-specified URL pointing to **dhcption160.cfg** as shown here:

Table 6-1: DHCP Option 160 URL

DHCP Options Configuration	
DHCP option 160 URL ('dhcption160.cfg')	
SYSTEM URLS	
OVOC accesses phones directly:	<a href="https://ppdm.audiocodes.com/firmwarefiles/pp/dhcption160.cfg">https://ppdm.audiocodes.com/firmwarefiles/pp/dhcption160.cfg</a>
OVOC accesses phones via SBC HTTP Proxy:	<a href="https://SBC_PROXY_IP:SBC_PROXY_PORT/firmwarefiles/pp/httpproxy/">https://SBC_PROXY_IP:SBC_PROXY_PORT/firmwarefiles/pp/httpproxy/</a>
<a href="#">Edit Dhcption160.Cfg Template</a>	<a href="#">Download Dhcption160.Cfg Template</a> <a href="#">Upload Dhcption160.Cfg Template</a>
<a href="#">Generate 'Dhcption160.Cfg'</a>	
Advanced: DHCP Option 160 With Tenant Configuration	

This URL is displayed in the Device Manager page under **Setup > DHCP Options Configuration**. After devices are added to the Device Manager, they're allocated to tenants by selecting **Change Tenant** in the 'Actions' menu. Unless already used, it's recommended to leave the default tenant as a 'lobby' for the new devices. The above URL can also be configured in AudioCodes' Redirect Server. Android-based Teams devices currently support:

- Provisioning of configuration
- Provisioning of firmware
- Switching to UC / Teams
- Monitoring (based on periodic Keep-Alive messages sent from devices)
- Resetting the device

The Device Manager's 'internal' functions (which don't involve devices) are:

- Change tenant
- Change template
- Show info
- Generate Configuration
- Delete device status
- Nickname

Actions that go beyond the devices' periodic provisioning cycle will be supported in next releases. The **Check Status** option is irrelevant for Android-based Teams devices therefore it's omitted from the 'Actions' menu.



- To change a device's configuration, see the *Device Manager Administrator's Manual*. Changing a device's configuration using the Device Manager is the same for Android-based Teams devices as for UC devices.
- To commit a change made at the template/tenant/site/group/user level, perform **Generate Configuration**. The change can be validated in the device's .cfg file. The Android-based endpoint pulls the updated configuration when the next periodic provisioning cycle occurs.

## Configuring a Periodic Provisioning Cycle

Network administrators can configure how often periodic provisioning cycles will occur, to suit enterprise management preference.

### ➤ To configure how often periodic provisioning cycles will occur:

- Use the following table as reference.

**Table 6-2: Periodic Provisioning Cycle**

Parameter	Description
provisioning/period/type	<p>Defines the frequency of the periodic provisioning cycle. Valid values are:</p> <ul style="list-style-type: none"> <li>■ HOURLY</li> <li>■ DAILY (default)</li> <li>■ WEEKLY</li> <li>■ POWERUP</li> <li>■ EVERY5MIN</li> <li>■ EVERY15MIN</li> </ul> <p>Each value type is accompanied by additional parameters (see <a href="#">Supported Parameters</a> on the next page) that further defines the selected frequency.</p>

## Configuring TimeZone and Daylight Savings

Network administrators can configure TimeZone and Daylight Savings to suit enterprise requirements.



AudioCodes' Teams phones feature a **Automatic Time Zone Detection** mechanism that allows the device to automatically detect the time zone via geographical location. If time zone is not configured, this feature is implemented.

### ➤ To configure TimeZone and Daylight Savings:

- Use the following table as reference.

**Table 6-3: TimeZone And Daylight Savings**

Parameter	Description
date_time/- timezone	<p>Defines the Timezone. Valid values are:</p> <ul style="list-style-type: none"> <li>■ +00:00</li> <li>■ +01:00</li> <li>■ +02:00</li> <li>■ Etc.</li> </ul>
date_time/time_ dst	[Boolean parameter]. Configuring <b>ENABLED</b> adds one hour to the configured time. Valid values are:

Parameter	Description
	<ul style="list-style-type: none"> <li>■ 1</li> <li>■ 0</li> </ul>

For example, to configure Central European Summer Time (CEST) you can either configure:

date\_time/timezone=+01:00

date\_time/time\_dst=1

-OR-

date\_time/timezone=+02:00

date\_time/time\_dst=0

## Managing Devices with HTTPS

Android-based Teams devices support an HTTPS connection.

### ➤ To establish an HTTPS connection:

- The server certificate must be signed by a well-known Certificate Authority

-OR-

- A root/intermediate CA certificate must be loaded to the device's trust store either via 802.1x or configuration parameter '/security/ca\_certificate/[0-4]/uri'

### ➤ To maintain backward compatibility with devices previously running UC versions:

- Configure parameter '/security/SSLCertificateErrorsMode' to **Ignore**

## Supported Parameters

Listed here are the configuration file parameters currently supported by Android-based Teams devices. They're in AudioCodes' UC version format. The parameters are comprised of Microsoft configuration profile settings and AudioCodes' device-specific parameters.

- general/silent\_mode = 0 (default)/1
- general/power\_saving = 0 (default)/1
- phone\_lock/enabled = 0 (default)/1
- phone\_lock/timeout = 900 (default) (in units of seconds)
- phone\_lock/lock\_pin = 123456
- display/language = English (default)
- display/screensaver\_enabled = 0/1
- display/screensaver\_timeout = 1800 (seconds)

- display/backlight = 80 (0-100)
- display/high\_contrast = 0 (default) /1
- date\_time/timezone = +02:00
- date\_time/time\_dst = 0 (default) /1
- date\_time/time\_format = 12 (default) / 24
- network/dhcp\_enabled = 0/1
- network/ip\_address =
- network/subnet\_mask =
- network/default\_gateway =
- network/primary\_dns =
- network/pecondary\_dns =
- network/pc\_port = 0/1
- office\_hours/start = 08:00
- office\_hours/end = 17:00
- logging/enabled = 0/1
- logging/levels = VERBOSE, DEBUG, INFO, WARN, ERROR, ASSERT, SILENT
- admin/default\_password = 1234
- admin/ssh\_enabled=0/1 (default)
- security/SSLCertificateErrorsMode = IGNORE, NOTIFICATION, DISALLOW (default)
- security/ca\_certificate/[0-4]/uri – uri to download costumer's root-ca
- provisioning/period/daily/time
- provisioning/period/hourly/hours\_interval
- provisioning/period/type = HOURLY, DAILY (default), WEEKLY, POWERUP, EVERY5MIN, EVERY15MIN
- provisioning/period/weekly/day
- provisioning/period/weekly/time
- provisioning/random\_provisioning\_time

# 7 Troubleshooting

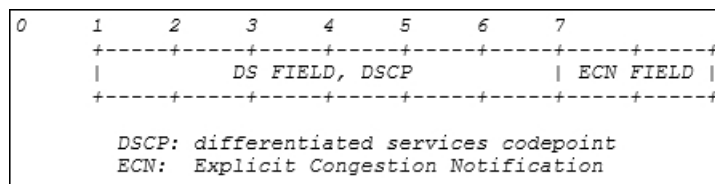
The information presented here shows how to troubleshoot AudioCodes devices.

## DSCP

The phone's Teams application supports DS (Differentiated Services) containing a differentiated Services Code Point (DSCP) value and an ECN (Explicit Congestion Notification) value, for monitoring Quality of Service (QoS).

DSCP is part of the IP header that defines the type of routing service to tag outgoing voice packets originated from the phone. It informs routers that this packet must receive a specific QoS. Values can be set in decimal (e.g., 184) or hexadecimal (e.g., 0xb8). The default value is **0xb8** (184).

**Figure 7-1: DS Field, DSCP**



The DSCP value for audio is **0x46**.

See also [Microsoft's website](#) for more information.



The DSCP value can be adjusted *on the server*; it cannot be adjusted on the client. See the figures below for recommended values.

**Figure 7-2: Recommended Values**

*Table 1. Recommended initial port ranges*

Media traffic type	Client source port range	Protocol	DSCP value	DSCP class
Audio	50,000–50,019	TCP/UDP	46	Expedited Forwarding (EF)
Video	50,020–50,039	TCP/UDP	34	Assured Forwarding (AF41)
Application/Screen Sharing	50,040–50,059	TCP/UDP	18	Assured Forwarding (AF21)

Figure 7-3: Audio

```

2057 47.390455 192.168.2.104 172.17.178.203 UDP 84 50006 → 50012 Len=42
2058 47.390541 192.168.2.104 172.17.178.203 UDP 228 50006 → 50012 Len=186
2059 47.393899 192.168.2.104 172.17.178.203 UDP 151 50006 → 50012 Len=109
2060 47.395193 172.17.178.203 192.168.2.104 UDP 114 50012 → 50006 Len=72
2061 47.395209 172.17.178.203 192.168.2.104 UDP 114 50012 → 50006 Len=72
<
> Frame 2057: 84 bytes on wire (672 bits), 84 bytes captured (672 bits) on interface \Device\NPF_{296D2E63-3934-488A-8FAB-666A48797EE2}, id 0
> Ethernet II, Src: AudioCod_9c:1a:38 (00:90:8f:9c:1a:38), Dst: VMware_ff:63:15 (00:0c:29:ff:63:15)
> Internet Protocol Version 4, Src: 192.168.2.104, Dst: 172.17.178.203
  0100 .... = Version: 4
  .... 0101 = Header Length: 20 bytes (5)
  > Differentiated Services Field: 0xb8 (DSCP: EF PHB, ECN: Not-ECT)
    1011 10.. = Differentiated Services Codepoint: Expedited Forwarding (46)
      .... ..00 = Explicit Congestion Notification: Not ECN-Capable Transport (0)
  Total Length: 70
  Identification: 0xd3ba (54202)
  > Flags: 0x4000, Don't fragment
  Fragment offset: 0
  Time to live: 64
  Protocol: UDP (17)
  Header checksum: 0x4447 [validation disabled]
  [Header checksum status: Unverified]
  Source: 192.168.2.104
  Destination: 172.17.178.203
> User Datagram Protocol, Src Port: 50006, Dst Port: 50012
    
```

## Users

Read the following if an issue with your phone occurs. Contact your network administrator if necessary. Network administrators can also use this documentation as reference.

Table 7-1: Troubleshooting

Symptom	Problem	Corrective Procedure
Phone is off (no screen displays and LEDs)	Phone is not receiving power	<ul style="list-style-type: none"> <li>■ Make sure the AC/DC power adapter is attached firmly to the DC input on the rear of the phone.</li> <li>■ Make sure the AC/DC power adapter is plugged into the electrical outlet.</li> <li>■ Make sure the electrical outlet is functional.</li> <li>■ If using Power over Ethernet (PoE), contact your network administrator to check that the switch is powering the phone.</li> </ul>
Phone is not ringing	Ring volume is set too low	<ul style="list-style-type: none"> <li>■ Increase the volume (see <a href="#">Adjusting Ring Volume</a> on page 72)</li> </ul>
Screen display is poor	Screen settings	<ul style="list-style-type: none"> <li>■ Adjust the phone's screen brightness</li> </ul>
Headset has no audio	Headset not connected properly	<ul style="list-style-type: none"> <li>■ Make sure your headset is securely plugged into the headset port located on the side of the phone.</li> <li>■ Make sure the headset volume level is adjusted adequately (see <a href="#">Adjusting Headset Volume</a> on page 72).</li> </ul>

## Network Administrators

Network administrators can troubleshoot telephony issues in their IP networks using the following as reference.

### Android Phone Utility

AudioCodes' IP phone is by default accessed via Secure Shell (SSH) cryptographic network protocol after the network administrator signs in.



SSH is by default disabled and can be enabled with Administrator permissions in the phone screen (**Device Administration > Debugging > SSH**).

AudioCodes provides network administrators with an SSH-based Android Phone Utility.

➤ **To sign in to the utility:**

- Enter your username and password; **admin** and **1234** are the defaults.

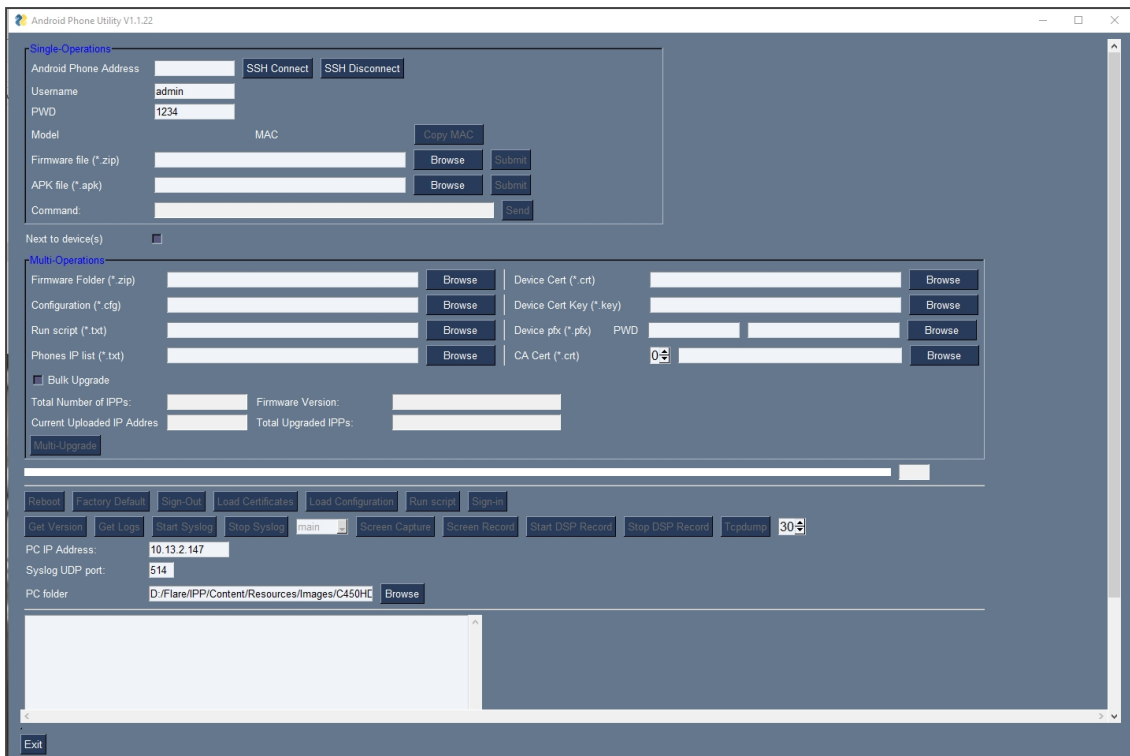
The application gives network administrators the following debugging capabilities:

- [Capturing the Phone Screen](#) on page 107
- [Running Tcpdump](#) on page 107
- [Getting Information about Phones](#) on page 108
- [Remote Logging \(Syslog\)](#) on page 110
- [Getting Diagnostics](#) on page 111
- Getting a Bug Report
- [Activating DSP Recording](#) on page 113
- [Deactivating DSP Recording](#) on page 114
- [Getting Information about Phones](#) on page 108

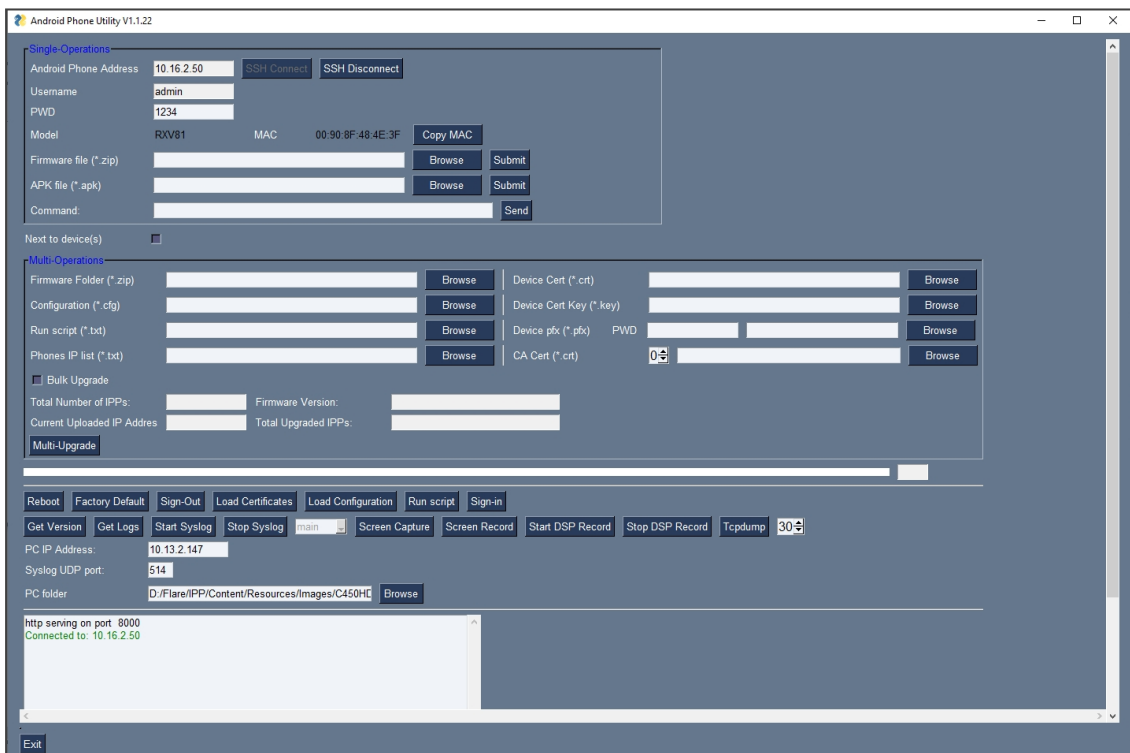
➤ **To open the utility:**

1. From the PC's **Start** menu, select the app icon or click the application's exe file in the folder in which you saved it.





2. In the 'Android Phone Address' field, enter the IP address of the device (get it by pressing the MENU hard key > **About phone** > **Status** > **IP Address**).
3. Click **SSH Connect**; a connection with the device is established.



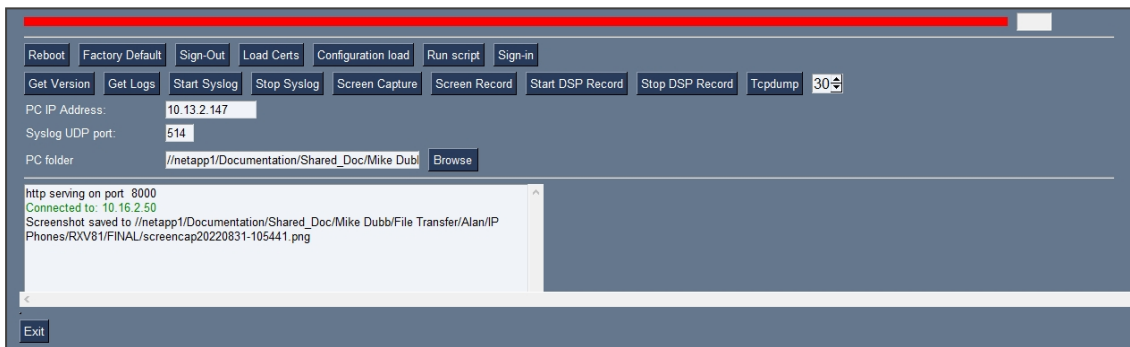
4. Next to the field 'PC folder', click the **Browse** button and navigate to and select the folder to which to send data to use for debugging.

## Capturing the Phone Screen

AudioCodes' Android Phone Utility allows network administrators to effectively collaborate and debug issues using the screen-capturing feature.

### ➤ To capture the phone screen:

1. Open the Android Phone Utility: From the PC's **Start** menu, select the app icon or click the application's exe file in the folder in which you saved it.
2. In the 'Android Phone Address' field, enter the IP address of the device (get it by pressing the MENU hard key > **About phone** > **Status** > **IP Address**).
3. Click **SSH Connect**; a connection with the device is established.
4. Next to the field 'PC folder', click the **Browse** button and navigate to and select the folder to which to send the screen captures.
5. Click the **Screen Capture** button; the phone's screen is captured and the screenshot is saved and sent to the folder.



6. On your PC, navigate to the folder and retrieve the screenshot. Default file name: **screencap.png**. Rename it to a name related to the screen you captured. If you don't rename it, it will be overwritten the next time you take a screenshot.

## Running Tcpcdump

Tcpcdump is a common packet analyzer that allows network administrators to display TCP/IP and other packets transmitted or received over the IP telephony network, for debugging purposes.

### ➤ To run Tcpcdump:

1. In the Android Phone Utility (see [Android Phone Utility](#) on page 105 for more information about the application), enter the phone's IP address, click **SSH Connect** and browse to a folder on the PC to which to send the information.
2. Next to the **Tcpcdump** button, set the time period or leave it at the default. Default: **30** seconds.
3. Click the **Tcpcdump** button and then after the progress indicator reaches the end you'll view in the results pane a 'Finished' indication.



4. Open the folder on the PC to which you commanded the application to send the information and locate and open the file 'net.pcap'.

Alternatively, run Tcpcdump *without* the utility.

➤ **To run tcpcdump without the utility:**

1. Access the phone via SSH and run the following commands:

```
setprop ac.ac_tcpdump.timeout <seconds>
```

2. After defining the capturing time as shown in the preceding command, start the capture:

```
setprop ac.ac_tcpdump 1
```

3. Tcpcdump capture file will appear in this location:

```
/sdcard/recording/net.pcap
```

4. After running Tcpcdump, reproduce the issue.
5. Execute the following command from your PC command prompt (cmd):

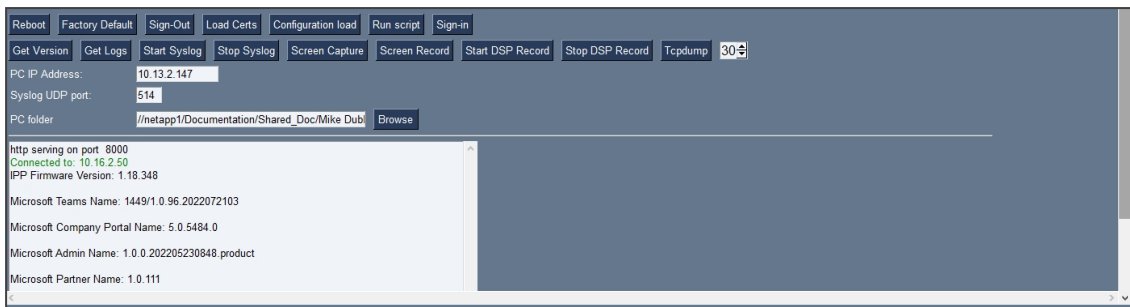
```
scp -r admin@%deviceIp%:/sdcard/recording/ %FolderOnPc%
```

## Getting Information about Phones

Network administrators can get information about phones using AudioCodes' SSH protocol based Android Phone Utility.

➤ **To get information about the phone:**

1. Open the Android Phone Utility (see [Android Phone Utility](#) on page 105 for more information about the application), enter the phone's IP address, click the adjacent **SSH Connect** button and browse to a folder on the PC to which to send the information.
2. Click the **Get Version** button.



3. View the information in the pane.

4. Alternatively:

- To get *firmware information*, in the 'Command' field enter the following and then click **Send**:

```
getprop ro.build.id
```

- To get *Bootloader information* using SSH protocol, in the utility's 'Command' field enter the following and then click **Send**:

```
getprop ro.bootloader
```

- To get *DSP information* using SSH protocol, in the utility's 'Command' field enter the following and then click **Send**:

```
getprop ro.ac.dsp_version
```

- To get the *Microsoft Teams version* using SSH protocol, in the utility's 'Command' field enter the following and then click **Send**:

```
getprop ro.teams.version
```

- To get the *Microsoft Company Portal version* using SSH protocol, in the utility's 'Command' field enter the following and then click **Send**:

```
getprop ro.portal.version
```

- To get the *Microsoft Admin version* using SSH protocol, in the utility's 'Command' field enter the following and then click **Send**:

```
getprop ro.agent.version
```

## Remote Logging (Syslog)

Remote Logging via Syslog provides the same log level as Device Diagnostics (performed via the Microsoft Admin Center) with some additional information that may be relevant to device issues (not Teams application issues). Device Diagnostics via the Microsoft Admin Center are saved to the device sdcard and collected after the event. When performing Remote Logging via Syslog, the logs are collected in real time.

Remote Logging via Syslog can be enabled from the

- [Android Phone Utility](#) on page 105
- below

### ➤ To enable Remote Logging via Syslog from the Android Phone Utility:

1. In the Android Phone Utility (see [Android Phone Utility](#) on page 105 for more information), enter the phone's IP address, click **SSH Connect** and browse to a folder on the PC to which to send the information.
2. In the 'PC IP Address' field, enter the IP address of the PC on which the utility is installed and then click the **Start Syslog** button.



3. Open the folder on the PC to which you commanded the application to send the information, and then locate the Syslog file.
4. To view Syslog, you can optionally download the Syslog Viewer available in AudioCodes' website.

ccaudiocodes		AudioCodes Utilities				
Utility Name	Latest Version	Windows	MacOS	Linux	Other	Win32
Syslog Viewer	1.28	Download	Download	Download		Download
INI Viewer & Editor	1.13	Download	Download	Download		
SBC Configuration Wizard	2.28	Download				
-- Templates Pack (*)	2.55				Download	
Configuration Builder	1.1	Download				
Stack Manager	2.7.1			Download		
PII Log Scrubber	1.5	Download	Download	Download		Download

Notes:  
(\*) Templates Pack is part of the SBC Configuration Wizard. Latest version of the Template Pack is automatically downloaded during Wizard startup, therefore there is typically no need to download it manually.

### ➤ To enable Remote Logging via Syslog from the phone:

1. Log in to the phone as Administrator and go back.
2. In the 'Device administration' screen, select **Debugging**.

### 3. Select **Remote logging**.



4. Configure the 'Remote IP address' and 'Remote port' and enable 'Remote Logging'; the device starts sending logs to the Syslog server.



Network administrators can also enable Syslog using Secure Shell (SSH) protocol.

- **To enable Syslog using SSH protocol, type the following command at the shell prompt:**

```
setprop persist.ac.rl_address <syslog_server_ip>:<port>.
```

- **To disable Syslog using SSH, type the following command at the shell prompt:**

```
setprop persist.ac.rl_address ""
```

### Getting Diagnostics

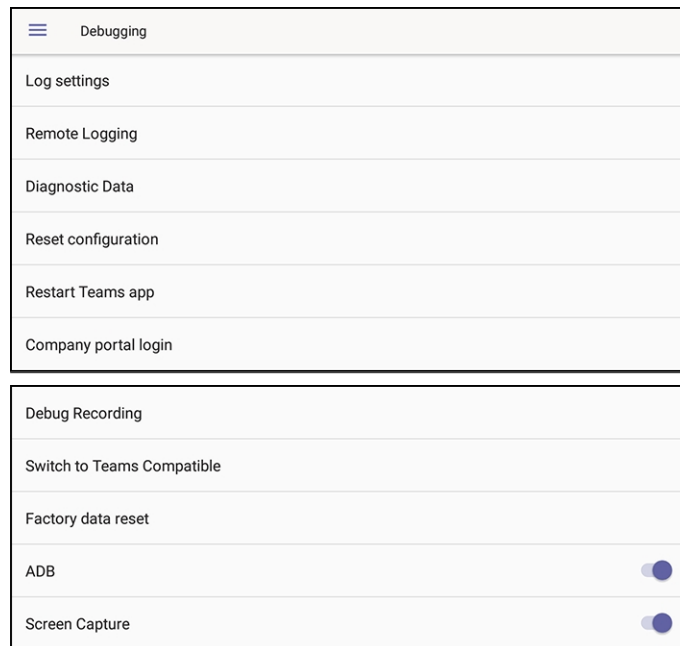
Network administrators can get diagnostics to facilitate debugging.



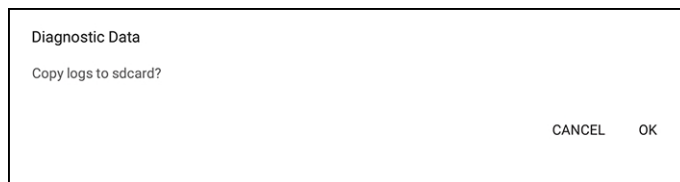
Network administrators who need to get diagnostics from the device can dump the logs to the phone's Secure Digital (SD) Card and then later collect them using Secure Copy Protocol (SCP) based on Secure Shell (SSH) protocol. Whenever an issue occurs, the administrator can dump the logs into the SD Card.

- **To get diagnostics:**

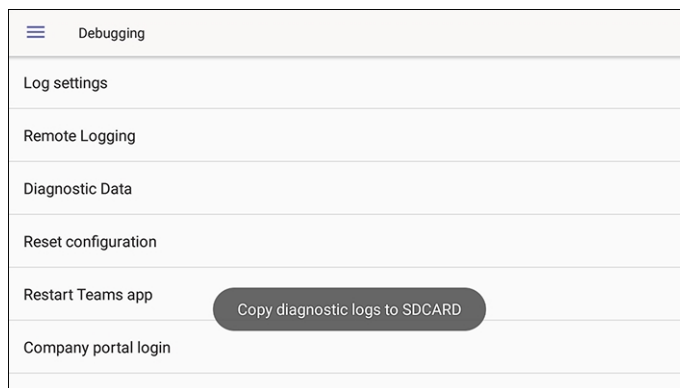
1. Log in to the phone as an Admin user
2. Open the Debugging screen (**Device Administration > Debugging**).



3. Select the **Diagnostic Data** option.



4. Select **OK** to confirm.



5. Wait until the screen shown in the preceding figure disappears; the phone creates all necessary logs and copies them to the its SD Card / Logs folder.
6. Get the logs using SCP notation as follows:

```
scp -r admin@host_IP:/sdcard/logs/ .
```

- Following are the relevant logs (version and ID may be different to those shown here):

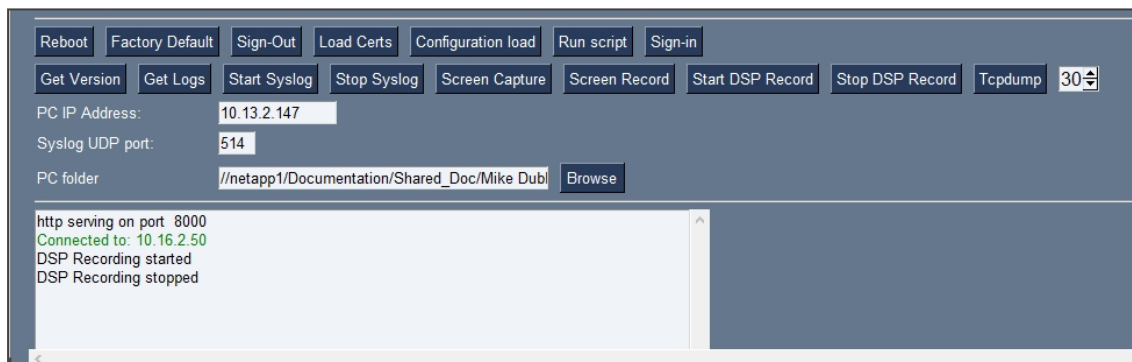
- ✓ dmesg.log
- ✓ upstate-TEAMS\_1.3.16-undated.txt
- ✓ dumpstate\_log-undated-2569.txt
- ✓ logcat.log

### Activating DSP Recording

Network administrators can activate DSP recording using AudioCodes' SSH protocol based Android Phone Utility.

#### ➤ To activate DSP Recording:

1. In the AudioCodes Android Phone Utility (see [Android Phone Utility](#) on page 105 for more information about the application), enter the phone's IP address, click **SSH Connect** and then click the **Browse** button next to the field 'PC folder' to configure a folder on the PC to which to send the information.
2. In the 'PC IP Address' field, enter the IP address of the PC on which the utility is installed and then click the **Start DSP Record** button.
3. After a period of recording, click **Stop DSP Record**.



4. View the DSP recording in the PC folder you configured.



Network administrators can alternatively activate a DSP recording using SSH protocol *without* the Android Phone Utility, as shown next.

#### ➤ To activate DSP recording using SSH protocol *without* the utility, type the following at the shell prompt:

```
setprop ac.dr_voice_enable true
setprop ac.dr_ipaddr <ip_address>
setprop ac.dr_port 50000
```





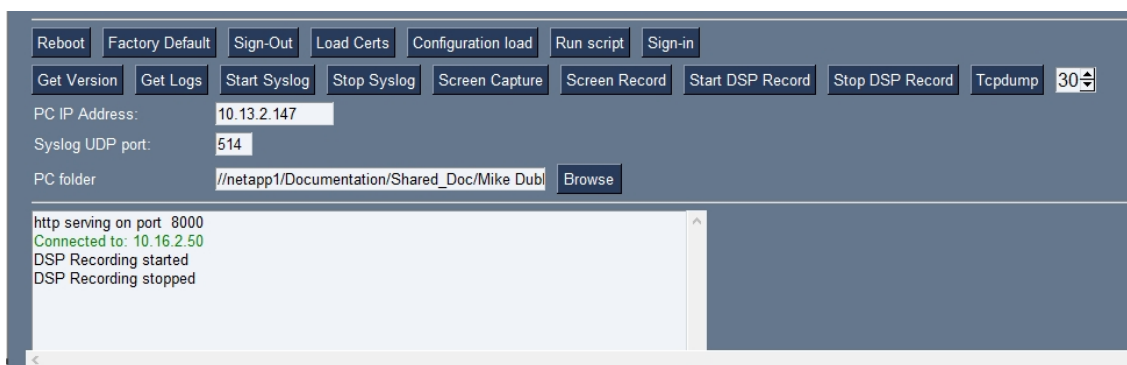
DSP recording can be activated on the fly without requiring the network administrator to reset the phone.

## Deactivating DSP Recording

Network administrators can deactivate DSP recording using AudioCodes' SSH protocol based Android Phone Utility.

### ➤ To deactivate DSP Recording:

1. In the utility (see [Android Phone Utility](#) on page 105 for more information about the application), click **Stop DSP Record** after a period of recording (see [Activating DSP Recording](#) on the previous page for information on how to start DSP recording).



2. View the DSP recording in the PC folder you configured when [Activating DSP Recording](#) on the previous page.



Network administrators can alternatively deactivate a DSP recording using SSH protocol *without* the Android Phone Utility, as shown next.

### ➤ To deactivate DSP recording using SSH protocol *without* the utility, type the following at the shell prompt:

```
setprop ac.dr_voice_enable false
```



DSP recording can be deactivated on the fly without requiring the network administrator to reset the phone.

## SSH

The phone can be accessed via Secure Shell (SSH) cryptographic network protocol after the network administrator signs in.



SSH is by default disabled and can be enabled with Administrator permissions in the phone screen (Device Administration > Debugging > SSH).

To sign in, the administrator needs to know their username and password; **admin** and **1234** are the defaults. SSH access allows administrators debugging capabilities such as:

- [Getting the Phone IP Address](#) below
- Pulling files from the phone sdcard (using the curl command)
- [Activating DSP Recording](#) on page 113
- [Deactivating DSP Recording](#) on the previous page
- [Installing the APK using SSH](#) below

### Getting the Phone IP Address

Network administrators can get a phone's IP address using SSH protocol.

- **To get the phone's IP address using SSH protocol, type the following at the shell prompt:**

```
ifconfig
```

### Installing the APK using SSH

Network administrators can install the Team Android Application Package using SSH protocol.

### Updating Phones using SSH Commands

- **To upgrade firmware:**

1. Download the required firmware version to **sdcard/update\_image.zip**.

For example, use the following:

```
SCP <file name> admin@<DeviceIP>:/sdcard/update_image.zip
```

2. Update the firmware using the following:

```
setprop ctl.start local_update
```

3. Track progress using the following:

```
logcat | grep update_engine_client_android
```

➤ **To upgrade the Android Package Kit (APK):**

1. Download the required APK to `sdcard/teams.apk`

For example use the following:

```
SCP <file name> admin@<DeviceIP>:/sdcard/teams.apk
```

2. Update the APK using the following:

```
pm install -r -g /sdcard/<filename>
```

3. Delete the old APK using the following:

```
pm uninstall com.microsoft.skype.teams.iphone
```



If the new APK is older than the existing one, delete the existing APK before installing the new one.

➤ **To collect logs:**

1. Collect logs using the following:

```
command/bugreport 1
```

2. Wait until the logs are created (see in `/sdcard/logs/bugreports/` that there is a `.gz` file)
3. Get the logs from the `"/sdcard/logs/bugreports/"` folder.

For example, use the following:

```
SCP admin@<DeviceIP>:/sdcard/logs/bugreports/<log file name>  
C:\<destination Directory>
```

➤ **To install the Client Certificate:**

1. Download certificates to `/sdcard/devcert/`
2. Install the certificate using the following:

```
setprop ctl.start sdcard_certs_install.
```

## Microsoft Teams Admin Center

The Microsoft Teams Admin Center allows network administrators to troubleshoot issues encountered with the phone.

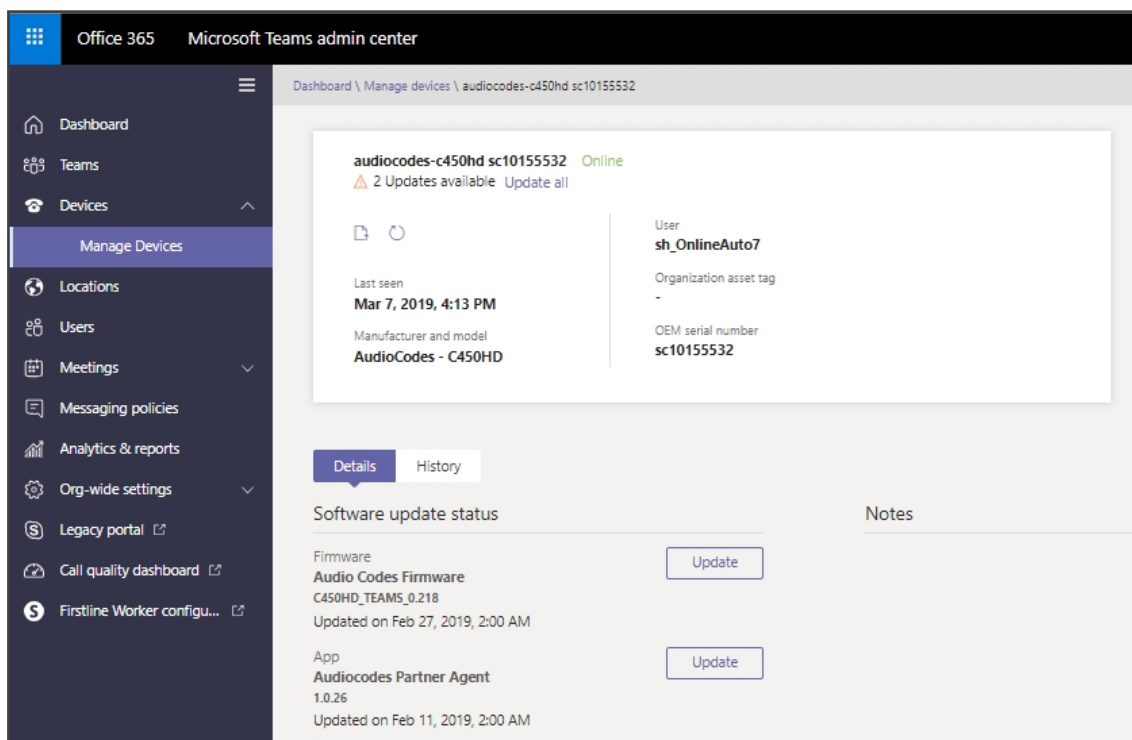
## Collecting Logs

Network administrators can download *all logs* from the Microsoft Teams admin center. Logs that administrators can download include device diagnostics (Logcat), dumpsys, ANRs, Client Log, Call Policies File, Call Log Info File, Sky lib Log Files, Media Log Files, and CP. The logs can help debug Teams application issues and also for issues related to the device.


### ➤ To collect logs:

1. Reproduce the issue.
2. Access Microsoft Admin Center and under the **Devices** tab click the **Diagnostics** icon.

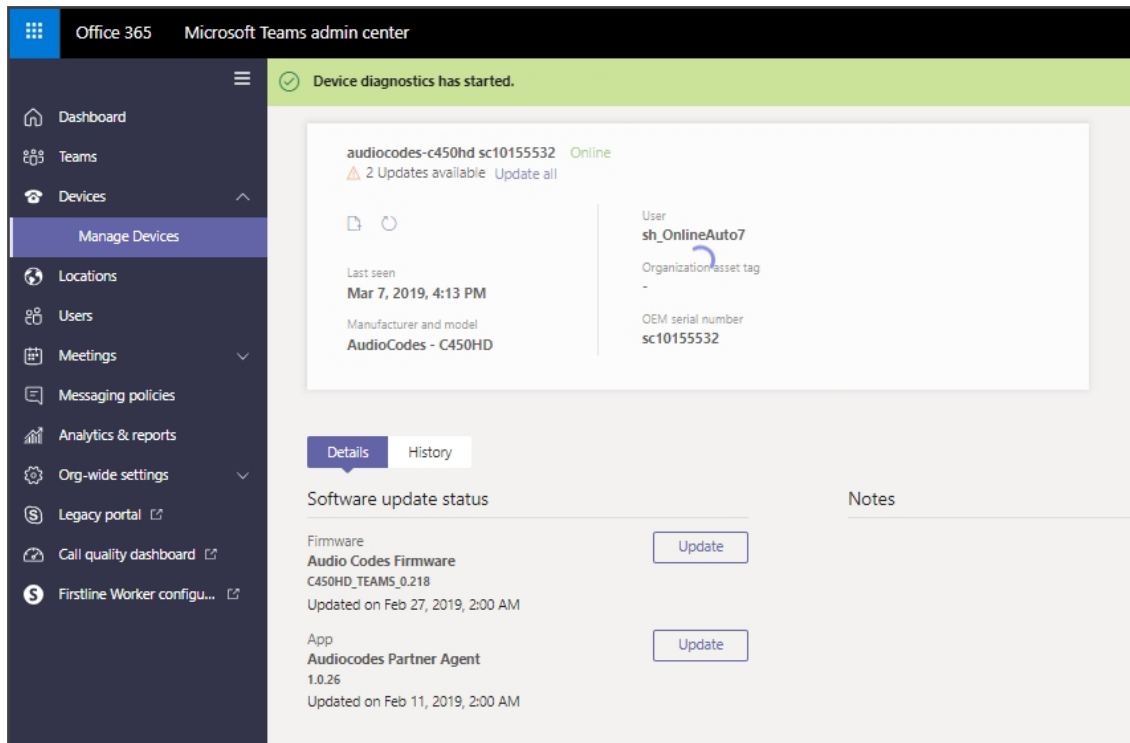
**Figure 7-4: Microsoft Teams Admin Center - Diagnostics**



Applies to all AudioCodes phones for Microsoft Teams even though a specific model is shown in the figures here.

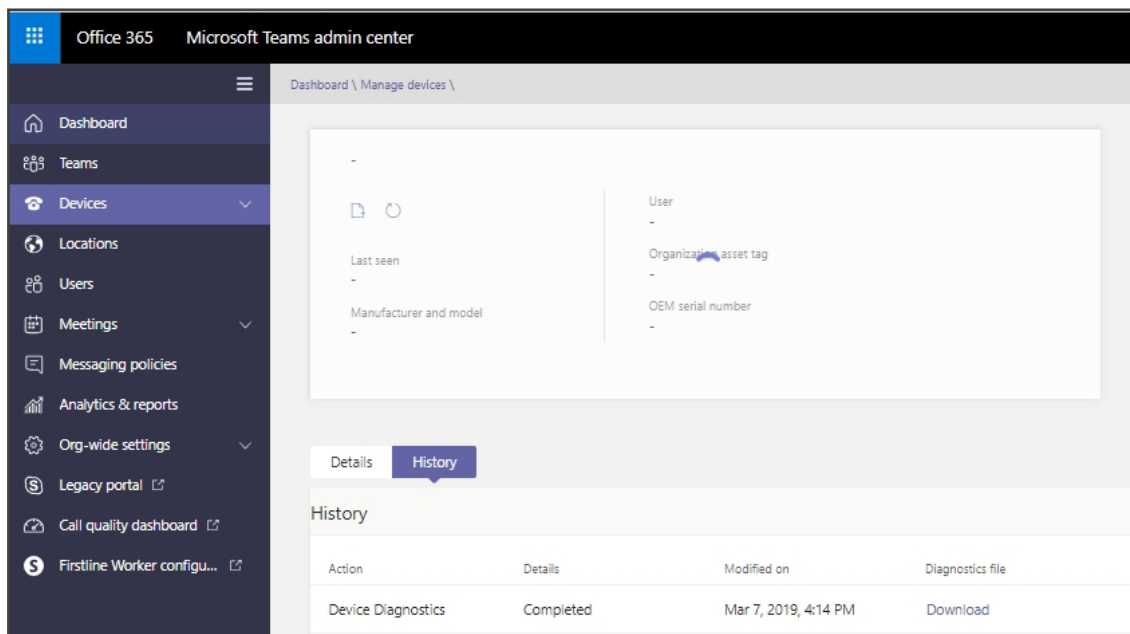
3. Click the **Diagnostics** icon  and in the 'Device diagnostics' prompt that pops up, click **Proceed**; log files are retrieved from the devices and uploaded to the server.

**Figure 7-5: Microsoft Teams Admin Center – Logs Upload to Server**



4. Click the **History** tab.

**Figure 7-6: History - Download**



Click **Download** to download the logs.



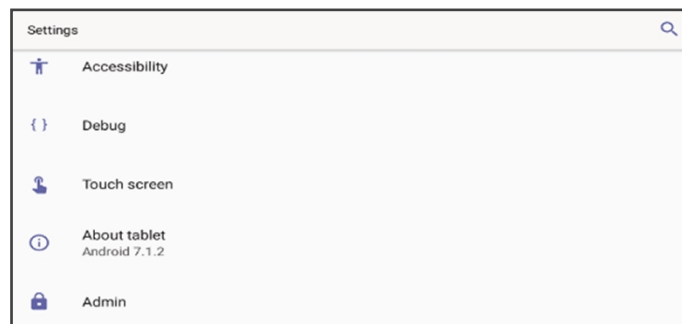
- AudioCodes Device Manager's 'Collect Logs' action also includes all information collected by Microsoft Teams admin center (TAC). The .zip file includes the following files:
  - ✓ Android BugReport
  - ✓ AdminAgentLogs.zip - includes logcat collected by the OVOC/Device Manager.
  - ✓ blog files (media logs)
  - ✓ Skylib-XXX.blog
  - ✓ app\_process32.XXX.blog
  - ✓ config.cfg & status.cfg - Device configuration and status
  - ✓ ac\_config.xml and ac\_status.xml - Device configuration and status for internal use.
  - ✓ dmesg - Diagnostic messages command useful for debugging hardware-related issues.
  - ✓ SessionID\_For\_Company\_Portal\_Logs.txt (this is the CP SSDI, not the logs; the logs are sent to the OVOC / Device Manager server).
- See also the *Device Manager Administrator's Manual*.

## Getting Audio Debug Recording Logs

Network administrators can opt to get Audio Debug Recording logs from the phone screen. The purpose of these logs is for issues related to media.

### ➤ To enable Audio Debug Recording logs:

1. Log in as Administrator.
2. Open the Settings screen and scroll down to **Debug**.



3. Select **Debug** and then scroll down to **Debug Recording**.



4. Configure the remote IP address and port.

5. Enable 'Voice record'.
6. Start Wireshark on your PC to capture the Audio traffic.

## Collecting Media Logs (\*.blog) from the Phone

Network administrators can collect Media Logs (\*.blog) from the phone.

### ➤ To collect Media Logs (\*.blog) from the phone

1. Access the phone via SSH.



SSH is by default disabled and can be enabled with Administrator permissions in the phone screen (Device Administration > Debugging > SSH).

2. Set the phone to the screen to capture.
3. Run the following command:

```
scp -r admin@hosp_  
ip:/sdcard/android/data/com.microsoft.skype.teams.ipphone/cache/ .
```

## Capturing Traffic Using 'rpcapd'

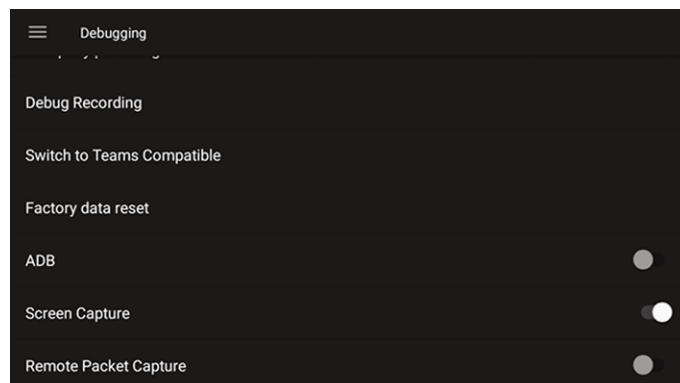
The 'rpcapd' (Remote Packet Capture) network sniffer application allows the network administrator to analyze and debug Android traffic on their desktop PC using the app's integral SSH server.



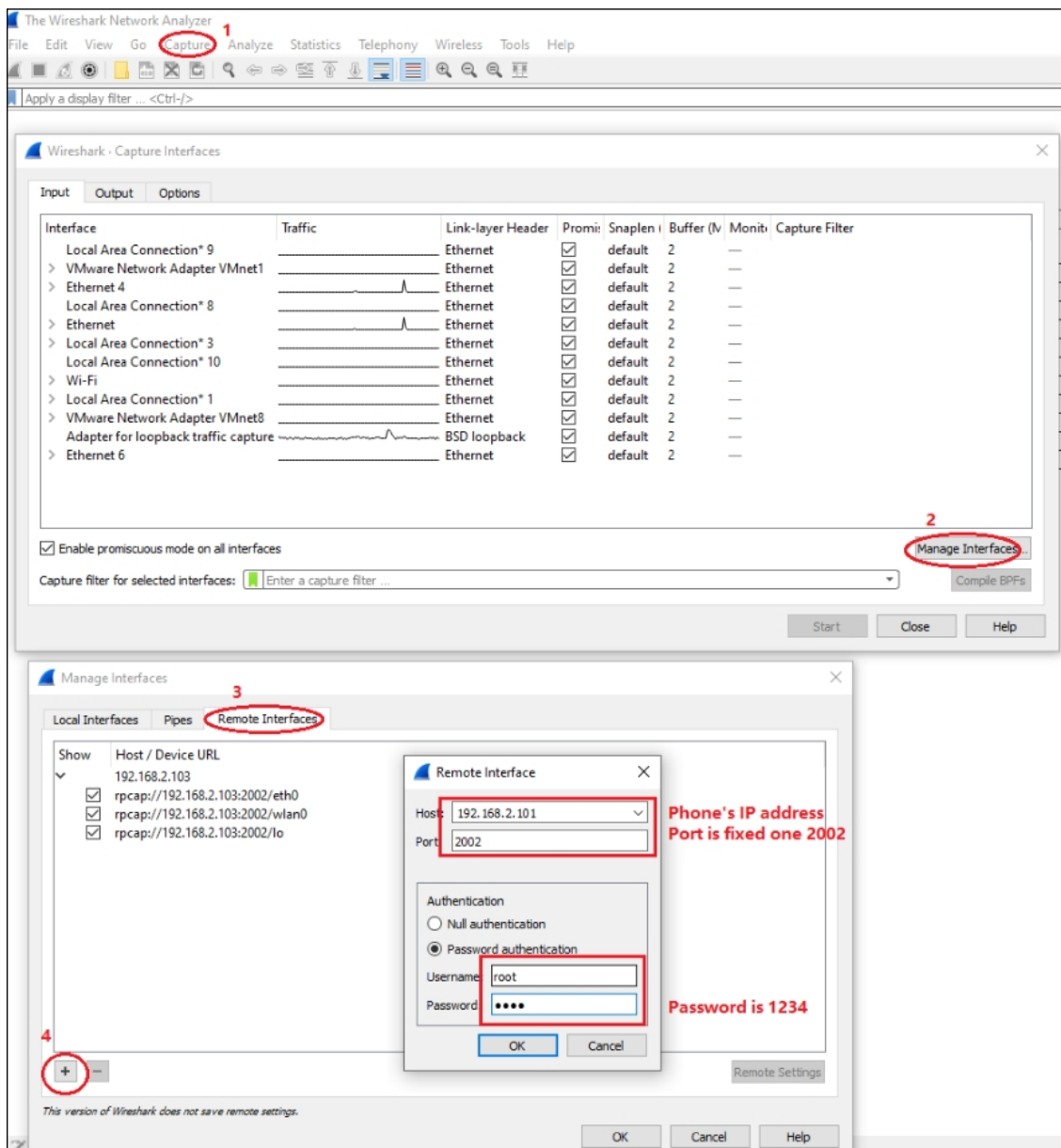
SSH is by default disabled and can be enabled with Administrator permissions in the phone screen (Device Administration > Debugging > SSH).

### ➤ To capture traffic using 'rpcapd':

1. Open the phone's Debugging screen and switch **Remote Packet Capture** on.



2. After 'rpcapd' is enabled on the phone, use Wireshark to connect with it. Follow **the steps below** to connect to the phone.



- View all the interfaces on the phone and choose your preferred interface with which to capture packets.

### Port Mirroring Network Monitoring

The phone supports the port mirroring network monitoring technique of copying and sending network packets transmitted as input from a phone port, to another port of a monitoring device for enhanced analysis and debugging capability.

➤ **To enable the feature:**

- Open the phone's 'Modify network' screen (**Settings > Device admin settings > Modify network**) and select parameter 'Enable PC Port Mirror' to enable it if it isn't already enabled.



**This page is intentionally left blank.**

### **International Headquarters**

1 Hayarden Street,

Airport City

Lod 7019900, Israel

Tel: +972-3-976-4000

Fax: +972-3-976-4040

### **AudioCodes Inc.**

80 Kingsbridge Rd

Piscataway, NJ 08854, USA

Tel: +1-732-469-0880

Fax: +1-732-469-2298

**Contact us:** <https://www.audiocodes.com/corporate/offices-worldwide>

**Website:** <https://www.audiocodes.com/>

**Documentation Feedback:** <https://online.audiocodes.com/documentation-feedback>

©2022 AudioCodes Ltd.. All rights reserved. AudioCodes, AC, HD VoIP, HD VoIP Sounds Better, IPmedia, Mediant, MediaPack, What's Inside Matters, OSN, SmartTAP, User Management Pack, VMAS, VoIPerfect, VoIPerfectHD, Your Gateway To VoIP, 3GX, VocaNom, AudioCodes One Voice, AudioCodes Meeting Insights, and AudioCodes Room Experience are trademarks or registered trademarks of AudioCodes Limited. All other products or trademarks are property of their respective owners. Product specifications are subject to change without notice.

Document #: LTRT-13315

