EC935X

La Specialista

PRESTIGIO

MACCHINA DA CAFFÈ

COFFEE MAKER

MACHINE À CAFÉ

KAFFEEMASCHINE

KOFFIEZETAPPARAAT

CAFETERA

MÁQUINA DE CAFÉ

ΜΗΧΑΝΗ ΓΙΑ ΚΑΦΕ

KAFFEMASKIN

KAFFEMASKIN

KAFFEMASKINE

KAHVINKEITIN

ΚΟΦΕΜΑШИΝΑ

ΚΟΦΕ ЖАСАҒЫШ

KÁVÉFŐZŐGÉP

KÁVOVAR

KÁVOVAR

EKSPRES DO KAWY

APARAT DE PREPARAT CAFEA

ماكينة قهوة



DeLonghi

IT

pag. 6

EN

page 19

FR

pag. 32

DE

S. 45

NL

pag. 60

ES

pág. 74

PT

pág. 87

EL

σελ 101

NO

sid. 116

SV

sid. 129

DA

sid. 142

FI

siv. 155

RU

стр.168

KZ

181-бет

HU

old. 217

CS

str. 231

SK

str. 245

PL

str. 259

RO

pag. 273

AR

2

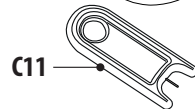
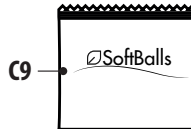
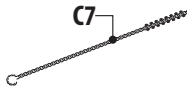
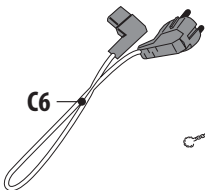
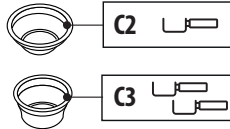
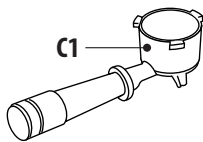
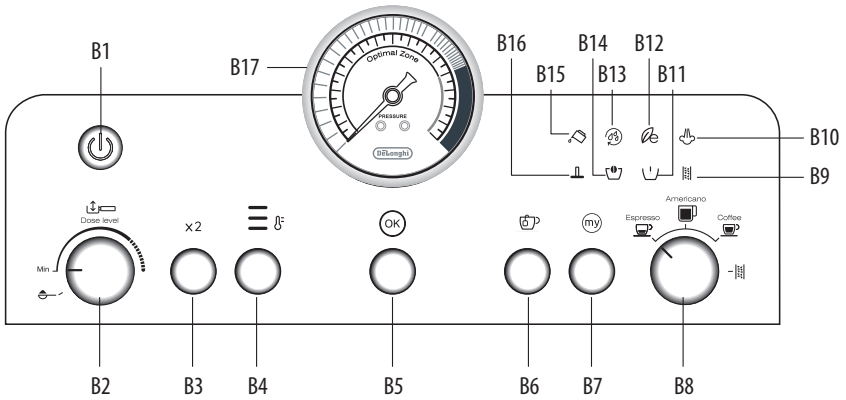

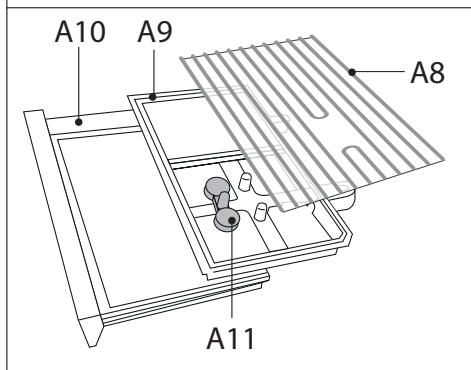
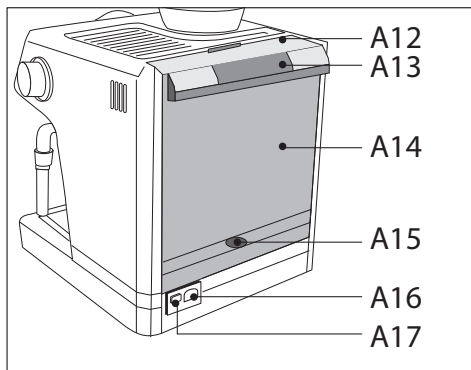
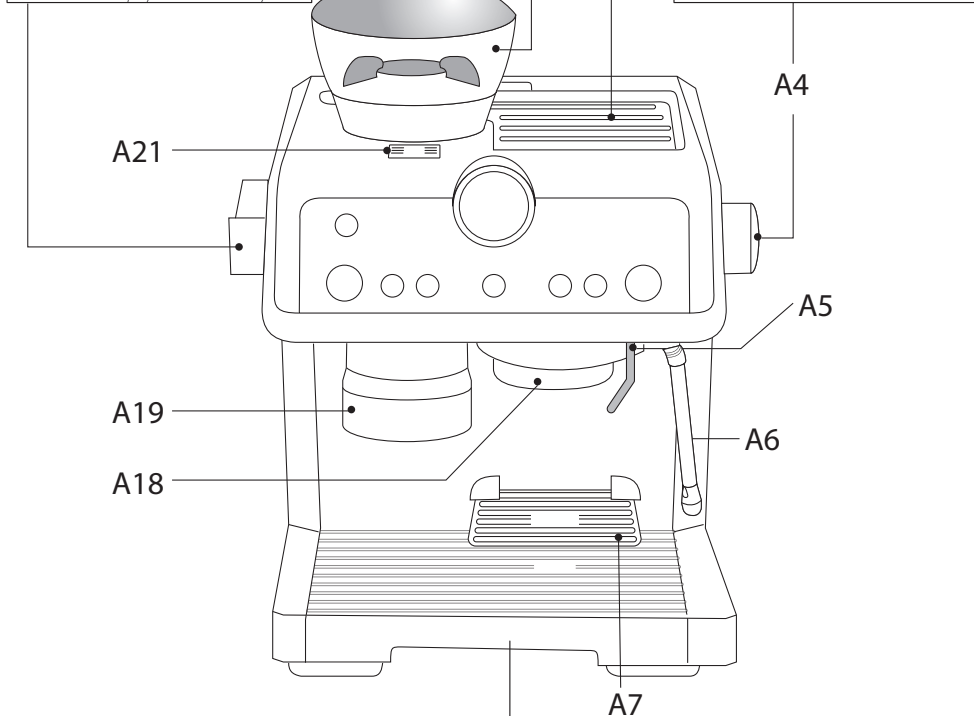
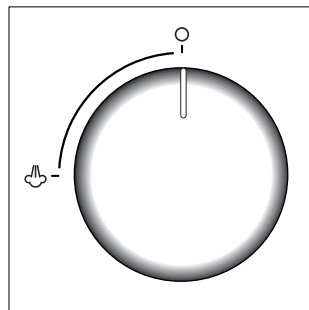
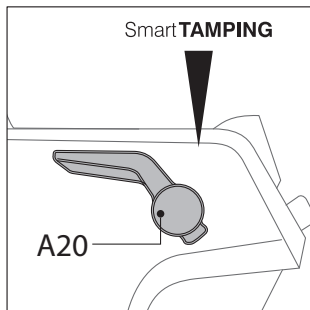

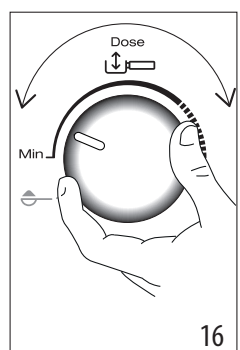
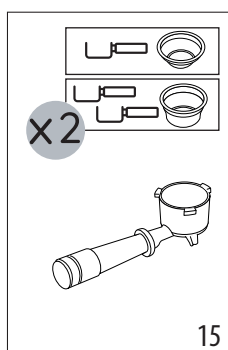
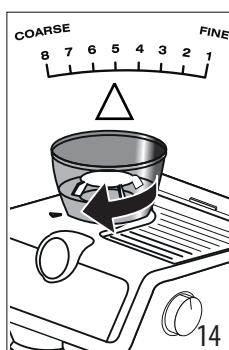
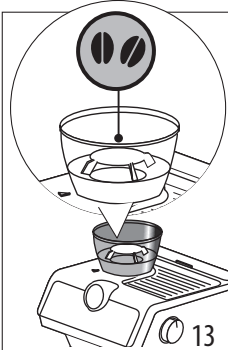
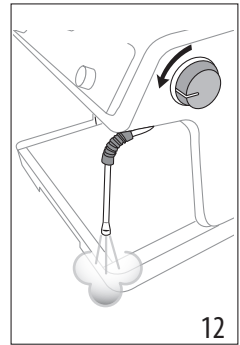
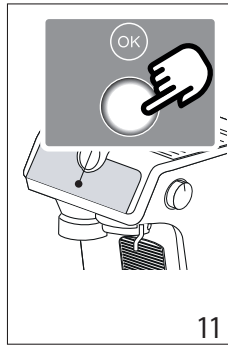
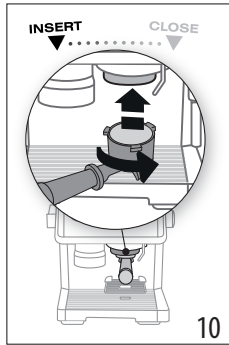
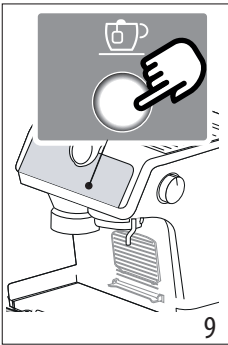
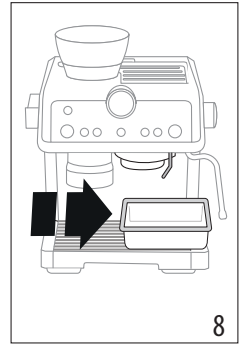
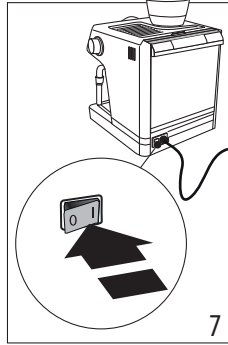
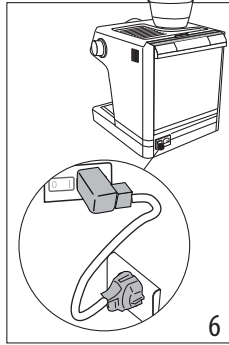
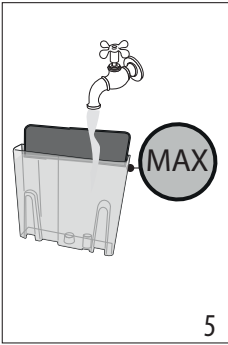
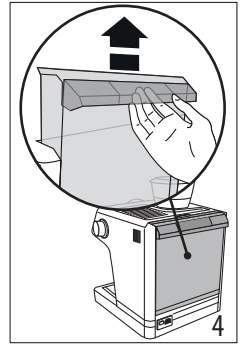
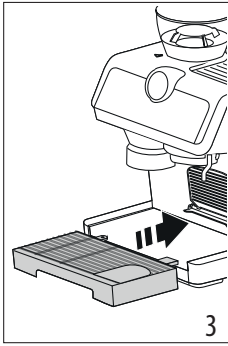
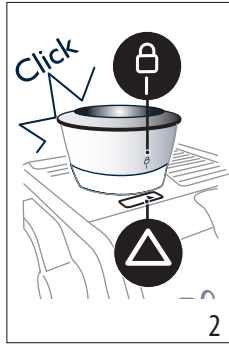
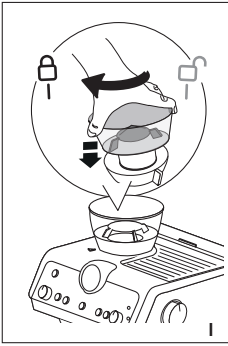

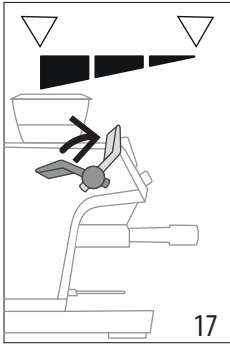

17

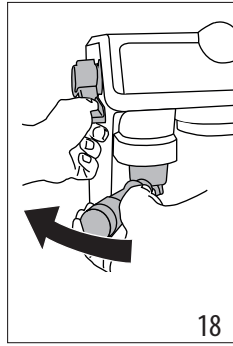

18

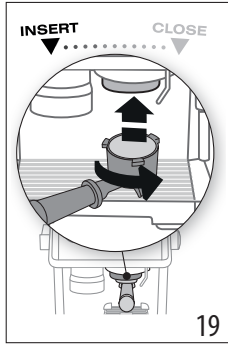

19

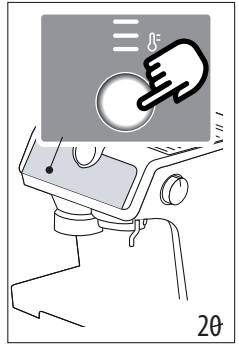

20

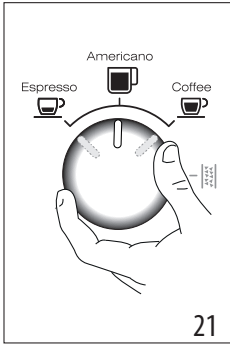

21

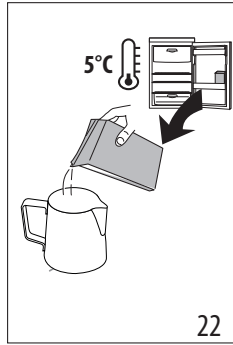

22

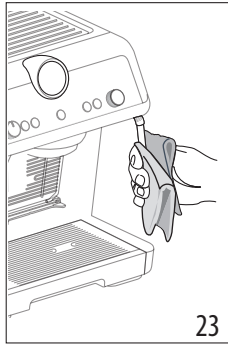

23

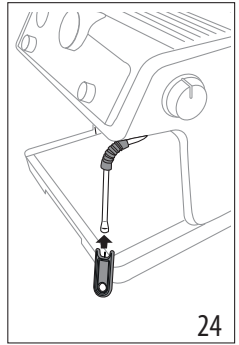

24

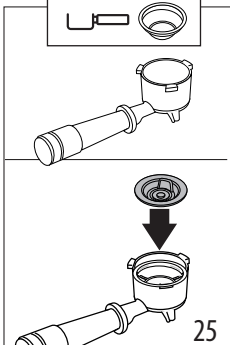

25

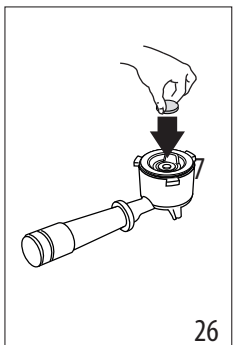

26

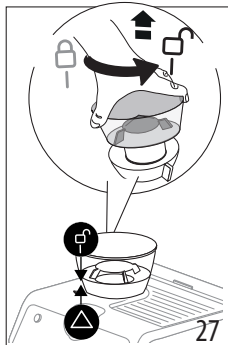

27

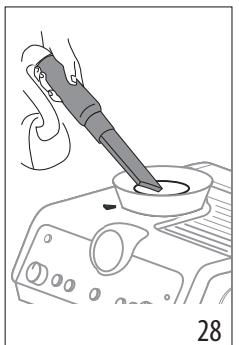

28

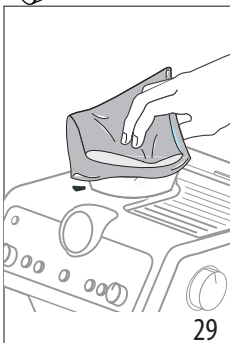

29

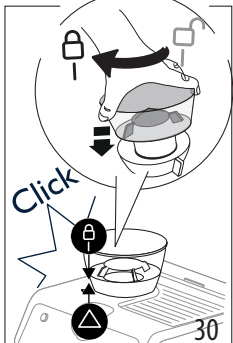

30

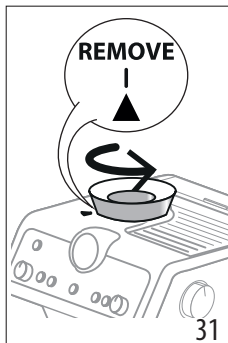

31

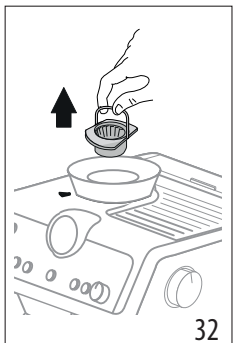

32

Prima di utilizzare l'apparecchio leggere sempre il fascicolo delle avvertenze di sicurezza.

1. DESCRIZIONE

1.1 Descrizione dell'apparecchio - A

- A1. Coperchio contenitore chicchi
- A2. Contenitore chicchi
- A3. Poggiatazze
- A4. Manopola vapore
- A5. Erogatore acqua calda
- A6. Tubo erogatore vapore
- A7. Griglia poggiatezze per espresso
- A8. Griglia poggiatezze per bicchieri o mug
- A9. Griglia vaschetta
- A10. Vaschetta raccogliocce
- A11. Indicatore di livello acqua nella vaschetta raccogliocce
- A12. Coperchio serbatoio acqua
- A13. Maniglia estrazione serbatoio acqua
- A14. Serbatoio acqua
- A15. Sede filtro addolcitore
- A16. Sede connettore cavo alimentazione
- A17. Interruttore generale (ON/OFF)
- A18. Erogatore caffè
- A19. Uscita macinacaffè (Tamping station)
- A20. Leva pressino
- A21. Sportellino per accedere allo scivolo del macinacaffè

1.2 Descrizione pannello di controllo - B

- B1. Tasto ON/Standby
- B2. Manopola regolazione quantità caffè macinato
- B3. Tasto "X2": per utilizzare il filtro 2 caffè
- B4. Tasto "temperatura caffè"
- B5. Tasto "OK": per erogare la bevanda/per confermare
- B6. Tasto "erogazione acqua calda"
- B7. Tasto "My": per personalizzare la lunghezza delle bevande
- B8. Manopola selezione funzioni
 - Espresso
 - Americano
 - Coffee
 - Decalcificazione
- B9. Spia "decalcificazione"
- B10. Spia "pronto vapore"
- B11. Spia "mancanza contenitore chicchi"
- B12. Spia "risparmio energetico"
- B13. Spia "Pulizia" (vedi "8.1 Cleaning of the coffee outlet")
- B14. Spia "contenitore chicchi vuoto"
- B15. Spia "mancanza acqua"
- B16. Spia "pressatura"
- B17. Manometro

1.3 Descrizione degli accessori - C

- C1. Coppetta portafiltro
- C2. Filtro 1 tazza
- C3. Filtro 2 tazze
- C4. Striscia reattiva "Total Hardness Test"
- C5. Decalcificante
- C6. Cavo alimentazione removibile
- C7. Scovolino
- C8. Accessorio pulizia erogatore caffè
- C9. Softballs
- C10. Bricco latte
- C11. Ago di pulizia per lancia vapore

1.4 Accessori pulizia non inclusi, raccomandati dal costruttore

Per maggiori informazioni, visita Delonghi.com.



Pastiglie pulizia

(Vedi "8.1 Pulizia dell'erogatore caffè")

EcoMultiClean Detergente

EAN: 8004399333307

2. PREPARAZIONE DELL'APPARECCHIO

Lavare con acqua tiepida e detersivo per piatti tutti gli accessori, quindi procedere come segue:

1. Inserire il contenitore chicchi (A2) nel macinacaffè (fig. 1). Il contenitore è inserito correttamente quando la freccia ▲ è allineata al simbolo ☐ e si sente un "click" (fig. 2).
2. Inserire il vassoio raccogliocce (A10) completo di griglia poggiatezze (A8) e griglia vaschetta (A9) (fig. 3);
3. Estrarre il serbatoio acqua (A14) (fig. 4) e riempirlo con acqua fresca e pulita facendo attenzione a non superare la scritta MAX (fig. 5).
4. Quindi reinserire il serbatoio.

Attenzione: Non mettere mai in funzione l'apparecchio senza l'acqua nel serbatoio o senza serbatoio.

Nota bene: Si consiglia di personalizzare al più presto la durezza dell'acqua seguendo la procedura descritta nel capitolo "7. Menù impostazioni".

3. PRIMA MESSA IN FUNZIONE DELL'APPARECCHIO

1. Inserire il connettore del cavo alimentazione (C6) nell'apposita sede (A16) sul retro dell'apparecchio (fig. 6); quindi inserire la spina nella presa. Assicurarsi che l'interruttore generale (A17), posto sul retro dell'apparecchio sia premuto in posizione I (fig. 7);
2. Posizionare sotto l'erogatore acqua calda (in corrispondenza dell'erogatore caffè (A18)) un contenitore con capienza minima di 100 ml (fig. 8);
3. Premere il tasto (B6) in corrispondenza della spia ☐ (fig. 9): l'erogazione inizia e si interrompe automaticamente. Svuotare il contenitore.

Prima di iniziare a utilizzare la macchina, è necessario risciacquare i circuiti interni della macchina. Procedere come segue:

4. Agganciare la coppetta portafiltro (C1) completa di filtro alla macchina: per un aggancio corretto, allineare il manico della coppetta portafiltro a "INSERT" (fig. 10) e ruotare l'impugnatura verso destra, fino ad allinearla alla posizione "CLOSE";
5. Mettere un contenitore sotto la coppetta portafiltro e al tubo erogatore vapore (A6);
6. Premere il tasto OK (B5) (fig. 11): l'erogazione comincia;
7. Finita l'erogazione, ruotare la manopola vapore (A4) (fig. 12) ed erogare vapore per alcuni secondi in modo da risciacquare il circuito vapore: per un'erogazione ottimale di vapore, si consiglia di ripetere quest'operazione per 3 o 4 volte. Questo permette di eliminare l'acqua nel tubo prima di erogare vapore.

L'apparecchio è quindi pronto all'uso.

Nota bene: il risciacquo dei circuiti interni è consigliato anche in caso di prolungato inutilizzo dell'apparecchio.

Al primo utilizzo è necessario fare 4-5 caffè prima che la macchina cominci a dare un risultato soddisfacente: dedicare particolare attenzione alla dose caffè macinata nel filtro ((C2) o (C3)) (vedi istruzioni al paragrafo "4.1 Fase 1 - Macinatura (grinding)"). Procedere come indicato al capitolo "La dose perfetta".

4. PREPARARE IL CAFFÈ

4.1 Fase 1 - Macinatura (grinding)

1. Versare i chicchi nel contenitore (A2) (fig. 13). È consigliabile versare solo i chicchi necessari alla preparazione: in questo modo si utilizzerà sempre caffè fresco;
2. Selezionare il grado di macinatura (fig. 14). L'impostazione di fabbrica è 5 (macinatura media). Se il risultato non fosse soddisfacente, regolare il livello in base al gusto personale e al tipo di caffè (la regolazione va effettuata durante il funzionamento del macinacaffè).

Nota bene: Il grado di macinatura tra 3 e 6 è consigliato per la maggior parte dei caffè. Il risultato della macinatura con selezione su 1 o 2, è molto fine, da utilizzare solo con caffè molto particolare (tostato leggero).

3. Inserire uno dei filtri caffè (C2) o (C3) nel portafiltro (C1) (fig. 15). Se si utilizza il filtro per 2 tazze, premere il tasto X2 (B3): con questa selezione raddoppia anche la quantità erogata di espresso.
4. Regolare la manopola quantità (B2) partendo dalla posizione minima (fig. 16).

Fare riferimento al paragrafo "Regolare la quantità di caffè macinato nel filtro" per ulteriori indicazioni.

5. Agganciare il portafiltro all'uscita macinacaffè (A19) allineandolo alla scritta INSERT: quindi ruotare verso destra la coppetta. La macinatura inizia quando la coppetta raggiunge la posizione CLOSE e si interrompe automaticamente.

Regolare la quantità di caffè macinato nel filtro

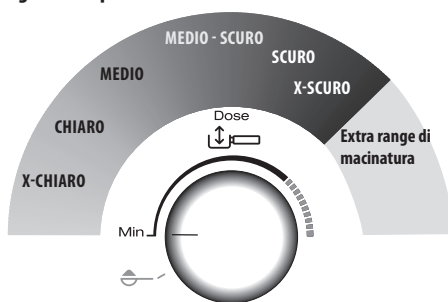

Ogni varietà di chicco dà un risultato diverso durante la macinatura e per questo all'inizio la regolazione della dose richiede estrema cura.

Questa illustrazione dà delle indicazioni su come regolare la dose, basate sul colore di tostatura: sono da considerarsi un punto di partenza, ma possono variare in base alla composizione dei chicchi caffè.

1. Impostare la dose dalla posizione minima.
2. Facendo riferimento al colore di tostatura del vostro caffè, ruotare lentamente la manopola.

4.2 Fase 2 - Pressatura (tamping)

1. Dopo la macinatura, abbassare la leva pressatura (A20) fino a fine corsa (non rimuovere il portafiltro) (fig. 17). Per un risultato perfetto, ripetere 2 volte.
2. Mantenere abbassata la leva fino a fine corsa durante la rimozione del portafiltro (fig. 18). Poi riportare la leva nella posizione iniziale.
3. Una volta verificato che la dose caffè sia corretta (vedi "La dose perfetta"), agganciare il portafiltro all'erogatore caffè (A18) (fig. 19).

Nota bene: Se dopo la pressatura rimane del caffè residuo lungo i bordi del filtro, questo non pregiudica assolutamente la qualità dell'estrazione e quindi il risultato finale.

La "dose perfetta"

- I filtri caffè, hanno un riferimento interno per identificare la dose perfetta.



Marcatura a laser

- Filtri con marcatura a laser: la dose perfetta corrisponde alla linea superiore della marcatura;
- Filtri con marcatura in rilievo: la dose perfetta corrisponde alla linea in rilievo;

Marcatura in rilievo

- Assicurarsi che il caffè sia a livello dopo la pressatura. Potrebbe essere necessario regolare più volte la manopola (B2) prima di arrivare alla dose perfetta.
- Se il caffè è sovra- o sotto-estratto e la dose è all'interno della dose perfetta, regolare il grado di macinatura più fine o più grossolana (vedi "4.1 Fase 1 - Macinatura (grinding)"). Se il caffè è sovra- estratto (erogazione troppo lenta) la macinatura dovrà essere più grossolana. Se il caffè è sotto-estratto (erogazione troppo veloce) la macinatura dovrà essere più fine.
- **Il barista consiglia:** Estrarre il portafiltro mentre la leva del pressino (A20) è abbassata per ottenere una perfetta finitura della dose di caffè.
- **Se si utilizza caffè pre-macinato:**
 - versare il caffè premacinato nel filtro;
 - ruotare la manopola su ;
 - agganciare il portafiltro all'uscita macinacaffè;
 - abbassare la leva pressatura.







4.3 Fase 3 - Erogazione (brewing)

1. Selezionare la temperatura (fig. 20) (vedi "La temperatura per preparare il caffè").
2. Selezionare la bevanda desiderata (fig. 21).
3. Premere OK (B5) per iniziare l'erogazione (fig. 11) (pre-infusione ed infusione). L'erogazione caffè si interrompe automaticamente.

La temperatura per preparare il caffè

La temperatura dell'acqua è controllata durante l'intero processo di preparazione per garantirne la stabilità in fase di estrazione. La Specialista Prestigio offre 3 temperatura di infusione* che corrispondono ad un range tra i 92°C e i 96°C.

A seconda della varietà e della tostatura dei chicchi, si consiglia una temperatura diversa: i chicchi di Robusta richiedono una temperatura bassa; i chicchi di Arabica una temperatura alta. Lo stesso vale per i chicchi con tostatura scura o per i chicchi appena tostati.

Livello di temperatura	Spia corrispondente	Livello di tostatura
MIN	 	Scuro
MED	 	Medio-scuro
MAX	 	Chiaro - medio

- * Questa temperatura fa riferimento all'acqua nel thermo-block. È quindi diversa dalla temperatura della bevanda in tazza o dalla temperatura misurata quando la bevanda esce dagli erogatori del portafiltro.

5. PREPARAZIONE BEVANDE LATTE

5.1 Schiumare il latte

1. Versare nel bricco (C10) la quantità di latte che si vuole scaldare/schiumare, tenendo conto che il volume del latte aumenterà di 2 o 3 volte (fig. 22). Per ottenere una schiuma più densa e omogenea, è consigliabile utilizzare latte vaccino intero ed a temperatura di frigorifero (circa 5°C).

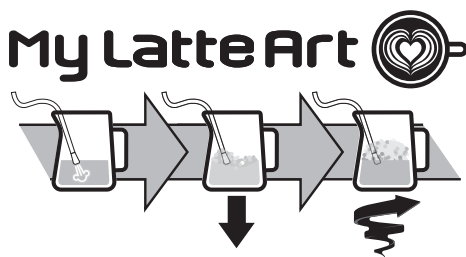

2. Per schiumare il latte, appoggiare il tubo erogatore vapore (A6) sulla superficie del latte: così facendo l'aria si mescola al latte e al vapore.
3. Mantenere l'erogatore vapore sulla superficie, prestando attenzione a non catturare troppa aria creando bolle troppo grosse.
4. Immergere l'erogatore vapore sotto la superficie del latte: in questo modo si crea un vortice. Una volta raggiunta la temperatura desiderata, richiudere la manopola vapore e attendere che l'erogazione vapore si interrompa completamente prima di rimuovere il bricco del latte.

Il barista consiglia:





- **Il latte fresco è migliore.** Utilizzare sempre latte fresco a temperatura di frigorifero.
- Per un risultato migliore, si consiglia di riporre sempre il brico del latte in frigorifero.
- Il latte intero assicura ottimi risultati. Il risultato e la texture della schiuma variano a seconda del latte vaccino o delle bevande vegetali utilizzate.
- Dopo aver schiumato il latte, eliminare le bolle roteando leggermente il bricco del latte.

Pulizia dell'erogatore vapore:

1. Dopo ogni uso, rimuovere con un panno i residui di latte dall'erogatore vapore (fig. 23). Per una pulizia profonda, è consigliabile utilizzare Eco MultiClean: assicura l'igiene rimuovendo proteine e grassi del latte e può essere utilizzato per pulire l'intera macchina.

- Erogare vapore per alcuni secondi per pulire bene l'erogatore (fig. 12).
- Attendere che l'erogatore si raffreddi: per mantenere l'efficienza dell'erogatore nel tempo, utilizzare l'ago di pulizia (C11) per mantenere liberi i 3 fori (fig. 24).







6. PERSONALIZZARE LA LUNGHEZZA DELLE BEVANDE CAFFÈ CON IL TASTO (B7)

- Preparare la macchina per erogare 1 o 2 tazze della bevanda caffè che si desidera erogare, fino ad agganciare il portafiltro (C1) completo di filtro (C2) o (C3) e caffè macinato.
- Ruotare la manopola (B8) per selezionare la bevanda da programmare.
- Premere il tasto : la spia corrispondente al tasto  lampeggia.
- Premere il tasto OK per iniziare l'erogazione. Le spie corrispondenti ai tasti OK e  lampeggiano.
- Una volta raggiunta la quantità desiderata, premere OK. Se la bevanda prevede l'erogazione di un altro ingrediente, comincia l'erogazione di quest'ultimo: una volta raggiunta la quantità desiderata, premere OK.
- Premere il tasto  per salvare. L'apparecchio è pronto per un nuovo utilizzo e la spia  rimane accesa.

Se non si desidera salvare la programmazione, premere qualsiasi altro tasto.

Nota bene:

- Si possono programmare le bevande con caffè, ma non l'erogazione di vapore e acqua calda.
- La programmazione modifica le quantità delle bevande, ma non del caffè macinato.
- Le bevande "X2" possono essere programmate separatamente.
- Per ritornare alle impostazioni di fabbrica, mantenere premuto il tasto  fino allo spegnimento. La bevanda selezionata torna alla quantità di fabbrica.

Ricetta caffè	Quantità di fabbrica	Quantità programmabile
 Espresso	35 ml	da 25 a 90 ml
 Espresso X2	70 ml	da 50 a 180 ml
 Coffee	80 ml	da 50 a 120 ml
 Coffee X2	160 ml	da 120 a 240 ml
 Americano	120 ml	<ul style="list-style-type: none"> espresso: da 25 a 60 ml acqua: da 25a 120 ml
 Americano X2	240 ml	<ul style="list-style-type: none"> espresso: da 50 a 120 ml acqua: da 50 a 240 ml



7. MENÙ IMPOSTAZIONI

1. Entrare nel menù:

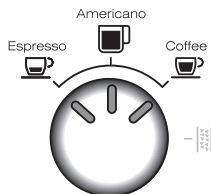

Premere contemporaneamente per 5 secondi	x2	
--	----	--

2. Impostazioni con selezione da manopola (B8)



Impostazione corrispondente	Ruotare su	Regolazioni
Regolazione extra della macinatura		x2 → Range 1
		 → Range 2
Durezza acqua	 Americano	x2 → dolce
		 → media
		 → dura/molto dura
Auto-spegnimento	 Coffee	x2 → 9 minuti
		 → 1,5 ore
		 → 3 ore

3. Impostazione con selezione da tasto:

Risparmio energetico	 → Attivo
	 → Spento
Valori di fabbrica	Mantenere premuto per almeno 5 secondi il tasto  , finchè la spia rimane accesa fissa

4. Salvare le nuove impostazioni premendo ON/Standby (B1)



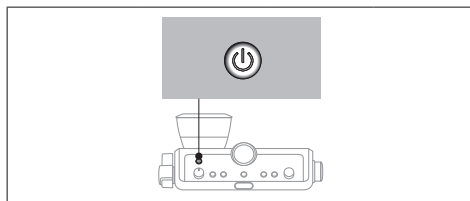

8. PULIZIA DELL'APPARECCHIO

Attenzione!

- Per la pulizia della macchina non usare solventi, detergenti abrasivi o alcool.
- Non utilizzare oggetti metallici per togliere le incrostazioni o i depositi di caffè, perché potrebbero graffiare le superfici in metallo o in plastica.
- Per periodi di inutilizzo superiori alla settimana è consigliato, prima di utilizzare la macchina, di procedere ad un risciacquo.

Pericolo!

- Durante la pulizia, non immergere mai la macchina nell'acqua: è un apparecchio elettrico.
- Prima di qualsiasi operazione di pulizia delle parti esterne dell'apparecchio, spegnere la macchina, staccare la spina dalla presa di corrente e lasciar raffreddare la macchina.

	×	✓	✓	×	×
	✓	×	×	✓	✓
	×	×	×	✓	✓
	×	×	×	✓	✓
	×	×	✓	✓	×
	×	×	×	✓	✓

8.1 Pulizia dell'erogatore caffè

Quando la spia si accende (arancione) (B13), è necessario procedere alla pulizia del circuito caffè. Per eseguire il ciclo di pu-

lizia, acquistare le pastiglie per la pulizia per macchine da caffè. Per maggiori informazioni, visitare www.Delonghi.com.

1. Inserire il filtro 1 tazza (C2) nel portafiltro (C1) (fig. 25).
2. Inserire nel filtro l'accessorio pulizia (C8) (fig. 25) e premerlo a fondo.
3. Mettere la pastiglia per la pulizia sull'accessorio (fig. 26).
4. Attaccare il portafiltro all'erogatore caffè (A18).
5. Riempire il serbatoio acqua (A14). Assicurarsi che la vaschetta raccogliacqua (A10) sia vuota.
6. Mantenere premuto il tasto (B6), finché si accende la spia (B13). Dopo alcuni minuti, la pulizia si interrompe automaticamente.
7. Rimuovere il portafiltro e l'accessorio pulizia.
8. Lavare il portafiltro ed il filtro sotto l'acqua corrente.
9. Reinscrivere il portafiltro e procedere con un risciacquo premendo il tasto : si consiglia di mettere un contenitore sotto il portafiltro.
10. Rimuovere e svuotare la vaschetta raccogliacqua.

Nota bene:

Questo ciclo di pulizia può essere avviato in ogni momento premendo il tasto per alcuni secondi. Per cancellare l'operazione, premere il pulsante per 10 secondi.

8.2 Pulire l'alloggiamento del contenitore chicchi

1. Assicurarsi che il contenitore chicchi (A2) sia vuoto. Eventualmente procedere con alcune macinature a vuoto per svuotarlo.
2. Sganciare il contenitore ruotandolo in senso antiorario ed estrarlo dalla macchina (fig. 27)
3. Aspirare i residui di caffè (fig. 28).
4. Pulire con un panno umido la sede del contenitore chicchi e asciugare (fig. 29);
5. Riposizionare il contenitore inserendolo nel macinacaffè. Il contenitore è inserito correttamente quando la freccia è allineata al simbolo e si sente un "click" (fig.30).

8.3 Pulizia delle macine

Quando si pulisce il contenitore chicchi (A2), pulire la sede del contenitore e la macina superiore con un panno umido. Rivolgersi ad un centro assistenza per rimuovere e sostituire le macine.

È possibile rimuovere la macina qualora il macinacaffè fosse bloccato da un corpo estraneo. Se questo dovesse accadere, rimuovere il contenitore chicchi e procedere come segue:

1. Agganciare la coppetta portafiltro (C1) e fare una macinatura "a vuoto" per liberare il condotto caffè.
2. Spegner l'apparecchio.
3. Ruotare in senso antiorario il regolatore di macinatura fino a fine corsa, in posizione "REMOVE" (fig. 31).
4. Estrarre la parte superiore della macina, afferrandola dall'apposita maniglia (fig.32).

5. Pulire la macina con un pennello (fig. 33) e aspirare i residui di caffè con un aspirapolvere (fig. 28).

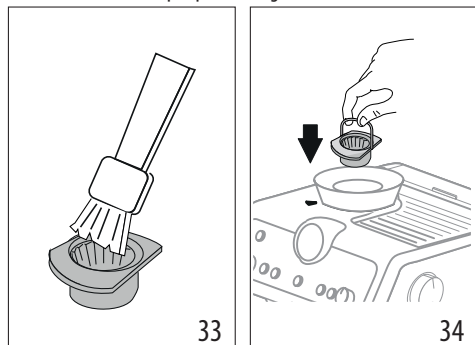

6. Inserire la macina nella sua sede (fig. 34);
7. Ruotare il regolatore selezionando il grado di macinatura desiderato (fig. 14);

Verificare che la macina sia ben inserita, tirandola per la maniglia: la macina è correttamente inserita se non si muove.

8.4 Sostituzione delle macine

Quando la quantità di caffè macinato si riduce ancora, rivolgersi ad un centro assistenza per sostituire le macine: poi regolare di nuovo il macinacaffè entrando nel menù impostazioni ("7. Menù impostazioni") e selezionando il primo range della regolazione extra della macinatura. Quindi, ruotare la manopola regolazione quantità (B2) in posizione MIN e regolare la dose come ad il primo utilizzo (vedi "La dose perfetta").

8.5 Pulizia della "Smart tamping station"

1. Pulire la zona di aggancio con un pennello (fig. 35).
2. Tirare la leva (A20) fino a fine corsa e pulire con un pennello il pressino (fig. 36), quindi rilasciare la leva.
3. Utilizzando lo scovolino (C7), pulire lo scivolo caffè (fig. 37).

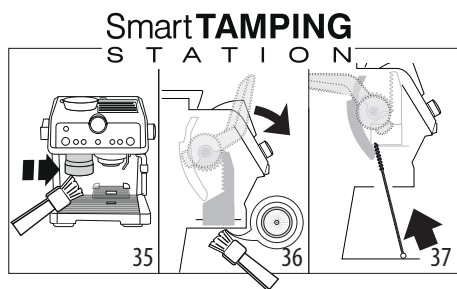

9. DUREZZA ACQUA

La spia (B9) decalcificazione si accende dopo un periodo di funzionamento predeterminato che dipende dalla durezza dell'acqua. È possibile programmare la macchina in base alla

reale durezza dell'acqua in utenza nelle varie regioni, rendendo così meno frequente l'operazione di decalcificazione.

1. Togliere dalla sua confezione la striscia reattiva in dotazione "TOTAL HARDNESS TEST" (C4).
2. Immergere completamente la striscia in un bicchiere d'acqua per circa un secondo.
3. Estrarre la striscia dall'acqua e scuoterla leggermente. Impostare l'apparecchio, come indicato nel capitolo "7. Menù impostazioni".

Risultato Test Durezza Acqua	Tasto	Livello
	×2	1 acqua dolce
	≡ ^B	2 acqua media
	OK	3 acqua dura o molto dura

4. Impostare l'apparecchio, come indicato nel capitolo "7. Menù impostazioni".

10. COME UTILIZZARE SOFTBALLS

Softballs (C9) è un sistema innovativo che allunga la vita della macchina, senza alterare le qualità dell'acqua, garantendo l'erogazione di un caffè cremoso e aromatico. Per ottimizzare l'efficacia, lasciare Softballs nell'acqua per l'intera notte precedente all'uso.

1. Estrarre il pacchetto di Softballs dall'imballo (fig. 38).

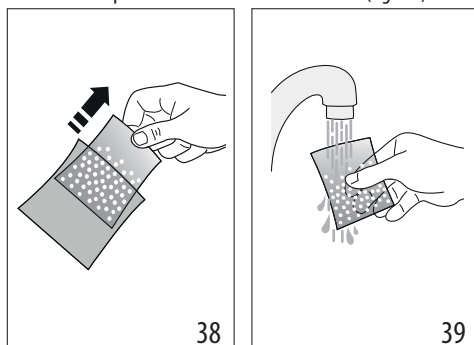

2. Risciacquare con acqua corrente il pacchetto di Softballs (fig. 39).
3. Immergere il sacchetto nel serbatoio acqua (A14) (fig. 40).

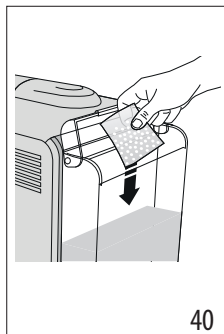

4. Sostituire il sacchetto di Softballs ogni 3 mesi (fig. 41).

11. DECALCIFICAZIONE

Attenzione!

- Prima dell'uso, leggere le istruzioni e l'etichettatura del decalcificante (C5), riportate sulla confezione del decalcificante stesso.
- Si raccomanda di utilizzare esclusivamente decalcificanti De'Longhi. L'utilizzo di decalcificanti non idonei, come pure la decalcificazione non regolarmente eseguita, può comportare l'insorgenza di difetti non coperti dalla garanzia del produttore.
- Il decalcificante può danneggiare le superfici delicate. Se il prodotto viene rovesciato accidentalmente, asciugare immediatamente.

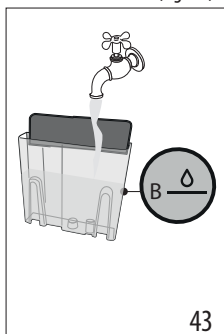
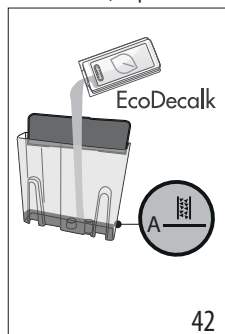

Per effettuare la decalcificazione	
Decalcificante	Decalcificante De'Longhi
Contenitore	Capacità 2 litri
Tempo	~40min

1. (SE PRESENTI, TOGLIERE IL FILTRO ADDOLCITORE E SOFTBALLS). Versare nel serbatoio acqua (A14) il decalcificante fino al livello  **A** (corrispondente a una confezione da 100ml) impresso sul lato interno del serbatoio (fig. 42).

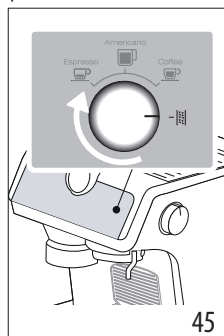
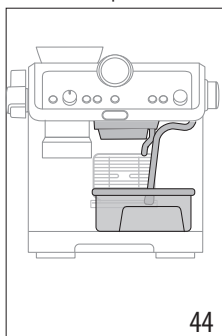

2. Aggiungere acqua fino a raggiungere il livello  **B** (fig. 43). Reinsерire quindi il serbatoio acqua in macchina.



3. Assicurarsi che il portafiltro (C1) non sia agganciato e posizionare un recipiente sotto gli erogatori caffè, acqua calda e sotto l'erogatore vapore (A6) (fig. 44).
4. Ruotare la manopola (B8) su  (fig. 45): la spia OK si accende di colore arancio e la spia  lampeggia.
5. Premere il tasto OK: la spia OK lampeggia.
6. Il programma di decalcificazione si avvia ed il liquido decalcificante esce dagli erogatori. Il programma di decalcificazione esegue automaticamente tutta una serie di risciacqui ad intervalli, per rimuovere i residui di calcare dall'interno della macchina da caffè fino a svuotare il serbatoio.

L'erogazione si interrompe e la spia OK diventa bianca. È quindi necessario procedere con il ciclo di risciacquo:

7. Svuotare il recipiente utilizzato per la raccolta del liquido decalcificante e riporlo sotto gli erogatori.
8. Estrarre il serbatoio acqua, svuotarlo da eventuali residui di soluzione decalcificante, sciarquarlo con acqua corrente e riempirlo con acqua fresca fino al livello MAX (fig. 46). Reinsерire quindi il serbatoio nella sua sede.

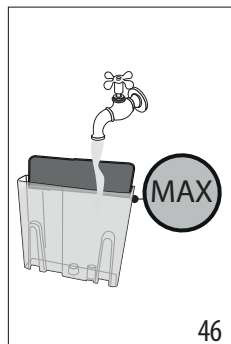









9. Premere il tasto OK: il risciacquo si avvia.
10. Una volta completato il risciacquo, l'erogazione si interrompe e l'apparecchio è pronto all'uso.

11. Svuotare i recipienti di raccolta dell'acqua di risciacquo.
 12. Estrarre e svuotare il vassoio raccogli gocce, quindi reinserirlo.
 13. Estrarre e riempire il serbatoio con acqua fresca, quindi reinserirlo.
- Ora l'apparecchio è pronto all'uso.





Nota bene:









- Il ciclo di decalcificazione può essere avviato in ogni momento (anche se la relativa spia non è ancora accesa).
- Nel caso la decalcificazione sia stata avviata per sbaglio, premere il tasto OK per 10 secondi; il risciacquo non può essere interrotto.

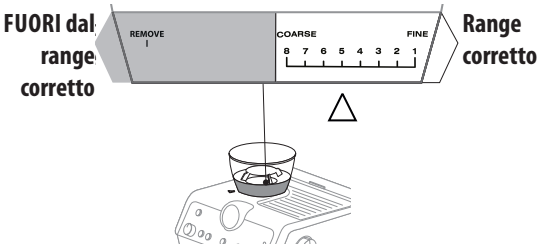

12. SIGNIFICATO DELLE SPIE

SPIE	SIGNIFICATO DELLE SPIE	OPERAZIONE
Tutte le spie lampeggiano brevemente	Accensione dell'apparecchio	Autodiagnosi
 fissa	È la prima accensione della macchina ed è necessario procedere al riempimento del circuito acqua	Procedere come indicato al cap. "3. Prima messa in funzione dell'apparecchio"
 fissa (bianca)	La macchina è pronta per l'erogazione	Preparare la macchina e procedere con la preparazione della bevanda
<ul style="list-style-type: none"> • Spia : indica la temperatura caffè selezionata • Spia : indica che la macchina è pronta ad erogare acqua calda 		
 fissa	La funzione risparmio energetico è attiva	Fare riferimento al cap. "7. Menù impostazioni" se si desidera disattivare la funzione
 fissa	Il contenitore chicchi (A2) è vuoto	Riempire il contenitore chicchi
 lampeggiante	Si vuole procedere con la macinatura, ma il contenitore chicchi (A2) è vuoto	Riempire il contenitore chicchi
 lampeggia brevemente ad intervalli regolari	La manopola (B2) è ruotata sulla posizione di regolazione massima	Quando dopo la macinatura il caffè nel filtro è insufficiente, selezionare un nuovo range di macinatura come indicato nel capitolo "6. Menù settings".
 fissa	L'acqua nel serbatoio (A14) non è sufficiente oppure il serbatoio acqua non è ben inserito	Riempire il serbatoio oppure estrarre e reinserire correttamente il serbatoio



SPIE	SIGNIFICATO DELLE SPIE	OPERAZIONE
 lampeggiante	Si vuole procedere con la preparazione di una bevanda, ma il serbatoio acqua (A14) è vuoto	Riempire il serbatoio acqua
	La macinatura è troppo fine e quindi il caffè fuoriesce troppo lentamente o non esce del tutto	Estrarre la coppetta portafiltro (C1), ripetere le operazioni per fare il caffè tenendo presente le indicazioni del par. "4.1 Fase 1 - Macinatura (grinding)" e "4.2 Fase 2 - Pressatura (tamping)"
	Il filtro caffè (C2) o (C3) è otturato	Risciacquare i filtri sotto l'acqua corrente
	Il serbatoio (A14) è mal inserito e le relative valvole non sono aperte	Premere leggermente il serbatoio in modo da aprirne le valvole
	Calcare all'interno del circuito idraulico	Eseguire la decalcificazione come al cap. "11. Decalcificazione"
 fissa	L'apparecchio è pronto per l'erogazione di vapore	L'apparecchio ha raggiunto la temperatura per erogare vapore. Per procedere con l'erogazione, ruotare la manopola vapore (A4)
 lampeggiante	L'apparecchio è acceso e la funzione risparmio energetico è attiva: la manopola vapore (A4) è in posizione per erogare vapore	La spia lampeggia ad indicare che l'apparecchio si sta preparando per erogare vapore: l'erogazione inizia appena l'apparecchio è in temperatura
	L'apparecchio è pronto per l'erogazione di vapore	L'apparecchio è in temperatura per la preparazione di vapore quando la spia rimane fissa
	L'apparecchio sta erogando vapore	
 fissa	Il contenitore chicchi non è inserito	Inserire correttamente il contenitore chicchi (A2) o verificare che sia correttamente inserito. Il contenitore è inserito correttamente quando la freccia ▲ è allineata al simbolo ☐ e si sente un "click"
→		

SPIE	SIGNIFICATO DELLE SPIE	OPERAZIONE
 lampeggiante	La regolazione del selettore del grado di macinatura non è corretta o è oltre la regolazione massima possibile	Riportare il selettore in una delle posizioni di macinatura (tra 1 e 8), rammentando di: <ul style="list-style-type: none"> Regolare la macinatura mentre il macinacaffè è in funzione Regolare di un livello alla volta e fare almeno 5 macinature tra una regolazione e l'altra
		
 fissa	L'apparecchio richiede la pressatura	È stata appena eseguita la macinatura ed il portafiltro è agganciato al macina caffè
	Il portafiltro è stato sganciato dal macina caffè senza pressare	Sganciare il portafiltro e procedere pressando il caffè come descritto al par. "La "dose perfetta"" "Se si utilizza caffè pre-macinato."
	Il portafiltro è stato sganciato senza concludere la macinatura o la pressatura è stata eseguita troppo presto	Ripetere la macinatura
	Lo scivolo caffè del macinacaffè è intasato	Procedere alla pulizia come indicato al par. "8.5 Pulizia della "Smart tamping station"". Se il problema persiste, accedere allo scivolo aprendo l'apposito sportellino e liberarlo utilizzando lo scovolino
	Le macine sono bloccate da un corpo estraneo	Rimuovere il corpo estraneo e pulire le macine come indicato al par. "8.3 Pulizia delle macine".
 fissa (rossa)	È necessario procedere con la decalcificazione	Eseguire la decalcificazione come illustrato al cap. "11. Decalcificazione"
 lampeggia (rossa) +  lampeggia (arancione)	L'apparecchio sta eseguendo la decalcificazione	Procedere completando l'operazione come descritto al cap. "11. Decalcificazione"
 lampeggia (rossa) +  fissa (bianca)	È necessario procedere con il risciacquo	
 lampeggi (rossa) +  lampeggia (bianca)	L'apparecchio sta eseguendo il risciacquo del ciclo decalcificazione	
→		

SPIE	SIGNIFICATO DELLE SPIE	OPERAZIONE
 fissa (arancione)	È necessario procedere con la pulizia dell'erogatore caffè	Vedi par. "8.1 Pulizia dell'erogatore caffè"
 lampeggiante (arancione)	L'apparecchio sta eseguendo la pulizia dell'erogatore caffè	
Tutte le spie lampeggiano	Allarme generico	Rivolgersi ad un centro assistenza

13. SE QUALCOSA NON FUNZIONA

PROBLEMA	CAUSA	SOLUZIONE
C'è dell'acqua nella vaschetta raccogli-gocce (A10)	Fa parte del normale funzionamento dai circuiti interni della macchina	Svuotare e pulire regolarmente la vaschetta raccogli-gocce
Non esce più il caffè espresso	Mancanza di acqua nel serbatoio (A14)	Riempire il serbatoio
	La spia  (B6) è accesa ad indicare che il circuito caffè o circuito vapore è vuoto	Premere il tasto corrispondente alla spia  per riempire il circuito
	Il filtro (C2) o (C3) è otturato	Risciacquare i filtri sotto l'acqua corrente
	Il serbatoio (A14) è mal inserito e le valvole sul suo fondo non sono aperte	Premere leggermente il serbatoio in modo da aprire le valvole sul suo fondo
	Calcare all'interno del circuito idraulico	Eeguire la decalcificazione come al cap. "11. Decalcificazione"
	Macinatura troppo fine	Estrarre la coppetta portafiltro (C1), ripetere le operazioni per fare il caffè tenendo presente le indicazioni del par. "4.1 Fase 1 - Macinatura (grinding)" e "4.2 Fase 2 - Pressatura (tamping)"
Il portafiltro non si aggancia all'apparecchio	Il caffè macinato non è stato pressato o è in quantità eccessiva	Ripetere la macinatura con delle impostazioni diverse. Ridurre la quantità della dose: verificare che il filtro (C2) o (C3) (1 o 2 tazze) sia corretto rispetto alla dose da macinare (tasto 2x (B3) selezionato o no)
Il caffè espresso gocciola dai bordi del portafiltro (C1) anziché dai fori	Il portafiltro è male inserito	Agganciare il portafiltro correttamente e ruotarlo fino in fondo con forza
	La guarnizione dell'erogatore caffè (A18) ha perso elasticità o è sporca	Sostituire la guarnizione dell'erogatore caffè presso un Centro Assistenza
	Il filtro (C2) o (C3) è otturato	Risciacquare i filtri sotto l'acqua corrente
La crema del caffè è chiara (scende velocemente dal beccuccio)	È necessario rivedere le impostazioni dell'apparecchio	Estrarre la coppetta, ripetere le operazioni per fare il caffè tenendo presente le indicazioni del par. "4.1 Fase 1 - Macinatura (grinding)" e "4.2 Fase 2 - Pressatura (tamping)"
		→

PROBLEMA	CAUSA	SOLUZIONE
La crema del caffè è scura (il caffè scende lentamente dal beccuccio)	È necessario rivedere le impostazioni dell'apparecchio	Estrarre la coppetta portafiltro (C1), ripetere le operazioni per fare il caffè tenendo presente le indicazioni del par. "4.1 Fase 1 - Macinatura (grinding)" e "4.2 Fase 2 - Pressatura (tamping)"
Al termine della decalcificazione, l'apparecchio richiede un altro risciacquo	Durante il ciclo di risciacquo, il serbatoio non è stato riempito fino al livello MAX	Ripetere il risciacquo (vedi cap. "11. Decalcificazione")
L'apparecchio non macina il caffè	All'interno del macinacaffè è presente un corpo estraneo	Procedere alla pulizia delle macine come indicato al par. "8.3 Pulizia delle macine", assicurandosi di aver rimosso tutti i chicchi dal contenitore chicchi (A2) prima di estrarlo. Prima di reinserire la macina, aspirare accuratamente ogni residuo dalla sua sede
	Il contenitore chicchi (A2) non è in posizione corretta	Il contenitore è inserito correttamente quando la freccia ▲ è allineata al simbolo ☞ e si sente un "click"
Se si desidera cambiare qualità di caffè	È necessario eliminare tutti i chicchi presenti nella macchina	<ul style="list-style-type: none"> • Svuotare il contenitore chicchi (A2) (facendo delle macinature a vuoto o eventualmente aspirando i chicchi residui) • Agganciare la coppetta portafiltro (C1) e fare delle macinature "a vuoto" per liberare il condotto caffè: agganciare quindi il portafiltro all'uscita macinacaffè (A19) allineandolo alla scritta INSERT e ruotare verso destra la coppetta. La macinatura inizia quando la coppetta raggiunge la posizione CLOSE e si interrompe automaticamente. Ripetere finché il filtro rimane vuoto • Inserire nel contenitore (A2) la nuova varietà di chicchi di caffè • Se alla macinatura non si raggiunge la "dose perfetta", procedere come al primo utilizzo
		→

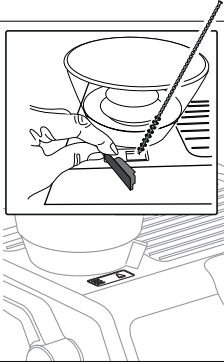
PROBLEMA	CAUSA	SOLUZIONE
<p>Dopo la macinatura, il filtro caffè (C2) o (C3) è vuoto</p> <p>Dopo la macinatura, la polvere caffè nel filtro è sovrabbondante</p>	<p>Lo scivolo caffè del macinacaffè è intasato</p>	<p>Procedere alla pulizia come indicato al par. "8.5 Pulizia della "Smart tamping station"". Se il problema persiste, accedere allo scivolo aprendo l'apposito sportellino (A21) e liberarlo utilizzando lo scovolino</p> 
<p>Dopo la macinatura, la polvere caffè nel filtro (C2) o (C3) non raggiunge la "dose perfetta"</p>	<p>La "Smart Tamping Station" necessita pulizia</p> <p>È necessario regolare la quantità di caffè macinato</p> <p>Con il tempo le macine si usurano</p>	<p>Procedere alla pulizia come indicato al par. "8.5 Pulizia della "Smart tamping station"", quindi ripetere la macinatura</p> <p>Regolare la quantità con la manopola dedicata (B2) seguendo le indicazioni al par. La "dose perfetta". Se la manopola è già in posizione max, procedere come indicato nella sezione "7. Menù impostazioni" - "Regolazione extra della macinatura"</p> <p>Procedere alla sostituzione delle macine come indicato al par. "8.4 Sostituzione delle macine"</p>

Before using the appliance, always read the safety warnings.

1. DESCRIPTION

1.1 Description of appliance - A

- A1. Beans container lid
- A2. Beans container
- A3. Cup tray
- A4. Steam dial
- A5. Hot water spout
- A6. Steam wand
- A7. Cup grille for espresso
- A8. Cup grille for glasses or mugs
- A9. Drip tray grille
- A10. Drip tray
- A11. Drip tray water level indicator
- A12. Water tank lid
- A13. Water tank extraction handle
- A14. Water tank
- A15. Water softener filter housing
- A16. Power cord connector socket
- A17. Main switch (ON/OFF)
- A18. Coffee spout
- A19. Coffee mill outlet (tamping station)
- A20. Presser lever
- A21. Cover giving access to coffee mill funnel

1.2 Description of control panel - B

- B1. ON/Standby button
- B2. Ground coffee quantity dial
- B3. "2x" button: selection of 2-coffee filter
- B4. Coffee temperature button
- B5. "OK" button: delivery of beverage/confirm
- B6. Hot water button
- B7. "My" button: customization of beverage quantity
- B8. Function selector dial
 - Espresso
 - Americano
 - Coffee
 - Descale
- B9. "Descale" light
- B10. "Steam ready" light
- B11. "No beans container" light
- B12. "Energy saving" light
- B13. "Clean" light (see "8.1 Cleaning of the coffee outlet")
- B14. "Beans container empty" light
- B15. "No water" light
- B16. "Press" light
- B17. Pressure gauge

1.3 Description of accessories - C

- C1. Filter holder
- C2. 1 cup filter
- C3. 2 cup filter
- C4. "Total Hardness Test" paper
- C5. Descaler
- C6. Removable power cord
- C7. Tube brush
- C8. Coffee outlet cleaning accessory
- C9. Softballs
- C10. Milk jug
- C11. Steam wand cleaning needle

1.4 Optional cleaning accessories recommended by the manufacturer

For more information, visit www.delonghi.com.



Cleaning tabs

(see "8.1 Cleaning the coffee outlet")

EcoMultiClean Cleaner

EAN: 800439933307

2. PREPARING THE APPLIANCE

Wash all accessories with warm water and washing-up liquid, then proceed as follows:

1. Locate the beans container in the (A2) coffee mill (fig. 1). The container is correctly in place when the arrow ▲ aligns with the ☐ symbol and a "click" is heard (fig. 2).
2. Locate the drip tray (A10) together with the cup grille (A8) and drip tray grille (A9) (fig. 3);
3. Take out the water tank (A14) (fig. 4) and fill with fresh clean water, taking care not to exceed the MAX level (fig. 5).
4. Put the tank back in the appliance.

Important: *Never operate the appliance without water in the tank or without the tank.*

Please note: *You should customise water hardness as soon as possible following the instructions in section "7. Settings menu".*

3. SETTING UP THE APPLIANCE

1. Plug the power cord connector (C6) into the socket (A16) at the back of the appliance (fig. 6), then plug into the mains socket. Make sure the main switch (A17) at the back of the appliance is pressed and in the I position (fig. 7);
2. Place a container of at least 100 ml capacity under the hot water spout (next to the coffee spout (A18)) as illustrated (fig. 8).
3. Press the button (B6) next to the ☐ indicator light (fig. 9): delivery will start and then stop automatically. Empty the container.

Before using the coffee maker, the internal circuits of the machine must be rinsed. Proceed as follows:

4. Attach the filter holder (C1) complete with filter to the appliance. To attach correctly, align the filter holder handle with

"INSERT" (fig. 10), then turn the handle to the right until it is aligned in the "CLOSE" position;

- Place a container under the filter holder and the steam wand (A6);
- Press the OK button (B5): delivery will start (fig. 11);
- When delivery has finished, turn the steam dial (A4) (fig. 12) and release the jet for a few seconds so as to rinse the steam circuit: to ensure best possible results, repeat the operation 3 or 4 times. The purpose of this procedure is to purge any water from the circuit before using steam to prepare a beverage.

The appliance is ready for use.

Please note: *We also recommend rinsing the internal circuits if the appliance is not used for a long period.*

The first time you use the appliance, you need to make 4-5 cups of coffee before the appliance starts to give satisfactory results. Pay particular attention to the quantity of pre-ground coffee in the filter ((C2) or (C3)) (see instructions in section "4.1 Step 1 - Grinding").

Proceed as described in section "The "perfect dose"".

4. PREPARATION OF COFFEE

4.1 Step 1 - Grinding

- Put coffee beans in the container (A2) (fig. 13). It is best to grind only a quantity of beans sufficient for immediate use, so that the coffee will always be fresh.
- Select the grinding level (fig. 14). The factory setting is 5 (medium ground). If this is too fine or too coarse, adjust the level according to personal taste and to the type of coffee being used (the adjustment must be made only when the coffee mill is in operation).

Please note: *A grinding level between 3 and 6 is recommended for most coffees. A grinding level of 1 or 2 is very fine and should be used with special coffees only (light roasted)*

- Place the ground coffee filter (C2) or (C3) in the filter holder (C1) (fig. 15); If the 2-cup filter is in use, press the 2x button (B3): this will also double the quantity of espresso coffee delivered from the spout.
- Set the quantity by adjusting the dial (B2), starting from the minimum position (fig. 16).

Refer to the section on "Adjusting the quantity of ground coffee in the filter" for further indications.

- Attach the filter holder to the outlet of the coffee mill (A19), aligning it with "INSERT", then turning it to the right. Grinding begins when the filter holder reaches the CLOSE position, then stops automatically.

Adjusting the quantity of ground coffee in the filter

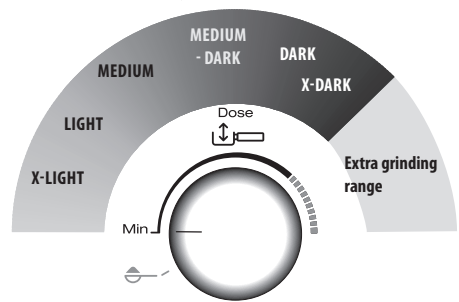

Different varieties of coffee bean give different results when ground: consequently, the initial adjustment of the dosage requires special care.

This illustration shows how to regulate the dosage, based on the roast colour: this should be taken as a general guide, given that in practice, the final adjustment can vary according to the composition of the beans.

- Set the dosage starting from the minimum position.
- Looking at the roast colour of your particular beans, turn the dial slowly to find the right adjustment.

4.2 Step 2 - Tamping

- Following the grinding step, bring the tamping lever (A20) down completely (keeping the filter in place under the outlet) (fig. 17). For a perfect result, repeat the step twice.
- Keep the tamping lever fully down when removing the filter holder (fig 18) and then return the lever to its initial position.
- Having checked that the dosage is as required (see "The "perfect dose""), attach the filter holder to the brewer outlet (A18) (fig. 19).

Please note: *Coffee left on the edges of the filter after pressing does not in any way compromise the quality of the brewing and therefore the end result.*

The "perfect dose"

- A reference mark inside the coffee filters identifies the perfect quantity.

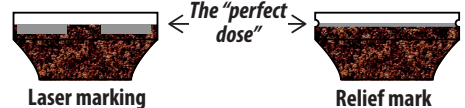

- Laser marked filters: the perfect quantity corresponds to the top line of the mark.
- Filters with relief mark: the perfect quantity corresponds to the line in relief.
- Make sure the coffee is at the right level after tamping. It might be necessary to adjust the level a few times using the dial (B2) before the ideal dosage is achieved.

- If the coffee is extracted too strongly or too weakly even at the ideal dosage, this can be corrected by grinding the beans more finely or more coarsely (see “4.1 Step 1 - Grinding”). To correct over-extraction (coffee released too slowly), select a coarser setting. To correct under-extraction (coffee released too quickly), select a finer setting.
- **Barista tips:** Draw the filter holder away from the tamper with the lever (A20) still down, so that the dose of coffee has a perfectly smooth finish.
- **When using pre-ground coffee:**
 - spoon the pre-ground coffee into the filter;
 - turn the dial to ;
 - attach the filter holder to the grinder outlet;
 - lower the tamping lever.







4.3 Step 3 - Brewing

1. Select the temperature (fig. 20) (see “Coffee preparation temperature”).
2. Select the desired beverage (fig. 21).
3. Press OK (B5) to start brewing (fig. 11) (pre-infusion and infusion). Delivery of the coffee will stop automatically.

Coffee preparation temperature

The water temperature is controlled during the entire preparation process to ensure its stability during the extraction step. The Specialista Prestigio offers 3 infusion temperatures* set in a range between 92 and 96 °C.

The temperature effectively utilized will depend typically on the variety of bean and the roast: Robusta beans require a lower temperature, and Arabica beans a higher temperature. The same applies for dark roasted beans or for light roasted beans, respectively.

Temperature level	Corresponding indicator light	Roast colour
MIN	 	Dark
MED	 	Medium-dark
MAX	 	Light - Medium

* This is the temperature of the water in the thermoblock. It is therefore not the temperature of the beverage in the cup or the temperature of the beverage at the moment of release from the outlets of the filter holder.

5. MAKING MILK BEVERAGES

5.1 Frothing the milk

1. Fill the jug (C10) with the amount of milk to be warmed/frothed, bearing in mind that the volume of the milk will increase 2- or 3-fold (fig. 22). For a denser and more evenly distributed froth, best results will be achieved using whole cow's milk at refrigerator temperature (about 5 °C).

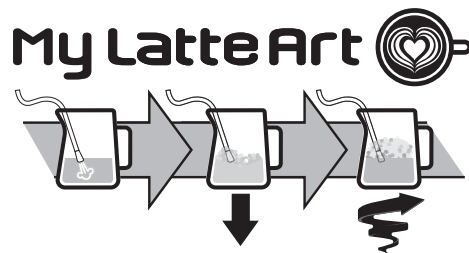

2. To froth the milk, offer the nozzle of the steam wand (A6) to the surface of the liquid: this will allow air to mix with the milk and steam.
3. Keep the steam nozzle just in contact with the surface, taking care not to let in too much air and create unsuitably large bubbles.
4. Immerse the nozzle just beneath the surface of the milk: this will create a vortex in the liquid. Once the milk is heated to the desired temperature, turn off the steam and wait for the flow to stop completely before removing the milk jug from the machine.





Barista tips:

- **Fresh milk is best.** Always use fresh milk straight from the fridge.
- For best results, always replace the milk jug in the fridge when not in use.
- Whole milk ensures optimum results. The appearance and texture of froth depending on the nature of the dairy milk or vegetable beverages utilized.
- After frothing the milk, eliminate unwanted bubbles by swirling the jug gently.

Cleaning the steam wand:

1. Following use, always wipe the steam wand (fig. 23) with a cloth to remove residual deposits of milk. The recommended procedure for in-depth cleaning is to use Eco MultiClean: this product ensures maximum hygiene by removing milk proteins and fats, and can be used for cleaning the entire machine.
2. Release steam for a few seconds to clean the wand (fig. 12).
3. Wait until the steam wand has cooled down: to ensure the wand works efficiently over time, use the special cleaning tool (C11) to free the 3 holes (fig. 24) of any obstruction.







6. CUSTOMISING THE QUANTITY OF COFFEE BEVERAGES WITH THE BUTTON (B7)

1. Prepare the appliance to deliver 1 or 2 cups of the coffee beverage you want to make, as far as attaching the filter holder (C1) complete with the (C2) or (C3) filter and ground coffee.
2. Turn the dial (B8) to select the beverage being programmed.
3. Press the  button: the light associated with the  button blinks.
4. Press the OK button to start delivery. The lights associated with the Ok and  buttons blink.
5. When the required quantity is reached, press OK. If the beverage includes another ingredient, the machine will start delivering this one as well: once the required quantity has been reached, press OK.
6. Press the  button to save. The appliance is now ready again for further use and the  light remains on.

If there is no wish to save the new setting, simply press any other button.

Please note:











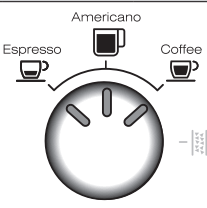

- Coffee beverages can be programmed, but the delivery of steam and hot water can not.
- Programming changes the quantity of beverage delivered, but not the quantity of ground coffee
- "2x" beverages can be programmed separately.
- **To restore the default factory settings, press and hold the  button until the light goes off. The selected beverage reverts to the default quantity.**

Coffee recipe	Default quantity	Programmable quantity
 Espresso	35 ml	from 25 to 90 ml
 Espresso 2x	70 ml	from 50 to 180 ml
 Coffee	80 ml	from 50 to 120 ml
 Coffee 2x	160 ml	from 120 to 240 ml
 Americano	120 ml	<ul style="list-style-type: none"> • espresso: from 25 to 60 ml • water: from 25 to 120 ml
 Americano 2x	240 ml	<ul style="list-style-type: none"> • espresso: from 50 to 120 ml • water: from 50 to 240 ml

7. SETTINGS MENU

1. Enter the menu:

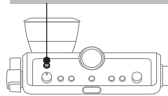

Press together and hold for 5 seconds	2x	
2. Settings selected with dial (B8)		
		
Corresponding setting	Turn to	Adjustments
Extra grinding adjustment	 Espresso	×2 → Range 1
		 → Range 2
Water hardness	 Americano	×2 → soft
		 → medium
		 → hard/very hard
Auto-off	 Coffee	×2 → 9 minutes
		 → 1.5 hours
		 → 3 hours
3. Settings selected with buttons		
Energy saving	 → Active	
	 → Off	
Default values	Press the button and hold for at least 5 seconds  , until the light remains permanently on	
4. Save the new settings by pressing ON/Standby (B1)		
 		











8. CLEANING THE APPLIANCE

Important!

- Do not use solvents, abrasive detergents or alcohol to clean the coffee machine.
- Do not use metal objects to remove encrustations or coffee deposits as they could scratch metal or plastic surfaces.
- Should the machine remain idle for more than a week, it is advisable to carry out a rinse cycle before preparing any beverages.

Danger!

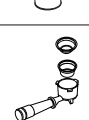

- Never immerse the coffee maker in water when cleaning: it is an electrical appliance.
- Before commencing any cleaning operation on the outside of the machine, turn it off, unplug it from the mains socket and wait for it to cool down.

					
	✗	✓	✓	✗	✗
	✓	✗	✗	✓	✓
	✗	✗	✗	✓	✓
	✗	✗	✗	✓	✓
	✗	✗	✓	✓	✗
	✗	✗	✗	✓	✓

8.1 Cleaning the coffee outlet

When  light comes on (orange) (B13), it means that the coffee circuit needs to be cleaned. This requires special cleaning tabs for coffee makers, which must be purchased separately. For more information, visit www.Delonghi.com.



- Insert the 1-cup filter (C2) in the holder (C1) (fig. 25).
- Position the cleaning accessory in the filter (C8) (fig. 25) and press home.
- Place the cleaning tab on the accessory (fig. 26).
- Attach the filter holder to the coffee outlet (A18).
- Fill the tank (A14) with water. Make sure the drip tray (A10) is empty.

- Press and hold the  button (B6) until the light  (B13) comes on. After a few minutes, the cleaning cycle stops automatically.
- Remove the filter holder and the cleaning accessory.
- Wash the filter holder and the filter under running water.
- Attach the filter holder again and run a rinse cycle by pressing the  button: it is advisable to place a container under the filter holder.
- Remove and empty the drip tray.

Please note:

This cleaning cycle can be initiated at any time by pressing the  button and holding for a few seconds. To cancel, press and hold the button for at least 10 seconds.

8.2 Cleaning the beans container housing

- Make sure the beans container (A2) is empty. If in doubt, operate the mill briefly to make certain.
- Release the container by turning it anticlockwise and detach it from the machine (fig. 27).
- Remove coffee residues using a vacuum cleaner (fig. 28).
- Clean the beans container housing with a moist cloth, and wipe dry (fig. 29);
- Reposition the beans container in the coffee mill. The container is correctly in place when the arrow  is aligned with the  symbol and a "click" is heard (fig.30).

8.3 Cleaning the burrs

When cleaning the beans container (A2), clean the container housing and the top burr with a moist cloth. If the burrs need to be removed and replaced, contact a service centre.

The burr can be removed in the event of the coffee mill being jammed by the presence of foreign matter. Should this occur, remove the beans container and proceed as follows:

- Attach the filter holder (C1) and operate the mill briefly without beans to free the internal duct.
- Turn the appliance off.
- Turn the grinding adjustment dial anticlockwise as far as it will go, which is the "REMOVE" position (fig. 31).
- Gripping the top burr by the handle, pull it up and out of the housing (fig.32).
- Clean the burr with a brush (fig. 33) and remove coffee residues using a vacuum cleaner (fig. 28).

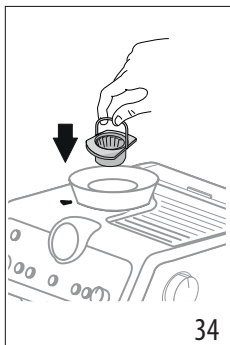
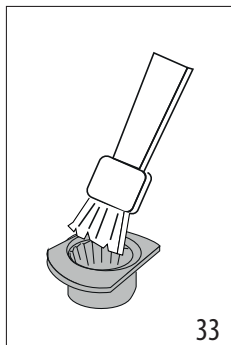

6. Replace the burr in the housing (fig. 34);
7. Turn the adjustment dial to select the desired grinding level (fig. 14);

Check that the burr is properly seated by pulling on the handle: if it is correctly in place, it will not move.

8.4 Replacing the burrs

When the quantity of ground coffee becomes less than expected, contact a service centre to have the burrs replaced: with the new burrs fitted, adjust the coffee mill by accessing the settings menu ("7. Settings menu") and selecting the first range of the "extra grinding adjustment" setting. Next, turn the ground coffee quantity adjustment dial (B2) to the MIN position and set the dose as for first-time use (see "The "perfect dose"").

8.5 Cleaning the "Smart tamping station"

1. Clean the attachment area with a brush (fig. 35).
2. Pull the lever (A20) down completely and clean the tamper with a brush (fig. 36), then release the lever.
3. Use the tube brush (C7) to clean the coffee funnel (fig. 37).

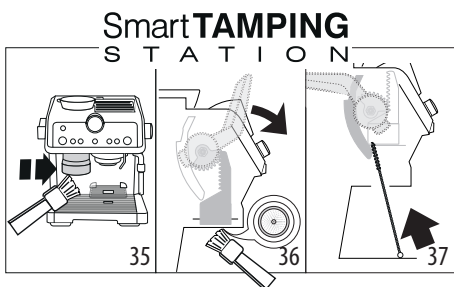

9. WATER HARDNESS

The descale light  (B9) comes on following a predetermined period of operation that depends on a water hardness setting. The machine can also be programmed according to the actual hardness of the local water supply, in which case descaling may be required less frequently.

1. Remove the "TOTAL HARDNESS TEST" indicator paper (C4) from its pack.
2. Immerse the paper completely in a glass of water for one second.
3. Remove the paper from the water and shake lightly. Set the machine accordingly, as indicated in the section "7. Settings menu".

Water Hardness Test Result	Button	Level
	×2	1 soft water
		2 medium water
		3 hard or very hard water

4. Set the machine accordingly, as indicated in the section "7. Settings menu".

10. HOW TO USE SOFTBALLS

Softballs (C9) are an innovative treatment system that prolongs the life of the machine, without altering the properties of the water, while ensuring consistently creamy and aromatic coffee. To optimize the effectiveness of the treatment, leave Softballs in the water overnight before use.

1. Take the sachet of Softballs from the wrapper (fig. 38).

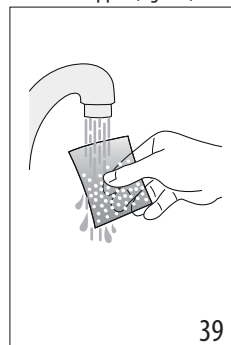
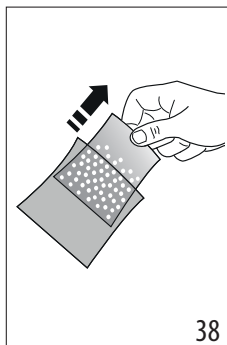

2. Rinse the sachet of Softballs under running water (fig. 39).
3. Immerse the sachet in the water tank (A14) (fig. 40).

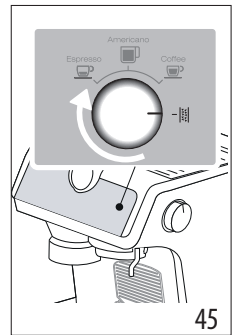
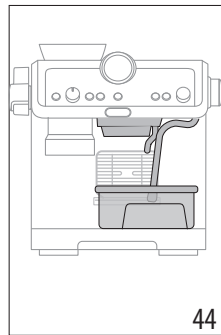
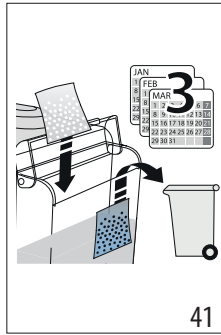
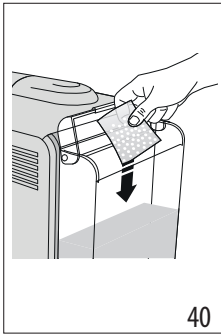

4. Change the sachet of Softballs every 3 months (fig. 41).

11. DESCALING

Important!

- Before using the descaler, (C5) read the instructions and the labelling on the pack.
- Use De'Longhi descaler only. Using unsuitable descaler products and/or performing the descale procedure incorrectly could give rise to faults not covered by the manufacturer's guarantee.
- Descaler can cause damage to delicate surfaces. If the product is accidentally spilt, dry immediately.

To descale	
Descaler	De'Longhi descaler
Container	Capacity 2 litres
Time	~40min

1. (REMOVE WATER SOFTENER AND SOFTBALLS, IF PRESENT). Pour the descaler into the water tank (A14) up to the first level A marked on the inside of the tank (which corresponds to the contents of one 100ml pack) (fig. 42).

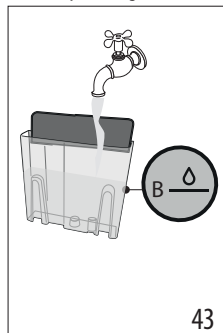
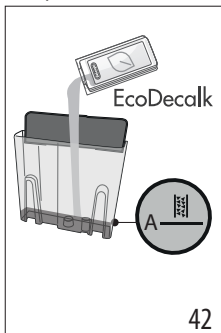

2. Add water up to level B (fig. 43). Now reposition the water tank in the machine.

3. Make sure that the filter holder (C1) is not attached. Position a container under the coffee outlet and the hot water spout, and another under the steam wand (A6) (fig. 44).

4. Turn the knob (B8) to (fig. 45): the OK light comes on, orange in colour and the light blinks.

5. Press the OK button: the OK light blinks.

6. The descaling programme starts and the descaler liquid comes out of the spouts. The descale programme removes limescale deposits from inside the appliance by automatically performing a series of rinses and pauses until the tank is empty.

Descaling ceases and the colour of the OK light turns to white. This means that a rinse cycle must be carried out:

7. Empty the containers used to collect the descaler solution and reposition them under the spouts.

8. Remove the water tank, empty out any residual descaler solution, rinse under running water and fill with fresh water up to the MAX level (fig. 46). Put the tank back in its housing.

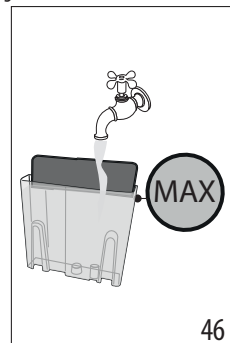

9. Press the OK button: the rinse cycle will start.
10. Once the rinse cycle has been completed, water will stop draining out and the machine is ready for use.

11. Empty the containers used to collect the rinse water.

12. Remove and empty the drip tray, then reposition it in the machine.









13. Remove the tank, fill with fresh water, and reposition in the machine.





The machine is now ready for use.







Please note:



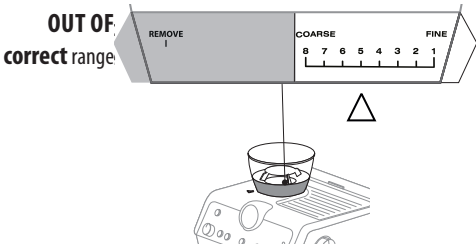

- The descaling cycle can be started up at any time (even if the relative light has not yet come on).
- Should descaling be started up by mistake, it can be stopped by pressing the OK button and holding for 10 seconds; the rinse cycle cannot be stopped.

12. EXPLANATION OF INDICATOR LIGHTS



LIGHTS	EXPLANATION OF LIGHTS	OPERATION
All lights blink briefly	Turning the machine on	Self-diagnosis
 permanently on	The machine has been turned on for the first time and the water circuit must be filled	Proceed as indicated in section “3. Setting up the appliance”
 permanently on (white) <ul style="list-style-type: none"> •  light: indicates the selected coffee temperature •  light: indicates the machine is ready to deliver hot water 	The machine is ready to deliver fluids	Set up the machine and proceed with preparation of the beverage
 permanently on	Energy saving is enabled	Refer to section “7. Settings menu” for instructions on disabling the function
 permanently on	The beans container (A2) is empty	Fill the beans container
 blinking	The grinding function has been selected, but the beans container (A2) is empty	Fill the beans container
 blinking momentarily at regular intervals	The dial (B2) has been set to the MAX adjustment	When the freshly ground coffee in the filter is not sufficient, select a new grinding range as indicated in section “6. Menu settings”.
 permanently on	There is not enough water in the tank (A14) or the tank is not correctly in place	Fill the tank with water, or remove the tank and reposition it correctly
		→

LIGHTS	EXPLANATION OF LIGHTS	OPERATION
 blinking	An attempt is being made to prepare a beverage, but with water tank (A14) empty	Fill the tank with water
	Because the beans are too finely ground, the coffee is delivered too slowly or not at all	Remove the filter holder (C1) and repeat the coffee-making steps, bearing in the mind the indications given in sections “4.1 Step 1 - Grinding” and “4.2 Step 2 - Tamping”
	The coffee filter (C2) or (C3) is obstructed	Rinse the filters under running water
	The tank (A14) is not properly in place and the relative valves are not open	Press down lightly on the tank to open the valves
	Limescale in the water circuit	Descale as described in section “11. Descaling”
 permanently on	The machine is ready to deliver steam	The machine is at the right temperature to deliver steam. To deliver steam from the wand, turn the steam dial (A4)
 blinking	The machine is switched on and energy saving is enabled. The steam dial (A4) is in the steam delivery position	The indicator light blinks to indicate that the machine is preparing to deliver steam. Delivery begins as soon as the steam circuit is up to temperature
	The machine is ready to deliver steam	The machine is at the right temperature to provide steam when the light remains permanently on
	The machine is delivering steam	
 permanently on	The beans container is not in place	Position the beans container (A2) correctly, or check that it is correctly in place The container is correctly in place when the arrow ▲ is aligned with the  symbol and a “click” is heard
→		

LIGHTS	EXPLANATION OF LIGHTS	OPERATION
 blinking	<p>The setting of the grinding level adjustment selector is incorrect, or beyond the maximum adjustment possible</p>	<p>Return the selector to one of the regular settings (between 1 and 8), remembering that:</p> <ul style="list-style-type: none"> • The grinding adjustment must be made with the mill in operation • The mill should be adjusted one level at a time, and used at least 5 times between one adjustment and the next
	<p>OUT OF correct range</p>  <p>Correct range</p>	
 permanently on	<p>The machine calls for tamping</p>	<p>The coffee has just been ground and the filter holder is attached to the coffee mill</p>
	<p>The filter holder has been detached from the coffee mill without tamping</p>	<p>Release the filter holder and proceed, tamping the coffee as described in section “The “perfect dose”” “When using pre-ground coffee:”</p>
	<p>The filter holder has been released with grinding incomplete, or the tamping step has occurred too quickly</p>	<p>Repeat the grinding step</p>
	<p>The coffee mill funnel is clogged</p>	<p>Clean as described in section “8.5 Cleaning the “Smart tamping station””. If the problem persists, access the funnel by opening the relative cover and clear the blockage using the tube brush</p>
	<p>The burrs are jammed by foreign matter</p>	<p>Remove the foreign matter and clean the burrs as indicated in section “8.3 Cleaning the burrs”.</p>
 permanently on (red)	<p>Descaling is required</p>	<p>Carry out descaling as described in section “11. Descaling”</p>
 blinks (red) +  blinks (orange)	<p>Descaling is in progress</p>	<p>Complete the operation as described in section “11. Descaling”</p>
 blinks (red) +  permanently on (white)	<p>Rinsing is required</p>	
→		

LIGHTS	EXPLANATION OF LIGHTS	OPERATION
 blinks (red) +  blinks (white)	Rinsing is in progress following completion of the descale cycle	
 permanently on (orange)	The coffee outlet requires cleaning	See section “8.1 Cleaning the coffee outlet”
 blinking (orange)	Cleaning of the coffee outlet is in progress	
All indicator lights blink	General alarm	Contact Customer Services

13. TROUBLESHOOTING

PROBLEM	CAUSE	SOLUTION
There is water in the drip tray (A10)	This water comes from the internal circuits of the machine and is a normal consequence of their operation	Empty and clean the drip tray on a regular basis
The machine fails to produce espresso coffee	No water in the tank (A14)	Fill the tank
	The  (B6) light is on, meaning that the coffee circuit or the steam circuit is empty	Press the button associated with the  light to fill the circuit
	Blockage in the coffee filter (C2) or (C3)	Rinse the filters under running water
	The tank (A14) is not properly in place and the valves at the bottom are not open	Press down lightly on the tank to open the valves at the bottom
	Limescale in the water circuit	Descale as described in section “11. Descaling”
	Coffee ground too finely	Remove the filter holder (C1) and repeat the coffee-making steps, bearing in the mind the indications given in sections “4.1 Step 1 - Grinding” and “4.2 Step 2 - Tamping”
The filter holder cannot be attached to the coffee outlet	The ground coffee has not been tamped or the quantity is excessive	Repeat the grinding step with different settings. Reduce the dosage quantity: check that the filter (C2) or (C3) (1 or 2 cups) and the grinding dosage are correctly matched (2x button (B3) selected or otherwise)
The espresso coffee drips from the edges of the filter holder (C1) instead of from the holes	The filter holder is not properly attached	Attach the filter holder correctly and rotate firmly as far as it will go
	The seal of the coffee outlet (A18) has lost flexibility or is dirty	Have the coffee outlet seal replaced by a Service Centre
	Blockage in the coffee filter (C2) or (C3)	Rinse the filters under running water
		➔

PROBLEM	CAUSE	SOLUTION
The espresso cream is too white (delivered from the spout too fast)	The machine settings need to be reappraised	Remove the filter holder and repeat the coffee-making steps, bearing in the mind the indications given in sections "4.1 Step 1 - Grinding" and "4.2 Step 2 - Tamping"
The espresso cream is too dark (delivered from the spout too slowly)	The machine settings need to be reappraised	Remove the filter holder (C1) and repeat the coffee-making steps, bearing in the mind the indications given in sections "4.1 Step 1 - Grinding" and "4.2 Step 2 - Tamping"
On completion of the descale cycle, the machine calls for a further rinse	During the rinse cycle, the water tank has not been filled to the MAX level	Repeat the rinse cycle (see section "11. Descaling")
The machine does not grind the coffee	Foreign matter has found its way into the coffee mill	Clean the burrs as described in section "8.3 Cleaning the burrs", making sure you remove all the beans from the beans container (A2) before extracting it. Before putting the burr back, vacuum all residues from the housing
	The beans container (A2) is not correctly positioned	The container is correctly in place when the arrow ▲ is aligned with the ☐ symbol and a "click" is heard
Changing to a different type of coffee	All beans currently in the machine must first be removed	<ul style="list-style-type: none"> • Empty the beans container (A2) (operating the coffee mill without beans or removing any beans still present with a vacuum cleaner) • Attach the filter holder (C1) and operate the mill a few times without beans to free the internal duct: now attach the filter holder to the coffee mill outlet (A19) aligning it with the INSERT mark, and turn it to the right. Grinding begins when the filter holder reaches the CLOSE position, then stops automatically. Repeat until the filter is empty • Fill the container (A2) with the new variety of coffee beans • If the amount of ground coffee does not give the perfect dose, proceed to set up the machine as for first-time use
		→

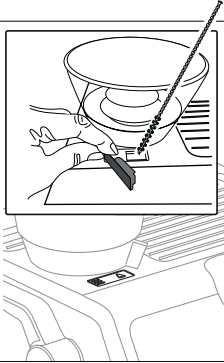
PROBLEM	CAUSE	SOLUTION
<p>After grinding, the coffee filter (C2) or (C3) is empty</p> <p>After grinding, there is too much coffee in the filter</p>	<p>The funnel of the coffee mill is clogged</p>	<p>Clean as described in section "8.5 Cleaning the "Smart tamping station"". If the problem persists, access the funnel by opening the relative cover (A21) and clear the blockage using the tube brush</p> 
<p>After grinding, the amount of coffee in the filter (C2) or (C3) does not give the "perfect dose"</p>	<p>The "Smart Tamping Station" needs cleaning</p> <p>The quantity of ground coffee needs adjusting</p> <p>Over time the burrs wear down</p>	<p>Clean as described in section "8.5 Cleaning the "Smart tamping station"", then repeat the grinding step</p> <p>Adjust the quantity of coffee with the dial (B2), following the instructions in section "The "perfect dose"". If the dial is already in the max. position, proceed as described in section "7. Settings menu" - "Extra grinding adjustment"</p> <p>Have the burrs replaced as indicated in section "8.4 Replacing the burrs".</p>

1. الوصف

1.1 وصف الجهاز - A

- A1. غطاء وعاء الحبوب
- A2. وعاء الحبوب
- A3. حامل فناجين القهوة
- A4. مقبض البخار
- A5. فوّهة صب الماء الساخن
- A6. أنبوب توزيع البخار
- A7. شبكة حمل فناجين الإسبرسو
- A8. شبكة حمل الكؤوب أو المعج
- A9. شبكة الحوض
- A10. وعاء تجميع قطرات الماء
- A11. مؤشّر مستوى الماء في حوض تجميع القطرات
- A12. غطاء خزّان الماء
- A13. مقبض استخراج خزان الماء
- A14. خزّان الماء
- A15. موضع مرشح تنقية الماء
- A16. مكان موصل كابل التيار الكهربائي
- A17. قاطع التيار العمومي (تشغيل/إيقاف "ON/OFF")
- A18. مؤرّج سكب القهوة
- A19. مخرج مطحنة البن (Tamping station)
- A20. ذراع الضغط
- A21. منفذ صغير للوصول إلى منزلق مطحنة البن

1.2 وصف لوحة التحكم - B

- B1. زر التشغيل/الاستعداد
- B2. مقبض ضبط كمية البن المطحون
- B3. الزر "X2": لاستخدام المرشح 2 للقهوة
- B4. زر "درجة الحرارة حرارة القهوة"
- B5. زر "OK": لإخراج المشروب/التأكيد
- B6. زر "سكب الماء الساخن"
- B7. زر "My": من أجل تخصيص طول المشروبات
- B8. مقبض اختيار الوظائف
 - Espresso
 - قهوة أمريكية
 - Coffee
 - إزالة الترسبات الكلسية
- B9. مؤشّر "إزالة الترسبات الكلسية"
- B10. مؤشّر "استعداد البخار"
- B11. مؤشّر "نقص حاوية حبوب القهوة"
- B12. مؤشّر "توفير الطاقة"
- B13. مؤشّر "النظافة" (انظر 8.1 تنظيف موزع سكب القهوة)
- B14. مؤشّر "حاوية حبوب القهوة فارغ"
- B15. مؤشّر "نقص الماء"
- B16. مؤشّر "الضغط"
- B17. مقياس الضغط

1.3 وصف الملحقات التشغيلية - C

- C1. كأس حامل المرشّح
- C2. مرشح 1 فنجان
- C3. مرشح 2 فنجان
- C4. شريط الاختبار «Total Hardness Test» (قسوة المياه)
- C5. مزيل الترسبات الجيرية
- C6. كابل تغذية قابل للإزالة
- C7. فرشاة تنظيف
- C8. ملحق تنظيف مؤرّج سكب القهوة
- C9. Softballs
- C10. حاوية الحليب
- C11. إبرة تنظيف لذرّاع البخار

1.4 الملحقات التشغيلية الخاصة بالتنظيف لا تأتي مع الجهاز

وهي موصى عليها من قبل الشركة المصنّعة

للحصول على مزيد من المعلومات حول ذلك، قمر بزيارة Delonghi.com.

قرص تنظيف

(انظر «8.1 تنظيف موزع سكب القهوة»)



المنظف EcoMultiClean

الرمز الشريطي: 8004399333307

2. إعداد الماكينة

اغسل جميع الملحقات بماء فاتر ومنظف أطباق، ثم اتبع الخطوات التالية:

1. أدخل وعاء الحبوب (A2) في مطحنة البن (الشكل 1). يتم إدخال الوعاء بشكل صحيح عندما يكون السهم ▲ محاذاً للرمز □ وتُسمع "نقرة" (الشكل 2).
2. أدخل صينية تجميع القطرات (A10) كاملة مع شبكة حمل الفناجين (A8) وشبكة الحوض (A9) (الشكل 3)؛
3. أزل خزان الماء (A14) (الشكل 4) وأعد ملئه بماء بارد ونظيف مع الانتباه إلى عدم تجاوز الكتابة MAX (الشكل 5).
4. ثم أعد إدخال الخزان.

تنبيه: لا تشغّل مطلقاً الجهاز بدون صب الماء أولاً في الخزّان أو بدون وجود خزان. اتبه جيّداً: يُسمح بتعديل في أسرع وقت ممكن درجة مستوى المعادن في الماء باتباع الإجراءات التي تُر وصفها بالتفصيل في فقرة «7. قائمة إعدادات الضغط».

3. استعمال الجهاز لأول مرة

1. أدخل موصل كابل التغذية (C6) في الموضع المخصص له (A16) خلف الجهاز (الشكل 6)؛ ثم أدخل القابس في مأخذ التيار. تحقق من الضغط على قاطع التيار العام (A17)، الموجود خلف الجهاز في الوضع I (الشكل 7)؛
2. ضع تحت صنوبر الماء الساخن (بجانب صنوبر القهوة (A18)) وعاءً لا تقل سعته عن 100 مل (الشكل 8)؛
3. اضغط الزر (B6) بمحاذاة مؤشّر (B) (الشكل 9): يبدأ صرف القهوة ويتوقف تلقائياً. قمر بإفراغ الحاوية.
- قبل البدء في استخدام الماكينة، يلزم شطف الدوائر الداخلية للماكينة. اتبع الخطوات التالية:
4. قمر بتثبيت كوب حامل المرشح مزوداً بمرشح (C1) بالماكينة: من أجل الحصول على التثبيت الصحيح، قمر بمحاذاة مقبض كوب حامل المرشح مع الرمز "INSERT" (الشكل 10) وأدر المقبض نحو اليمين، حتى محاذاة الوضع "CLOSE":

Register Now 
www.delonghi.com/register

