

# Dell Premier Multi-Device Wireless Keyboard and Mouse KM7321W



## User's Guide

Mouse Model: MS5320W  
Keyboard Model: KB700  
Regulatory Model: MS5320Wt/KB7221Wt



# Notes, Cautions, and Warnings

---

-  **NOTE:** A NOTE indicates important information that helps you make better use of your computer.
-  **CAUTION:** A CAUTION indicates potential damage to hardware or loss of data if instructions are not followed.
-  **WARNING:** A WARNING indicates a potential for property damage, personal injury, or death.

© 2021-2022 Dell Inc. or its subsidiaries. All rights reserved. Dell, EMC, and other trademarks are trademarks of Dell Inc. or its subsidiaries. Other trademarks may be trademarks of their respective owners.

2022-03

Rev. A01

# Contents

Notes, Cautions, and Warnings .....	2
What's in the box .....	5
Features .....	6
Wireless mouse.....	6
Wireless keyboard .....	7
Dell Peripheral Manager .....	9
Setting up your wireless mouse .....	10
Pairing your wireless mouse.....	13
Pairing your wireless mouse with a USB receiver .....	13
Pairing your wireless mouse using Bluetooth.....	14
Pairing device three using Bluetooth .....	17
Setting up your wireless keyboard .....	20
Pairing your wireless keyboard .....	22
Pairing your wireless keyboard with a USB receiver .....	22
Pairing your wireless keyboard using Bluetooth .....	24
Pairing device three using Bluetooth .....	27
Wireless keyboard specification .....	30
General .....	30
Electrical.....	30
Physical characteristics .....	31



Environmental.....31

Wireless mouse specification.....32

    General .....32

    Electrical.....32

    Physical characteristics .....33

    Environmental.....33

Troubleshooting .....34

Statutory Information .....37

    Warranty.....37

        Limited warranty and return policies.....37

        For U.S. customers:.....37

        For European, Middle Eastern and African customers: .....37

        For non-U.S. customers:.....37



# What's in the box

---

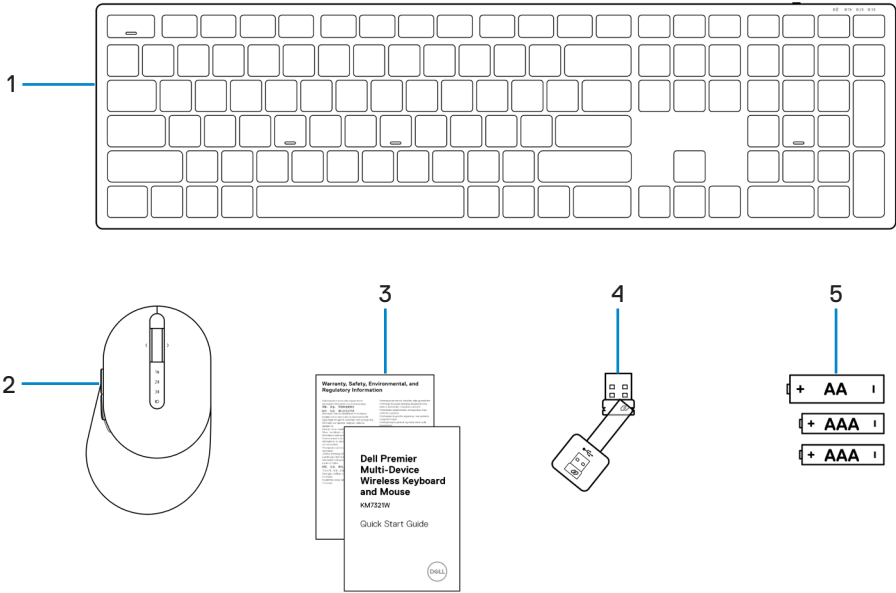

- 1 Wireless keyboard
- 2 Wireless mouse
- 3 Documents
- 4 USB receiver
- 5 Batteries  
(AA-type x1 and AAA-type x2)



# Features

---

## Wireless mouse

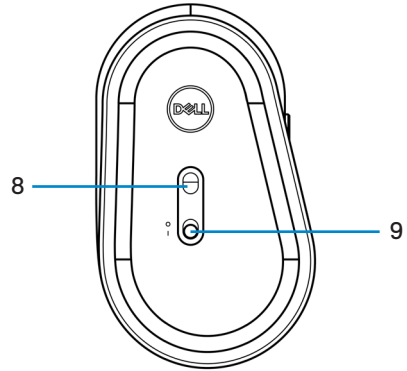
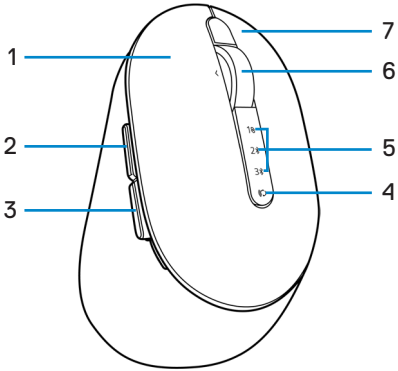

- 1 Left button
- 2 Forward button
- 3 Backward button
- 4 Connection-mode button
- 5 Connection-mode lights
- 6 Scroll wheel
- 7 Right button
- 8 Optical sensor
- 9 Power switch



# Wireless keyboard

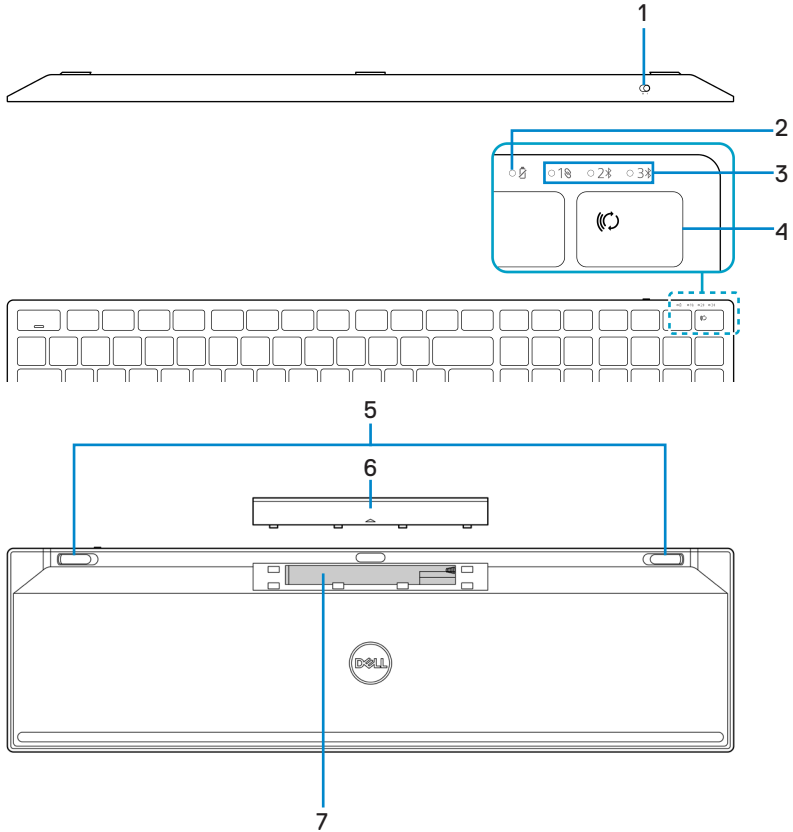

- 1 Power switch
- 2 Battery-status light
- 3 Connection-mode lights
- 4 Connection-mode button
- 5 Keyboard feet
- 6 Battery cover
- 7 PPID (Piece Part Identification) label





**NOTE: Caps/Num lock LED behavior:**

Both Lock LED will be “On” for 5 seconds once pressed and then goes “Off” even if user continues to type under current state. LED will only be “On” for 5 seconds again if user presses the Num Lock/ Caps Lock keys again. The lock state will also be reflected in the OSD (On Screen Display) if the Dell Peripheral Manager is installed on user’s PC.





# Dell Peripheral Manager

---

Dell Peripheral Manager software enables you to perform the following:

- Assign program shortcuts to device programmable buttons or keys through the Action tab.
- View device information such as firmware version and battery status through the Info tab.
- Upgrade the latest firmware updates on your devices.
- Pair additional devices through the radio frequencies (RF) USB receiver or directly to your computer through Bluetooth.

For more information, see *Dell Peripheral Manager User's Guide* on the product page at <https://www.dell.com/support>.



# Setting up your wireless mouse

---

- 1 Locate the slot on the side of the wireless mouse cover. Using your fingertip, pry open the wireless mouse cover.

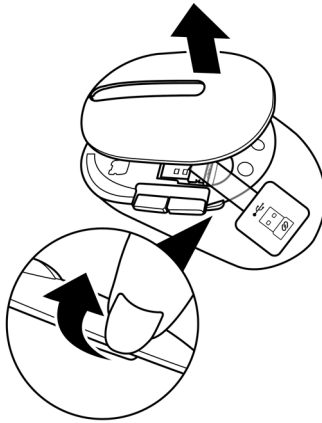

- 2 Remove the USB receiver from its compartment.

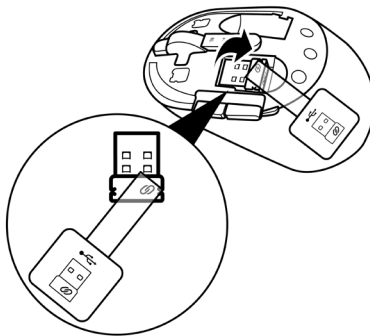

3 Install the AA battery into the battery compartment.

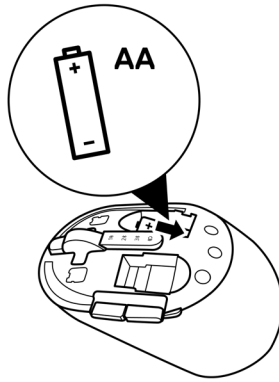

4 Replace the wireless mouse cover.

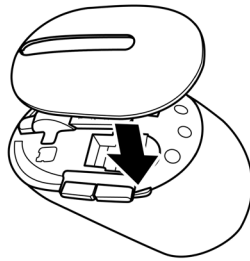

5 Slide the power switch down to turn on the wireless mouse.

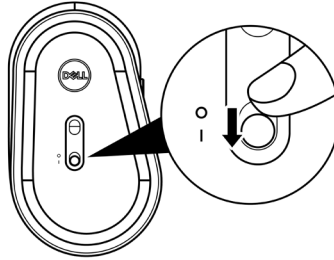

**NOTE:** Ensure that the distance between your computer and wireless mouse is within ten meters.



# Pairing your wireless mouse

Your Dell wireless mouse can be paired with devices using either the USB receiver or Bluetooth. You can pair and switch between a laptop, desktop, or any compatible mobile device.

## Pairing your wireless mouse with a USB receiver

**NOTE:** You can connect a device to your wireless mouse using the Dell Universal pairing.

1 Connect the Dell Universal USB receiver to the USB port on your computer.

**NOTE:** A USB Type-C to Type-A adapter (sold separately) is required if your computer does not support USB Type-A port.

**NOTE:** The RF (Radio Frequencies) device is pre-paired in the factory.

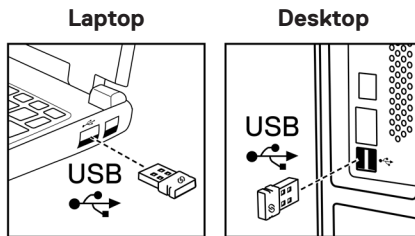

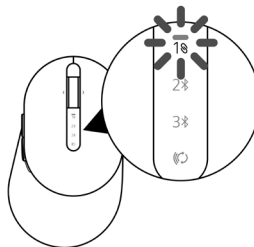

2 The connection-mode light (18) on the wireless mouse turns on to indicate the Dell Universal pairing, and then turns off.

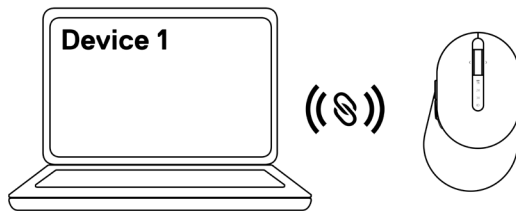

The wireless mouse is paired with your computer.



## Pairing your wireless mouse using Bluetooth

-  **NOTE:** You can connect up to two devices with your wireless mouse using Bluetooth.
-  **NOTE:** Before pairing your wireless mouse using Bluetooth, ensure that you unpair the inactive devices on your computer, and update the Bluetooth driver on your Dell computer to the latest version. For more information, see Drivers & Downloads at <https://www.dell.com/support>.

- 1 Press the connection-mode button a few times on your mouse until the connection-mode light (2 ✕ BLE-2; Bluetooth Low Energy-2) turns on, indicating that the second-Bluetooth connection is selected.

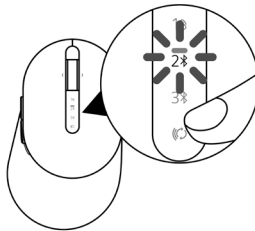

- 2 Press and hold the connection-mode button for 3 seconds to initiate pairing.  
The connection-mode light (2\*) blinks for 3 minutes, indicating your wireless mouse is in the pairing mode.

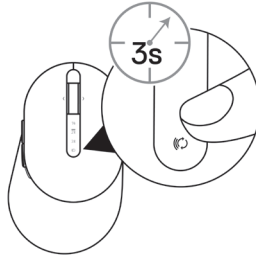

- 3 Pair your wireless mouse with your Bluetooth-enabled Windows computer.

**Swift Pair:**

- a. In Windows Search, type **Bluetooth**.
- b. Click **Bluetooth and other devices settings**. The **Settings** window appears.
- c. Ensure that the “Show notifications to connect using Swift Pair” box is checked.

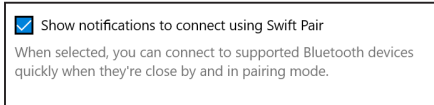

- d. Ensure that the Bluetooth is turned on.
- e. Place your wireless mouse near your computer. The **New Dell Mouse found** window appears.
- f. Click **Connect** and confirm the pairing process on both wireless mouse and your computer.

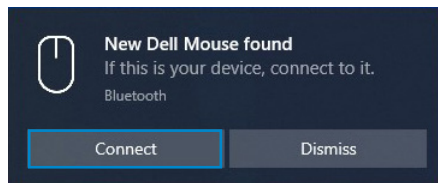

**Add Device:**

- a. In Windows Search, type **Bluetooth**.
- b. Click **Bluetooth and other devices settings**. The **Settings** window appears.
- c. Ensure that the Bluetooth is turned on.
- d. Click **Add Bluetooth or other device > Bluetooth**.
- e. From the list of available devices, click **Dell Mouse**.

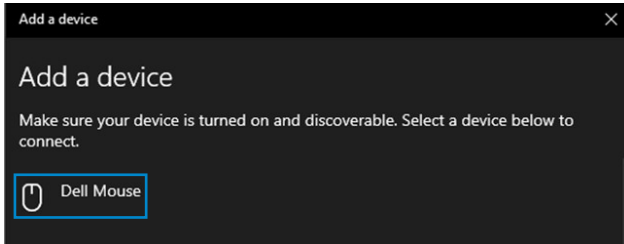

 **NOTE: If Dell Mouse is not listed, ensure that the pairing mode is enabled on the wireless mouse.**

- 4 Confirm the pairing process on both wireless mouse and your computer.

The connection-mode light (2\*) turns solid white for a few seconds to confirm the pairing, and then the light turns off. After your wireless mouse and computer pairing is completed, the wireless mouse connects to the computer automatically when the Bluetooth is enabled and both devices are within the Bluetooth range.

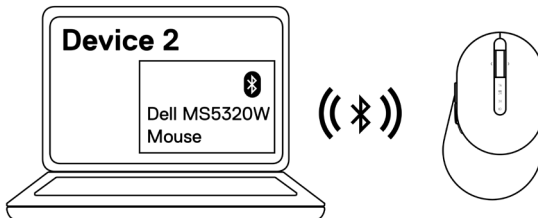
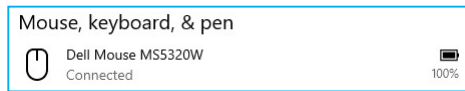



## Pairing device three using Bluetooth

 **NOTE:** You can connect a third device to your wireless mouse using Bluetooth.

 **NOTE:** Before pairing your wireless mouse using Bluetooth, ensure that you unpair the inactive devices on your computer, and update the Bluetooth driver on your Dell computer to the latest version. For more information, see Drivers & Downloads at <https://www.dell.com/support>.

- 1 Press the connection-mode button a few times on your mouse until the connection-mode light (3⌘ BLE-3; Bluetooth Low Energy-3) turns on, indicating that the third-Bluetooth connection is selected.

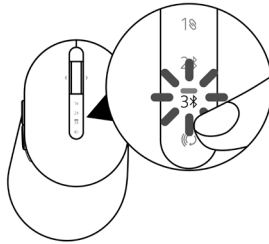

- 2 Press and hold the connection-mode button for 3 seconds to initiate pairing.  
The connection-mode light (3⌘) blinks for 3 minutes, indicating your wireless mouse is in the pairing mode.

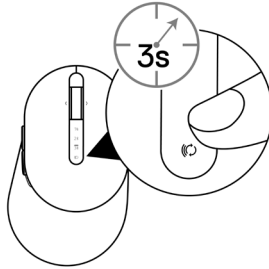

3 Pair your wireless mouse with your Bluetooth-enabled computer.

**Swift Pair:**

- a. In Windows Search, type **Bluetooth**.
- b. Click **Bluetooth and other devices settings**. The **Settings** window appears.
- c. Ensure that the “Show notifications to connect using Swift Pair” box is checked.

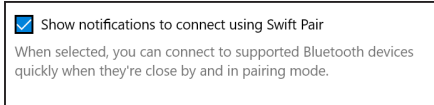

- d. Ensure that the Bluetooth is turned on.
- e. Place your wireless mouse near your computer. The **New Dell Mouse found** window appears.
- f. Click **Connect** and confirm the pairing process on both wireless mouse and your computer.

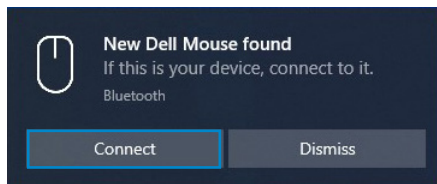

**Add Device:**

- a. In Windows Search, type **Bluetooth**.
- b. Click **Bluetooth and other devices settings**. The **Settings** window appears.
- c. Ensure that the Bluetooth is turned on.
- d. Click **Add Bluetooth or other device > Bluetooth**.
- e. From the list of available devices, click **Dell Mouse**.

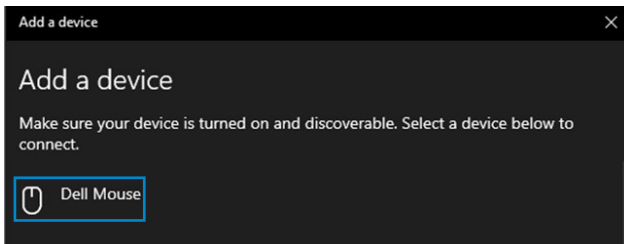

 **NOTE: If Dell Mouse is not listed, ensure that the pairing mode is enabled on the wireless mouse.**

4 Confirm the pairing process on both wireless mouse and your computer.

The connection-mode light (3) turns solid white for a few seconds to confirm the pairing, and then the light turns off. After your wireless mouse and computer pairing is completed, the wireless mouse connects to the computer automatically when the Bluetooth is enabled and both devices are within the Bluetooth range.

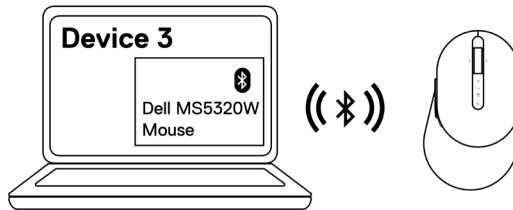
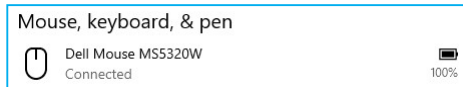

# Setting up your wireless keyboard

---

1 Remove the battery cover.

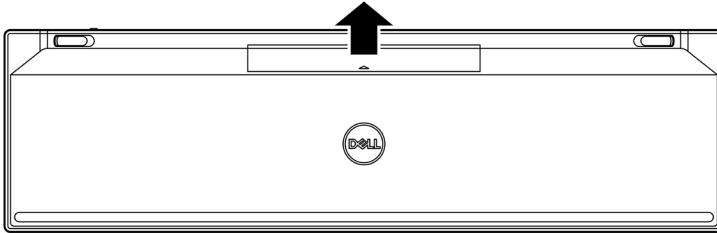

2 Install the AAA batteries into the battery compartment.

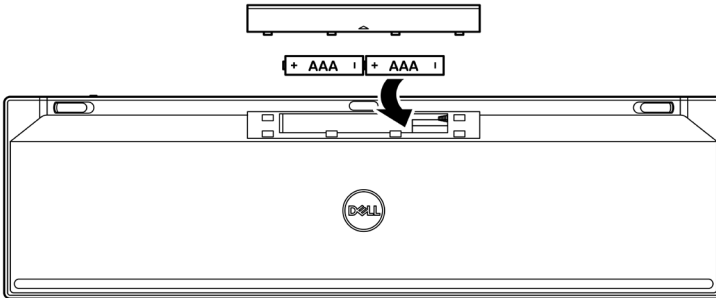

3 Replace the battery cover.

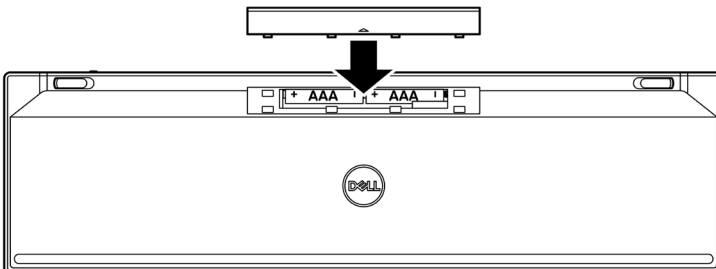

4 Slide the power switch to the right to turn on the wireless keyboard.

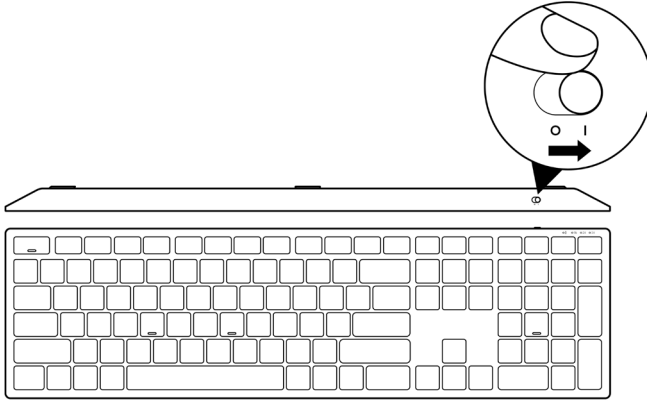

 **NOTE:** Ensure that the distance between your computer and wireless keyboard is within ten meters.



# Pairing your wireless keyboard

---

Your Dell wireless keyboard can be paired with devices using either the USB receiver or Bluetooth. You can pair and switch between a laptop, desktop, or any compatible mobile device.

## Pairing your wireless keyboard with a USB receiver

 **NOTE: You can connect a device to your wireless keyboard using the Dell Universal pairing.**

1 Connect the Dell Universal USB receiver to the USB port on your computer.

 **NOTE: A USB Type-C to Type-A adapter (sold separately) is required if your computer does not support USB Type-A port.**

 **NOTE: The RF device is pre-paired in the factory.**

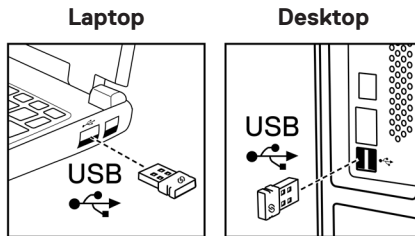

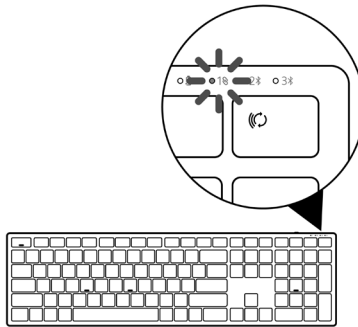

- 2 The connection-mode light (1Ⓢ) on the wireless keyboard is set to Dell Universal Pairing by default.

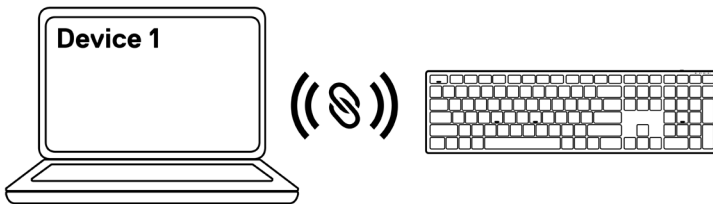

- 3 The wireless keyboard is paired with your USB device.



## Pairing your wireless keyboard using Bluetooth

-  **NOTE:** You can connect up to two devices with your wireless keyboard using Bluetooth.
-  **NOTE:** Before pairing your wireless keyboard using Bluetooth, ensure that you unpair the inactive devices on your computer, and update the Bluetooth driver on your Dell computer to the latest version. For more information, see Drivers & Downloads at <https://www.dell.com/support>.

- 1 Press the connection-mode button a few times on your keyboard until the connection-mode light (2⌘ BLE-2) turns on, indicating that the second-Bluetooth connection is selected.

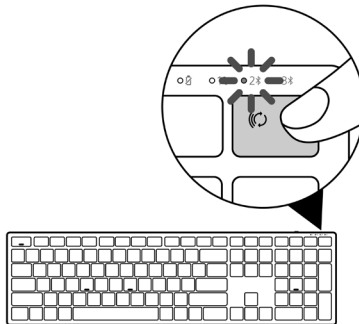

- 2 Press and hold the connection-mode button for 3 seconds to initiate pairing.  
The connection-mode light (2⌘) blinks for 3 minutes, indicating your wireless keyboard is in the pairing mode.

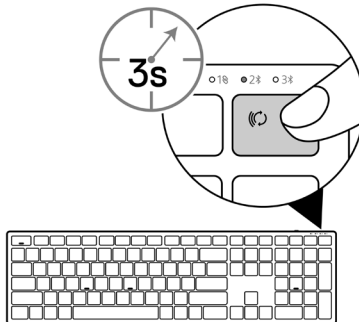



3 Pair your wireless keyboard with your Bluetooth-enabled computer.

**Swift Pair:**

- a. In Windows Search, type **Bluetooth**.
- b. Click **Bluetooth and other devices settings**. The **Settings** window appears.
- c. Ensure that the “Show notifications to connect using Swift Pair” box is checked.

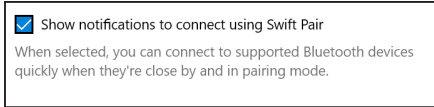

- d. Ensure that the Bluetooth is turned on.
- e. Place your wireless keyboard near your computer. The **New Dell Keybd found** window appears.
- f. Click **Connect** and confirm the pairing process on both wireless keyboard and your computer.

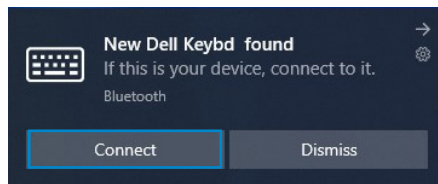

**Add Device:**

- a. In Windows Search, type **Bluetooth**.
- b. Click **Bluetooth and other devices settings**. The **Settings** window appears.
- c. Ensure that the Bluetooth is turned on.
- d. Click **Add Bluetooth or other device > Bluetooth**.
- e. From the list of available devices, click **Dell Keybd**.

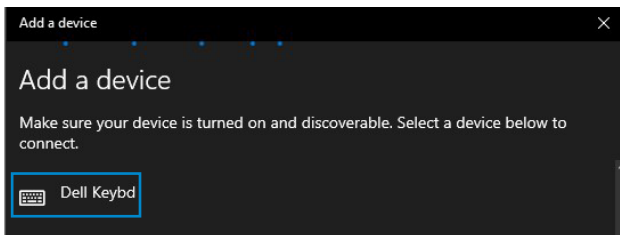



 **NOTE: If Dell Keybd is not listed, ensure that the pairing mode is enabled on the wireless keyboard.**

4 Confirm the pairing process on both wireless keyboard and your computer.

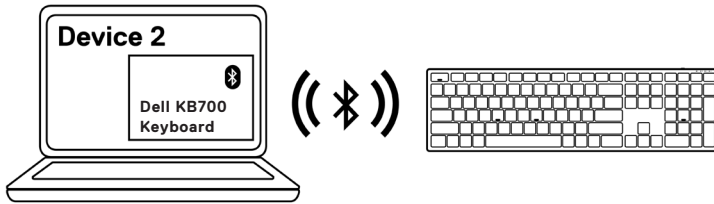
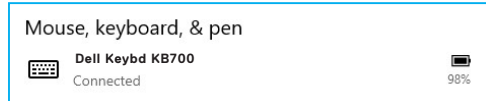
The connection-mode light (2\*) turns solid white for a few seconds to confirm the pairing, and then the light turns off. After your wireless keyboard and computer pairing is completed, the wireless keyboard connects to the computer automatically when the Bluetooth is enabled and both devices are within the Bluetooth range.



## Pairing device three using Bluetooth

-  **NOTE:** You can connect a third device to your wireless keyboard using Bluetooth.
-  **NOTE:** Before pairing your wireless keyboard using Bluetooth, ensure that you unpair the inactive devices on your computer, and update the Bluetooth driver on your Dell computer to the latest version. For more information, see Drivers & Downloads at <https://www.dell.com/support>.

- 1 Press the connection-mode button a few times on your keyboard until the connection-mode light (3⌘ BLE-3) turns on, indicating that the third-Bluetooth connection is selected.

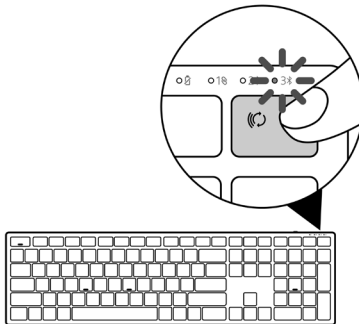

- 2 Press and hold the connection-mode button for 3 seconds to initiate pairing.  
The connection-mode light (3⌘) blinks for 3 minutes, indicating your wireless keyboard is in the pairing mode.

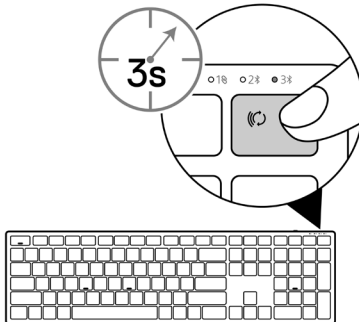

3 Pair your wireless keyboard with your Bluetooth-enabled computer.

**Swift Pair:**

- a. In Windows Search, type **Bluetooth**.
- b. Click **Bluetooth and other devices settings**. The **Settings** window appears.
- c. Ensure that the “Show notifications to connect using Swift Pair” box is checked.

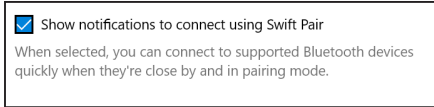

- d. Ensure that the Bluetooth is turned on.
- e. Place your wireless keyboard near your computer. The **New Dell Keybd found** window appears.
- f. Click **Connect** and confirm the pairing process on both wireless keyboard and your computer.

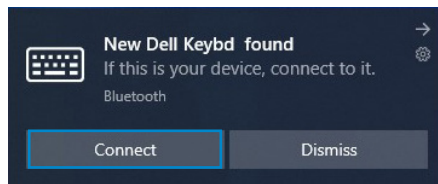

**Add Device:**

- a. In Windows Search, type **Bluetooth**.
- b. Click **Bluetooth and other devices settings**. The **Settings** window appears.
- c. Ensure that the Bluetooth is turned on.
- d. Click **Add Bluetooth or other device > Bluetooth**.
- e. From the list of available devices, click **Dell Keybd**.

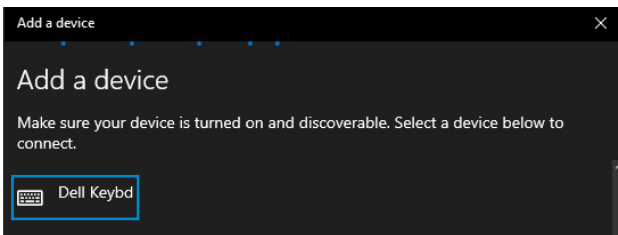

 **NOTE: If Dell Keybd is not listed, ensure that the pairing mode is enabled on the wireless keyboard.**

4 Confirm the pairing process on both wireless keyboard and your computer.

The connection-mode light (3\*) turns solid white for a few seconds to confirm the pairing, and then the light turns off. After your wireless keyboard and computer pairing is completed, the wireless keyboard connects to the computer automatically when the Bluetooth is enabled and both devices are within the Bluetooth range.

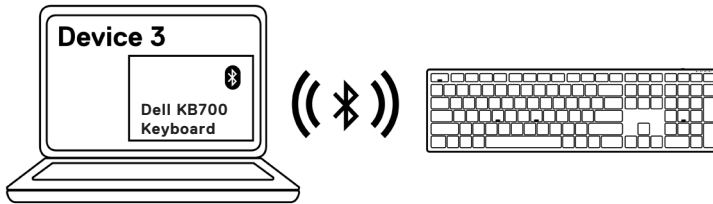
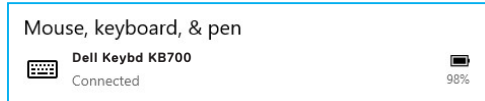

# Wireless keyboard specification

---

## General

Wireless keyboard model number	KB700
RF protocol	<ul style="list-style-type: none"><li>• Bluetooth 5.0 LE (supports Microsoft Swift Pair)</li><li>• 2.4 GHz RF</li></ul>
Encryption technology	AES 128 bits and AES-CCM
Operating range	<ul style="list-style-type: none"><li>• 10 m radio range</li><li>• No performance degradation up to max. radio range (10 m)</li><li>• Performance to be in par with or better than Dell existing shipping wireless keyboard and mouse. Dell will provide a benchmark reference product.</li></ul>
Supported operating systems (2.4 GHz)	<ul style="list-style-type: none"><li>• Windows 11/10/8/7/XP/Vista Server 2003/Server 2008/Server 2012</li><li>• Linux Ubuntu 18 and Redhat 8 Enterprise, Free DOS</li><li>• Chrome and Android</li><li>• MAC OS</li></ul>
Supported operating systems (Bluetooth)	<ul style="list-style-type: none"><li>• Windows 11/10/8</li><li>• Chrome and Android</li><li>• MAC OS</li></ul>

## Electrical

Operating voltage	2.0 V - 3.2 V
Battery required	Two AAA alkaline
Radio transmission	Bi-directional communication
Transmission range	Up to 10 m



## Physical characteristics

Weight (without battery)	540 g
Weight (with battery)	561 g
Dimensions:	
Length	433.30 mm (17.05 in.)
Width	121.50 mm (4.78 in.)
Height	28.36 mm (1.11 in.)

## Environmental

Temperature:	
Operating	0°C to 40°C (32°F to 104°F)
Storage	-40°C to 65°C (-40°F to 149°F)
Storage humidity	95% maximum relative humidity; non-condensing



# Wireless mouse specification

---

## General

Wireless mouse model number	MS5320W
RF protocol	<ul style="list-style-type: none"><li>• Bluetooth 5.0 LE (supports Microsoft Swift Pair)</li><li>• 2.4 GHz RF</li></ul>
Encryption technology	AES 128 bits and AES-CCM
Operating range	<ul style="list-style-type: none"><li>• 10 m radio range</li><li>• No performance degradation up to max. radio range (10 m)</li><li>• Performance to be in par with or better than Dell existing shipping wireless keyboard and mouse. Dell will provide a benchmark reference product.</li></ul>
Supported operating systems (2.4 GHz)	<ul style="list-style-type: none"><li>• Windows 11/10/8/7/XP/Server 2008/Server 2012</li><li>• Linux Ubuntu 18 and Redhat 8 Enterprise, Free DOS</li><li>• Chrome and Android</li><li>• MAC OS</li></ul>
Supported operating systems (Bluetooth)	<ul style="list-style-type: none"><li>• Windows 11/10/8</li><li>• Chrome and Android</li><li>• MAC OS</li></ul>

## Electrical

Operating voltage	0.9 V – 1.6 V
Battery required	One AA alkaline
Radio transmission	Bi-directional communication
Transmission range	Up to 10 m





## Physical characteristics

Weight (without battery)	86.7 g
Weight (with battery)	110 g
Dimensions:	
Length	114.5 mm (4.50 in.)
Width	70.0 mm (2.75 in.)
Height	41.6 mm (1.63 in.)

## Environmental

Temperature:	
Operating	0°C to 40°C (32°F to 104°F)
Storage	-40°C to 65°C (-40°F to 149°F)
Storage humidity	95% maximum relative humidity; non-condensing



# Troubleshooting

---

Problems	Possible solutions
Unable to use the wireless mouse/ wireless keyboard	<ol style="list-style-type: none"><li>1 Check if the battery is inserted correctly. Battery “+” and “-” ends should follow those indicated on the battery compartment label.</li><li>2 Check the battery level.<ul style="list-style-type: none"><li>• If the wireless mouse uses a rechargeable battery, ensure that the battery is fully charged.</li><li>• If the battery is exhausted, replace it with a new one.</li></ul></li><li>3 Turn the wireless mouse/wireless keyboard off, and then turn it on again. Check if the battery-status light is flashing amber, indicating that the battery power is low. If the battery is fully depleted, the battery-status light will not turn on.</li><li>4 Ensure that the USB receiver is directly connected to your computer. Avoid using the port replicators, USB hubs, and so on.</li><li>5 Change the USB port. Insert the USB receiver into another USB port on your computer.</li><li>6 Update the Bluetooth driver on your computer:<ol style="list-style-type: none"><li>a) Open the web browser and download the latest Bluetooth drivers from <a href="https://www.dell.com/support">https://www.dell.com/support</a>.</li><li>b) Restart your computer.</li></ol></li></ol>



Problems	Possible solutions
<p>Unable to pair the wireless mouse/wireless keyboard to the computer using Bluetooth</p>	<ol style="list-style-type: none"> <li>1 Check the battery level. <ul style="list-style-type: none"> <li>• If the wireless mouse/wireless keyboard uses a rechargeable battery, ensure that the battery is fully charged.</li> <li>• If the battery is exhausted, replace it with a new one.</li> </ul> </li> <li>2 Turn the wireless mouse/wireless keyboard off, and then turn it on again. Check if the battery-status light is flashing amber, indicating that the battery power is low. If the battery is fully depleted, the battery status light will not turn on.</li> <li>3 Restart your computer.</li> <li>4 Check the operating system is Windows 11/Windows 10/Windows 8/ Chrome/Android.</li> <li>5 Ensure that the wireless mouse/wireless keyboard is set to Bluetooth Low Energy (BLE) mode in your computer. For more information, see the documentation that came with your computer.</li> </ol>
<p>Wireless mouse pointer does not move</p>	<ol style="list-style-type: none"> <li>1 Check the battery level. <ul style="list-style-type: none"> <li>• If the wireless mouse uses a rechargeable battery, ensure that the battery is fully charged.</li> <li>• If the battery is exhausted, replace it with a new one.</li> </ul> </li> </ol>
<p>Left/right buttons do not work</p>	<ol style="list-style-type: none"> <li>2 Turn the wireless mouse off, and then turn it on. Check if the battery-status light is flashing amber ten times, indicating that the battery power is low. If the battery is fully depleted, the battery-status light will not turn on.</li> <li>3 Restart your computer.</li> </ol>



<b>Problems</b>	<b>Possible solutions</b>
Unable to pair the wireless mouse/wireless keyboard with the computer	<ol style="list-style-type: none"> <li>1 Check the battery level. <ul style="list-style-type: none"> <li>• If the wireless mouse/wireless keyboard uses a rechargeable battery, ensure that the battery is fully charged.</li> <li>• If the battery is exhausted, replace it with a new one.</li> </ul> </li> <li>2 Turn the wireless mouse/wireless keyboard off, and then turn it on again. Check if the battery-status light is flashing amber, indicating that the battery power is low. If the battery is fully depleted, the battery-status light will not turn on.</li> <li>3 Restart your computer.</li> </ol>
Wireless connection is lost	<ol style="list-style-type: none"> <li>1 Ensure that the USB receiver is connected directly to your computer. Avoid using the port replicators, USB hubs, and so on.</li> <li>2 Change the USB port. Insert the USB receiver into another USB port on your computer.</li> </ol>



# Statutory information

---

## Warranty

### Limited warranty and return policies

Dell-branded products carry a three-year limited hardware warranty. If purchased together with Dell system, it will follow the system warranty.

#### For U.S. customers:

This purchase and your use of this product are subject to Dell's end user agreement, which you can find at [Dell.com/terms](https://www.dell.com/terms). This document contains a binding arbitration clause.

#### For European, Middle Eastern and African customers:

Dell-branded products that are sold and used are subject to applicable national consumer legal rights, the terms of any retailer sale agreement that you have entered into (which will apply between you and the retailer) and Dell's end user contract terms.

Dell may also provide an additional hardware warranty – full details of the Dell end user contract and warranty terms can be found by going to [Dell.com/terms](https://www.dell.com/terms), selecting your country from the list at the bottom of the “home” page and then clicking the “terms and conditions” link for the end user terms or the “support” link for the warranty terms.

#### For non-U.S. customers:

Dell-branded products that are sold and used are subject to applicable national consumer legal rights, the terms of any retailer sale agreement that you have entered into (which will apply between you and the retailer) and Dell's warranty terms. Dell may also provide an additional hardware warranty – full details of Dell's warranty terms can be found by going to [Dell.com](https://www.dell.com), selecting your country from the list at the bottom of the “home” page and then clicking the “terms and conditions” link or the “support” link for the warranty terms.

