

C450HD IP Phone – Teams Compatible

Version 3.4.3



Table of Contents

1	Introduction	11
1.1	Highlights	11
1.2	Unified Communications	11
1.3	Management	11
2	Setting up the Phone.....	13
2.1	Unpacking	13
2.2	Device Description	14
2.2.1	Front View	14
2.2.2	Rear View	16
2.3	Cabling.....	17
2.4	Mounting the Phone	18
2.4.1	Desktop Mounting	18
2.4.2	Mounting the Expansion Unit on a Desktop.....	18
2.4.2.1	Routing the Handset Cable.....	18
2.4.3	Wall Mounting	19
3	Getting Started.....	21
3.1	Getting Acquainted with the Phone's Touch Screen	21
3.2	Softkeys	22
3.3	Navigating the Phone Menu	24
3.4	Inputting Data using the Virtual QWERTY Keyboard.....	26
3.5	Selecting an Alphanumerical Mode	27
3.6	Signing In.....	29
3.6.1	Signing in with PIN Code	29
3.6.2	Signing in with User Name and Password.....	30
3.6.3	Signing in with the Web Sign-in (Cloud) Option.....	31
3.6.4	Signing in using the Web Login Option	31
3.6.4.1	Users with IP Phone Manager Pro / Express Version 7.4.3000 or Earlier	33
3.7	Signing in as a Common Area Phone (CAP) User	34
3.8	Signing Out	37
3.8.1	Signing out if the 'Sign out' Softkey is Removed from the Touch Screen	37
3.9	Connecting to Wi-Fi.....	41
3.10	Hot Desking	43
3.11	Viewing Process Messages Displayed in the Screen	44
4	Using the Phone's Automatic Lock Feature.....	45
4.1	Enabling the Feature.....	45
4.2	Unlocking a Locked Phone.....	46
4.3	Manually Changing the Lock Code.....	46
4.4	Dialing Emergency Numbers if the Phone is Locked	48
4.5	Using Other Functionalities if the Phone is Locked	48
5	Customizing Your Phone.....	49
5.1	Changing the Screen Language.....	49
5.2	Selecting Ring Tone.....	50
5.3	Displaying Contacts Pictures.....	51

- 5.4 Enabling Call Waiting 54
- 5.5 Managing Simultaneous Incoming Calls..... 54
 - 5.5.1 Configuring Busy on Busy 55
- 5.6 Configuring Call Forwarding..... 56
- 5.7 Making Sure the NTP Server is Enabled 58
- 5.8 Configuring Screen Brightness..... 60
- 5.9 Selecting an Answering Device..... 62
- 5.10 Viewing your Location Information 63
- 5.11 Uploading Logs to Microsoft Server 64
- 5.12 Configuring an Outbound Proxy..... 65
- 5.13 Adjusting Volume 66
 - 5.13.1 Adjusting Ring Volume 66
 - 5.13.2 Adjusting Tones Volume..... 66
 - 5.13.3 Adjusting Handset Volume 67
 - 5.13.4 Adjusting Speaker Volume 67
 - 5.13.5 Adjusting Headset Volume 68
- 5.14 Managing Phone Directories..... 69
 - 5.14.1 Accessing Directories..... 69
 - 5.14.2 Adding a Contact to the Personal Directory..... 70
 - 5.14.3 Editing Contact Information in the Personal Directory..... 72
 - 5.14.4 Deleting a Contact from the Personal Directory..... 73
 - 5.14.5 Adding a Person to Favorites after a Call with them is Logged 74
 - 5.14.6 Removing a Person from Favorites..... 75
 - 5.14.7 Adding a Distribution Group to Favorites..... 76
 - 5.14.8 Searching for a Contact in a Directory 77
- 5.15 Searching for a Contact in the Corporate Directory using T9..... 78
 - 5.15.1 Searching for a Contact Using A/a/1 Instead of T9..... 79
- 5.16 Configuring a Function Key as a Speed Dial 80
 - 5.16.1 Configuring Pause Dialing for a Speed Dial to an Ext. behind an IVR..... 81
 - 5.16.2 Deleting a Speed Dial..... 82
- 5.17 Configuring a Function Key as Speed Dial in the Expansion Module Screen 83
- 5.18 Configuring a Function Key as a Key Event 85
- 5.19 Configuring a Function Key for Direct Voice Dialing 87
- 5.20 Configuring a Function Key for Paging..... 88
- 5.21 Configuring a Function Key for Making a Discreet Call..... 90
- 5.22 Customized UI Experience..... 91
- 5.23 Deleting a Function Key 92
- 5.24 Changing your Presence Status..... 93
- 5.25 Viewing Microsoft Exchange Calendar in the Phone's Touch Screen..... 95
- 5.26 Receiving Meeting Reminders 96
 - 5.26.1 Displaying Calendar Meetings without Identifying Details 97
- 5.27 Determining Meeting Attendees' Presence Status..... 98
- 6 Performing Basic Operations 99**
 - 6.1 Using Audio Devices 99
 - 6.2 Checking Voice Quality 99
 - 6.3 Making Calls 100
 - 6.3.1 Dialing..... 101
 - 6.3.2 Redialing..... 102

6.3.3	Dialing a Missed Call	103
6.4	Answering Calls	104
6.5	Rejecting Incoming Calls.....	105
6.6	Silencing Incoming Calls	105
6.7	Ending an Established Call	106
6.8	Viewing Missed, Received and Dialed Calls.....	107
6.9	Reporting a Malicious Call.....	109
7	Performing Advanced Operations	111
7.1	Answering Waiting Calls	111
7.2	Placing Calls On Hold	113
7.3	Handling Multiple Incoming Calls	113
7.4	Using a Speed Dial to Call a Contact	114
7.5	Accessing Speed Dials when in a Call	115
7.6	Making a Call in Discreet Mode.....	116
7.7	Transferring Calls.....	117
7.7.1	Performing a Blind Transfer.....	117
7.7.2	Performing a Consultative Transfer.....	118
7.7.3	Performing a Semi-Consultative Transfer	119
7.7.4	Merging Calls	120
7.8	Parking a Call.....	121
7.9	Configuring Group Call Pickup (GCP).....	121
7.10	Initiating a Multi-Party Skype for Business Remote Conference.....	122
7.11	Muting Calls	127
7.12	Paging	128
7.12.1	Barge-in	128
7.12.2	Performing a Paging Call.....	128
7.12.3	Receiving an Incoming Paging Call.....	129
7.13	Switching between any Available Audio Device	131
7.14	Configuring a Default Audio Device.....	131
7.15	Configuring Bluetooth on the Phone.....	132
7.16	Setting up Better Together over Ethernet.....	135
7.16.1	Installing the BToE PC/Laptop Application	135
7.16.2	Making Sure BToE is Correctly Installed	143
7.16.3	Configuring the BToE TCP Port.....	143
7.16.4	Enabling BToE for Online Users	144
7.16.5	Automatically Pairing the BToE PC/Laptop Application with the Phone	144
7.16.6	Manually Pairing the BToE PC/Laptop Application with the Phone	145
7.16.6.1	Manually Generating a Pair Code	145
7.16.6.2	Manually Connecting the Phone with the BToE PC/Laptop Application	146
7.16.6.3	Connecting the Skype for Business Client with the Phone.....	149
7.16.7	Making Sure the Phone/ Skype for Business Client are Paired.....	149
7.16.7.1	Making Sure Skype for Business Client is Paired	149
7.16.7.2	Making Sure the Phone is Paired.....	150
7.17	Using BToE Functions	151
7.17.1	Signing in to the Phone from the Skype for Business Client	151
7.17.2	Making a Call (Click-to-Dial)	152
7.17.3	Answering a Call	152
7.17.4	Establishing a Unified Communications Call Conference	153
7.17.5	Transferring a Call.....	155
7.17.6	Switching the Primary Audio Device	155

7.17.7	Routing Voice from a Video Call to the Phone.....	157
7.18	Using the Boss Admin Feature.....	158
7.18.1	Viewing Admins and Bosses.....	158
7.18.2	Handling an Incoming Call for the Boss	159
7.18.3	Calling on Behalf of the Boss.....	160
7.18.3.1	Touching the Boss'  icon	160
7.18.3.2	Keying in the Destination Phone Number.....	161
7.18.3.3	Pressing the CONTACTS Key	161
7.18.4	Answering a Call on Boss' Phone	162
7.18.5	Admin Hands Off a Call to Boss.....	163
7.18.6	Boss Hands Off a Call to Admin.....	163
7.18.7	Boss Monitors Admins, Seizes a Call Put on Hold by an Admin	164
7.18.8	Admin Sees Who's Call Boss Answered	165
7.18.9	Admin Picks up a Call Answered by Boss, Put on Hold by Boss.....	166
7.18.10	Admin 1 Picks up a Call from Admin 2	166
7.18.11	Admin's Phone Notifies Called Party that Admin's Call is on Behalf of Admin's Boss	167
7.18.12	Admin Calling Boss	167
7.18.13	Admin Calling Someone on Behalf of Boss.....	167
7.19	Configuring Distinctive Ringing on Admin's Phone	168
7.19.1	Setting a Different Volume for Each Boss's Ringtone	168
7.20	Viewing and Playing Voicemail Messages	169
7.20.1	Sending an Incoming Call Directly to Voicemail	170
7.20.2	Calling a Contact's Voicemail Directly.....	170
7.20.3	Sending an Existing Call to My Voicemail	171
7.20.4	Sending an Existing Call with Contact X to the Voicemail of Contact Y.....	171
8	Troubleshooting	173
8.1	Uploading Logs to Microsoft Server for Support Purposes	174

List of Figures

Figure 2-1: Front View.....	14
Figure 2-2: Rear View.....	16
Figure 2-3: Cabling.....	17
Figure 3-1: Touch Screen in Idle State.....	21
Figure 3-2: Menu Screen.....	24
Figure 3-3: Menus.....	25
Figure 3-4: Alphanumerical Selection.....	27
Figure 3-5: Entering a Symbol (e.g., a dot).....	28
Figure 3-6: Reverting to Letters (e.g., abc).....	28
Figure 3-7: Enter the Web URL Displayed in the Phone Screen.....	32
Figure 3-8: Login.....	38
Figure 3-9: Web Interface – Home Page.....	38
Figure 3-10: Sign-in – Content Blocked Page.....	39
Figure 3-11: Sign-in – Windows Security Prompt.....	39
Figure 3-12: Windows Security Prompt.....	40
Figure 3-13: Sign-out.....	40
Figure 5-1: C450HD Phone with Speed Dials Configured in the Expansion Module Screen.....	83
Figure 5-2: Configuring a Speed Dial in the Expansion Module Screen.....	83
Figure 5-3: Selecting the Private Option in Microsoft Exchange.....	97
Figure 7-1: InstallShield Wizard – Preparing to Install.....	136
Figure 7-2: Welcome to the InstallShield Wizard.....	136
Figure 7-3: License Agreement.....	137
Figure 7-4: License Agreement.....	137
Figure 7-5: Destination Folder.....	138
Figure 7-6: Change Current Destination Folder.....	138
Figure 7-7: Ready to Install.....	139
Figure 7-8: Installing AudioCodes Better2Gether.....	139
Figure 7-9: InstallShield Wizard Completed.....	140
Figure 7-10: AudioCodes Icon in Taskbar.....	140
Figure 7-11: Control Panel>Programs>AudioCodes Better2Gether.....	141
Figure 7-12: Computer Management > Services and Applications.....	141
Figure 7-13: Device Manager > AudioCodes B2GoE USB Driver.....	142
Figure 7-14: Popup Menu.....	143
Figure 7-15: About AC BToE.....	143
Figure 7-16: TCP Port.....	143
Figure 7-17: AC BToE TCP Port.....	144
Figure 7-18: Popup Menu.....	146
Figure 7-19: Phone Pairing.....	146
Figure 7-20: AC BToE Failed Indication.....	146
Figure 7-21: AC BToE is Connected Indication.....	146
Figure 7-22: Popup Menu: 'Disconnect' Enabled, 'Phone Pairing' Disabled.....	147
Figure 7-23: BToE Disconnected.....	147
Figure 7-24: Popup Menu: BToE Disconnected.....	147
Figure 7-25: Start > Programs > AudioCodes > BToE Controller.....	148
Figure 7-26: Skype for Business Sign-in Request Prompt.....	149
Figure 7-27: Primary Device: Phone.....	155
Figure 7-28: Primary Device: Speaker.....	156
Figure 7-29: Primary Device: Headset.....	156

List of Tables

Table 2-1: Front View Description.....	14
Table 2-2: Rear View Description.....	16
Table 3-1: Touch Screen in Idle State	21
Table 3-2: Softkey Descriptions.....	22
Table 3-3: Menu Descriptions.....	24
Table 3-4: Displayed Messages Indicating Processes In Progress.....	44
Table 5-1: Screen Brightness Options.....	60
Table 5-2: Presence Statuses	93
Table 5-3: Meeting Status [Applies to Non-Microsoft Theme Screen].....	96
Table 7-1: Popup Menu Items – Touch to Activate	114
Table 7-2: Boss-Admin Icons	158
Table 8-1: Troubleshooting	173

Notice

Information contained in this document is believed to be accurate and reliable at the time of printing. However, due to ongoing product improvements and revisions, AudioCodes cannot guarantee accuracy of printed material after the Date Published nor can it accept responsibility for errors or omissions. Updates to this document can be downloaded from <https://www.audiocodes.com/library/technical-documents>.

This document is subject to change without notice.

Date Published: Apr-27-2020

Trademarks

AudioCodes Ltd. All rights reserved. AudioCodes, AC, HD VoIP, HD VoIP Sounds Better, IPmedia, Mediant, MediaPack, What's Inside Matters, OSN, SmartTAP, VMAS, VoIPerfect, VoIPerfectHD, Your Gateway To VoIP, 3GX, VocaNom, AudioCodes One Voice and CloudBond are trademarks or registered trademarks of AudioCodes Limited All other products or trademarks are property of their respective owners. Product specifications are subject to change without notice.

WEEE EU Directive

Pursuant to the WEEE EU Directive, electronic and electrical waste must not be disposed of with unsorted waste. Please contact your local recycling authority for disposal of this product.

Customer Support

Customer technical support and services are provided by AudioCodes or by an authorized AudioCodes Service Partner. For more information on how to buy technical support for AudioCodes products and for contact information, please visit our Web site at <https://www.audiocodes.com/services-support/maintenance-and-support>.

Stay in the Loop with AudioCodes



Abbreviations and Terminology

Each abbreviation, unless widely used, is spelled out in full when first used.

Documentation Feedback

AudioCodes continually strives to produce high quality documentation. If you have any comments (suggestions or errors) regarding this document, please fill out the Documentation Feedback form on our Web site at <http://online.audiocodes.com/documentation-feedback>.

Related Documentation

Document Name
400HD Series IP Phones Release Notes – Teams Compatible
400HD Series IP Phones Administrator’s Manual – Teams Compatible
C450HD IP Phone Quick Guide – Teams Compatible
400HD Series IP Phones for Skype for Business Hosting Partner (LHPv2) Environment Configuration Note

1 Introduction

AudioCodes' C450HD IP Phone is a high-end, executive phone model delivering high-definition enterprise voice within Skype for Business unified communications environments.

The main feature differentiating this model from the other IP phone models in AudioCodes' 400HD IP Phones Series is its large 5-inch color capacitive 1280 x 720 high-resolution touch (TFT) screen, with an intuitive touch-oriented user interface design. This touch screen user interface enables up to eight Function Keys with multi-lingual support.

The phone supports Gigabit Ethernet (two GbE interfaces are supported). The phone also features support for two USB ports for headset support and an optional expansion module. Skype for Business certification is pending.

1.1 Highlights

Highlighted features of the C450HD model are:

- One line, up to eight concurrent calls
- 5-inch color capacitive 1280 x 720 high-resolution touch (TFT) screen
- Highly intuitive, touch-oriented user interface enabling up to 8 Function softkeys and extensive unified communications functionality
- Multi-lingual support
- Expansion module support
- Skype for Business certification (pending)
- Conferencing and multi-call management, contacts' photos display, and more.
- High-definition call quality with SILK voice coder support
- Part of AudioCodes' IP phone management which defines it as an IT-managed entity.
- Two Gigabit Ethernet (GbE) interfaces supported - two USB ports for headset support, one USB headset at a time.
- Wireless connectivity:
 - Single band 2.4GHz, 802.11b/g/n Wi-Fi support

Note that Wi-Fi is supported in the USA, Canada, the European Union, Switzerland and Israel, and requires a specific CPN with a 'BW' suffix. The list of supported countries is dynamic. Contact your local AudioCodes representative for more information about regional availability and specific country type approvals of Wi-Fi.

Users can connect the phone to an Access Point via Wi-Fi when the phone is installed in an environment free of LAN/cables. See Section 3.9 for more information.

1.2 Unified Communications

Designed especially for use within unified communications environments, including Skype for Business Online, the C450HD provides built-in support for the industry's leading voice codecs, including SILK, to offer high voice quality even under poor network conditions.

1.3 Management

Along with the other members of the AudioCodes 400HD IP phone family, it can be deployed as part of a fully managed IP phone solution, with unique and complete centralized device life-cycle management courtesy of AudioCodes' IP phone management utilities for managing end-user desktop devices.

Read this *User's Manual* carefully to learn how to operate the product and take full advantage of its rich feature set.

This page is intentionally left blank.

2 Setting up the Phone

2.1 Unpacking

When unpacking, ensure that the following items are present and undamaged:

Phone / Stand

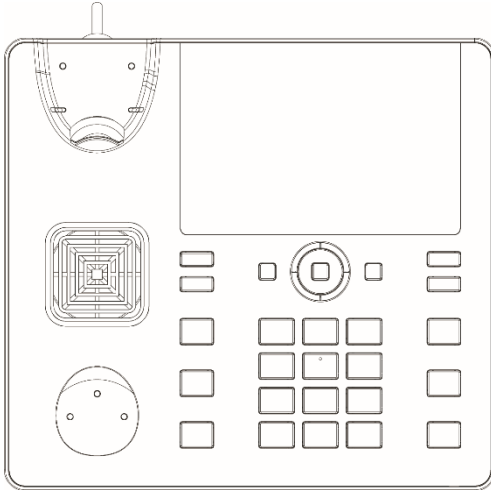

Handset / Cord

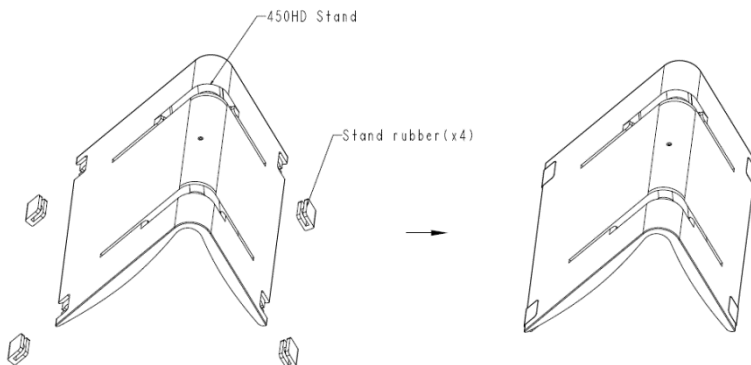

Cat 5e Ethernet Cable

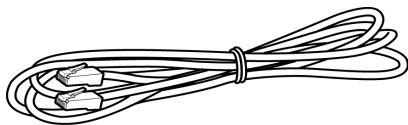

AC Power Adapter (Optional)

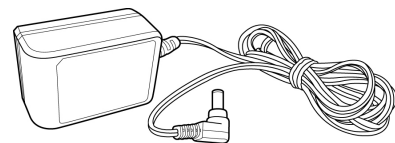

If anything appears to be missing or broken, contact the distributor from whom you purchased the phone for assistance.

2.2 Device Description

Use the graphics below to identify and familiarize yourself with the device's hardware functions.

2.2.1 Front View

The front view of the phone is shown in [Figure 2-1](#) and described in [Table 2-1](#).

Figure 2-1: Front View

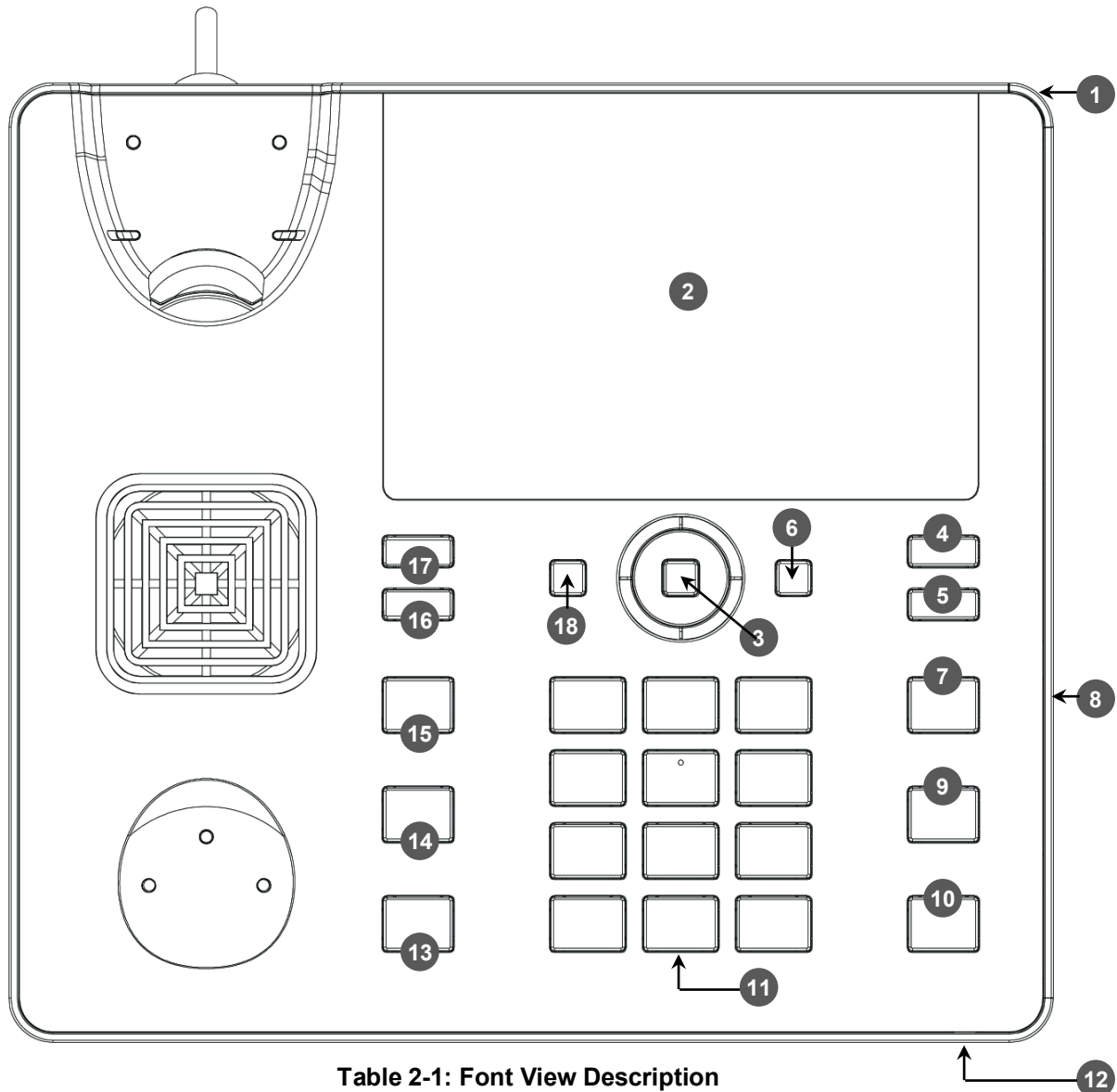

Table 2-1: Font View Description

Item #	Label/Name	Description
1	Ring LED	Indicates phone status: <ul style="list-style-type: none"> Green: Idle state Flashing blue: Incoming call (ringing) Red: Answered call
2	TFT touch screen	Thin Film Transistor touch screen, a type of LCD (Liquid Crystal Display) interactive screen which displays calling information and lets you configure phone features by touching the glass.
3	Navigation	<ul style="list-style-type: none"> Press the button's upper rim to scroll up menus/items in the touch screen.

Item #	Label/Name	Description
	Control / OK	<ul style="list-style-type: none"> ▪ Press the button's lower rim to scroll down. ▪ Press the button's left or right rim to move the cursor left or right (when editing a contact number for example). ▪ Press OK to select a menu/item/option.
4	Voicemail	Retrieves voicemail messages.
5	CONTACTS	Press to directly access the 'Favorites' directory. Other directories can be accessed from the 'Favorites' screen.
6	MENU	<p>Accesses menus:</p> <ul style="list-style-type: none"> ▪ Call Log ▪ Calendar ▪ Keys ▪ Settings ▪ Device Status ▪ Administration ▪ Favorites ▪ Log upload.
7	REDIAL	Accesses a list of recently dialed numbers; one can be selected to redial.
8	Kensington lock	Allows locking the device.
9	TRANSFER	Transfers a call.
10	HOLD	Places an active call on hold.
11	Alphanumeric Keypad	Keys for entering numbers, alphabetical letters and symbols (e.g., colons)
12	Microphone	Allows talking and listening. The network administrator can disable it if required.
13	SPEAKER	Activates the speaker, allowing a hands-free conversation.
14	HEADSET	Activates a call using an external headset.
15	MUTE	Mutes a call.
16	▲ VOL	Increases or decreases the volume of the handset, headset, speaker, ring tone and call progress tones.
17	▼ VOL	
18	x	Cancel an action, such as dialing a number, after beginning it.

2.2.2 Rear View

The rear view of the phone is shown in the figure below and described in the table below.

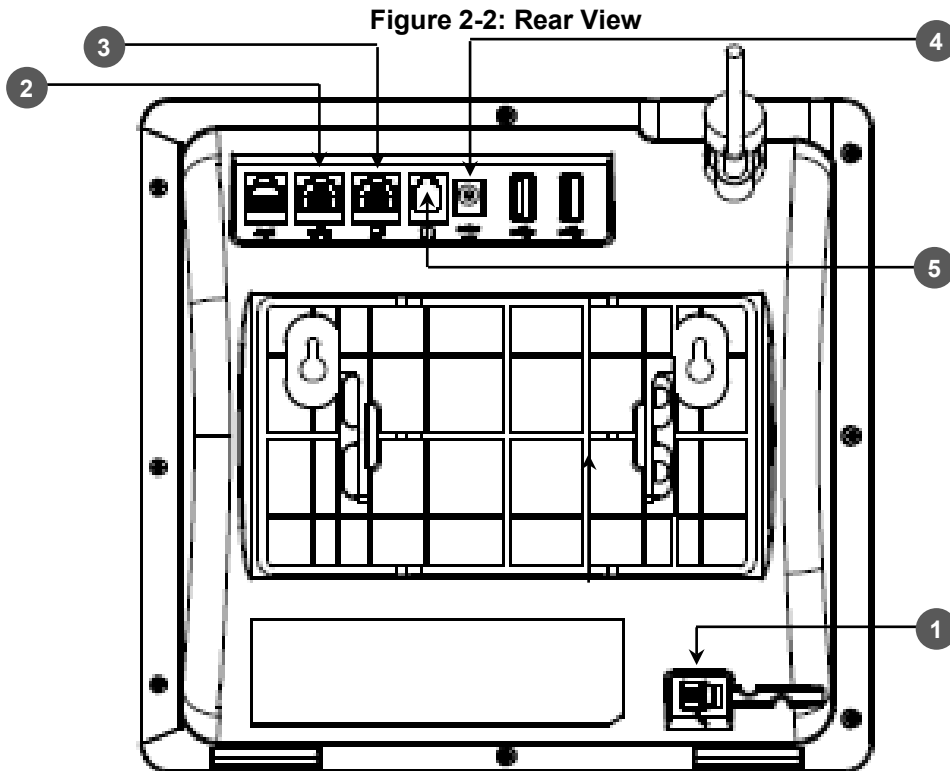







Table 2-2: Rear View Description

#	Label	Description
1		Handset jack, i.e., port RJ-9, to connect the handset.
2		RJ-45 port to connect to the Ethernet LAN cable for the LAN connection (uplink - 10/100/1000 Mbps). If you're using Power over Ethernet (PoE), power to the phone is supplied from the Ethernet cable (draws power from either a spare line or a signal line).
3		RJ-45 port to connect the phone to a PC (10/100/1000 Mbps downlink).
4	 DC12V	12V DC power jack that connects to the AC power adapter.
5		Headset jack, i.e., RJ-9 port that connects to an external headset.

2.3 Cabling

This section covers how to cable your phone. Use the figure and table below as reference.

Figure 2-3: Cabling

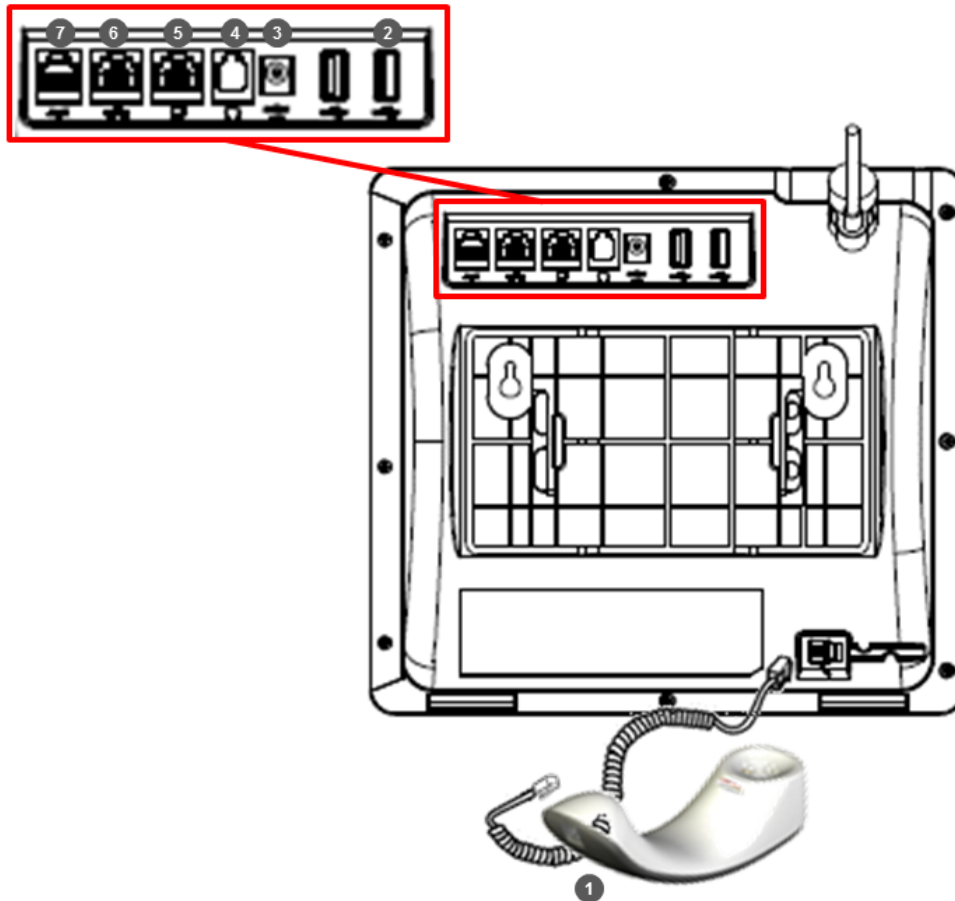

Action	Description
1	Connect the phone's RJ-9 port to the handset cord's <i>longer, straight end</i> . Connect the handset to the handset cord's <i>short, straight end</i> .
2	Connect one of the two USB ports to a headset [optional].
3	Connect the phone's power socket labelled DC 12V to the connector tip of the AC power adapter. Connect the two-prong AC adapter directly to the electrical wall outlet. When the phone powers up, all the LEDs momentarily light up.
4	Connect the phone's RJ-9 headset jack to a headset [optional]
5	Connect the RJ-45 PC port to a computer/laptop, using a CAT 5 / 5e straight-through Ethernet cable
6	Connect the phone's RJ-45 LAN port to your LAN network (LAN port or LAN switch/router) using a CAT 5 / 5e Ethernet cable.
7	Internal use only. FAEs use the port to debug and troubleshoot the phone - after connecting the AUX (auxiliary) port to a terminal monitor with a serial cable.



Note: If the LAN to which the phone is connected supports Power over Ethernet (PoE), no AC adapter is required; the phone receives power from the Ethernet network.



Prior to connecting power, refer to the Compliancy and Regulatory Information at www.audiocodes.com/library.

2.4 Mounting the Phone

The phone can be mounted on a:

- Desk (see Section 2.4.1 below)
- Wall (see Section 2.4.3)

See also <https://www.youtube.com/watch?v=oGe9STB9IFE> to assemble the base stand.

2.4.1 Desktop Mounting

This section shows how to mount the phone on a flat surface like a desk.

➤ **To mount the phone on a flat surface like a desk:**

1. Off-hook the handset (if on-hook) and place the phone upside down, i.e., base-up, on your desktop.
2. On the phone's stand, identify outer notches.
3. On the phone's base, identify outer rails.
4. Invert the stand and align its outer notches with the base's outer rails.
5. Insert the stand's outer notches into the base's outer rails and slide the notches along the rails until the stand click-locks into the base.
6. Revert the phone and stand it on the desktop.

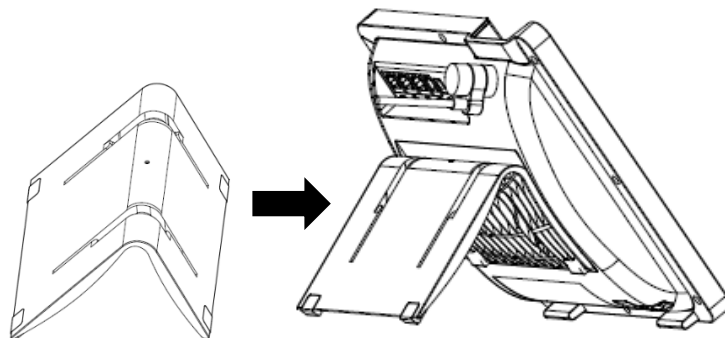

2.4.2 Mounting the Expansion Unit on a Desktop



Note: Only applies to C450HD phone users with the Expansion Unit option.

A dedicated stand is supplied for the Expansion Unit. Its mounting mechanism is identical to the phone's (see the previous section for more information).

2.4.2.1 Routing the Handset Cable

The phone features a groove for routing the handset cable.

2.4.3 Wall Mounting

This section shows how to mount the phone on a wall.

➤ **To mount the phone on a wall:**

1. Attach the stand of the phone for the purpose of a wall mounting:
 - a. Detach the base.

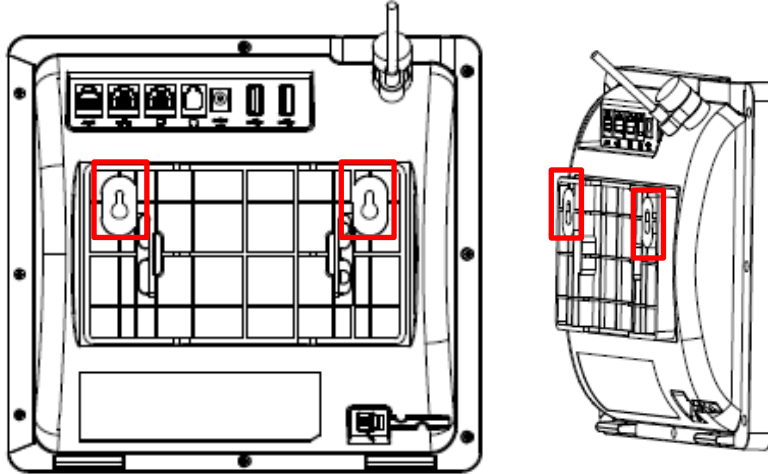

- b. Attach it again as you did for a desktop mounting (see Section 2.4.1) only now make sure that it's flatly aligned to lie flush against the wall, i.e., slide the *inner rails* of the phone stand onto the phone base's inner notches.
 2. Connect the AC power adapter, LAN and PC/laptop cords.
 3. In the wall, drill two horizontal holes at a distance of 3 15/16 inches (100 mm) from one another, in line with the template.
 4. Insert two masonry anchors into the holes if necessary.
 5. Thread two screws (not supplied) into the two masonry anchors; ensure that the heads extend sufficiently (about 3/16 inch or 5 mm from the wall) for the phone stand's keyhole slots to hang on.
 6. Hang the phone stand's keyhole slots on these screws.

This page is intentionally left blank.

3 Getting Started

This section gets you started with the phone. The phone features a touch screen, providing an intuitive, menu-driven user interface for configuring the device and viewing call information.

This section shows how to use the phone's touch screen but before using it, you must sign in.

3.1 Getting Acquainted with the Phone's Touch Screen

This section gets you acquainted with the phone's touch screen.



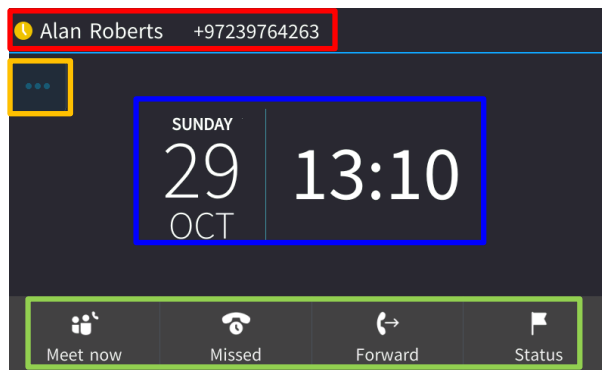

The figure below shows the touch screen in idle state.

Figure 3-1: Touch Screen in Idle State



Use the table below as reference:

Table 3-1: Touch Screen in Idle State

Reference	Description
	Presence status: Available, Busy, Do not disturb, Away, In a call or Be right back. See Section 5.20 for details.
	User name and phone number configured by your network administrator using the Web interface.
	Softkeys; to activate a softkey, touch its icon located in the screen. See Table 3-2 for softkey descriptions.
	Day, Date and Month, automatically retrieved from the Network Time Protocol (NTP) server, enabled by your network administrator.
	Time, automatically retrieved from the Network Time Protocol (NTP) server, enabled by your network administrator.
	Softkeys (see the next page).

3.2 Softkeys

The table below describes the softkeys displayed in the touch screen. Touch a softkey to activate.

Table 3-2: Softkey Descriptions

Softkey	Description
Meet Now	Initiates a Skype for Business server based phone conference.
Missed	Displays missed calls.
Forward	Automatically forwards calls.
Status	Lets you sets your presence status: Available, Busy, Do not disturb, Be right back, Off Work, Appear Away.
Sign in /Sign out	Sign in is displayed if you haven't signed in yet, in the idle screen. Sign out is displayed if you touch the Status softkey after signing in.
Directory	Displayed after lifting the handset (for example). Allows access to the Corporate or Personal Directory.
Call Log	Displayed after lifting the handset (for example). Allows access to the Call Logs.
Select	Identical to the hard OK key on the phone. Either can be used. Selects a menu or option.
BToE	Displayed after pressing the MENU hard key unless disabled by the network administrator. Generates a code for manually pairing the phone with Skype for Business client, for unified communications.
A/a/1	Displayed to allow switching between abc, ABC, Abc, 123, or T9 when inputting.
Save	Saves settings. Displayed after pressing Forward > Forward to a number and then entering the number to which to forward to (for example).
Cancel	Cancels the currently initiated call or configuration.
Dial	Displayed after a number is keyed, a directory contact is selected, or a logged call is selected.
Clear	Displayed after entering a digit of a phone number (for example). Deletes from right to left.
Call Menu	Displayed after a number is dialed and answered on the other side, and after you answer a call. Displays the Call Menu.
Conference	Displayed (1) after a number is dialed and the call is answered on the other side and (2) after you answer a call. Touching the softkey opens the ADD PARTICIPANT screen.
BXfer	Displayed (1) after a number is dialed and the call is answered on the other side and (2) after a call is answered. Lets you transfer the call in a blind transfer.
URL	Displayed after lifting the handset (for example). Enables calling a URL.
Detail	Displayed after selecting a call log (for example). If selected, the details of a logged call are displayed (Time, Date, etc.).
Favorite	Displayed in the Call Details screen. Allows adding the person to the Favorites directory.
End	Displayed after pressing the Dial softkey (for example). Ends the call.
Back	Displayed after pressing the MENU hard key (for example). Returns to the previous screen.
Edit	Displayed after you select a contact to be edited (for example).
Delete	Displayed after pressing the MENU hard key on the phone and then selecting Call Log (for example).
Silent	Displayed when the phone rings on an incoming call. Lets you silence the ring.

Softkey	Description
Reject	Displayed when the phone rings, alerting to an incoming call. Lets you reject the call.
Accept	Displayed when the phone rings, alerting to an incoming call. Lets you accept the call.

3.3 Navigating the Phone Menu

The MENU hard key on the phone lets you configure settings and access information. Press the key to view the phone's Menu screen.

Figure 3-2: Menu Screen

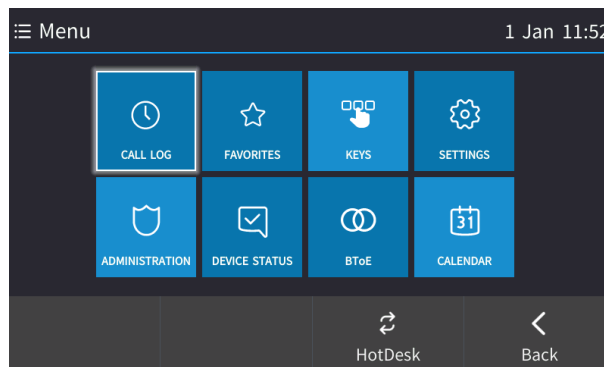

Touch a menu to perform actions described in the table below (from left to right).

Table 3-3: Menu Descriptions

Menu	Description
Call Log	Accesses logged calls (All Calls, Missed Calls, Received Calls and Dialed Calls)
Favorites	Accesses the 'Favorites' directory.
Keys	Used to configure Function Keys as Speed Dial, Key Event, or VocaNOM.
Settings	Used to customize phone settings and upload logs to Microsoft server.
Administration	Used to perform administrative tasks such as configure network settings, restore defaults and restart.
Device Status	Used to obtain information about the device's network status, firmware version, release and location.
BToE	Used to set up unified communications between the phone and your pc/laptop based Skype for Business client.
Calendar	Used to view meetings scheduled in the calendar for that day (integrated with Skype for Business client).

The figure below shows the phone's menus.

Figure 3-3: Menus



Note: **Administration** is intended for network administrators only. It is password protected. See the *Administrator's Manual* for details.

➤ **To navigate to a menu item:**

- Press the navigation control button's upper, lower, left or right rim, or press the item's number, e.g., open the Settings menu and press **4** to navigate to **Forward Settings**.

- **To select a menu item:**
 - Press the navigation control's **OK** button or touch the item.
- **To cancel and move to a previous menu level:**
 - Touch the **Back** softkey.

3.4 Inputting Data using the Virtual QWERTY Keyboard

The feature allows users to easily and effortlessly enter strings into fields in the phone's screens. Users will mainly use the virtual keyboard when:

Searching for contacts



URL dialing



Signing in



3.5 Selecting an Alphanumerical Mode

The keypad lets you enter alphabetical letters, numbers or symbols, and to switch between them.

➤ **To select a number, letter or symbol (e.g., lower case letters):**

1. When configuring a contact, for example, touch the **A/a/1** softkey:

Figure 3-4: Alphanumerical Selection

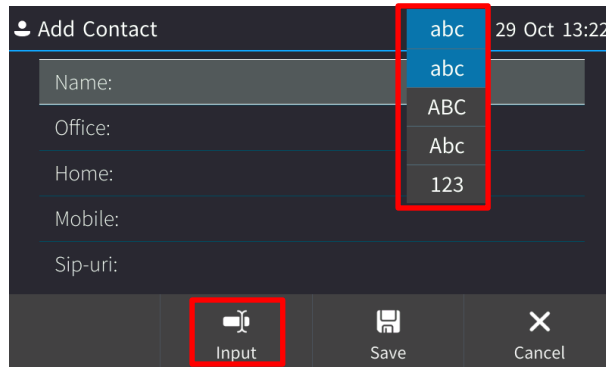

You can also access the mode menu by pressing the # key on the keypad. Successively press the # key to navigate in the mode menu.

2. From the mode menu, navigate to and select:
 - **abc** = lower case letters
 - **ABC** = upper-case letters
 - **Abc** = first-letter upper case, the rest lower case
 - **123** = numerical mode (i.e., numbers)
3. Select **abc** (for example) and then on the keypad, press **2** (for example); **a** is entered. Successively press **5** three times; **l** is entered (pressing it once produces **j**, twice produces **k**). Similarly, enter **a** and finally **n**.

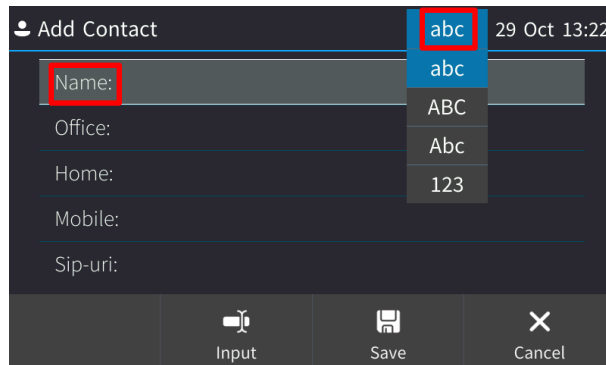

➤ **To enter a symbol (e.g., dot or @ or hyphen):**

1. Touch the **A/a/1** softkey and navigate to **abc** (mandatory).
2. Press the **1** key on the keypad; a period / full stop is entered. *Immediately* press the **1** key again; a backslash is entered.
3. Pressing successively produces the following symbols:

Symbol	Explanation	Symbol	Explanation
.	Dot	*	Star sign
\	Backslash	=	Equal sign
@	At		Separator

Symbol	Explanation	Symbol	Explanation
;	Semi-colon	(Open parenthesis
:	Colon)	Close parenthesis
#	Pound	{	Open parenthesis
\$	Dollar	}	Close parenthesis
%	Percentage	[Open square parenthesis
^	Caret]	Close square parenthesis
&	Ampersand	"	Double quotation marks
!	Exclamation mark	'	Single quotation mark
?	Question mark	>	Greater than
+	Plus	<	Less than
-	Hyphen	,	Comma
_	Underscore	/	Forward slash
~	Approximates		

Note that the asterisk (*) symbol is entered directly using the star key.

Figure 3-5: Entering a Symbol (e.g., a dot)

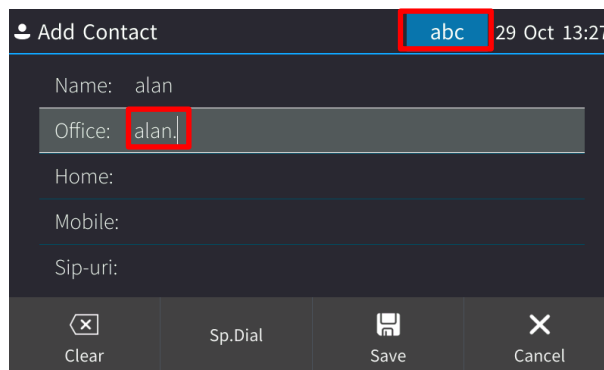

➤ **To revert to letters (e.g., abc):**

- Make sure the phone is in **abc** mode and successively press the **PQRS** key three times to produce **r** (for example):

Figure 3-6: Reverting to Letters (e.g., abc)

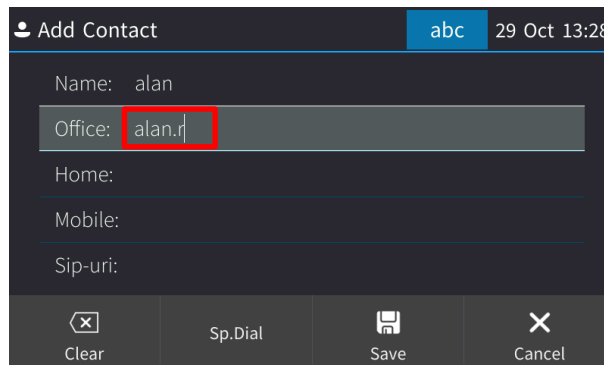

3.6 Signing In

This section shows how to sign in.

➤ **To sign in:**

- In the Offline screen, touch the **Sign in** softkey; the Sign-in options are displayed:

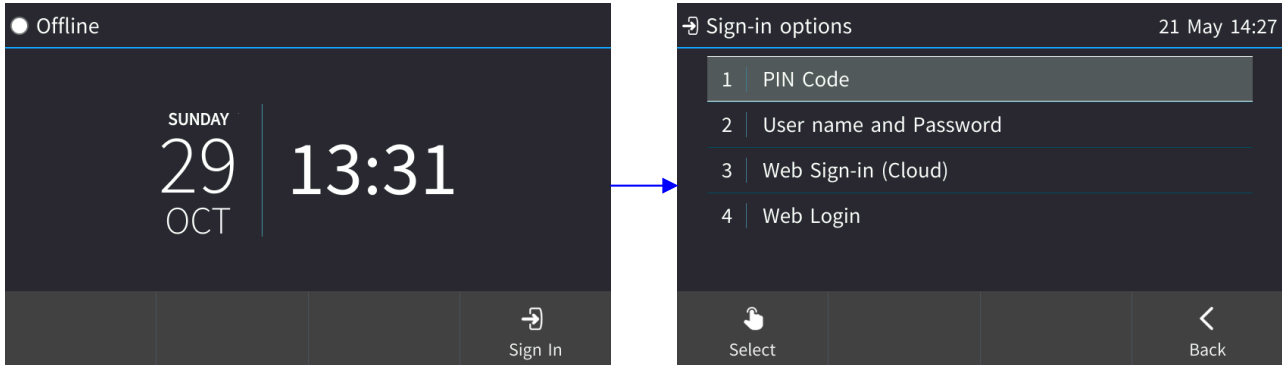

- PIN code - see Section 3.5.1
- User name and Password - see Section 3.5.2
- Web Cloud (Office 365) - see Section 3.5.3
- Web Login – see Section 3.5.4



Note:

- After signing out, the next time you sign in the phone will present the option that was used to sign in before signing out.
- If a user signs out and another signs in, the phone presents empty Speed Dials and empty Call Logs to the newly signed-in user. The Speed Dials and Call Logs of the signed-out user are not saved on the phone.
- Sign-in can be cancelled during the signing in procedure. You can cancel signing in after starting the sign-in process.

3.6.1 Signing in with PIN Code

This section shows how to sign in with the PIN code and phone number. The PIN code is provided by your network administrator.

➤ **To sign in with the PIN code:**

1. In the 'Sign-in options' screen shown above, select the **PIN Code** option.

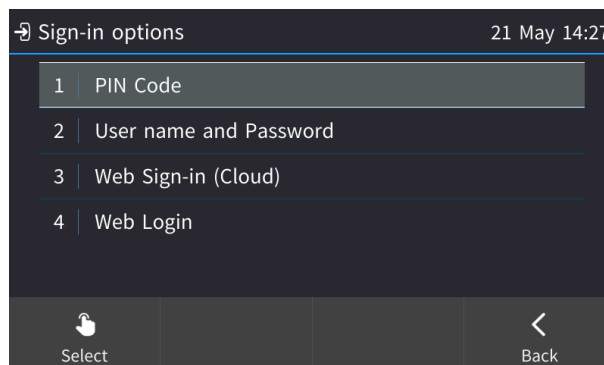

2. Enter your phone number.
3. Navigate down and enter your PIN code (obtainable from the network administrator).

To switch from numbers to alphabetical letters and symbols, see Section 3.4.

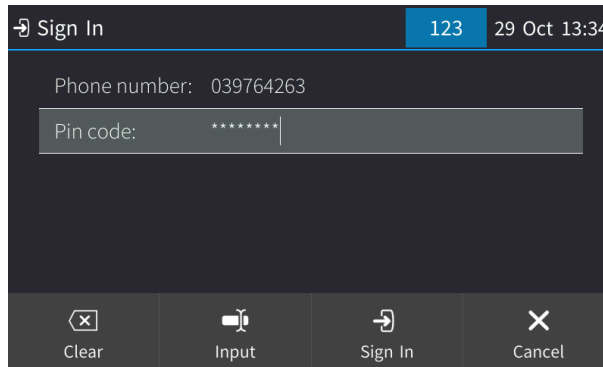

4. Touch the **Sign in** softkey.

3.6.2 Signing in with User Name and Password

This section shows how to sign in with User Name and Password.

➤ **To sign in with User Name and Password:**

1. In the 'Sign-in options' screen, select **User name and Password**.

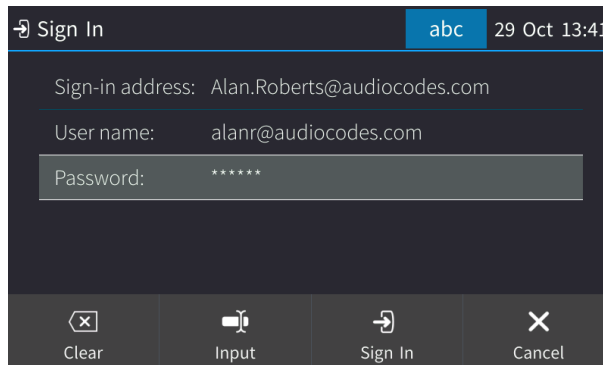
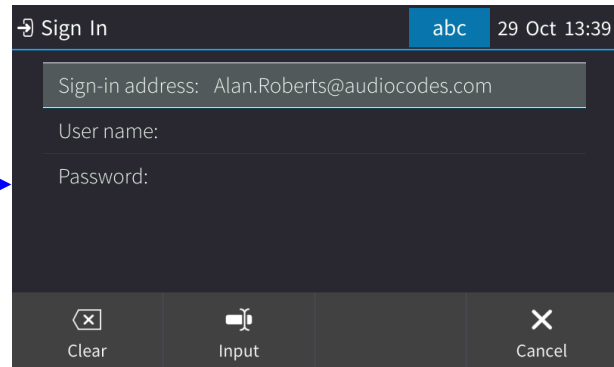
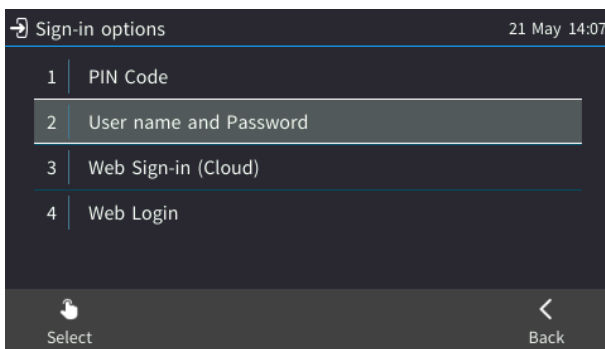

Note: Signing in with a username that is a NetBIOS Domain Name, i.e., **domain\username**, or with the PIN Code, are *disallowed* for Skype for Business online sign-in. They are only allowed for *on-premises* sign-in. Online sign-in must be in the following format:

- Sign-in address, i.e., SIP URI. To switch from letters of the alphabet to symbols such as @, - and period, see Section 3.4.
- User name, in UPN (User Principal Name) format, i.e., the way the user's name appears in their e-mail address listed in the Active Directory: **username@domain.com**
- User's network IT password (the same password you use to access your PC)

2. Touch the **Sign in** softkey.



Note:  indicates you are using a username format that cannot access Microsoft Exchange, for example, **audiocodes/someone** instead of **someone@audiocodes.com**.

3.6.3 Signing in with the Web Sign-in (Cloud) Option

Signing in using the sign-in option 'Web Sign-in (Cloud)' enables connectivity to Microsoft's Cloud PBX, Microsoft's cloud-hosted version of enterprise voice. Also known as Device Pairing, signing in with this option only applies to Microsoft Cloud PBX users. The option exempts users from having to laboriously key in their user name and password using the phone keypad.

If this sign-in option is selected, a Web URL and a Pairing Code are displayed:

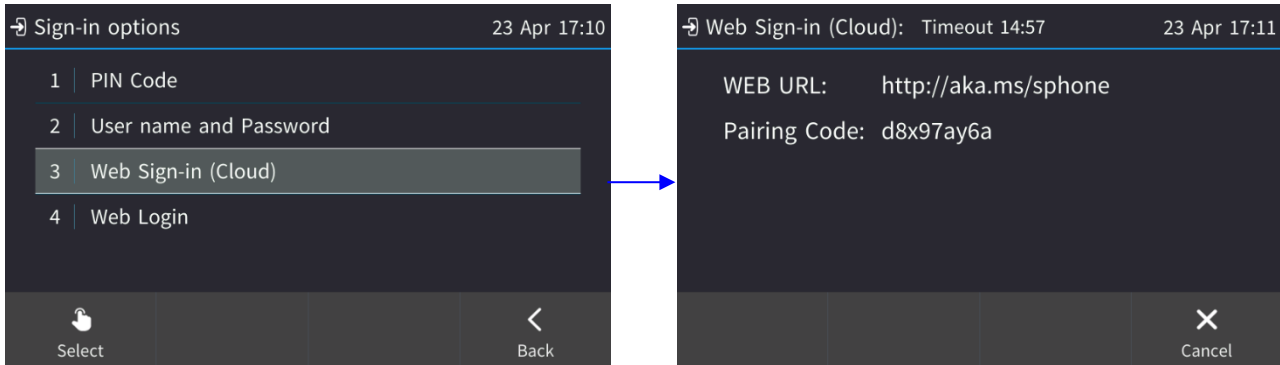

Point your browser to the URL and then enter the Pairing Code in the Microsoft web page. Sign-in to Microsoft's Cloud PBX is then performed.



Note:

- The name of this sign-in option was previously **Web sign-in**. The option's name was changed to **Web Sign-in (Cloud)** in line with Microsoft's recommendations, and to avoid confusion.
- Applies only to Microsoft Cloud PBX users.

3.6.4 Signing in using the Web Login Option

Signing in using the sign-in option 'Web Login' enables users to sign-in to their phone from their browser using their PC keyboard to quickly enter sign-in credentials, rather than use the longer method on the phone's keypad which requires switching input from letters of the alphabet to numbers and vice versa. [Applies to Skype for Business online and on-premises].

The Web Login method of signing in to the phone features a secure HTTPS protocol between the web internet browser and the phone. The IP Phone Manager Pro/Express server *intermediates* between the browser and the phone.

➤ **To sign in using the Web Login option:**

1. When the phone is offline, press the **Sign-in** softkey and then select **Web Login**.

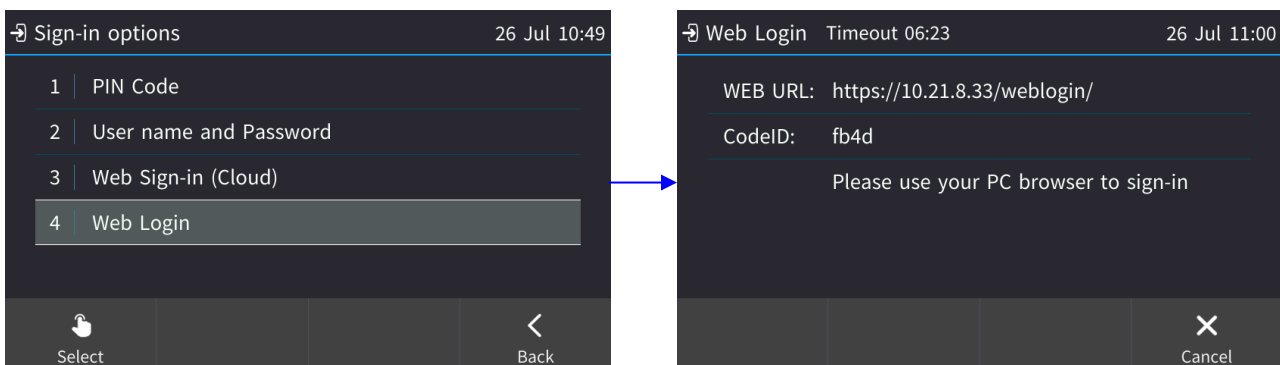

- Open your browser and in the browser's address field, enter the Web URL displayed in the phone screen.

Figure 3-7: Enter the Web URL Displayed in the Phone Screen

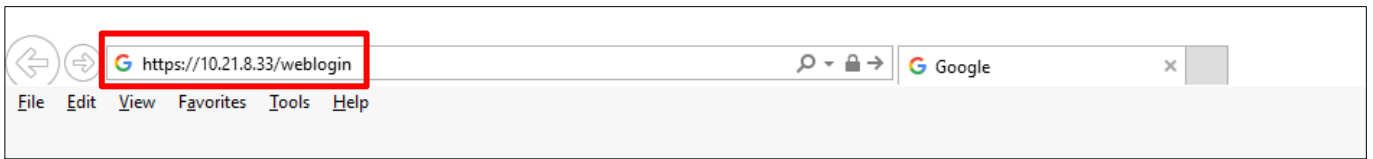

The Web Login screen opens. You've browsed over HTTPS to the IP Phone Manager Pro/Express server URL.



- Enter the Code ID. Get it from the phone screen prompt. This is the random 4-character string generated by the IP Phone Manager Pro/Express server. It's valid for 10 minutes. Use the pc keyboard to enter the Code ID and the user credentials.

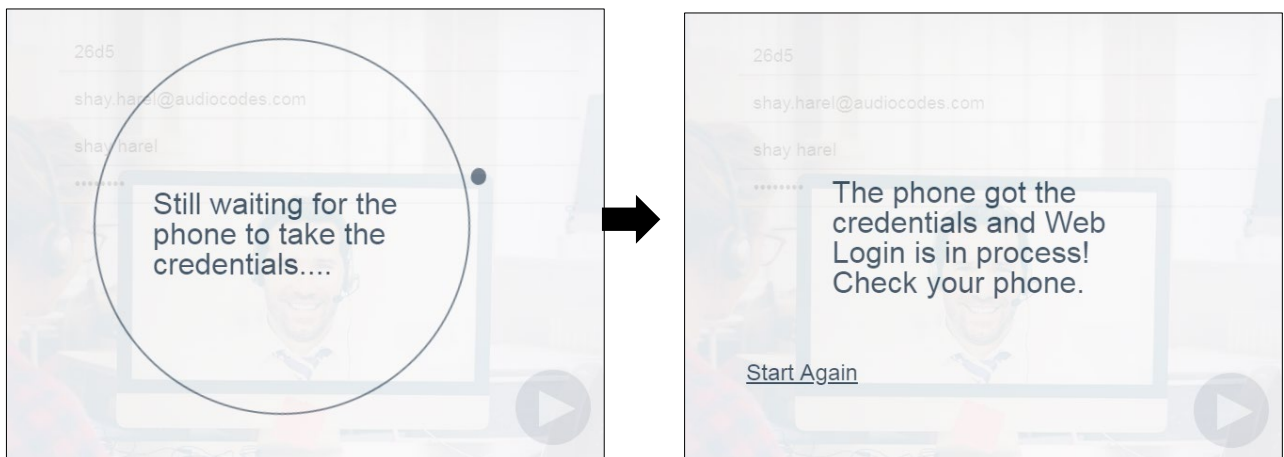

The server then sends the credentials over HTTPS to the phone. If the phone screen indicates that the Web Login is unsuccessful, you can 'Start Again' and reenter your credentials.



Note: The feature applies to Skype for Business online and on-premises. Username and password sign-in as well as BToE sign-in are supported.

3.6.4.1 Users with IP Phone Manager Pro / Express Version 7.4.3000 or Earlier

This section shows the Web Login procedure that is performed if you have an earlier version of IP Phone Manager Pro / Express than 7.4.3000.

This procedure allows you to sign-in by browsing directly to the phone.

➤ **To sign in using the Web Login option:**

1. When the phone is offline, press the **Sign-in** softkey and then select **Web Login**; the phone screen displays a Web URL.
2. Open your browser and enter the URL in the address field; the Web Login page opens.

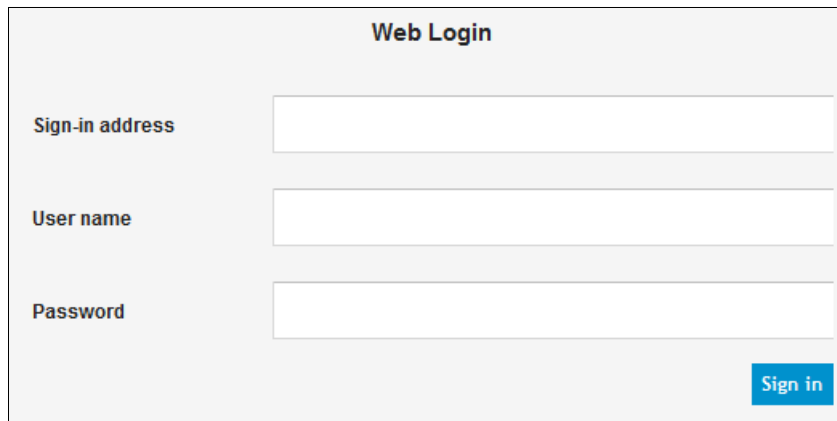

The screenshot shows a web browser interface titled "Web Login". It contains three input fields: "Sign-in address", "User name", and "Password". A blue "Sign in" button is located at the bottom right of the form.

3. Enter the 'Sign-in address', i.e., SIP URI, for example, john.doe@enterprise.com.
4. Enter your username and password (ask the network administrator if necessary) and then click **Sign in**.

3.7 Signing in as a Common Area Phone (CAP) User

A phone can be configured as a CAP. Configured *per physical phone* rather than *per user*, a CAP requires a special sign-in method called 'CAP provisioning'. Before signing in, your network administrator needs to enable the phone as a CAP.

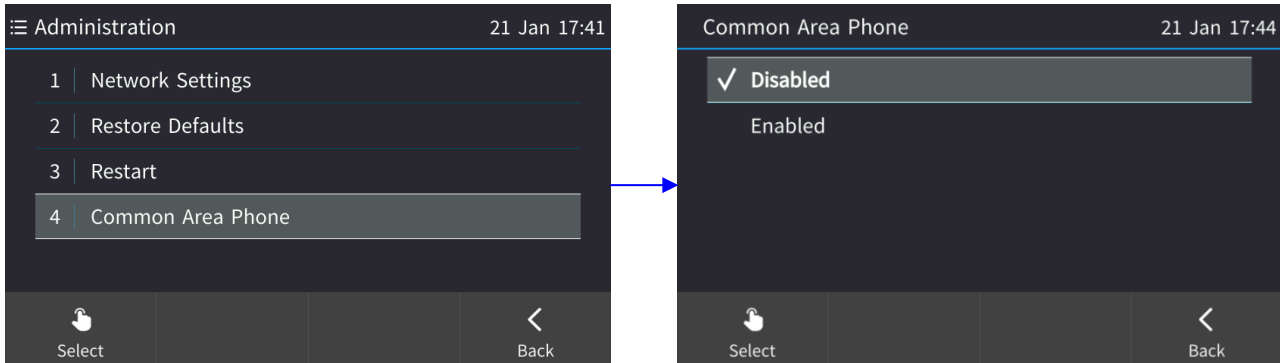

After the phone is enabled as a CAP, it restarts.

➤ **To sign in using the CAP Provisioning option:**

1. When the phone is offline, press the **Sign-in** softkey and from the 'Sign-in options' screen select **CAP Provisioning**.

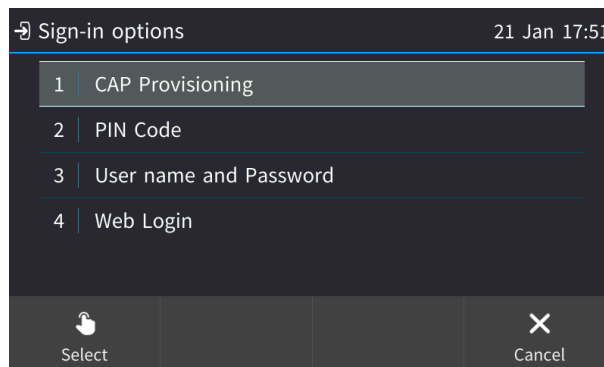

2. After selecting the 'CAP provisioning' method, view a displayed URL and Pairing Code.

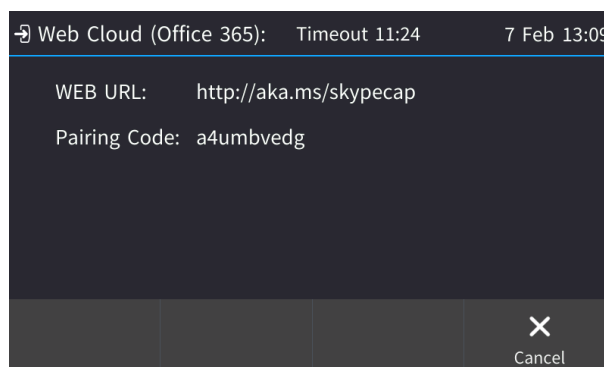

3. Point your browser to the URL, sign in to Office 365 and locate the phone.

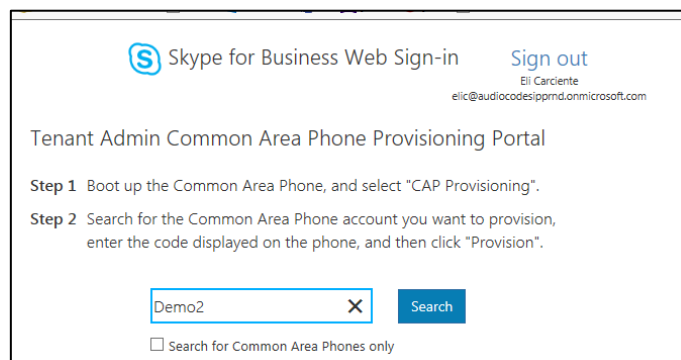
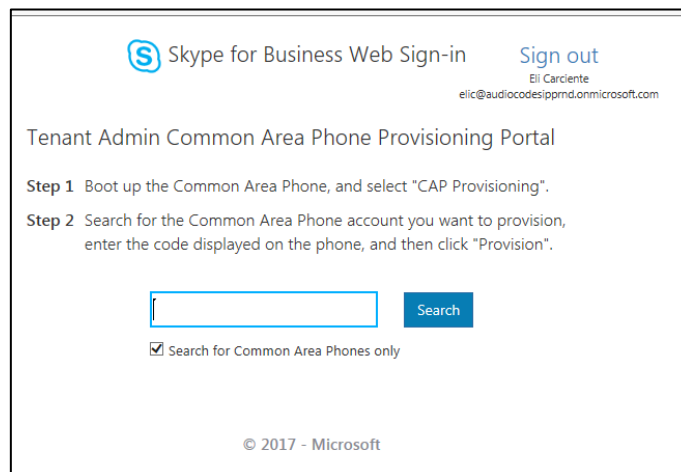
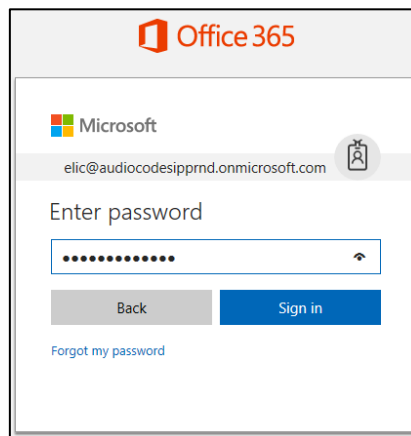
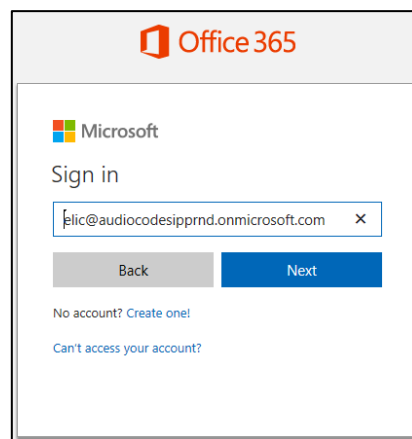
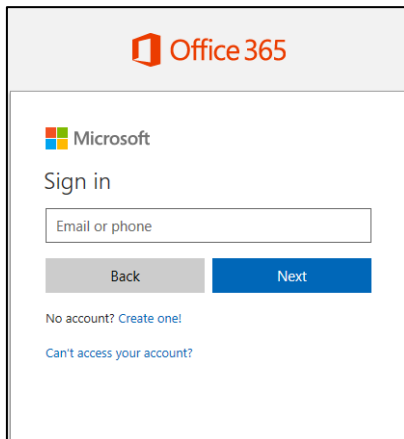

4. Enter the Pairing Code in the Microsoft web page and clicks **Provision**.

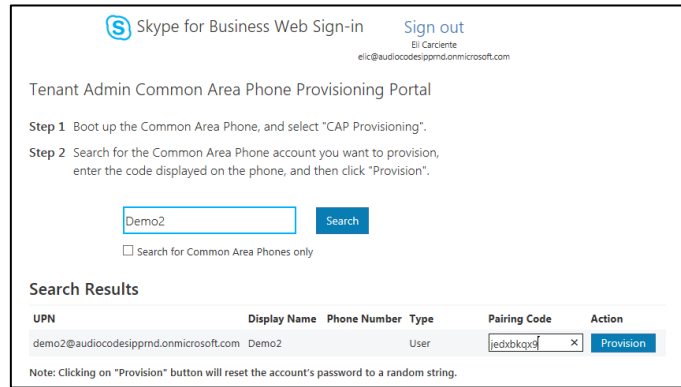

Sign-in to Microsoft's Cloud PBX is performed.

3.8 Signing Out

This section shows how to sign out.

➤ To sign out:

1. In the idle screen, touch the **Status** softkey.
2. In the Status screen touch the **Sign out** softkey.

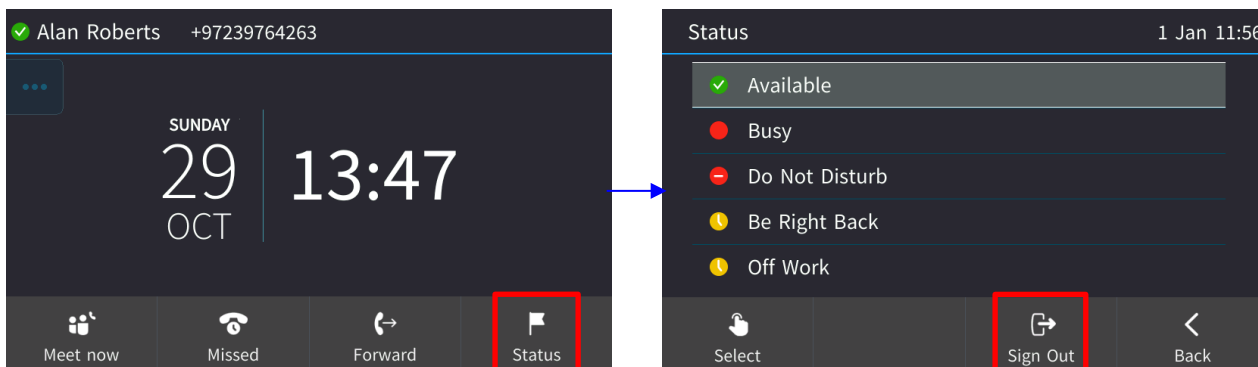

You're signed out and returned to the offline screen displaying the **Sign in** softkey.

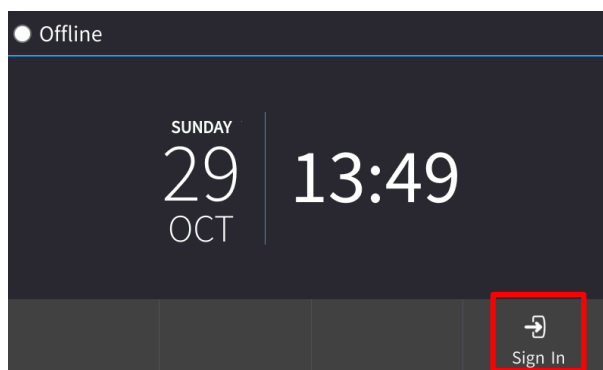

Note: If a user signs out and another signs in, the phone presents empty Speed Dials and empty Call Logs to the newly signed in user. The Speed Dials and Call Logs of the signed out user are not saved on the phone.

3.8.1 Signing out if the 'Sign out' Softkey is Removed from the Touch Screen

Located in lobbies, cafeterias, employee lounges, meeting rooms, and other gathering places, Common Area phones typically do not display a **Sign out** softkey in the touch screen, in line with network management's decision to remove the capability from users. Users can sign out, if necessary, using the Web interface.

➤ To sign out using the Web interface:

1. Obtain the Common Area phone's IP address (MENU hard key > **Device Status** > **Network Status** > **IP Address**) and point your Web browser to it; the phone's Web interface login page opens.

Figure 3-8: Login

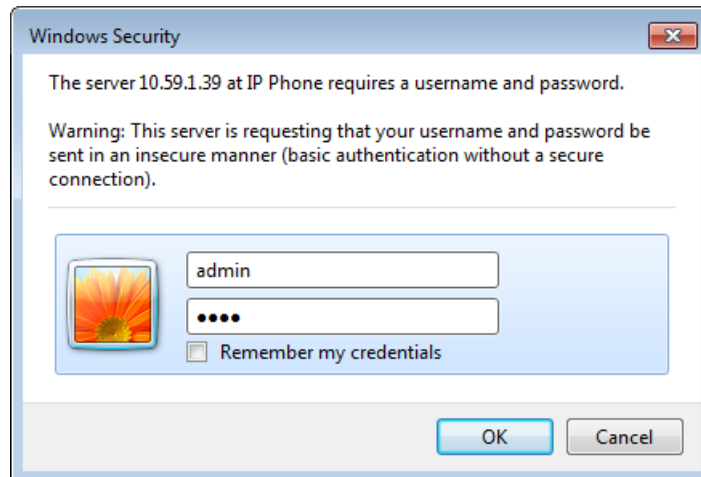

2. Enter the login credentials (default username is **admin** and default password is **1234**); the Home page of the Web interface is displayed.

Figure 3-9: Web Interface – Home Page

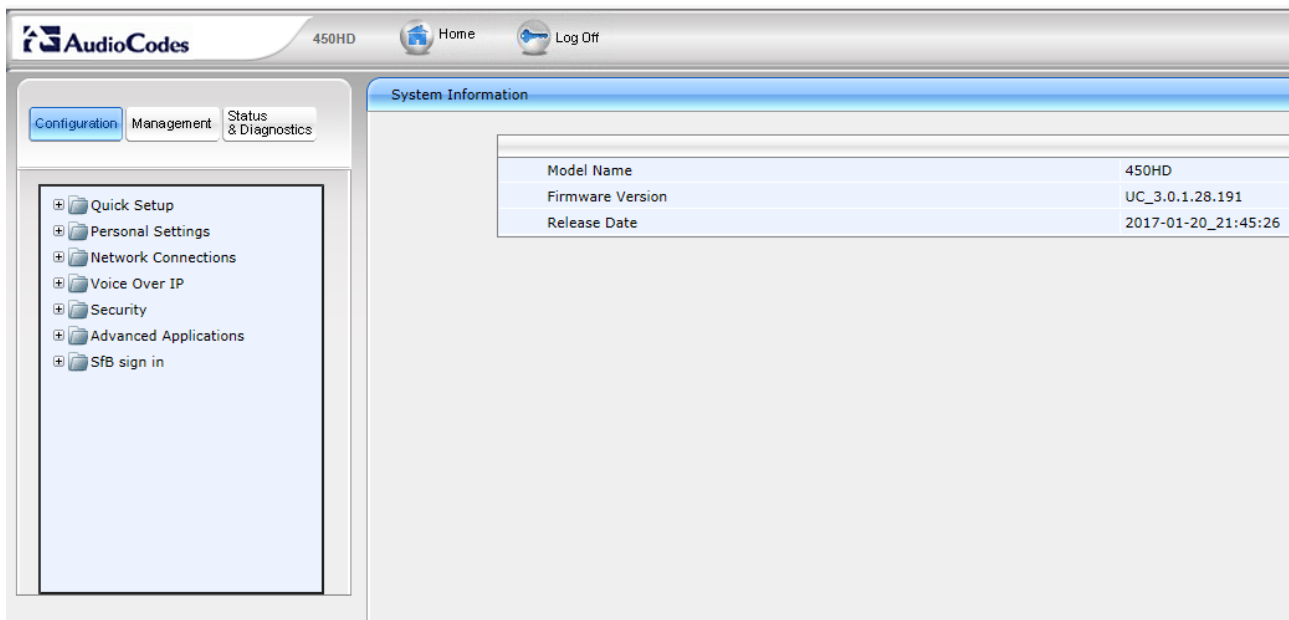

3. In the Web interface, open the Sign-In page (**Configuration** tab > **SfB sign in** > **Sign in**).

Figure 3-10: Sign-in – Content Blocked Page

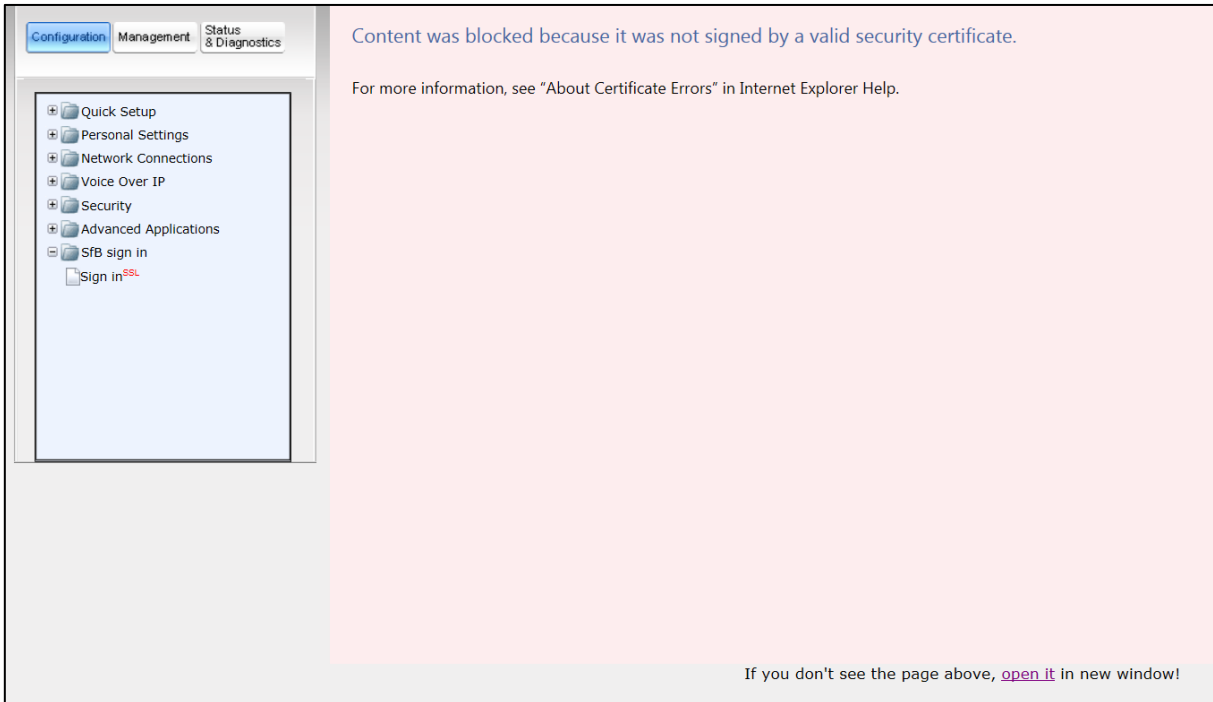

4. Click the **open it** link and then click **Show content**.

Figure 3-11: Sign-in – Windows Security Prompt

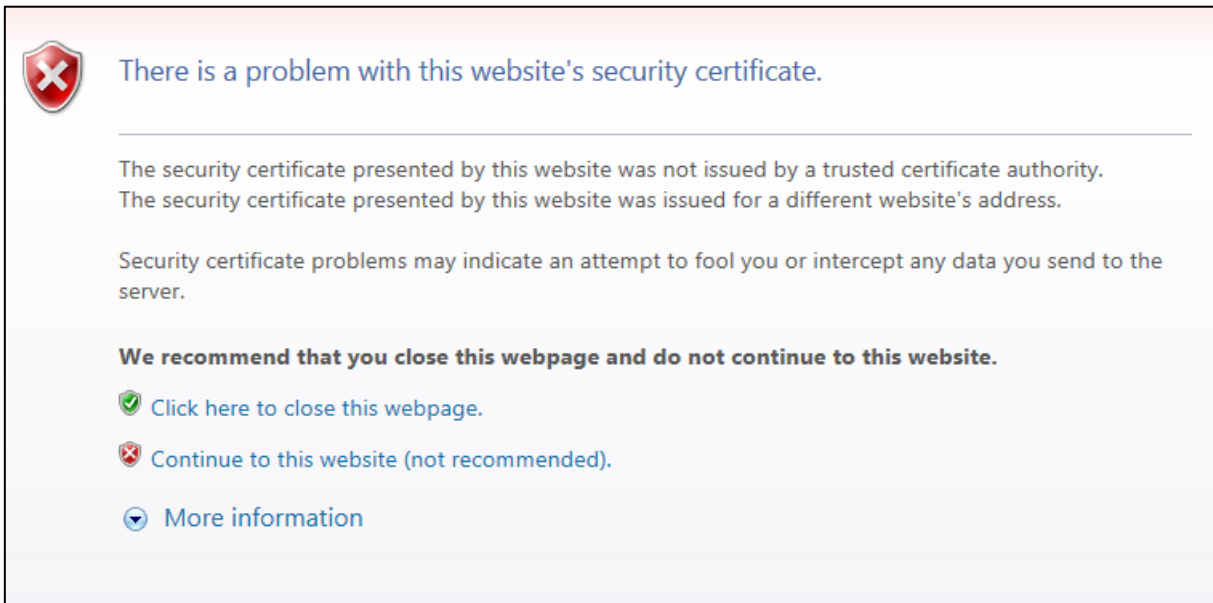

5. Click the **Continue to this website (not recommended)** link.

Figure 3-12: Windows Security Prompt

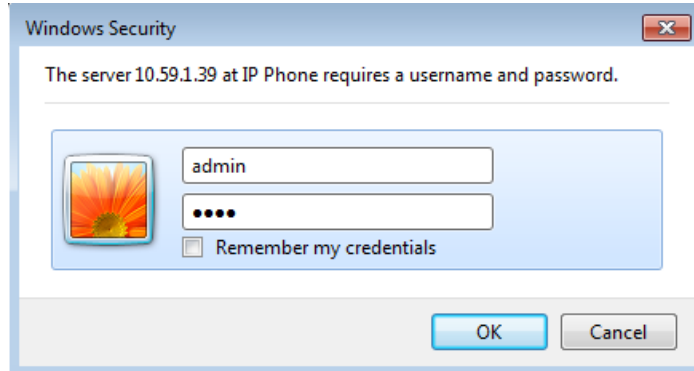

6. In the Windows Security prompt, enter the username and password and then click **OK**.

Figure 3-13: Sign-out

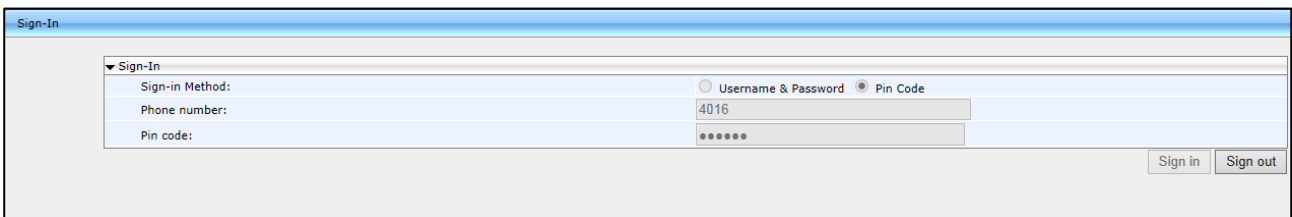

7. Click the **Sign out** button.

3.9 Connecting to Wi-Fi

The phone can connect to an Access Point via Wi-Fi. The Wi-Fi interface can be used when the phone is installed in an environment free of LAN/cables, to perform VoIP calls over Wi-Fi.

➤ **To connect to Wi-Fi:**

1. In the phone's main menu, press the **Networks** icon -or- in the 'Settings' menu, navigate to and select the **Wi-Fi** option. If an Ethernet cable does not connect the phone to a LAN port:

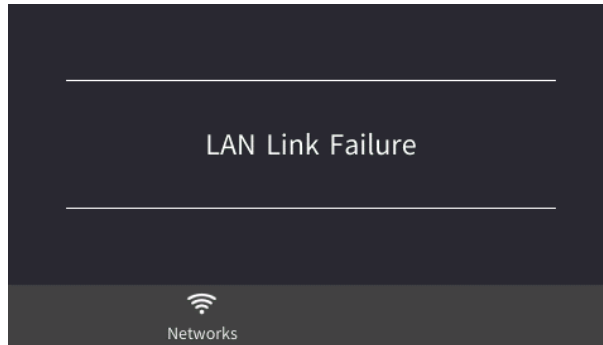

2. Alternatively access Wi-Fi settings via the MENU hard key > **Settings** > **Wi-Fi Settings**.

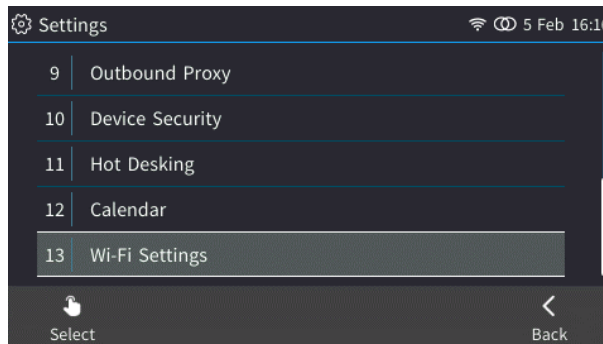

3. Enable | disable Wi-Fi by pressing the navigation button's right/left rim (Default: Disabled).

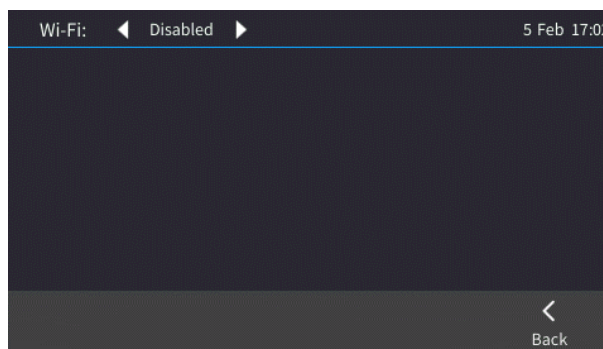

4. After enabling Wi-Fi, the phone indicates 'Searching for networks...' and then displays available Wi-Fi Access Points. Optionally press the **Refresh** softkey to display more options.

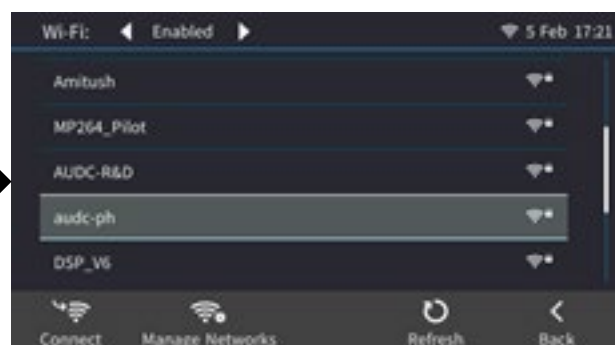
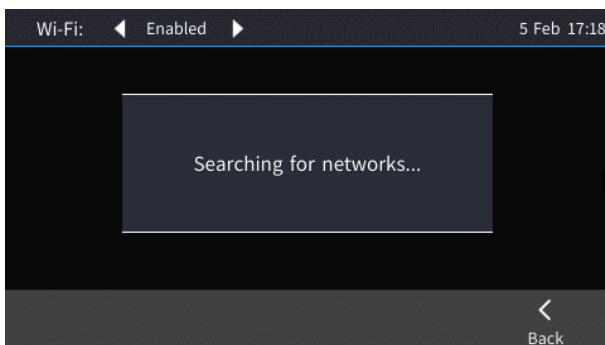

- After selecting a Wi-Fi Access Point, configure Access Point parameters.

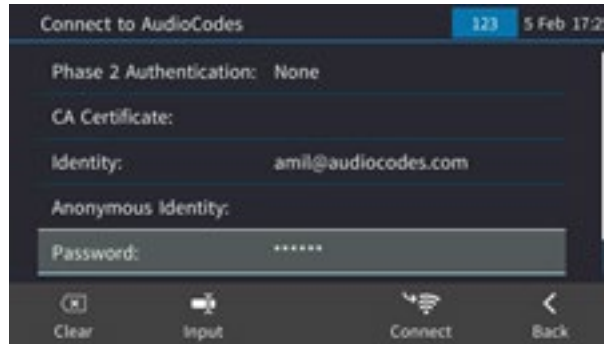

- After configuring the Wi-Fi parameters, press the **Connect** softkey and wait about 20-30 seconds for the phone to connect to Wi-Fi and receive an IP address; the Wi-Fi icon is then displayed in the uppermost right corner of the screen:

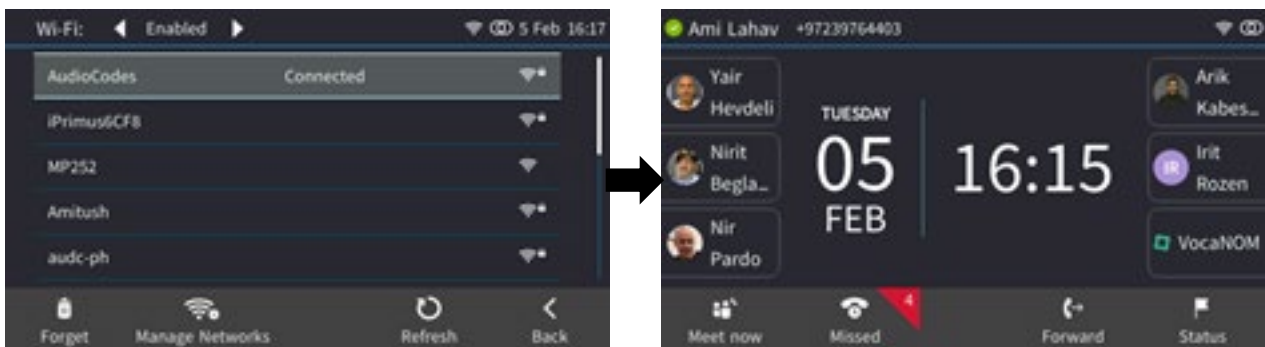

- Determine Wi-Fi status (network name, authentication method and Wi-Fi signal strength) from the Wi-Fi Network Info screen (**Device Status > Wi-Fi**).

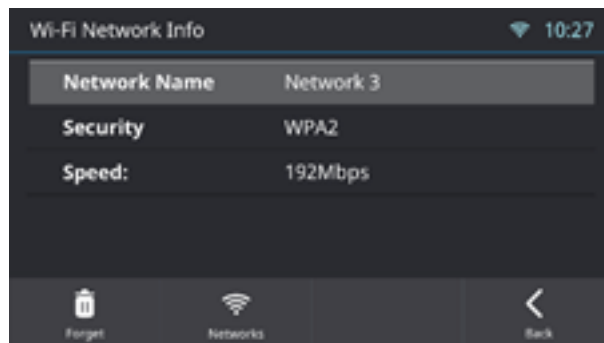

Note:

- An icon indicating Wi-Fi signal strength is also displayed, on the screen's upper bar.
- If a Wi-Fi connection has been set up and established, it will be used even if a LAN connection exists.

3.10 Hot Desking

Employees in enterprises that operate according to a 'touch-down desk' concept can use the phone's HotDesk feature. Employees in these enterprises typically travel frequently to remote branches, or work in shifts. They can sign in to a phone that is already signed in by another (CAP or regular) user without signing out the original user to whom the phone was assigned for primary use.

➤ **To use the HotDesk feature:**

1. Press the MENU key on the phone.

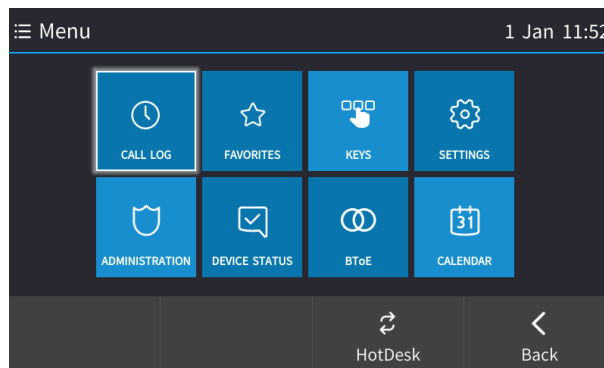

2. Click the HotDesk softkey displayed; the 'HotDesk Sign-in options' screen opens – identical to the regular sign-in screen.
3. Select **PIN code** -or- **Username and Password** -or- **Web Sign-in** (see under Section 3.5 for more information).

Note:

- If the phone is locked, a popup prompt is displayed after the HotDesk softkey is selected, prompting you to confirm your request for Hot Desking.
- If the feature isn't enabled on the server, the enterprise's network administrator must enable it for the feature to be available.
- When the HotDesk user signs out or if the phone stays in idle state longer than the HotDesk timeout defined on the server, the phone automatically returns to its original user and state; its configuration and data are preserved as they were before the phone was leased for HotDesk use. HotDesk users cannot perform all operations that the original (CAP or regular) user could perform, for example, change Language.



3.11 Viewing Process Messages Displayed in the Screen

Messages indicating processes in progress displayed in the touch screen include:

Table 3-4: Displayed Messages Indicating Processes In Progress

Message	Description
Initializing	Initializing
Discovering LLDP	Discovering VLAN using Link Layer Discovery Protocol (LLDP)
Discovering CDP	Discovering VLAN using Cisco Discovery Protocol (CDP))
Acquiring IP	Acquiring an IP address from a DHCP server
Initializing Network	Initializing the network
Signing in	Signing in to the Skype for Business server
Signing in...Contacting time server	Get the time from the NTP server
Discovering SfB server	Auto discovering the Skype for Business server on the network
Registering	Registering to a Skype for Business server (after booting up the phone)
Downloading Firmware File	Downloading a firmware file
Upgrading Firmware	Upgrading the phone's firmware
Signing out	Signing out of the Skype for Business server

4 Using the Phone's Automatic Lock Feature

The phone is capable of automatically locking after a configured period of time to secure it against unwanted (mis)use. If left untouched for 10 minutes (default), it automatically locks and is inaccessible to anyone who doesn't know its lock code.

4.1 Enabling the Feature



Note: For the phone's automatic locking feature to be available to users, the network administrator must first enable it in the Skype for Business server and Web interface. See the *Administrator's Manual* for details.

After the network administrator has enabled the feature in the Skype for Business server and Web interface, you need to enable it on the phone if it isn't enabled already.

➤ To enable the lock feature on the phone:

1. Press the MENU key, touch the **Settings** item and scroll to and select **Device Security**.

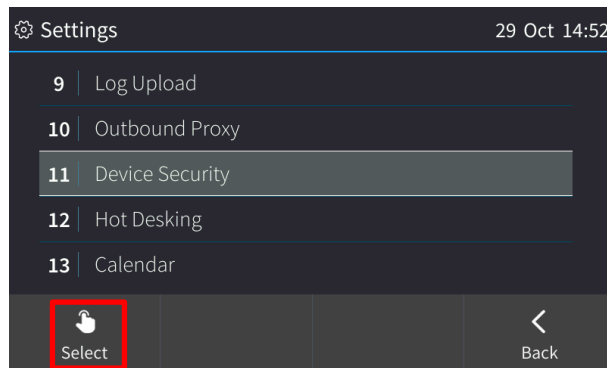

2. In the Device Security screen, select **Locking the Device** and then select **Enabled**.

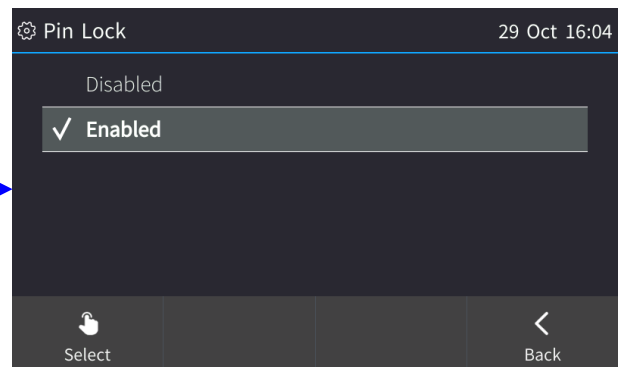
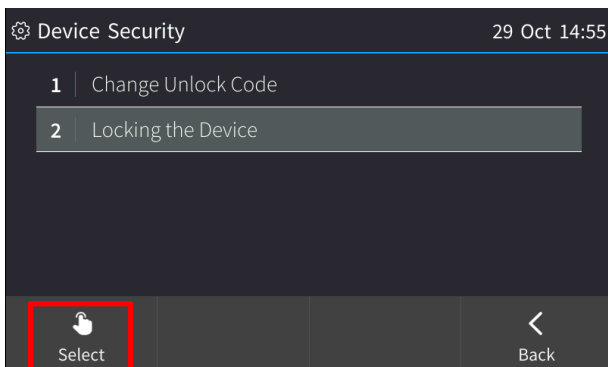

➤ To disable the feature on the phone:

- In the Device Security screen, select the **Locking the Device** option and then in the Pin Lock screen, select **Disabled**.

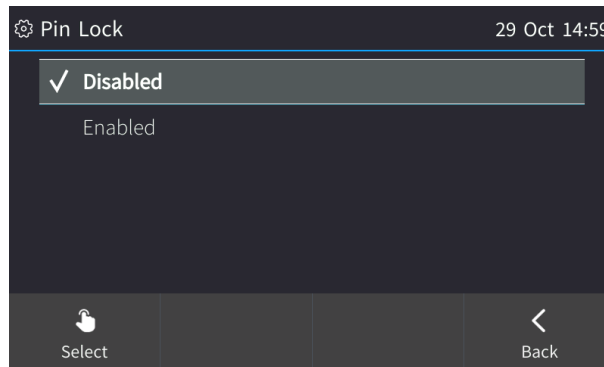

4.2 Unlocking a Locked Phone

If the locking feature is enabled, the phone automatically locks after a configured period of time, securing it against unwanted (mis)use. If left untouched for 10 minutes (default), it automatically locks and is inaccessible to anyone who doesn't know its lock code. After a phone locks:

- Outgoing calls cannot be made
- Call Log, Calendar and Corporate Directory cannot be accessed

Your network administrator if necessary can allow making emergency calls and other capabilities even though the phone is locked. See the next section for more information.

➤ **To unlock a locked phone:**

- When prompted for a lock code, enter a code, e.g., **123456**, and then press **OK**; the phone enters idle state.

4.3 Manually Changing the Lock Code

The lock code can manually be changed as an extra security measure.

➤ **To manually change the code:**

1. Press the MENU key on the phone, select **Settings** and then scroll down to select **Device Security**.

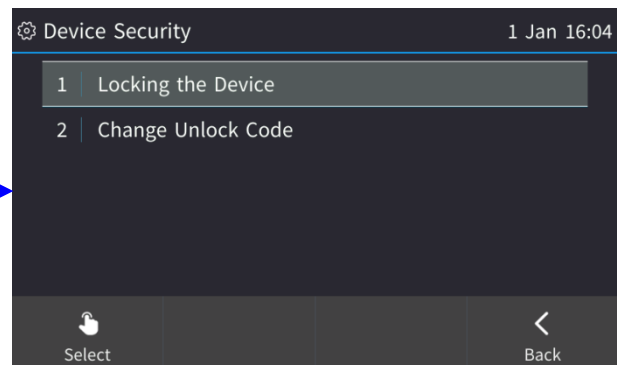
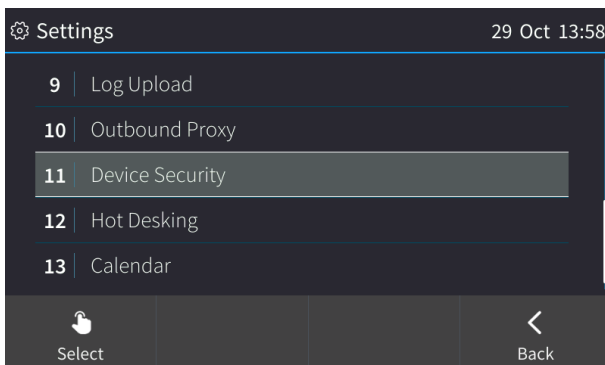

2. Select **Change Unlock Code**.

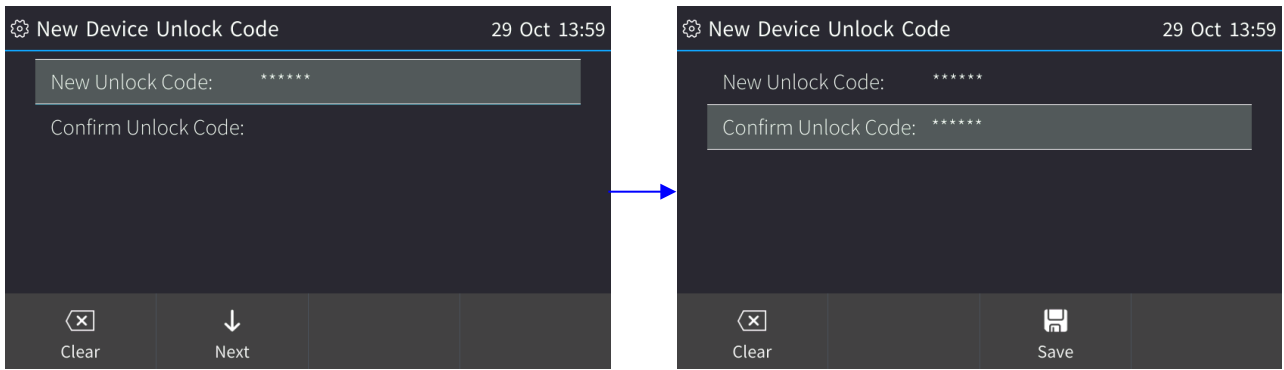

3. Enter the new unlock code, touch the **Next** softkey, re-enter the code, and then **Save**.

4.4 Dialing Emergency Numbers if the Phone is Locked

If the phone locks, emergency numbers such as for the police, ambulance service, firefighting service, etc., will still be available and dialable via an **Emergency** softkey that is displayed in the phone's idle screen after the lock takes effect.

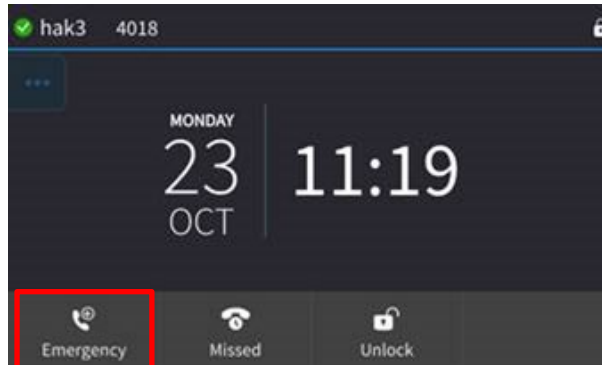

You can select an emergency number from a list of emergency destinations. A dedicated number for the police, ambulance service, fire fighting service, etc., can be selected from a list of options, for example:

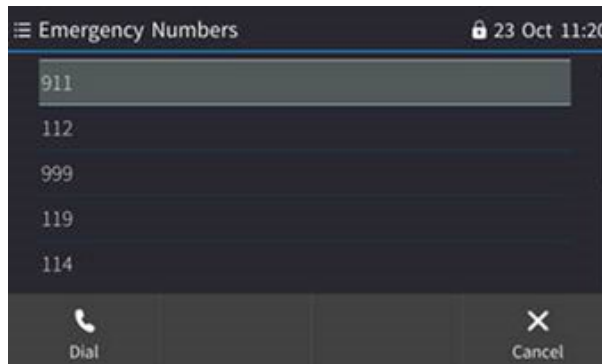

Note: The network administrator must define these emergency numbers in the Skype for Business server for the feature to be available.

4.5 Using Other Functionalities if the Phone is Locked

Your network administrator can allow other capabilities besides making emergency calls, even though your phone is locked, in compliance with Microsoft Skype for Business. Your network administrators can configure your phone to:

- Allow you to make outgoing calls even though the phone is locked
- Allow you to receive incoming calls even though the phone is locked
- Allow you to answer Delegate calls even though the phone is locked
- Allow you to use the phone's handset even though the phone is locked



Note: Consult your network administrator if necessary. For more information, see the *Administrator's Manual*.

5 Customizing Your Phone

You can customize your phone to create a friendlier user experience.

5.1 Changing the Screen Language

The touch screen supports multiple languages. English is the default but you can change it to another.

➤ **To change the default:**

1. Open the **Languages** screen (MENU hard key > **Settings** > **Language**).

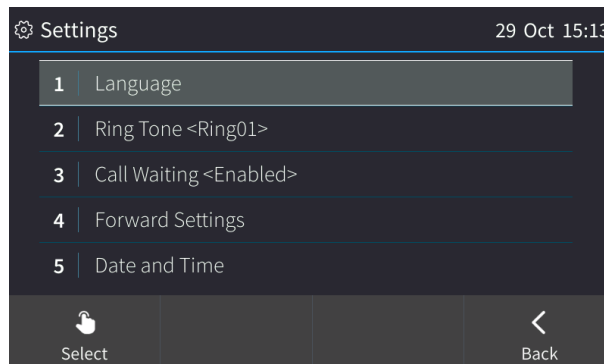

2. Navigate to the language you require.

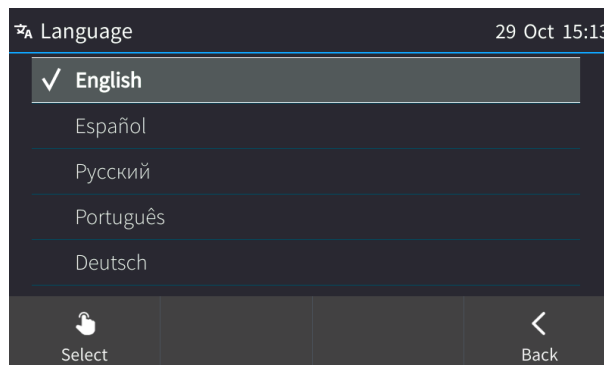

3. Touch the **Select** softkey to select it.
4. Touch the **Save** softkey to save the setting.

5.2 Selecting Ring Tone

You can choose from a selection of ring tones to indicate incoming calls.

➤ **To select a ring tone:**

1. Open the **Ring Tone** screen (MENU hard key > **Settings** > **Ring Tone**).

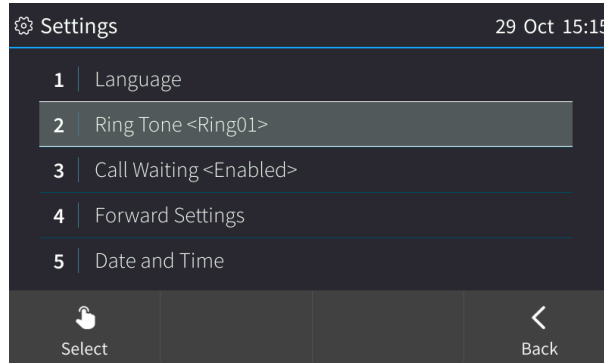

2. Navigate to and select a ring tone. A sample of each ring tone is played as you navigate through the list.

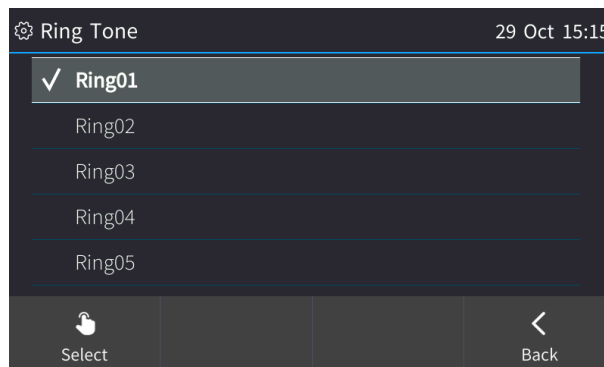

3. Set ring tone volume by pressing the VOL  or VOL  key:

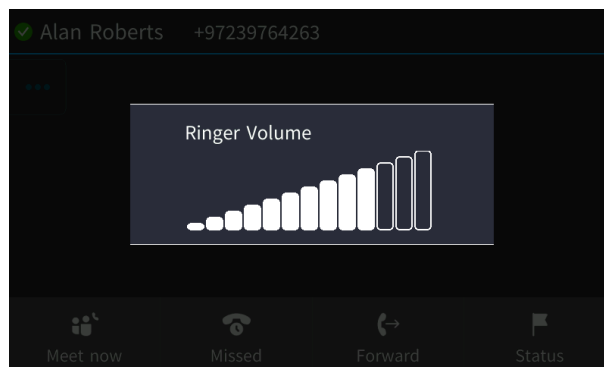

A few seconds after adjusting the volume level the Ringer Volume indication is hidden.

4. Touch the **Select** softkey to apply your settings.
5. Touch the **Save** softkey to save your settings.

5.3 Displaying Contacts Pictures

Contact pictures are by default displayed in the C450HD phone screens and C450HD Expansion Module screen after signing in with the User Name and Password method or with the PIN method. For more information about signing in with this method, see Section 3.5.2. Contact pictures are displayed with:

- speed dials in the idle screen
- Favorites, Corporate Directory, Personal Directory, Outlook Contacts and other contact lists
- incoming calls
- outgoing calls
- conference calls
- visual voice mail
- call logs

The figure below left shows contact pictures displayed for speed dials in the C450HD Expansion Module screen. The figure below right (uppermost) shows contact pictures displayed for speed dials in the idle screen. The figure below right (middle) shows contact pictures displayed for Favorites. The figure below right (lowermost) shows contacts pictures displayed in a conference.

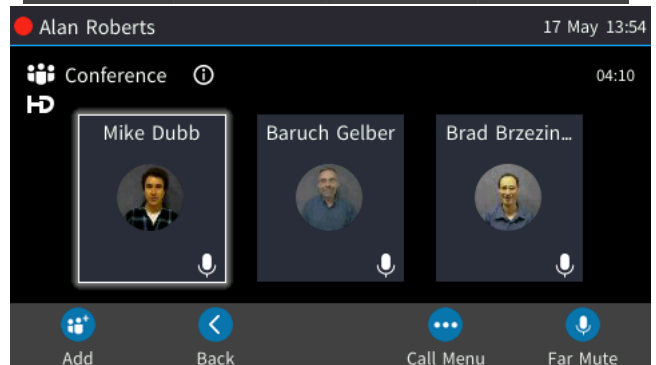
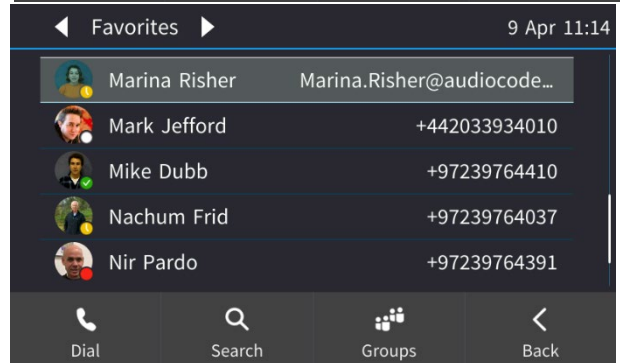
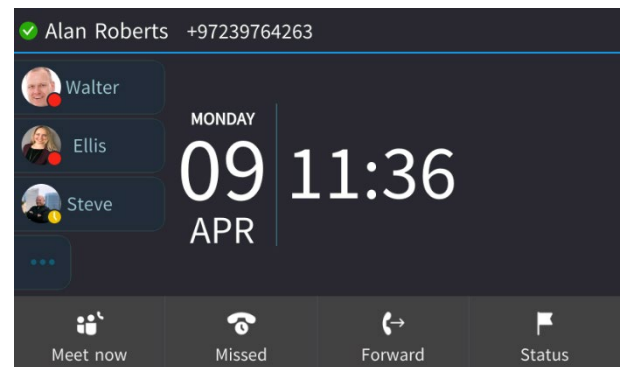
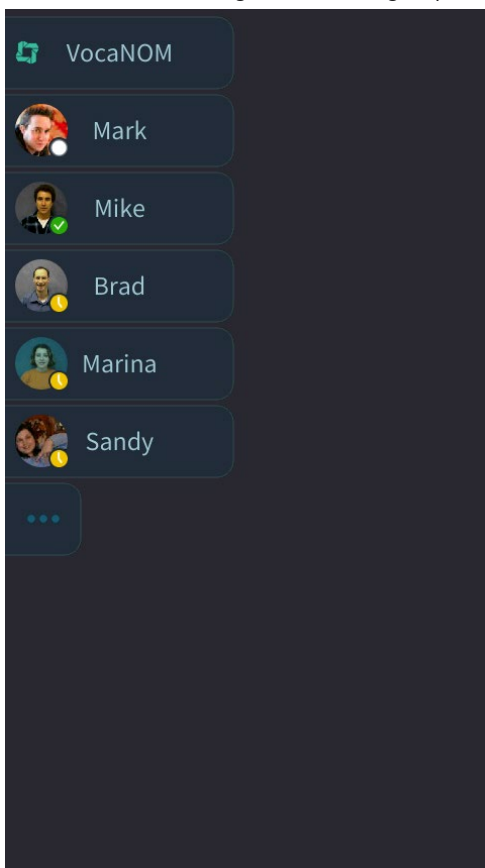



Note: In the Skype for Business client (see the figure below), users can despite the default reserve their right to hide their pictures so that others won't be able to see it.

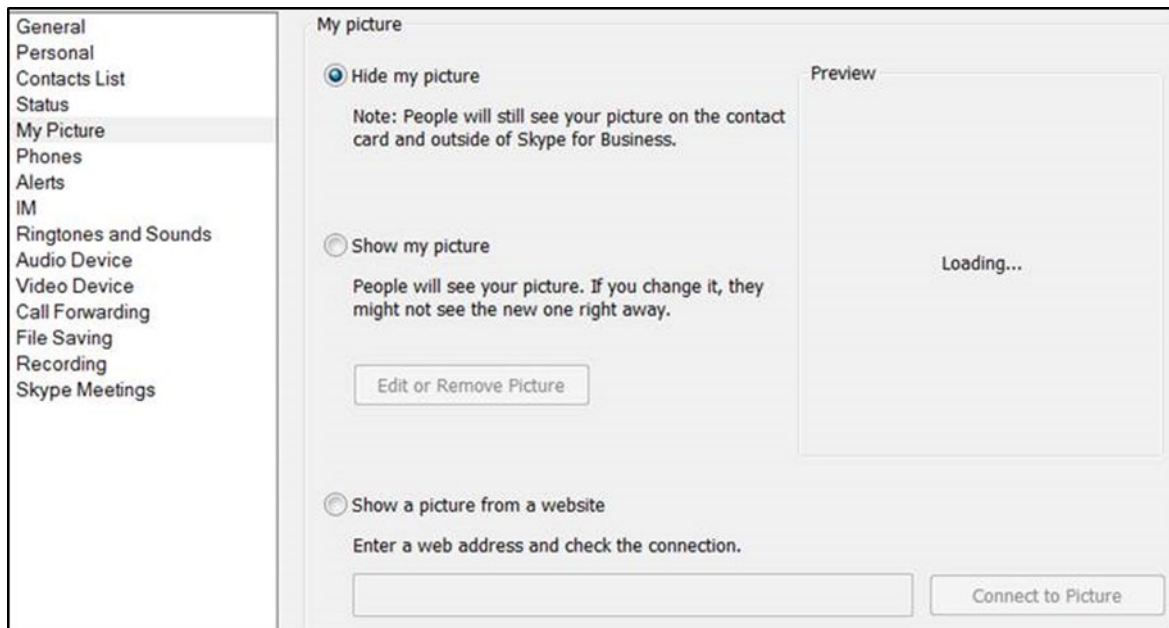

Note: If the phone does not find a contact's picture, the contact's initials [in color] are displayed instead of the contact's picture.

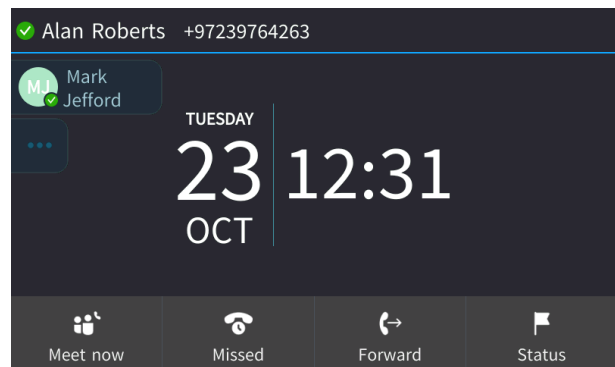
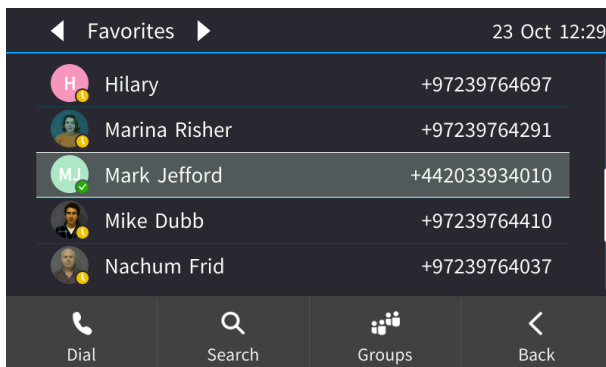

- The figure upper left shows the Favorites screen displaying MJ's initials rather than their picture
- The figure upper right shows the phone's idle screen displaying a speed dial to a contact indicated by their initials MJ rather than their picture

- The figure below shows the Calling screen displaying the called party indicated by their initials MJ rather than their picture

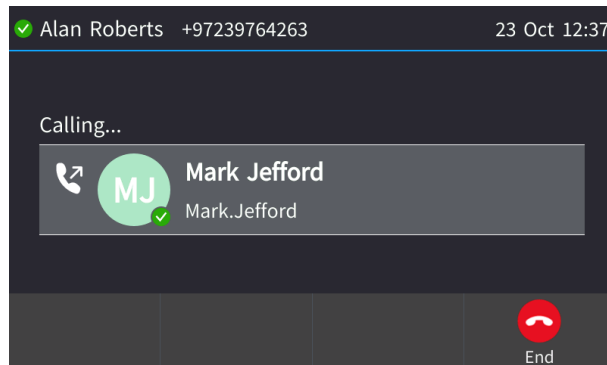

Note: Contacts' initials are also briefly displayed when opening (for example) the Calls Log before the phone finds and loads the contacts' pictures.

5.4 Enabling Call Waiting

You can enable or disable the call waiting feature.

➤ **To enable or disable call waiting:**

1. Open the **Call Waiting** screen (MENU hard key > **Settings** > **Call Waiting**).

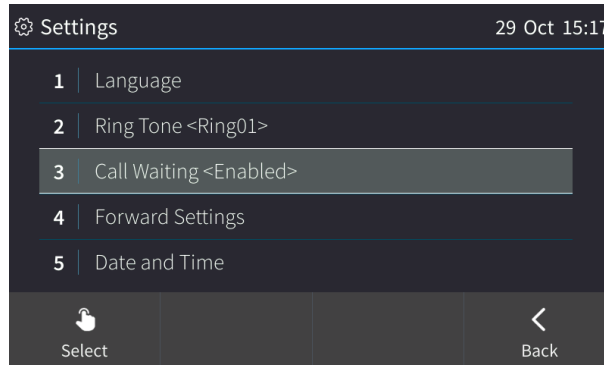

2. Navigate to and select:

- **Disable** (disables call waiting) -OR-
- **Enable** (enables call waiting) -OR-
- **Busy on Busy** (see Section 5.5.1 below)

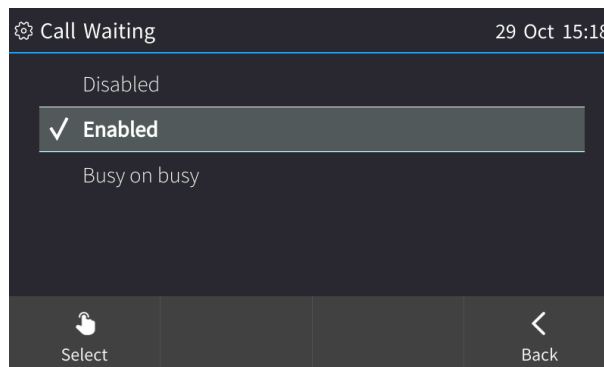

3. Touch the **Select** softkey to apply your settings.
4. Touch the **Save** softkey to save your settings.

5.5 Managing Simultaneous Incoming Calls

If two calls simultaneously come in on a phone, or if a user is in a call and a third party calls, the phone's touch screen displays them in a graphically user-friendly way.

- Simultaneous incoming calls:

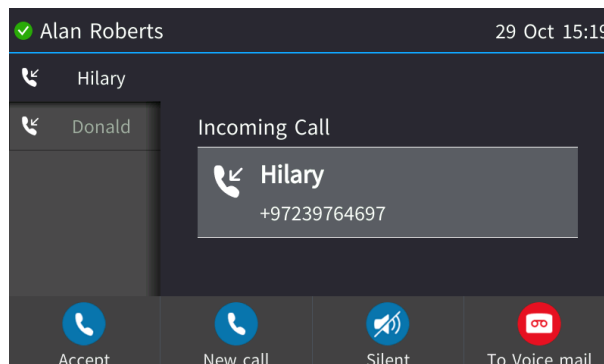

- When one of the incoming calls is answered:

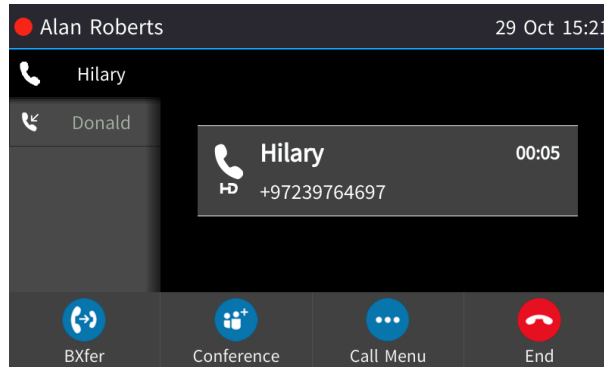

- When a phone is in a call and another comes in:

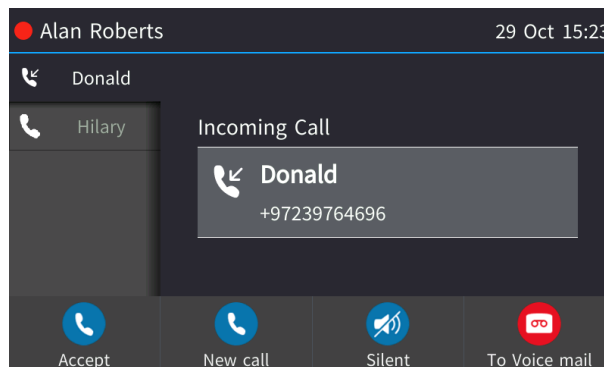

Visual indication on the device when the call comes in:

- The LED in the upper right corner of the device flashes blue.

5.5.1 Configuring Busy on Busy

If you're already in an active call on either the phone or Skype for Business client and a call comes in, the Busy on Busy feature rejects the coming call and plays a busy signal to the caller.

➤ To configure Busy on Busy:

1. Open the **Call Waiting** screen (MENU hard key > **Settings** > **Call Waiting**).

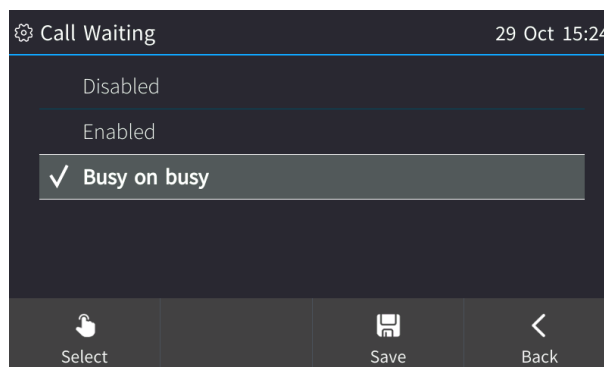

2. Scroll to and then select the **Busy on Busy** option.
3. Touch the **Save** softkey to save your settings.

5.6 Configuring Call Forwarding

This feature enables you to automatically redirect an incoming call to another phone number, including a mobile phone number if a user-defined condition is met, e.g., if the line is busy.

All Call Forwarding options available on the Skype for Business client, i.e., Call Forward with Delegation, Simultaneous ring, and Forward unanswered calls, can be configured from the phone, in compliance with Unified Communications between pc and phone. Delegates can be added directly from the phone and phones can be configured to ring simultaneously.

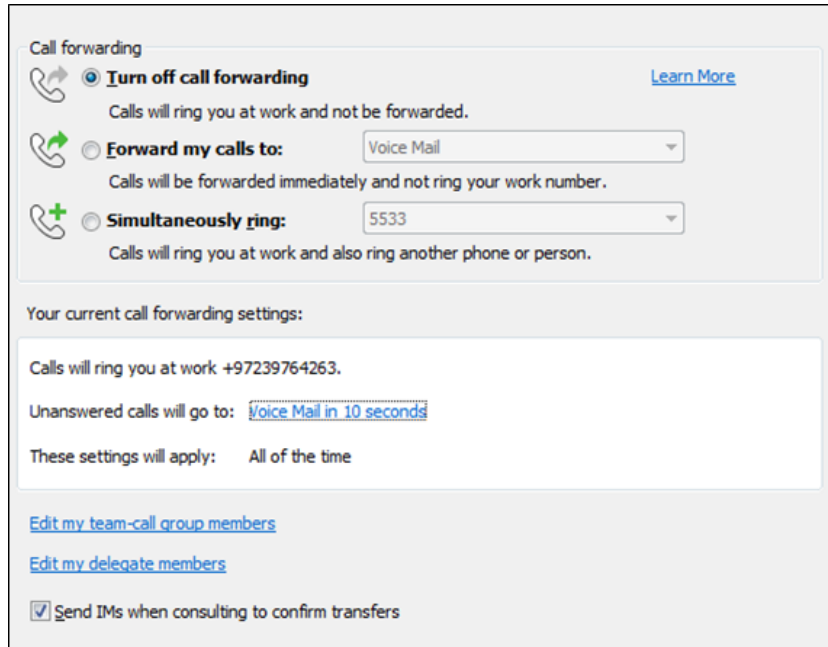

➤ **To configure call forwarding:**

1. Open the **Automatic Forward** screen (MENU hard key > **Settings** > **Forward settings** -or- touch the **Forward** softkey when the touch screen is in idle state):

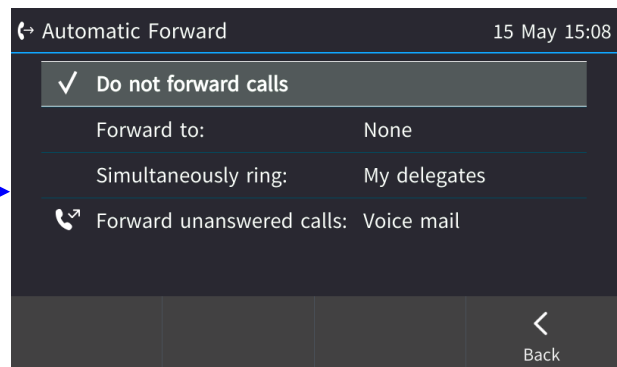
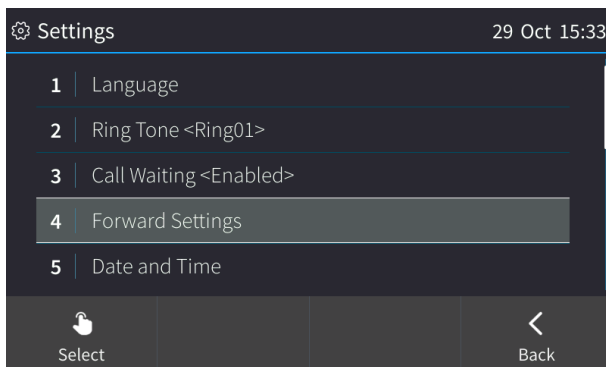

- To automatically forward all calls to voicemail:
 - In the Automatic Forward screen, navigate to 'Forward to' and then navigate to and select the **Voice mail** option.
 - Touch **Save**; you're returned to the idle screen. In the idle screen, view a check mark in the corner of the **Forward** softkey; calls will automatically be forwarded to your voicemail.
- To forward unanswered calls to voicemail:
 - In the Automatic Forward screen, navigate down to **Forward unanswered calls** and then touch the **Configure** softkey.

- In the Forward Unanswered Calls screen, navigate down to the 'After (seconds)' field and choose after how many seconds unanswered calls will automatically be forwarded to voicemail. Default: 20 seconds.
- To forward unanswered calls to a number:
 - In the Automatic Forward screen, navigate to the 'Forward unanswered calls' field and then touch the **Configure** softkey.
 - Touch the **New Number** softkey and in the New Number screen enter the number or select from the directory. Touch the **OK** softkey; you're returned to the idle screen; unanswered calls will be automatically forwarded to the number.
- 2. To configure simultaneously ring:
 - In the Automatic Forward screen, navigate to the 'Simultaneously ring' field and then navigate to **My delegates**; as with the Skype for Business client, calls will ring you at work and also ring another phone or person simultaneously.
- **To stop call forwarding:**
 - When the phone is in idle state, touch the **Forward** softkey and in the Automatic Forward screen, select **Do not forward calls**.

5.7 Making Sure the NTP Server is Enabled

Date and time are automatically retrieved from the deployed Network Time Protocol (NTP) server.



Note: If the phone's 'NTP server' setting is set to 'Disabled', inform the network administrator. Only the network administrator can change it. It must be set to 'Enabled' for date and time to be automatically retrieved from the NTP server.

➤ **To make sure the NTP server is enabled:**

1. Open the Date and Time screen (MENU key > **Settings** > **Date and Time**).

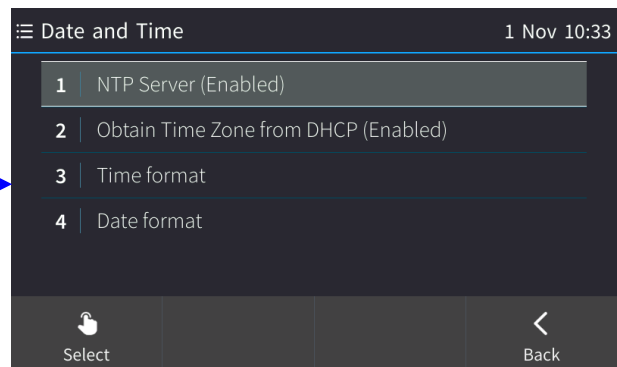
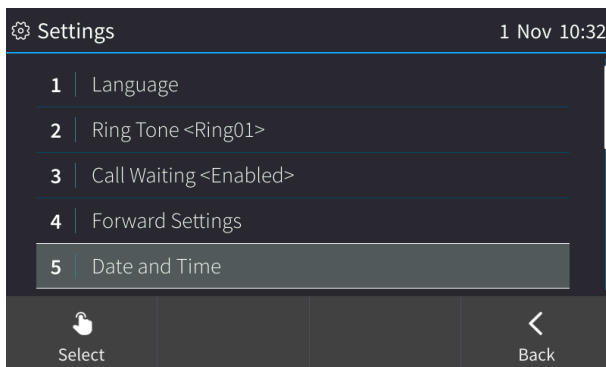

2. If not already 'Enabled', notify your network administrator.



Note: To configure the NTP server, see the *Administrator's Manual*.

➤ **To enable/disable obtaining time zone from the DHCP server:**

- In the Date and Time screen shown above, select **Obtain Time Zone from DHCP**.

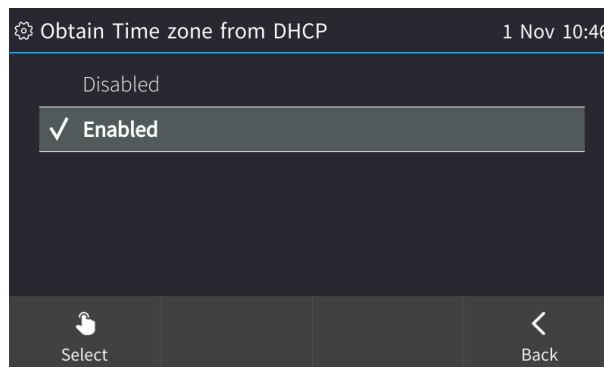

Note: If 'Obtain Time Zone from DHCP' is set to **Disabled**, inform the network administrator. Only the network administrator can change the setting on the phone because it is password secured.

➤ **To configure the time format:**

- Navigate to and select the **Time format** option and then select the format of your choice.

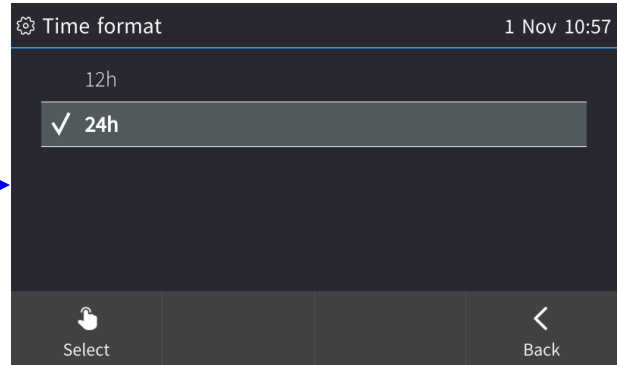
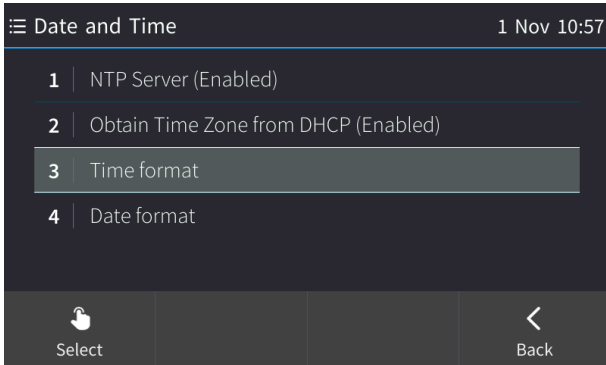

➤ **To configure the date format:**

- Navigate to and select the **Date Format** option and select the format of your choice.

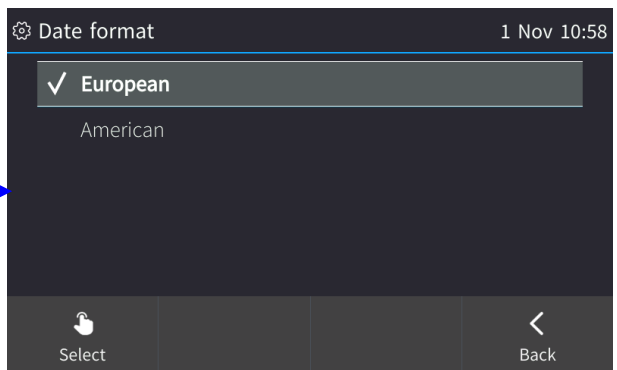
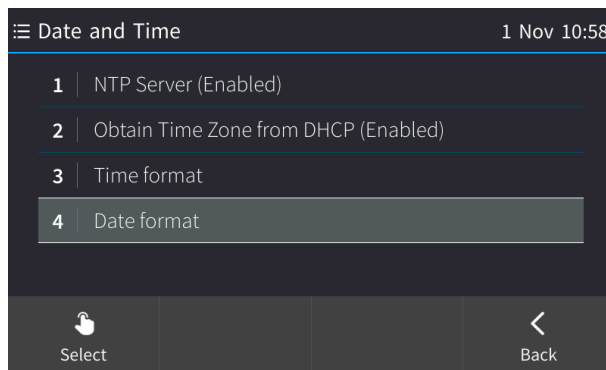

5.8 Configuring Screen Brightness

The phone's touch screen supports different brightness levels. You can choose the level that suits you best.

➤ **To configure screen brightness:**

1. Open the LCD Brightness screen (MENU hard key > **Settings** > **LCD Brightness**).

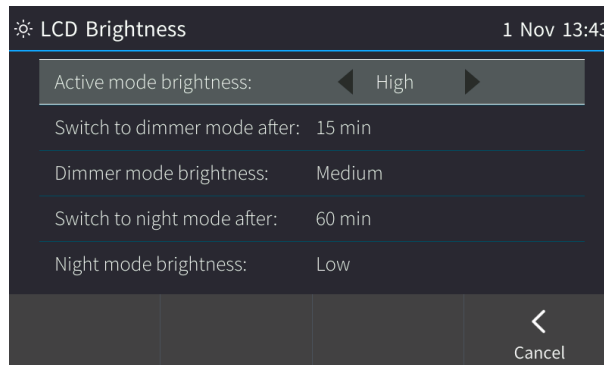

2. Touch an option and then touch < or > to navigate to the level that suits you best. Use the table below as reference.
3. Touch the **Save** softkey to apply the setting.

Table 5-1: Screen Brightness Options

LCD Brightness Option	Description
Active mode brightness	Configures the brightness of the screen when it's in 'active mode', which is - for example - after a calendar reminder pops up in your screen, or when a call comes in, or after you press a key on the dialpad, etc. <ul style="list-style-type: none"> • Low • Medium • High (default)
Switch to dimmer mode after	Defines the timeout of 'active mode', in minutes. If it expires, the screen changes to 'dimmer mode' (see the next description). Configure either 15 (default), 30, 45 or 60 minutes. <p>If your network administrator enabled Microsoft Skype for Business' online Power Save Mode feature, three Microsoft parameters apply:</p> <ul style="list-style-type: none"> • EnablePowerSaveMode • PowerSaveDuringOfficeHoursTimeoutMS • PowerSavePostOfficeHoursTimeoutMS <p>The second determines 'active mode' timeout if in working hours. The third determines 'active mode' timeout if in non-working hours. Consult your network administrator for more information.</p>

LCD Brightness Option	Description
Dimmer mode brightness	<p>Configures the brightness of the screen when it's in 'dimmer mode'. The screen changes to 'dimmer' mode after the timeout configured for 'active mode' expires (see above). You can configure either:</p> <ul style="list-style-type: none"> • Low • Medium (default) • High
Switch to night mode after	<p>Defines the timeout of 'dimmer mode', in minutes. If it expires, the screen changes to 'night mode'. Configure either 30, 60 (default), 90 or 120 minutes.</p> <p>If your network administrator enabled Microsoft Skype for Business' online Power Save Mode feature, three Microsoft parameters apply: (1) Enable/Disable (2) Timeout during work hours and (3) Timeout when out of the office. The third determines how much time in 'dimmer mode' must pass before the screen switches to 'night mode'. The screen never switches to 'night mode' when you are in the office. In the morning, when working hours start, the screen automatically switches from 'night mode' to 'dimmer mode'. The phone gets your work hours from Microsoft Exchange server, configured by your network administrator. Consult your network administrator for more information.</p>
Night mode brightness	<p>Configures the brightness of the screen when it's in 'night mode'. The screen changes to 'night mode' after the timeout configured for 'dimmer mode' expires (see above). You can configure either:</p> <ul style="list-style-type: none"> • Low (default) • Medium • High

5.9 Selecting an Answering Device

You can select which audio device (speaker or headset) is activated when you answer calls (by pressing the **Accept** softkey or lifting the handset) or when you dial calls (by pressing the number keys on the keypad and then pressing the **Dial** softkey).

The default device is the speaker.

➤ **To select the answering device:**

1. Open the Answer Device screen (MENU hard key > **Settings** > **Answer Device**).

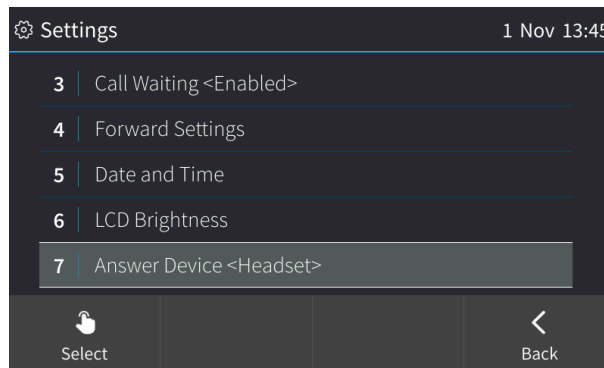

2. Navigate to and select the device (Speaker or Headset) and touch the **Select** softkey.

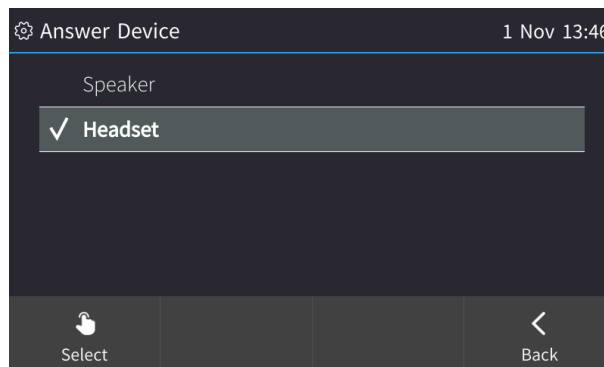

3. Touch the **Save** softkey.

5.10 Viewing your Location Information

The Location feature enables the called party to identify the geographical location of the calling party. For example, if a caller in the U.S. makes an emergency call to E911, the feature extracts the caller's information for the police department to immediately identify the caller's location.

The network administrator configures geographical location for each subnet (see the *Administrator's Manual*). After you sign in, your geographical location is downloaded via inband provisioning.



Note: If geographical location is not provisioned by the server, you're notified as shown in the figure below.

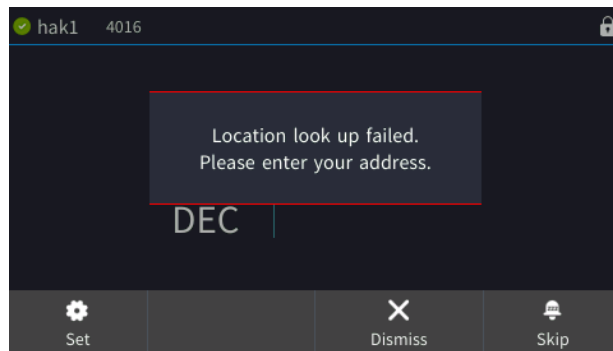

- Either **Set** the location manually, **Skip** (the screen closes but opens every few hours), or **Dismiss** ('kills' the display).
- **To view your location information:**
- Open the Location screen (MENU hard key > **Settings** > **Location**).

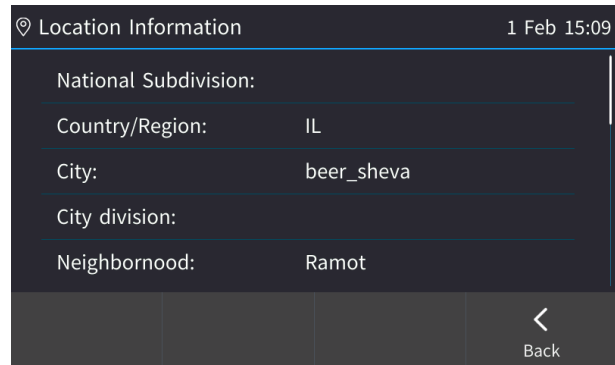
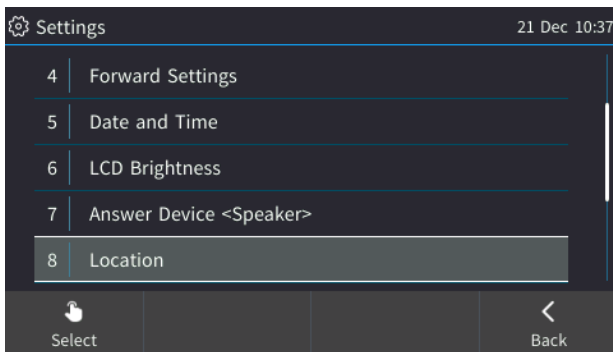

5.11 Uploading Logs to Microsoft Server

An integrated log upload feature lets you upload logs from the phone to the Microsoft server for troubleshooting and support, in compliance with Microsoft's certification requirements for 3rd party Skype for Business clients. If a user experiences an irregularity such as poor voice quality, they'll contact an AudioCodes Field Application Engineer (FAE) who will instruct them to upload and send logs for analysis. The FAE will then download the logs to their PC, perform the analysis, and provide a fix.

➤ **To upload logs:**

1. Select MENU key > **Settings** > **Log Upload**

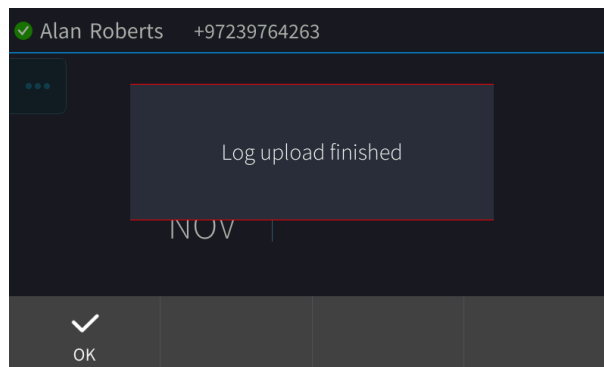
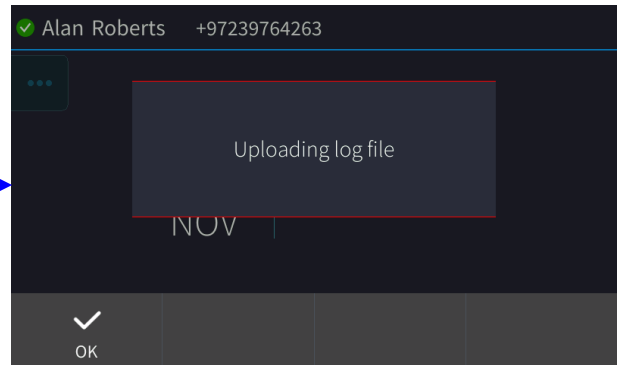
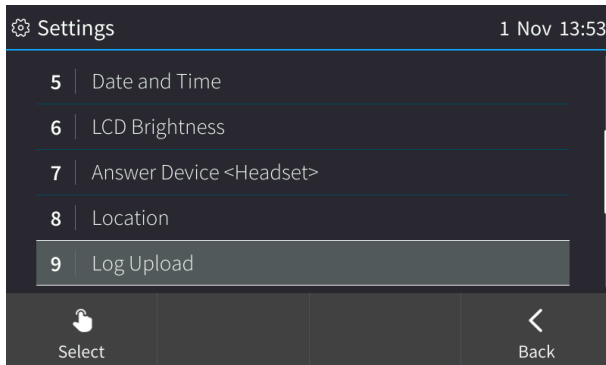

5.12 Configuring an Outbound Proxy

Skype for Business Server Multitenant Hosting Pack is a Microsoft® Unified Communications (UC) hosting solution for telecommunications and hosting providers which enables hosting partners to deploy a single instance of the server software to securely and economically host multiple tenants with a rich, fully integrated UC solution. To connect the phone to a hosted Lync environment (LHP), you need to configure the hosted service provider's domain name (FQDN).



Note: In hosted environments, it's common practice that this hosted domain name is different to the enterprise's domain name. Refer also to *400HD Series IP Phones for Skype for Business Hosting Partner (LHPv2) Environment Configuration Note*.

To configure a phone for an LHP environment, configure the address of the Outbound Proxy as the hosted service provider's domain name (FQDN).

➤ To configure the address of the Outbound Proxy:

1. Open the Outbound Proxy screen (MENU hard key > **Settings** > **Outbound Proxy**) and then set the 'Use Hosted Proxy' field to **Enabled**.

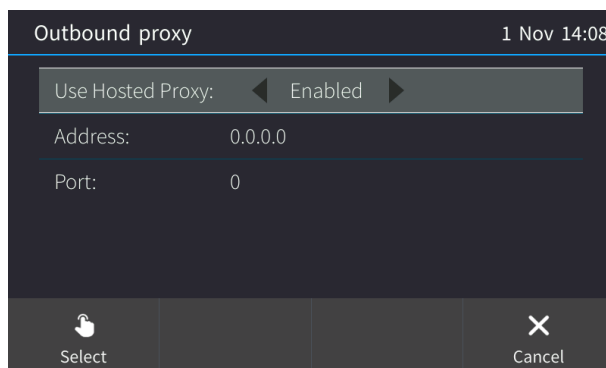

2. In the 'Address' field enter the hosted service provider's domain name (FQDN), configure the 'Port' field (default = **0**), and then touch the **Save** softkey.

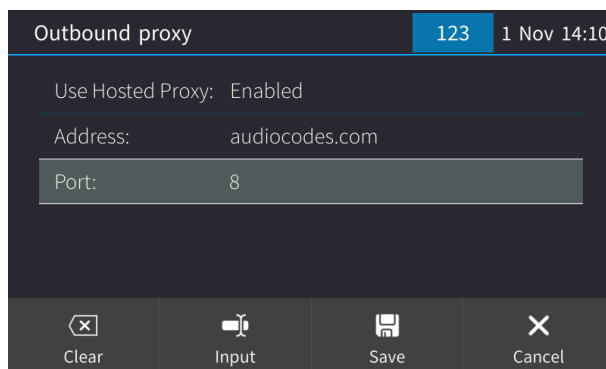

5.13 Adjusting Volume



The phone allows you to adjust

- Ring volume
- Tones volume (e.g., dial tone)
- Handset volume
- Speaker volume
- Headset volume



5.13.1 Adjusting Ring Volume

The volume of the phone's ring alerting you to an incoming call can be adjusted to suit personal preference.

➤ **To adjust ring volume:**

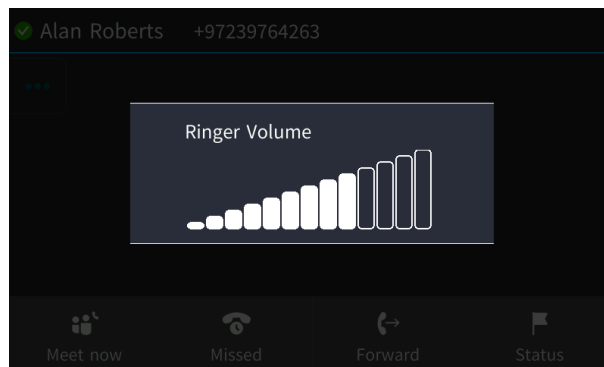
1. When the phone is in idle state, press the VOL  or VOL  key; the Ringer Volume bar is displayed on the screen.





2. Press the VOL  or VOL  key on the keypad to adjust the volume. After adjusting, the Ringer Volume level disappears from the screen.



5.13.2 Adjusting Tones Volume

The phone's tones, including dial tone, ring-back tone and all other call progress tones, can be adjusted to suit personal preference.

➤ **To adjust tones volume:**

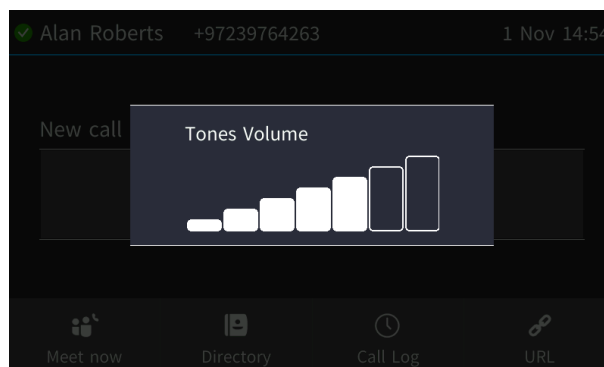
1. Off-hook the phone (using handset, speaker or headset).
2. Press the VOL  or VOL  key; the Tones Volume bar displays on the screen.



3. Press the VOL  or VOL  key to adjust the volume. After adjusting, the Tones Volume bar disappears from the screen.

5.13.3 Adjusting Handset Volume

The volume of the handset can be adjusted to suit personal preference. The adjustment is performed during a call or when making a call. The newly adjusted level applies to all subsequent handset use.

➤ **To adjust handset volume:**

1. During a call or when making a call, make sure the handset is off the cradle.
2. Press the VOL ▲ or VOL ▼ key; the Handset Volume bar is displayed on the screen.

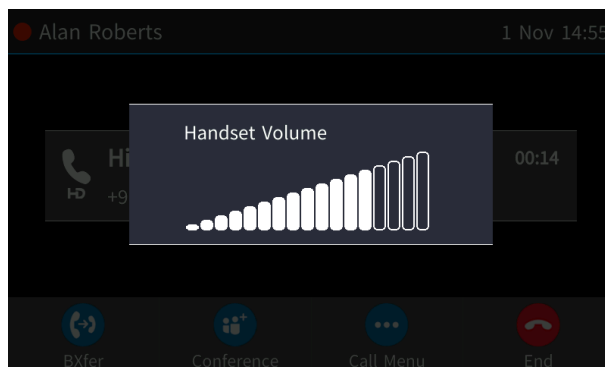

3. Press the VOL ▲ or VOL ▼ key. After adjusting, the Handset Volume bar disappears from the screen.

5.13.4 Adjusting Speaker Volume

The volume of the speaker can be adjusted to suit personal preference. It can only be adjusted *during a call*.

➤ **To adjust the speaker volume:**

1. During a call, press the speaker hard key on the phone.
2. Press the VOL ▲ or VOL ▼ key; the Speaker Volume bar is displayed on the screen.

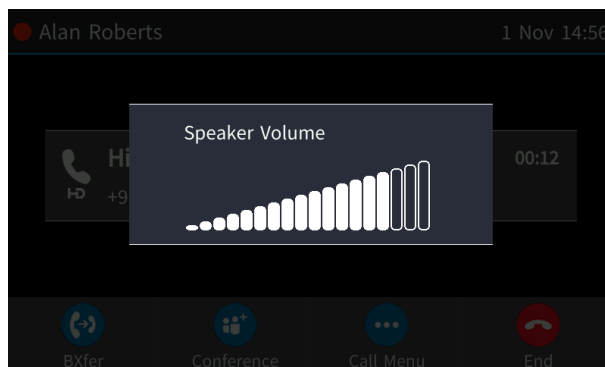

3. Adjust the volume using the VOL ▲ or VOL ▼ key. After you have completed adjusting the volume, the Speaker Volume bar disappears from the screen.

5.13.5 Adjusting Headset Volume

The volume of the headset can be adjusted to suit personal preference. It can only be adjusted *during a call*.

➤ **To adjust the headset volume:**

1. During a call, press the headset hard key on the phone.
2. Press the VOL ▲ or VOL ▼ key; the Speaker Volume bar is displayed on the screen.

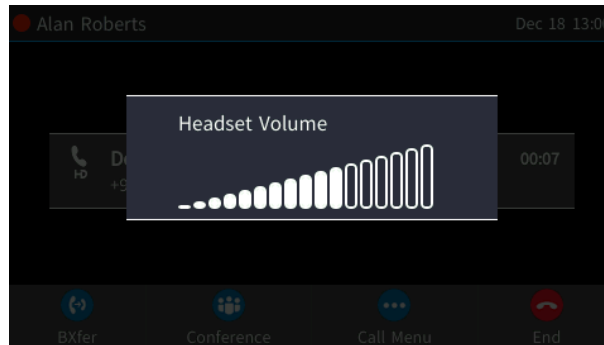

3. Adjust the volume using the VOL ▲ or VOL ▼ key.

5.14 Managing Phone Directories

The phone supports a number of directories:

- Favorites (integrated with Skype for Business client)
- Corporate directory
- Personal directory
- Outlook Contacts
- Others



Note:

- You can add, edit and delete contacts in the Personal Directory. You *cannot* in the Corporate Directory.
- You can add a maximum of 1,000 contacts to your Personal Directory. After adding a contact, you can call the contact directly from the directory. If you receive an incoming call from a contact listed in the directory, the touch screen displays the name listed.
- The Personal Directory and Corporate Directory display the presence status of contacts if your network administrator set them up in the Microsoft Skype for Business server (see the *Administrator's Manual*).
- If you assign a speed dial key to the contact, you can press it to call them.

5.14.1 Accessing Directories

All directories can be accessed from the CONTACTS hard key on the phone.

➤ To access the Skype for Business client Favorites directory:

- Press the CONTACTS key on the phone.

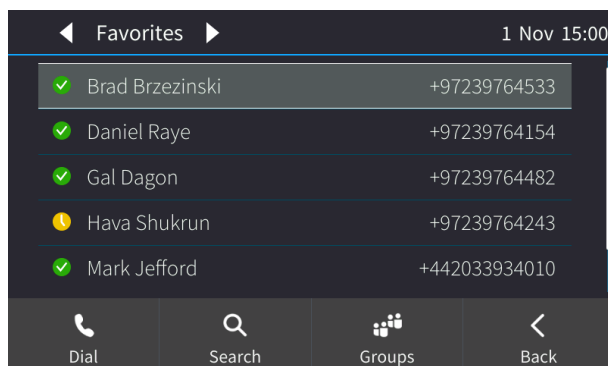

➤ To access other directories:

- Press the **Groups** softkey and select the directory of your choice from the 'Contact groups' screen shown below.

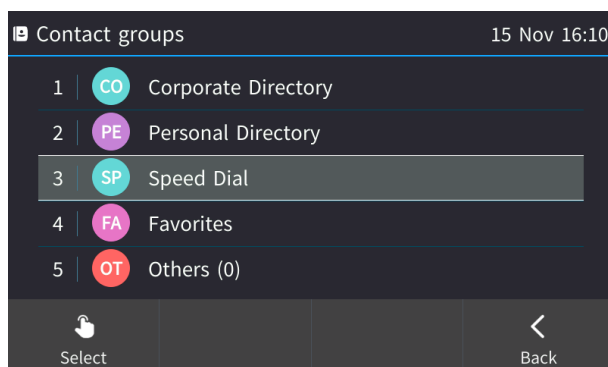

Note that you can also access your Speed Dials from this screen.

5.14.2 Adding a Contact to the Personal Directory

The home number, office number, mobile number and/or SIP URI of a contact can be added to the Personal Directory. You can also configure a speed dial to place calls quickly to the contact (see Section 5.16). After adding the contact, you can search for them in the group, dial them, edit their contact information or delete them.



Note: You can add a maximum of 1,000 contacts to your Personal Directory. After adding a contact, you can call the contact directly from the directory. If you receive an incoming call from a contact listed in the directory, the touch screen displays the name listed.

➤ **To add a contact to the Personal Directory:**

1. Open the Personal Directory (CONTACTS key > **Groups** softkey > **Personal Directory**) and select **+ New Contact**.

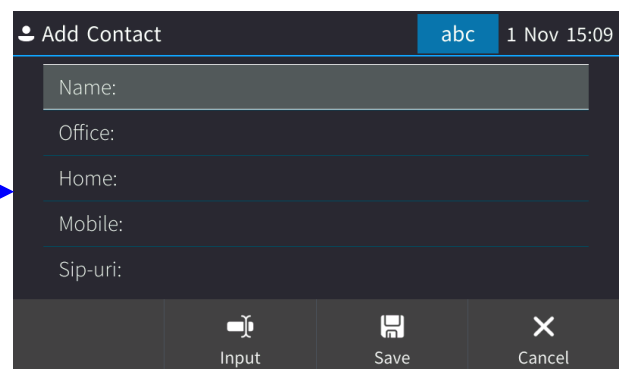
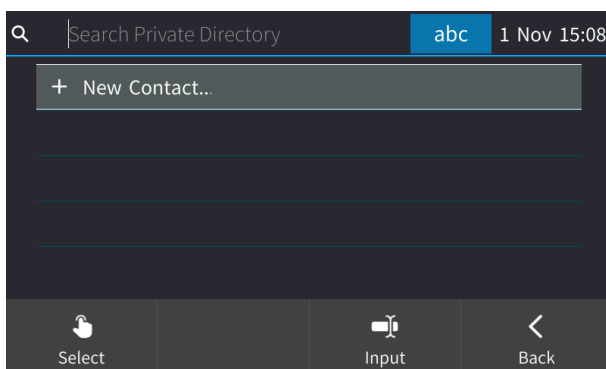

2. In the 'Modify Contact' screen, key in the 'Name' of the new contact (see Section 3.4 for detailed instructions).
3. Navigate down and key in the new contact's office phone number (see Section 3.4 for detailed instructions).
4. Optionally, navigate down and key in the new contact's home and mobile numbers as well.
5. Optionally, navigate down and enter the contact's SIP URI, e.g., mike.dubb@audiocodes.com. This option is useful if you don't know their phone number.
6. Touch the **Sp. Dial** softkey to assign a speed dial key if required:

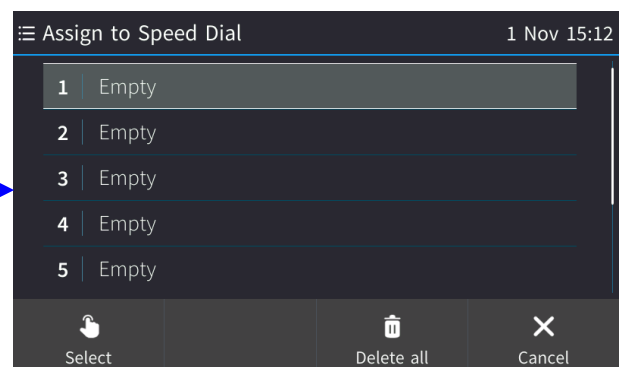
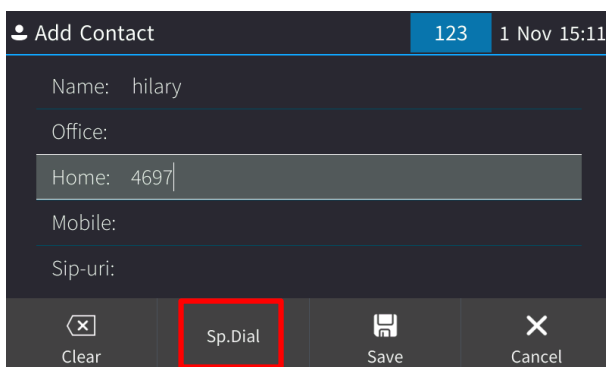

7. Optionally, touch the **Select** softkey; a speed dial key is assigned to the contact.
8. Touch the **Save** softkey; 'Contact Saved' is displayed.
9. To view the assigned speed dial, navigate down to the contact's name and touch the **Details** softkey:

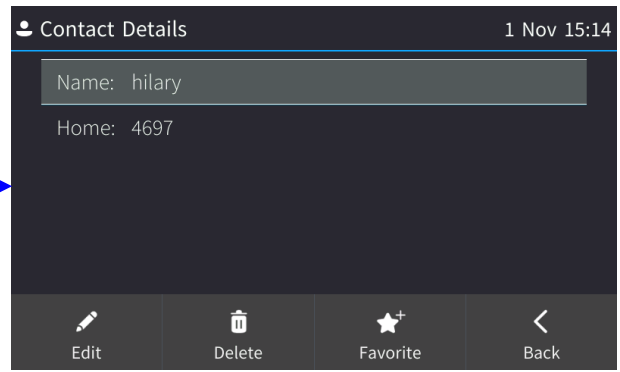
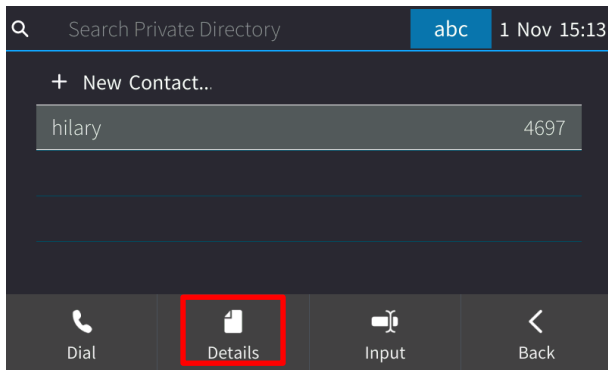

5.14.3 Editing Contact Information in the Personal Directory

This section shows how to edit contact information in the Personal Directory.

➤ **To edit contact information:**

1. Access the Personal Directory (CONTACTS hard key > **Groups** softkey > **Personal Directory**).
2. Navigate to the name of the contact to edit:

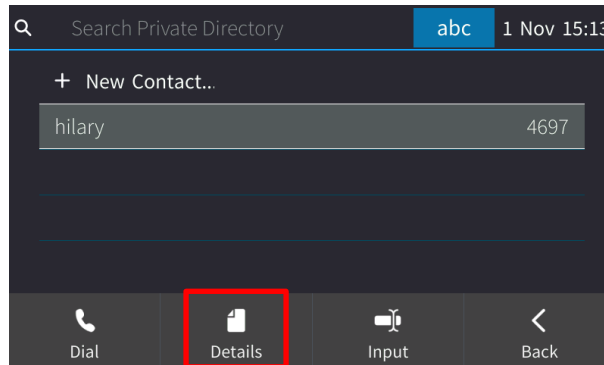

3. Touch the **Details** softkey:

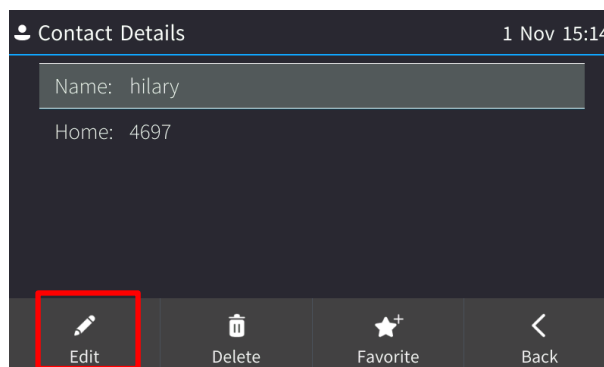

4. Touch the **Edit** softkey:

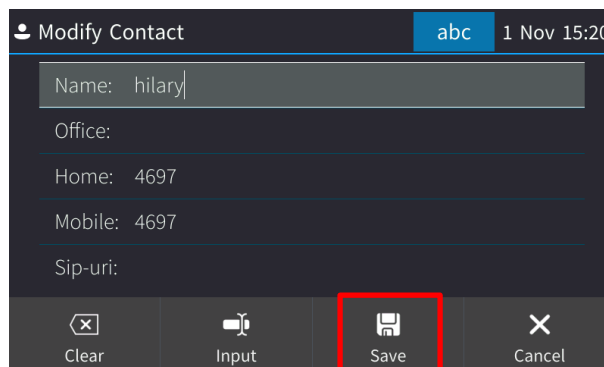

5. Modify the contact's details and touch the **Save** softkey.



Note:

- The Corporate Directory cannot be modified.
- Only the Personal Directory can be modified.

5.14.4 Deleting a Contact from the Personal Directory

This section shows how to delete a contact from the Personal Directory.

➤ **To delete a contact from the Personal Directory:**

1. Access the Personal Directory (CONTACTS hard key > **Groups** softkey > **Personal Directory**).
2. Navigate to the contact to delete.

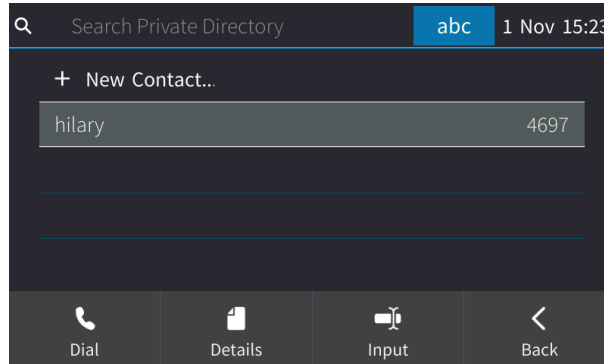

3. Touch the **Details** softkey; the contact details are shown.

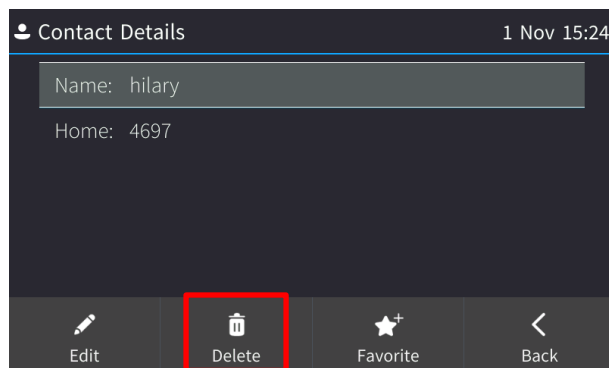

4. Touch the **Delete** softkey; a 'Delete current contact?' warning message appears.
5. Touch the **Yes** softkey to remove the contact from the phone directory or **No** if you want to keep the contact in the directory; the contact is removed from the directory.



Note:

- Corporate Directory contacts cannot be deleted.
- Only Personal Directory contacts can be deleted.

5.14.5 Adding a Person to Favorites after a Call with them is Logged

This section shows how to add a person to the Favorites directory after a call with them is logged.



Note: A maximum of 1,000 people can be added to the Favorites directory.

➤ **To add a person to your Favorites directory:**

1. Open the Call Log (MENU key > **Call Log**).

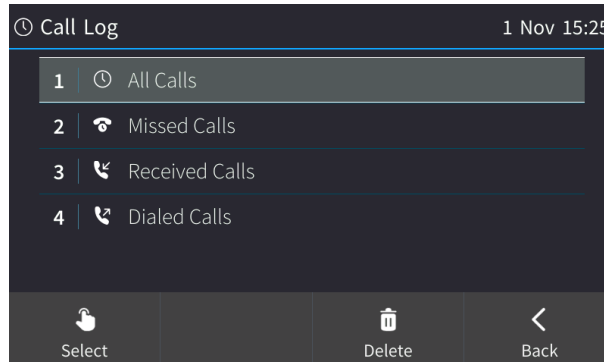

2. Select the call log:

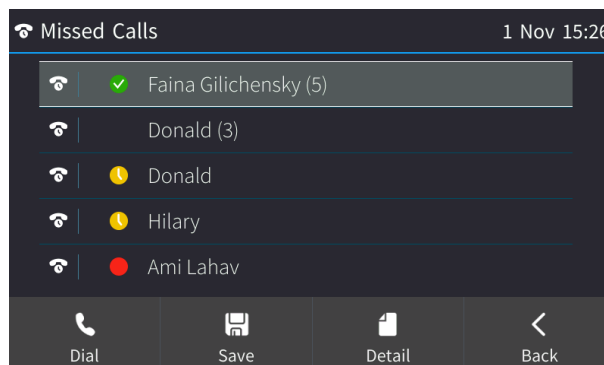

3. Select the person with whom the call was made and then touch the **Detail** softkey.

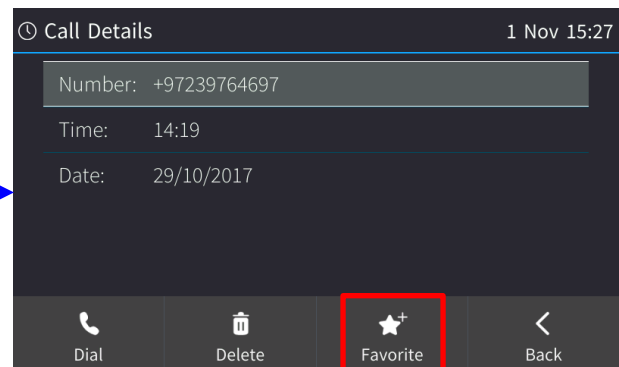
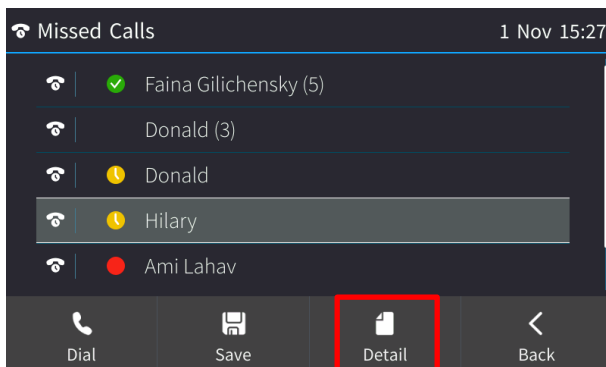

4. In the Call Details screen, touch the **Favorite** softkey; you're notified 'Successfully added to Favorites'. The person is added to your Favorites.



Note: You can also add a person to the Favorites directory from the Corporate Directory, Outlook Contacts, Personal Directory and (User) Groups, through the 'Contact details' screen's **Favorite** softkey, shown below.

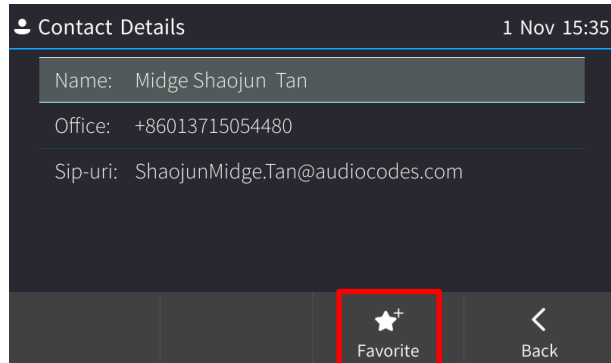

5.14.6 Removing a Person from Favorites

You can remove a person from the Favorites directory.

➤ **To remove a person from the Favorites directory:**

1. Open the Favorites directory (MENU key > **Favorites**).
2. Navigate to the person to remove and press the **OK** navigation control; the Contact Details screen opens.
3. Press the **Unfavorite** softkey; the person is removed from the Favorites directory.

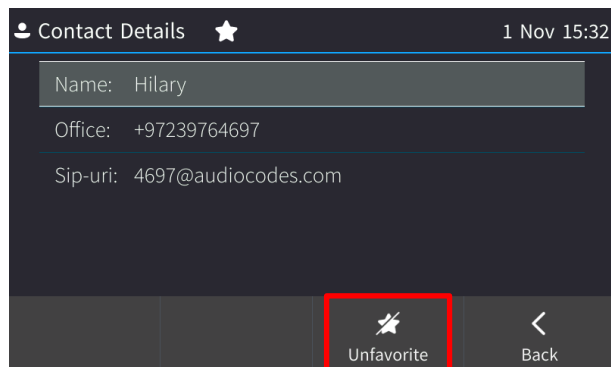

5.14.7 Adding a Distribution Group to Favorites

This feature allows you to view users who are members of Active Directory distribution groups (preconfigured as Favorites in the Skype for Business client) on the phone screen. With the feature, users from distribution groups can be called, invited to conference calls, etc.

From the Skype for Business client, add a Distribution Group to the Skype for Business client's Favorites directory, view the group in the phone screen, open it and navigate to a group member and call them.

The feature enhances Unified Communications between phone and pc (Skype for Business client).

➤ **To add a Distribution Group to the Favorites directory:**

1. From Skype for Business client, add a Distribution Group to your Favorites directory, right-click and from the popup menu choose **Add to Contact List**.

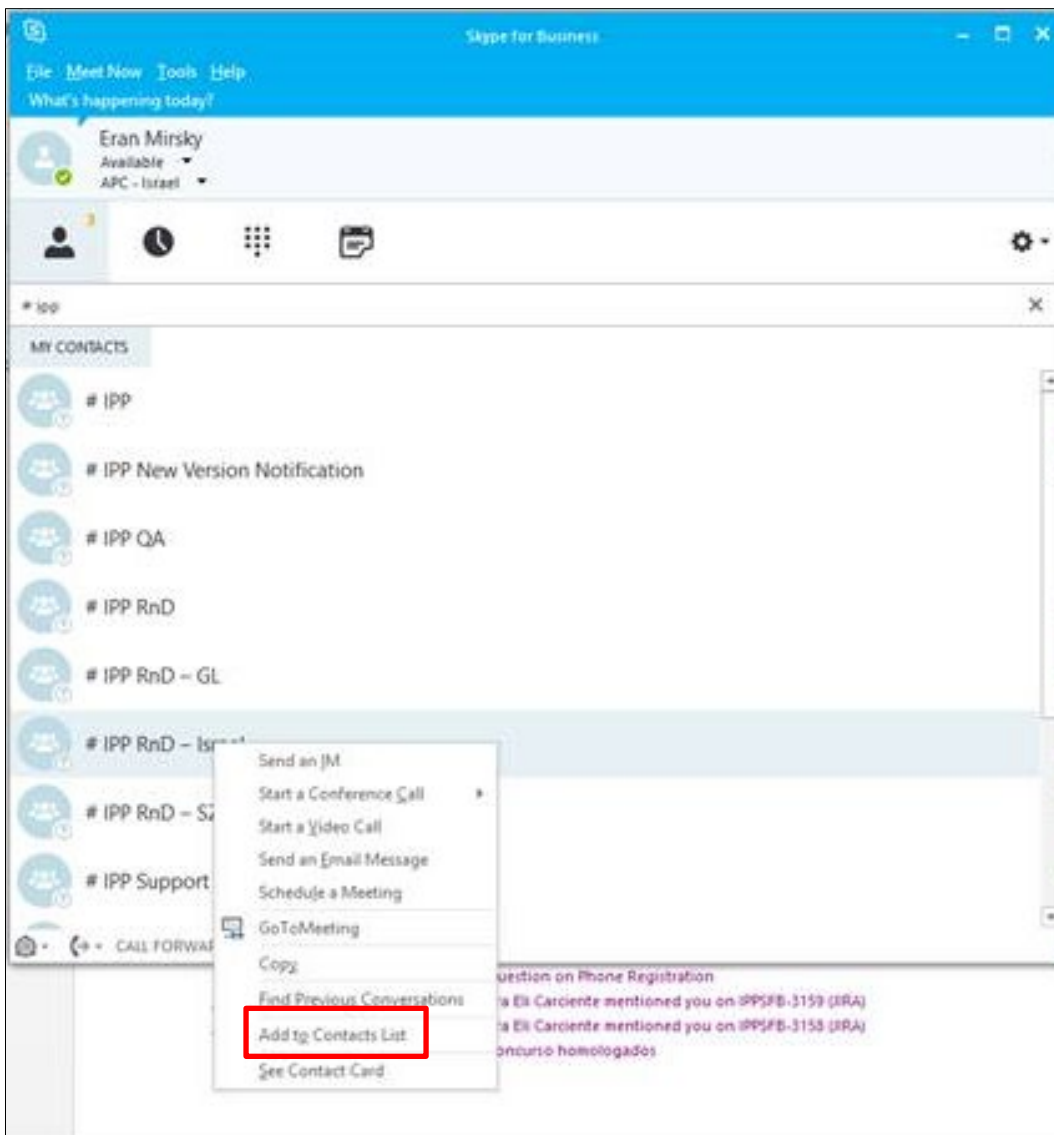

2. On the phone, open the Contact groups screen (**Contacts > Contact groups**) and make sure you can view this group, select it and view group members.



Note: A group of more than 100 members cannot be fully expanded.

5.14.8 Searching for a Contact in a Directory

The search feature lets you quickly and easily locate a contact in a directory. The feature is especially useful if you have a long list of contacts.



Note: When searching in the Corporate Directory, the T9 feature is available. See the next section for details.

➤ **To search for a contact:**

1. Access the phone directory.
2. Search for a contact:
 - Scroll down to the contact in the list
 - OR-
 - Key the first letter in the contact's name; the directory locates contacts whose names begin with that letter. For example, as you press the **J** key to search for contact Jerry, the directory locates contacts whose names begin with **J**. As you key in the next letter, i.e., **e**, contacts whose names begin with **Je** appear, etc.

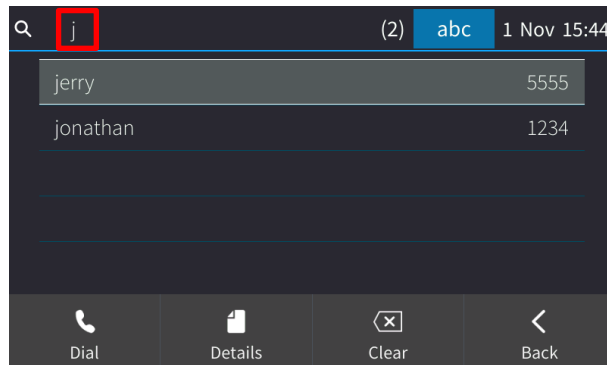

5.15 Searching for a Contact in the Corporate Directory using T9



Note: Applies to searching for a contact in the Corporate Directory.

The T9 (Text on 9 keys) feature lets you press (once) the **1** key on the dialpad to input the letter **A** (for example). So to input **Alan** you can press **2526**. T9 supports predictive search so as letters are entered, possibilities are displayed before you finish entering the name. If the name **Alex** (for example) appears many times in the directory, users can enter **alex**, space (*), and then the first letter of the family name.

➤ **To access a contact in the Corporate Directory using T9:**

1. Open the Corporate Directory (press the CONTACTS hard key and select **Corporate Directory**).
2. **T9** is enabled by default. On the dialpad, press (once) the key containing the first letter in the contact's name, for example, **A**. Press (once) the key containing the second letter, for example, **L**. Press (once) the key containing the third letter, for example, **E**. If necessary, press (once) the key containing the fourth letter, for example, **X**.

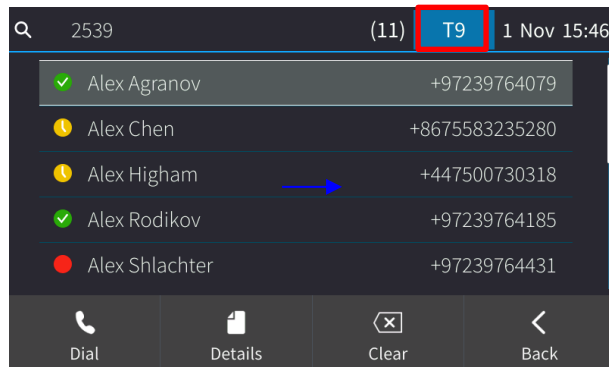

3. If you need to, press the * key on the dial pad to enter a space, and then enter the first letter of the family name.

5.15.1 Searching for a Contact Using A/a/1 Instead of T9

You can search for a contact in the Corporate Directory using A/a/1 instead of the default T9.

➤ **To change to A/a/1:**

1. Open the Corporate Directory (press the CONTACTS hard key and select **Corporate Directory**).
2. In the directory, touch the **Input** softkey.

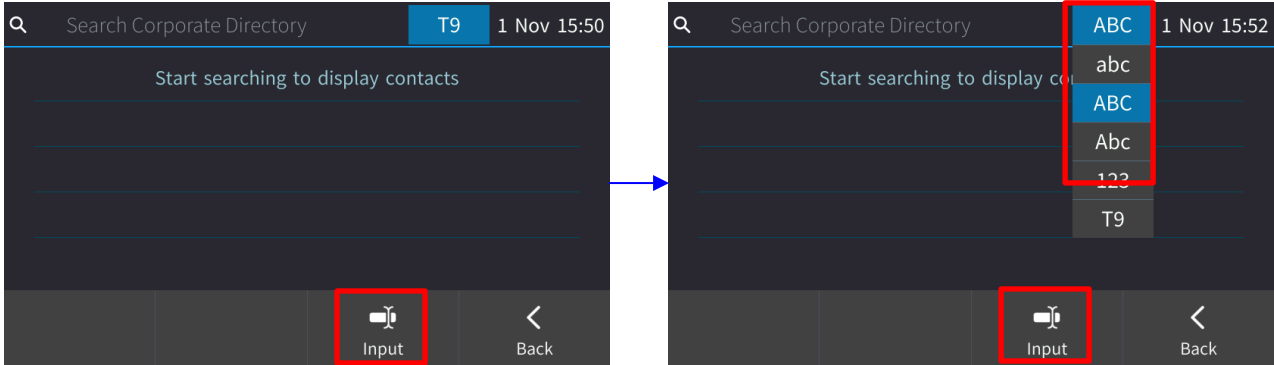

3. If you're searching for **Alex** (for example), on the dialpad press once the **2** key, press three times the **5** key, press twice the **3** key, and if necessary, press twice the **9** key.

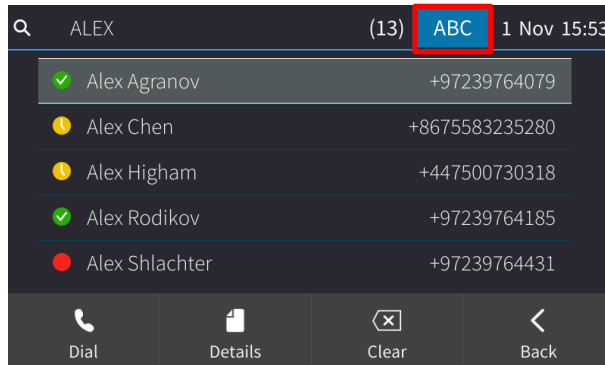

4. If necessary, you can press the * key on the dial pad to enter a space, and then enter the first letter of the family name.

5.16 Configuring a Function Key as a Speed Dial

Any of the 1-8 Function Keys can be configured as a Speed Dial in the phone's idle screen. Any of the Function Keys in the Expansion Module can also be configured as a Speed Dial. The instructions below apply to the idle screen but the principle is identical in the Expansion Module.

➤ **To configure a Function Key as a Speed Dial:**

1. In the phone's idle screen, touch the ... button. [The identical button is displayed in the Expansion Module].

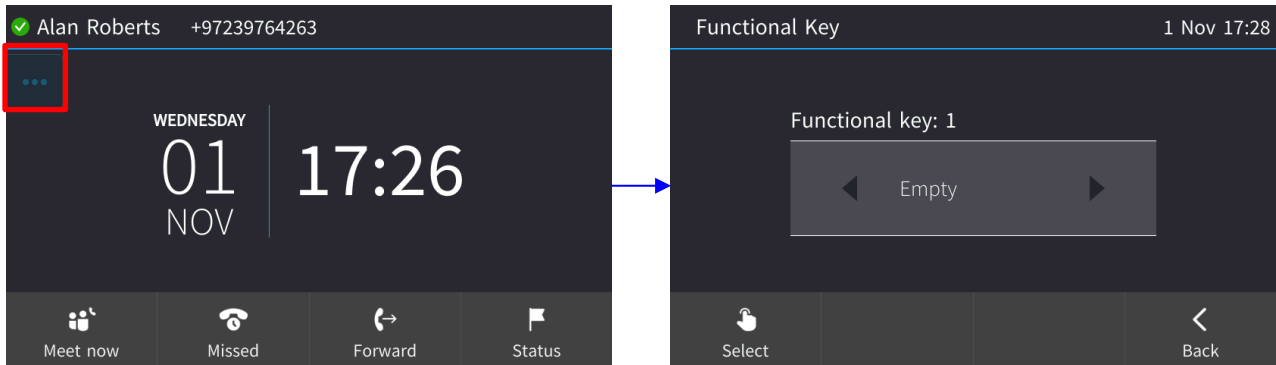

Note: Alternatively, you can press the MENU key, touch the **Keys** item and then in the Function Keys screen that opens, select an 'Empty'.

2. Touch < or > to navigate to and select **Speed Dial**.

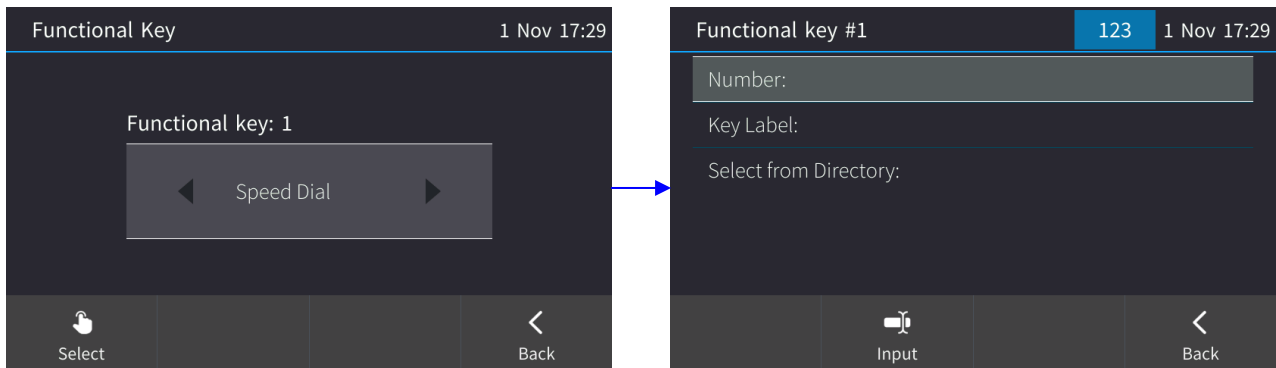

3. Configure the 'Number' and 'Key Label' fields or navigate down to select the **Select from Directory** option.

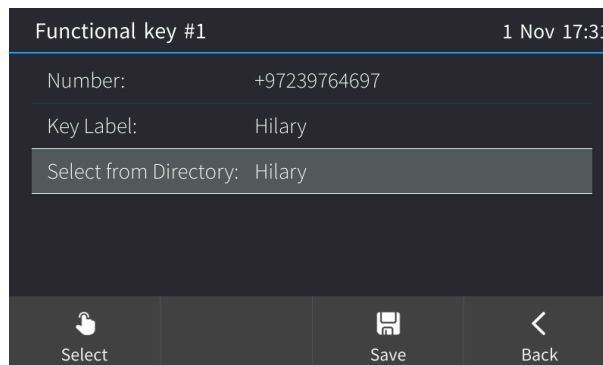

4. Touch the **Save** softkey; the touch screen reverts to idle mode displaying the name of the contact you configured ('Hilary', in this example):

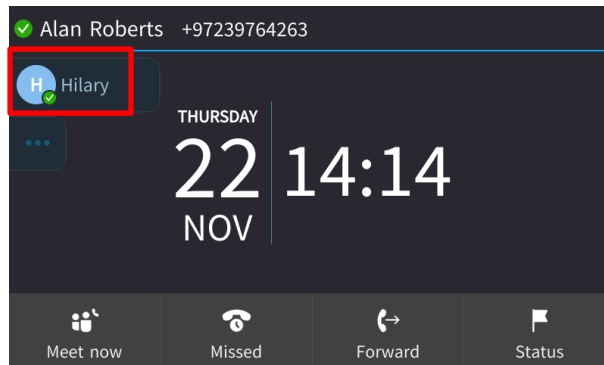

5. To determine presence status, refer to the figure below. In the figure above, Hilary's presence status is 'Available'.

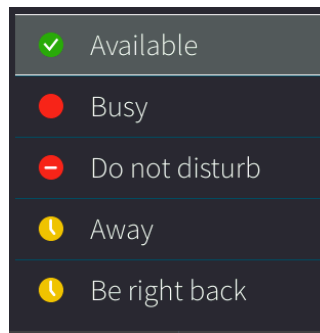

6. To quickly place a call, touch **Hilary** in the idle screen; the number is dialed. See Section 7.4 for more information.

5.16.1 Configuring Pause Dialing for a Speed Dial to an Ext. behind an IVR

Your network administrator can configure pause dialing for a Speed Dial, in order to create a time break. This is typically required for a Speed Dial which dials a destination extension number that is behind an Interactive Voice Response (IVR) system.



Note: Consult your network administrator if you need a pause dialing configured for a Speed Dial. See the *Administrator's Manual* for more information.

5.16.2 Deleting a Speed Dial

➤ **To delete a Speed Dial:**

1. Long-press the Speed Dial displayed in the idle screen.

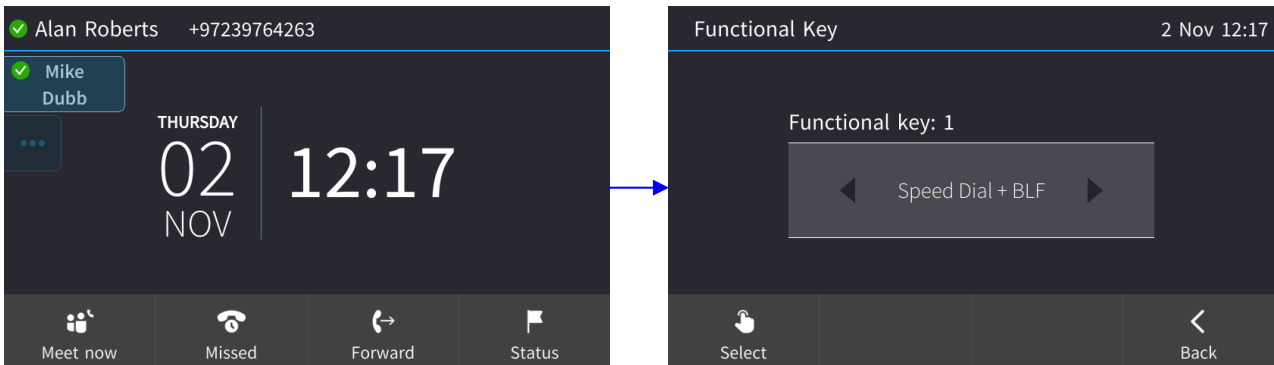

2. Touch < to navigate to and select **Empty**.

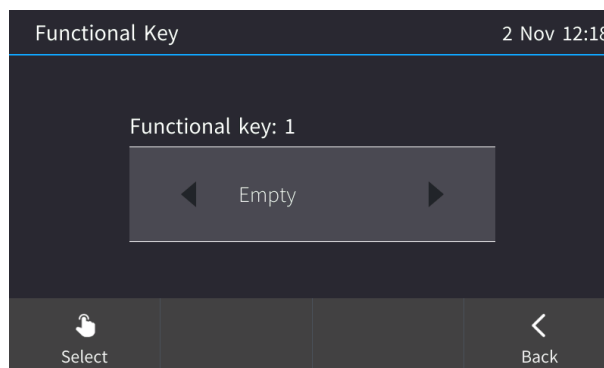

3. You're returned to the idle screen; the Speed Dial is removed.

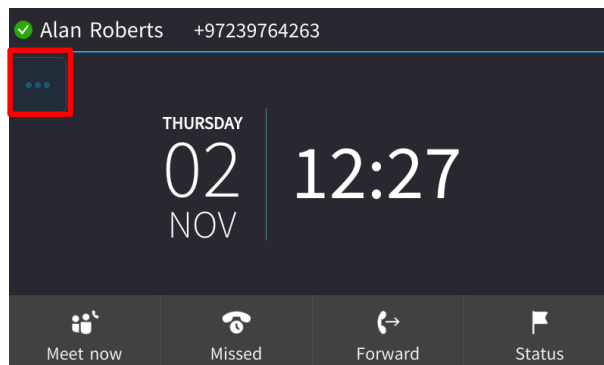

5.17 Configuring a Function Key as Speed Dial in the Expansion Module Screen



Note: Only applies to users of the C450HD phone with the Expansion Module option.

Users of the *C450HD phone with the Expansion Module* can configure up to 22 speed dials in the Expansion Module's high-resolution full-touch color screen, in addition to the 1-8 Function Keys that can be configured *in the phone screen* as Speed Dials (see the previous section for more information).

Figure 5-1: C450HD Phone with Speed Dials Configured in the Expansion Module Screen

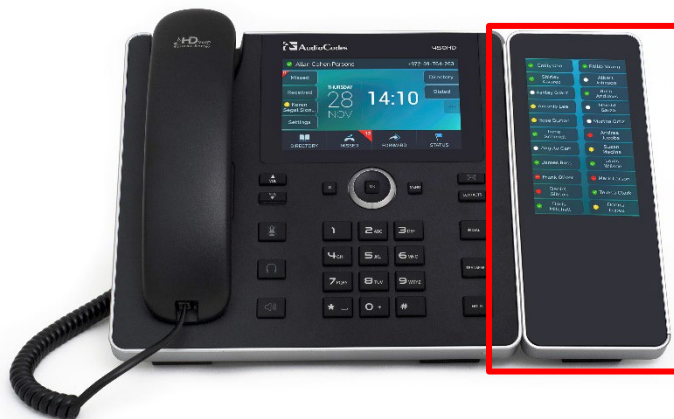

- **To configure a Function Key as a Speed Dial in the Expansion Module screen:**
- 1. In the phone's Expansion Unit Module, touch the ... button shown in the figure below..

Figure 5-2: Configuring a Speed Dial in the Expansion Module Screen

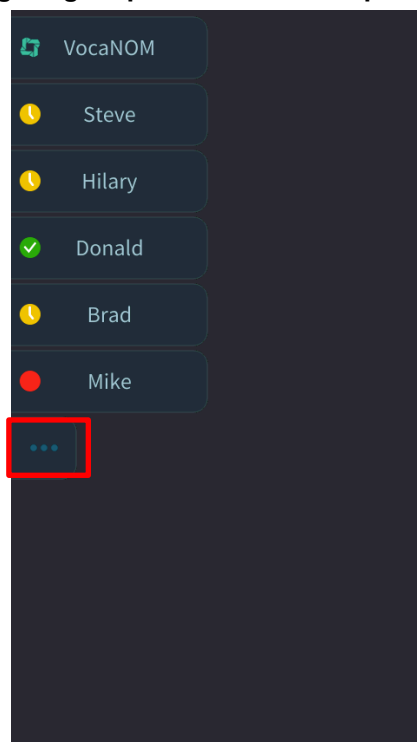

2. View in the *phone unit's interface* the Function Key screen that opens.
3. Proceed exactly as described in the previous section:
 - Use the navigation control to navigate to and select **Speed Dial**.
 - Configure the 'Number' and 'Key Label' or select the **Select from Directory** option.
 - Touch **Save**.
4. View now in the *Expansion Module screen* the name of the contact and their presence displayed.
1. To determine presence status, use this figure as reference:

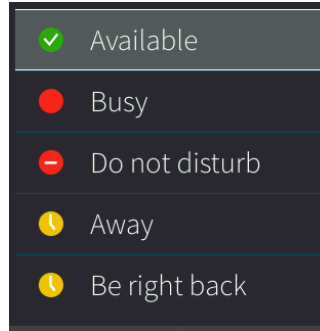

2. To quickly place a call, touch a contact's label in the Expansion Module screen; the number is automatically dialed. See Section 5.20 for more information.

5.18 Configuring a Function Key as a Key Event

Any of the 1-8 Function Keys can be configured as a Key Event. In the figure below, for example, Function Key 1 has been configured as a 'Calendar' Key Event. Pressing it opens the Calendar screen.

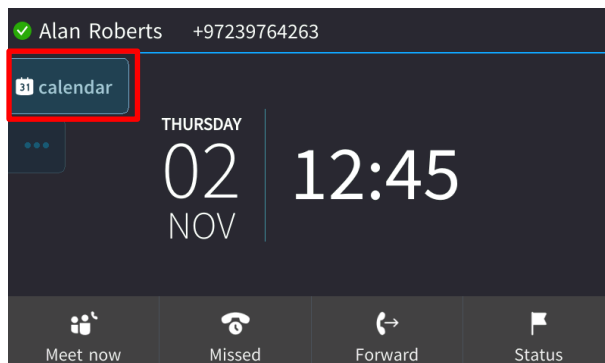

Note: For the calendar to be displayed, you need to have signed in with User Name and Password. If you haven't, you're notified 'Calendar is not available for PIN code login'. See also under troubleshooting in Section 0 and under sign-in in Section 3.5.2.

Other Key Events you can configure:

- Missed Calls
- Received Calls
- Dialed Calls
- Directory
- DnD All
- Forward All

The section below shows how to configure a Function Key as a Key Event.

➤ To configure a Function Key as a Key Event:

1. Open the Function Keys screen (press the MENU key and then touch the **Keys** option).

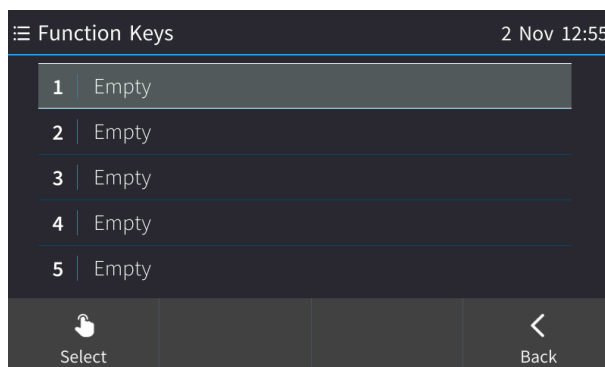

2. Select an 'Empty' key. If necessary, navigate down to one using the lower rim of the navigation control button on the phone.

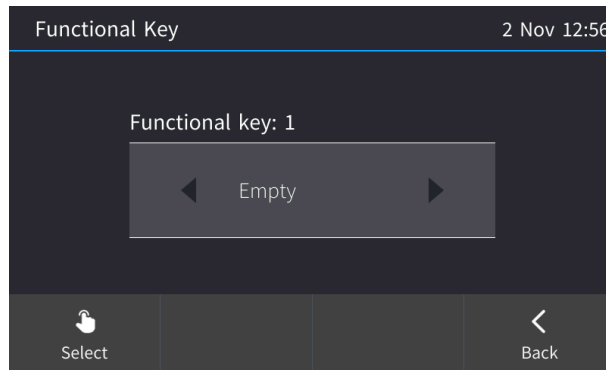

3. Press the right or left rim of the navigation control button to select **Key Event**.

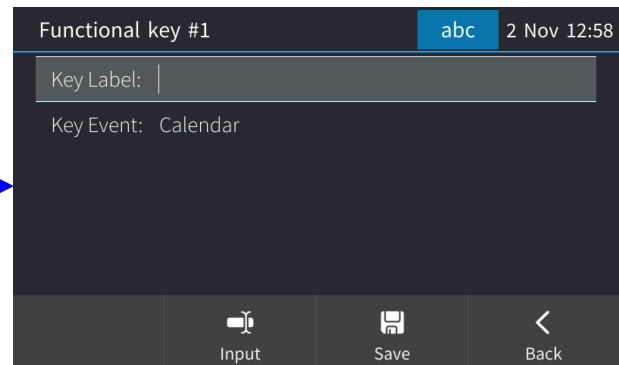
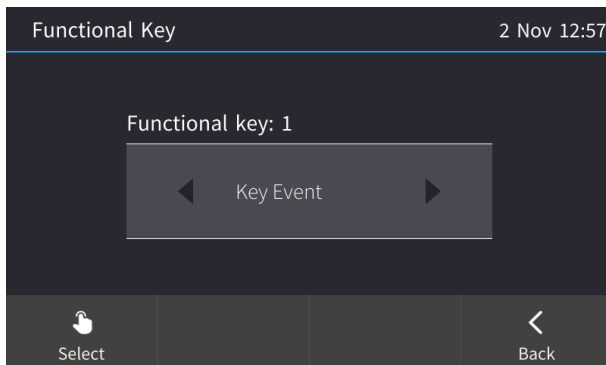

4. In the 'Key Label' field, define an identifier that you'll easily identify in your idle screen. Touch the **Input** softkey to select capital | small letters or numbers.
5. Touch the 'Key Event' field and then touch < or > to navigate to and select the Key Event you want to configure, for example, 'Calendar' (default).

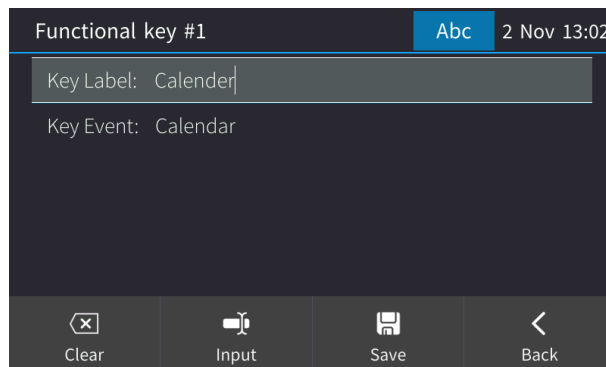

6. Touch the **Save** softkey; the touch screen reverts to idle mode displaying the Key Event you configured ('Calendar' in this example).

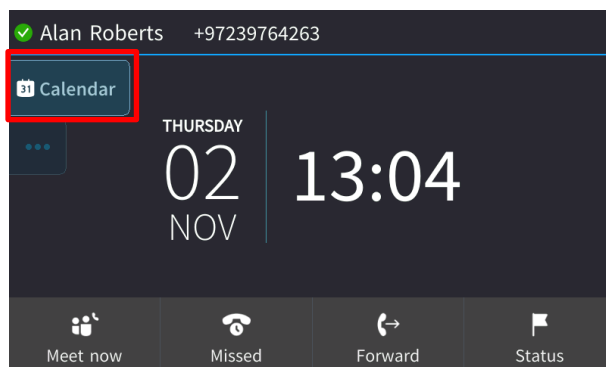

5.19 Configuring a Function Key for Direct Voice Dialing

The phone is directly integrated with AudioCodes' Voca services to allow voice dialing to any other user in same corporate directory. To enable the service, the user must add a VocaNOM function key.



Note: The network administrator must enable the feature and configure the VocaNOM IP address service on the phone for the Function Key to be activated. See the *Administrator's Manual* for more information.

VocaNOM allows voice-dialing colleagues by touching the VocaNOM key in the phone's idle screen or in the Expansion Unit screen. A beep is played and then a voice prompt requests first and last name or department. The caller articulates the first and last name and then at the prompt, articulates "Office" or "Mobile". The VocaNOM service then directly dials the requested party according to the instructions articulated by the user.

When the service identifies the requested party, the phone dials their number just as it does in a regular call. Later, the user can press the REDIAL hard key on the phone and view the call logged in the phone's 'Dialed Calls' just like with any other call.

The VocaNOM voice-dialing feature increases day-to-day work productivity.

➤ To configure a Function Key for direct voice dialing:

1. Open the Function Keys screen (press the MENU hard key and then touch the **Keys** option) and then select any of the 'Empty' 1-8 Function Keys.

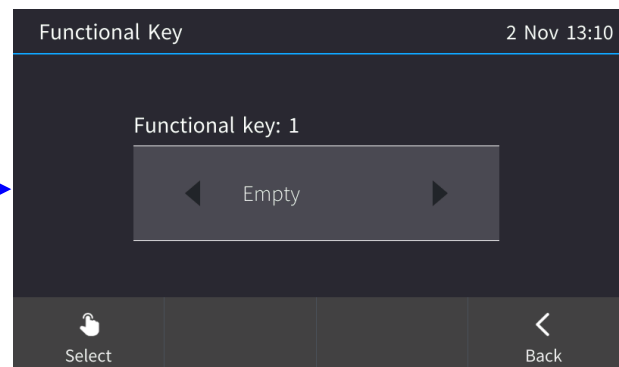
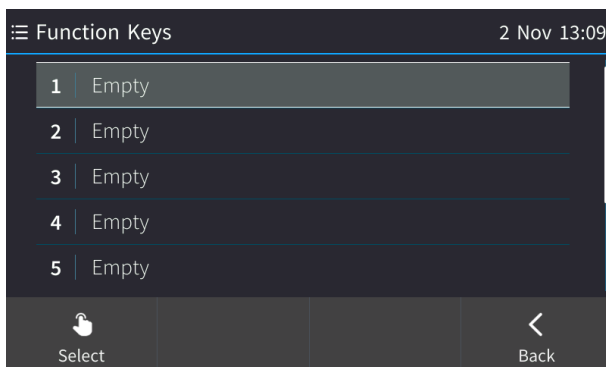

2. Touch < or > to navigate to and select **Voca** and then make sure the key is displayed in the idle screen and that it is active. If it isn't active, consult your network administrator.

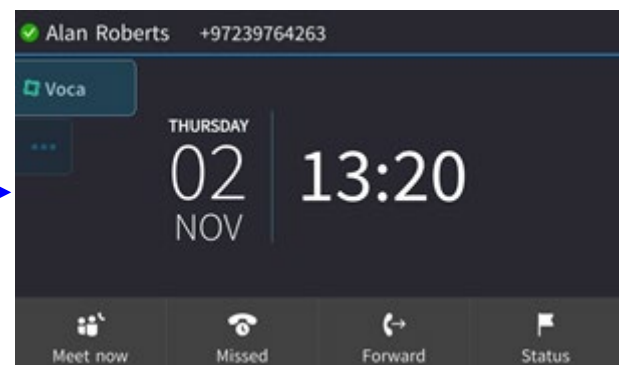
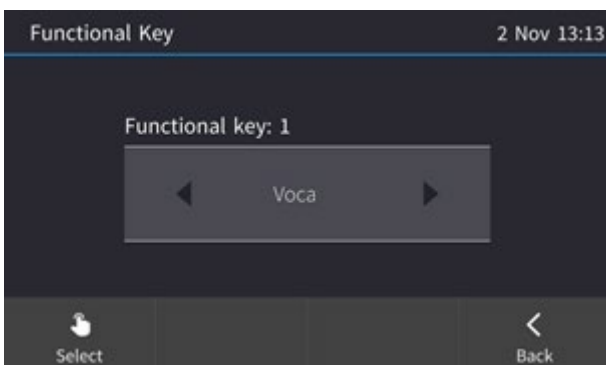

5.20 Configuring a Function Key for Paging

Live announcements can be made (paged) from a phone to a group of phones, to notify a team (for example) that a meeting is about to commence. The paged announcement is multicast via a designated group IP address, in real time, on all idle phones in the group, without requiring listeners to pick up their receivers. The name of the group is displayed on phone screens when the paging call comes in.



Note: The feature must be enabled in the Web interface by the network administrator before a Function Key can be configured for paging. See the *Administrator's Manual* for more information.

➤ **To configure a paging dial:**

1. Open the Function Keys screen (press the MENU hard key and then touch the **Keys** option -or- in the idle screen touch the ... icon):

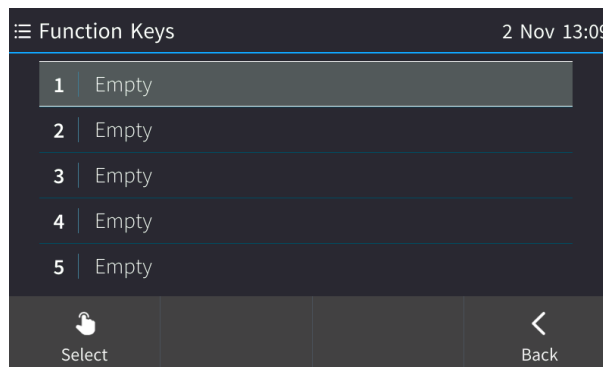

2. Select an 'Empty' key (if you accessed the screen from the MENU hard key) you'll see this screen:

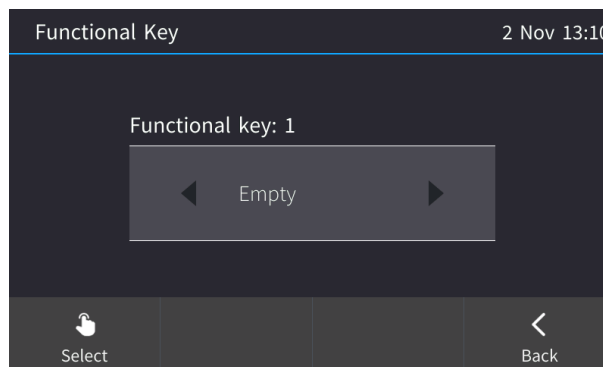

3. Touch < or > to navigate to and select **Paging** and then touch the **Select** softkey; the 'Function key #n' screen opens.

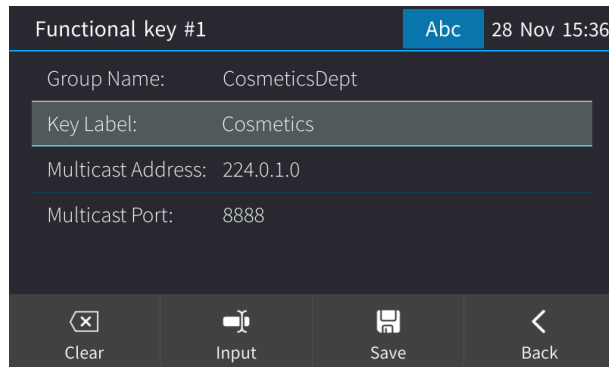

Functional key #1 Abc 28 Nov 15:36

Group Name: CosmeticsDept

Key Label: Cosmetics

Multicast Address: 224.0.1.0

Multicast Port: 8888

Clear Input Save Back

4. In the 'Group Name' field, enter the name of the group, to be displayed in the phone's screen when there's an incoming / outgoing paging call.
5. In the 'Key Label' field, enter the name of the key to be displayed in the idle screen that you will touch to make a paging call.
6. In the 'Multicast Address' field, enter the paging group's multicast IP address. Default: 224.0.1.0. For phones to be in a group, all must be configured with the identical multicast address.
7. In the 'Multicast Port' field, enter the group's port. Default: 8888. For phones to be in a group, all must be configured with the identical port.
8. Touch the **Save** softkey; a key is defined in the idle screen as a paging dial.

5.21 Configuring a Function Key for Making a Discreet Call

This feature answers a requirement for more security measures in public institutions such as making a discreet call. If a call is made in discreet mode, it's a one-way call to a remote phone.



Note: Both caller and called party phones must be AudioCodes phones.

The caller's phone does not indicate audially that a call is in progress; it's silent. The screen remains in idle mode and the backlight is not activated. The only indication that a call is in progress is the presence status of the caller changes to red (busy).

It's recommended that the called party's phone be a dedicated phone to avoid the scenario of being on another call when needed for the discreet call; the phone automatically answers the discreet call; there is no need to pick up the handset. The called party then 'listens' to what's happening at the caller's end. When the called party ends the call, the call ends on both sides. The caller cannot end the call.

➤ **To configure the feature:**

1. Open the Function Key screen (MENU hard key > select 'Empty') and then navigate to and select **Discreet Call**.

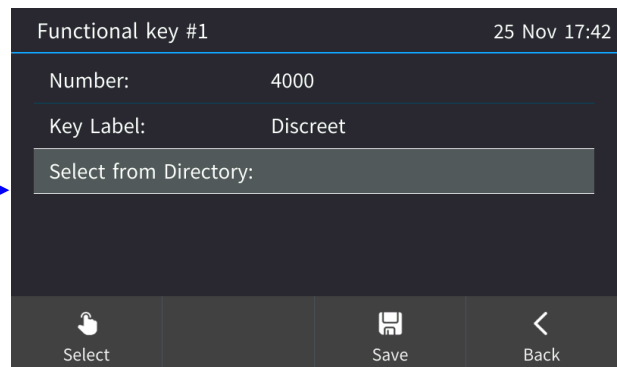
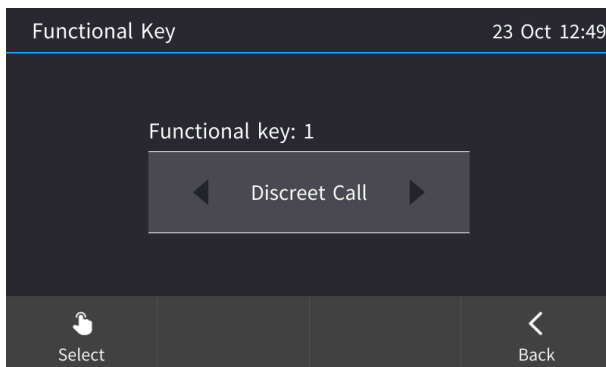

2. In the Function Key screen, configure the phone number of the authority in the organization to whom the discreet call will be made in the event that the necessity arises.
3. Configure a label for the key. Make it intuitive to facilitate quick action in an emergency. The label should differentiate Discreet Call functionality from other Speed Dials displayed, without compromising discretion. A label such as 'Emergency' would compromise discretion. The label is displayed in the phone's screen like a Speed Dial.
4. [Alternatively] Configure the preceding two parameters by 'Selecting (the destination phone) from Directory'.
5. Save the configuration.
6. Make a discreet call as you'd make a call using a speed dial (see Section 7.4).



Note:

- Device Lock must be disabled on the called party's phone.
- The call runs via the Skype for Business server as a regular call when the phone tunes the behavior to match the required functionality.

5.22 Customized UI Experience



Note: Only the network administrator can configure this feature. See the phone's *Administrator's Manual* for more information.

Users and / or enterprise management can ask their network manager to customize the **New Call** screen, **Ongoing call** screen and/or **Idle** screen.

Examples include:

- The **Meet Now** softkey in the idle screen can be disabled and replaced with another softkey such as the **Received Calls** softkey or the **Calendar** softkey.
- The ongoing call screen shown in the figure below can be customized:

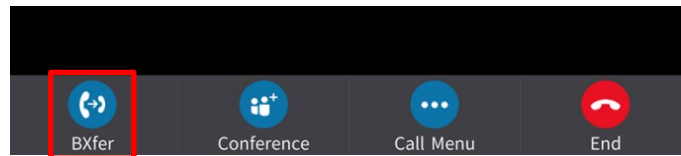

The **BXfer** softkey for example can be replaced with the **New Call** softkey shown in the figure below on the phones of users who infrequently transfer calls.

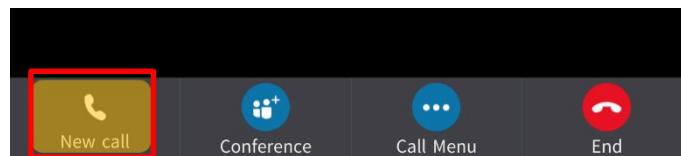

- The initiate call screen shown in the figure below can also be customized:

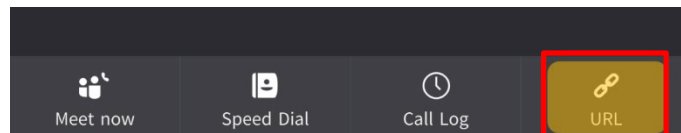

The **URL** dialing softkey, for example, can be replaced with the **Contacts** softkey shown in the figure below.

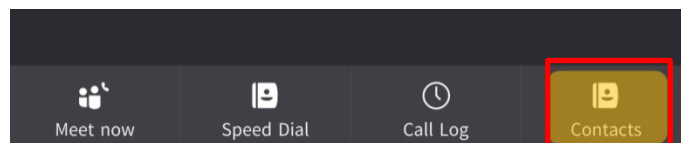

5.23 Deleting a Function Key

A Function Key can be deleted after you configure it if you no longer find it useful (for example).

➤ **To delete a Function Key:**

1. Long-press the configured Function Key.

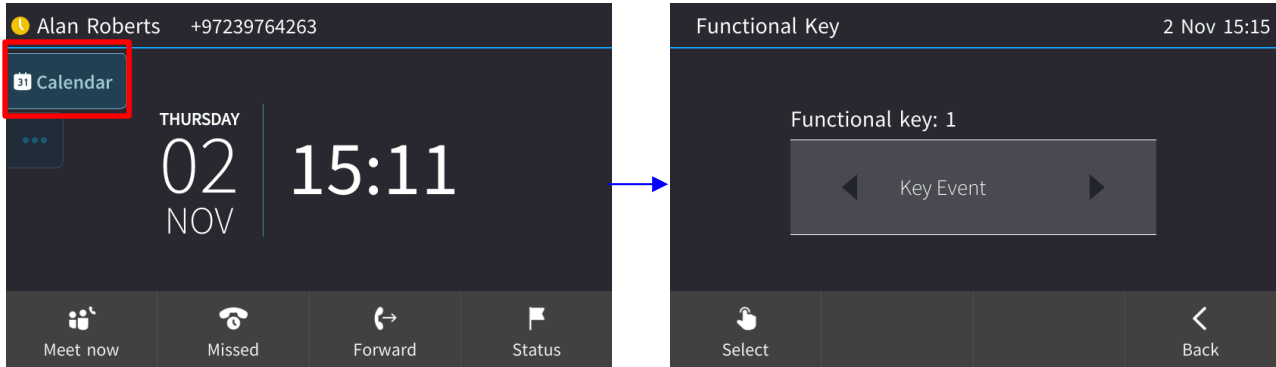

2. In the Function Key screen that opens, navigate to and select **Empty**; the Function Key is removed the idle screen.

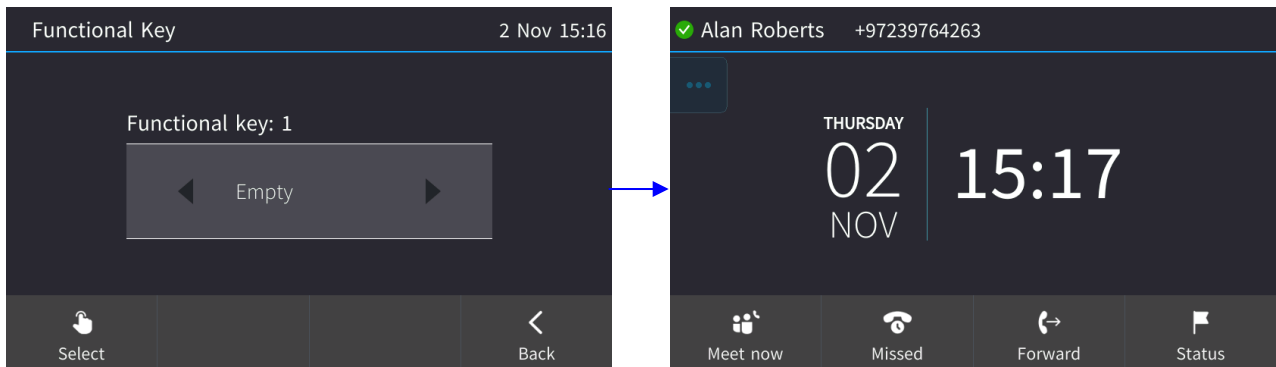

5.24 Changing your Presence Status

You can assign a presence status to control whether you want people to contact you or not, and if so, how. By default, your status is based on your Skype for Business client.



Note:

- Presence status can be changed by your Skype for Business client running on your computer. This status is reflected in the phone's touch screen.
- After n minutes (configured in the Skype for Business server by your administrator), presence status automatically changes to 'Inactive'.
- n minutes after this (also configured in the Skype for Business server by your administrator), presence status automatically changes to 'Away'; all calls are then automatically forwarded to the RGS (Response Group Service) if it is configured.

➤ To set/change presence status:

1. In the idle screen, touch the **Status** softkey:

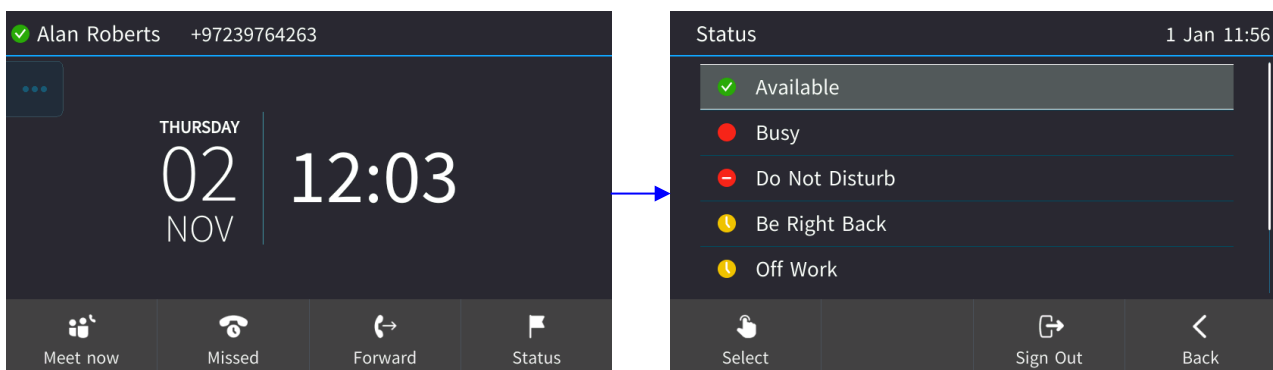

2. Navigate to a presence status, for example, **Do not disturb**, by pressing the lower rim of the navigation control button:

Table 5-2: Presence Statuses

Icon	Presence Status	Description
	Available	You're online and available for other contacts to call.
	Busy	You're busy and don't want to be interrupted.
	Do not disturb	You don't want to be disturbed. Stops the phone from ringing when others call you. If DnD is activated, callers hear a tone indicating that your phone is busy; the call is blocked and your phone's touch screen indicates 'Missed Calls'.
	Be Right Back	You'll be away briefly and you'll return shortly.
	Off Work	You're going on vacation (for example).
	Appear Away	You want to hide your status and appear to others you're currently away.

3. Touch the **Select** softkey; the status you selected - **Do not disturb** in the example above - is displayed in the idle screen.

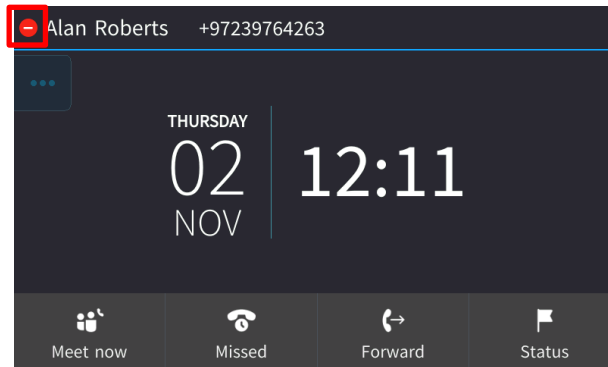

4. To reset your presence status, navigate to and select **Reset** in the Status screen; your status is received from the Skype for Business server and automatically updated.

5.25 Viewing Microsoft Exchange Calendar in the Phone's Touch Screen

You can view Microsoft Exchange Calendar items displayed in the phone's touch screen. Only items whose start date / time falls on the same day are displayed.



Note: For this feature to be available:

- It must be enabled by your network administrator if it isn't already (the default is enabled). For more information, see the *Administrator's Manual*.
- You need to sign in to the phone with Username and Password. If you signed in with PIN code, the feature will not be available and you'll receive the message shown below. Features activated from Microsoft's Exchange Server are only available after signing in with Username and Password.

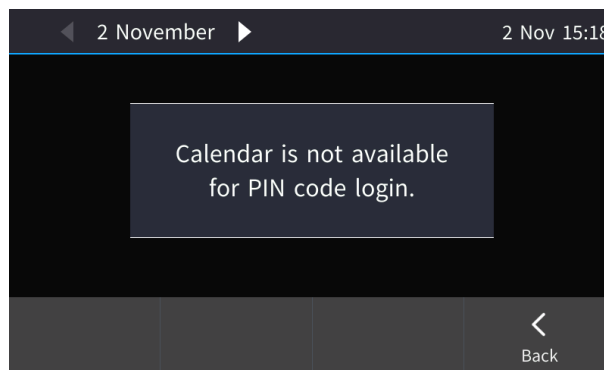

➤ To view the calendar:

1. Press the MENU hard key on the phone and in the Menu screen, select the **Calendar** option.

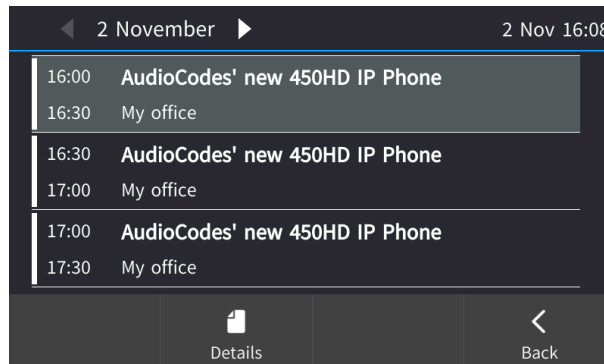

2. You can view other meetings scheduled for that day by scrolling down, or you can touch the **Back** softkey.

5.26 Receiving Meeting Reminders

The phone automatically pops up meeting reminders for meetings defined as Skype for Business meetings. Meeting reminders pop up in the phone's idle screen at the time defined for them in the meeting invitation.



Note: If the feature is disabled, ask your network administrator to enable it. For more information, see the *Administrator's Manual*.

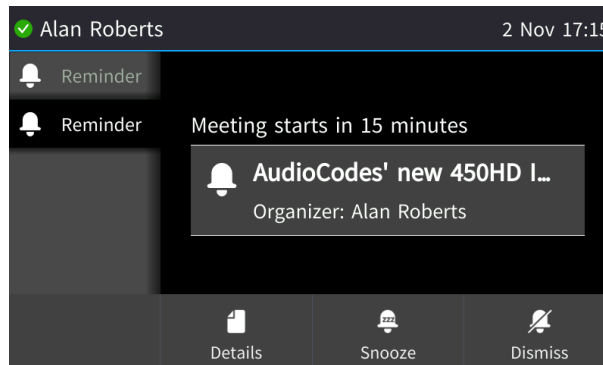

Table 5-3: Meeting Status [Applies to Non-Microsoft Theme Screen]

Icon	Description
	Meeting will be starting
	Meeting has started

You can Snooze a Reminder, or Dismiss it. If you select Dismiss, the Reminder does not pop up again; you'll still be able to access Calendar items and view the meeting.

If you select Snooze, the Reminder pops up 10 minutes before the start of the meeting, five minutes before the start of the meeting, and when the meeting begins.

The feature therefore allows you to receive advance notice about meetings and to enjoy direct access to them by clicking **Join**.

5.26.1 Displaying Calendar Meetings without Identifying Details

The phone can be configured to display Calendar meetings without displaying identifying details such as the subject of the meeting, to protect a user's privacy if required.

➤ **To do this:**

- When defining a new meeting in Microsoft Exchange, select the **Private** option as shown in the figure below.

Figure 5-3: Selecting the Private Option in Microsoft Exchange

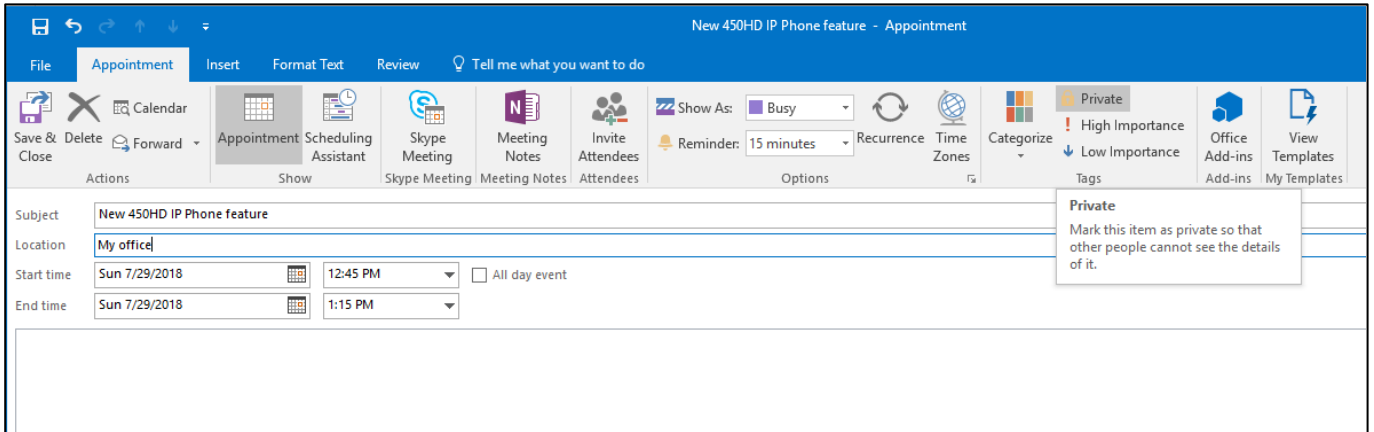

The meeting prompt will be displayed on your phone without identifying details, and will be identified as **(private)**.

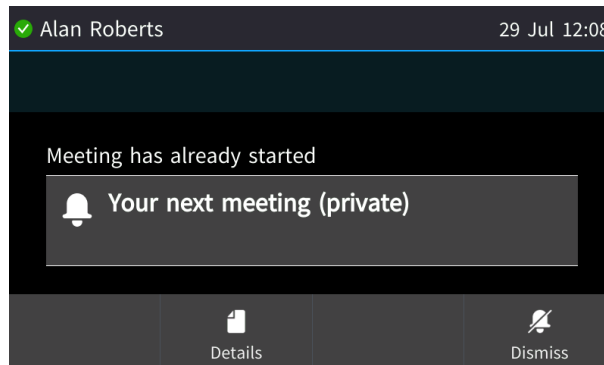

5.27 Determining Meeting Attendees' Presence Status

You can determine the presence status of meeting attendees.

➤ **To determine the presence status of meeting attendees:**

1. In the Meeting Reminder, touch the **Details** softkey.

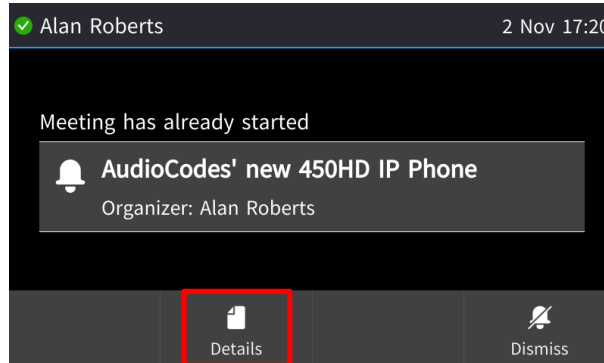

2. If the meeting has already started, press the MENU hard key on the phone and touch the **Calendar** option. In the list of meetings that opens, navigate to the meeting whose attendees' presence statuses you want to determine and then touch the **Details** softkey.

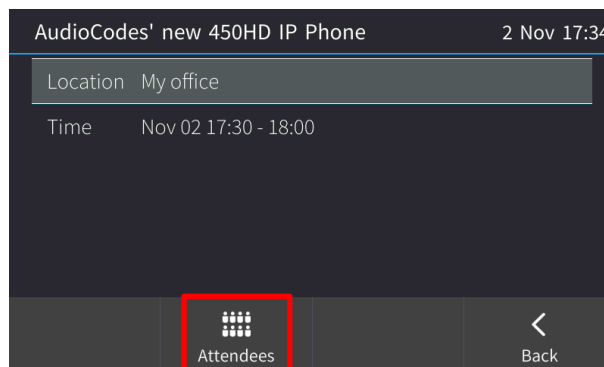

3. Touch the **Attendees** softkey to view the presence status of the participants attending the meeting.

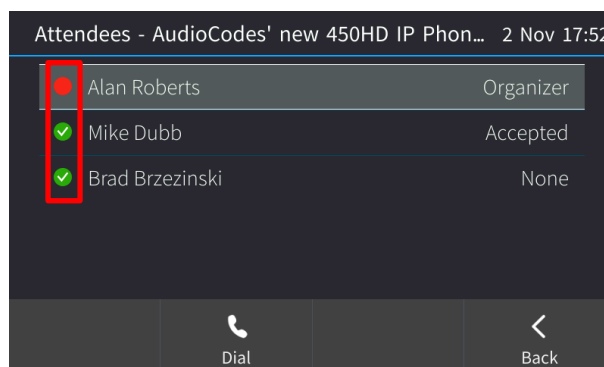

4. Determine the attendee presence status from the icons - see Section 5.20 for more information.
5. Optionally, navigate to an attendee and touch the **Dial** softkey to dial them.

6 Performing Basic Operations

This section shows basic phone operations.

6.1 Using Audio Devices

You can use one of the following audio devices on the phone for speaking and listening:

- **Handset:** To make a call or answer a call, lift the handset off the cradle.
- **Speaker** (hands-free mode). To activate it, press the speaker key during a call or when making a call. To deactivate it, press the speaker key again.
- **Headset** (hands-free mode). When talking on the phone, you can relay audio to a connected headset. To enable it, press the headset key. To disable it, press it again.

You can easily change audio device during a call.

- **To change from speaker/headset to handset:** Activate speaker/headset and pick up the handset; the speaker/headset is automatically disabled.
- **To change from handset to speaker/headset:** Off-hook the handset and press the speaker/headset key to activate the speaker/headset. Return the handset to the cradle; the speaker/headset remains activated.

6.2 Checking Voice Quality

You can perform a voice quality check on the phone.

➤ **To perform a voice quality check:**

- Press the MENU key on the phone, touch the **Device Status** menu option and select **Voice Quality Check**.

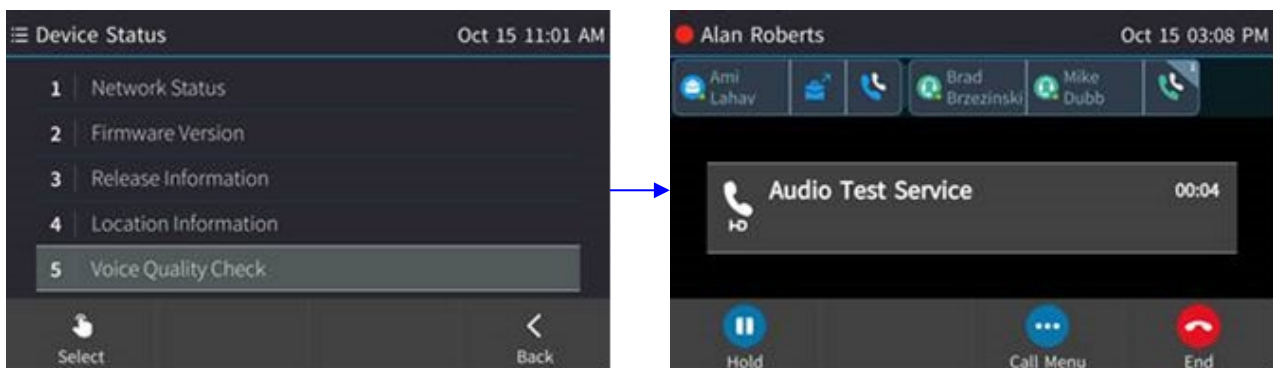

You're invited to "Record a short message after the tone then wait to hear how you sound".



Note: The feature must be enabled on the Skype for Business server by the network administrator for it to be available. See the *Administrator's Manual* for more information.

6.3 Making Calls

The phone offers multiple ways of making a call. After dialing, the touch screen displays:

- 
- the called party's presence status (in the screen below it's Away | Be Right Back)
- the called party's name if it's listed in the phone directory
- the number on which the called party is dialed

Touch screen indications:

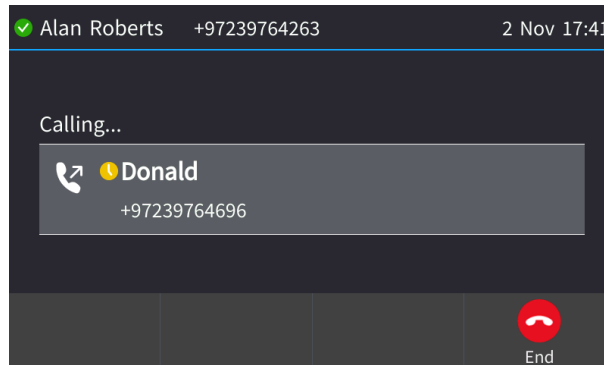

The phone plays a ring-back tone

- **To end dialing a call before it's answered:**
- Touch the **End** softkey or the speaker key.



Note: For advanced dialing using the phone directory, see Section 5.14. To configure a Speed Dial, see Section 5.16.

6.3.1 Dialing

This section shows how to dial. To dial, either (1) key-in the number on the keypad (2) press the speaker key and enter the number (3) press the speaker key or lift the handset and enter a URL address (e.g., host and domain name, or IP address) or alphabetical letters (e.g., tvservice).

➤ **To dial a regular-digits phone number:**

1. On the keypad, key the first digit of a regular phone number; the touch screen displays the digit in the New Call field; key in the remaining digits. To delete (from right to left) entered digits, touch the **Clear** softkey. To cancel the call, touch the **Cancel** softkey.

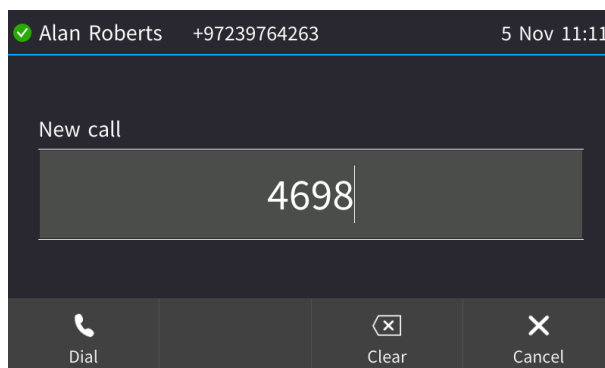

2. Do any of the following:
 - Don't do anything; dialing is automatically performed after a few seconds.
 - Touch the **Dial** softkey; dialing is performed.
 - Pick up the receiver; dialing is performed.
 - Press the **Speaker** key; dialing is performed.
 - [If you switched on speaker/headset before keying in the number] Press the **#** hard key on the phone after keying in the number, to dial the number *immediately*.

➤ **To dial a URL:**

1. Press the speaker key or lift the handset; the touch screen displays the New Call field and the **URL** softkey:

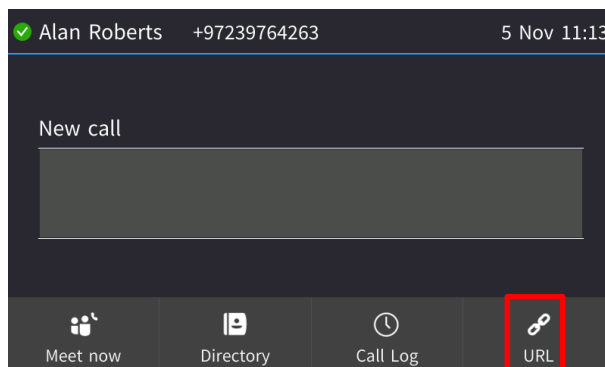

2. Touch the **URL** softkey and enter a URL address.
 - See Section 3.4 for how to switch letters, numerals and symbols.
 - To delete (from right to left) entered letters/numerals/symbols, touch the **Clear** softkey.
 - To cancel the call, touch the **Cancel** softkey.

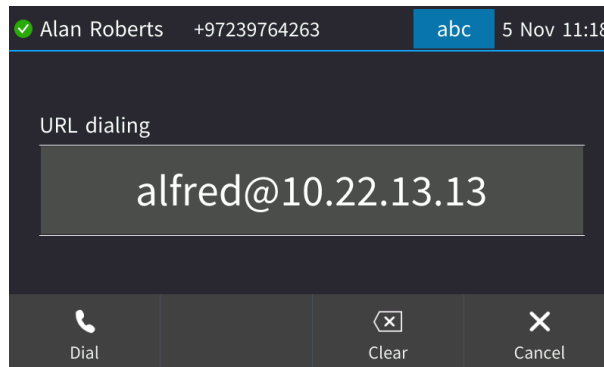

3. Touch the **Dial** softkey to call the URL.

6.3.2 Redialing

You can redial a number you previously dialed.

➤ **To redial:**

1. Press the REDIAL hard key on the phone; the Dialed Calls screen is displayed, listing in chronological order, recently dialed numbers:

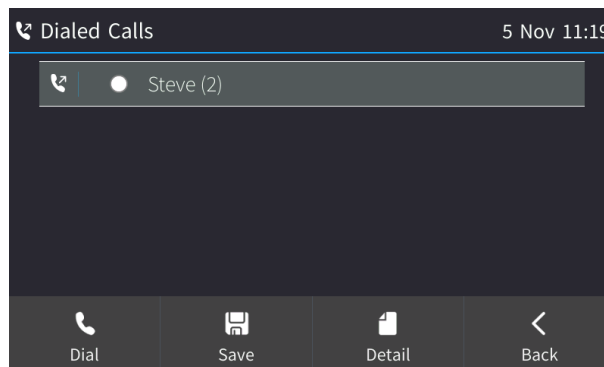

2. Navigate to the number to redial.
3. Touch the **Dial** softkey or press the **OK** key.

6.3.3 Dialing a Missed Call

The phone logs all missed calls. The touch screen in idle state displays the number of missed calls.

➤ **To dial a missed call:**

1. Touch the **Missed** softkey.

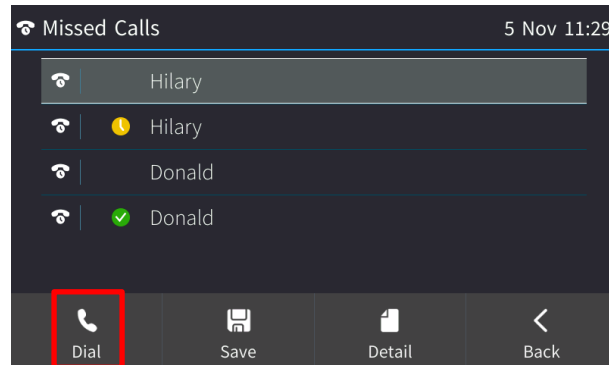

2. Navigate to the missed call to dial if there are more than one listed.
3. Touch the **Dial** softkey or press the **OK** key.

6.4 Answering Calls

The phone indicates an incoming call as follows:

- Touch screen displays  together with the caller's phone number (or contact name if listed in the phone directory):

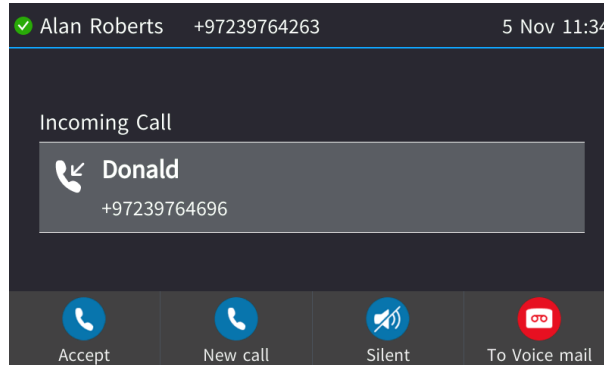

- Phone rings.
- Ring LED flashes blue.

➤ **To answer:**

- Pick up the handset -OR- press the headset key (make sure the headset is connected to the phone) -OR- press the speaker key -OR- touch the **Accept** softkey (the speaker is automatically activated).

When you answer, the touch screen displays the  icon and the caller's details and call duration:

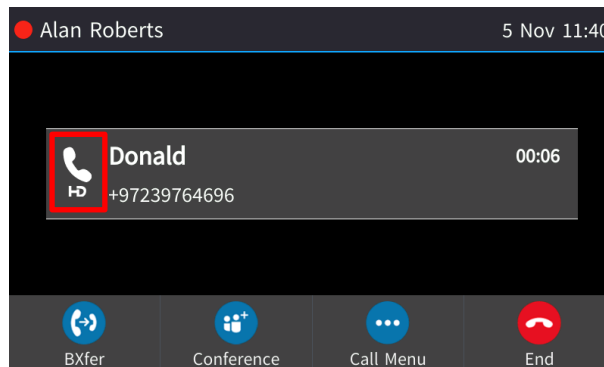

Note:

- **HD** in the touch screen indicates a high-definition call (using a wideband voice coder).
- When two incoming calls occur simultaneously, the names of the calling parties appear in the touch screen and the adjacent incoming call icons flash. If a user is in a call and a third party calls, the name of the calling party appears in the touch screen and the adjacent incoming call icon flashes.

6.5 Rejecting Incoming Calls

You can reject an incoming call; the caller hears a busy tone from your phone if you do.

➤ **To reject an incoming call:**

- Touch the **Reject** softkey.



Note:

- The **Reject** softkey will *not* be displayed if your network administrator configured voicemail on the phone.
- The **To Voice Mail** softkey will be displayed instead of the **Reject** softkey if your network administrator configured voicemail. You can press it to send an incoming call directly to voicemail. See below.

➤ **To send an incoming call to voicemail:**

- When the phone rings to alert to a call, touch the **To Voice Mail** softkey displayed.

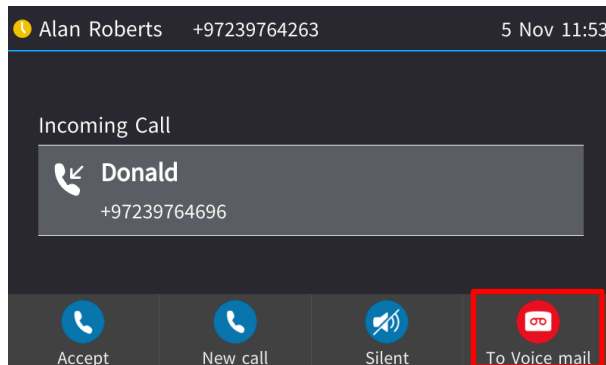

➤ **To view voicemail content:**

1. Press the voicemail key on the phone, indicated by an envelope icon which will be illuminated red if you have voicemail.

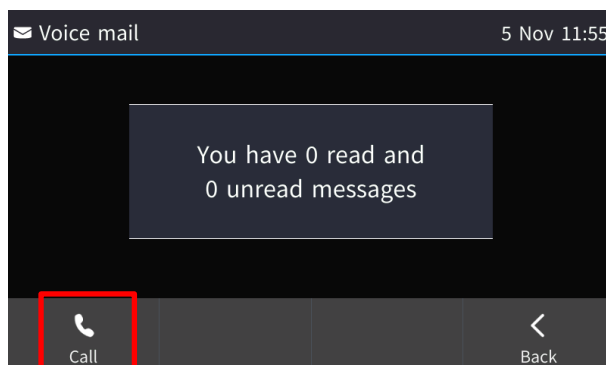

2. Touch the **Call** softkey
3. Listen to your messages played back to you and then (optionally) touch the **End** softkey.

6.6 Silencing Incoming Calls

You can silence an incoming call's ringing; the caller hears normal ringing but no answer.

➤ **To silence the ringing of an incoming call:**

- Touch the **Silent** softkey.

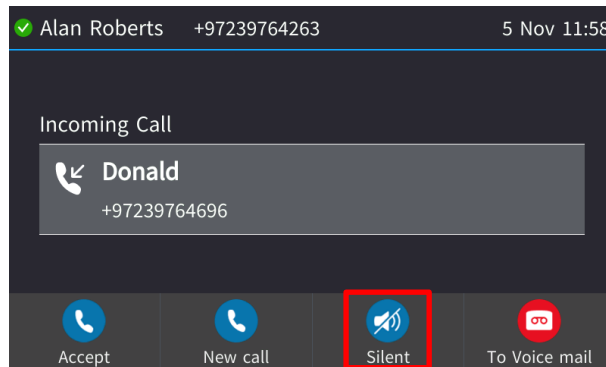

Answer a silenced call by pressing the **Accept** softkey or picking up the handset.

6.7 Ending an Established Call

You can end an established call.

➤ **To end an established call:**

- Return the handset to the phone cradle if it was used to take the call -or- press the headset key -or- press the speaker key -or- touch the **End** softkey.

6.8 Viewing Missed, Received and Dialed Calls

The phone logs calls missed, received and dialed calls.



Note:

- The phone's Call Logs are synchronized with Microsoft's Exchange server. All lists in each device's Call Log are synchronized except the Missed Calls list. All devices that a user signs into are synchronized with the server. Each device reports every call from | to that user to the server. Each device then pulls the last 20 reported calls and performs synchronization.
- If the feature has been disabled, the network administrator must re-enable for synchronization to function. See the *Administrator's Manual* for more information.

In idle state, the touch screen displays the number of missed calls (if any). In the example below, 3 missed calls are indicated.

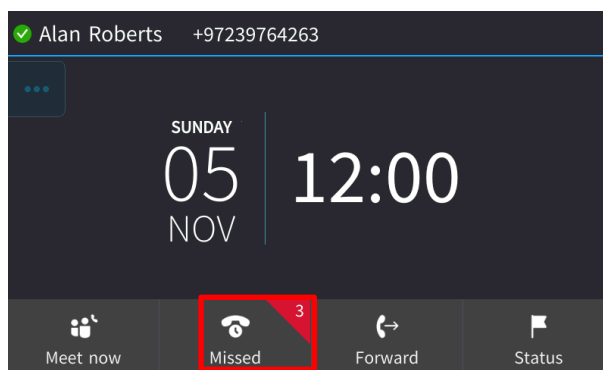

➤ To view missed calls:

- Touch the **Missed** softkey.



Note: After viewing, the indication disappears from the screen. The next time a call is missed, the indication will reappear.

➤ To view call history:

1. Open the Call Log screen (MENU hard key > **Call Log**).
2. In the Call Log screen, navigate to and select the call log you require.

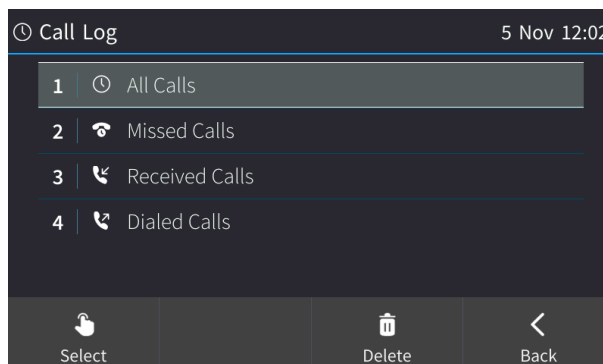

- **All Calls** = calls that were missed, received and dialed
- **Missed Calls** = calls that were not answered

- **Received Calls** = the most recently answered numbers
 - **Dialed Calls** = the most recently dialed numbers
3. Navigate to the option you want and touch the **Select** softkey; a list of the logged calls is displayed, for example, All Calls:

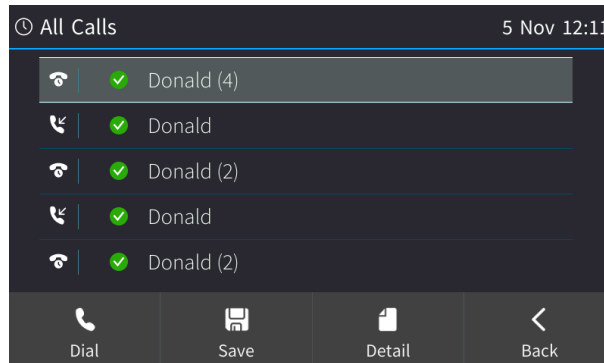

4. Touch the softkey you need:
- **Dial** = dials the number of the selected logged entry.
 - **Save** = saves the related information about the call entry in the Personal Directory (for adding a contact in the directory, see Section 5.14).
 - **Detail** = accesses the Call Details screen, which displays details of the call entry:

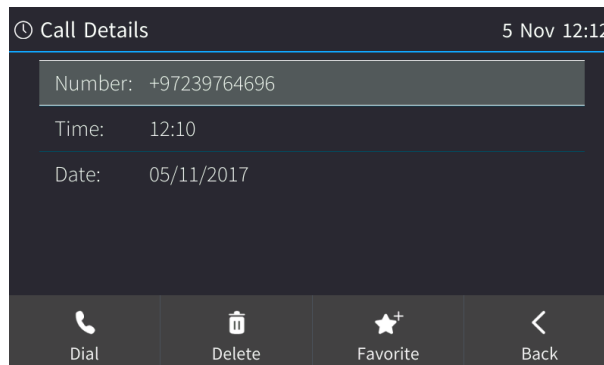

The Call Details screen displays the following logged call information:

- **Number** = phone number logged
- **Time** = the time the call was logged
- **Date** = the date on which the call was logged
- **Duration** = the duration of the call (if answered)



Note:

- The call history lists are stored from the newest to oldest entries. The maximum number of entries for each call history type is 200. Once this maximum is attained, the oldest entry is deleted and replaced with the new entry.
- The call history lists are saved on a daily basis. In the case of a power outage, some of the received information may be lost.
- If you view missed calls by pressing the **Missed** softkey, the missed calls notification no longer appears on the screen and reappears the next missed call.

6.9 Reporting a Malicious Call

You can report a malicious call. If you receive a call and you want to report it as malicious, the phone allows you to send a report to the Skype for Business server.



Note: The feature must be enabled by the network administrator on the Skype for Business server for malicious call reporting to be allowed by the phone. See the *Administrator's Manual* for more information.

➤ **To report a malicious call:**

1. After receiving a call, press the MENU key on the phone and touch the **Call Log** item.
2. Select the **Report a call** option; the phone reports the malicious call.

This page is intentionally left blank.

7 Performing Advanced Operations

This section shows how to perform advanced operations.

7.1 Answering Waiting Calls

You can accept a call on an extension on which there already is an active call.

➤ **To answer a waiting call:**

- a. A call with Donald is in progress:

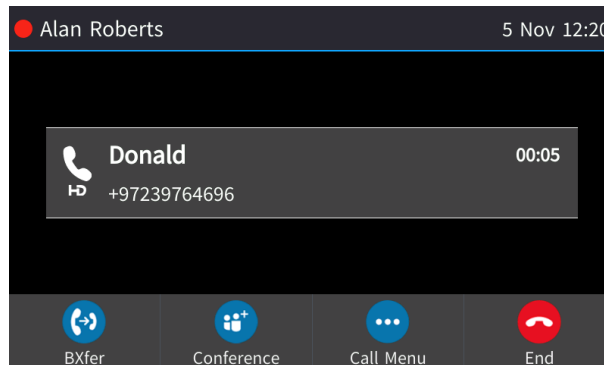

- b. A call comes in from Hilary:

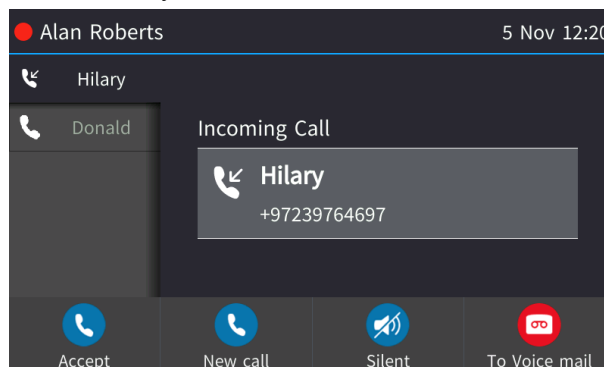

➤ **To answer Hilary:**

1. Touch the **Accept** softkey; the waiting call from Hilary is answered; the previous call from Donald is put on hold:

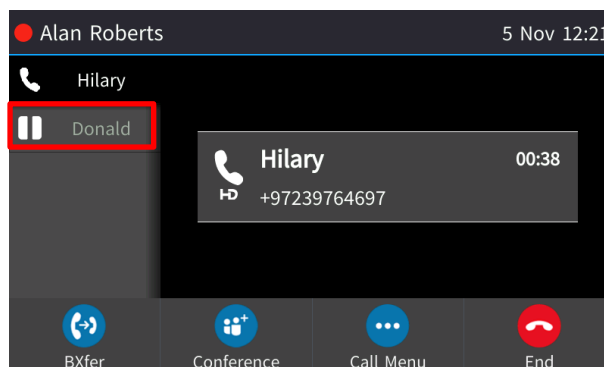

2. To toggle between calls, press the navigation control's upper or lower rim, or just touch the caller's name in the screen.

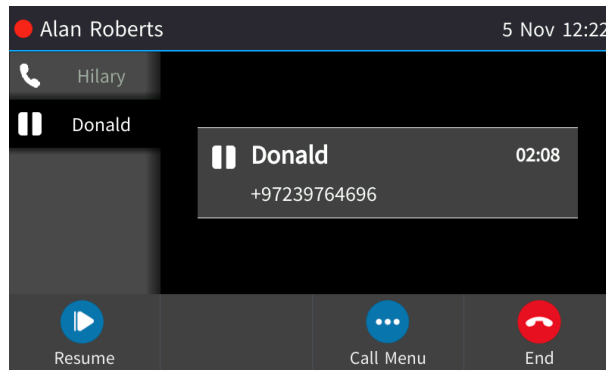

Note: To enable / disable the call waiting feature, see Section 5.3.

7.2 Placing Calls On Hold

You can place a call on hold in order to answer an incoming call (see Section 7.1) or to make another call. The party put on hold will hear music played (Music on Hold (MOH)).

➤ To place a call on hold:

- Accept an incoming call and then press the HOLD hard key.

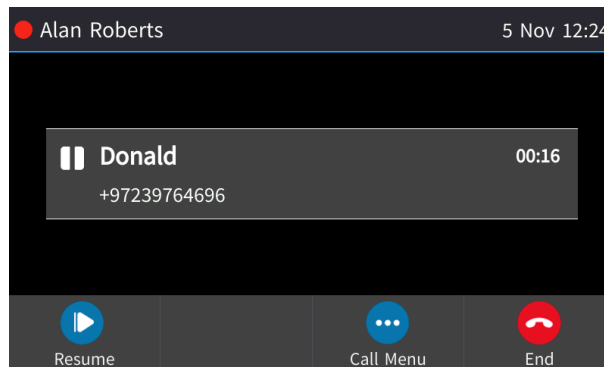

➤ To retrieve a call on hold:

- Press the HOLD hard key again or touch the **Resume** softkey.



Note: When using the handset in a call, if the handset is on-hooked after putting the call on hold, the call is *not* disconnected and the *audio is switched to the speaker*. For the call to be *disconnected*, as it was in earlier versions, refer to your network administrator.

7.3 Handling Multiple Incoming Calls

The phone is capable of handling up to eight concurrent calls per line. Multiple calls can be put on hold and you can switch between them. This feature is valuable for front desk personnel.

➤ To manage multiple incoming calls:

- If a call comes in from Steve and then after it, a call comes in from Donald, when you answer Donald, Steve is put on hold.
- If a third call comes in, this one from Hilary, and you answer it, Donald is also put on hold, so now both Steve (caller 1) and Donald (caller 2) are on hold.

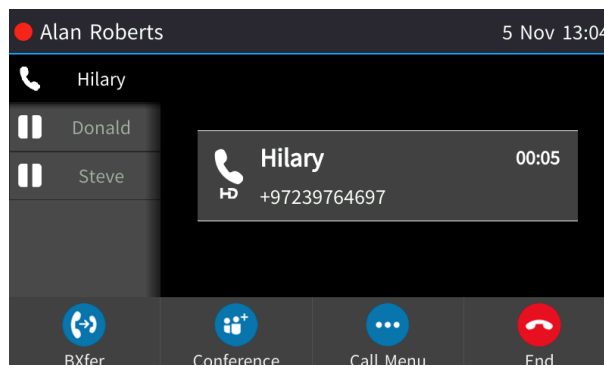

➤ To toggle between callers:

- Press the upper or lower rim of the control button to navigate from one caller to another or just touch the caller's name in the screen.

7.4 Using a Speed Dial to Call a Contact

Speed dials are used to quickly place calls to contacts rather than laboriously look up their number in the directory every time you need to call them.



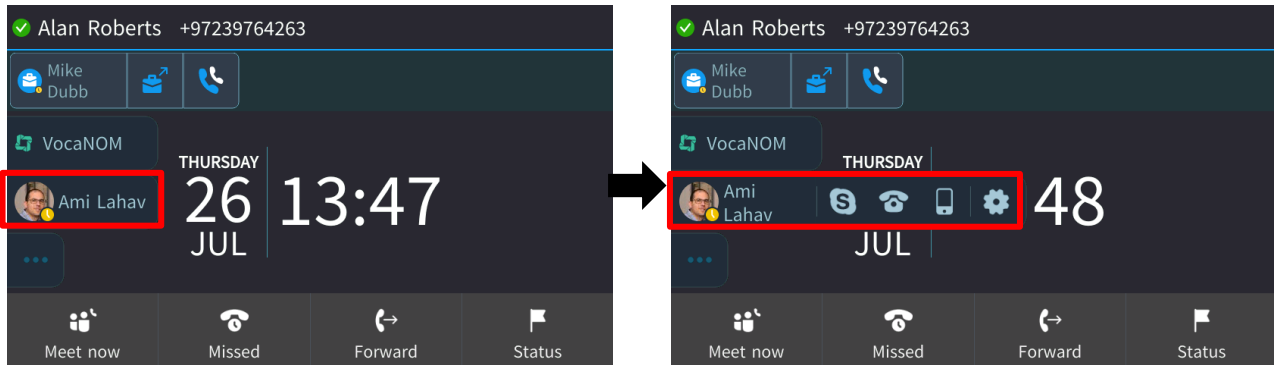

➤ **To quickly place a call to a contact:**

1. Long-press the contact's speed dial displayed in the phone's screen or Expansion Module.



2. Touch an item in the popup menu to directly activate its functionality. Use the table below as reference.

Table 7-1: Popup Menu Items – Touch to Activate

Popup Menu Item	Functionality
	Directly calls the Skype for Business phone of the contact to whom the speed dial is configured.
	Directly calls the office phone of the contact to whom the speed dial is configured.
	Directly calls the mobile phone of the contact to whom the speed dial is configured.
	Opens the Function Key settings for quick access to the configuration of the speed dial to the contact. To configure a Function Key as a Speed Dial, see Section 5.16.



Note: Touching a speed dial dials the default option, namely, a Skype for Business call.

7.5 Accessing Speed Dials when in a Call

You can access your speed dials when in a call to (for example):

- transfer the call to a third party
- add a participant to a conference

➤ **To access your speed dials when in a call:**

1. When in a call, touch the **BXfer** softkey (for example); the 'Blind transfer to...' screen opens displaying the **Speed Dial** softkey.

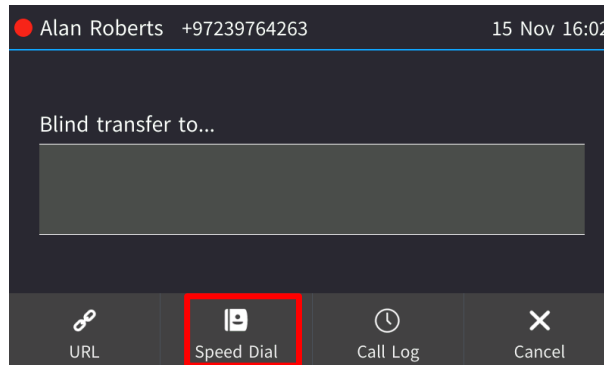

2. Touch the **Speed Dial** softkey to access your speed dials.

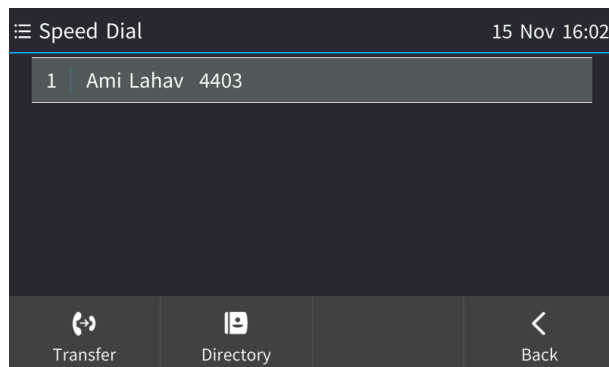

3. In the Speed Dial screen that opens, select the Speed Dial of the contact to transfer the call to.

7.6 Making a Call in Discreet Mode

This feature answers a requirement for more security measures such as a silent mode call for public institutions. If a call is made in discreet mode, it's a one-way call to a remote phone. The caller's phone does not indicate audially that a call is in progress; the screen remains in idle mode and the backlight is not activated. The only indication that a call is in progress is the presence status of the caller changes to red (busy). The caller cannot end the call.

➤ **To configure the feature:**

7. Open the Function Key

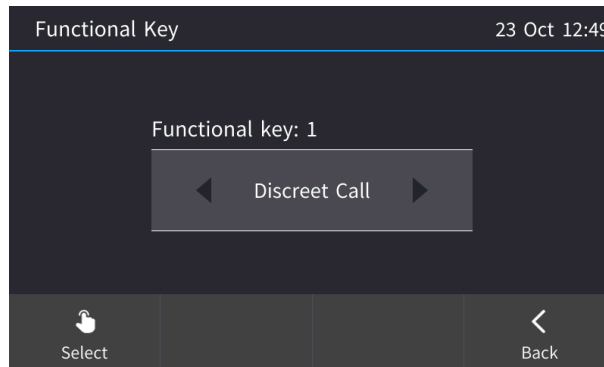

It's recommended that the called party's phone be a dedicated phone to avoid the scenario of being on another call when needed for the discreet call; the phone automatically answers the discreet call; there is no need to pick up the handset. The called party then 'listens' to what's happening at the caller's end. When the called party ends the call, the call ends on both sides.

Note:

- Both caller and called party phones must be AudioCodes phones.
- Device Lock must be disabled on the called party's phone.
- The call runs via the Skype for Business server as a regular call when the phone tunes the behavior to match the required functionality.



7.7 Transferring Calls

You can transfer a call to another party using blind transfer (default) or consultative transfer.

Transfer	Description
Blind	Connects another party to a third party <i>before</i> the third party answers.
Consultative	Connects another party to a third party <i>after</i> the third party answers and agrees to take the call from the second party.



Note:

- The hard TRANSFER key on the phone *by default* performs a *blind transfer*.
- Your network administrator can change the key's functionality to *consultative transfer*. See the *Administrator's Manual* for more information.

7.7.1 Performing a Blind Transfer

You can transfer a call to a destination party without consulting them.

➤ **To perform a blind transfer:**

1. Steven asks you – Alan - to transfer him to Hilary. Press the TRANSFER hard key on the phone or touch the **BXfer** softkey (or touch the Call Menu softkey and then touch the menu option **Blind transfer**). Steven is put on hold.

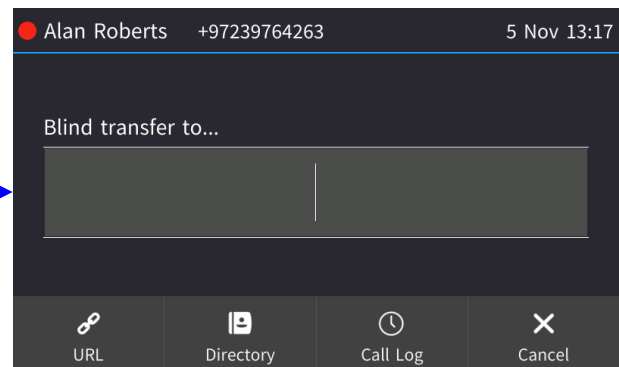
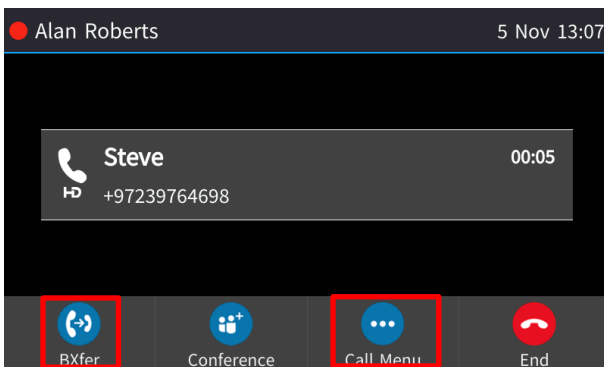

2. In the 'Blind transfer to' field, enter Hilary's number (4697) and then touch the **Transfer** softkey or wait; Hilary's phone rings.

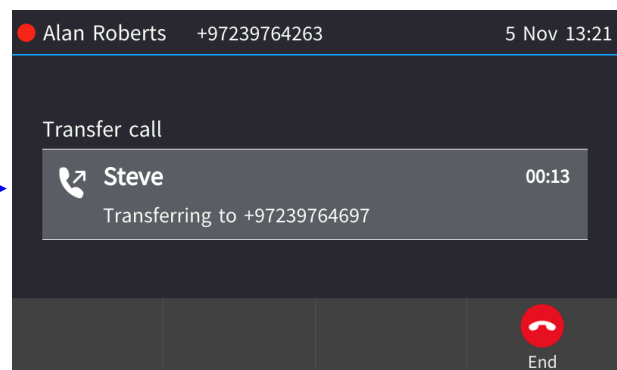
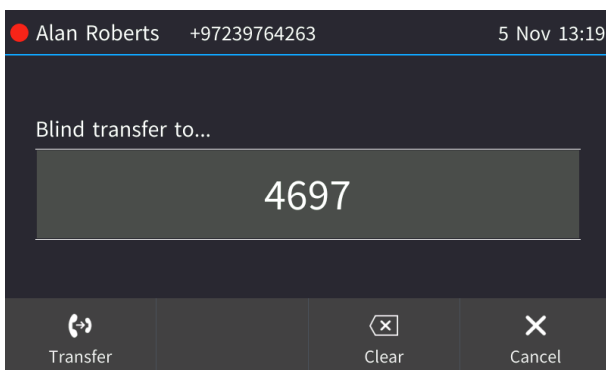

3. When Hilary picks up, Steve is automatically transferred to Hilary and your call with Steve is automatically disconnected.

7.7.2 Performing a Consultative Transfer

You can consult with a party before transferring the call to them.

➤ **To perform a consultative transfer:**

1. In a call with Steve, he asks you (Alan) to transfer him to Hilary. Touch **Call Menu**.

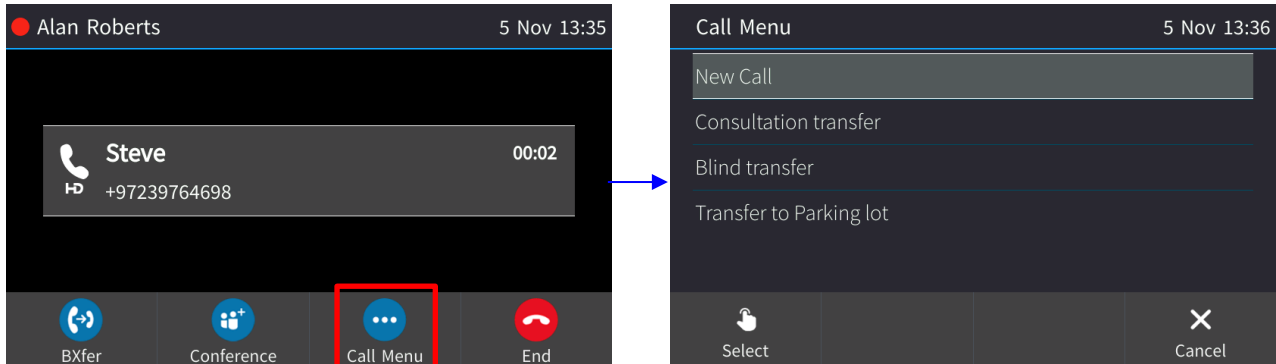

2. Scroll down in the Call Menu to select **Consultation transfer**.

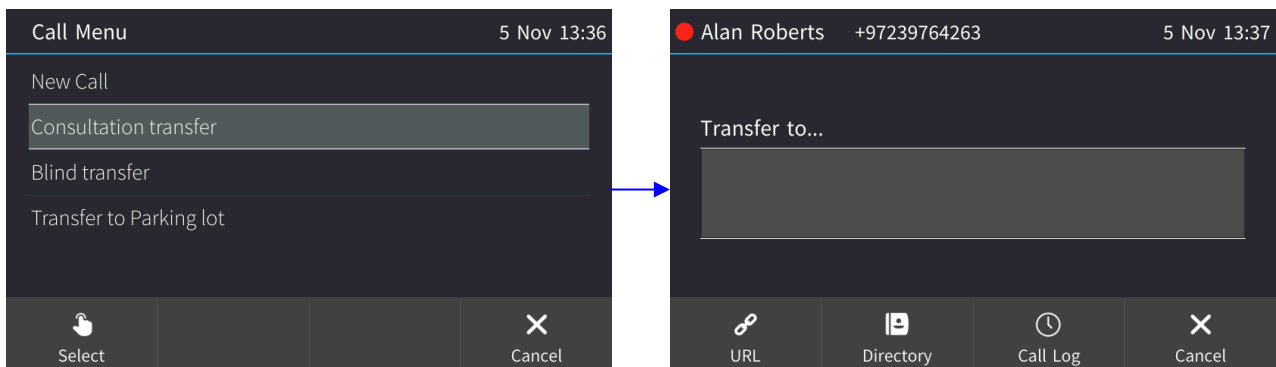

3. In the TRANSFER TO field, enter Hilary's number (or select it from a Directory or Call Log) and touch the **Dial** softkey; Hilary's phone rings and Hilary answers:

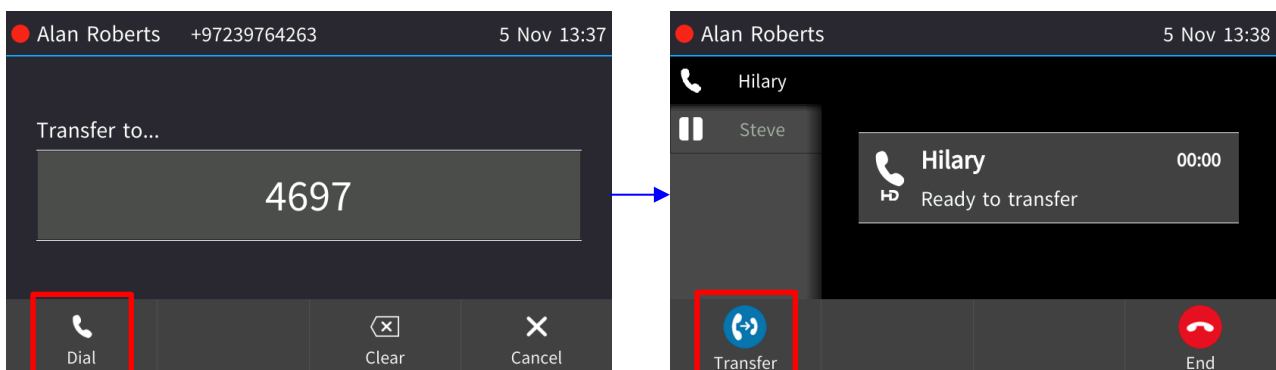

4. Touch **Transfer** or press the TRANSFER hard key. Hilary is connected to Steve.

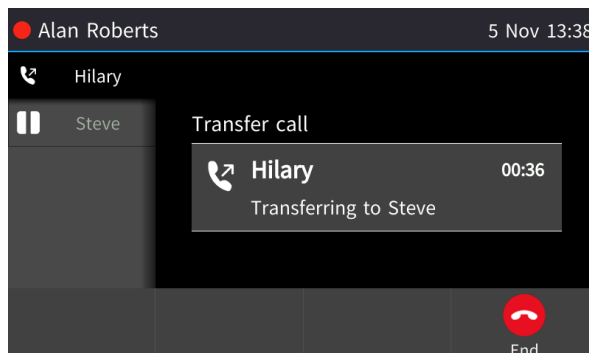

7.7.3 Performing a Semi-Consultative Transfer

Instead of consulting extensively with the destination party after they answer, you can transfer the call when they say hello. Semi-consultative transfer allows you to identify the voice of the destination party before transferring the call to them, without asking them whether they agree to take the call or not.



Note: The feature is by default disabled. For the feature to be available, your enterprise network administrator must enable it on the phone. See the *Administrator's Manual* for details.

➤ **To perform a semi-consultative transfer:**

1. Donald asks you - Alan - to transfer him to Hilary. Touch the **Call Menu** softkey and select the menu option **Consultation transfer**. Donald is put on hold. MoH is played to him.
2. Enter Hilary's number and touch the now-enabled **Dial** softkey. Before you hear Hilary's voice, touch the **Transfer** softkey or press the TRANSFER hard key on the phone; Donald is connected to Hilary.



Note: If your network administrator has not enabled the feature, the **Transfer** softkey will not be displayed.

7.7.4 Merging Calls

You can merge two separate calls into one conference call if you're in a call and you want to add another participant to the established call.



Note: A regular call cannot be merged with an active conference call.

Merging therefore is in effect similar to adding a participant to a conference. It can be performed via the phone's menu softkey or via the Skype for Business client if the user is paired.

➤ **To merge calls:**

1. While in a call with Steve, you (Alan Roberts) decide you want to add Hilary to the conversation. Touch the **Call Menu** softkey and then select **New Call**.

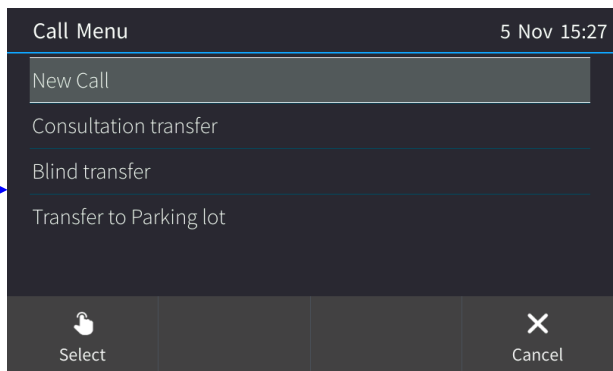
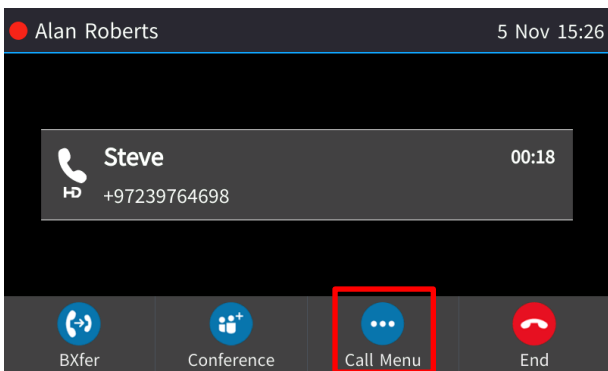

2. In the 'New Call' field, enter Hilary's number and touch the now-enabled **Dial** softkey.

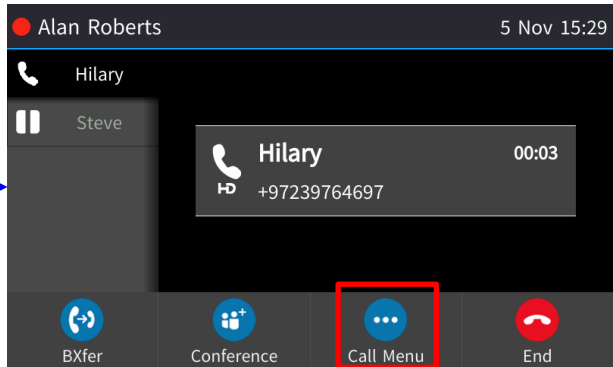
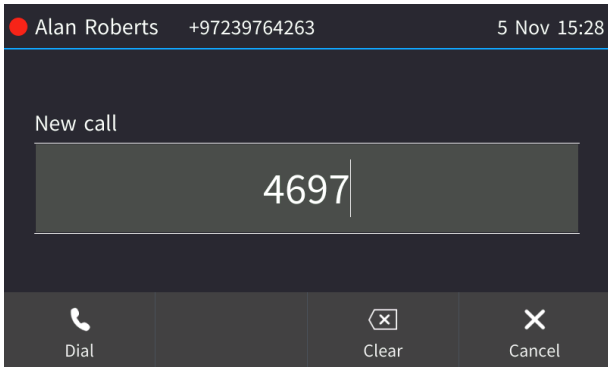

3. When Hilary answers, touch the **Call Menu** softkey and then select **Merge Calls**; all three of you are now in the conversation.

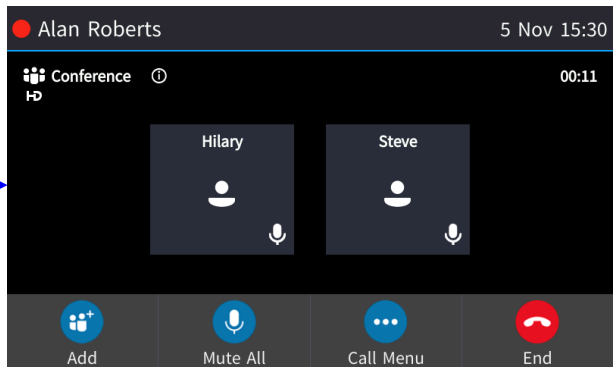
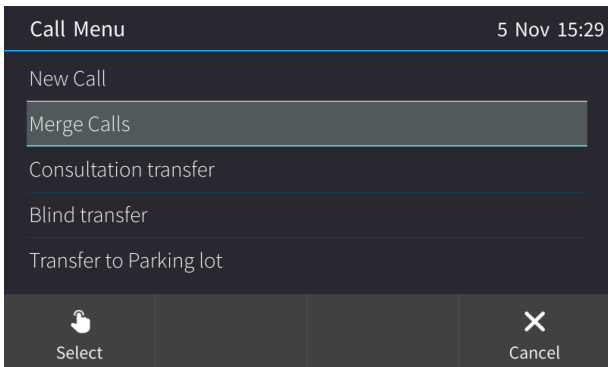

7.8 Parking a Call

You can park a call, i.e., you can transfer a call to a "parking lot" for it to be picked up on any other phone in the enterprise by a party who must dial a retrieval number in order to retrieve it on that phone. The retrieval number is configured in the Skype for Business server's parking lot parameter. Your network administrator can change the retrieval number if required.



Tip: Don't park a call unless you know precisely who you want to answer it. If you park a call, it can be answered by anyone in the enterprise listed in the Skype for Business server's parking lot parameter.

➤ To park a call:

1. When you're in the call, touch the **Call Menu** softkey and then navigate to and select the **Transfer to Parking lot** option:

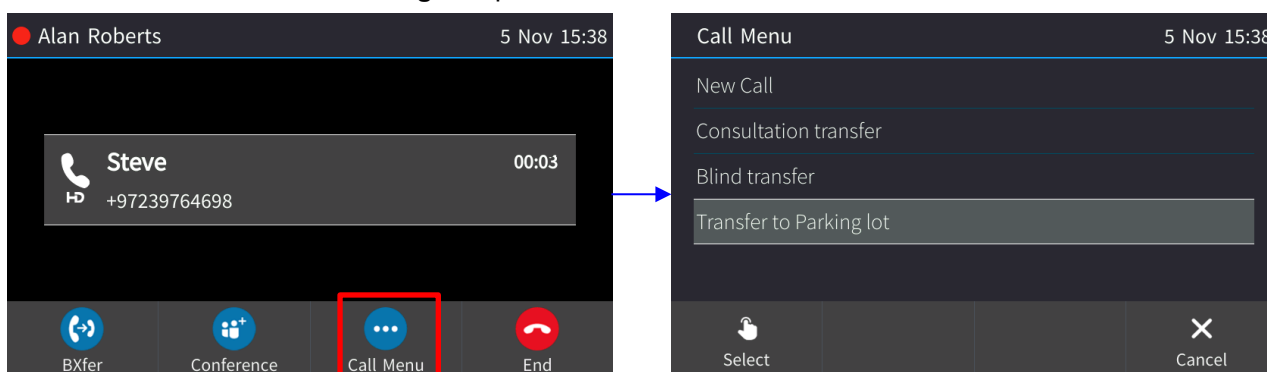

The screen notifies you of the number to dial on another phone to retrieve the call:

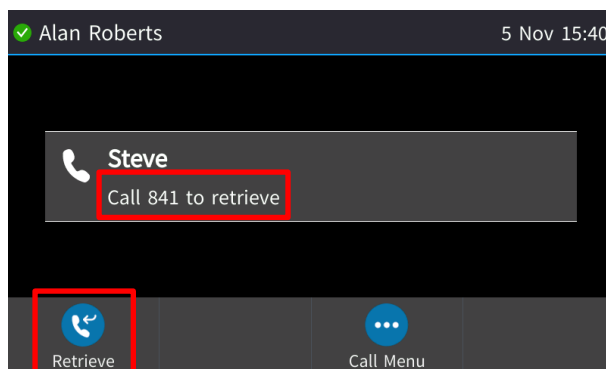

2. On another phone, dial the retrieval number (e.g., **841** as shown in the figure above); the call is pulled to that phone.
3. To pull the call back to the phone which it originally was on, touch the **Retrieve** softkey.

7.9 Configuring Group Call Pickup (GCP)

GCP capability lets an employee take a call coming in on a colleague's phone, on their phone. If an employee in an open space hears a colleague's phone ringing and knows that colleague is unavailable, instead of having the call go unanswered and routed to voicemail, the call can be redirected and answered by the available employee. Only employees configured in the Skype for Business server's GCP parameter can pick up the call. Consult your network administrator if required.

7.10 Initiating a Multi-Party Skype for Business Remote Conference

A multi-party call conference based on the Skype for Business server (remote conference) can be initiated from the phone.



Note: This section describes conferencing when Better Together over Ethernet (BToE) is *not* installed. See Section 7.14.4 for information about conferencing when BToE *is* installed.

The phone of the conference initiator uses CCCP (Centralized Conference Control Protocol) to establish the conference. The feature is integrated with Microsoft Exchange so in an email invitation to join a Skype for Business meeting, you can touch a **Join** link.

➤ **To initiate a conference:**

1. In the phone's idle screen, touch the **Meet Now** softkey; the Conference screen opens indicating **You are the only participant in the conference**.

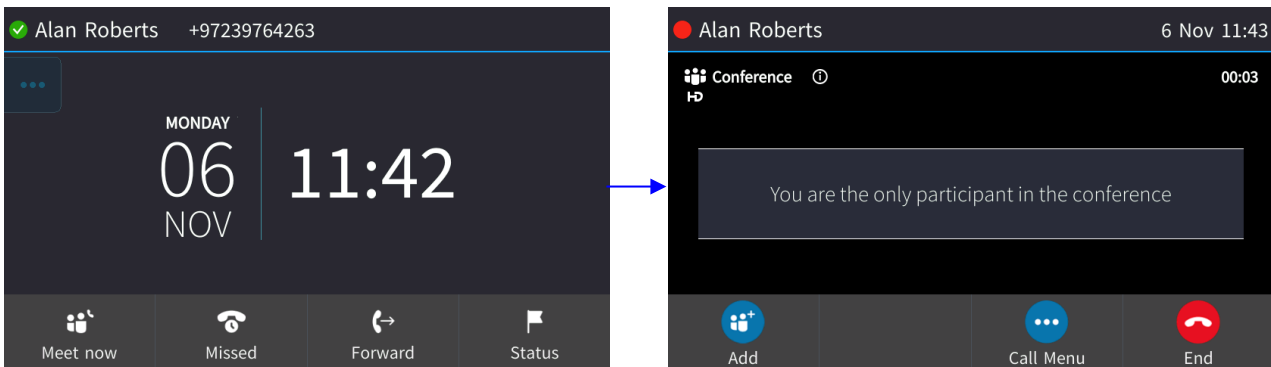

3. Touch the **Add** softkey; the Add Participant screen opens.

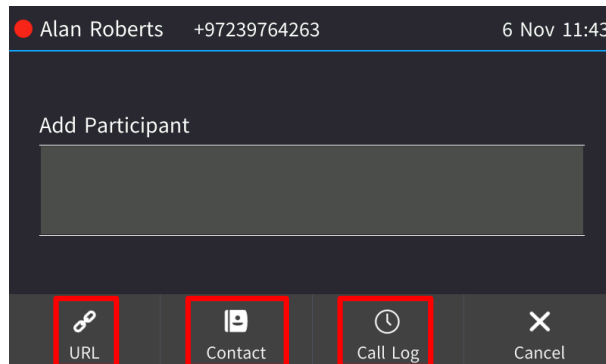

4. Enter the participant's phone number. Either:
 - Touch the **URL** softkey and enter the participant's URL (use the alphanumerical selection displayed - see Section 3.4 for more information). Touch the **Dial** softkey.

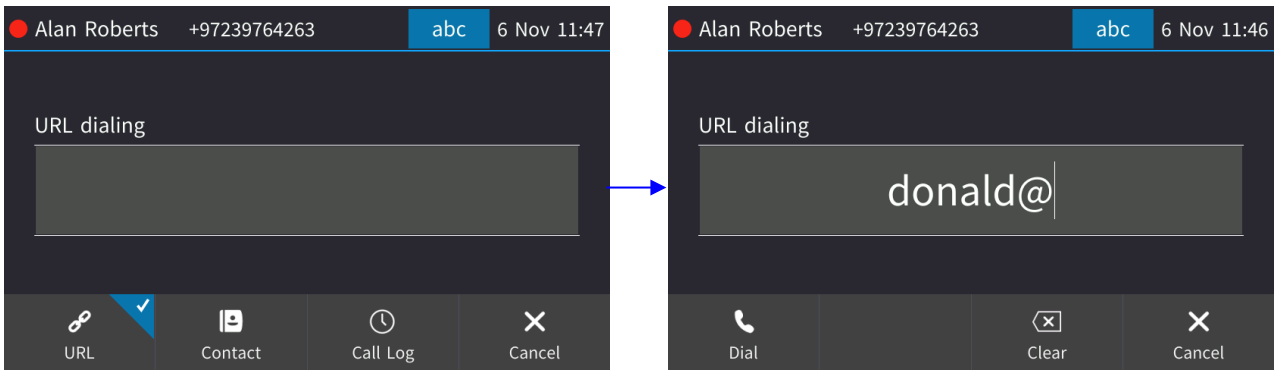

- Touch the **Contact** softkey and navigate in the Corporate or Personal Directory to find the contact to add (see Sections 5.14 and 5.15 for more information). After finding them, touch the **Dial** softkey.

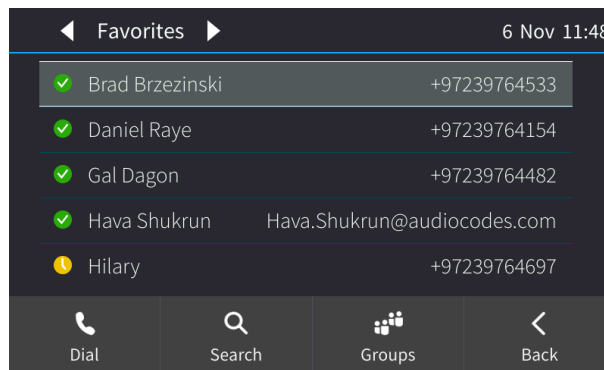

- Touch the **Call Log** softkey and navigate to and select a log from within which you can add a participant.

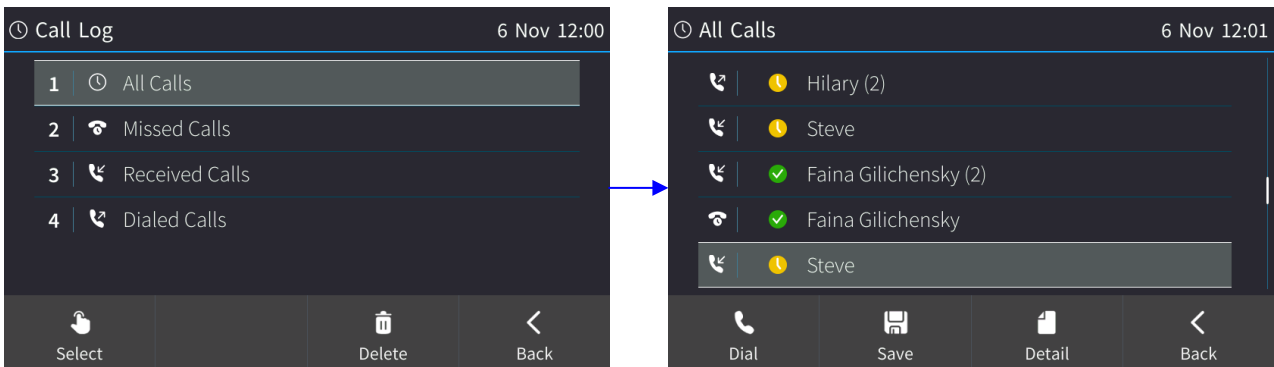

- After navigating to the participant to add, touch the **Dial** softkey (see Section 6.8 for more information about the Call Logs).
5. Add and dial other participants to include in the conference.

➤ **To view conference participants:**

- In the phone's idle screen, touch the **Meet Now** softkey to open the Conference screen.

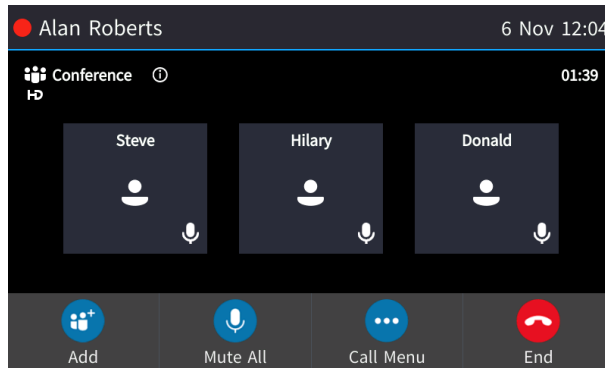

➤ **To disconnect a conference participant:**

1. In the Conference screen, touch the participant to disconnect (e.g., Hilary).
2. Touch the **Call Menu** softkey and in the Call Menu screen that opens, scroll down and select **Disconnect Hilary**.

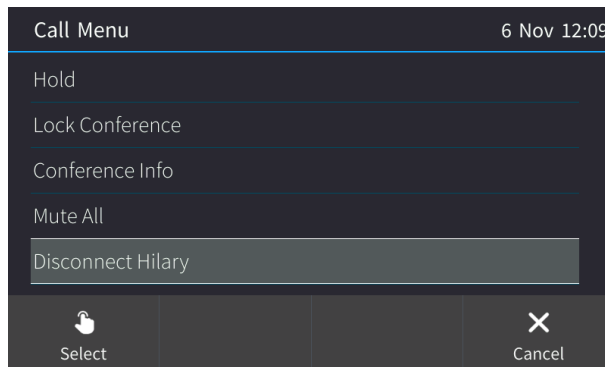

➤ **To change a participant's privileges:**



Note:

- A participant with 'host' privileges can perform every action: far mute, mute all, remove, etc.
- A participant with 'attendee' privileges can only add participants, no more.
- 'host' privileges is relevant only to Skype for Business users rather than - for example - to PSTN/mobile calls.

3. In the Conference screen, touch the participant whose privileges you want to change, e.g., Hilary, and then touch the **Call Menu** softkey.
4. In the Call Menu screen that opens, navigate to and select the **Make Hilary attendee** option.

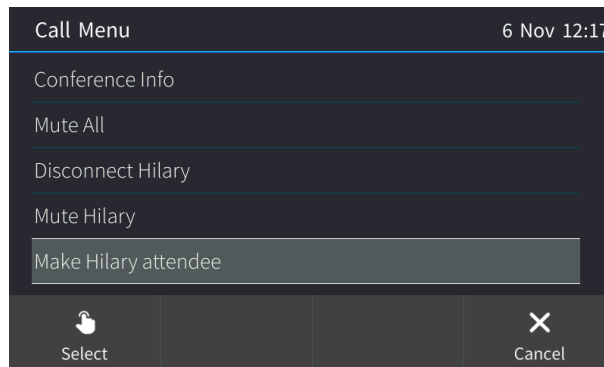

The participant's privileges will change to 'attendee' privileges.

➤ **To mute all participants:**

- In the Conference screen, touch the **Mute All** softkey -or- touch the **Call Menu** softkey and in the Call Menu screen that opens, navigate to and select **Mute All**.

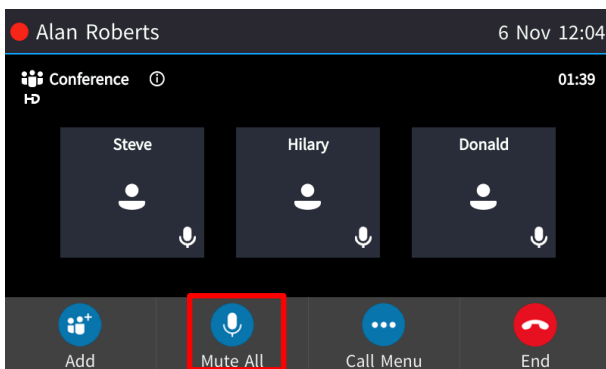

-OR-

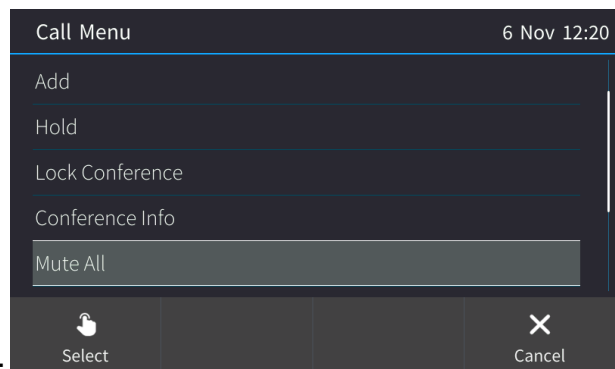

To lock a conference:

- In the Conference screen, touch the **Call Menu** softkey and in the Call Menu screen that opens, navigate to and select the **Lock Conference** option.

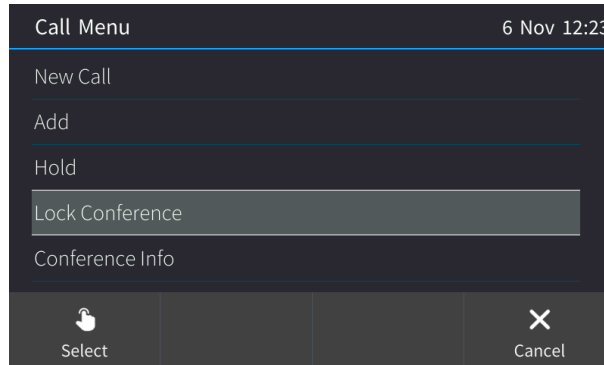

➤ **To view conference information:**

- In the Conference screen, touch the **Call Menu** softkey and in the Call Menu screen that opens, navigate to and select the **Conference Info** option.

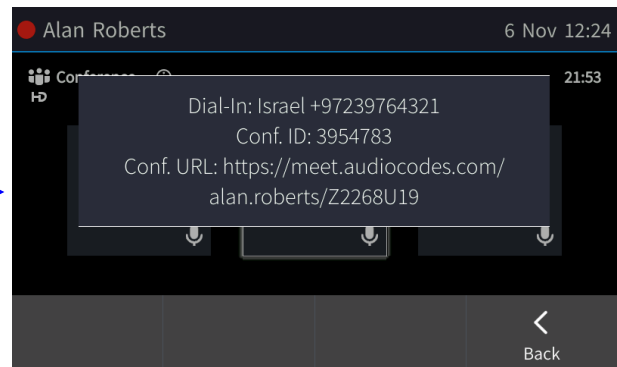
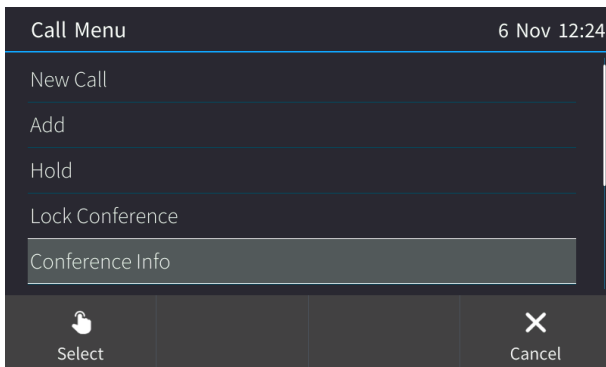

➤ **To mute a remote participant:**

- In the Conference screen, touch the participant to mute (e.g., Donald), touch the **Call Menu** softkey and then navigate down in the Call Menu that opens to select **Mute Donald**, as shown below.

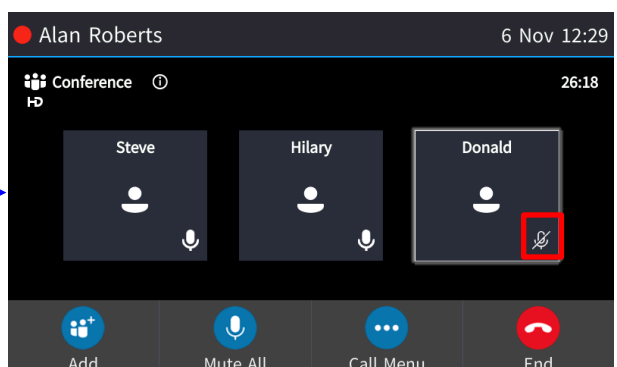
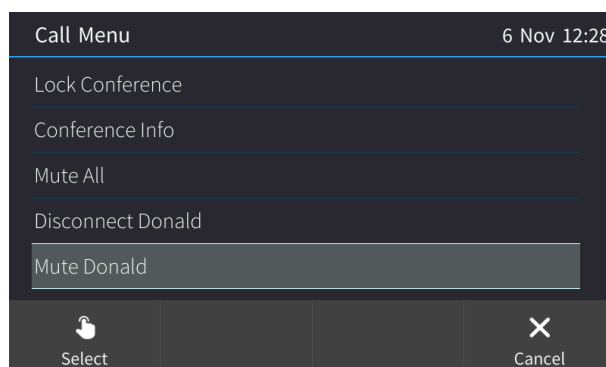

After muting Donald, as shown in the example above, he is displayed with a muted icon. You can also touch an unmuted icon to mute a participant.



Note: If another participant mutes you, you'll view on your screen the message **A presenter has muted you.**

➤ **To unmute a remote participant:**

- In the Conference screen, touch the participant to unmute, e.g., Donald, touch the **Call Menu** softkey and then navigate down in the Call Menu that opens to select **Unmute Donald**.

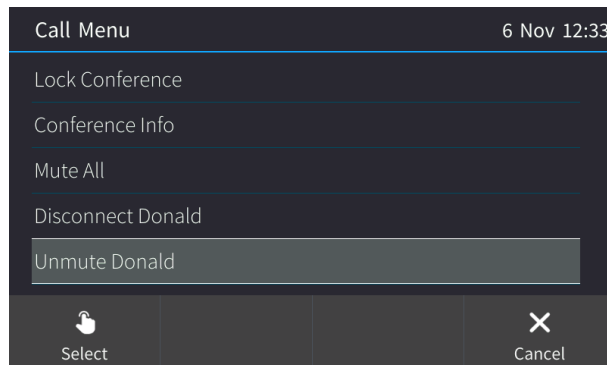

You can also touch the muted icon to unmute a participant



Note: If another participant unmutes you, you'll view on the screen the message **A presenter wants you to unmute yourself**. Press the illuminated (red) mute key on the phone to unmute yourself.

7.11 Muting Calls

You can mute the microphone of the handset, headset, or speaker during a call so that the other party cannot hear you. While the call is muted you can still hear the other party. Muting calls can also be used during conference calls, as described above.

➤ **To mute/unmute:**

1. During a call, press the mute key on the phone 
2. To unmute, press the mute key again and resume the conversation.

7.12 Paging

This feature allows live announcements to be made (paged) from a phone to a group of phones, to notify a team (for example) that a meeting is about to commence at a certain venue. The paged announcement is multicast via a designated group IP address, in real time, on all idle phones in the group, without requiring listeners to pick up their receivers. The name of the group is displayed on phone screens when the paging call comes in.



Note:

- For detailed information on configuring a Function Key for paging on the phone, see Section 5.20.
- The feature must be enabled in the Web interface by the network administrator before a Function Key can be configured for paging. See the *Administrator's Manual* for more information.

7.12.1 Barge-in



Note: The feature must be enabled in the Web interface by the network administrator for it to function. See the *Administrator's Manual* for more information.

If the feature is enabled, paging calls will interrupt (barge in on) phone conversations that are in progress, without prompting you in the phone's screen with an option to accept or reject the paging call.

If disabled (default) and a paging call comes in, you'll be prompted in the phone's screen to choose whether or not to accept or reject the paging call. If you accept, the paging call is heard and the regular call is not.

7.12.2 Performing a Paging Call

The phone speaker, handset or headset can be used as the audio device to page others in your group.

➤ **To page others in your group:**

1. Touch the Function Key displayed in the idle screen that you configured for paging a group – 'Morgages' in the figure below.

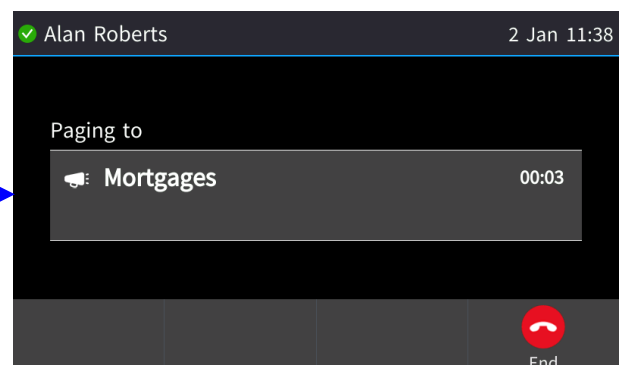
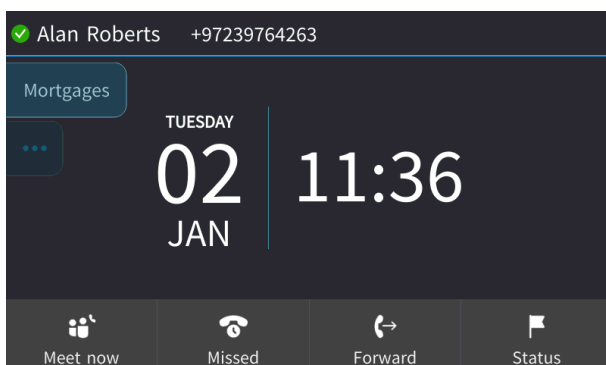

2. Pick up the receiver or talk directly into the speaker or headset to make the announcement.

7.12.3 Receiving an Incoming Paging Call

Others in your group can page you.

➤ **To receive a paging call from another in your group:**

1. View in your phone's screen which group is paging you and listen for the announcement.

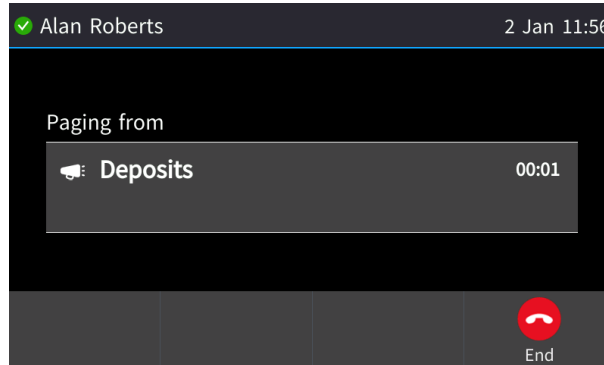

Note: If you're *in a regular call* when the paging call comes in and the 'Barge-in' feature was *enabled* by your network administrator, the paging call barges in on the regular call.

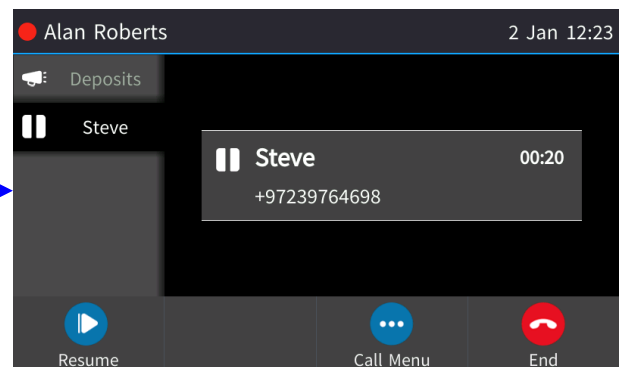
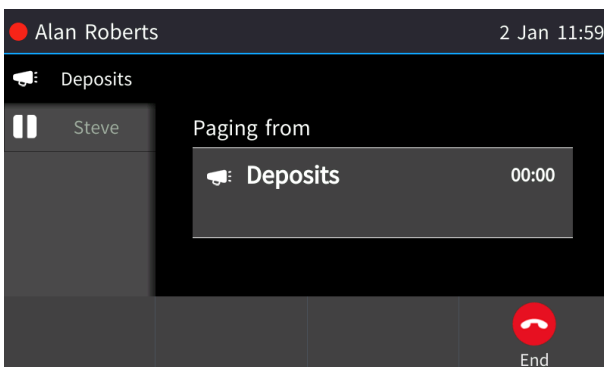

2. Optionally, navigate to the caller whom you were speaking with before the barge-in and then touch the **Resume** softkey to resume the conversation with them.



Note: If you're *in a regular call* when there's an incoming paging call and the 'Barge-in' feature was *disabled* by your network administrator, you're prompted to *accept* or *reject* the incoming paging call.

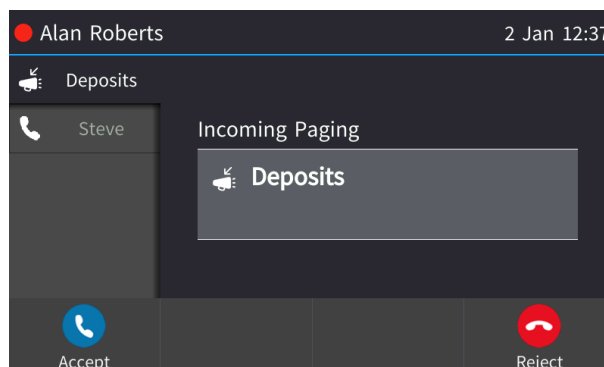

3. If you touch the **Accept** softkey, the incoming paging call is heard and the regular call is not.

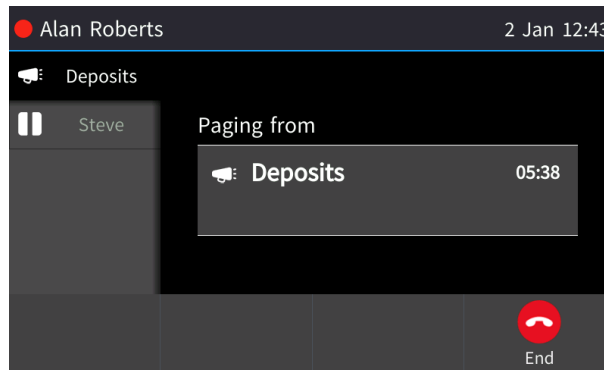

4. If you then touch the **End** softkey, the paging call is terminated and you're given the option to **Resume** the regular call.

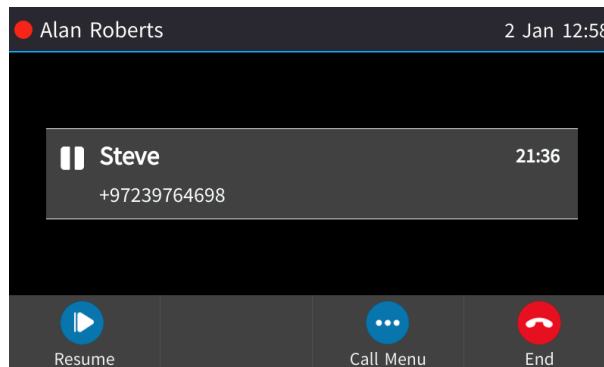

Note: If you'd have touched the **Reject** softkey when the paging call came in, it would have been rejected (not heard) and the regular call would have continued.

7.13 Switching between any Available Audio Device

Users can switch between any available audio device either by pressing the headset / speaker key or by long-pressing the speaker / headset key and then if there are more devices, selecting the device from the list.

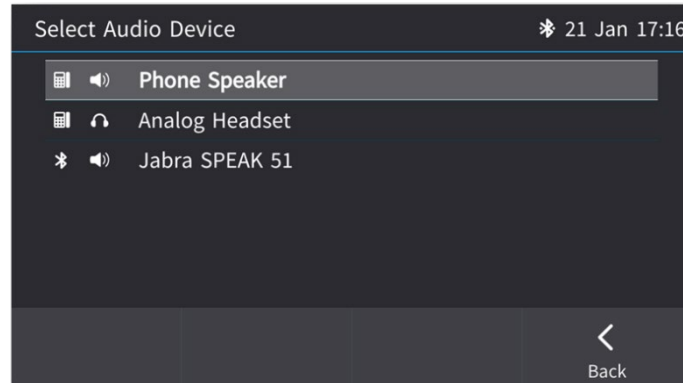

The device indicates the selected audio device in the screen title.

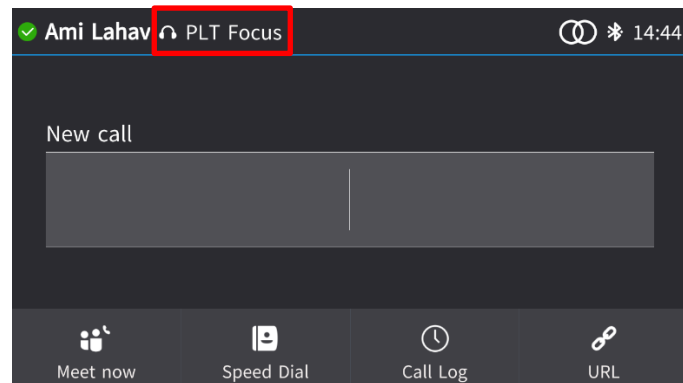

7.14 Configuring a Default Audio Device

Users can configure a default audio device. This is the device that's used when the user presses the accept key to answer calls or when the user dials using a speed dial.

➤ **To configure a default audio device:**

1. Open the Select Audio Device screen (**Settings > Audio device**) and choose the device to be the default.

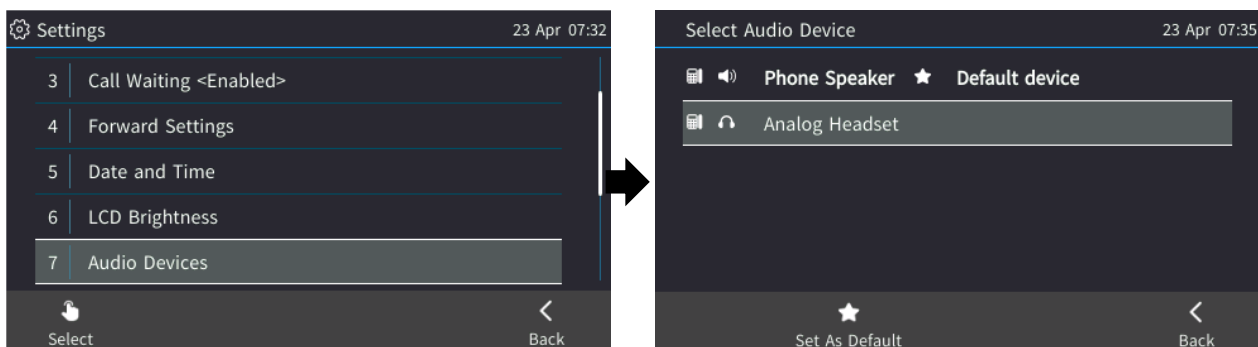

7.15 Configuring Bluetooth on the Phone

The phones support integrated Bluetooth for (wireless) USB headset connectivity.



Note:

- Beta level
- Only applies to the C450HD-BW model.
- Supported in specific regions such as the USA, Canada, the European Union, Switzerland, South Africa and Israel, and requires a specific CPN with a 'BW' suffix when ordering. For an updated list of supported regions, contact AudioCodes.

➤ **To enable Bluetooth on the phone:**

1. Access the Bluetooth screen (**Menu > Settings**):

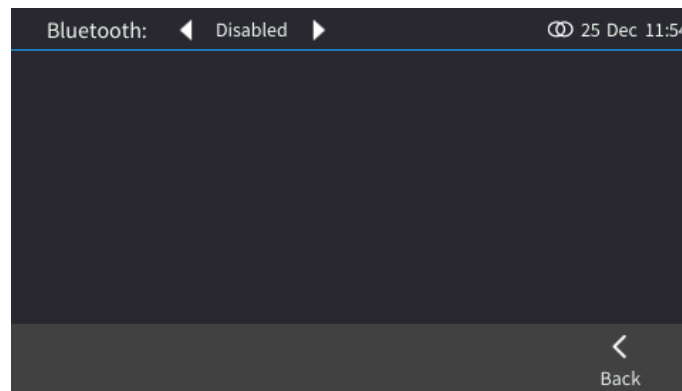

2. Press the right/left rim of the navigator key to configure **Enabled**:

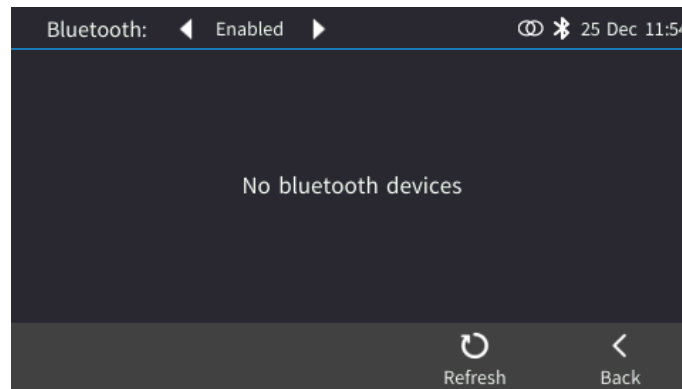

3. Configure the device (Bluetooth headset or speaker) to allow pairing and then press the **Refresh** softkey; the phone attempts to discover available devices:

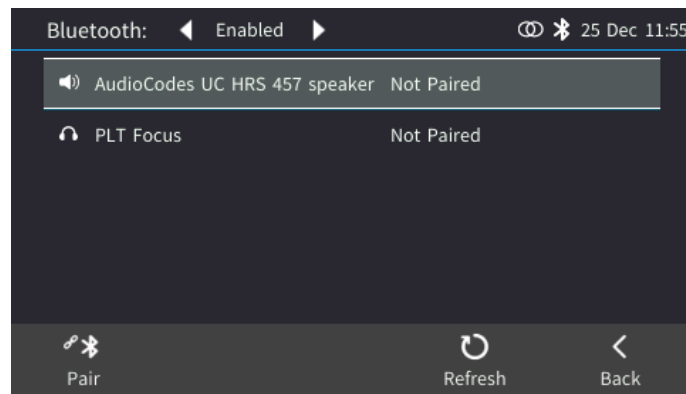

4. Press the **Pair** softkey to pair the device. After pairing is complete, the phone displays 'Connected'.

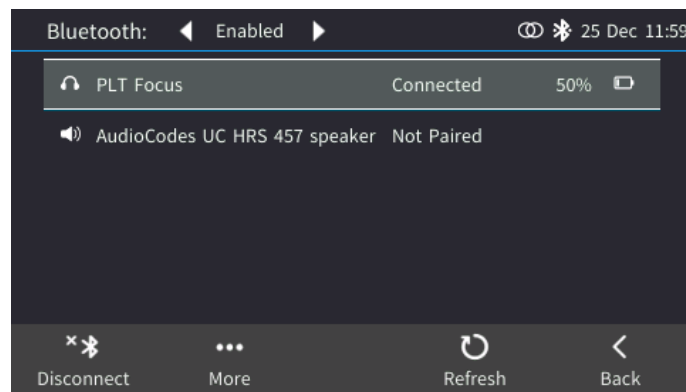

- When the phone is connected via Bluetooth, its battery level is visually indicated adjacent to the 'Connected' indication. Bluetooth connectivity is indicated on the upper bar by the Bluetooth icon.
 - ◆ indicates Bluetooth is enabled, not paired
 - ◆ indicates that the device is connected
- Start using the device.
- The following Bluetooth call controls are supported (and can be used from the Bluetooth device itself):
 - ◆ Accept call
 - ◆ End call
 - ◆ Reject call
 - ◆ Mute/unmute
 - ◆ Volume up/down

Note:

- All Bluetooth headsets are defined by the phone as headsets and the phone's headset hard key onhooks / offhooks the headset.
- Connecting both the USB headset and the Bluetooth headset is currently not recommended.
- Known speakers such as the HRS 457, Jabra 710 and Jabra 510 are not defined as Bluetooth headsets. Users can define a known Bluetooth speaker as the phone's default Audio Device from **Settings > Audio Device**:

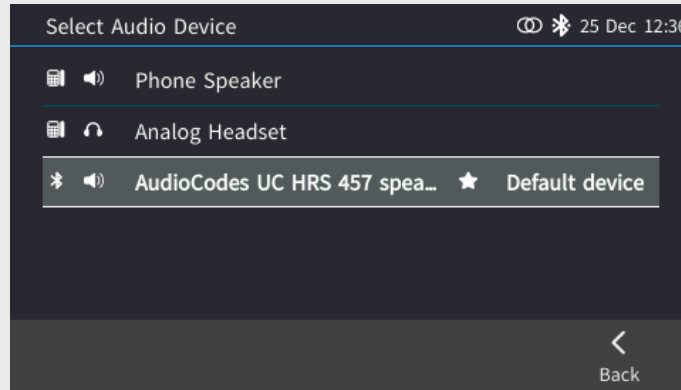

- After it is selected, the Bluetooth speaker will be used whenever a call is answered via the **Accept** softkey or initiated via the **Dial** key. The phone's hard speaker and headset keys are used for its speaker and connected headset, for example, USB headset.

7.16 Setting up Better Together over Ethernet

BToE enables operations to be mirrored on both AudioCodes' IP phone and the Skype for Business client on the PC/laptop, so that these operations can be controlled from either the phone or the PC/laptop, whichever is convenient to the user at the time, for enhanced unified communications and optimized enterprise efficiency.

After your phone is paired with your Skype for Business client, you can control (from phone or PC/laptop) operations such as answering incoming calls, making outgoing calls (click-to-dial), putting calls on hold and resuming them, and making conference calls. Note that BToE is also supported in a Citrix XenDesktop virtual desktop infrastructure (VDI) environment. Consult your network administrator if necessary. See also the *Administrator's Manual*.

7.16.1 Installing the BToE PC/Laptop Application

This section shows how to install AudioCodes' BToE PC/laptop application.

➤ **To install the BToE PC/laptop application:**

1. After obtaining the installation file whose name will be either *AudioCodes BToE.exe* or *AudioCodes BToE.msi*, save it to your PC/laptop and then double-click it.

Note:

- The *msi* file is for the purpose of network administrator distribution. Users are not allowed to install BToE using the *msi* file, only using the *exe* file.
- After installing with the *exe*, then when upgrading the *exe* must be used. Upgrading with the *msi* cannot be done if the first installation was with the *exe*, and vice versa.
- Some PCs require the installation of .Net 4.0 prior to the installation of the BToE PC/laptop application. If you use the installation file *AudioCodes BToE.exe*, the Installation Wizard will detect that .Net 4.0 is missing and will prompt you to install it:

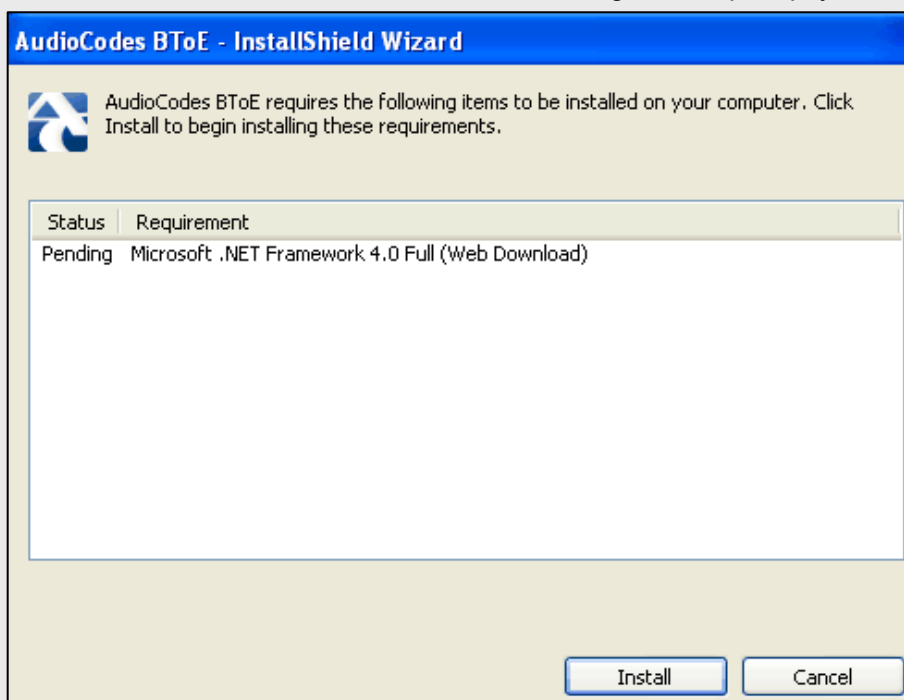

When installing the BToE PC/laptop application using the installation file *AudioCodes BToE.msi*, you won't be prompted to install .Net 4.0 and the network administrator should make the necessary preparations prior to installation of the BToE PC application.

The Prepare to Install screen opens showing preparation progress until the Welcome to the InstallShield Wizard screen opens:

Figure 7-1: InstallShield Wizard – Preparing to Install

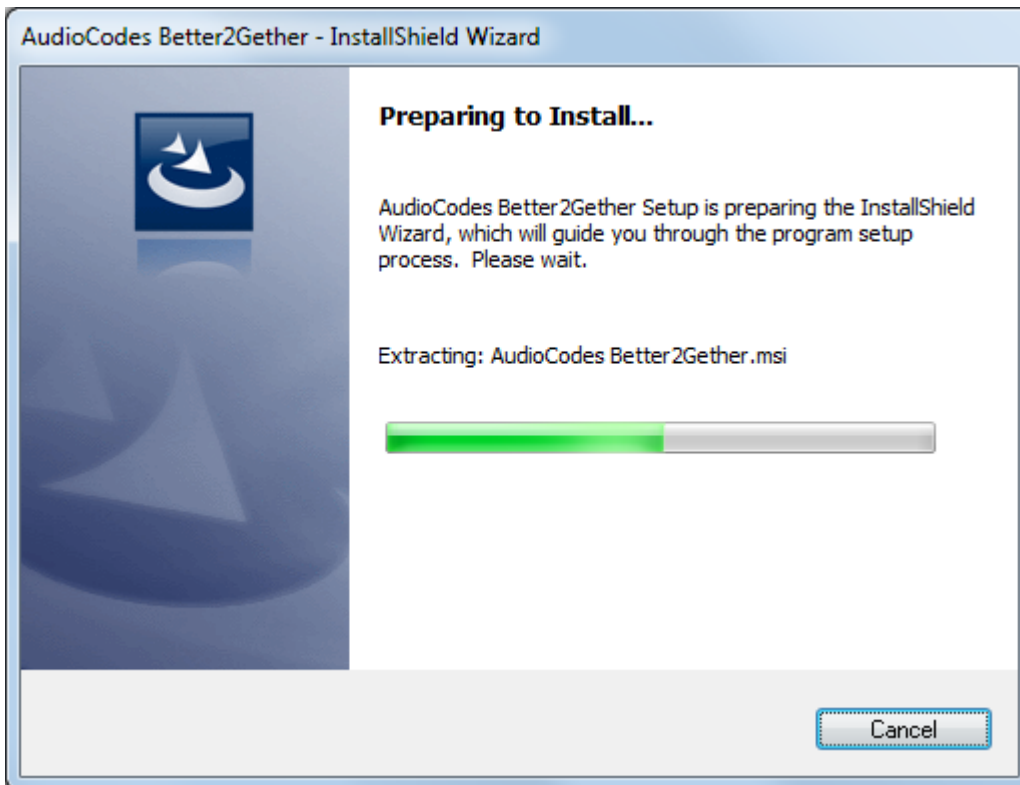
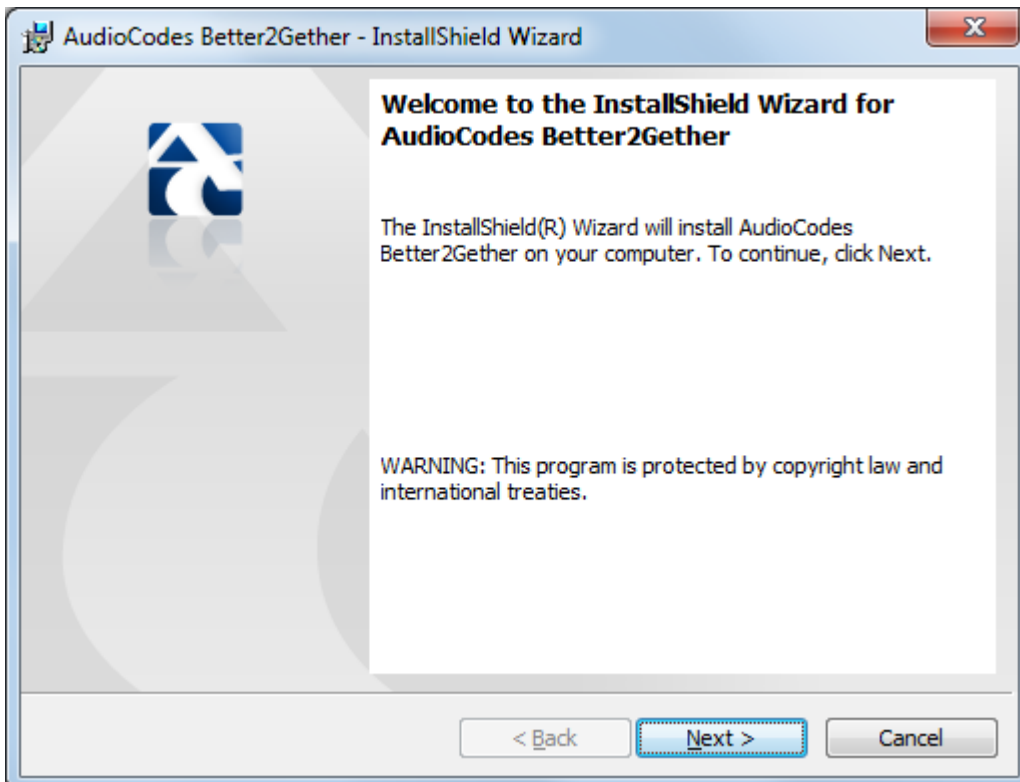
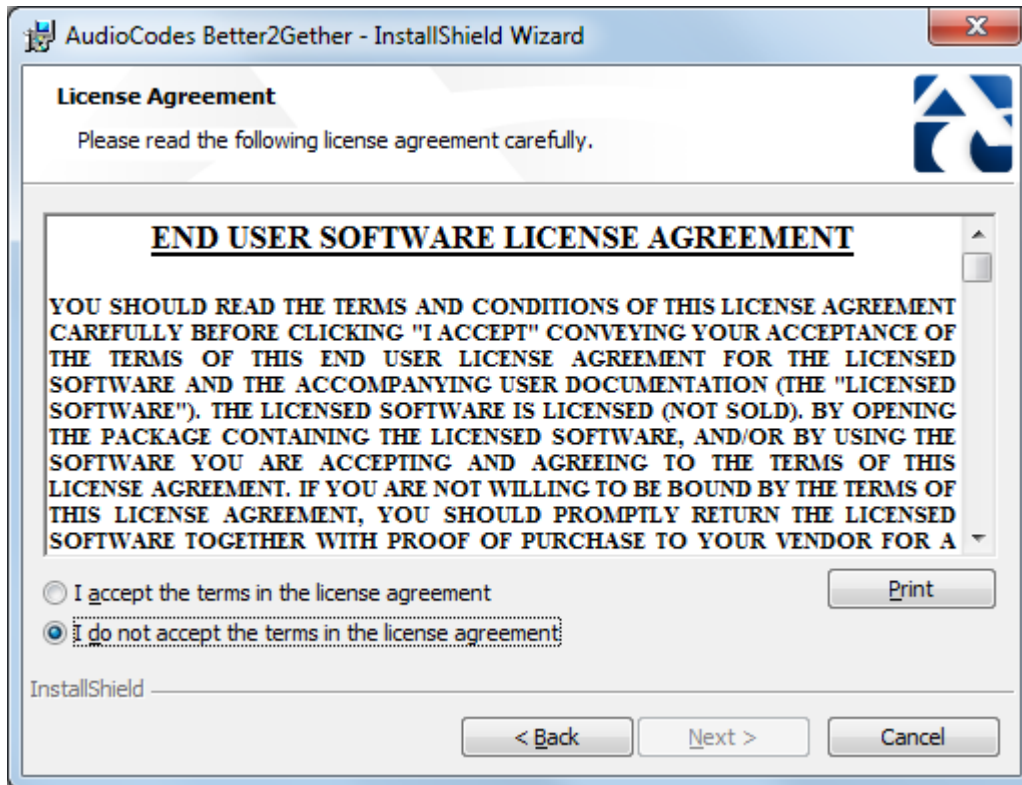

Figure 7-2: Welcome to the InstallShield Wizard



2. Click the **Next** button; the License Agreement screen opens.

Figure 7-3: License Agreement



3. Select the **I accept...** option and click **Next**.

Figure 7-4: License Agreement

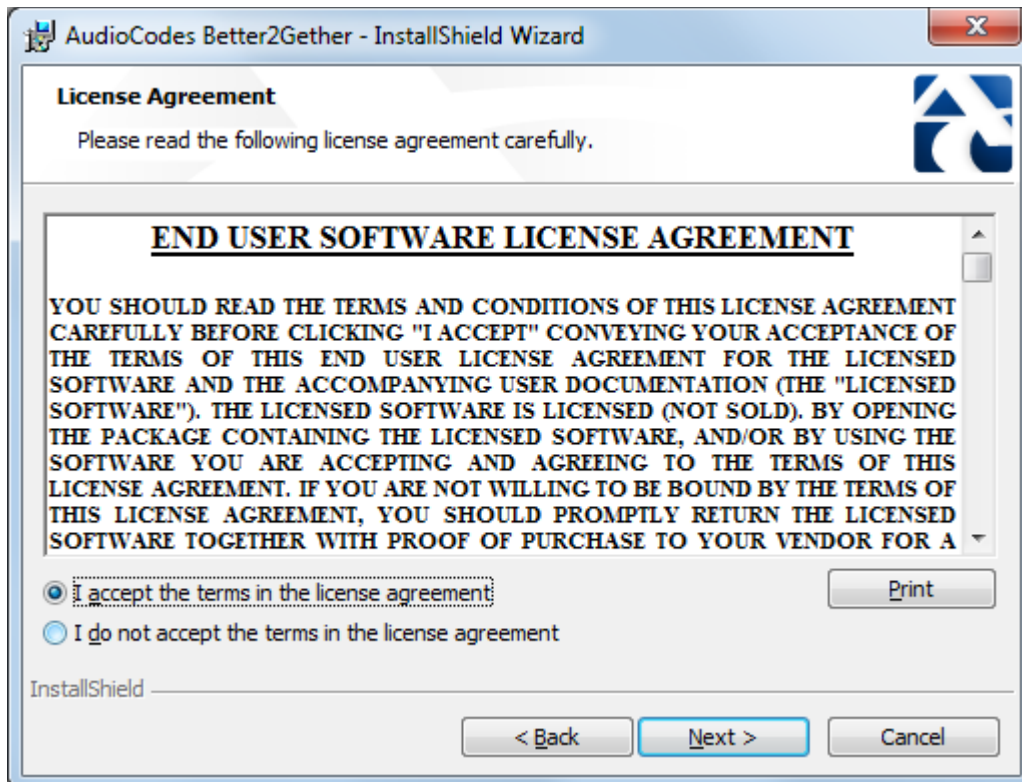

4. Click **Next**; the Destination Folder screen opens.

Figure 7-5: Destination Folder

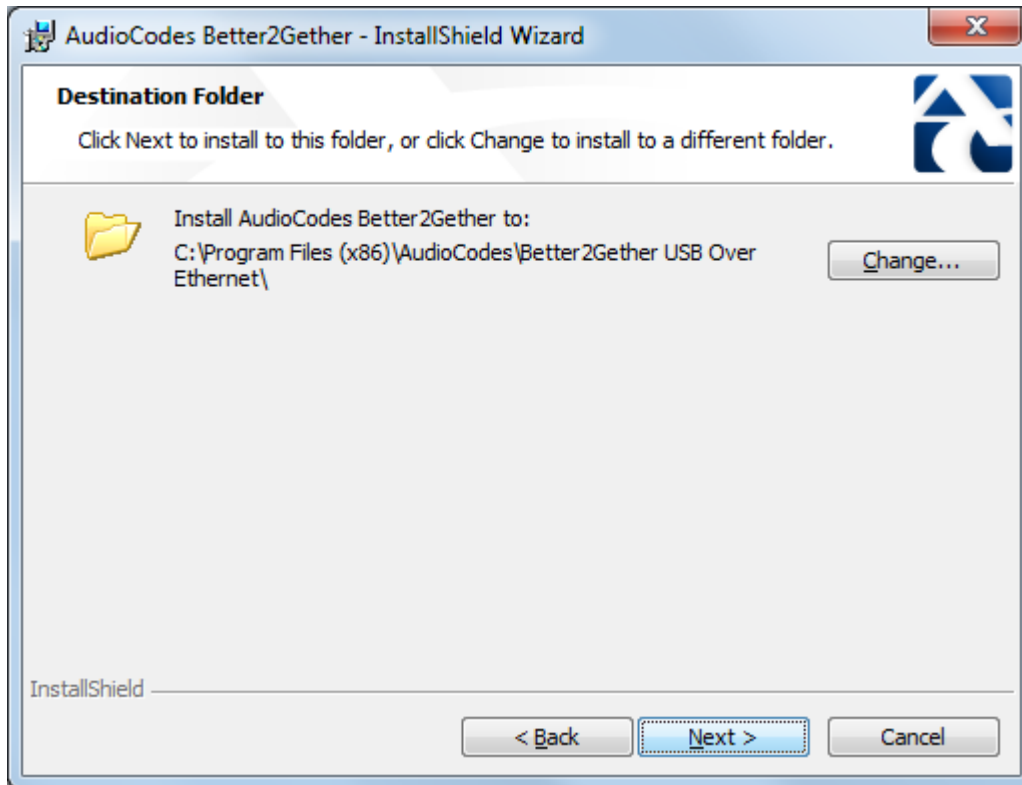

5. To change the default Destination Folder, click **Change** and proceed to step 6. To leave the Destination Folder at its default, click **Next** and proceed to step 7.

Figure 7-6: Change Current Destination Folder

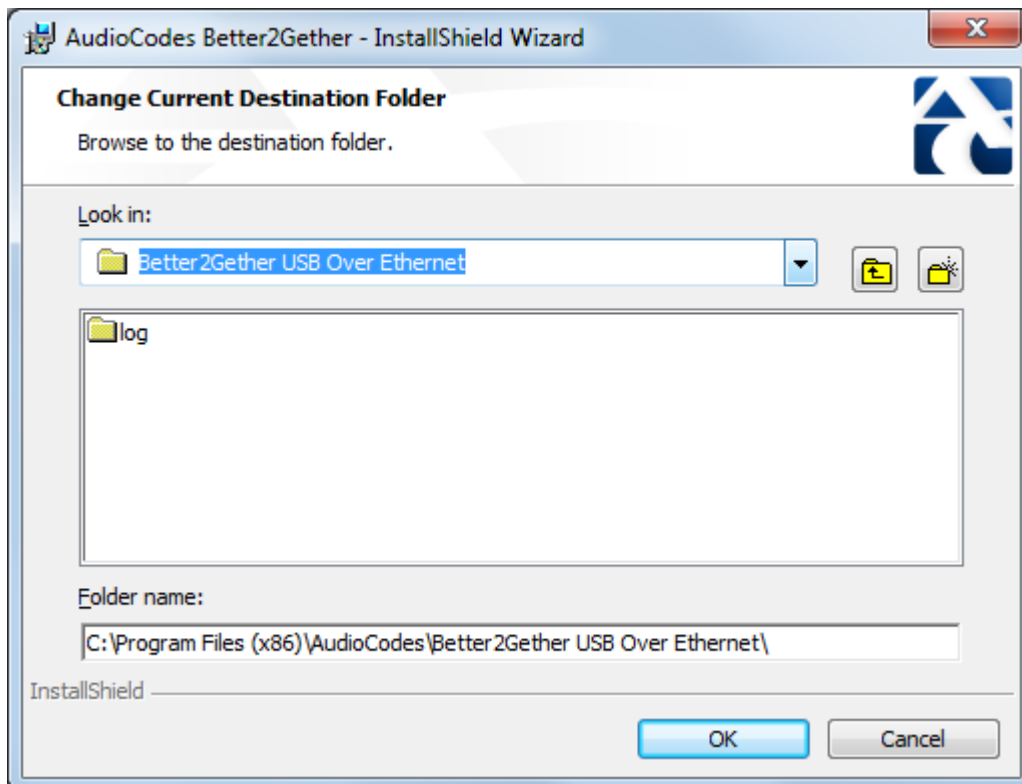

6. Click **OK**; you're returned to the Destination Folder screen.
7. Click **Next**; the Ready to Install screen opens.

Figure 7-7: Ready to Install

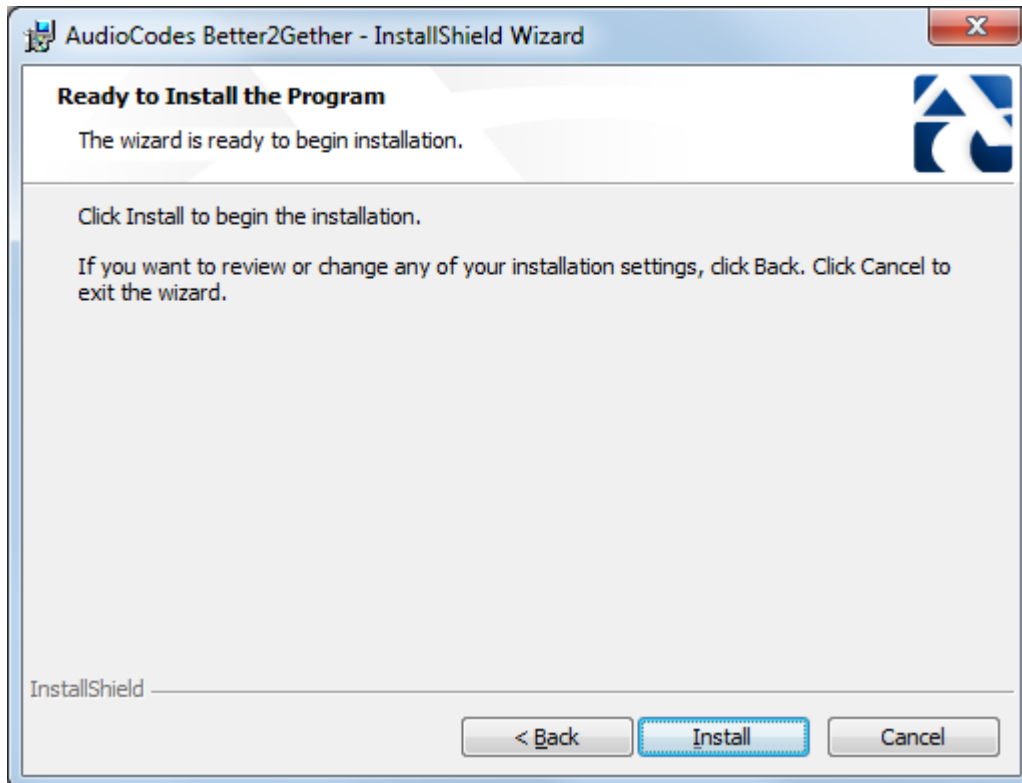

8. Click the **Install** button; the Installing AudioCodes Better2Gether screen opens indicating installation progress status.

Figure 7-8: Installing AudioCodes Better2Gether

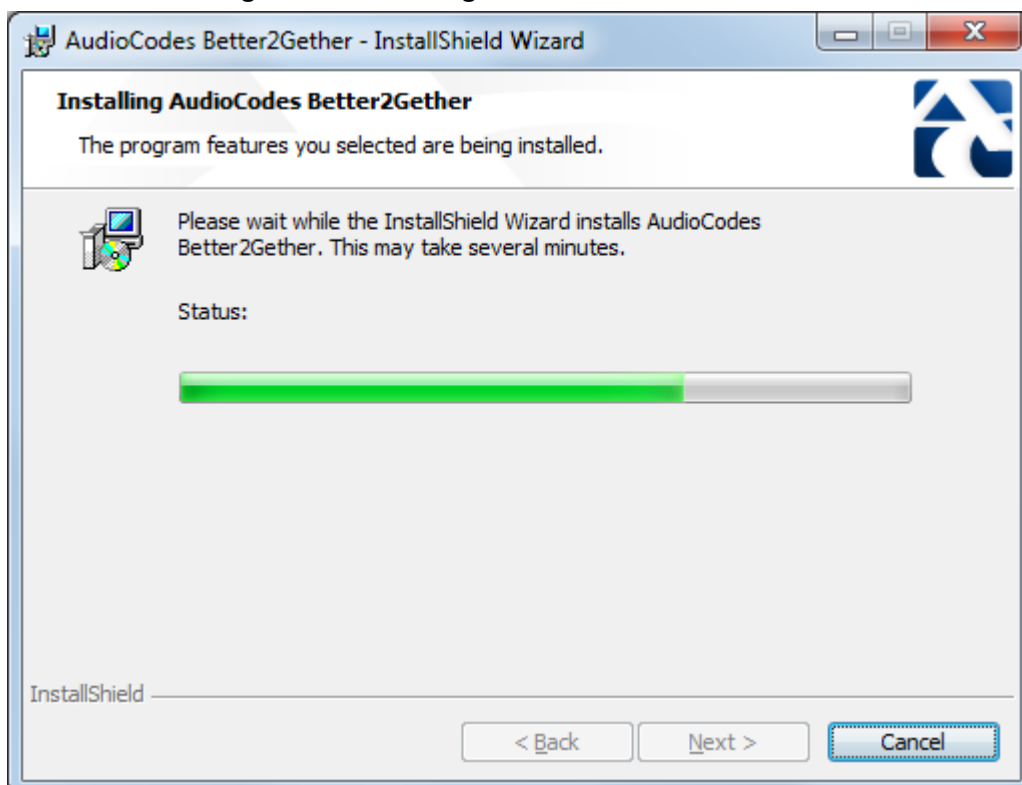

9. Wait until the following screen is displayed:

Figure 7-9: InstallShield Wizard Completed

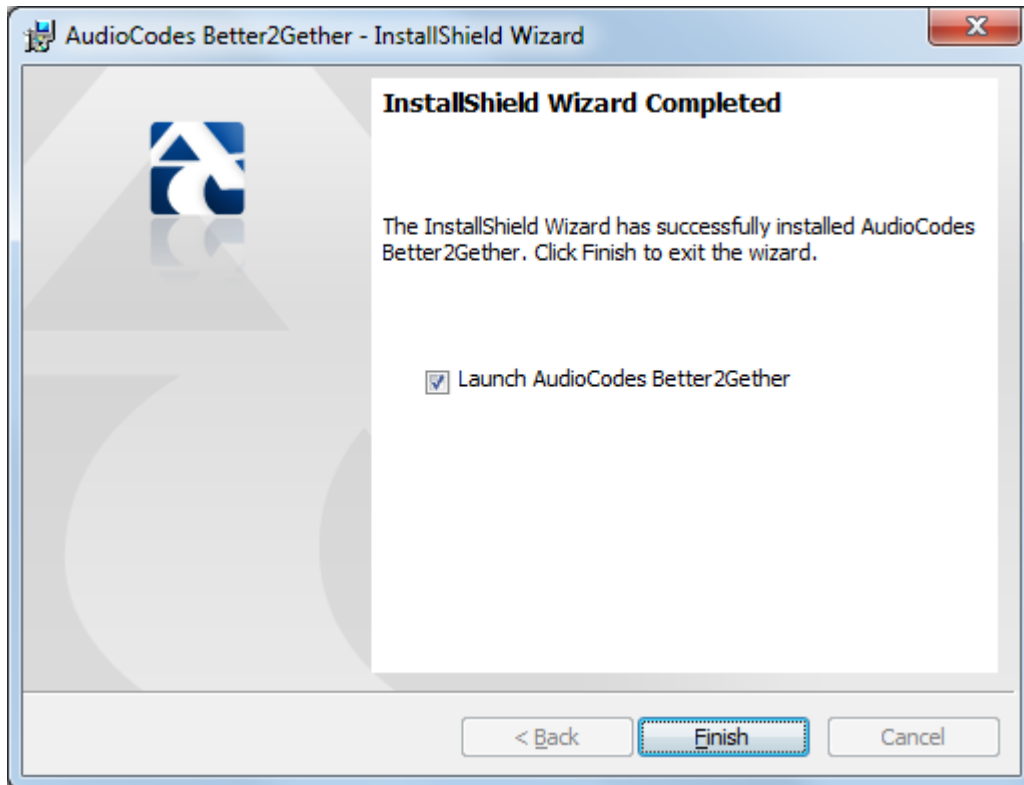

10. Click the **Finish** button and then check your Windows taskbar and locate the newly displayed AudioCodes icon (AC) as shown below:

Figure 7-10: AudioCodes Icon in Taskbar

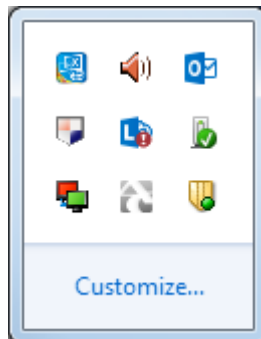

11. Wait until the “Installing device driver software” process completes:



12. Check your programs in the Control Panel > Programs. You should see:

Figure 7-11: Control Panel>Programs>AudioCodes Better2Gether

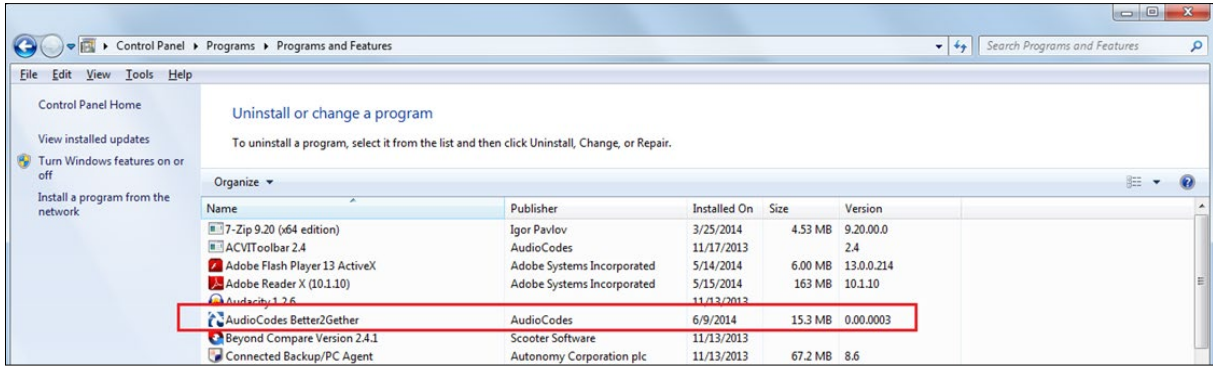

Note: You can use this entry in the Control Panel > Programs to uninstall.

13. Access Computer Management > Services and Applications and locate 'BtoE':

Figure 7-12: Computer Management > Services and Applications

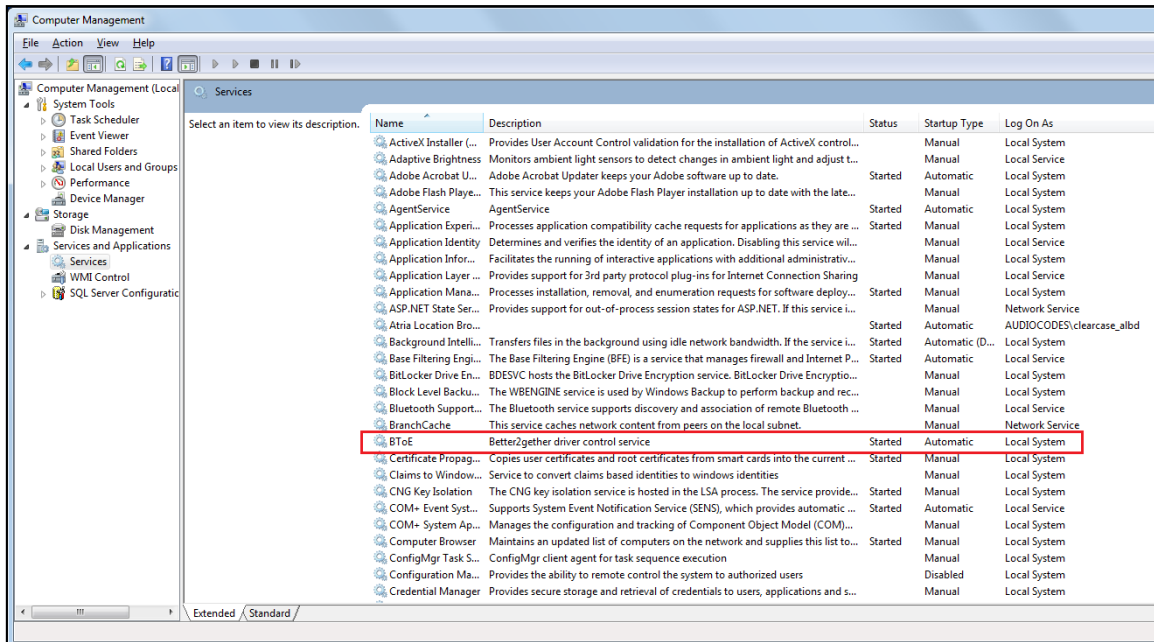

14. Access the Device Manager and locate 'AudioCodes B2GoE USB driver'.

Figure 7-13: Device Manager > AudioCodes B2GoE USB Driver

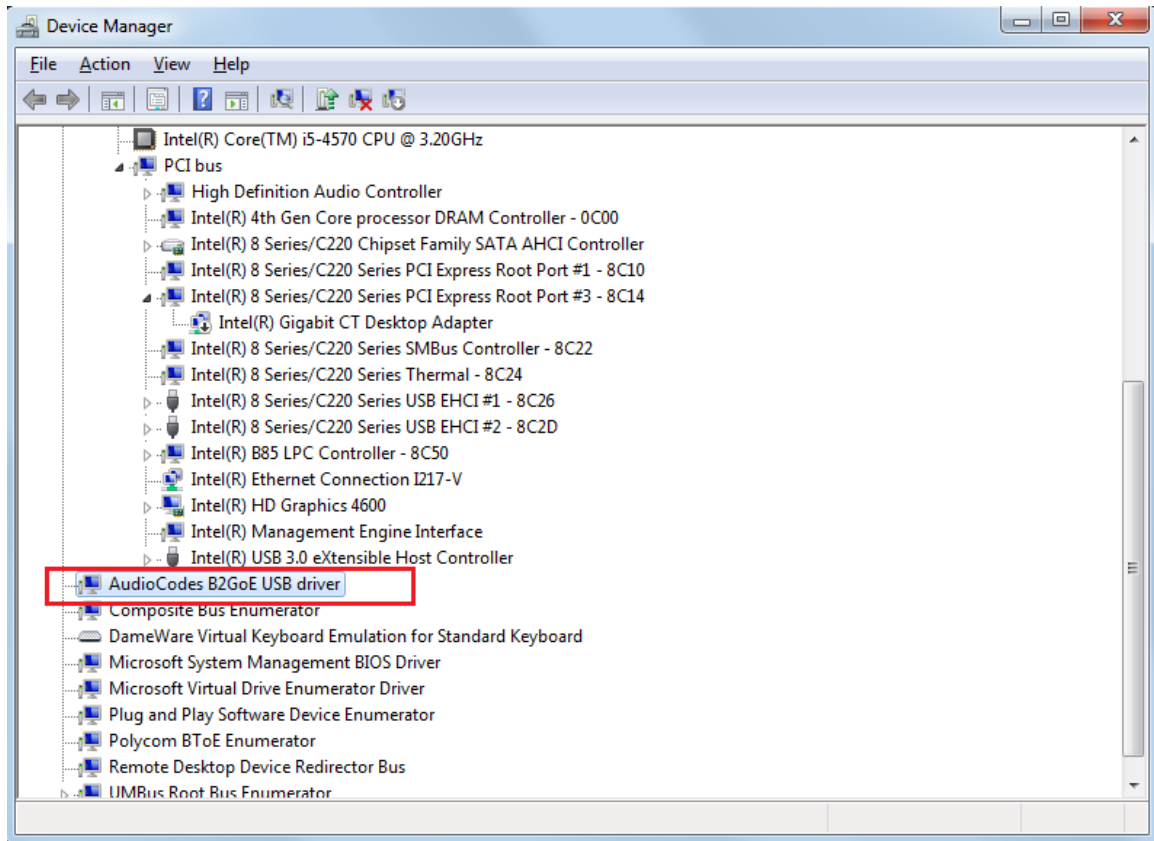

You've successfully installed the program.

7.16.2 Making Sure BToE is Correctly Installed

This section shows how to make sure Better Together over Ethernet is correctly installed.

➤ **To make sure BToE is correctly installed:**

1. Click the **AC** (AudioCodes) taskbar icon; the following menu pops up:

Figure 7-14: Popup Menu

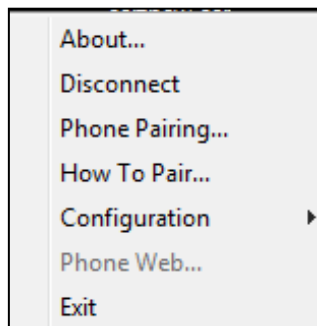

2. Select the **About...** menu option to verify the DLL and BToE version:

Figure 7-15: About AC BToE

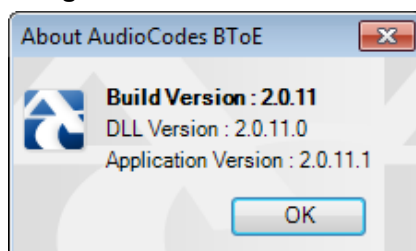

7.16.3 Configuring the BToE TCP Port

You can opt to configure a different BToE TCP port to the default 9999, depending on the requirements of your enterprise. For example, you may decide to change the BToE TCP port to 5000 because your enterprise is using the default port of 9999, and 5000 is available. This feature therefore provides enterprise administrators with more freedom in network administration.



Note: If you decide to change the default BToE TCP port, you must update *both* the PC/laptop *and* the phone with the new BToE TCP port number.

➤ **To change the BToE TCP port on the PC/laptop side:**

1. Click the **AC** (AudioCodes) taskbar icon; the menu shown in [Figure 7-14](#) pops up.
2. Select **Disconnect** in the popup menu and then select **Configuration > TCP Port**.

Figure 7-16: TCP Port

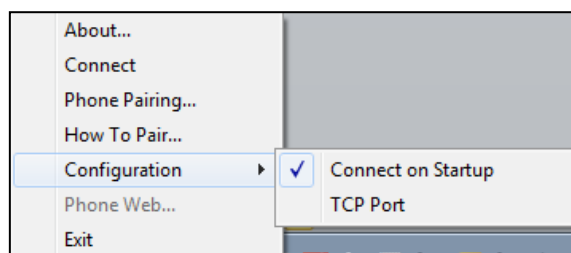

- From the AC BTOE TCP Port dialog that opens, configure the TCP Port:

Figure 7-17: AC BToE TCP Port



The valid range is 1 to 65535.

- **To change the BToE TCP port on the phone side:**
 - See the *Administrator's Manual*.

7.16.4 Enabling BToE for Online Users



Note: To enable BToE for online users, the Skype for Business server must be configured to enable BToE.

7.16.5 Automatically Pairing the BToE PC/Laptop Application with the Phone

Pairing is automatically performed when the phone's PC port is connected to the PC/laptop 'behind' the phone. See the *Administrator's Manual* for more information.



Note: Automatic pairing requires BToE PC/laptop application Version 2.x.

If the laptop after *automatic* pairing is disconnected and moved to another location, its speaker/headset becomes the audio device associated with the Skype for Business client. If the laptop is *manually* paired and then relocated, Skype for Business audio will remain through the phone. It's therefore advisable to pair *automatically*.

Note: If the BToE PC/laptop application has already been *manually* paired with the phone, as shown in the section below, and you want to *automatically* pair, you must delete the old pair code from the BToE PC/laptop application in order to allow BToE *automatic* pairing:

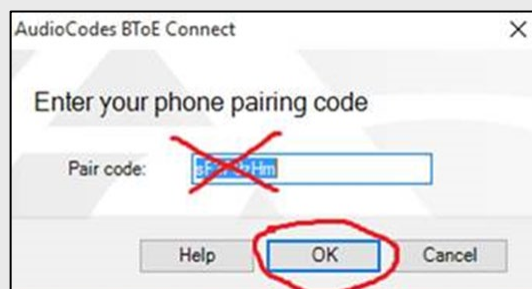

7.16.6 Manually Pairing the BToE PC/Laptop Application with the Phone

This section shows how to *manually* pair AudioCodes' BToE PC/laptop application with the phone using a pair code. Even though *automatic* pairing gives users greater freedom, *manual* pairing is still an option. Manually pair like this:

1. Generate a pair code (see Section 7.13.6.1)
2. Connect the phone and BToE PC/laptop application using the pair code (see Section 7.13.6.2)



Note:

- If the IP changes, you will need to generate a pair code again.
- If you know the last pair code, you don't need to generate a new one. If you don't know it, continue below.

7.16.6.1 Manually Generating a Pair Code

This section shows how to manually generate a pair code.



Note: The phone is by default *automatically paired* with the PC/laptop. If you want to *manually* pair, consult with your network administrator. See the *Administrator's Manual*.

➤ **To manually generate a pair code:**

- Press the MENU hard key on the phone and then touch the **BToE** option; the BToE pairing code is displayed:

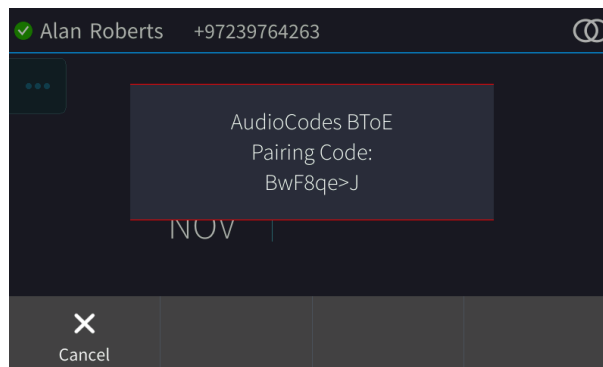

Note: This is the pairing code that will be used by the BToE PC/laptop application. Make a note of it for reference when connecting the phone with the BToE PC/laptop application.

7.16.6.2 Manually Connecting the Phone with the BToE PC/Laptop Application

This section shows how to connect the phone with the BToE PC/laptop application.

➤ **To connect the two:**

1. Open the AudioCodes BToE Connect screen: Click the BToE client icon placed on your taskbar after installation; the following popup menu opens.

Figure 7-18: Popup Menu

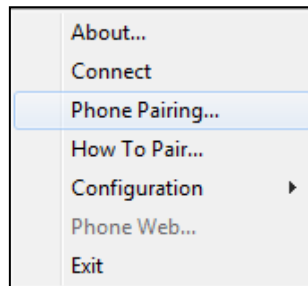

2. Select the **Phone Pairing** option

Figure 7-19: Phone Pairing

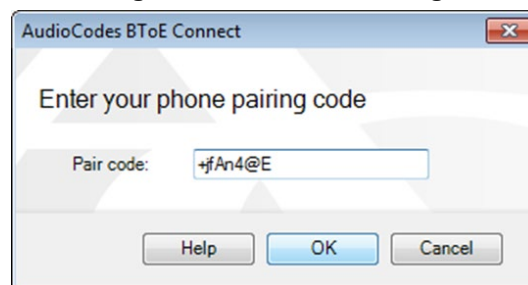

3. In the 'Type the pair code' screen, enter the pair code that you generated as shown in Section 7.13.6.1; the **OK** button is activated after 8 characters are entered.
3. Click the **OK** button; BToE is activated.
4. If a communication error occurs or the wrong pair code was entered, the following icon indication appears:

Figure 7-20: AC BToE Failed Indication

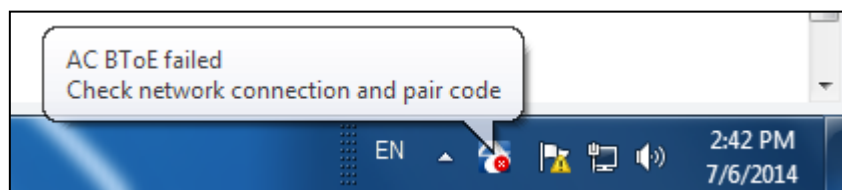

5. When BToE is successfully connected, view the following icon indication:

Figure 7-21: AC BToE is Connected Indication

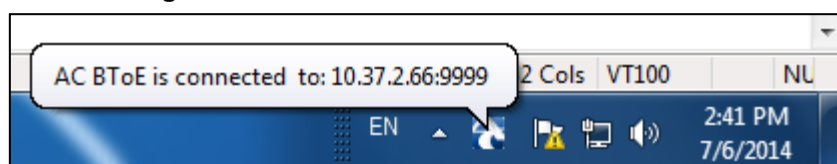

6. When BToE is in 'Connected' state, the popup menu shows the **Disconnect** menu item and the **Phone Pairing** menu item is deactivated:

Figure 7-22: Popup Menu: 'Disconnect' Enabled, 'Phone Pairing' Disabled

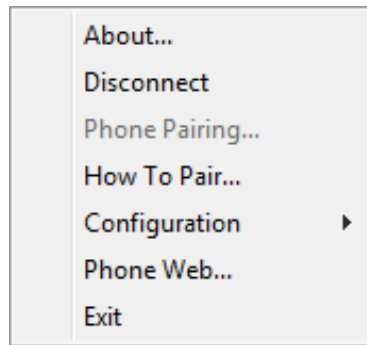

7. After selecting the **Disconnect** menu option, the 'AC BToE Disconnected' indication is displayed:

Figure 7-23: BToE Disconnected

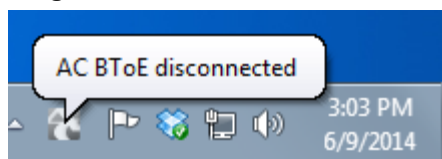

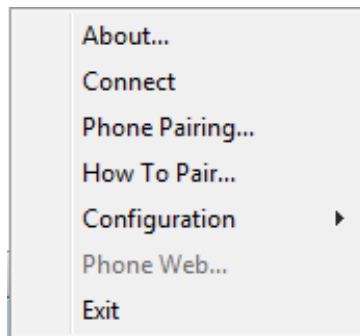

8. From the popup menu as well you can see if BToE is disconnected:

Figure 7-24: Popup Menu: BToE Disconnected



Note: When BToE is connected, you can select the **Phone Web** menu option to open the phone's the Web interface.

9. Use the table below as reference when determining BToE's connection state from the taskbar icon.

Taskbar Icon	BToE's connection state
	BToE is connected
	BToE is disconnected
	BToE is connected but a failure is preventing a correct connection. The failure can be a network problem or the wrong pair code was defined.

- From the click popup menu, you can select the **Exit** option; the BToE PC application stops. You can activate the application again from the Start menu as shown in [Figure 7-25](#).

Figure 7-25: Start > Programs > AudioCodes > BToE Controller

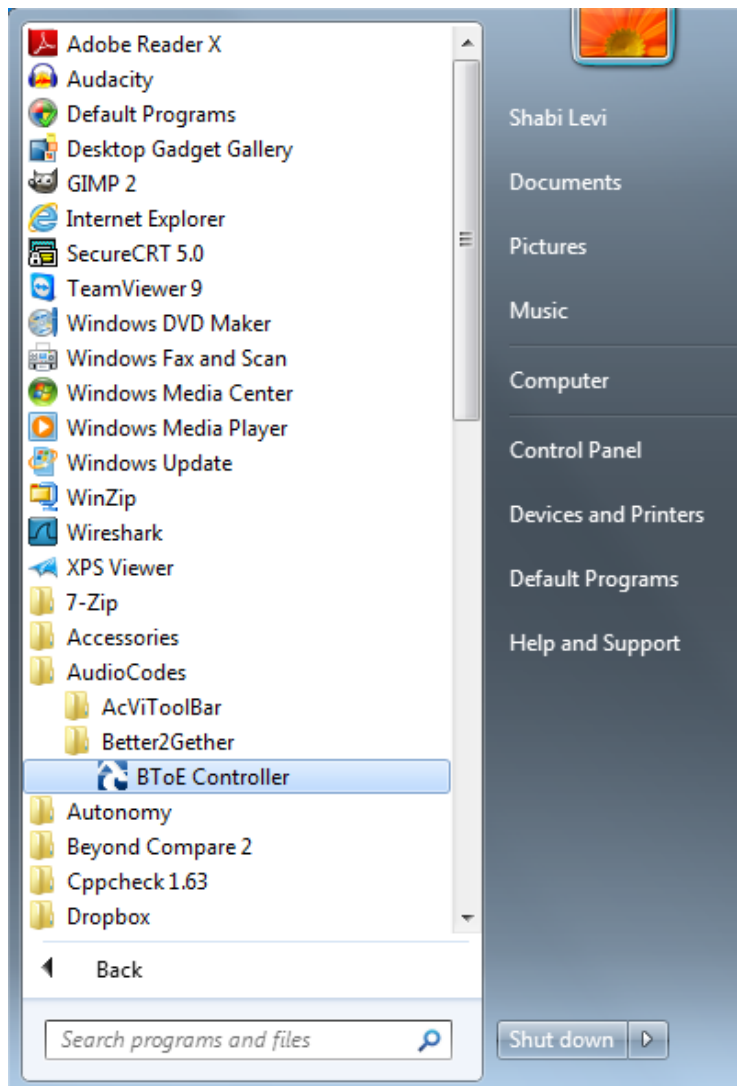

7.16.6.3 Connecting the Skype for Business Client with the Phone

This section shows how to connect the Microsoft Skype for Business client with the phone using the Skype for Business login screen.

➤ **To connect the two:**

- Enter your credentials in the Skype for Business Sign-in request prompt, and click **OK**.

Figure 7-26: Skype for Business Sign-in Request Prompt

Note:

- Signing in via the Skype for Business client is flexible with respect to user name format: It can be entered in NetBIOS format (domain\user, for example, companyname\johnb) as well as User Principal Name (UPN) format (user@domain, for example, johnb@companyname.com).
 - ✓ BToE version 2.1.8 must be installed.
 - ✓ The configuration file parameter 'lync/BToE/use_UPN_str' must be configured to 1 (Default: 0).
- Primary Device cannot be changed in Skype for Business Client PC/laptop client during a call. When the phone is in idle mode (not in a call), the PC/laptop application must be disconnected in order to change Primary Device. See the *Release Notes*.



7.16.7 Making Sure the Phone/ Skype for Business Client are Paired

This section shows how to make sure you successfully paired your phone with the Skype for Business client.

7.16.7.1 Making Sure Skype for Business Client is Paired

You can make sure the Skype for Business client is paired with the phone.

➤ **To make sure the Skype for Business client is paired with the phone:**

1. In the Skype for Business client application, in the lowermost left corner of the screen, click the Select Primary Device icon

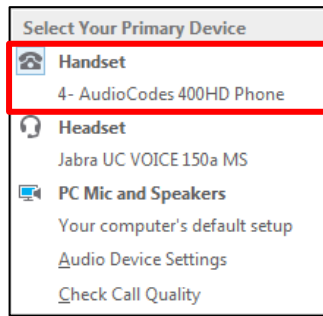

2. Make sure **Handset AudioCodes 400HD Phone** is selected.

7.16.7.2 Making Sure the Phone is Paired

You can determine from the phone's idle screen if the phone is paired with the Skype for Business client. Two interlocked rings in the idle screen indicate the phone is paired.

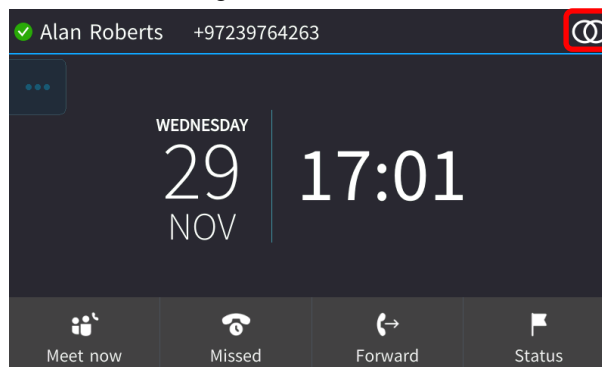

If the idle screen does not display two interlocked rings, the phone is *not* paired. After connecting, a 'BToE Activated' notification pops up and then disappears.

7.17 Using BToE Functions

You can use the phone as an extension of the Skype for Business client, and the client as an extension of the phone, for enhanced unified communications and optimized efficiency. Before using BToE functions, you need to install BToE and to make sure in the Skype for Business client that the 'Primary Device' selected is **Handset AudioCodes BToE**.

7.17.1 Signing in to the Phone from the Skype for Business Client

You can sign in to the phone from the Skype for Business client.

➤ **To sign in to the phone from the Skype for Business client:**

1. Sign out from the phone.
 - a. In the phone's idle screen, touch the **Status** softkey and then in the Status screen that opens, touch the **Sign out** softkey; the phone goes offline.

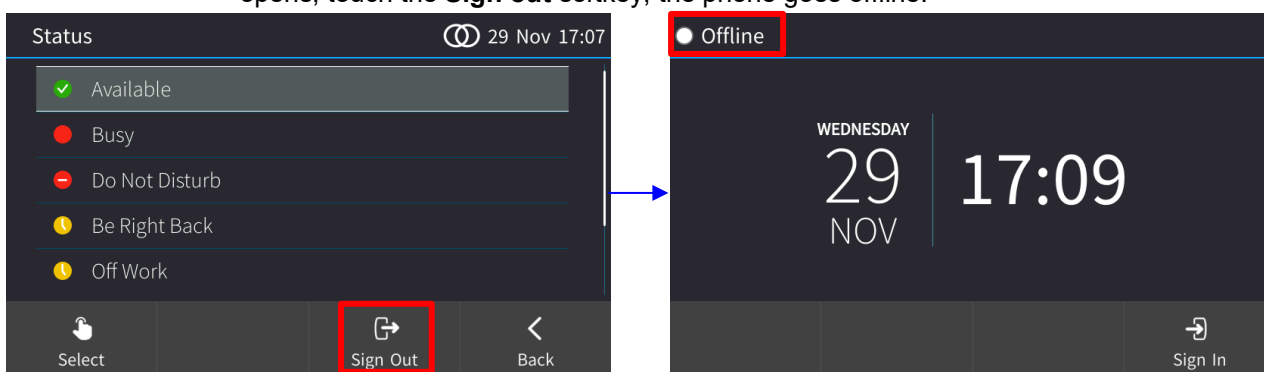

- b. The Skype for Business client on the PC prompts you for Logon information.

✕

Logon information needed

A connection has been detected between your desk phone and Skype for Business. To complete the connection, type your network logon password.

Sign-in address:

User name:

Password:

2. Enter the same password you use to access your PC and then click **OK**; the phone displays the registration process, a 'BToE Activated' notification pops up, and the Phone Lock screen is displayed.
3. Enter a PIN code to unlock the phone – see Section 0 for more information.

The phone is signed in and after a few seconds, the two interlocked rings are displayed indicating that the phone is paired with the PC BToE application. Note that the phone's IP address may change during the registration process.

7.17.2 Making a Call (Click-to-Dial)

You can make a call from the PC Skype for Business client or from the phone; the one operation mirrors the other, providing an enhanced UC experience and optimized enterprise efficiency.

➤ **To make a call:**

1. In the PC Skype for Business client, click the digit keys of the number to call (or call from Outlook); both phone and client display a Calling screen.

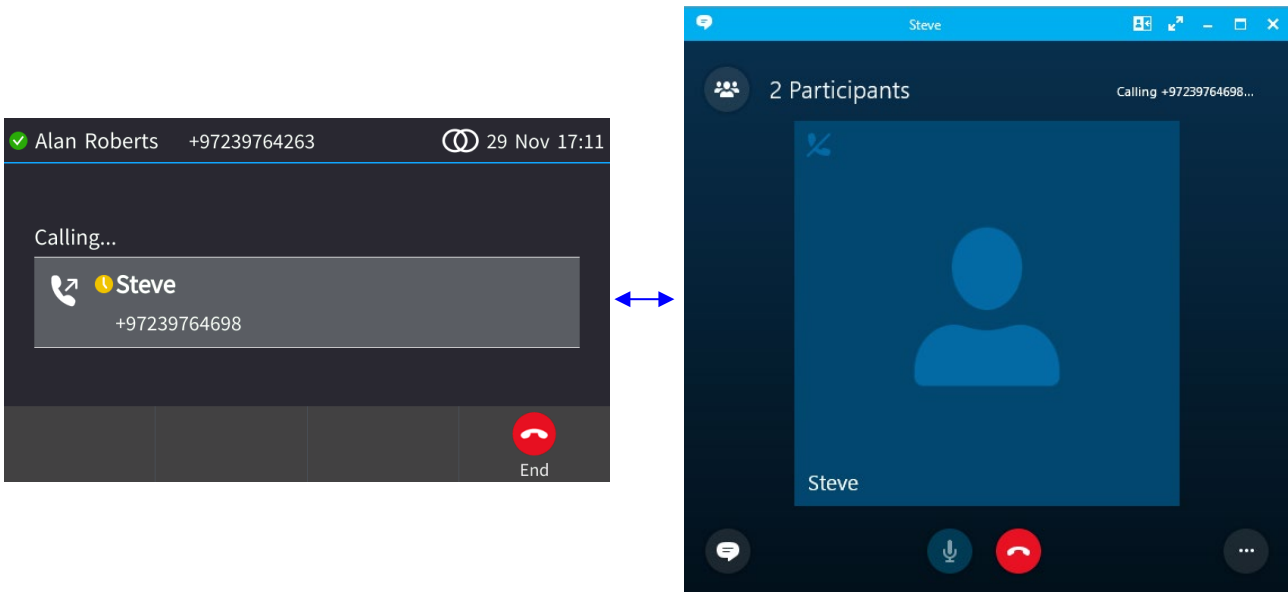

2. When the called party answers, you can use the phone or the client to talk, whichever is more convenient. When BToE is paired, you can use only the phone to talk; the client is used to control the call. To talk via the client, you need to switch the primary device. You can use the phone's speaker, handset or headphones.

7.17.3 Answering a Call

You can answer an incoming call with the phone or the Skype for Business client, whichever is more convenient at the time, for unified communications and optimized enterprise efficiency.

➤ **To answer a call on the phone:**

1. When the Incoming Call is displayed in the phone's user interface, touch the **Accept** softkey.
2. You can end the call by pressing the **End** softkey.



Note: If you answer an incoming *video call* with a paired phone, the call will be established but the default device will be the PC speaker/microphone, not the phone. Subsequent audio calls will be unaffected; the paired phone will be the default device.

7.17.4 Establishing a Unified Communications Call Conference

The phone supports multi-party Skype for Business remote conferencing. BToE is not mandatory for conferencing. See Section 7.10 for more information about conferencing. BToE is mandatory for *unified communications conferencing*. When BToE is installed, the phone mirrors the PC Skype for Business client; conferencing in the phone's screen mirrors conferencing in the client.

The example below shows how BToE integrates the phone with the PC Skype for Business client for unified communications call conferencing.

- In the client, Alan calls Steve.

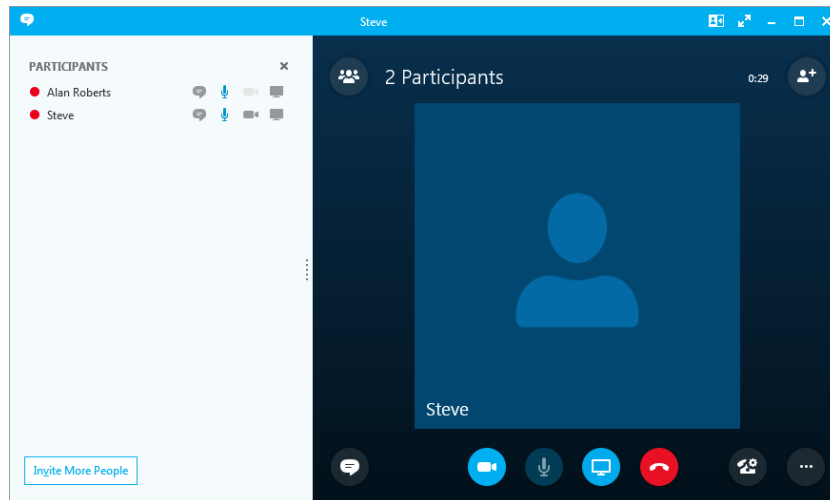

- Steve answers his phone.
- In his client, Alan clicks **Invite More People** and dials Hilary, who answers.

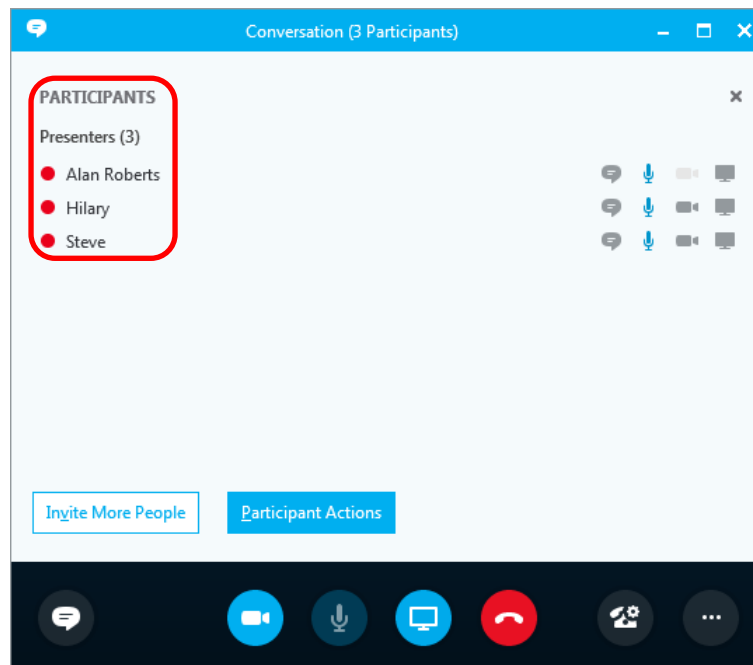

- Hilary sees that the call is a conference call initiated by Alan and that Steve was invited:

**Note:**

- After making a call in the client, you can invite an unlimited number of other participants.
- You can use the phone's speaker, handset or headphones to continue the meeting.
- When a user whose phone is connected to BToE joins a meeting, their phone is muted and the red **MUTE** button is lit. The user can unmute using the phone's **MUTE** button.
- You can touch the phone's **End** softkey to end a meeting.

See Section [7.10](#) for more information about conferencing.

7.17.5 Transferring a Call

You can transfer a call to another party either from your PC Skype for Business client or phone, whichever is more convenient for you at the time, for an enhanced unified communications experience.

➤ **To transfer a call:**

1. From your PC Skype for Business client or phone, whichever is more convenient, make a call; calling is indicated on both the PC Skype for Business client and the phone.
2. When the called party answers, you can perform a blind transfer or a consultative transfer, using your phone or your PC Skype for Business client, whichever you prefer.
 - For detailed information on performing call transfer with the phone, see Section 7.6.
 - For details on performing call transfer with the PC Skype for Business client, see Microsoft documentation. A guideline is shown below. The operation is mirrored in your phone. Note that a paired Skype for Business client can't perform consultation transfer.

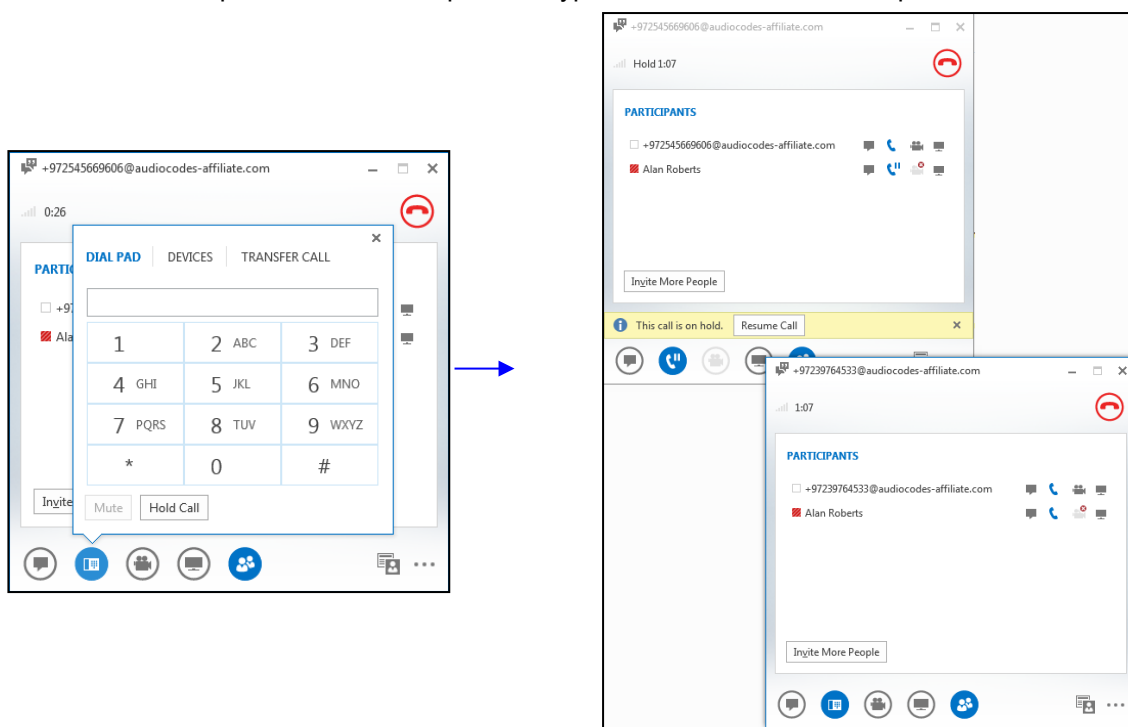

7.17.6 Switching the Primary Audio Device

BTtoE lets you switch primary audio device, so you can switch from listening to a Skype for Business conversation through the phone handset, for example, to listening on a headset, or from listening on a headset to listening through the phone speaker.

➤ **To determine which audio device is currently primary:**

- Locate in the lowermost left corner of the Skype for Business client screen the icon indicating 'Primary Device'.

Figure 7-27: Primary Device: Phone



Figure 7-28: Primary Device: Speaker

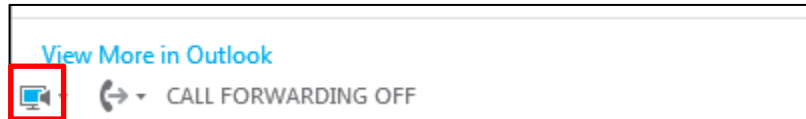
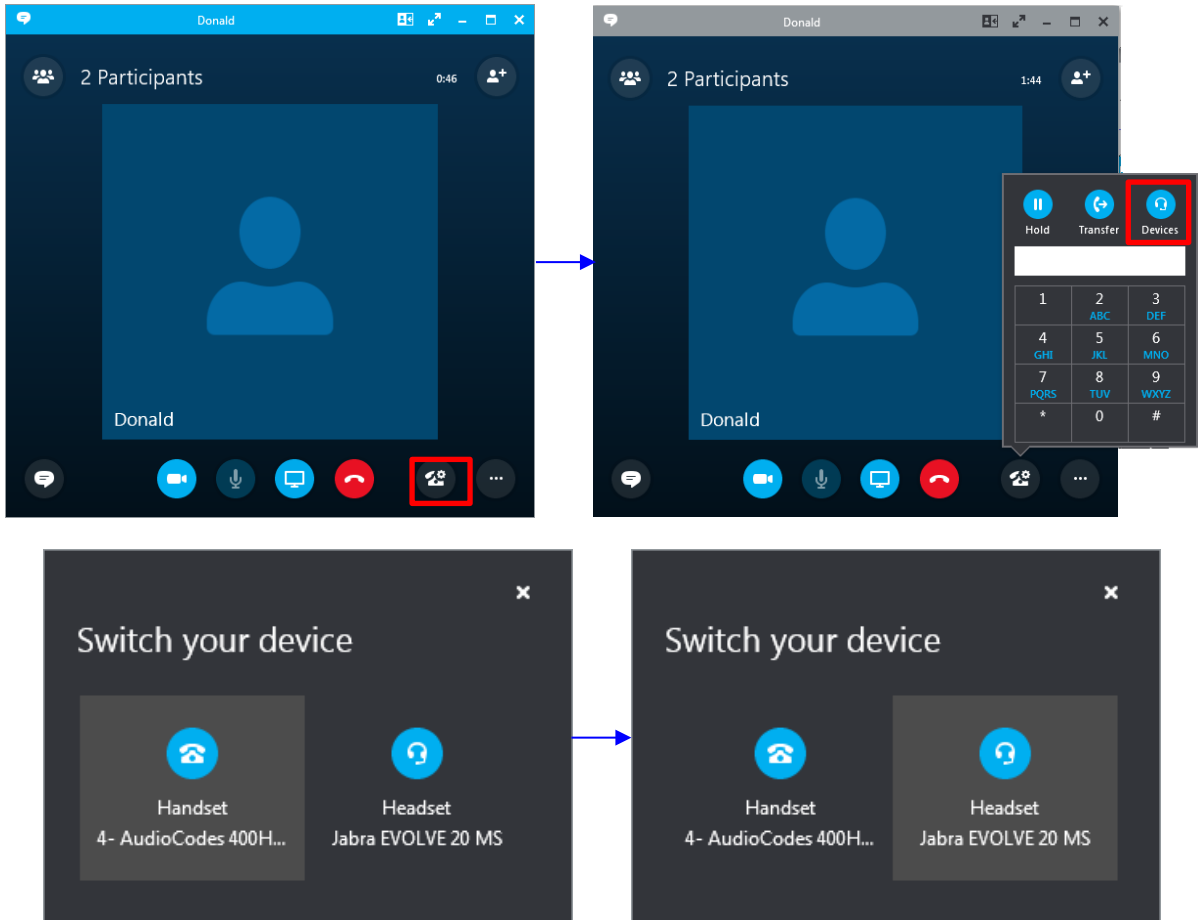

Figure 7-29: Primary Device: Headset



➤ **To switch primary device:**

- In a Skype for Business call, click the **Call Control** icon and select **Devices**.



7.17.7 Routing Voice from a Video Call to the Phone

When a video call comes in, video is displayed in the PC/laptop based Skype for Business client. The user can route the voice from the video call to the phone. In this scenario, the phone performs similarly to a USB device.

The example below illustrates how a user who's in a video call with another, routes voice to the phone.

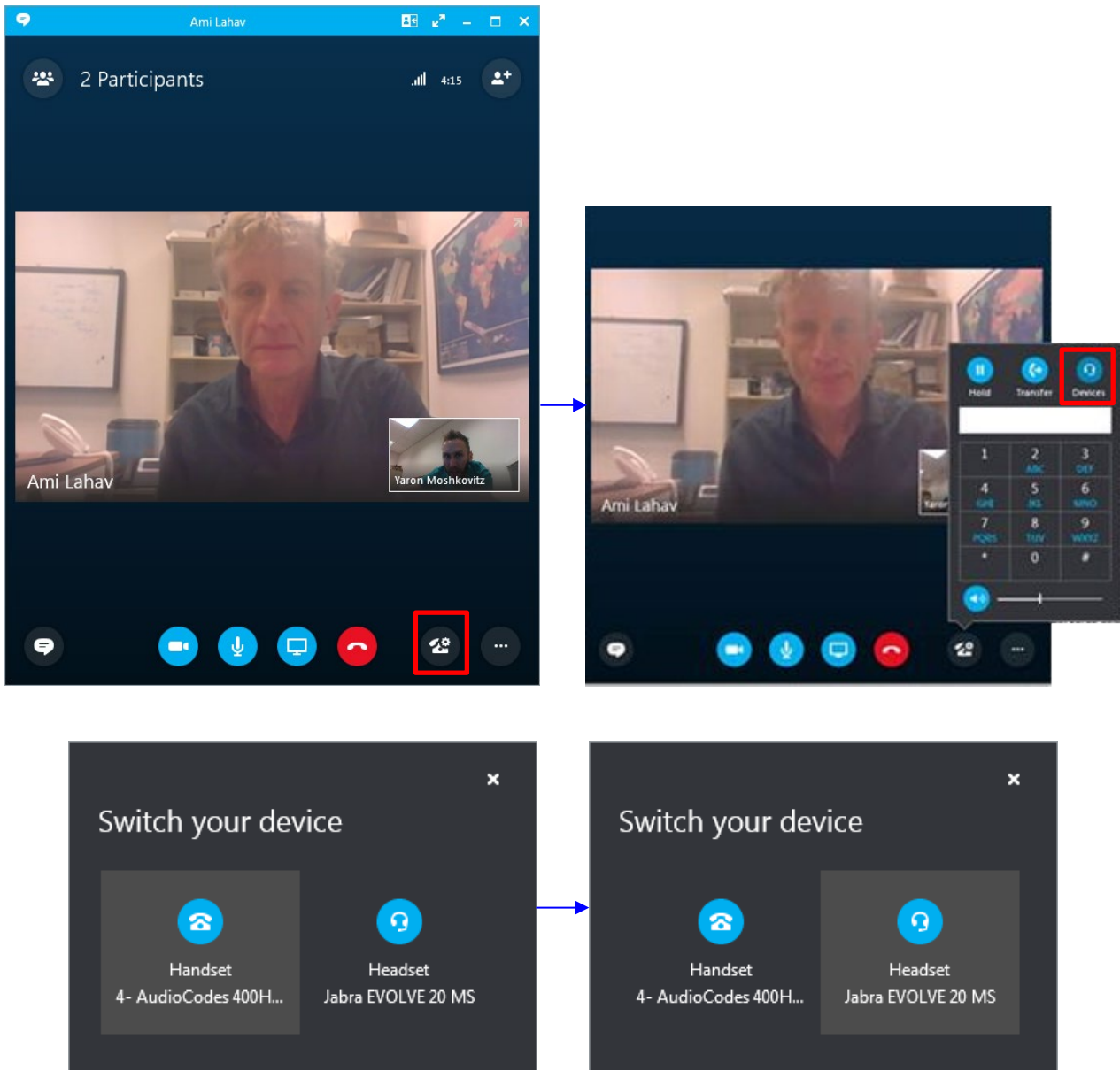

7.18 Using the Boss Admin Feature

This section shows how to use the Boss Admin feature. The feature allows a relationship to be established between a boss's phone and an administrative secretary's phone. The feature streamlines office workflow and enhances office efficiency.



Note:

- Boss Admin is by default disabled. The network administrator must enable it before the feature can function. For setup information, see the *Administrator's Manual*. After it is enabled, you will see the BToE icon displayed in the idle screen: 
- Each phone can support up to five Bosses or Admins.
- To remove an Admin, the Boss must remove the Admin in the Skype for Business client's 'Call Forwarding – Delegates' screen (click **Call Forward Settings** > click **Edit my delegate members** > select the Admin > click **Remove**). It's not enough to turn off call forwarding.



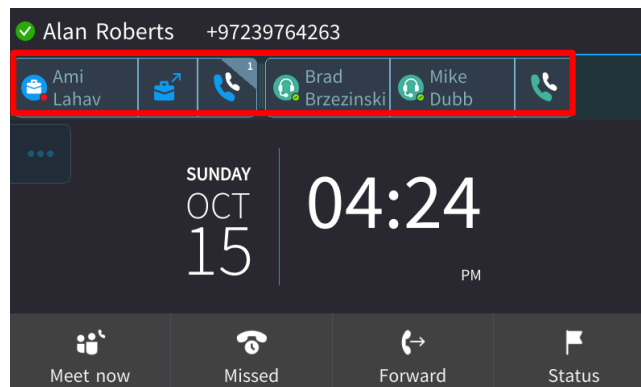

7.18.1 Viewing Admins and Bosses

After Admins and Bosses are configured, Admins can view on the phone's idle screen which Boss/es configured them as Admins. This can be useful for an administrative secretary replacing another during a lunch break for example.



Use the following table as reference to the Boss-Admin icons.

Table 7-2: Boss-Admin Icons

Boss-Admin Icons	Description
	Boss is [L-R] Online Offline Busy Away Do not Disturb
	Allows Admin to view Boss' calls.
	Admin is [L-R] Online Offline Busy Away Do not Disturb
	Allows Boss to view calls answered by Admins
	Allows Admin to call on behalf of Boss

You can *be* a Boss and you can *have* a Boss. You can be an Admin in charge of the other Admins in the office, i.e., you can be their Boss, but you can also report to a Boss above you. You can therefore have Bosses *and* Admins displayed.

7.18.2 Handling an Incoming Call for the Boss

Admin can handle an incoming call for the Boss.

➤ **To handle an incoming call for the Boss:**

1. If a call from **Hilary** for example comes in on the phone of the Boss (**Mike Dubb**), the phone of the Admin (**Alan Roberts**, shown below) rings simultaneously:

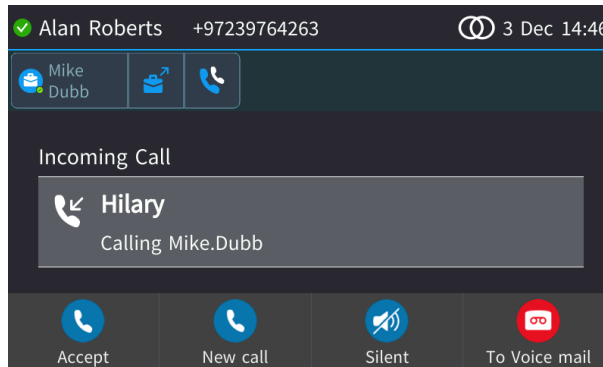

2. Admin can touch the **Accept** softkey or lift the handset to take the call. On the Boss' phone, a notification is displayed indicating the call was answered by Admin.

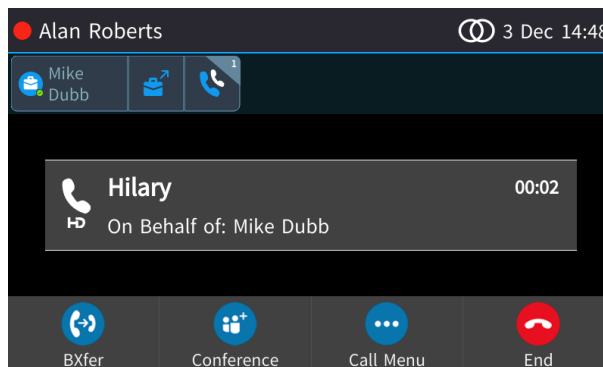

3. Admin can touch the **Call Menu** softkey and from the Call Menu screen that opens, select the **Handoff** option; the call is transferred to the Boss.

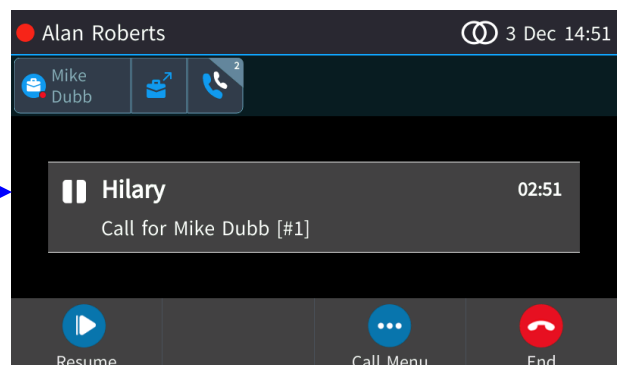
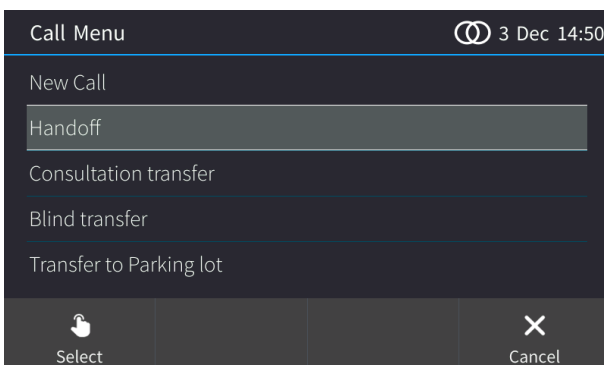

4. When the Boss answers, a notification is displayed on Admin's phone indicating the the call was answered by Boss (similar to the notification displayed on Boss' phone when a call is answered by Admin).

7.18.3 Calling on Behalf of the Boss

Admin can make a call on behalf of Boss by

- touching the  icon in the idle screen (see Section 7.15.3.1)
- keying the digits of the destination number (see Section 7.15.3.2)
- pressing the CONTACTS key on the phone (see Section 7.15.3.3)

7.18.3.1 Touching the Boss' icon

Admin can call on behalf of Boss by touching the Boss'  icon in the Admin phone's idle screen.

➤ **To make a call on behalf of Boss:**

1. In the Admin phone's idle screen, touch the  icon of Boss (**Mike Dubb** in the example below).

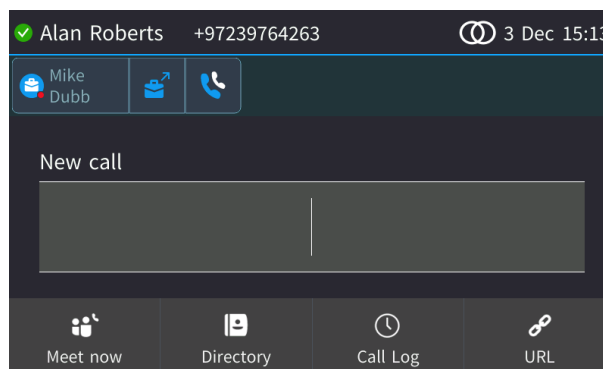

2. Enter the number of the destination to call (**Hilary** in the example below) and touch the enabled **OnBehalf** softkey; the number is dialed; Hilary's end rings.

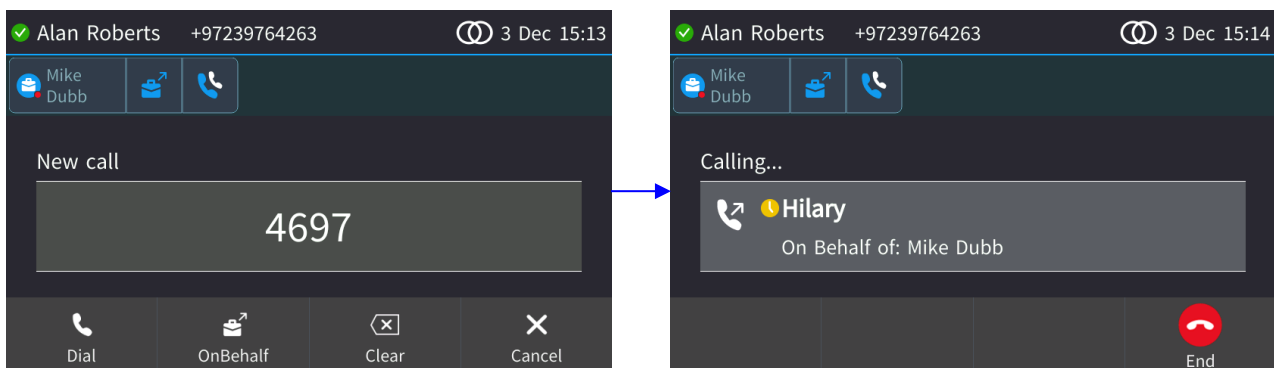

3. Hilary views an incoming call from Admin (**Alan**) on behalf of Boss (**Mike**) on her phone.
4. Hilary answers; Hilary's phone displays 'Alan Roberts on Behalf of Mike Dubb'.

7.18.3.2 Keying in the Destination Phone Number

You can call on behalf of Boss by pressing the digit keys of the destination phone number.

➤ **To make a call on behalf of Boss:**

1. On the phone's dial pad, press the first digit key of the destination number; the NEW CALL screen opens displaying the **OnBehalf** softkey:

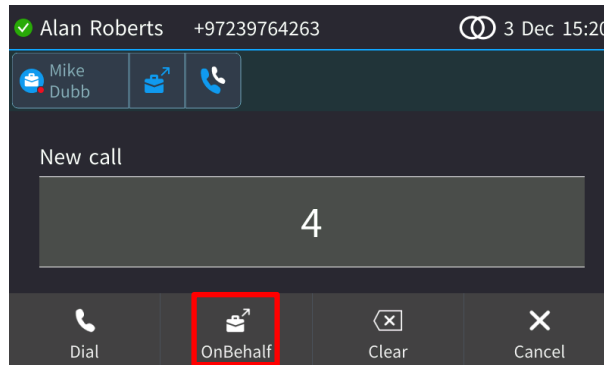

2. Enter the rest of the destination number and then press the **OnBehalf** softkey; the Bosses List screen opens:

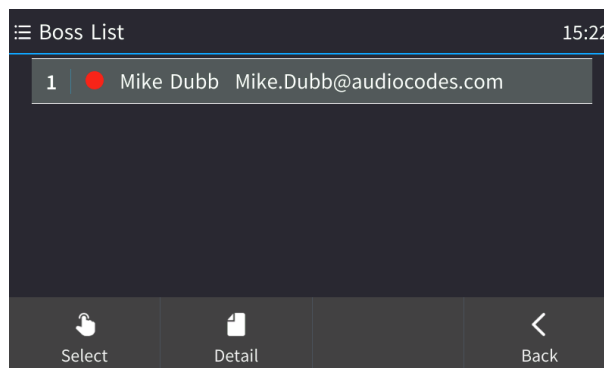

3. Navigate to the Boss on behalf of whom to call (the screen above shows only one configured Boss, **Mike Dubb**, as an example), and then touch the **Select** softkey; the phone of the called party shows an INCOMING CALL on behalf of **Mike Dubb** (the Boss).

7.18.3.3 Pressing the CONTACTS Key

You can make a call on behalf of Boss by pressing the CONTACTS hard key on the phone.

➤ **To call on behalf of Boss by pressing the CONTACTS key:**

1. Press the CONTACTS hard key on the phone and then in the Favorites screen that opens, touch the **Groups** softkey.

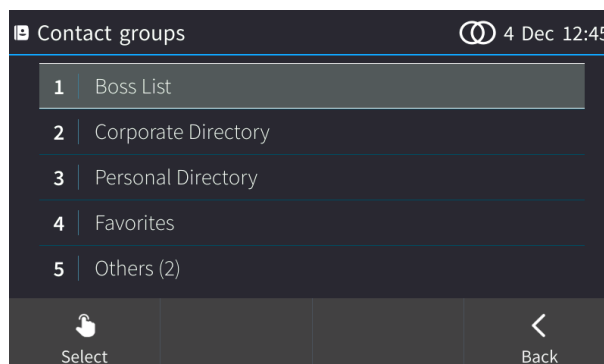

2. Select the **Bosses List** option.

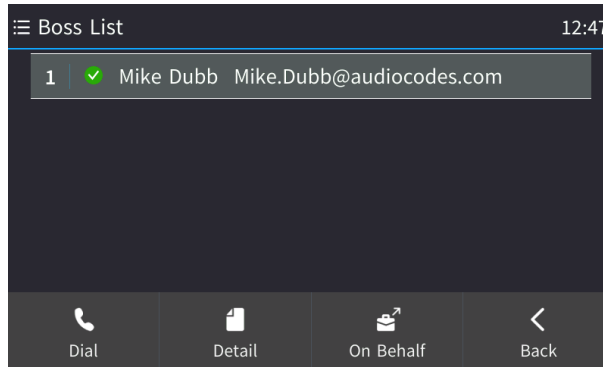

3. Select the Boss on whose behalf you want to call (the screen above shows only one configured Boss, **Mike Dubb**, as an example).
4. Touch the **OnBehalf** softkey and then dial the required number.

7.18.4 Answering a Call on Boss' Phone

When a call comes in for Boss, Boss' phone and Admin's phone ring simultaneously. Boss can answer the call independently of Admin.

➤ **To answer a call on Boss' phone:**

1. When Boss' phone rings, Boss (**Alan Roberts**, in the example below) sees 'Incoming Call' from **Donald** (in the example below). Boss also sees that his delegates (Admins) are ringed.

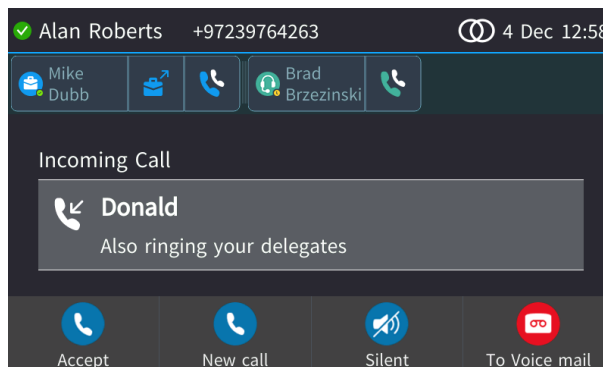

2. If Boss answers the call, a notification is displayed on Admin's phone indicating the call was answered by Boss.

7.18.5 Admin Hands Off a Call to Boss

When in a call on Boss' behalf, Admin can hand the call off to Boss. Boss' phone rings and Admin is disconnected. This is similar to Blind Transfer (see Section 7.7.1) except that Boss is always the party to whom the call is transferred.

➤ **To hand off a call to Boss:**

- If you the Admin (**Alan Roberts** in the example below) are in a call with caller **Hilary** on behalf of Boss **Mike Dubb**, touch the **Call Menu** softkey and then in the Call Menu scroll to and select the **Handoff** option; the call with caller Hilary is handed off to Boss **Mike Dubb**.

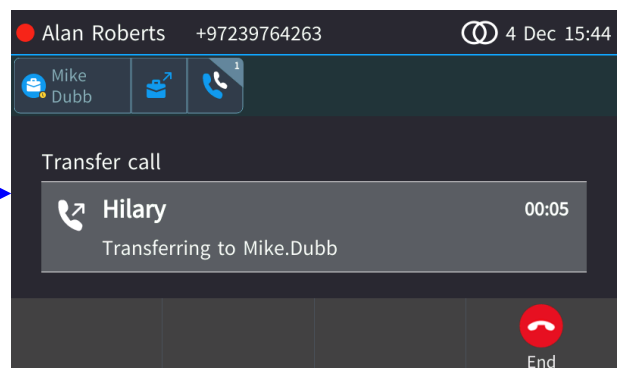
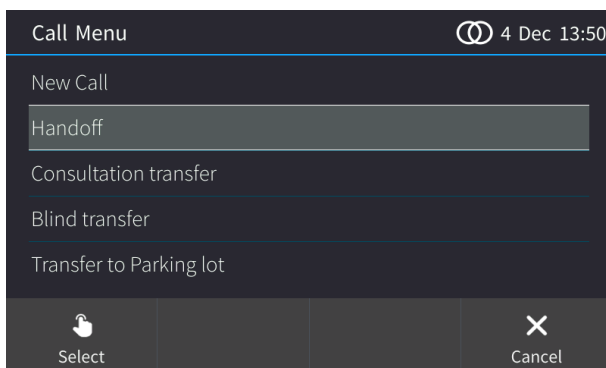
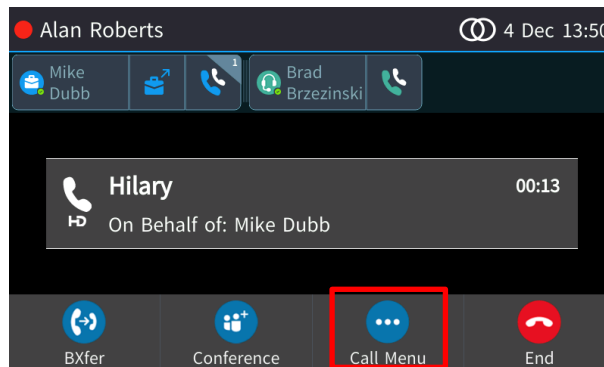

7.18.6 Boss Hands Off a Call to Admin

When in a call, Boss can hand off the call to Admin. This is similar to Blind Transfer (see Section 7.7.1) only Admin is always the party to whom the call is transferred. Admin's phone rings and Boss is disconnected.

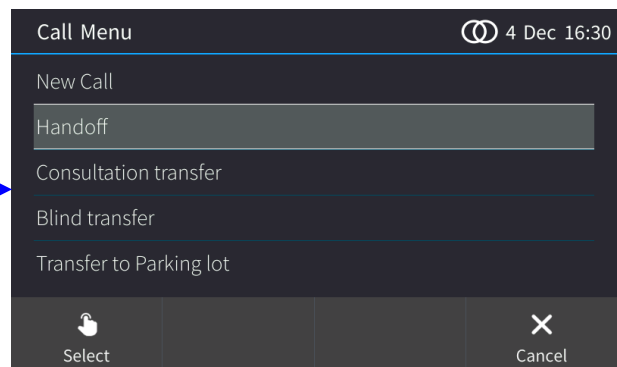
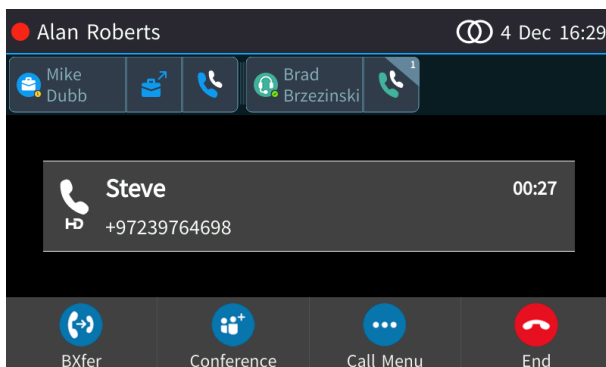

➤ **To hand off a call to Admin:**

- When Boss (**Alan Roberts** , in the example below) is in a call with **Steve**, Boss touches the **Call Menu** softkey and selects the **Handoff** option to hand off **Steve** to his Admin **Brad Brzezinski**.

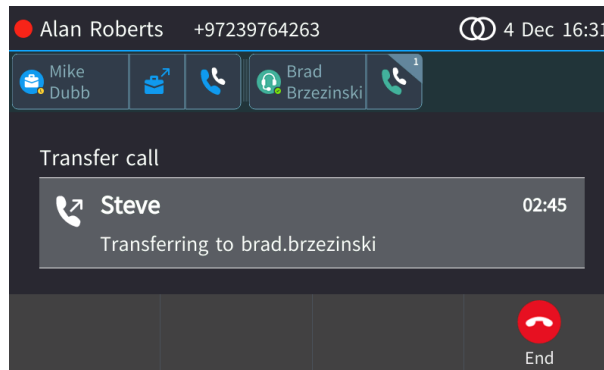



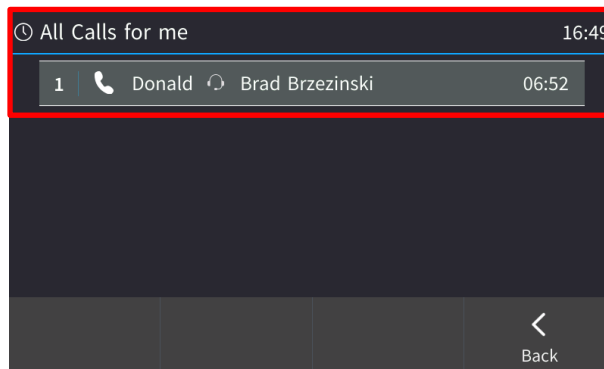
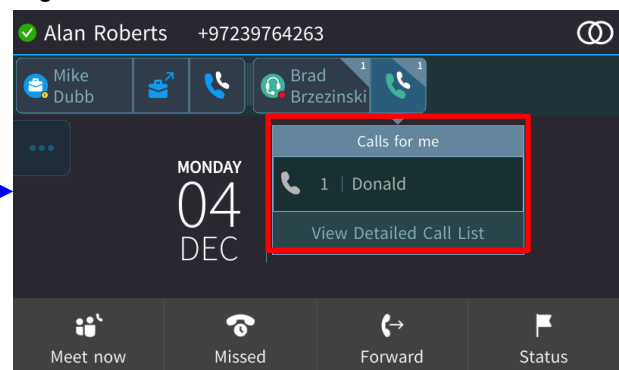
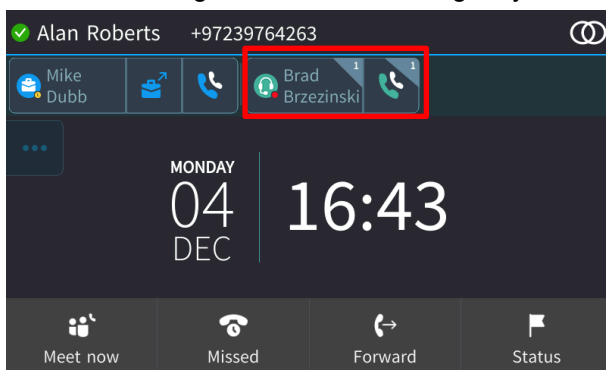

7.18.7 Boss Monitors Admins, Seizes a Call Put on Hold by an Admin

Boss can monitor Admin when Admin is in a call on Boss' behalf. If Admin's icon on Boss' phone is , it indicates to Boss that Admin is in a call. Boss can touch the  icon to see who Admin is talking with and for how long they've been talking.



In the example above, Boss (**Alan Roberts**) determines that his Admin (**Brad Brzezinski**) answered a call on his behalf from Donald and that they've been talking for 6 minutes 52 seconds.

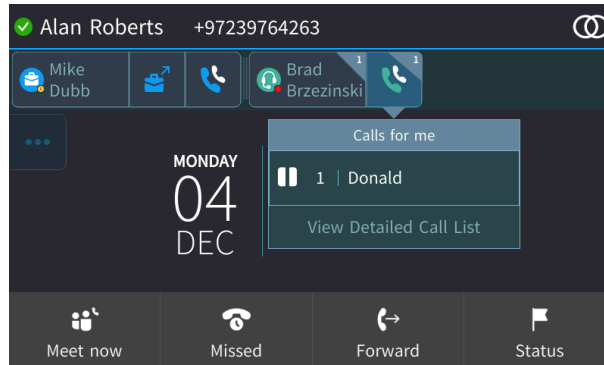

In the example below, Boss (**Alan Roberts**) touches the  icon of his Admin (**Brad Brzezinsky**) and determines from the icon  that Admin has put the call with Donald on hold.



Boss (**Alan Roberts**) touches  Donald to pick up the call from Admin (**Brad Brzezinsky**).

7.18.8 Admin Sees Who's Call Boss Answered

Admin (**Alan Roberts**) can see who's phone call Boss (**Baruch Gelber**) answered.

- A call comes in.
- Admin determines that Boss answered because Admin didn't and Boss' icon on Admin's screen changed from  to .

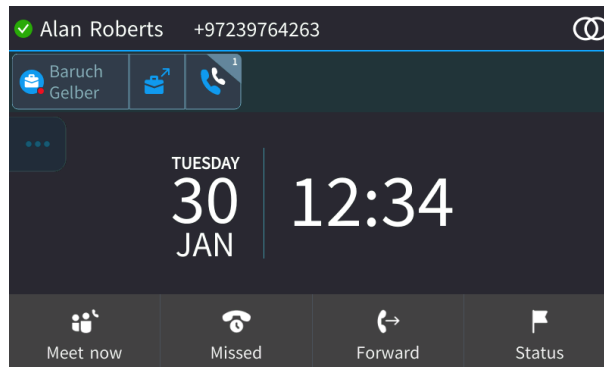

- Admin touches the Boss icon to see who Boss is in the call with.

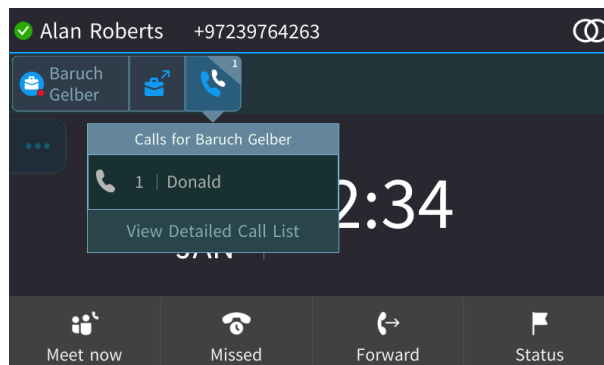

- Admin touches **View Detailed Call List** to see how long they've been speaking.

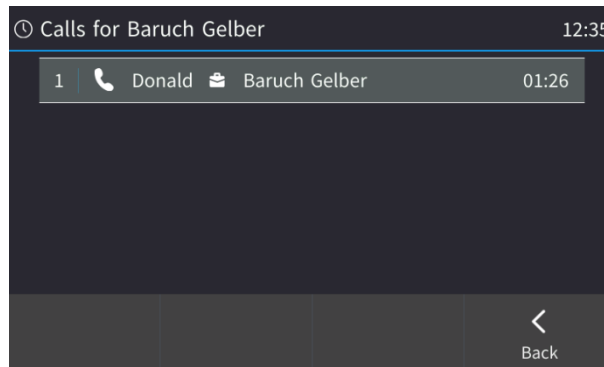

7.18.9 Admin Picks up a Call Answered by Boss, Put on Hold by Boss

If Boss answers an incoming call and puts it on hold, Admin sees

- that Boss answered
- who Boss is talking with and how long they've been talking
- that Boss has put the call on hold if Boss puts it on hold

If Boss puts the call on hold, Admin will see the  icon next to the callers name. Admin can touch the icon to pick up the call.

7.18.10 Admin 1 Picks up a Call from Admin 2

Admin 1 can pick up a call from Admin 2:

- Admin 2 answers an incoming call for Boss (Mike Dubb).
- Admin 1 sees the call was answered and touches Boss'  icon:

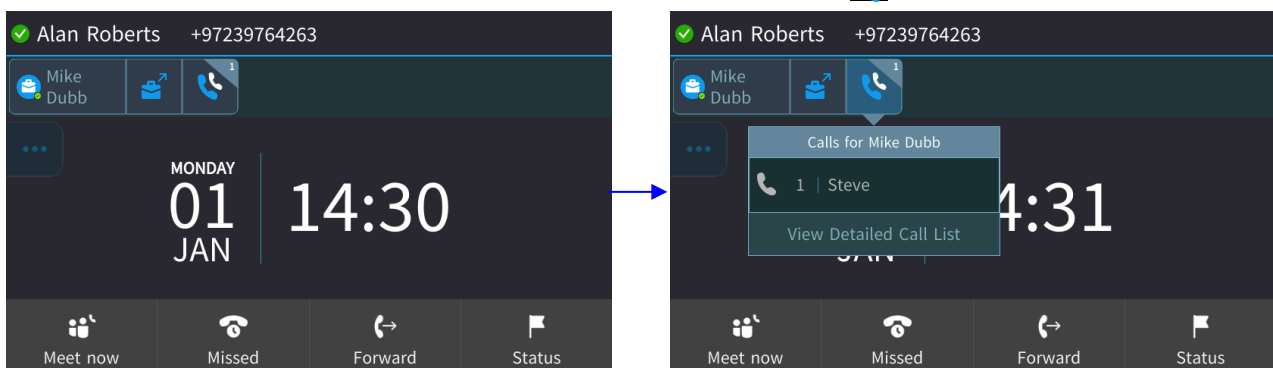

- Admin 1 sees that the call was from **Steve** and touches **View Detailed Calls List**

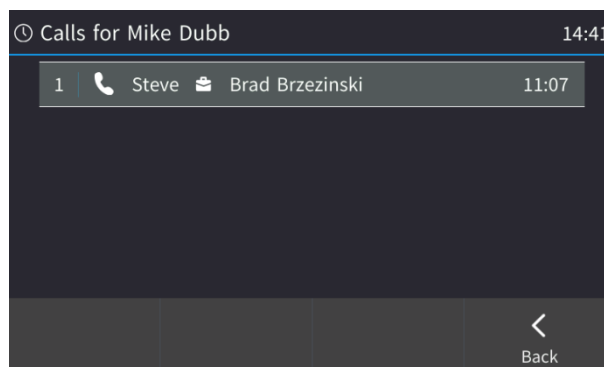

- Admin 1 sees that Admin 2 (Brad Brzezinski) answered Steve's call
- If Admin 2 puts the caller on hold, the **Pick up** softkey is displayed in Admin 1's screen
- Admin 1 touches it to pick up the call from Admin 2

7.18.11 Admin's Phone Notifies Called Party that Admin's Call is on Behalf of Admin's Boss

Admin's phone notifies the called party that Admin is calling on behalf of Admin's Boss. This function applies to external called parties as well.

7.18.12 Admin Calling Boss

Admin can call Boss by touching Boss's  icon in the idle screen.

7.18.13 Admin Calling Someone on Behalf of Boss

Admin can call someone *on behalf of* Boss.

➤ **To call on behalf of Boss:**

- Admin touches Boss's  icon in the idle screen, enters the number of the person to call in the 'New call' field, and then touches the **OnBehalf** softkey.

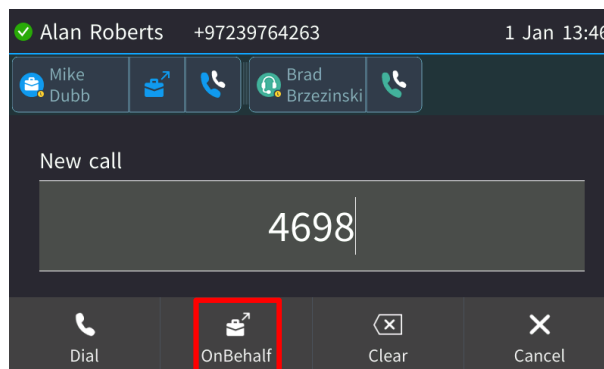

7.19 Configuring Distinctive Ringing on Admin's Phone

Admin can configure on Admin's phone a distinctive ring for each configured Boss. Distinctive ring tones allow Admin to audially distinguish between incoming calls for Bosses, optimizing Admin's work efficiency.

➤ **To configure distinctive ringing:**

1. On Admin's phone, open the Boss' Ring Tone screen (MENU > **Settings** > **Boss' Ring Tone** > **Boss ID** and then select the Boss from the list of Bosses; the figure below displays only one Boss).

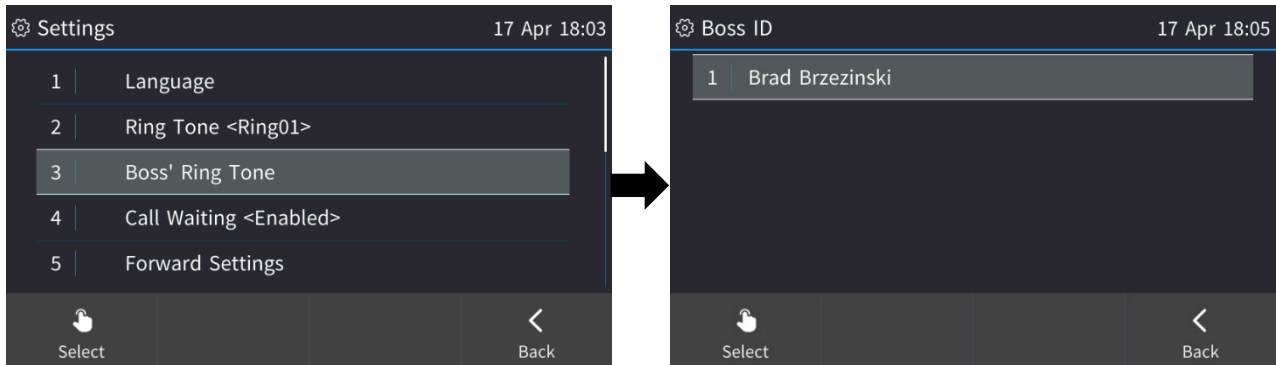

2. In the Ring Tone screen, navigate to the ring tone you want to be played when calls come in for the Boss you selected in the previous step. As you navigate down the list, the ring tone of each item plays.

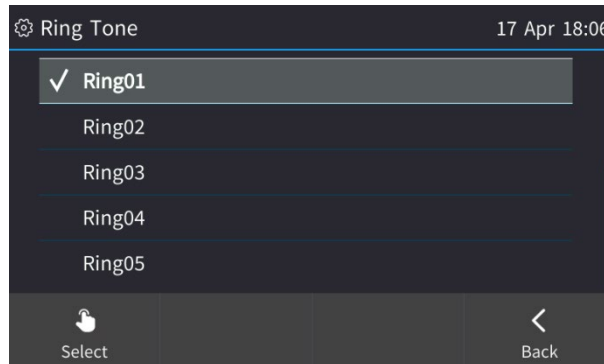

3. Save the configuration and then do the same for each of the other Bosses.

7.19.1 Setting a Different Volume for Each Boss's Ringtone

In addition to Admin's ability to configure a distinctive ring for each configured Boss, Admin can set the volume of each configured Boss's ringtone.

➤ **To set a Boss's volume:**

- After navigating in the Ring Tone screen to the ring tone you want to be played when calls come in for the Boss, press the VOL ▲ or VOL ▼ hard key on the phone until you hear the volume you require.

7.20 Viewing and Playing Voicemail Messages

New messages will be in your voicemail box if:

- The voicemail key on the phone is illuminated red.
- The Ring LED on the phone is illuminated blue (see [Figure 2-1](#), label 1)
- An envelope icon is displayed in the phone's screen.
- A stutter dial tone is heard when you pick up the handset.

➤ **To view a list of your voicemail messages:**

1. Press the voicemail key:

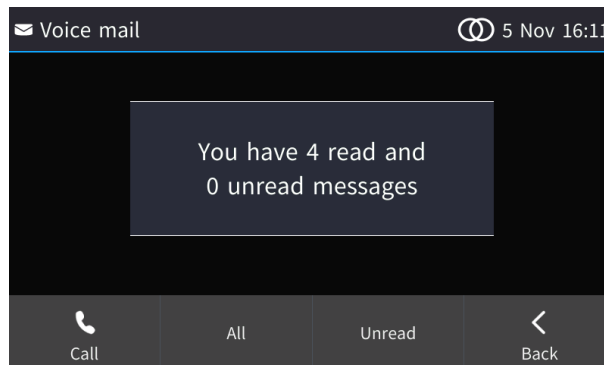

2. Touch the **Call** softkey and wait for the list to update.

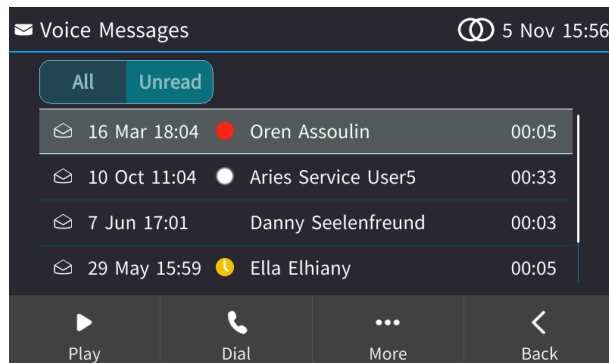

3. Scroll to select from the list which message to **Play**, **Call** or **Delete**.

Note:

For this feature to function:

- Your network administrator must enable private voicemail for you. You must sign in to the phone with your username and password. If you signed in with your PIN code, voicemail will be unavailable and you'll see the message **Your account is not configured for Exchange Unified Messaging**.
- Features like this, activated from Microsoft's Exchange Server, are only available after signing in to the phone with Username and Password.
- By default, the phone skips PIN code authentication and allows users direct access to voicemail. The network administrators can secure user access to voicemail with PIN code authentication so that when the user presses the voicemail key, they're prompted to enter their PIN code. See the *Administrator's Manual* for details.



When you have at least **one new message** in your voicemail box, you can listen to it.

7.20.1 Sending an Incoming Call Directly to Voicemail

You can send an incoming call directly to voicemail if time constraints (for example) prevent you from answering it.

➤ **To send an incoming call directly to voicemail:**

- Touch the **To Voice Mail** softkey displayed when the phone rings.

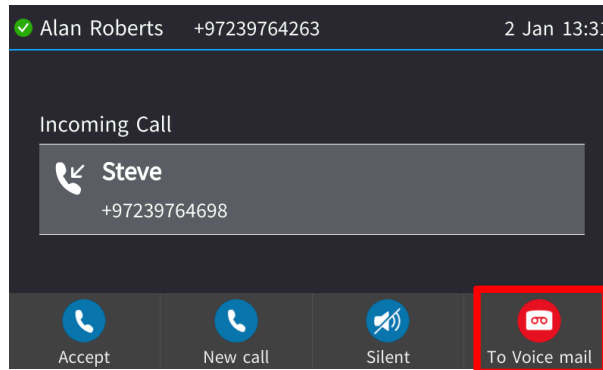

7.20.2 Calling a Contact's Voicemail Directly

You can directly call a contact's voicemail and leave a voice message in it, bypassing ringing. The feature can be used if you need to (for example):

- Communicate a message now because later you won't be able to - but the contact's presence status now indicates they're busy
- Be efficient with a quick, no-frills message rather than a prolonged call
- Prepare the contact for a conversation later
- Tell 'your side of the story' without interruption

➤ **To directly call a contact's voicemail:**

1. Open the Contact Details screen (CONTACTS > **Groups** > **Corporate Directory** > **T9** > navigate to the contact > **Details**).

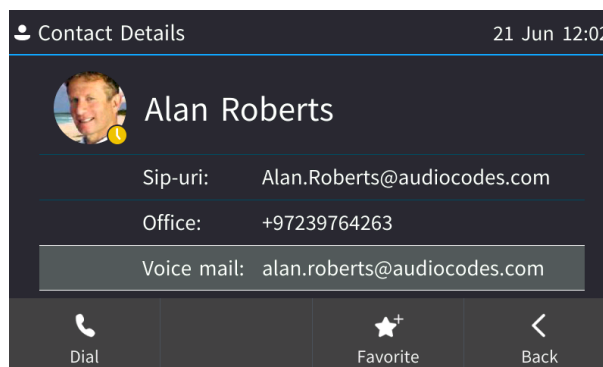

2. In the Contact Details screen, navigate to the **Voice mail** option and select **Dial**.



Note: The contact must have voicemail configured on their phone for this option to be displayed.

7.20.3 Sending an Existing Call to My Voicemail

You can send an existing call to your own voicemail if (for example) you do not have time right now to take down the other party's particulars.

➤ **To sending an existing call to My Voicemail:**

- When in the call, select the **Call Menu** softkey and in the Call Menu screen, navigate to and select the **Transfer to my Voice mail** option.

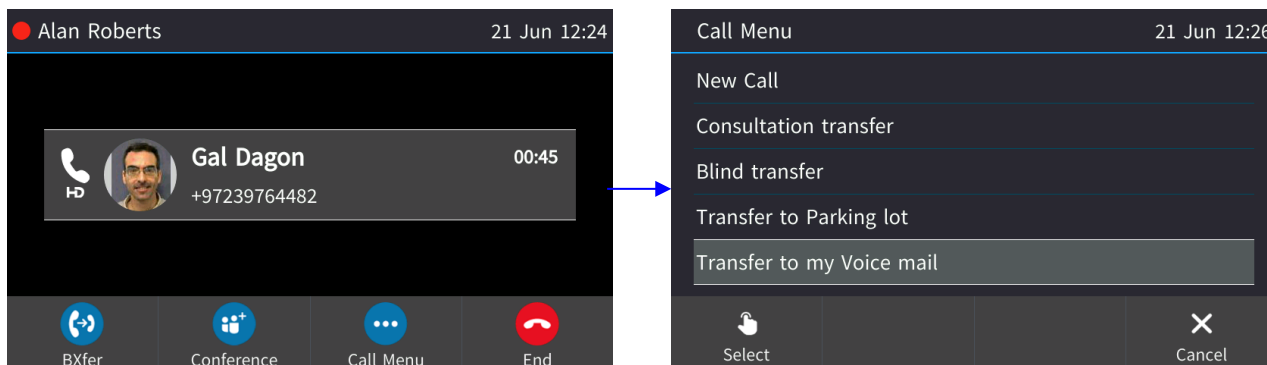

7.20.4 Sending an Existing Call with Contact X to the Voicemail of Contact Y

You can transfer an existing call with contact X to the voicemail of contact Y. The feature can be used if (for example) X's communication is related to Y but Y's presence status indicates they're busy right now.

➤ **To send an existing call with contact X to the voicemail of contact Y:**

1. When in the call with X, select the **BXfer** softkey then select **Directory**, navigate to Y and select **Details**.

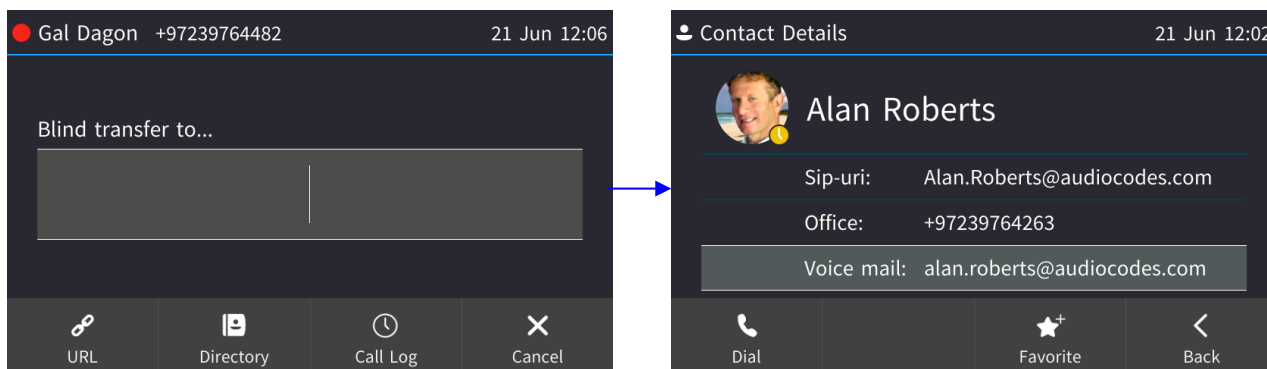

2. In the Contact Details screen of Y, navigate to **Voice mail** and then select **Dial**.

This page is intentionally left blank.

8 Troubleshooting

Read this section if a problem with a phone occurs. Contact your administrator if necessary.

Table 8-1: Troubleshooting

Symptom	Problem	Corrective Procedure
Phone is off (no touch screen displays and LEDs)	Phone is not receiving power	<ul style="list-style-type: none"> ▪ Make sure the AC/DC power adapter is attached firmly to the DC input on the rear of the phone. ▪ Make sure the AC/DC power adapter is plugged into the electrical outlet. ▪ Make sure the electrical outlet is functional. ▪ If using Power over Ethernet (PoE), contact your network administrator to check that the switch is powering the phone.
'LAN Link Failure' message displayed in the touch screen	No LAN connection	<ul style="list-style-type: none"> ▪ Make sure the LAN cable is connected securely to the LAN port on the rear of the phone. ▪ Make sure the other end of the LAN cable is connected to the network (switch). If it's not, inform your network administrator.
Phone is not ringing	Ring volume is set too low	<ul style="list-style-type: none"> ▪ Increase the volume (see Section 5.13.1)
Touch screen display is poor	Touch screen settings	<ul style="list-style-type: none"> ▪ Adjust the phone's screen brightness (see Section 5.8)
Headset has no audio	Headset not connected properly	<ul style="list-style-type: none"> ▪ Make sure your headset is securely plugged into the headset port located on the side of the phone. ▪ Make sure the headset volume level is adjusted adequately (see Section 5.13.5).
'Calendar is not available for PIN code login' message	Cannot access Microsoft Exchange Calendar	<ul style="list-style-type: none"> ▪ Log in again but do not log in using PIN code ▪ Log in using Username and Password (see Section 3.5.2 for more information)
 displayed in the idle screen	Can't connect to Exchange	<ul style="list-style-type: none"> ▪ Change the username format from audiocodes/someone to someone@audiocodes.com to sign in to the phone.

8.1 Uploading Logs to Microsoft Server for Support Purposes

An integrated log upload feature allows network administrators to upload logs from the phone to the Microsoft server for troubleshooting/support purposes. If a user experiences an irregularity such as poor voice quality, they'll contact an AudioCodes Field Application Engineer (FAE) who will instruct them to upload and send the logs for analysis. The FAE then downloads the logs to their PC, performs the analysis, and provides a fix.

➤ **To upload logs:**

- Press the MENU hard key, touch the **Settings** item and scroll down to select **Log upload**.

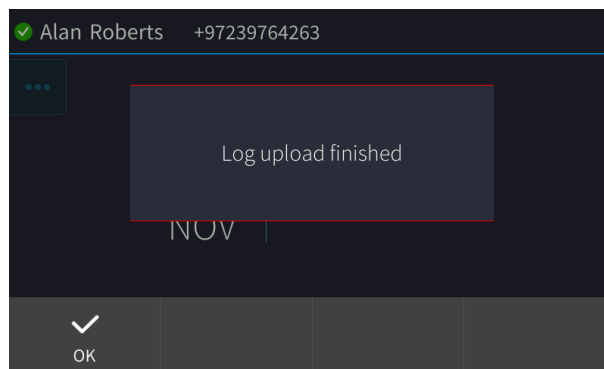
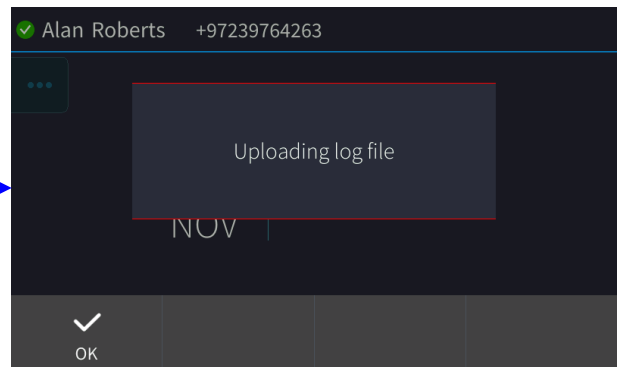
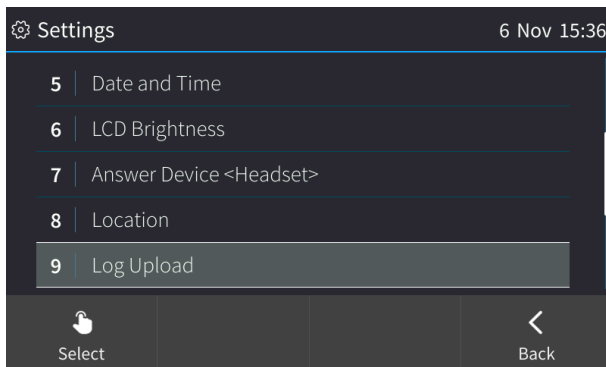

This page is intentionally left blank.

International Headquarters

1 Hayarden Street,
Airport City
Lod 7019900, Israel
Tel: +972-3-976-4000
Fax: +972-3-976-4040

AudioCodes Inc.

200 Cottontail Lane,
Suite A101E,
Somerset, NJ 08873
Tel: +1-732-469-0880
Fax: +1-732-469-2298

Contact us: <https://www.audiocodes.com/corporate/offices-worldwide>

Website: <https://www.audiocodes.com/>

©2020 AudioCodes Ltd. All rights reserved. AudioCodes, AC, HD VoIP, HD VoIP Sounds Better, IPmedia, Mediant, MediaPack, What's Inside Matters, OSN, SmartTAP, User Management Pack, VMAS, VoIPerfect, VoIPerfectHD, Your Gateway To VoIP, 3GX, VocaNom, AudioCodes One Voice and CloudBond are trademarks or registered trademarks of AudioCodes Limited. All other products or trademarks are property of their respective owners. Product specifications are subject to change without notice.

Document #: LTRT-13264

