

> TD2223/TD2423

Display User Guide

IMPORTANT: Please read this User Guide to obtain important information on installing and using your product in a safe manner, as well as registering your product for future service. Warranty information contained in this User Guide will describe your limited coverage from ViewSonic® Corporation, which is also found on our web site at <http://www.viewsonic.com> in English, or in specific languages using the Regional selection box in the upper right corner of our website. "Antes de operar su equipo lea cuidadosamente las instrucciones en este manual"

Model No. VS18311/VS18312
P/N: TD2223/TD2423

Thank you for choosing ViewSonic®

As a world-leading provider of visual solutions, ViewSonic® is dedicated to exceeding the world's expectations for technological evolution, innovation, and simplicity. At ViewSonic®, we believe that our products have the potential to make a positive impact in the world, and we are confident that the ViewSonic® product you have chosen will serve you well.

Once again, thank you for choosing ViewSonic®!

> Safety Precautions

Please read the following **Safety Precautions** before you start using the device.

- Keep this user guide in a safe place for later reference.
- Read all warnings and follow all instructions.
- Sit at least 18" (45 cm) away from the device.
- Allow at least 4" (10 cm) clearance around the device to ensure proper ventilation.
- Place the device in a well-ventilated area. Do not place anything on the device that prevents heat dissipation.
- Do not use the device near water. To reduce the risk of fire or electric shock, do not expose the device to moisture.
- Avoid exposing the device to direct sunlight or other sources of sustained heat.
- Do not install near any heat sources such as radiators, heat registers, stoves, or other devices (including amplifiers) that may increase the temperature of the device to dangerous levels.
- Use a soft, dry cloth to clean the external housing. For more information, refer to the "Maintenance" section.
- Oil may collect on the screen as you touch it. To clean the greasy spots on the screen, refer to the "Maintenance" section.
- Do not touch the screen surface with sharp or hard objects, as it may cause damage to the screen.
- When moving the device, be careful not to drop or bump the device on anything.
- Do not place the device on an uneven or unstable surface. The device may fall over resulting in an injury or a malfunction.
- Do not place any heavy objects on the device or connection cables.
- If smoke, an abnormal noise, or a strange odor is present, immediately turn the device off and call your dealer or ViewSonic®. It is dangerous to continue using the device.
- Do not attempt to circumvent the safety provisions of the polarized or grounding-type plug. A polarized plug has two blades with one wider than the other. A grounding-type plug has two blades and a third grounding prong. The wide blade and the third prong are provided for your safety. If the plug does not fit into your outlet, obtain an adapter and do not attempt to force the plug into the outlet.

- When connecting to a power outlet, DO NOT remove the grounding prong. Please ensure grounding prongs are NEVER REMOVED.
- Protect the power cord from being treaded upon or pinched, particularly at the plug, and at the point where it emerges from the equipment. Ensure that the power outlet is located near the equipment so that it is easily accessible.
- Only use attachments/accessories specified by the manufacturer.
- When a cart is used, use with caution when moving the cart/equipment combination to avoid injury from tipping over.
- Disconnect the power plug from the AC outlet if the device is not being used for a long period of time.
- Refer all servicing to qualified service personnel. Service will be required when the unit has been damaged in any way, such as:
 - » if the power supply cord or plug is damaged
 - » if liquid is spilled onto or objects fall in the unit
 - » if the unit is exposed to moisture
 - » if the unit does not operate normally or has been dropped
- NOTICE: LISTENING THROUGH EAR-/HEADPHONES AT A HIGH VOLUME FOR EXTENDED PERIODS CAN CAUSE HEARING DAMAGE/HEARING LOSS. When using ear-/headphones, adjust the volume to appropriate levels, or hearing damage may result.
- NOTICE: THE MONITOR MAY OVERHEAT AND SHUTDOWN! If the device shuts down automatically, please turn on your monitor again. After rebooting, change your monitor's resolution and refresh rate. For details, please refer to the graphics card's user guide.
- NOTICE: This product is not specifically designed for 24/7 usage in any environment.



> Contents

Safety Precautions	3
Introduction	7
Package Contents	7
Product Overview	8
Initial Setup	9
Installing the Stand	9
Wall Mounting.....	10
Using the Security Slot.....	11
Making Connections	12
Connecting to Power	12
Connecting External Devices	13
HDMI Connection.....	13
DVI Connection.....	14
VGA Connection	15
USB Connection.....	16
Touch Function Control.....	17
Touch Accuracy	18
Audio Connection.....	19
Using the Monitor	20
Adjusting the Viewing Angle.....	20
Tilt Angle Adjustment.....	20
Turning the Device On/Off	21
Using the Control Panel Keys.....	21
On-Screen Display (OSD) Menu	22
Hot Keys	23
Configuring the Settings	25
General Operations	25
On-Screen Display (OSD) Menu Tree	27

Appendix.....	30
Specifications.....	30
Glossary	33
Troubleshooting	38
Maintenance.....	40
General Precautions.....	40
Cleaning the Screen.....	40
Cleaning the Case	40
Regulatory and Service Information	41
Compliance Information.....	41
FCC Compliance Statement.....	41
Industry Canada Statement.....	41
CE Conformity for European Countries.....	41
Declaration of RoHS2 Compliance.....	42
Indian Restriction of Hazardous Substances	43
Product Disposal at End of Product Life	43
Copyright Information	44
Customer Service	45
Limited Warranty	46
Mexico Limited Warranty.....	49

> Introduction

Package Contents

- Touch Display
- Power cord
- HDMI cable
- USB 2.0 upstream cable (Type B to Type A)
- Quick start guide

NOTE: The power cord and video cables included in your package may vary depending on your country. Please contact your local reseller for more information.

Product Overview

Front View

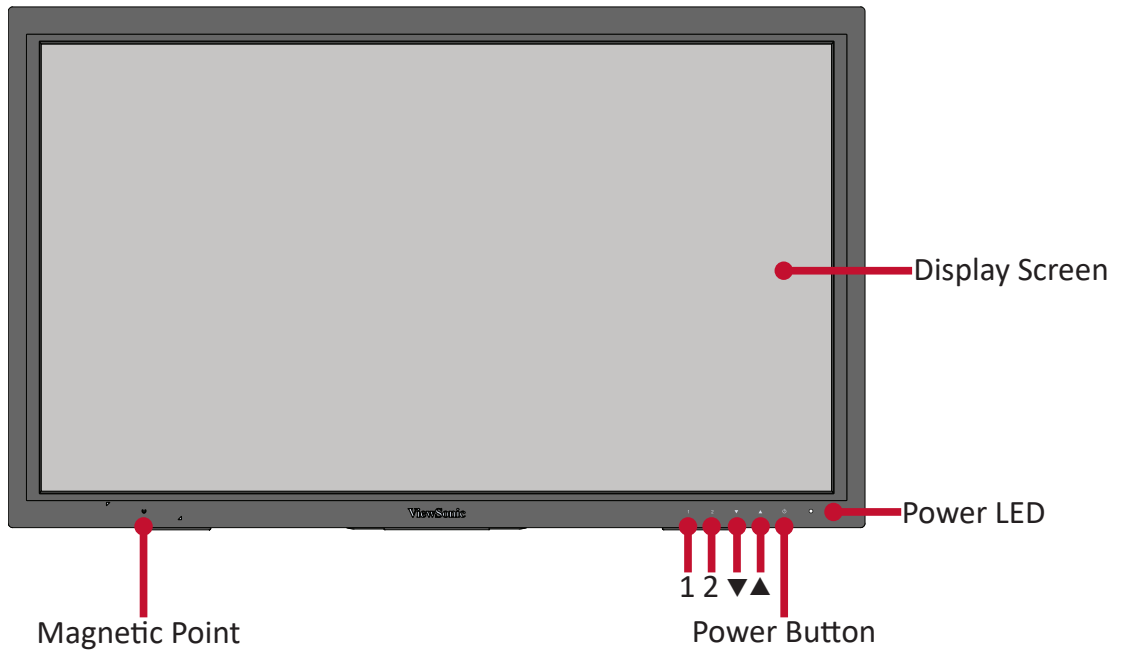

Rear View

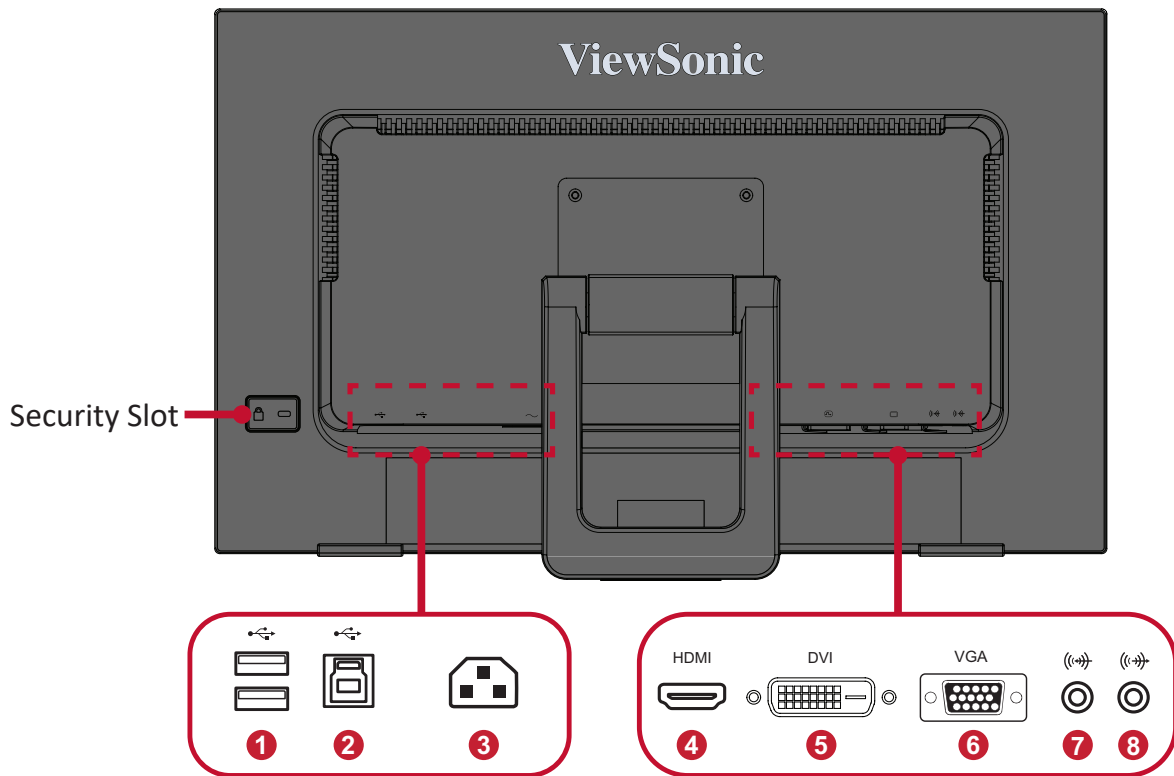

1. USB Downstream 2. USB Upstream 3. AC IN 4. HDMI 5. DVI
6. VGA 7. Audio In 8. Audio Out

NOTE: For more information about the **1/2/▲/▼** key and its functions, refer to “Hot Keys” on page 23.

> Initial Setup

This section provides detailed instructions for setting up your monitor.

Installing the Stand

1. Place the monitor on a flat, stable surface with the screen facing down.
2. With one hand applying downward pressure on the monitor, carefully lift and extend the stand.

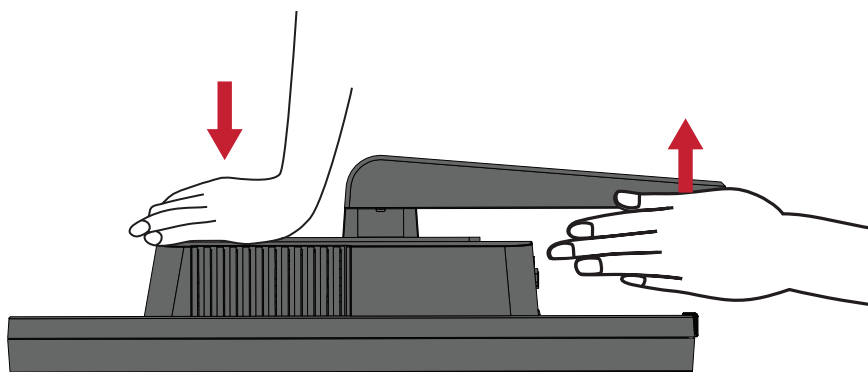

3. Lift the device into its upright position on a flat, stable surface.



NOTE: Always place the device on a flat, stable surface. Failure to do so may cause the device to fall and damage the device and/or result in personal injury.

Wall Mounting

Refer to the table below for the standard dimensions for wall mount kits.

NOTE: For use only with a UL certified wall mount kit/bracket. To obtain a wall-mounting kit or height adjustment base, contact ViewSonic® or your local dealer.

Maximum Loading	Hole pattern (W x H)	Interface Pad (W x H x D)	Pad Hole	Screw Specification & Quantity
14 kg	100 x 100 mm	115 x 115 x 2.6 mm	Ø 5 mm	M4 x 10 mm 4 pieces

NOTE: Wall mount kits are sold separately.

1. Turn off the device and disconnect all cables.
2. Place the device on a flat, stable surface with the screen facing down.
3. Unscrew the attached stand and carefully remove it.
4. Attach the mounting bracket to the VESA mounting holes at the rear of the monitor. Then secure it with four (4) screws (M4 x 10 mm).

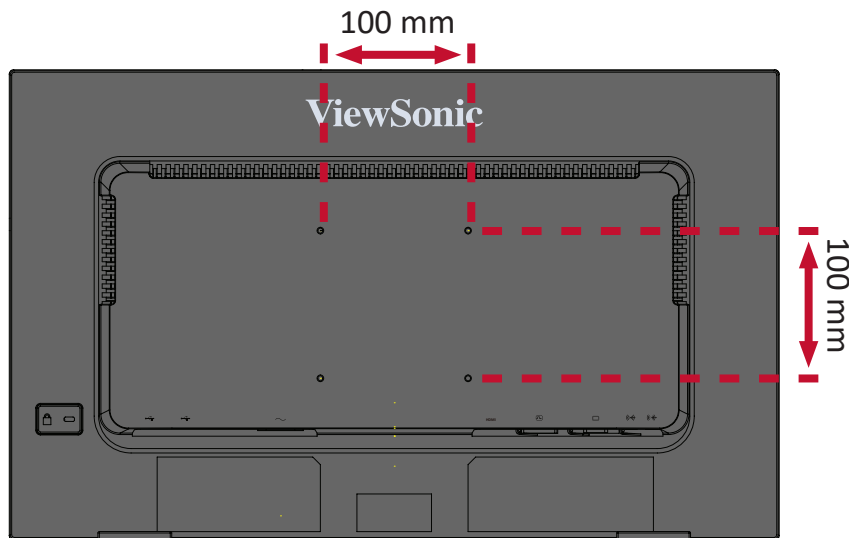

5. Follow the instructions that come with the wall mounting kit to mount the monitor onto the wall.

Using the Security Slot

To help prevent the device from being stolen, use a security slot locking device to secure the device to a fixed object.

Additionally, fastening the monitor to a wall or fixed object using a security cable can help support the weight of the monitor in order to prevent the monitor from falling over.

Below is an example of setting up a security slot locking device on a table.

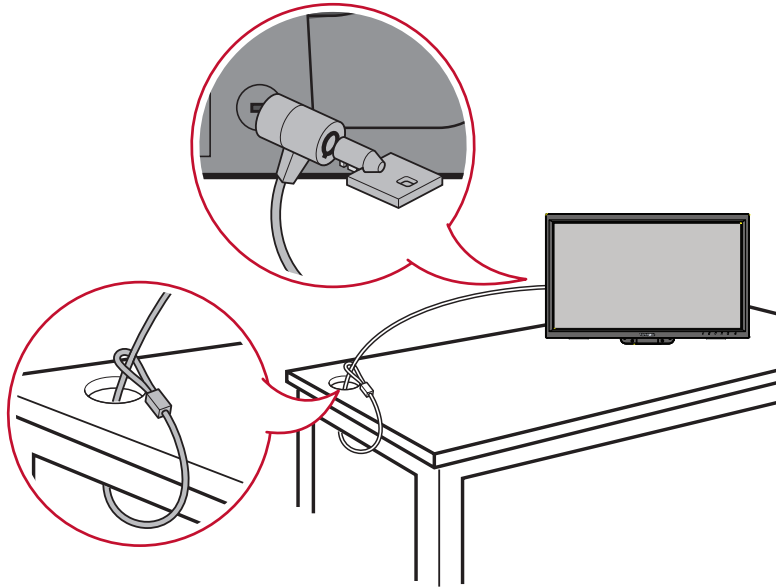

> Making Connections

This section guides you on how to connect the monitor with other equipment.

Connecting to Power

1. Connect the power cord to the AC IN jack at the rear of the device.
2. Connect the power cord plug to a power outlet.

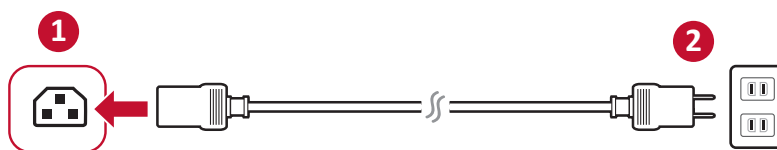
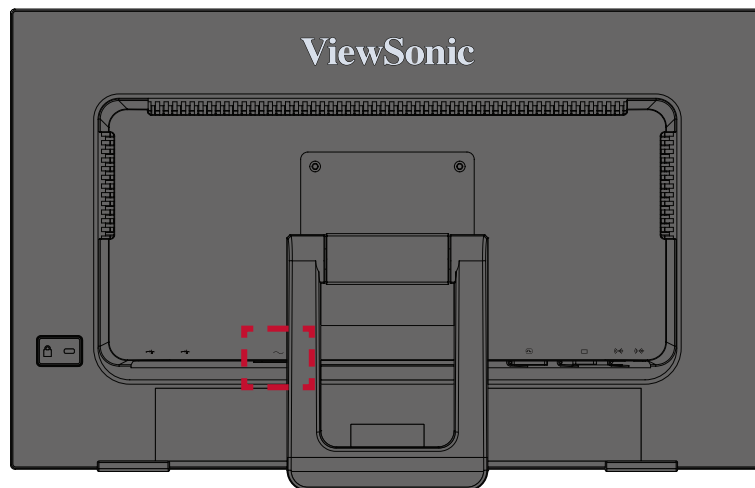

Connecting External Devices

HDMI Connection

Connect one end of an HDMI cable to the HDMI port of your monitor. Then connect the other end of the cable to the HDMI port of your computer.

NOTE: The monitor is equipped with one HDMI 1.4 port.

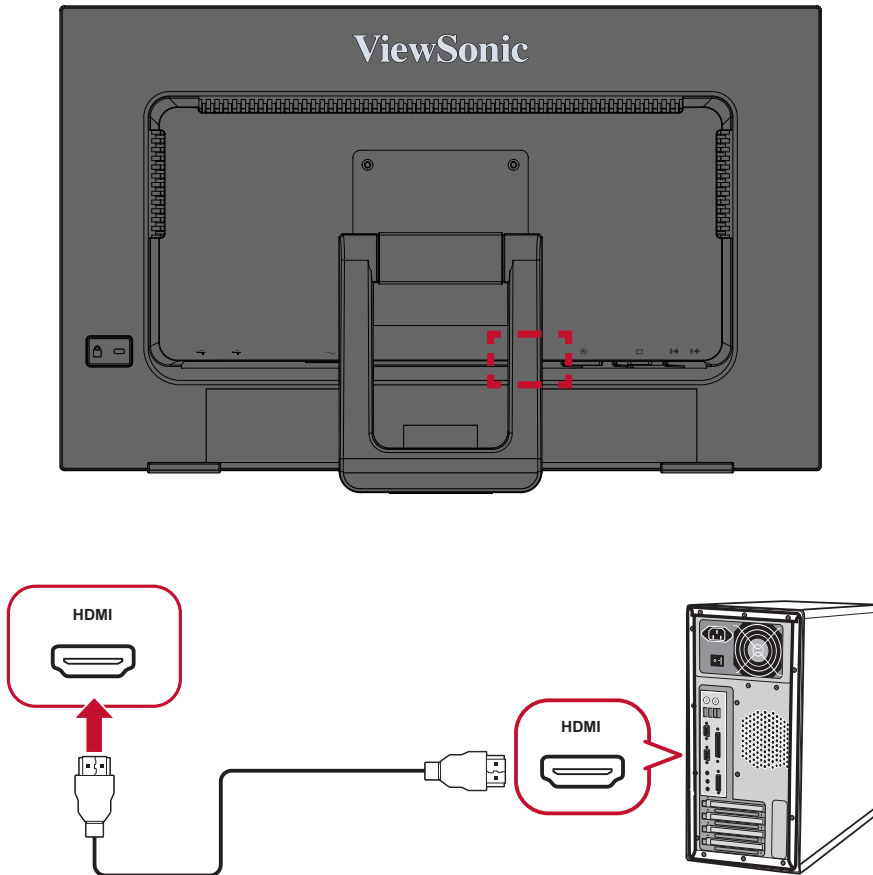

DVI Connection

Connect one end of a DVI cable to the DVI port. Then connect the other end of the cable to the DVI port of your computer.

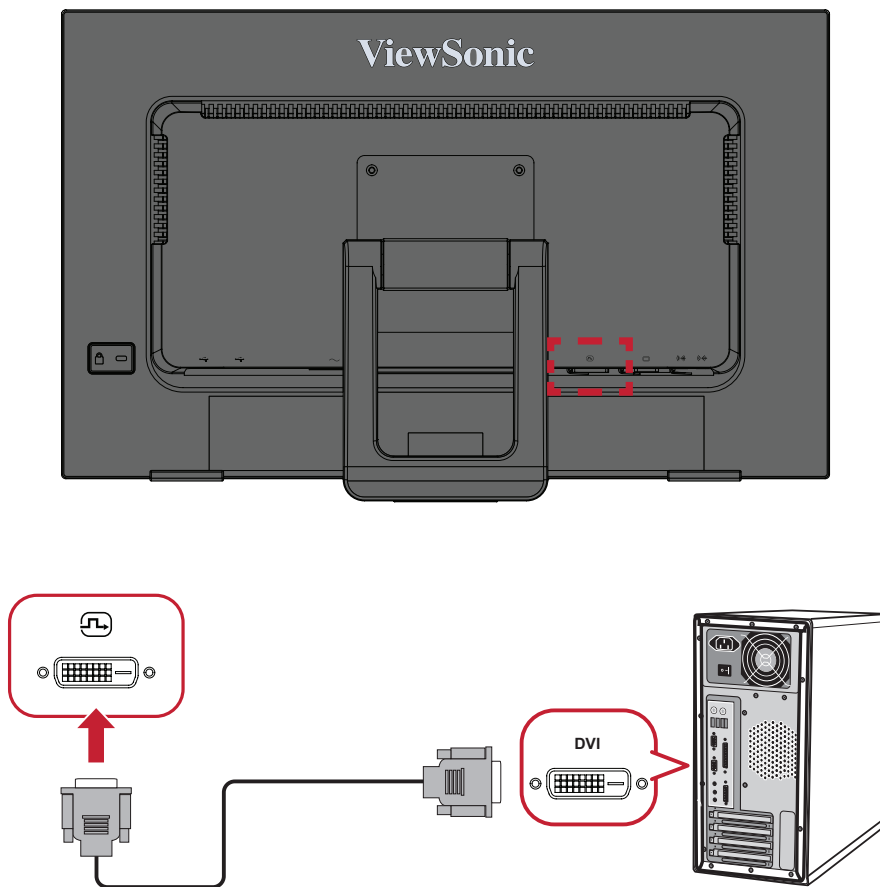

VGA Connection

Connect one end of a VGA cable to the VGA port. Then connect the other end of the cable to the VGA port of your computer.

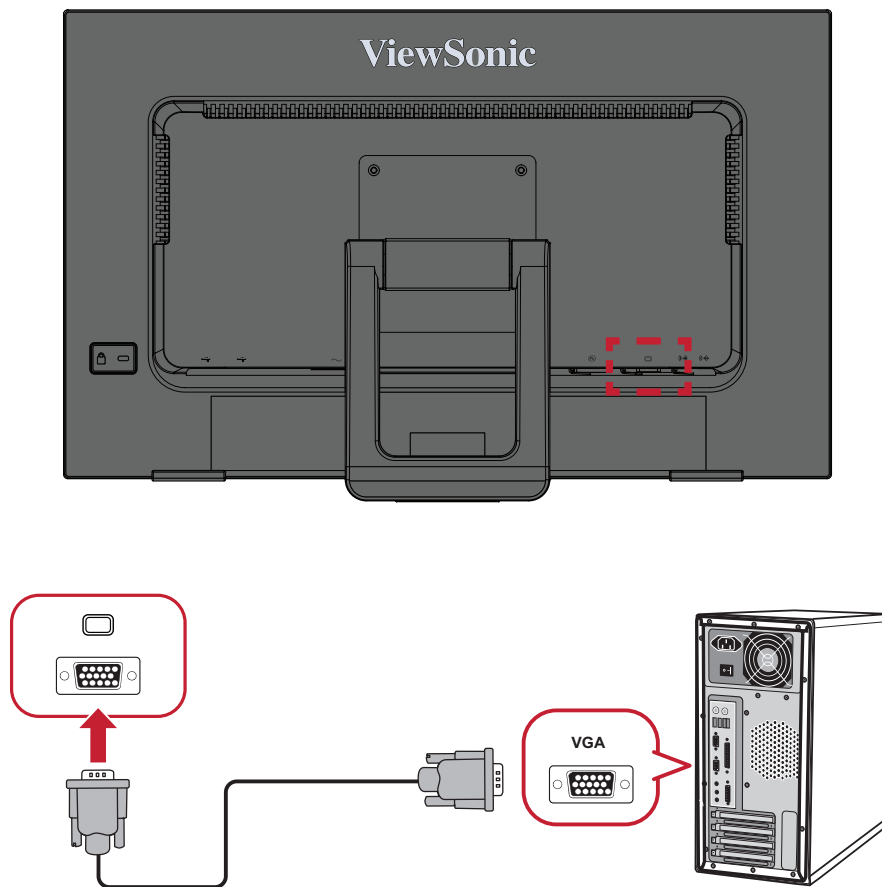

USB Connection

Connect one end of a USB cable to a USB port of the monitor. Then connect the other end of the cable to a USB port of your computer.

NOTE: The monitor supports two (2) types of USB ports. When making the connection(s), observe the following guidelines:

- Two (2) USB Type A ports: Connection for your Type A peripheral device(s). (i.e. storage device).
 - » **NOTE:** To activate the USB Type A port, ensure your computer is also connected to the monitor's USB Type B port.
- One (1) USB Type B port: Connect the USB Type B male cable (square with 2 cut corners) to this port, and then connect the other end of the cable to the USB downstream port of your computer.

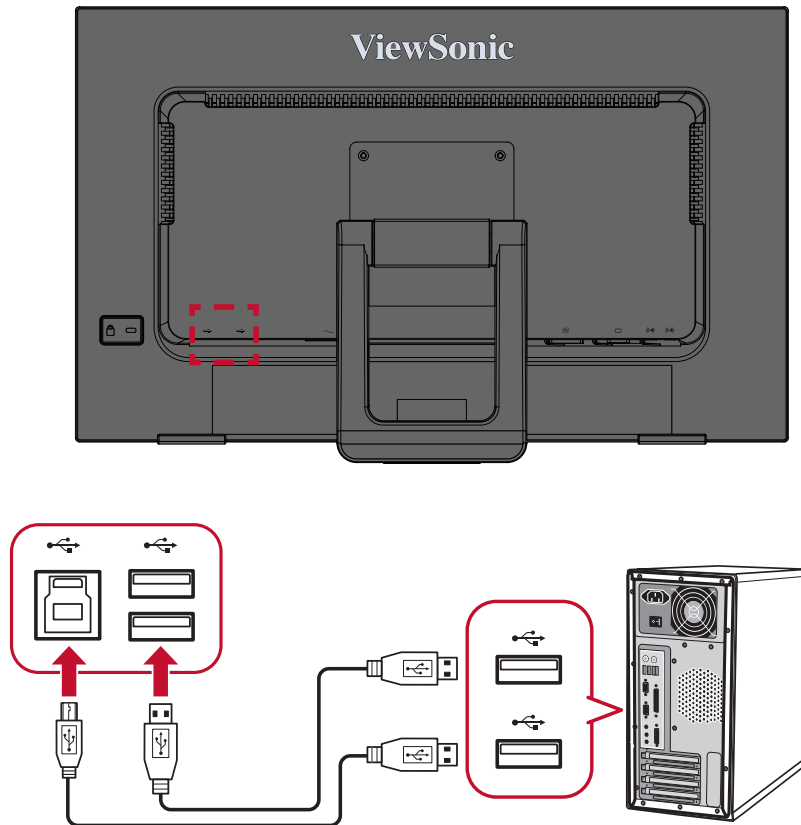

Touch Function Control

Before using the touch function, ensure the USB Type B to Type A cable is connected to your computer and the Windows operating system is running.

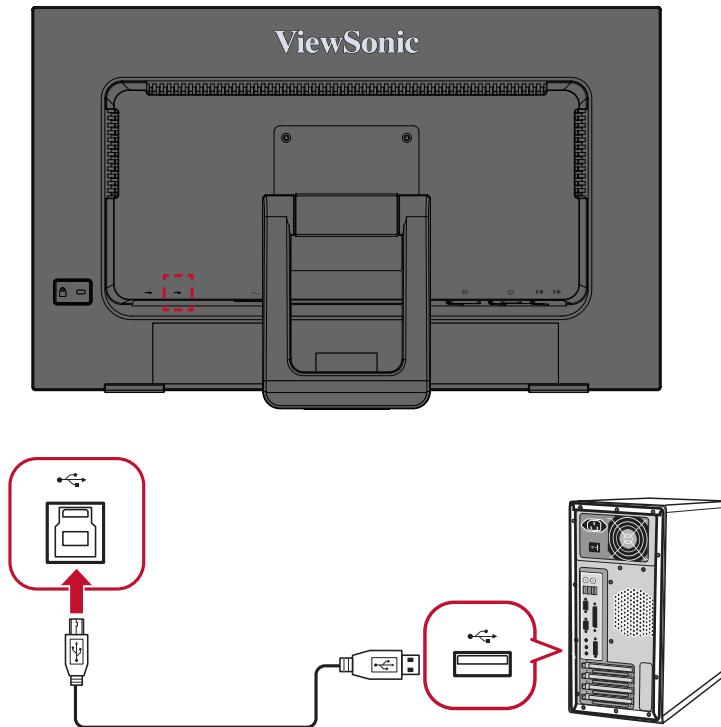

When using the touch function, please note:

- The touch function may need about five (5) seconds to resume if the USB cable is removed and plugged in again, or the computer resumes from *Sleep Mode*.
- The touchscreen can only detect up to ten (10) fingers simultaneously.
- If the Windows' cursor does not accurately follow your finger when you touch the screen, do the following:
 1. Open: **Control Panel > Hardware and Sound > Tablet PC Settings**
 2. Select **Calibration**.
 3. Follow the instructions to recalibrate your screen.

Touch Accuracy

- Touch accuracy is ± 2 mm over 90% of the touch active area located in the middle.
- Touch size at 10% of the edge area is ≥ 8 mm (as illustrated below), the area at the edges without black ink might not support any touch.



- It is requested to use a spherical tip stylus with a minimum diameter of 3 mm in 90% of the touch active area.
- It is requested to use a spherical tip stylus with a minimum diameter of 8 mm in 10% of the edge area.

Audio Connection

Plug an audio cable into the Audio In/Audio Out port of the monitor. Plug the other end into your computer (Audio In) or ear-/headphones (Audio Out).

NOTE: The monitor is also equipped with dual speakers.

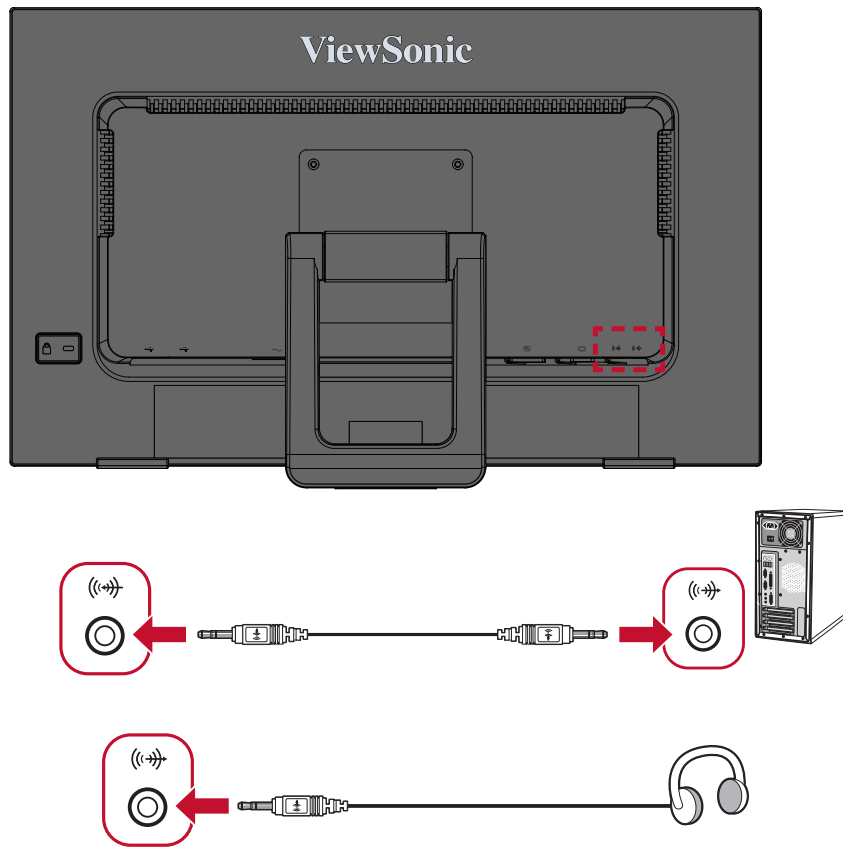

> Using the Monitor

Adjusting the Viewing Angle

Tilt Angle Adjustment

Tilt the monitor stand forwards or backwards to the desired viewing angle (20° to 40°).

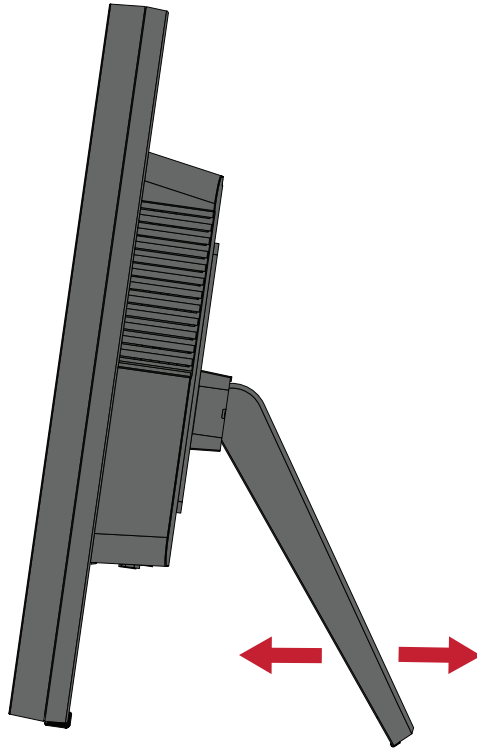

Turning the Device On/Off

1. Plug the power cord into a power outlet.
2. Press the **Power** key to turn on the monitor.
3. To turn the monitor off, press the **Power** key again.

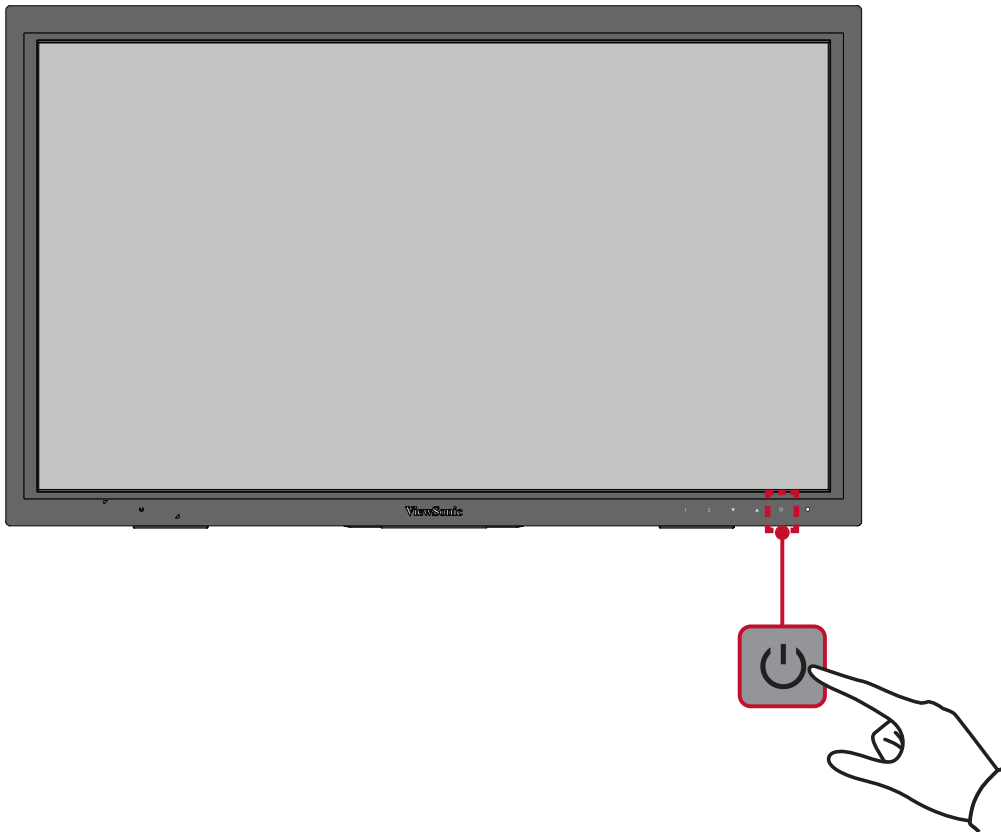

NOTE: The monitor will still consume some power as long as the power cord is connected to the power outlet. If the monitor is not being used for a long period of time, please disconnect the power plug from the power outlet.

Using the Control Panel Keys

Use the control panel keys to activate Hot Keys, navigate the On-Screen Display (OSD) Menu, and change the settings.

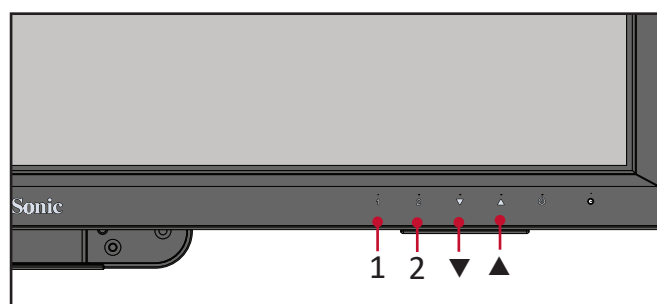





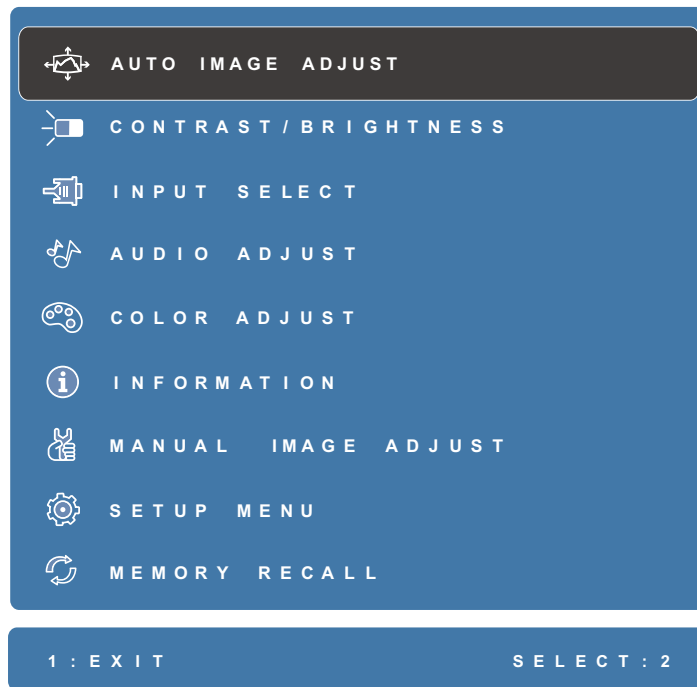



On-Screen Display (OSD) Menu

Press the **1** key to activate the On-Screen Display (OSD) Menu.







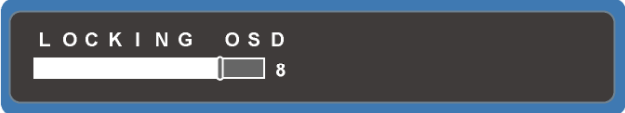

NOTE: Follow the key guide that appears on the bottom of the screen to select the option, then make adjustments with the ▼ and ▲ keys.

Menu	Description
 Auto Image Adjust	Automatically adjust the screen position.
 Contrast/Brightness	Adjust the contrast or brightness level.
 Input Select	Select the input source.
 Audio Adjust	Adjust the level, or mute the volume.
 Color Adjust	Select one of the preset color settings.
 Information	Displays the timing mode coming from the graphics card in the computer, the LCD model number, the serial number, and the ViewSonic® website URL.
 Manual Image Adjust	Manually set a variety of image quality adjustments.
 Setup Menu	Adjust On-Screen Display (OSD) settings.
 Memory Recall	Returns the adjustments back to factory settings.

Hot Keys

When the On-Screen Display (OSD) Menu is off, you can quickly access special functions by using the control panel keys.

Key	Description
1+ ▲	<p>Press and hold the keys to lock/unlock the OSD Menu. When the menu appears on the screen, continue holding both keys for 10 seconds to lock/unlock the OSD Menu.</p>  <p>If the OSD Menu is locked, the below message will appear on the screen:</p> 
1 + ▼	<p>Press and hold the keys to lock/unlock the Power button. When the menu appears on the screen, continue holding both keys for 10 seconds to lock/unlock the Power button.</p>  <p>If the Power button is locked, the below message will appear on the screen:</p> 
2 + ▲	<p>Press the keys to display/hide the boot up screen when the device is turned on.</p> 
2 + ▼	<p>Press the keys to toggle between DDC/CI and DDC/2B NOTE: DDC/CI is the default setting.</p>  

Key	Description
▲	Press the key to enter the Contrast menu.
▼	Press the key to enter the Color Adjust menu.
2	Press the key to toggle between input sources.

Configuring the Settings

General Operations

1. Press the **1** key to display the On-Screen Display (OSD) Menu.



2. Press the **▼** or **▲** key to select the main menu. Then press the **2** key to enter the selected menu.

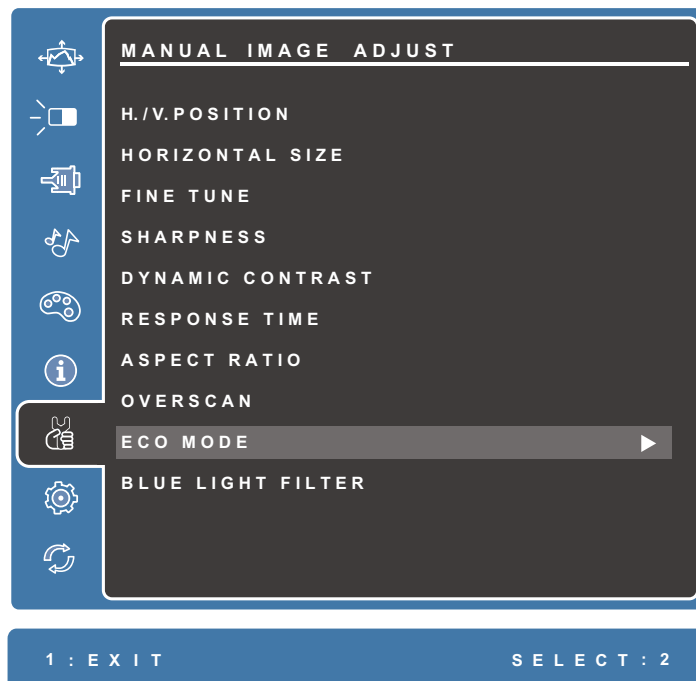

3. Press the ▼ or ▲ key to select the desired menu option. Then press the 2 key to enter the sub-menu.

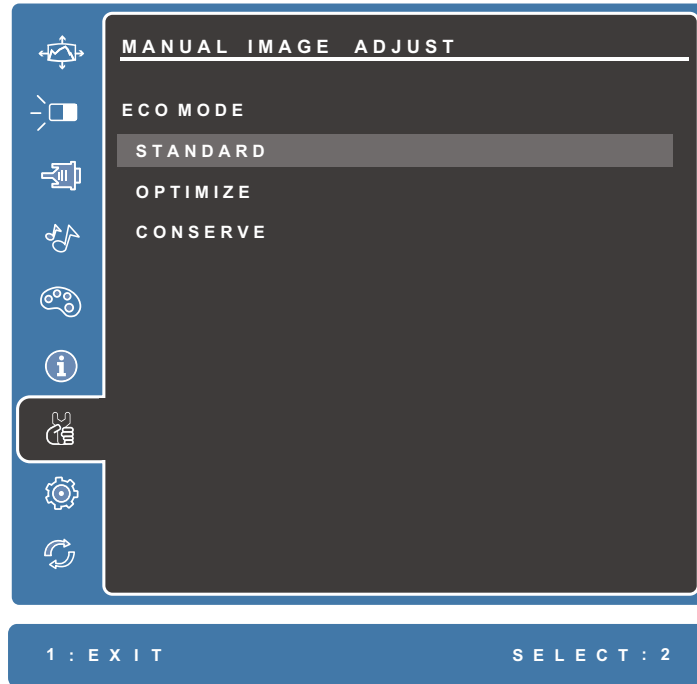

4. Press the ▼ or ▲ key to adjust/select the setting. Then press the 2 key to confirm.

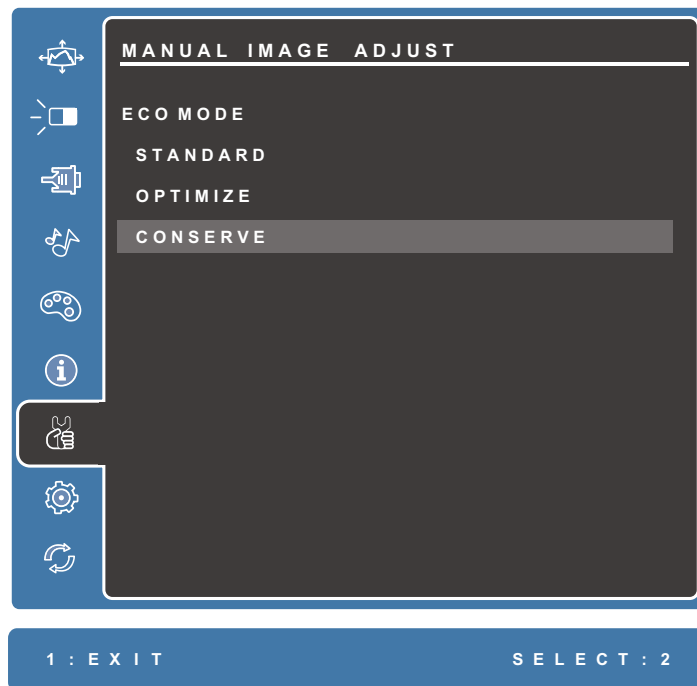

NOTE: Certain menu option adjustments do not require the user to press the 2 key to confirm the selection. Follow the key guide to select the option or make adjustments.

On-Screen Display (OSD) Menu Tree

Main Menu	Sub-menu	Menu Option		
Auto Image Adjust				
Contrast/Brightness	Contrast	(-/+ , 0~100)		
	Brightness	(-/+ , 0~100)		
Input Select	VGA			
	DVI			
	HDMI			
Audio Adjust	Volume	(-/+ , 0~100)		
	Mute	On		
		Off		
	Audio Input	HDMI		
Audio In				
Color Adjust	sRGB			
	Bluish			
	Cool			
	Native			
	Warm			
	User Color	Red	(-/+ , 0~100)	
		Green	(-/+ , 0~100)	
Blue		(-/+ , 0~100)		
Information				
Manual Image Adjust	H/V Position	Horizontal Position	(-/+ , 0~100)	
		Vertical Position	(-/+ , 0~100)	
	Horizontal Size	(-/+ , 0~100)		
	Fine Tune	(-/+ , 0~100)		
	Sharpness	(-/+ , 0~100)		
	Dynamic Contrast	On		
		Off		
	Response Time	Standard		
		Advanced		
		Ultra Fast		
	Aspect Ratio	4:3		
Full Screen				
Overscan	On			
	Off			

Main Menu	Sub-menu	Menu Option	
Manual Image Adjust	ECO Mode	Standard	
		Optimize	
		Conserve	
	Blue Light Filter	(-/+ , 0~100)	
Setup Menu	Language Select	English	
		Français	
		Deutsch	
		Español	
		Italiano	
		Suomi	
		Русский	
		Türkçe	
		日本語	
		한국어	
		繁體中文	
		简体中文	
		Česká	
	Svenska		
	Resolution Notice	On	
		Off	
	OSD Position	H. Position	(-/+ , 0~100)
V. Position		(-/+ , 0~100)	

Main Menu	Sub-menu	Menu Option
Setup Menu	OSD Pivot	0°
		+90°
		-90°
	OSD Timeout	(-/+ , 5/15/30/60)
	OSD Background	On
		Off
	Auto Power Off	On
		Off
	Sleep	30 Minutes
		45 Minutes
		60 Minutes
		120 Minutes
		Off
	Power Indicator	On
		Off
	Boot Up Screen	On
		Off
	Touch Screen	On
Off		
Memory Recall		

> Appendix

Specifications

Item	Category	Specifications	
		TD2223	TD2423
LCD	Type	a-si, TFT Active Matrix 1920 x 1080 LCD, 0.2482 mm x 0.2482 mm pixel pitch	a-si, TFT Active Matrix 1920 x 1080 LCD, 0.2715 mm x 0.2715 mm pixel pitch
	Display Size	54.69 cm, 24" (21.53" viewable)	60.96 cm, 24" (23.6" viewable)
	Surface Treatment	Glossy treatment (Haze 1%, 7H)	
Input Signal	Video Sync	<u>RGB Analog (75 Ω)</u> f_h :24-82 KHz, f_v :50-75 Hz <u>TMDS digital (100 Ω)</u> HDMI: f_h :24-82 KHz, f_v :50-75 Hz DVI: f_h :24-82 KHz, f_v :50-75 Hz	
Compatibility	PC	up to 1920 x 1080	
	Macintosh	up to 1920 x 1080	
	Recommended	1920 x 1080 @ 60Hz	

Item	Category	Specifications	
		TD2223	TD2423
Resolution ¹	Supported	<ul style="list-style-type: none"> • 1920 x 1080 @ 50, 60, 75Hz • 1680 x 1050 @ 60Hz • 1600 x 1200 @ 60Hz • 1600 x 900 @ 60Hz • 1440 x 900 @ 60, 75Hz • 1400 x 1050 @ 60Hz • 1366 x 768 @ 60 Hz • 1360 x 768 @ 60Hz • 1280 x 1024 @ 60, 75Hz • 1280 x 960 @ 50, 60, 75Hz • 1280 x 800 @ 50, 60, 75Hz • 1280 x 768 @ 50, 60, 75Hz • 1280 x 720 @ 50, 60Hz • 1152 x 900 @ 66Hz • 1152 x 870 @ 75Hz • 1152 x 864 @ 60, 75Hz • 1024 x 768 @ 50, 60, 70, 72, 75Hz • 1024 x 600 @ 60Hz • 832 x 624 @ 75Hz • 848 x 480 @ 60Hz • 800 x 600 @ 56, 60, 72, 75Hz • 800 x 480 @ 60Hz • 720 x 576 @ 50Hz • 720 x 480 @ 60Hz • 720 x 400 @ 70Hz • 640 x 480 @ 50, 60, 67, 72, 75Hz • 640 x 400 @ 60, 70Hz • 640 x 350 @ 70Hz 	
Power Adapter ²	Input Voltage	AC 100-240V, 50/60Hz (auto switch)	
Display Area	Full Scan (H x V)	476.64 x 268.11 mm (18.76" x 10.56")	521.28 x 293.22 mm (20.52" x 11.54")
Operating conditions	Temperature	0° C to 40° C (32° F to 104° F)	
	Humidity	20% to 90% (non-condensing)	
	Altitude	16,404 feet (4.9 km)	
Storage conditions	Temperature	-20° C to 60° C (-4° F to 140° F)	
	Humidity	5% to 90% (non-condensing)	
	Altitude	40,000 feet (12.1 km)	

Item	Category	Specifications	
		TD2223	TD2423
Dimensions	Physical (W x H x D)	521.28 x 333.85 x 100.53 mm (20.54" x 13.15" x 3.96")	570.92 x 348.48 x 100.99 mm (22.47" x 13.71" x 3.98")
Wall Mount	Dimensions	100 x 100 mm	
Weight	Physical	4.47 kg (9.86 lbs)	5.23 kg (11.53 lbs)
Power saving modes	On	15.0 W (Typical)	18.0 W (Typical)
	Off	< 0.3W	

¹ Do not set the graphics card in your computer to exceed these timing modes; doing so may result in permanent damage to the display.

² Please use the power adapter from ViewSonic® or an authorized source only.

Glossary

This section describes the standard glossary of terms used in all LCD display models. All terms are listed in alphabetical order.

NOTE: Some terms may not be applicable to your monitor.

A **Advanced DCR**

Advanced DCR technology automatically detects the image signal and intelligently controls the backlight brightness and color to improve on the ability to make the black blacker in a dark scene, and make the white whiter in a bright environment.

All Recall

Returns the adjustments back to factory settings if the display is operating in a factory Preset Timing Mode listed in the Specifications of this manual.

NOTE: (Exception) This control does not affect changes made with the “Language Select” or “Power Lock setting”.

Audio Adjust

Adjusts the volume, mutes the sound, or toggles between inputs if you have more than one source.

Auto Detect

If the current input source has no signal, the monitor will automatically switch to the next input option. This function, on some models, is disabled by default.

B **Black Stabilization**

ViewSonic’s Black Stabilization provides heightened visibility and detail by brightening dark scenes.

Blue Light Filter

Adjusts the filter that blocks high-energy blue light for a more comfortable viewing experience.

Brightness

Adjusts background black levels of the screen image.

C Color Adjust

Provides several color adjustment modes to help adjust the color settings to fit the user's needs.

Color Format

The monitor can detect the input signal color range automatically. You can manually change the color range options to fit the correct color range if the colors are not displayed correctly.

Color Space

Allows users to choose which color space they would like to use for monitor color output (RGB, YUV).

Color Temperature

Allows users to select specific color temperature settings to further customize their viewing experience.

Panel Default	Panel Original Status
Panel Default	Panel's default mode.
Bluish	Set the color temperature to 9300K.
Cool	Set the color temperature to 7500K.
Native	Default color temperature. Recommended for general use.
Warm	Set the color temperature to 5000K.
User	Custom user settings.

Contrast

Adjusts the difference between the image background (black level) and the foreground (white level).

F FreeSync

FreeSync technology puts an end to choppy gameplay and broken frames with fluid, artifact-free performance at virtually any frame rate.

G Game Mode

Integrating a gaming-oriented OSD design including pre-calibrated FPS, RTS, and MOBA gaming settings. Each mode is functionally customized with in-game testing and adjustments made for the best blend of color and technology.

Gamma

Allows users to manually adjust the brightness level of the monitor's grayscale levels.

H HDR10 (High-Dynamic-Range)

Reduces the overall contrast of a given scene so that detail in the highlights and shadows can be seen.

NOTE: Only available on HDR10 video content.

Hue

Adjusts the tint of each color (red, green, blue, cyan, magenta, and yellow).

I Information

Displays the timing mode (video signal input) coming from the graphics card in the computer, the LCD model number, the serial number, and the ViewSonic® website URL. See your graphics cards's user guide for instructions on changing the resolution and refresh rate (vertical frequency).

NOTE: VESA 1024 x 768 @ 60Hz, for example, means that the resolution is 1024 x 768 and the refresh rate is 60Hz.

Input Select

Toggles between the various input options that are available for the monitor.

L Low Input Lag

ViewSonic® offers low input lag, utilizing a monitor process reducer, which decreases signal latency. Under the "Low Input Lag" sub-menu, you can select the appropriate speed for your desired use from the options.

M Manual Image Adjust

Displays the “Manual Image Adjust” menu. You can manually set a variety of image quality adjustments.

Memory Recall

Returns the adjustments back to factory settings if the display is operating in a factory preset timing mode listed in the “Specifications” of this manual.

NOTE:

- (Exception) This control does not affect changes made in the “Language Select” or “Power Lock” setting.
- Memory Recall is the default as-shipped display configuration and settings. Memory Recall is the setting in which the product qualifies for ENERGY STAR®. Any changes to default as-shipped display configuration and settings would change the energy consumption, and may increase energy consumption beyond the limits required for ENERGY STAR® qualification, as applicable. ENERGY STAR® is a set of power-saving guidelines issued by the U.S. Environmental Protection Agency (EPA). ENERGY STAR® is a joint program of the U.S. Environmental Protection Agency and the U.S. Department of Energy helping us all save money and protect the environment through energy efficient products and practices.



O Overscan

Refers to a cropped image on your monitor’s screen. A setting on your monitor zooms in on movie content, so that you cannot see the outermost edges of the film.

P PIP (Picture-in-Picture)

Split the screen into two parts, a main window and an inset window. The user can specify the input source for each screen.

PIP Swap

This exchanges the main-picture source with the sub-picture source.

R **Recall**
Resets the ViewMode monitor settings.

Resolution Notice

The notice tells users that the current viewing resolution is not the correct native resolution. This notice will appear in the display settings window when setting up the display resolution.

Response Time

Creates smooth images without streaking, blurring, or ghosting. A low response time is perfect for the most graphic-intense gaming, and provides amazing visual quality while watching sports or action movies.

S **Saturation**

Adjusts the color depth of each color (red, green, blue, cyan, magenta, and yellow).

Setup Menu

Adjusts On-Screen Display (OSD) Menu settings. Many of these settings can activate on-screen display notifications so users do not have to reopen the menu.

Sharpness

Adjusts the picture quality of the monitor.

V **ViewMode**

ViewSonic's unique ViewMode feature offers "Game", "Movie", "Web", "Text", "MAC", and "Mono" presets. These presets are specifically designed to deliver an optimized viewing experience for different screen applications.

Y **YUV Color Space**

YUV color space is used for color image and video processing; taking into account properties of the human eye that allow for reduced bandwidth of chroma components without perceptual distortion.

Troubleshooting

This section describes some common problems that you may experience when using the monitor.

Problem or Issue	Possible Solutions
No power	<ul style="list-style-type: none">• Make sure you have turned on the monitor by pressing the Power button.• Make sure the power cord is properly and securely connected to the monitor and power outlet.• Plug another electrical device into the power outlet to verify that the outlet is supplying power.
Power is On, but no image appears on screen	<ul style="list-style-type: none">• Make sure the video cable connecting the monitor to the computer is properly and securely connected.• Adjust the brightness and contrast settings.• Make sure the correct input source is selected.
Wrong or abnormal colors	<ul style="list-style-type: none">• If any colors (red, green, or blue) are missing, check the video cable to make sure it is properly and securely connected. Loose or broken pins in the cable connector could cause an improper connection.• Connect the monitor to another computer.• If you have an older graphics card, contact ViewSonic® for a non-DDC adapter.
Screen image is too light or dark	<ul style="list-style-type: none">• Adjust brightness and contrast settings via the OSD Menu.• Reset the monitor to factory settings.
Screen image cuts in and out	<ul style="list-style-type: none">• Make sure the correct input source is selected.• Check for bent or broken pins in the video cable connector.• Make sure the video cable connecting the monitor to the computer is properly and securely connected.
Screen image is blurred	<ul style="list-style-type: none">• Adjust the resolution to the correct Aspect Ratio.• Reset the monitor to factory settings.
The screen isn't centered correctly	<ul style="list-style-type: none">• Adjust the horizontal and vertical controls via the OSD Menu.• Check the Aspect Ratio.• Reset the monitor to factory settings.

Problem or Issue	Possible Solutions
The screen appears yellow	<ul style="list-style-type: none"> • Make sure the “Blue Light Filter” is Off.
The OSD Menu does not appear on the screen/the OSD controls are inaccessible	<ul style="list-style-type: none"> • Check whether the OSD Menu is locked. Turn off the monitor, unplug the power cord, plug it back in, and then turn on the monitor. • Reset the monitor to factory settings.
Control panel keys do not work	<ul style="list-style-type: none"> • Press only one key at a time. • Restart the computer.
Some menus aren’t selectable in the OSD	<ul style="list-style-type: none"> • Adjust the ViewMode or the input source. • Reset the monitor to factory settings.
No audio output	<ul style="list-style-type: none"> • If using ear-/headphones, ensure the mini stereo jack is connected. • Make sure the volume is not muted, nor set to 0. • Check the Audio Input setting.
The monitor will not adjust	<ul style="list-style-type: none"> • Make sure there are no obstructions near or on the monitor, and that there is adequate spacing. • For more information, see “Adjusting the Viewing Angle”.
USB devices connected to the monitor do not work	<ul style="list-style-type: none"> • Make sure the USB cable is connected properly. • Try changing to another USB port (if applicable). • Some USB devices require a higher electric current; connect the device directly to the computer.
The external device is connected, but no image appears on the screen	<ul style="list-style-type: none"> • Make sure the Power is On • Adjust brightness and contrast via the OSD Menu. • Check the connecting cable and make sure it is properly and securely connected. Loose or broken pins in the cable connector could cause an improper connection.

Maintenance

General Precautions

- Make sure the monitor is turned off and the power cable is unplugged from the power outlet.
- Never spray or pour any liquid directly onto the screen or case.
- Handle the monitor with care, as a darker-colored monitor, if scuffed, may show marks more clearly than a lighter-colored monitor.

Cleaning the Screen

- Wipe the screen with a clean, soft, lint-free cloth. This removes dust and other particles.
- If the screen is still not clean, apply a small amount of non-ammonia, non-alcohol based glass cleaner onto a clean, soft, lint-free cloth; then wipe the screen.

Cleaning the Case

- Use a soft, dry cloth.
- If the case is still not clean, apply a small amount of non-ammonia, non-alcohol based, mild non-abrasive detergent onto a clean, soft, lint-free cloth, then wipe the surface.

Disclaimer

- ViewSonic® does not recommend the use of any ammonia or alcohol-based cleaners on the display screen or case. Some chemical cleaners have been reported to damage the screen and/or case of the monitor.
- ViewSonic® will not be liable for damage resulting from use of any ammonia or alcohol-based cleaners.

> Regulatory and Service Information

Compliance Information

This section addresses all connected requirements and statements regarding regulations. Confirmed corresponding applications shall refer to nameplate labels and relevant markings on the unit.

FCC Compliance Statement

This device complies with part 15 of FCC Rules. Operation is subject to the following two conditions: (1) this device may not cause harmful interference, and (2) this device must accept any interference received, including interference that may cause undesired operation. This equipment has been tested and found to comply with the limits for a Class B digital device, pursuant to part 15 of the FCC Rules.

These limits are designed to provide reasonable protection against harmful interference in a residential installation. This equipment generates, uses, and can radiate radio frequency energy, and if not installed and used in accordance with the instructions, may cause harmful interference to radio communications. However, there is no guarantee that interference will not occur in a particular installation. If this equipment does cause harmful interference to radio or television reception, which can be determined by turning the equipment off and on, the user is encouraged to try to correct the interference by one or more of the following measures:

- Reorient or relocate the receiving antenna.
- Increase the separation between the equipment and receiver.
- Connect the equipment into an outlet on a circuit different from that to which the receiver is connected.
- Consult the dealer or an experienced radio/TV technician for help.

Warning: You are cautioned that changes or modifications not expressly approved by the party responsible for compliance could void your authority to operate the equipment.

Industry Canada Statement

CAN ICES-3 (B)/NMB-3(B)

CE Conformity for European Countries

 The device complies with the EMC Directive 2014/30/EU and Low Voltage Directive 2014/35/EU.

The following information is only for EU-member states:

The mark shown to the right is in compliance with the Waste Electrical and Electronic Equipment Directive 2012/19/EU (WEEE). The mark indicates the requirement NOT to dispose of the equipment as unsorted municipal waste, but use the return and collection systems according to local law.



Declaration of RoHS2 Compliance

This product has been designed and manufactured in compliance with Directive 2011/65/EU of the European Parliament and the Council on restriction of the use of certain hazardous substances in electrical and electronic equipment (RoHS2 Directive) and is deemed to comply with the maximum concentration values issued by the European Technical Adaptation Committee (TAC) as shown below:

Substance	Proposed Maximum Concentration	Actual Concentration
Lead (Pb)	0.1%	< 0.1%
Mercury (Hg)	0.1%	< 0.1%
Cadmium (Cd)	0.01%	< 0.01%
Hexavalent Chromium (Cr6 ⁺)	0.1%	< 0.1%
Polybrominated biphenyls (PBB)	0.1%	< 0.1%
Polybrominated diphenyl ethers (PBDE)	0.1%	< 0.1%
Bis (2-ethylhexyl) phthalate (DEHP)	0.1%	< 0.1%
Butyl benzyl phthalate (BBP)	0.1%	< 0.1%
Dibutyl phthalate (DBP)	0.1%	< 0.1%
Diisobutyl phthalate (DIBP)	0.1%	< 0.1%

Certain components of products as stated above are exempted under the Annex III of the RoHS2 Directives as noted below. Examples of exempted components are:

- Mercury in cold cathode fluorescent lamps and external electrode fluorescent lamps (CCFL and EEFL) for special purposes not exceeding (per lamp):
 - » Short length (500 mm): maximum 3.5 mg per lamp.
 - » Medium length (> 500 mm and 1,500 mm): maximum 5 mg per lamp.
 - » Long length (> 1,500 mm): maximum 13 mg per lamp.
- Lead in glass of cathode ray tubes.
- Lead in glass of fluorescent tubes not exceeding 0.2% by weight.
- Lead as an alloying element in aluminum containing up to 0.4% lead by weight.
- Copper alloy containing up to 4% lead by weight.

- Lead in high melting temperature type solders (i.e. lead-based alloys containing 85% by weight or more lead).
- Electrical and electronic components containing lead in a glass or ceramic other than dielectric ceramic in capacitors, e.g. piezoelectronic devices, or in a glass or ceramic matrix compound.

Indian Restriction of Hazardous Substances

Restriction on Hazardous Substances statement (India). This product complies with the “India E-waste Rule 2011” and prohibits use of lead, mercury, hexavalent chromium, polybrominated biphenyls or polybrominated diphenyl ethers in concentrations exceeding 0.1 weight % and 0.01 weight % for cadmium, except for the exemptions set in Schedule 2 of the Rule.

Product Disposal at End of Product Life

ViewSonic® respects the environment and is committed to working and living green. Thank you for being part of Smarter, Greener Computing. Please visit the ViewSonic® website to learn more.

USA & Canada:

<http://www.viewsonic.com/company/green/recycle-program/>

Europe:

<http://www.viewsoniceurope.com/eu/support/call-desk/>

Taiwan:

<https://recycle.epa.gov.tw/>

Copyright Information

Copyright© ViewSonic® Corporation, 2021. All rights reserved.

Macintosh and Power Macintosh are registered trademarks of Apple Inc.

Microsoft, Windows, and the Windows logo are registered trademarks of Microsoft Corporation in the United States and other countries.

ViewSonic®, the three birds logo, OnView, ViewMatch, and ViewMeter are registered trademarks of ViewSonic® Corporation.

VESA is a registered trademark of the Video Electronics Standards Association. DPMS, DisplayPort, and DDC are trademarks of VESA.

ENERGY STAR® is a registered trademark of the U.S. Environmental Protection Agency (EPA).

As an ENERGY STAR® partner, ViewSonic® Corporation has determined that this product meets the ENERGY STAR® guidelines for energy efficiency.

Disclaimer: ViewSonic® Corporation shall not be liable for technical or editorial errors or omissions contained herein; nor for incidental or consequential damages resulting from furnishing this material, or the performance or use of this product.

In the interest of continuing product improvement, ViewSonic® Corporation reserves the right to change product specifications without notice. Information in this document may change without notice.

No part of this document may be copied, reproduced, or transmitted by any means, for any purpose without prior written permission from ViewSonic® Corporation.

Customer Service

For technical support or product service, see the table below or contact your reseller.

NOTE: You will need the product's serial number.

Country/ Region	Website	Country/ Region	Website
Asia Pacific & Africa			
Australia	www.viewsonic.com/au/	Bangladesh	www.viewsonic.com/bd/
中国 (China)	www.viewsonic.com.cn	香港 (繁體中文)	www.viewsonic.com/hk/
Hong Kong (English)	www.viewsonic.com/hk-en/	India	www.viewsonic.com/in/
Indonesia	www.viewsonic.com/id/	Israel	www.viewsonic.com/il/
日本 (Japan)	www.viewsonic.com/jp/	Korea	www.viewsonic.com/kr/
Malaysia	www.viewsonic.com/my/	Middle East	www.viewsonic.com/me/
Myanmar	www.viewsonic.com/mm/	Nepal	www.viewsonic.com/np/
New Zealand	www.viewsonic.com/nz/	Pakistan	www.viewsonic.com/pk/
Philippines	www.viewsonic.com/ph/	Singapore	www.viewsonic.com/sg/
臺灣 (Taiwan)	www.viewsonic.com/tw/	ประเทศไทย	www.viewsonic.com/th/
Việt Nam	www.viewsonic.com/vn/	South Africa & Mauritius	www.viewsonic.com/za/
Americas			
United States	www.viewsonic.com/us	Canada	www.viewsonic.com/us
Latin America	www.viewsonic.com/la		
Europe			
Europe	www.viewsonic.com/eu/	France	www.viewsonic.com/fr/
Deutschland	www.viewsonic.com/de/	Қазақстан	www.viewsonic.com/kz/
Россия	www.viewsonic.com/ru/	España	www.viewsonic.com/es/
Türkiye	www.viewsonic.com/tr/	Україна	www.viewsonic.com/ua/
United Kingdom	www.viewsonic.com/uk/		

Limited Warranty

ViewSonic® Display

What the warranty covers:

ViewSonic® warrants its products to be free from defects in material and workmanship during the warranty period. If a product proves to be defective in material or workmanship during the warranty period, ViewSonic® will, at its sole option, and as your sole remedy, repair or replace the product with a similar product. Replacement Product or parts (e.g. system board, display panel, power board) may include remanufactured or refurbished parts or components. The repair or replacement unit or parts or components will be covered by the balance of the time remaining on the customer's original limited warranty and the warranty period will not be extended. ViewSonic® provides no warranty for any third-party software whether included with the product or installed by the customer, installation of any unauthorized hardware parts or components (e.g. Projector Lamps). (Please refer to: "What the warranty excludes and does not cover" section).

How long the warranty is effective:

ViewSonic® displays are warranted for between 1 and 3 years, depending on your country of purchase, for all parts including the light source and for all labor from the date of the first consumer purchase.

Authorized service providers will offer replacement or repair for up to five (5) years from the date of the first consumer purchase. Should the display no longer be under warranty, the repair cost will be paid by the purchaser.

Who the warranty protects:

This warranty is valid only for the first consumer purchaser.

What the warranty excludes and does not cover:

- Any product on which the serial number has been defaced, modified, or removed.
- Damage, deterioration, or malfunction resulting from:
 - » Accident, misuse, neglect, fire, water, lightning, or other acts of nature, unauthorized product modification, or failure to follow instructions supplied with the product.
 - » Repair or attempted repair by anyone not authorized by ViewSonic®.
 - » Damage to or loss of any programs, data, or removable storage media.
 - » Normal wear and tear.
 - » Removal or installation of the product.

- Software or data loss occurring during repair or replacement.
- Any damage of the product due to shipment.
- Causes external to the product, such as electric power fluctuations or failure.
- Use of supplies or parts not meeting ViewSonic's specifications.
- Failure of owner to perform periodic product maintenance as stated in the User Guide.
- Any other cause which does not relate to a product defect.
- Damage caused by static (non-moving) images displayed for lengthy periods of time (also referred to as image burn-in).
- Software - Any third-party software included with the product or installed by the customer.
- Hardware/Accessories/Parts/Components – Installation of any unauthorized hardware, accessories, consumable parts or components (e.g. Projector Lamps).
- Damage to, or abuse of, the coating on the surface of the display through inappropriate cleaning as described in the product User Guide.
- Removal, installation, and set-up service charges, including wall-mounting of the product.

How to get service:

- For information about receiving service under warranty, contact ViewSonic® Customer Support (Please refer to the "Customer Service" page). You will need to provide your product's serial number.
- To obtain warranty service, you will be required to provide: (a) the original dated sales slip, (b) your name, (c) your address, (d) a description of the problem, and (e) the serial number of the product.
- Take or ship the product, freight prepaid, in the original container to an authorized ViewSonic® service center or ViewSonic®.
- For additional information or the name of the nearest ViewSonic® service center, contact ViewSonic®.

Limitation of implied warranties:

There are no warranties, express or implied, which extend beyond the description contained herein including the implied warranty of merchantability and fitness for a particular purpose.

Exclusion of damages:

ViewSonic's liability is limited to the cost of repair or replacement of the product. ViewSonic® shall not be liable for:

- Damage to other property caused by any defects in the product, damages based upon inconvenience, loss of use of the product, loss of time, loss of profits, loss of business opportunity, loss of goodwill, interference with business relationships, or other commercial loss, even if advised of the possibility of such damages.
- Any other damages, whether incidental, consequential or otherwise.
- Any claim against the customer by any other party.
- Repair or attempted repair by anyone not authorized by ViewSonic®.

Effect of state law:

This warranty gives you specific legal rights, and you may also have other rights which vary from state to state. Some states do not allow limitations on implied warranties and/or do not allow the exclusion of incidental or consequential damages, so the above limitations and exclusions may not apply to you.

Sales outside the U.S.A. and Canada:

For warranty information and service on ViewSonic® products sold outside of the U.S.A. and Canada, contact ViewSonic® or your local ViewSonic® dealer.

The warranty period for this product in mainland China (Hong Kong, Macao, and Taiwan Excluded) is subject to the terms and conditions of the Maintenance Guarantee Card.

For users in Europe and Russia, full details of warranty provided can be found at: <http://www.viewsonic.com/eu/> under "Support/Warranty Information".

Mexico Limited Warranty

ViewSonic® Display

What the warranty covers:

ViewSonic® warrants its products to be free from defects in material and workmanship, under normal use, during the warranty period. If a product proves to be defective in material or workmanship during the warranty period, ViewSonic® will, at its sole option, repair or replace the product with a like product. Replacement product or parts may include remanufactured or refurbished parts or components & accessories.

How long the warranty is effective:

ViewSonic® LCD displays are warranted for between 1 and 3 years, depending on your country of purchase, for all parts including the light source and for all labour from the date of the first consumer purchase.

Who the warranty protects:

This warranty is valid only for the first consumer purchaser.

What the warranty excludes and does not cover:

- Any product on which the serial number has been defaced, modified or removed.
- Damage, deterioration, or malfunction resulting from:
 - » Accident, misuse, neglect, fire, water, lightning, or other acts of nature, unauthorized product modification, unauthorized attempted repair, or failure to follow instructions supplied with the product.
 - » Causes external to the product, such as electrical power fluctuations or failure.
 - » Use of supplies or parts not meeting ViewSonic®'s specifications.
 - » Normal wear and tear.
 - » Any other cause which does not relate to a product defect.
- Any product exhibiting a condition commonly known as "image burn-in" which results when a static image is displayed on the product for an extended period of time.
- Removal, installation, insurance, and set-up service charges.

How to get service:

For information about receiving service under warranty, contact ViewSonic® Customer Support (Please refer to the attached “Customer Service” page). You will need to provide your product’s serial number, so please record the product information in the space provided below on your purchase for your future use. Please retain your receipt of proof of purchase to support your warranty claim.

For Your Records

Product Name: _____ Model Number: _____

Document Number: _____ Serial Number: _____

Purchase Date: _____ Extended Warranty Purchase? _____ (Y/N)

If so, what date does warranty expire? _____

- To obtain warranty service, you will be required to provide (a) the original dated sales slip, (b) your name, (c) your address, (d) a description of the problem, and (e) the serial number of the product.
- Take or ship the product, in the original container packaging, to an authorized ViewSonic® service center.
- Round trip transportation costs for in-warranty products will be paid by ViewSonic®.

Limitation of implied warranties:

There are no warranties, express or implied, which extend beyond the description contained herein including the implied warranty of merchantability and fitness for a particular purpose.

Exclusion of damages:

ViewSonic®’s liability is limited to the cost of repair or replacement of the product.

ViewSonic® shall not be liable for:

- Damage to other property caused by any defects in the product, damages based upon inconvenience, loss of use of the product, loss of time, loss of profits, loss of business opportunity, loss of goodwill, interference with business relationships, or other commercial loss, even if advised of the possibility of such damages.
- Any other damages, whether incidental, consequential or otherwise.
- Any claim against the customer by any other party.
- Repair or attempted repair by anyone not authorized by ViewSonic®.

Contact Information for Sales & Authorized Service (Centro Autorizado de Servicio) within Mexico:	
Name, address, of manufacturer and importers: México, Av. de la Palma #8 Piso 2 Despacho 203, Corporativo Interpalmas, Col. San Fernando Huixquilucan, Estado de México Tel: (55) 3605-1099 http://www.viewsonic.com/la/soporte/index.htm	
NÚMERO GRATIS DE ASISTENCIA TÉCNICA PARA TODO MÉXICO: 001.866.823.2004	
Hermosillo: Distribuciones y Servicios Computacionales SA de CV. Calle Juárez 284 local 2 Col. Bugambilias C.P: 83140 Tel: 01-66-22-14-9005 E-Mail: disc2@hmo.megared.net.mx	Villahermosa: Compumantenimientos Garantizados, S.A. de C.V. AV. GREGORIO MENDEZ #1504 COL, FLORIDA C.P. 86040 Tel: 01 (993) 3 52 00 47 / 3522074 / 3 52 20 09 E-Mail: compumantenimientos@prodigy.net.mx
Puebla, Pue. (Matriz): RENTA Y DATOS, S.A. DE C.V. Domicilio: 29 SUR 721 COL. LA PAZ 72160 PUEBLA, PUE. Tel: 01(52).222.891.55.77 CON 10 LINEAS E-Mail: datos@puebla.megared.net.mx	Veracruz, Ver.: CONEXION Y DESARROLLO, S.A DE C.V. Av. Americas # 419 ENTRE PINZÓN Y ALVARADO Fracc. Reforma C.P. 91919 Tel: 01-22-91-00-31-67 E-Mail: gacosta@qplus.com.mx
Chihuahua: Soluciones Globales en Computación C. Magisterio # 3321 Col. Magisterial Chihuahua, Chih. Tel: 4136954 E-Mail: Cefeo@soluglobales.com	Cuernavaca: Compusupport de Cuernavaca SA de CV Francisco Leyva # 178 Col. Miguel Hidalgo C.P. 62040, Cuernavaca Morelos Tel: 01 777 3180579 / 01 777 3124014 E-Mail: aquevedo@compusupportcva.com
Distrito Federal: QPLUS, S.A. de C.V. Av. Coyoacán 931 Col. Del Valle 03100, México, D.F. Tel: 01(52)55-50-00-27-35 E-Mail : gacosta@qplus.com.mx	Guadalajara, Jal.: SERVICRECE, S.A. de C.V. Av. Niños Héroes # 2281 Col. Arcos Sur, Sector Juárez 44170, Guadalajara, Jalisco Tel: 01(52)33-36-15-15-43 E-Mail: mmiranda@servicrece.com
Guerrero Acapulco: GS Computación (Grupo Sesicomp) Progreso #6-A, Colo Centro 39300 Acapulco, Guerrero Tel: 744-48-32627	Monterrey: Global Product Services Mar Caribe # 1987, Esquina con Golfo Pérsico Fracc. Bernardo Reyes, CP 64280 Monterrey N.L. México Tel: 8129-5103 E-Mail: aydeem@gps1.com.mx
MERIDA: ELECTROSER Av Reforma No. 403Gx39 y 41 Mérida, Yucatán, México CP97000 Tel: (52) 999-925-1916 E-Mail: rrrb@sureste.com	Oaxaca, Oax.: CENTRO DE DISTRIBUCION Y SERVICIO, S.A. de C.V. Murguía # 708 P.A., Col. Centro, 68000, Oaxaca Tel: 01(52)95-15-15-22-22 Fax: 01(52)95-15-13-67-00 E-Mail: gpotai2001@hotmail.com
Tijuana: STD Av Ferrocarril Sonora #3780 L-C Col 20 de Noviembre Tijuana, Mexico	FOR USA SUPPORT: ViewSonic® Corporation 381 Brea Canyon Road, Walnut, CA. 91789 USA Tel: 800-688-6688 E-Mail: http://www.viewsonic.com



ViewSonic®