

# DrayTek

## Vigor2927 Series

Dual-WAN Security Router



QUICK START GUIDE (RF MODEL)

V1.0

# Vigor2927 Series Dual-WAN Security Router Quick Start Guide (for RF Model)

Version: 1.0

Firmware Version: V4.2.0.1

(For future update, please visit [DrayTek web site](http://www.draytek.com))

Date: August 05, 2020

## Intellectual Property Rights (IPR) Information

### Copyrights

© All rights reserved. This publication contains information that is protected by copyright. No part may be reproduced, transmitted, transcribed, stored in a retrieval system, or translated into any language without written permission from the copyright holders.

### Trademarks

The following trademarks are used in this document:

- Microsoft is a registered trademark of Microsoft Corp.
- Windows, Windows 95, 98, Me, NT, 2000, XP, Vista, 7, 8, 10 and Explorer are trademarks of Microsoft Corp.
- Apple and Mac OS are registered trademarks of Apple Inc.
- Other products may be trademarks or registered trademarks of their respective manufacturers.

## Safety Instructions and Approval

### Safety

#### Instructions

- Read the installation guide thoroughly before you set up the router.
- The router is a complicated electronic unit that may be repaired only by authorized and qualified personnel. Do not try to open or repair the router yourself.
- Do not place the router in a damp or humid place, e.g. a bathroom.
- Do not stack the routers.
- The router should be used in a sheltered area, within a temperature range of +5 to +40 Celsius.
- Do not expose the router to direct sunlight or other heat sources. The housing and electronic components may be damaged by direct sunlight or heat sources.
- Do not deploy the cable for LAN connection outdoor to prevent electronic shock hazards.
- Keep the package out of reach of children.
- When you want to dispose of the router, please follow local regulations on conservation of the environment.

### Warranty

We warrant to the original end user (purchaser) that the router will be free from any defects in workmanship or materials for a period of two (2) years from the date of purchase from the dealer. Please keep your purchase receipt in a safe place as it serves as proof of date of purchase. During the warranty period, and upon proof of purchase, should the product have indications of failure due to faulty workmanship and/or materials, we will, at our discretion, repair or replace the defective products or components, without charge for either parts or labor, to whatever extent we deem necessary to restore the product to proper operating condition. Any replacement will consist of a new or re-manufactured functionally equivalent product of equal value, and will be offered solely at our discretion. This warranty will not apply if the product is modified, misused, tampered with, damaged by an act of God, or subjected to abnormal working conditions. The warranty does not cover the bundled or licensed software of other vendors. Defects which do not significantly affect the usability of the product will not be covered by the warranty. We reserve the right to revise the manual and online documentation and to make changes from time to time in the contents hereof without obligation to notify any person of such revision or changes.



## Declaration of Conformity

Hereby, DrayTek Corporation declares that the radio equipment type Vigor2927 is in compliance with Directive 2014/53/EU.

The full text of the EU Declaration of Conformity is available at the following internet address:

<http://www.draytek.com.tw/ftp/Vigor2927/Document/CE/>

Manufacturer: DrayTek Corp.

Address: No. 26, Fu Shing Road, HuKou Township, HsinChu Industrial Park, Hsin-Chu County, Taiwan 303

Product: Vigor2927 Series

Frequency Information for Europe area:

2.4G WLAN	2412MHz - 2472 MHz, max. TX power: 19.98dBm *1
5G WLAN	5160MHz - 5340 MHz, max. TX power: 22 dBm *2 5480MHz - 5720 MHz, max. TX power: 27 dBm
LTE	B1[1920-1980 MHz (TX); 2110-2170 MHz (RX)]; B3[1710-1785 MHz (TX); 1805-1880 MHz (RX)]; B7[2500-2570 MHz (TX); 2620-2690 MHz (RX)]; B20[832-862 MHz (TX); 791-821 MHz (RX)]; B28 [703-748 MHz (TX); 758-803 MHz (RX) ] B38 [2570-2620 MHz (TX); 2570-2620 MHz (RX)] B40 [2300-2400 MHz (TX); 2300-2400 MHz (RX)] *3
3G	B1[1920-1980 MHz (TX); 2110-2170 MHz (RX)]; B5[824-849 MHz (TX); 869-894 MHz (RX)]; B8[880-915 MHz (TX); 925-960 MHz (RX)] *3
	Requirements in AT/BE/BG/CZ/DZ/DK/EE/FR/DE/IS/IE/IT/EL/ES/ CY/LV/LI/LT/LU/HU/MT/NL/NO/PL/PT/RO/SI/SK/TR/FI/SE/CH/ UK/HR. 5150MHz-5350MHz is for indoor use only.

(\*1: for 2.4G WLAN model; \*2: for 5G WLAN model; \*3: for LTE model)

This product is designed for LTE and 2.4GHz /5GHz WLAN network throughout the EC region.

\*The external power supply used for each product will be model dependent.

	1	2	3	4	5	6	7	8	9
A Manufacturer	CWT	CWT	CWT	CWT	CWT	APD	APD	APD	APD
B Address	No. 222, Sec. 2, Nankan Rd., Lujhu Township, Taoyuan County 338, Taiwan	No. 222, Sec. 2, Nankan Rd., Lujhu Township, Taoyuan County 338, Taiwan	No. 222, Sec. 2, Nankan Rd., Lujhu Township, Taoyuan County 338, Taiwan	No. 222, Sec. 2, Nankan Rd., Lujhu Township, Taoyuan County 338, Taiwan	No. 222, Sec. 2, Nankan Rd., Lujhu Township, Taoyuan County 338, Taiwan	No.5, Lane 83, Lung-Sou St., Taoyuan City 330, Taiwan	No.5, Lane 83, Lung-Sou St., Taoyuan City 330, Taiwan	No.5, Lane 83, Lung-Sou St., Taoyuan City 330, Taiwan	No.5, Lane 83, Lung-Sou St., Taoyuan City 330, Taiwan
C Model identifier	2ABB012F UK 2ABB012F EU	2ABB018F UK 2ABB018F EU	2ABL024F UK 2ABL024F EU	2ABL030F UK 2ABL030F EU	2ABN036F UK 2ABN036F EU	WA-12M12FG WA-12M12FK	WB-18D12FG WB-18D12FK	WA-24Q12FG WA-24Q12FK	WA-36A12FG WA-36A12FK
D Input voltage	100-240V	100-240V	100-240V	100-240V	100-240V	100-240V	100-240V	100-240V	100-240V
E Input AC frequency	50/60Hz	50/60Hz	50/60Hz	50/60Hz	50/60Hz	50/60Hz	50/60Hz	50/60Hz	50/60Hz
Output voltage DC	12.0V	12.0V	12.0V	12.0V	12.0V	12.0V	12.0V	12.0V	12.0V
F Output current	1.0A	1.5A	2.0A	2.5A	3.0A	1.0A	1.5A	2.0A	3.0A
G Output power	12.0W	18.0W	24.0W	30.0W	36.0W	12.0W	18.0W	24.0W	36.0W
H Average active efficiency	84.9%	86.2%	87.6%	87.8%	89.8%	83.7%	85.4%	88.6%	88.2%
I Efficiency at low load 10%	73.6%	78.0%	81.3%	83.3%	83.7%	74.5%	80.5%	86.4%	85.4%
J No-load power consumption	0.07W	0.07W	0.07W	0.07W	0.07W	0.07W	0.10W	0.07W	0.10W

External power supply (Power Adapter) information. For more update, please visit [www.draytek.com](http://www.draytek.com).





## Regulatory Information

### Federal Communication Commission Interference Statement

This equipment has been tested and found to comply with the limits for a Class B digital device, pursuant to Part 15 of the FCC Rules. These limits are designed to provide reasonable protection against harmful interference in a residential installation. This equipment generates, uses and can radiate radio frequency energy and, if not installed and used in accordance with the instructions, may cause harmful interference to radio communications. However, there is no guarantee that interference will not occur in a particular installation. If this equipment does cause harmful interference to radio or television reception, which can be determined by turning the equipment off and on, the user is encouraged to try to correct the interference by one of the following measures:

- Reorient or relocate the receiving antenna.
- Increase the separation between the equipment and receiver.
- Connect the equipment into an outlet on a circuit different from that to which the receiver is connected.
- Consult the dealer or an experienced radio/TV technician for help.

This device complies with Part 15 of the FCC Rules. Operation is subject to the following two conditions:

- (1) This device may not cause harmful interference, and
- (2) This device may accept any interference received, including interference that may cause undesired operation.

USA Local Representative	Company name	ABP International Inc.		
	Address	13988 Diplomat Drive Suite 180 Dallas TX 75234		
	ZIP Code	75234	E-mail	rmesser@abptech.com
	Contact Person	Mr. Robert Messer	Tel.	19728311600

### Caution:

Any changes or modifications not expressly approved by the grantee of this device could void the user's authority to operate the equipment.

Any changes or modifications not expressly approved by the party responsible for compliance could void the user's authority to operate this equipment.

This transmitter must not be co-located or operating in conjunction with any other antenna or transmitter.

Radiation Exposure Statement: This equipment complies with FCC radiation exposure limits set forth for an uncontrolled environment. This equipment should be installed and operated with minimum distance 20cm between the radiator & your body.

The antenna/transmitter should be kept at least 20 cm away from human body.

## ***Table of Contents***

<b>1. Package Content .....</b>	<b>1</b>
<b>2. Panel Explanation.....</b>	<b>2</b>
2.1 Vigor2927L .....	2
2.2 Vigor2927ac / Vigor2927ax / Vigor2927Lac .....	4
<b>3. Hardware Installation .....</b>	<b>11</b>
3.1 Network Connection .....	11
3.2 Wall-Mounted Installation .....	12
3.3 Antenna Installation (for “L” model) .....	13
<b>4. Software Configuration .....</b>	<b>15</b>
<b>5. Customer Service .....</b>	<b>22</b>
Be a Registered Owner .....	22
Firmware & Tools Updates .....	22

# 1. Package Content

Take a look at the package content. If there is anything missed or damaged, please contact DrayTek or the dealer immediately. Besides, the content is subject to the real package.



**Vigor Router**

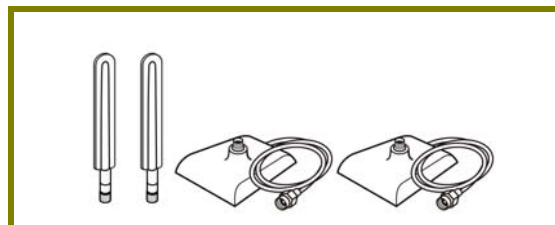

**Antenna + Socket (for L models)**

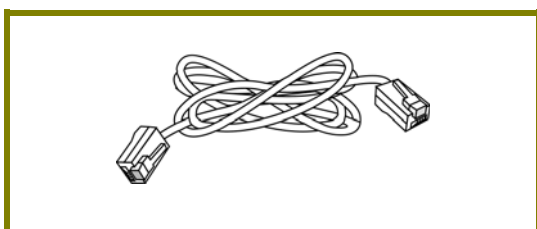

**RJ-45 Cable (Ethernet)**

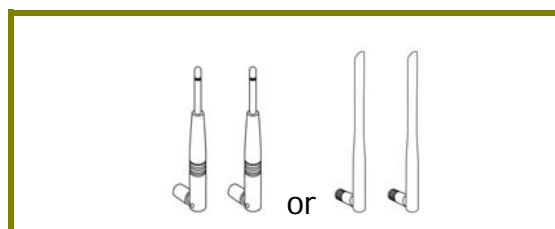

**Antenna (for ac / ax models)**

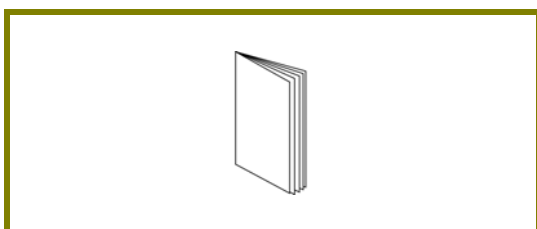

**Quick Start Guide**

The type of the power adapter depends on the country that the router will be installed. \* The maximum power consumption is *28 Watt*.

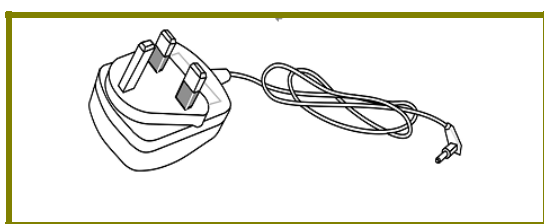

**UK-type Power Adapter**

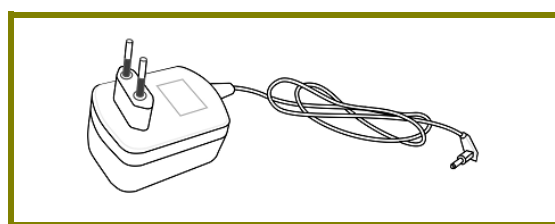

**EU-type Power Adapter**

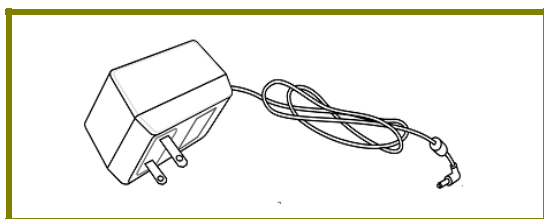

**USA/Taiwan-type Power Adapter**

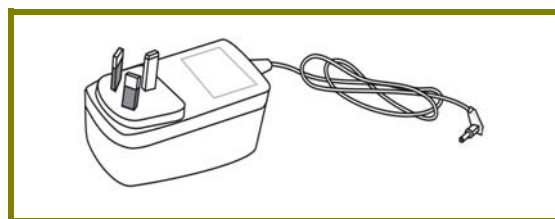

**AU/NZ-type Power Adapter**

## 2. Panel Explanation

### 2.1 Vigor2927L

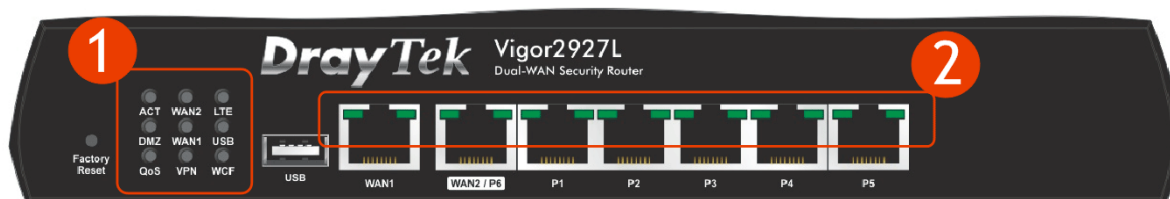

No.	LED	Status	Explanation
(1)	ACT	Off	The router is powered off.
		Blinking	The router is powered on and running normally.
	WAN2/WAN1	On	Internet connection is ready.
		Off	Internet connection is not ready.
		Blinking	The data is transmitting.
	LTE	On	LTE device is connected and ready for use.
		Off	LTE device is not detected, or has serious problem (e.g., no SIM card, SIM pin error, SIM deactivated, and etc.).
		Blinking	Slowly: LTE device is in dialing up. Quickly: The data is transmitting.
	DMZ	On	The DMZ function is enabled.
		Off	The DMZ function is disabled.
		Blinking	The data is transmitting.
	USB	On	USB device is connected and ready for use.
		Off	No USB device is connected.
		Blinking	The data is transmitting.
	QoS	On	The QoS function is active.
		Off	The QoS function is inactive.
	VPN	On	The VPN tunnel is active.
		Off	VPN services are disabled
Blinking		Traffic is passing through VPN tunnel.	
WCF	On	The Web Content Filter is active. (It is enabled from Firewall >> General Setup).	
	Off	WCF is disabled.	
(2)	WAN1, WAN2 / P6		
	Left LED	On	The port is connected.
		Off	The port is disconnected.
		Blinking	The data is transmitting.
	Right LED	On	The port is connected with 1000Mbps.
		Off	The port is connected with 10/100Mbps.



LAN P1-P5		
Left LED	On	The port is connected.
	Off	The port is disconnected.
	Blinking	The data is transmitting.
Right LED	On	The port is connected with 1000Mbps.
	Off	The port is connected with 10/100Mbps



No.	Interface	Description
(3)	Factory Reset	Restore the default settings. Usage: Turn on the router (ACT LED is blinking). Press the hole and keep for more than 5 seconds. When you see the ACT LED begins to blink rapidly than usual, release the button. Then the router will restart with the factory default configuration.
(4)	USB	Connector for a USB device (for 3G/4G USB Modem or printer or thermometer).
(5)	WAN1	Connector for local network devices or modem for accessing Internet.
	WAN2 / P6	Connector for local network devices or modem for accessing Internet. It is a switchable port. It can be used for LAN connection or WAN connection according to the settings configured in WUI.
	LAN P1-P5	Connecters for local network devices.
(6)	PWR	Connector for a power adapter.
	ON/OFF	Power Switch.
(7)		Connector for installing LTE antennas.
(8)	SIM 2 / SIM 1	Slots for installing SIM card.

## 2.2 Vigor2927ac / Vigor2927ax / Vigor2927Lac

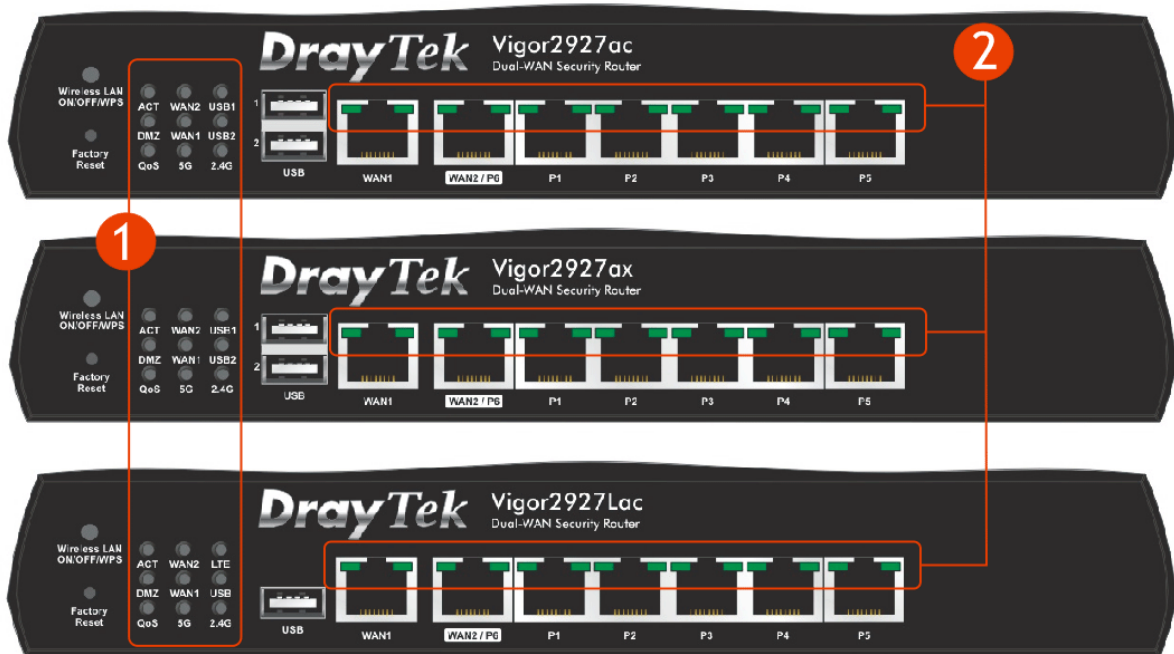

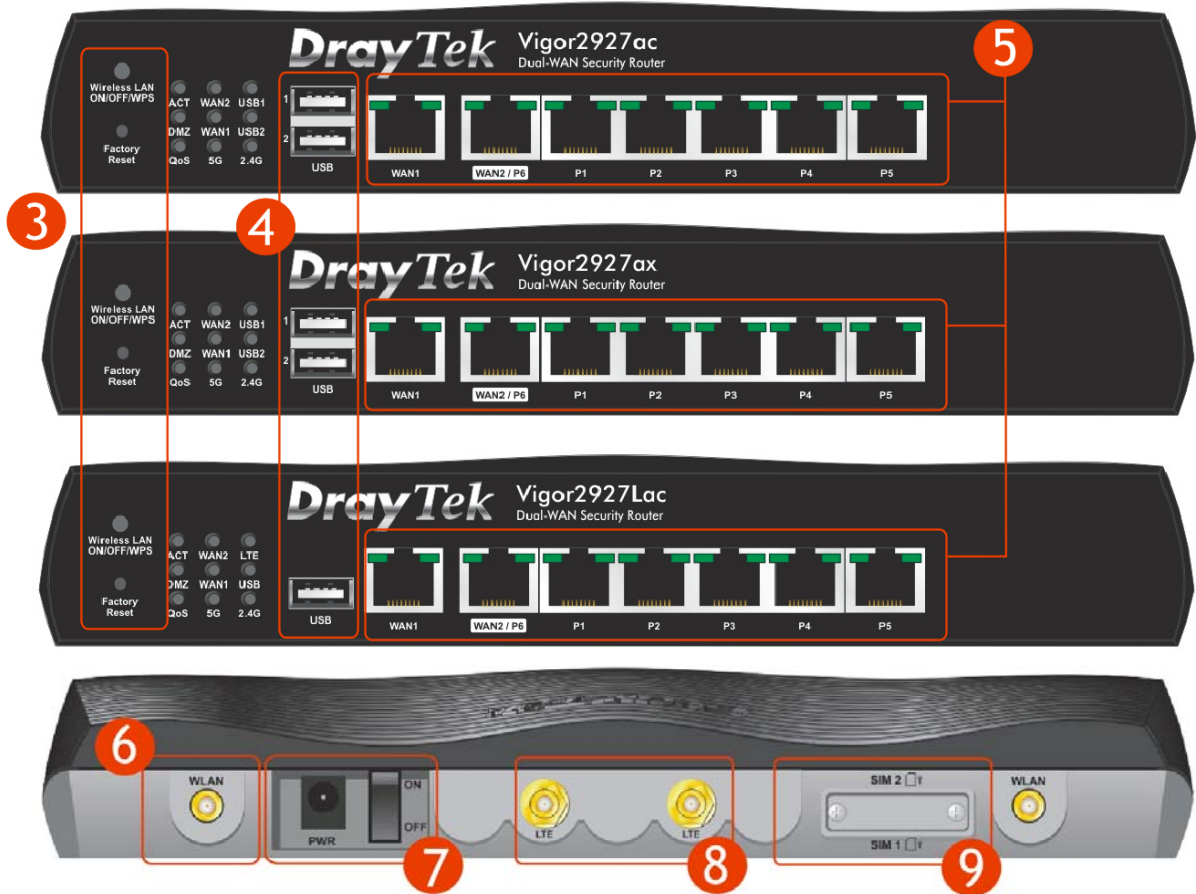

No.	LED	Status	Explanation
(1)	ACT	Off	The router is powered off.
		Blinking	The router is powered on and running normally.
	WAN2/WAN1	On	Internet connection is ready.
		Off	Internet connection is not ready.
		Blinking	The data is transmitting.
	USB1/USB2	On	USB device is connected and ready for use.
		Off	No USB device is connected.
		Blinking	The data is transmitting.
	LTE	On	LTE device is connected and ready for use.
		Off	LTE device is not detected, or has serious problem (e.g., no SIM card, SIM pin error, SIM deactivated, and etc.).
		Blinking	Slowly: LTE device is in dialing up. Quickly: The data is transmitting.
	DMZ	On	The DMZ function is enabled.
		Off	The DMZ function is disabled.
		Blinking	The data is transmitting.

(1)	QoS	On	The QoS function is active.
		Off	The QoS function is inactive.
	5G / 2.4G	On	5G / 2.4G: Wireless access point with bandwidth of 5GHz/2.4GHz is ready. WLAN: Wireless access point is ready.
		Off	Wireless function is disabled.
	Blinking	It will blink slowly while wireless traffic goes through. ACT and WLAN LEDs blink quickly and simultaneously when WPS is working, and will return to normal condition after two minutes. (You need to setup WPS within 2 minutes.)	
(2)	WAN1, WAN2 / P6		
	Left LED	On	The port is connected.
		Off	The port is disconnected.
		Blinking	The data is transmitting.
	Right LED	On	The port is connected with 1000Mbps.
		Off	The port is connected with 10/100Mbps.
	LAN P1-P5		
	Left LED	On	The port is connected.
		Off	The port is disconnected.
		Blinking	The data is transmitting.
Right LED	On	The port is connected with 1000Mbps.	
	Off	The port is connected with 10/100Mbps	



No.	Interface	Description
(3)	Wireless LAN ON/OFF/WPS	<p>Wireless band will be switched /changed according to the button pressed and released. For example,</p> <ul style="list-style-type: none"> <li>● 2.4G (On) and 5G (On) - in default.</li> <li>● 2.4G (Off) and 5G (On) - pressed and released the button once.</li> <li>● 2.4G (On) and 5G (Off) - pressed and released the button twice.</li> <li>● 2.4G (Off) and 5G (Off) - pressed and released the button three times.</li> </ul> <p>When WPS function is enabled by web user interface, press this button for more than 2 seconds to wait for client's device making network connection through WPS.</p>
	Factory Reset	<p>Restore the default settings. Usage: Turn on the router (ACT LED is blinking). Press the hole and keep for more than 5 seconds. When you see the ACT LED begins to blink rapidly than usual, release the button. Then the router will restart with the factory default configuration.</p>
(4)	USB1-2 / USB	<p>Connector for a USB device (for 3G/4G USB Modem or printer or thermometer).</p>
(5)	WAN1	<p>Connector for local network devices or modem for accessing Internet.</p>

	WAN2 / P6	Connector for local network devices or modem for accessing Internet. It is a switchable port. It can be used for LAN connection or WAN connection according to the settings configured in WUI.
	LAN P1-P5	Connecters for local network devices.
(6)	 WLAN	Connector for installing WLAN antennas. (For ac model)
(7)	PWR	Connector for a power adapter.
	ON/OFF	Power Switch.
(8)	 LTE	Connector for installing LTE antennas. (For L model).
(9)	SIM 2/ SIM 1	Slots for installing SIM card. (For L model).

## 2.3 Vigor2927Vac

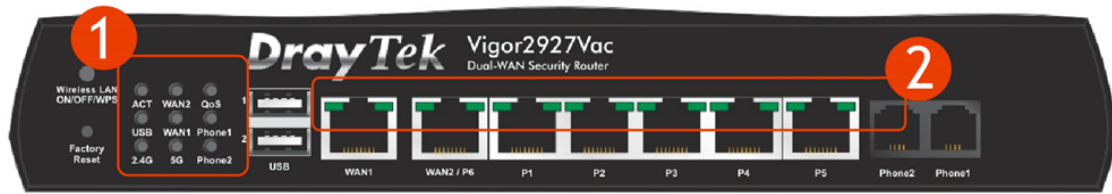

No.	LED	Status	Explanation
(1)	ACT	Off	The router is powered off.
		Blinking	The router is powered on and running normally.
	WAN2/WAN1	On	Internet connection is ready.
		Off	Internet connection is not ready.
		Blinking	The data is transmitting.
	QoS	On	The QoS function is active.
		Off	The QoS function is inactive.
	USB	On	USB device is connected and ready for use.
		Off	No USB device is connected.
		Blinking	The data is transmitting.
	Phone1/ Phone2	On	The phone connected to this port is off-hook.
		Off	The phone connected to this port is on-hook.
		Blinking	A phone call comes.
	2.4G/5G	On	5G / 2.4G: Wireless access point with bandwidth of 5GHz/2.4GHz is ready. WLAN: Wireless access point is ready.
		Off	Wireless function is disabled.
Blinking		It will blink slowly while wireless traffic goes through. ACT and WLAN LEDs blink quickly and simultaneously when WPS is working, and will return to normal condition after two minutes. (You need to setup WPS within 2 minutes.)	
(2)	WAN1, WAN2 / P6		
	Left LED	On	The port is connected.
		Off	The port is disconnected.
		Blinking	The data is transmitting.
	Right LED	On	The port is connected with 1000Mbps.
Off		The port is connected with 10/100Mbps.	

LAN P1-P5		
Left LED	On	The port is connected.
	Off	The port is disconnected.
	Blinking	The data is transmitting.
Right LED	On	The port is connected with 1000Mbps.
	Off	The port is connected with 10/100Mbps



No.	Interface	Description
(3)	Wireless LAN ON/OFF/WPS	<p>Wireless band will be switched /changed according to the button pressed and released. For example,</p> <ul style="list-style-type: none"> <li>● 2.4G (On) and 5G (On) - in default.</li> <li>● 2.4G (Off) and 5G (On) - pressed and released the button once.</li> <li>● 2.4G (On) and 5G (Off) - pressed and released the button twice.</li> <li>● 2.4G (Off) and 5G (Off) - pressed and released the button three times.</li> </ul> <p>When WPS function is enabled by web user interface, press this button for more than 2 seconds to wait for client's device making network connection through WPS.</p>
	Factory Reset	<p>Restore the default settings. Usage: Turn on the router (ACT LED is blinking). Press the hole and keep for more than 5 seconds. When you see the ACT LED begins to blink rapidly than usual, release the button. Then the router will restart with the factory default configuration.</p>
(4)	USB1~2 / USB	<p>Connector for a USB device (for 3G/4G USB Modem or printer or thermometer).</p>
(5)	WAN1	<p>Connector for local network devices or modem for accessing Internet.</p>
	WAN2 / P6	<p>Connector for local network devices or modem for accessing Internet. It is a switchable port. It can be used for LAN connection or</p>

		WAN connection according to the settings configured in WUI.
	LAN P1-P5	Connecters for local network devices.
(6)		Connector for installing WLAN antennas. (For ac model)
(7)	PWR	Connector for a power adapter.
	ON/OFF	Power Switch.



### 3. Hardware Installation

This section will guide you to install the router through hardware connection and configure the router's settings through web browser.

Before starting to configure the router, you have to connect your devices correctly. (For the hardware connection, we take "ac" model as an example.)

#### 3.1 Network Connection

1. Connect the cable Modem/DSL Modem/Media Converter to any WAN port of router with Ethernet cable (RJ-45).
2. Connect one end of an Ethernet cable (RJ-45) to one of the LAN ports of the router and the other end of the cable (RJ-45) into the Ethernet port on your computer.
3. Connect one end of the power adapter to the router's power port on the rear panel, and the other side into a wall outlet.
4. Power on the device by pressing down the power switch on the rear panel.
5. The system starts to initiate. After completing the system test, the ACT LED will light up and start blinking. (For the detailed information of LED status, please refer to section 3. Panel Explanation)

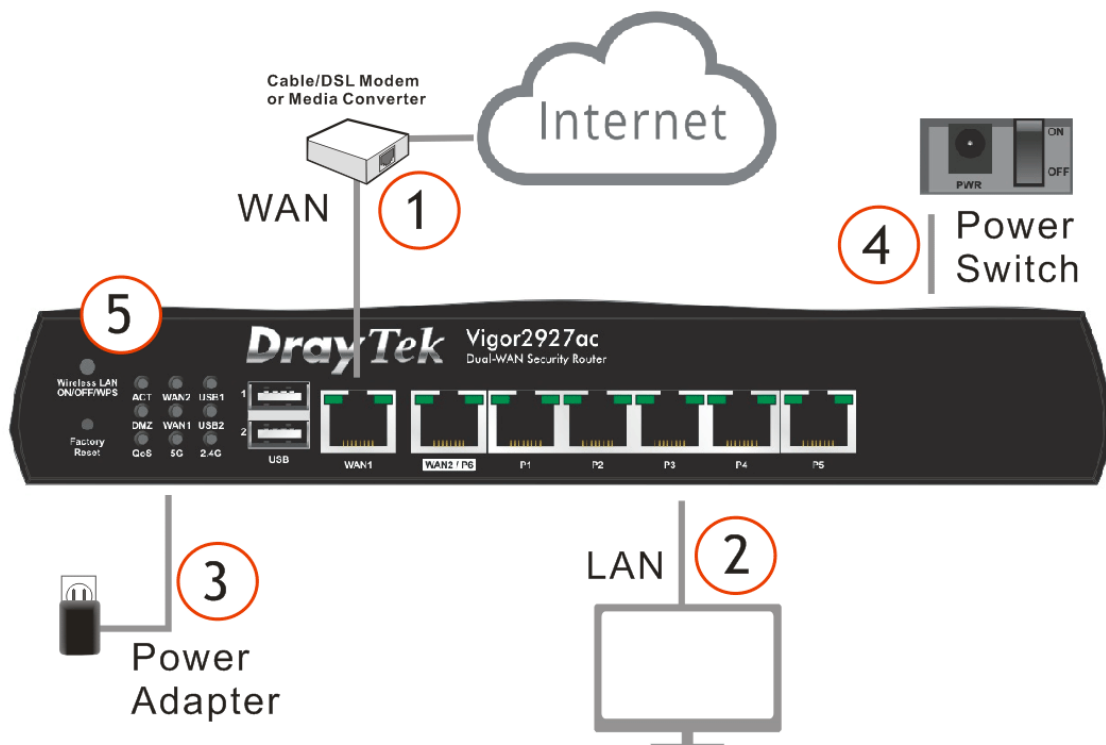

### 3.2 Wall-Mounted Installation

Vigor router has keyhole type mounting slots on the underside.

1. Drill two holes on the wall. The distance between the holes shall be 168mm.
2. Fit screws into the wall using the appropriate type of wall plug.

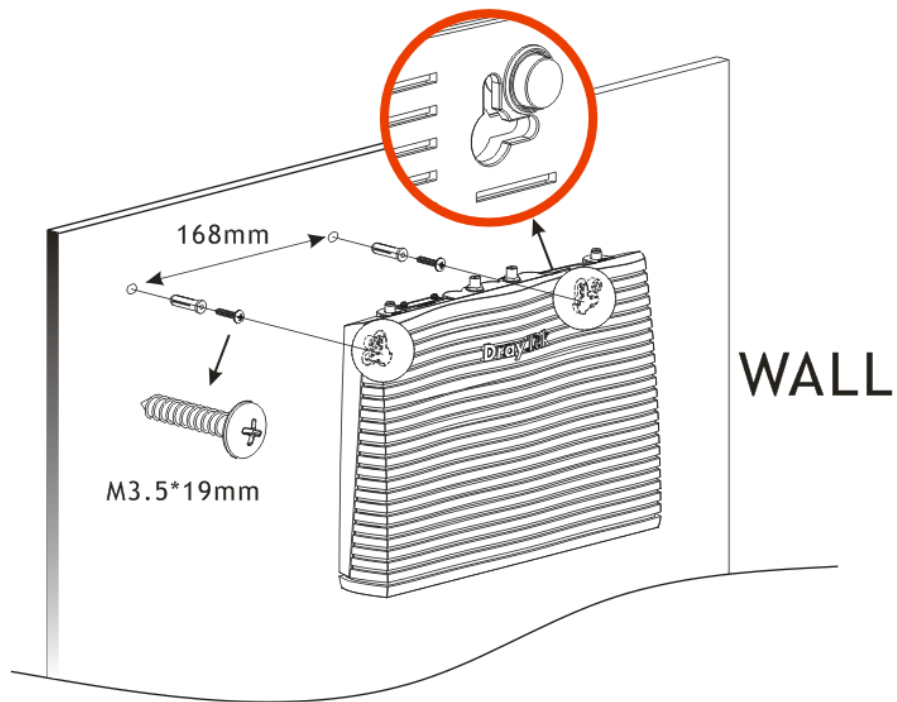

**Note**

The recommended drill diameter shall be 6.5mm (1/4").

3. When you finished about procedure, the router has been mounted on the wall firmly.

### 3.3 Antenna Installation (for "L" model)

Magnetic antenna must be installed on the extension base before connecting to Vigor router.

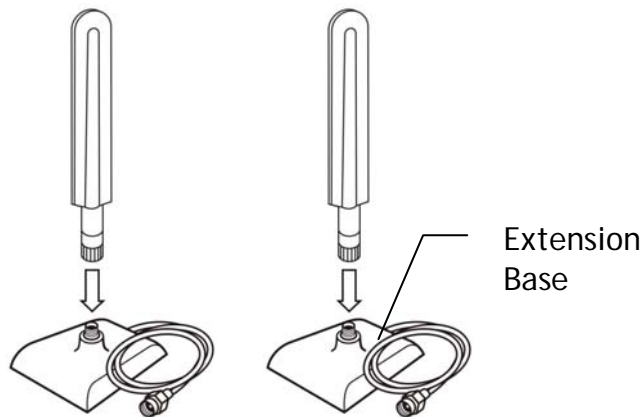

There are two mounting holes for installing antennas with extension base on Vigor router. Please install them as shown below.



Note, if only one antenna shall be installed, please use the mounting hole (major signal transmitted hole) near to the power switch.

While installing the SIM card into the card slot, note that back plate of the SIM card slot must be removed first and the direction of card notch must be on the left side.



There are two types of antennas provided for Vigor2927Lac, which must be be installed in different locations carefully and correctly. Wrong installation might cause bad signal of wireless connection. Therefore, pay attention to the installation of antennas by referring to the following illustration.

SMA jack for LTE Antenna  
(with extension base)

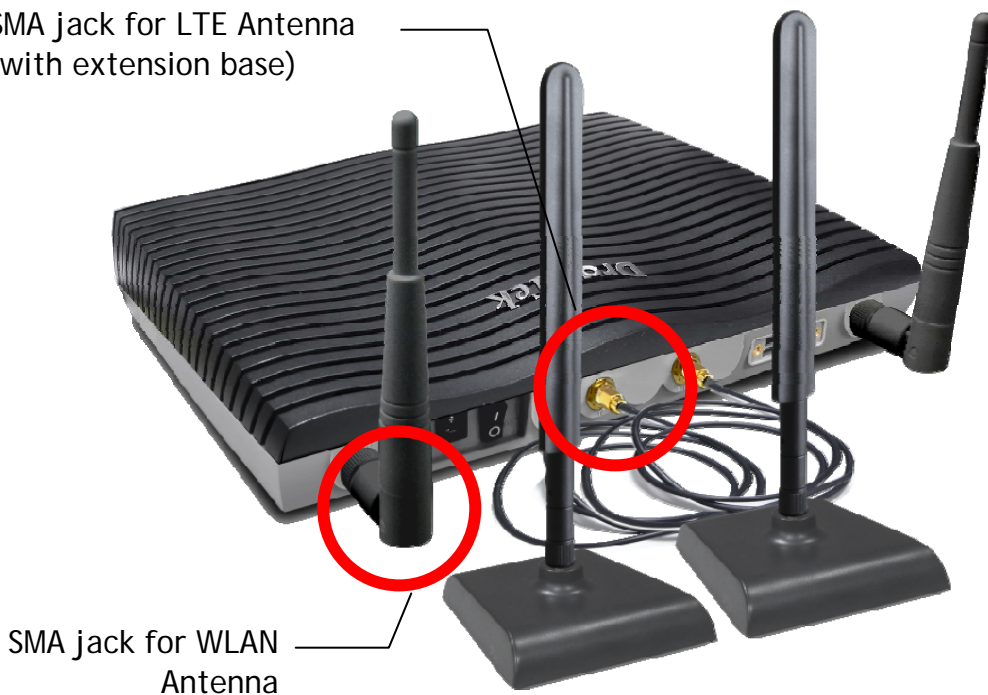

SMA jack for WLAN  
Antenna

## 4. Software Configuration

To access Internet, please finish basic configuration after completing the hardware installation.

The **Quick Start Wizard** is designed for you to easily set up your router for Internet access. You can directly access the **Quick Start Wizard** via Web User Interface. Make sure your PC connects to the router correctly.



---

### Note

You may either simply set up your computer to get IP dynamically from the router or set up the IP address of the computer to be the same subnet as the default IP address of Vigor router 192.168.1.1. For the detailed information, please refer to - Trouble Shooting of the user's guide.

---

Open a web browser on your PC and type **http://192.168.1.1**. A pop-up window will open to ask for username and password. Please enter "admin/admin" as the Username/Password and click **Login**.

**DrayTek** **Vigor2927 Series**

**Login**

Username

Password

**Login**

Security Warning: You are logging in without encryption which is not recommended. To login securely [click here](#).

Copyright © 2000-2019 DrayTek Corp. All Rights Reserved.



---

### Note

If you fail to access to the web configuration, please go to "Trouble Shooting" on User's Guide for detecting and solving your problem.

---

Now, the Main Screen will pop up. Click **Wizards>>Quick Start Wizard**.



**Note** The home page will change slightly in accordance with the router you have. Here we take Vigor2927Lac as an example.

If your router can be under an environment with high speed NAT, the configuration provide here can help you to deploy and use the router quickly. The first screen of **Quick Start Wizard** is entering login password. After typing the password, please click **Next**.

**Quick Start Wizard**

**Enter login password**

Please enter an alpha-numeric string as your **Password** (Max 23 characters).

Old Password

New Password

Confirm Password

Hint: If you want to keep the password unchanged, leave the password blank and press "Next" button to skip this process.

On the next page as shown below, please select the WAN interface that you use. If Ethernet interface is used, please choose WAN1 or WAN2; if wireless 2.4G/5G connection is used, please choose WAN3 or WAN4; if 3G USB modem/LTE module is used, please choose WAN5/LTE or WAN6. Then click **Next** for next step. Each WAN interface will bring up specific configuration page.

#### Quick Start Wizard

---

##### WAN Interface

WAN Interface:	WAN1 ▾
Display Name:	<input type="text"/>
Physical Mode:	Ethernet
Physical Type:	Auto negotiation ▾
VLAN Tag insertion	Disable ▾

Click **Next**. You have to select the appropriate Internet access type (PPPoE, PPTP, L2TP, Static IP or DHCP) according to the information from your ISP.

Here we take PPPoE and DHCP modes for WAN connection as examples.

## For PPPoE Connection

1. Choose WAN1 as WAN Interface and click the Next button; you will get the following page.

Quick Start Wizard

---

Connect to Internet

**WAN 1**  
Select one of the following Internet Access types provided by your ISP.

- PPPoE
- PPTP
- L2TP
- Static IP
- DHCP

2. Select PPPoE and click Next to get the following page.

Quick Start Wizard

---

PPPoE Client Mode

**WAN 1**  
Enter the user name and password provided by your ISP.

Service Name (Optional)	<input type="text" value="CHTI"/>
Username	<input type="text" value="77554248@hinet.net"/>
Password	<input type="password" value="....."/>
Confirm Password	<input type="password" value="....."/>



3. Enter the Username/Password provided by your ISP. Then click **Next** for viewing the summary of such connection.

Quick Start Wizard

---

Please confirm your settings:

WAN Interface:	WAN1
Physical Mode:	Ethernet
Internet Access:	PPPoE

Click **Back** to modify changes if necessary. Otherwise, click **Finish** to save the current settings and restart the Vigor router.

< Back

Next >

Finish

Cancel

4. Click **Finish**. A page of **Quick Start Wizard Setup OK!!!** will appear. Then, the system status of this protocol will be shown.
5. Now, you can enjoy surfing on the Internet.

## For DHCP Connection

1. Choose WAN1 as WAN Interface and click the Next button; you will get the following page.

### Quick Start Wizard

---

#### Connect to Internet

**WAN 1**  
Select one of the following Internet Access types provided by your ISP.

- PPPoE
- PPTP
- L2TP
- Static IP
- DHCP

2. Select DHCP and click Next to get the following page.

### Quick Start Wizard

---

#### DHCP Client Mode

**WAN 1**  
If your ISP requires you to enter a specific host name or specific MAC address, please enter it in.

Host Name  (optional)

MAC       (optional)

3. Enter the hostname and / or MAC address provided by your ISP. Then click **Next** for viewing summary of such connection.

#### Quick Start Wizard

---

Please confirm your settings:

WAN Interface:	WAN1
Physical Mode:	Ethernet
Internet Access:	DHCP

Click **Back** to modify changes if necessary. Otherwise, click **Finish** to save the current settings and restart the Vigor router.

4. Click **Finish**. A page of **Quick Start Wizard Setup OK!!!** will appear. Then, the system status of this protocol will be shown.

#### Quick Start Wizard Setup OK!

5. Now, you can enjoy surfing on the Internet.

## 5. Customer Service

If the router cannot work correctly after trying many efforts, please contact your dealer for further help right away. For any questions, please feel free to send e-mail to [support@draytek.com](mailto:support@draytek.com).

### Be a Registered Owner

Web registration is preferred. You can register your Vigor router via <http://www.draytek.com>.

### Firmware & Tools Updates

Due to the continuous evolution of DrayTek technology, all routers will be regularly upgraded. Please consult the DrayTek web site for more information on newest firmware, tools and documents.

<http://www.draytek.com>