

Kensington®

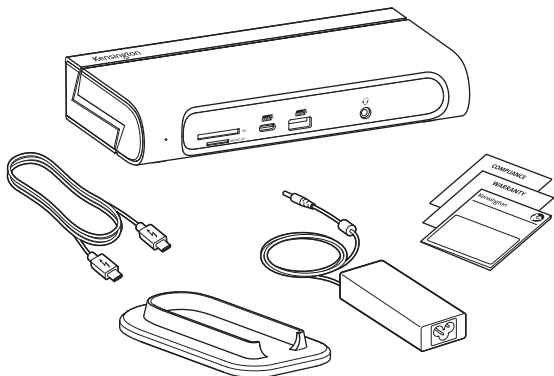

SD5600T Thunderbolt™ 3 and USB-C Dual 4K Hybrid Dock



NA/US

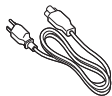

EU



AP/JP



[kensington.com/register](https://www.kensington.com/register)

1

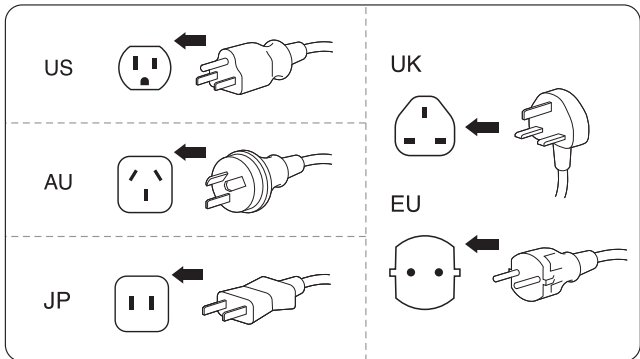
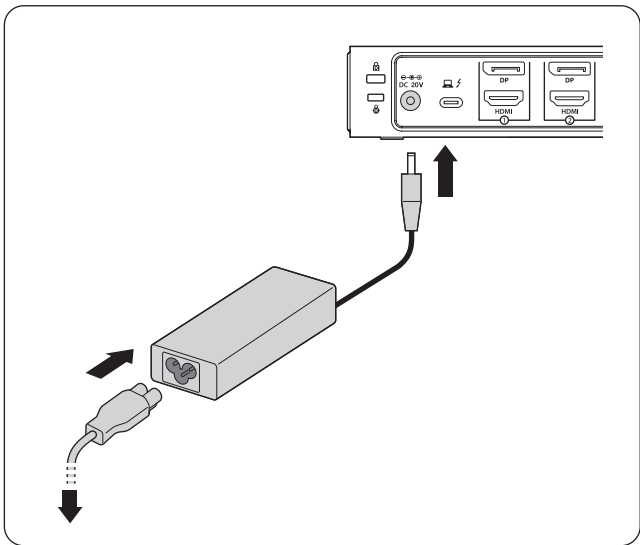

2

USB-C
USB 3.1 Gen2
10 Gbps (5V/1.5A)

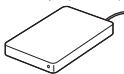

USB-A / USB 3.1 Gen2
10 Gbps / BC 1.2



BC 1.2 (5V/1.5A)*

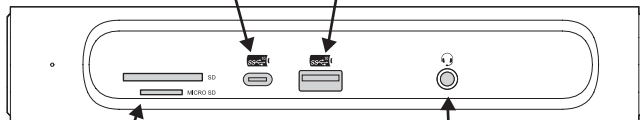

SD/Micro Card
Support SD4.0, UHS-II



* USB Battery Charging 1.2-compliant devices

Thunderbolt 3



Up to 100W



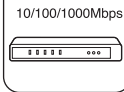
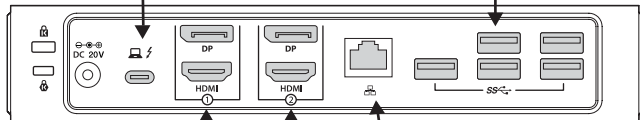
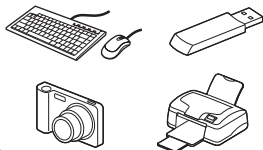

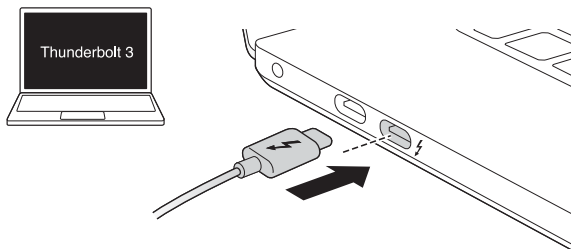
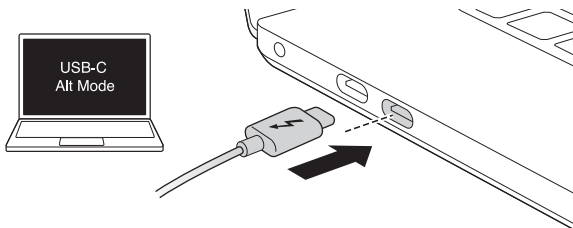
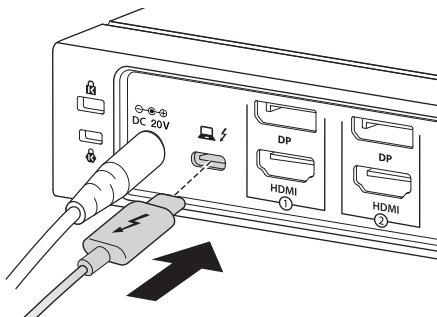
USB-A / USB 3.1 Gen1 / 5 Gbps (5V/0.9A)



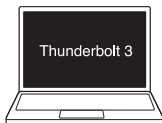





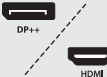
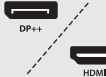

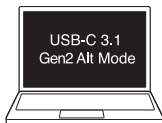
3**a****b****4**

5

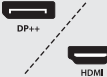

	1X 	2X  
		
HBR2 (DP-1.2)	3840*2160 @60HZ	3840*2160 @60HZ
HBR3 (DP-1.3)	3840*2160 @60HZ	3840*2160 @60HZ



	1X 	2X  		
				
HBR2 (DP-1.2)	3840*2160 @30HZ	1920*1080 @60HZ	1920*1080 @60HZ	1920*1080 @60HZ
HBR3 (DP-1.3)	3840*2160 @60HZ	2560*1440 @60HZ	2560*1440 @60HZ	2560*1440 @60HZ

6 Initial Thunderbolt 3 connection for Windows

New Thunderbolt™ device have been attached

Thunderbolt™ devices were attached. In order to approve them for use this application must be run with administrator privileges.

Click OK to run the Thunderbolt™ software with administrator privileges.

OK

Cancel

6.1 Manage Thunderbolt 3 devices and settings later



6.2

View Attached Devices
Approve Attached Devices >
Manage Approved Device

Settings
Exit



1

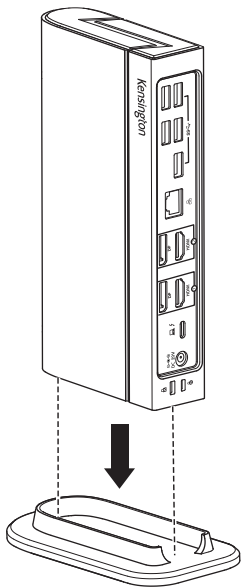

2

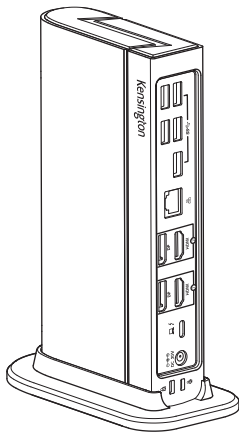

Sold separately

1

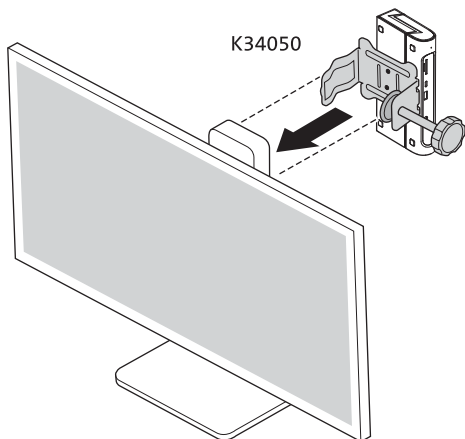

2

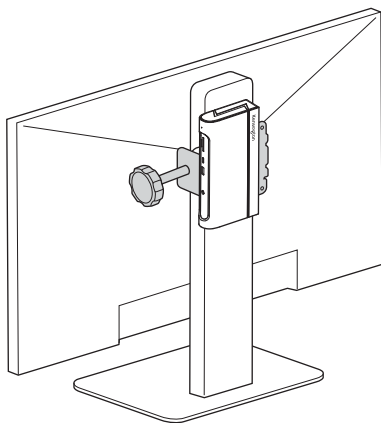

Sold separately

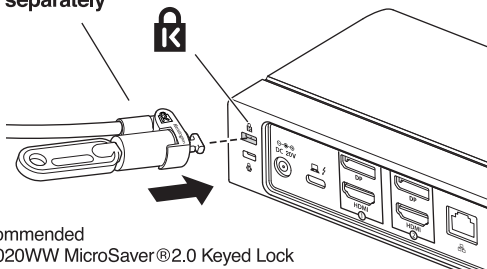

Recommended
K65020WW MicroSaver®2.0 Keyed Lock

Sold separately

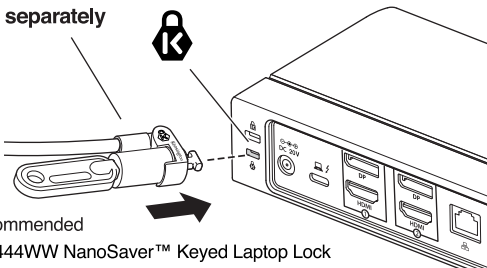

Recommended
K64444WW NanoSaver™ Keyed Laptop Lock

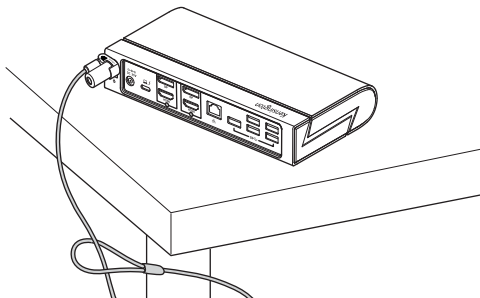

Kensington and the ACCO name and design are registered trademarks of ACCO Brands. All other registered and unregistered trademarks are the property of their respective owners. ©2020 Kensington Computer Products Group, a division of ACCO Brands. Any unauthorized copying, duplicating, or other reproduction of the contents hereof is prohibited without written consent from Kensington Computer Products Group. All rights reserved. 06/20



Kensington Computer Products Group
A Division of ACCO Brands
1500 Fashion Island Blvd, 3rd Floor
San Mateo, CA 94404, USA

Importer:

LEITZ ACCO Brands GmbH & Co KG
Siemensstraße 64
70469 Stuttgart
Germany

ACCO Brands Canada Inc

7381 Bramalea Rd
Mississauga, ON L5S 1C4
<https://accobrandscanada.com/>

ACCO Brands Australia - Kensington

2 Coronation Avenue
Kings Park NSW 2148
Australia

ACCO Brands Chile S.A.,

Avda. Presidente Riesco # 5711,
oficina 201
Las Condes, Santiago, Chile
CP 7561114
www.accobrand.cl

Importado e Distribuído por:

Tilbra Produtos De Papelaria Ltda.
CNPJ: 44.990.901/0001-43
Rua Aymorés, 6-9 – Bauru/SP – Brasil
CEP 17013-900
sac@tilbra.com.br

Dystrybutor:

Essekte Polska Sp. z o.o., ul.
Przemysłowa 11A, 26-900
Kozienice

Forgalmazza:

Essekte Kft, Váci út 76. V. torony
I. emelet,
1133 Budapest,
Magyarország

Distributor:

Essekte Sales SRL,
Gheorghe Țițeica 121C,
Sector 2, București,
România

Distribútor:

Essekte, s.r.o., V Lužích 818,
142 00 Praha 4,
Česká republika

Импортер:

ООО «Эссельте», Россия,
125040, Москва, 3-я улица
Ямского поля, д.18, тел.
+7(495)933-27-63

ДИСТРИБЬЮТОР:

Essekte Polska Sp. z o.o., ul.
Przemysłowa 11A, 26-900
Kozienice
Импорттаушы: "АБДИ Компани" АҚ,
Алматы қ., Сейфуллин даңғ. 465/191

Дистрибутор:

Эссельте Польска Сп. з о.о., вулиця
Пшемислова, 11А, 26-900 Козеніц

广州市爱珂贸易有限公司

广州市天河区林和西路159号
中泰国际北塔5楼, 501/701室
邮编: 510620
电话: 400 600 4599
网址: <https://www.kensington.com/zh-CN>
邮箱: infocn@kensington.com

アコ・ブランド・ジャパン株式会社

〒164-8721
東京都中野区本町1-32-2
ハーモニータワー14F
<https://www.kensington.com/ja-JP>
E-MAIL: JP.Kensington@acco.com