

TCL

2.0 Channel Home Theater Sound Bar

TS5000



User manual

Product Registration

Please register your purchase on-line at www.tcl.com. It will make it easier to contact you should it ever be necessary. Registration is not required for warranty coverage.

Product Information

Keep your sales receipt to obtain warranty parts and service and for proof of purchase. Attach it here and record the serial and model numbers in case you need them. These numbers are located on the product.

Model No. _____

Purchase Date _____

Serial No. _____

Dealer/Address/Phone _____

Contents

1	Important safety instructions	3
	Important information	3
	Important safety instructions	5

2	Welcome	10
	What's in the box	10
	Overview of the Sound Bar main unit	12
	Overview of the remote control	14
	Set up your Sound Bar system	15

3	Connect your Sound Bar system	21
	Connect with the optical cable	21
	Connect with the 3.5mm-to-3.5mm audio cable	23
	Connect your Sound Bar to power supply	24
	Connect the Sound Bar with your Bluetooth device	25
	Connect the IR pass-through cable	27

4	Use your Sound Bar system	28
	Use your Sound Bar with the top panel or remote control	28
	Sound settings	29
	Listen to music from your Bluetooth device	30
	Use the USB cable or device for music playback	31

5	Specifications	33
---	----------------	----

6	Notice	34
	Declaration of conformity	34
	Disposal of your old product and battery	34
	Trademarks	36

7	FAQ	37
---	-----	----

1 Important safety instructions

Important information



CAUTION

RISK OF ELECTRIC SHOCK
DO NOT OPEN



CAUTION: TO REDUCE THE RISK OF ELECTRIC SHOCK, DO NOT REMOVE COVER (OR BACK). NO USER-SERVICEABLE PARTS INSIDE. REFER SERVICING TO QUALIFIED SERVICE PERSONNEL.



The lightning flash with arrowhead symbol, within an equilateral triangle is intended to alert the user to the presence of uninsulated dangerous voltage within the

product's enclosure that may be of sufficient magnitude to constitute a risk of electric shock.



The exclamation point within an equilateral triangle is intended to alert the user to the presence of important operating and maintenance (servicing) instructions in the literature accompanying the product.



This symbol indicates that this product incorporates double insulation between hazardous main voltage and user accessible parts. When servicing, use only identical replacement parts.

Warnings

- *To reduce the risk of fire or electric shock, do not expose this product to rain or moisture. This product should not be exposed to dripping or splashing. No objects filled with liquids, such as vases, should be placed on or near the product.*
- *The product is unstable if it is not properly placed or mounted to the wall. Be sure to follow the wall mounting instructions provided in this user manual to ensure your safety.*
- *Do not expose batteries to excessive heat such as sunshine, fire, and so forth.*

Important safety instructions

- **Read these instructions** - Read all the safety and operating instructions before operating the product.
- **Retain these instructions** - Retain the safety and operating instructions for future reference.
- **Heed all warnings** - Adhere to all warnings on the product and in the operating instructions.
- **Follow all instructions** - Follow all operating and use instructions.
- **Do not use this apparatus near water** – The appliance should not be used near water or moisture – for example, in a wet basement or near a swimming pool and the like
- **Clean only with a dry cloth.**
- **Do not block any ventilation openings.** Install in accordance with the manufacturer's instructions.
- **Do not install near any heat sources** such as radiators, heat registers, stoves, or other apparatus (including amplifiers) that produce heat.
- **Do not defeat the safety purpose** of the polarized or grounding-type plug. A polarized plug has two blades with one wider than the other. A grounding type plug has two blades and a third grounding prong. The wide blade or the third prong are provided for your safety. If the provided plug does not fit into your outlet, consult an electrician for replacement of the obsolete outlet.
- **Protect the power cord** from being walked on or pinched particularly at plugs, convenience receptacles, and the point where it exits from the product.

- **Use only attachments/accessories** specified by the manufacturer.
- **Use only with the cart**, stand, tripod, bracket, or table specified by the manufacturer, or sold with the apparatus. When a cart is used, use caution when moving the cart/apparatus combination to avoid injury from tip-over.



- **Unplug this apparatus** during lightning storms or when unused for long periods of time.
- **Refer all servicing** to qualified service personnel. Servicing is required when the apparatus has been damaged in any way, such as power-supply cord or plug damaged, liquid has been spilled or objects have fallen into the apparatus, the apparatus has been exposed to rain or moisture, does not operate normally, or has been dropped.

Cautions

- To prevent electric shock, match wide blade of plug to wide slot, fully insert.
- The product shall not be exposed to dripping or splashing.
- Do not place any sources of danger on the product (for example: liquid filled objects, lighted candles).
- Disconnect the power cord to shut off when find trouble or not in use. The power cord shall be readily operable.
- Use of controls or adjustments or performance of procedures other than those described herein, may result in hazardous radiation exposure or other unsafe operation.
- The power cord/appliance coupler is used as the disconnect device, the disconnect device must remain readily operable.

Battery caution and disposal information

- Install only new batteries of the same type in your product.
- Failure to insert batteries in the correct polarity, as indicated in the battery compartment, may shorten the life of the batteries or cause batteries to leak.
- Do not mix old and new batteries.
- Do not use rechargeable (Nickel Cadmium) or (Nickel Metal Hydride) batteries.
- Do not mix alkaline, standard (Carbon-Zinc) or rechargeable (Nickel Cadmium) or (Nickel Metal Hydride) batteries.

- Do not dispose of batteries in fire or water.
- Recycle or dispose of batteries as per state and local guidelines.
- Danger of explosion if battery is incorrectly replaced. Replace only with the same or equivalent type.
- When the remote control is not to be used for a long time (more than a month), remove the battery from the remote control to prevent it from leaking.
- If the batteries leak, wipe away the leakage inside the battery compartment and replace the batteries with new ones.
- Keep away the batteries from heat or moisture.
- Do not carry or store batteries with other metallic objects. Doing so could cause batteries to short circuit, leak or explode.
- Do not carry or store batteries with other metallic objects. Doing so could cause batteries to short circuit, leak or explode.
- Never recharge a battery unless it is confirmed to be a rechargeable type.
- The product/remote control contains a coin/button type battery, which can be swallowed. Keep the battery out of reach of children at all times! If swallowed, the battery can cause serious injury or death. Severe internal burns can occur within two hours of ingestion.
- If you suspect that a battery has been swallowed or placed inside any part of the body, seek immediate medical attention.
- When you change the batteries, always keep all new and used batteries out of reach of children. Ensure that

the battery compartment is completely secure after you replace the battery.

- If the battery compartment cannot be completely secured, discontinue use of the product. Keep out of reach of children and contact the manufacturer.

Installation location

- This product is designed to sit on a firm, flat surface. Do not place the product on built-in installation such as a bookcase or rack because the ventilation slots around the product will be blocked, resulting in reduced lifetime from overheating. To assure adequate ventilation for this product, maintain a spacing of 7.8 inches (20cm) or more around the product.
- Make sure the product on the furniture is of adequate size and strength to prevent it from being accidentally tipped over, pushed off, or pulled off. This could cause personal injury and/or damage to the product.
- Installation of wall mount must be carried out by qualified personnel only. Incorrect assembly can result in severe personal injury and property damage (if you intend to install this product yourself, you must check for installations such as electrical wiring and plumbing that may be buried inside the wall). It is the installer's responsibility to verify that the wall will safely support the total load of the product and wall mount brackets.

2 Welcome

Congratulations on the purchase of your new TCL Sound Bar! After it is set up and connected, you can experience a superb sound quality and state-of-the-art design to best fit your home entertainment system. You are recommended to read through this user manual which helps you set up, connect and operate the product easily and properly. For more information, visit www.tcl.com

Let's get started.

What's in the box



Sound Bar main unit



IR pass-through cable

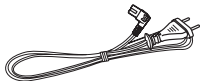

AC power cord

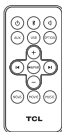

Remote control (with battery)



- Wall anchor x 4
- Silicone pad x 2
- Wall mount bracket x 2
- Wall bracket screw (M4)



Quick start guide



Wall mounting screw (M3) x 2







Warranty card

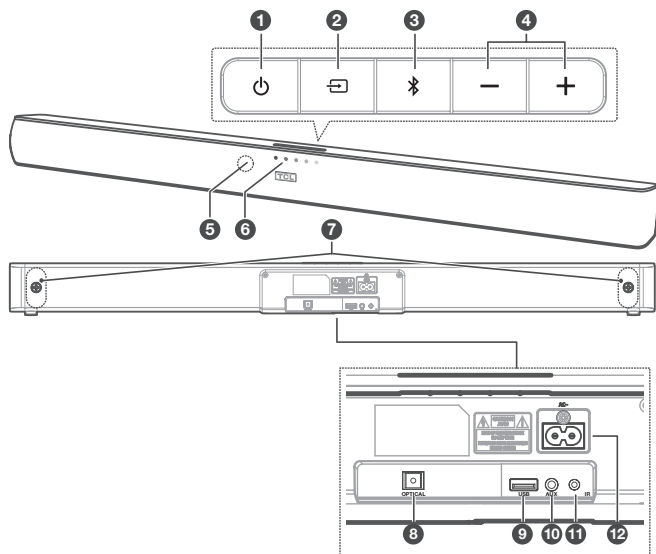

Wall mount template

Overview of the Sound Bar main unit





-  Press to turn the Sound Bar main unit on or to standby mode.
-  Press to switch the audio source among AUX/Bluetooth/Optical/USB modes.
-  Press to select the Bluetooth function.

- 4 **+/-**
Press to increase or decrease the volume level.
- 5 **Remote control sensor**
Receive signals from the remote control.
- 6 **LED indicators**
Red: in standby mode.
Green: in AUX mode.
Blue: in Bluetooth mode.
Orange: in Optical mode.
White: in USB mode.
- 7 **Wall bracket screws**
- 8 **Optical input connector**
- 9 **USB Type A connector (only for music playback)**
- 10 **AUX input connector**
- 11 **IR pass-through cable connector**
- 12 **AC input power connector**

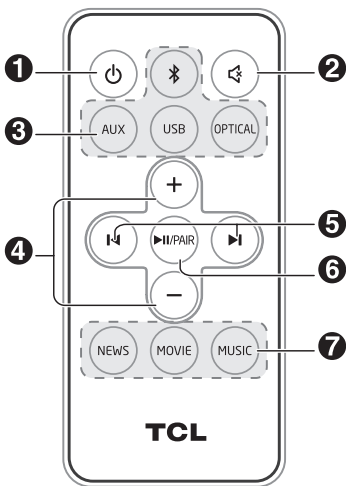
Overview of the remote control



- 1 
Press to turn the Sound Bar on or to standby mode.
- 2 
Press to mute or unmute the sound.
- 3 **Source buttons - AUX/OPTICAL/USB/**
Press to switch the audio source among different modes.
- 4 **+/-**
Press to increase or decrease the volume level.

- 5 **⏮/⏭**
Press to skip to previous/next track in Bluetooth/USB mode.
 - 6 **▶II/PAIR**
Play/pause/resume playback in Bluetooth/USB mode. Press and hold to activate the pairing function in Bluetooth mode or disconnect the paired Bluetooth device.
 - 7 **NEWS/MOVIE/MUSIC**
Press to select the equalizer (EQ) effect when you are watching **news** or **movies** or listening to **music**.
-

Set up your Sound Bar system

Notes

- Make sure you read all the safety information before you mount the Sound Bar main unit on the wall (see 'Important safety instructions' on page 5).
- Make sure you use screws and wall mount brackets provided or specified by the authorized manufacturer.
- TCL Entertainment Solutions Limited bears no responsibility for accidents or damage caused by improper wall mounting and screws installation or insufficient wall strength, etc.
- Additional tools (not supplied) are required for installation.

Mount your Sound Bar main unit on the wall

You can choose to place your Sound Bar main unit below the center of your TV or mount it on the wall.

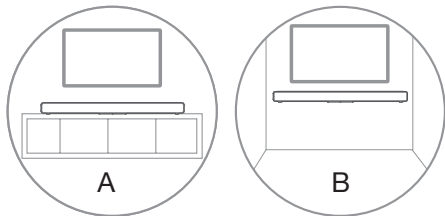

- 1 Place the supplied wall mount template on the wall. Make sure the wall mount template is at least 2 inches (5cm) below the center of the TV.
- 2 Use a level to make sure the Sound Bar is positioned accurately.
- 3 Use the tape to stick the wall mount template firmly on the wall.
- 4 Mark on the wall using each marking on the template on the template through the mounting holes.
- 5 Take away the wall mount template.
- 6 Drill a screw hole at each marking on the wall.

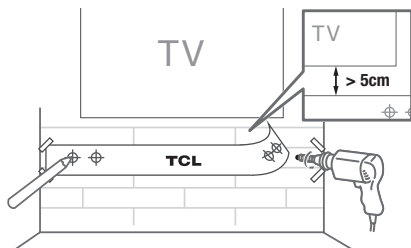

- 7 Insert the supplied wall anchors into 4 screw holes on the wall.
- 8 Insert the supplied wall bracket screws into the wall anchors.
- 9 Fix and tighten the wall bracket screws on the wall. Stick the silicone pads on the wall mount brackets when necessary to adjust the direction of the Sound Bar main unit.

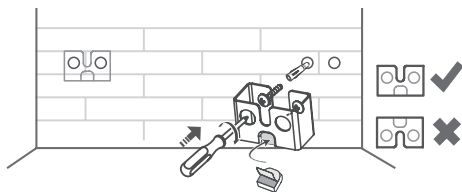

- 10** Replace the screws at the back of the Sound Bar main unit with the supplied wall mounting screws.

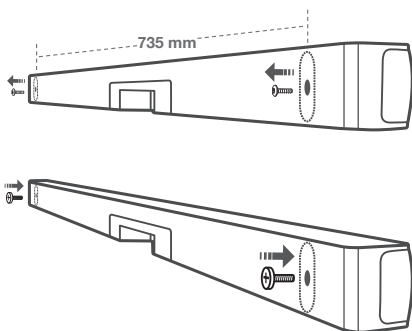

- 11** Hang the Sound Bar main unit on the wall mount brackets.

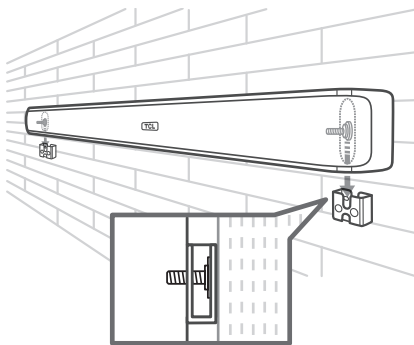

Notes

- Check the installation location before you mount the Sound Bar on the wall (see 'Installation location' on page 9).
- You may consider to connect the cables first before mounting the Sound Bar on the wall.

Activate the remote control

The battery is pre-installed in the remote control. For first time use, remove the battery protective tab from the battery door to activate battery connection.

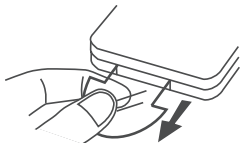

Replace the remote control battery

Warnings

- *Danger of explosion if battery is incorrectly replaced. Replace only with the same or equivalent type.*
- *The product/remote control may or may not contain a coin/button type battery, which can be swallowed. Keep the battery out of reach of children at all times!*

- 1 Open the battery compartment and remove the old battery.
- 2 Place a new lithium CR2025 battery into the battery compartment with the correct polarity (+/-).
- 3 Close the battery compartment.

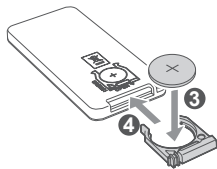
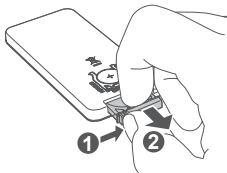

3 Connect your Sound Bar system

After you have fixed the position of the Sound Bar main unit, you can start connecting it to your TV or other devices and listen to the audio through your Sound Bar. Make sure you have muted the audio of your TV or device. For information, check the user manual of your TV or device.

Connect with the optical cable

- 1 Remove the protective caps from the optical cable (sold separately) when necessary.
- 2 Connect one end of the optical cable to the optical input connector on your Sound Bar main unit and another end to the optical output connector of your TV or device.

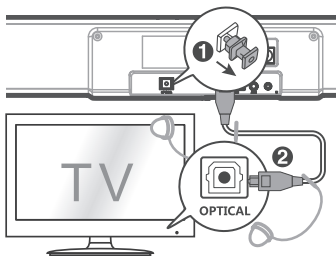

Note

- If there is no sound output from the Sound Bar main unit and the orange LED flashes rapidly, try to activate the PCM signal output on your TV or device. PCM is used to convert analog audio signals into digital audio signals in most devices. For more information of how to activate the PCM signal output, check the user manual of your TV or device.

Direction for setting up your Sound Bar using an optical cable



Do not bend or kink the optical cable (SPDIF) as it is fragile and can easily get damaged and broken.

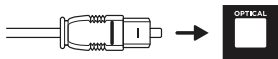

To get the best possible audio experience using the optical cable:

- 1 Press the **Settings** button on your TCL TV remote.
- 2 Navigate to Audio options.
- 3 Set TV speakers to **Off**.

Connect with the 3.5mm-to-3.5mm audio cable

You can either:

- connect one end of the 3.5mm-to-3.5mm audio cable (sold separately) to the AUX input connector on your Sound Bar main unit and another end to the headphone or audio output connector on your TV or device. This will disable the sound of your TV built-in speakers; or
- connect one end of an RCA-to-3.5mm audio cable (sold separately) to the AUX input connector on your Sound Bar main unit and other ends to the TV's audio output connectors.

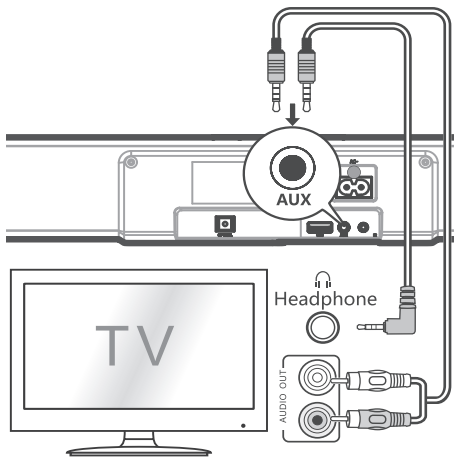

Connect your Sound Bar to power supply

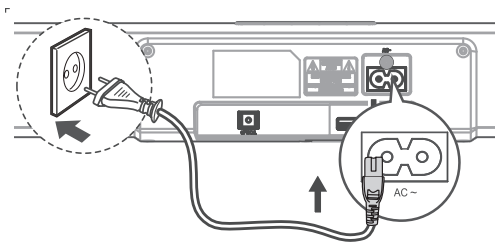

- 1 Make sure that you have completed all other connections before connecting the Sound Bar to power supply.
- 2 Make sure the power supply voltage complies with your country's safety standards (see 'Specifications' on page 39).
- 3 Connect one end of a supplied AC power cord to the AC input connector on your Sound Bar main unit and another end to the power socket on the wall.



Connect the Sound Bar with your Bluetooth device

Notes

- Make sure your wireless device supports the Bluetooth function.
- The operational range between the Sound Bar main unit and your Bluetooth device is approximately 10 meters (without any obstacle between the Bluetooth device and Sound Bar main unit).

- 1 Press  on the top panel of your Sound Bar main unit or remote control to power on the Sound Bar.
- 2 Press  on the top panel of your Sound Bar main unit or remote control.
 - The blue LED flashes slowly. The Sound Bar is ready to pair.
- 3 Power on your Bluetooth device and activate its Bluetooth function.
- 4 Select **TCL TS5000** on the pairing list of your Bluetooth device.
 - You hear distinct double beep sounds.
 - The blue LED remains on solidly when pairing is successful.

Tip

- If you cannot find the model name **TCL TS5000** on your Bluetooth device, press and hold **▶II/PAIR** on the remote control. You will see the blue LED flashes rapidly. Now the Sound Bar main unit is entering the pairing mode.

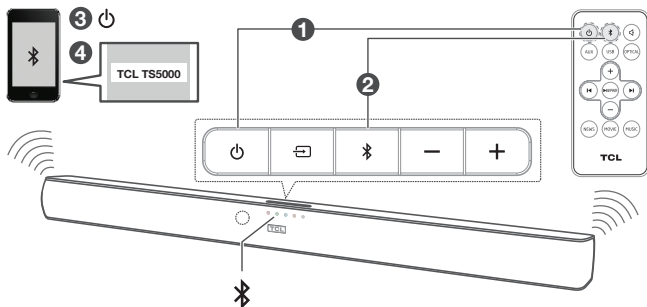

Your Sound Bar system is now set up and ready to use.

- 5 To disconnect the Bluetooth function, you can:
- press  on the Sound Bar main unit or the source buttons on the remote control to switch to another source; or
 - disable the Bluetooth function on your device; or
 - press and hold **▶II/PAIR** on the remote control.

Connect the IR pass-through cable

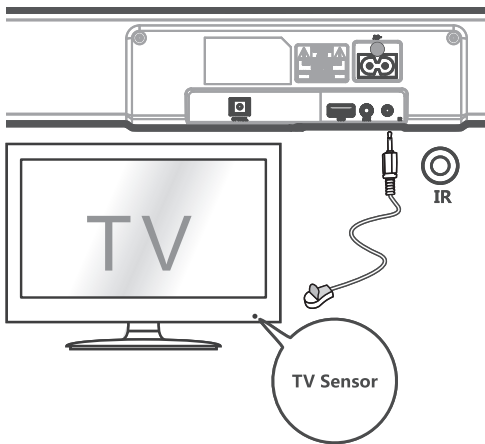

If the Sound Bar blocks the IR receiver of the TV when placing directly in front of it, you can connect the Sound Bar and TV with the supplied IR pass-through cable so that it can receive signal from the remote control of your TV.

Connect one end of the supplied IR pass-through cable to the IR pass-through cable connector on your Sound Bar main unit. Then, place another end with the IR blaster close to the TV sensor. For information, check the user manual of your TV.



4 Use your Sound Bar system

Use your Sound Bar with the top panel or remote control

- 1 Make sure the Sound Bar is properly connected to the power supply and sources.
- 2 Press  on the top panel of your Sound Bar main unit or remote control to power on the Sound Bar.
- 3 Press  on the top panel of your Sound Bar main unit or the source buttons on the remote control to switch to the correct source.

LED behaviors under different source modes

LED indicators	Sound Bar status
The red LED is on solidly.	in standby mode
The green LED is on solidly.	in AUX mode
The blue LED is on solidly.	in Bluetooth mode
The blue LED flashes slowly.	ready to pair
The blue LED flashes quickly.	pairing in progress
The orange LED is on solidly.	in optical mode
The white LED is on solidly.	in USB mode

Note

- After powering on your Sound Bar, if there is no operation performed on either the Sound Bar main unit or remote control within 15 seconds, all LED indicators on the Sound Bar main unit will turn off and light up again when the operation is resumed.

Tip

- You can use more advanced functions on the remote control (see 'Overview of the remote control' on page 14).

Sound settings

You can enjoy your movies or music with your ideal sound.

- Press **+/-** to adjust the volume.
- Press **⏏** on the remote control to mute the sound. Press **⏏** again to unmute the sound.
- Press the EQ buttons (**NEWS/MOVIE/MUSIC**) on the remote control to select the equalizer (EQ) effect when you are watching **news** or **movies** or listening to **music**.

Listen to music from your Bluetooth device

- 1 Make sure that your device supports A2DP and/or AVRCP. For information, check the specification of your device.
- 2 Pair your Bluetooth device with the Sound Bar main unit (see 'Connect the Sound Bar with your Bluetooth device' on page 25).
 - Start listening to music stored in your Bluetooth device through the Sound Bar. If your Bluetooth device supports A2DP, you can listen to music, but you cannot control the playback.
 - If your Bluetooth device supports AVRCP, you can listen to music and control music playback with the remote control. Press **▶II/PAIR** to pause or resume music playback. Press **◀ / ▶** to skip to the previous/next track.

Note

- The operational range between the Sound Bar and your Bluetooth device is approximately 10 meters (without any obstacle between the Bluetooth device and Sound Bar main unit).

Use the USB cable or device for music playback

- 1 Connect the USB device to the USB Type A connector on your Sound Bar main unit.
- 2 Press  on the Sound Bar main unit or **USB** on the remote control.
→ The white LED is on.
- 3 You can now listen to music through the Sound Bar.
 - To pause or resume music, press **▶/II/PAIR** on the remote control.
 - To skip to the previous or next track, press **◀** or **▶** on the remote control.

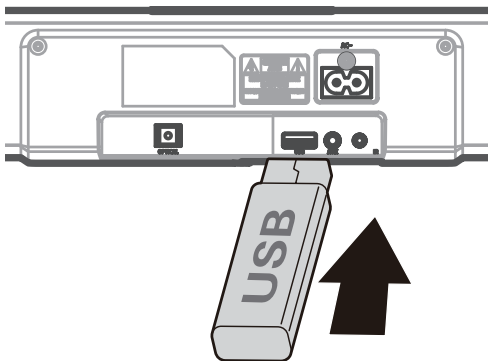

Operation	LED indicators
Listen to music.	The white LED is on.
Press ► to pause the music.	The white LED is on solidly.
Press ◀ or ▶ to skip to the previous/next track	The white LED is on solidly.

5 Specifications

Sound Bar main unit

- Power adapter: AC100-240V, 50/60Hz
- Power consumption: 25W
- Power consumption at standby mode: < 0.5W
- Impedance: 8 Ω
- Frequency response: 150 Hz-20 kHz
- Dimensions (W x H x D): 800 x 66 x 84 mm
- Weight: 1.5 kg
- Operating temperature: 0°C - 45°C

Bluetooth

- Bluetooth version: 4.2, Bluetooth profile - Bluetooth stereo supported (Advanced Audio Distribution Profile - A2DP; Audio Video Remote Control Profile - AVRCP)
- Frequency range: 2402 Mhz – 2480 Mhz
- Max transmitting power: 5dBm

Remote control

- Distance/Angle: 6m/ 30°
- Battery type: Lithium CR2025 battery (160 mAh) x 1, user replaceable.

Note

- Specifications are subject to change without notice.

6 Notice

Declaration of conformity

Hereby, TCL Entertainment Solutions Limited declares that this product is in compliance with the essential requirements and other relevant provisions of Directive 2014/53/EU. You can find the Declaration of Conformity on www.tcl.com.

Disposal of your old product and battery



Your product is designed and manufactured with high quality materials and components, which can be recycled and reused.



This symbol on a product means that the product is covered by European Directive 2012/19/EU.



This symbol means that the product contains a battery covered by European Directive 2013/56/EU which cannot be disposed of with normal household waste. Inform yourself about the local separate collection system for electrical and electronic products and batteries. Follow local rules and never dispose of the product and batteries with normal household waste. Correct disposal of old products and batteries helps prevent negative consequences for the environment and human health.

Remove the disposable battery

To remove the disposable batteries, see the section 'Replace the remote control battery'.

Environmental protection and sustainability

We have omitted all unnecessary packaging and make sure it is eco-friendly and sustainable.

Trademarks

Bluetooth



The Bluetooth® word mark and logos are registered trademarks owned by Bluetooth SIG, Inc. and any use of such marks by TCL Corporation under license. Other trademarks and trade names are those of their respective owners.

Dolby Audio



Manufactured under license from Dolby Laboratories. Dolby, Dolby Audio, and the double-D symbol are trademarks of Dolby Laboratories. Copyright 1992-2015 Dolby Laboratories. All rights reserved

7 FAQ

No power

- Make sure the AC power cord and AC input connector are connected properly.
- Make sure there is power supply.
- Make sure the Sound Bar has turned on.

No sound

- Make sure the audio cable is connected to the Sound Bar and your device.
- Make sure you have selected the correct source.
- Press **+** to increase the volume level.
- Make sure the Sound Bar is not muted.

The remote control does not work.

- Make sure you have selected the correct source.
- Make sure the distance of remote control and the Sound Bar main unit is within operational range.
- Make sure the battery is correctly inserted and is working.
- Make sure the remote control is close to the remote control sensor of the Sound Bar main unit.

I hear distorted sound.

- Make sure all cables are properly connected.
- Make sure you have selected the correct source.
- Make sure the TV is muted if you play audio from the TV.

I cannot find the Bluetooth name of this Sound Bar on my Bluetooth device.

- Make sure the Bluetooth function is activated on your Bluetooth device.
- Make sure the Sound Bar has paired with your Bluetooth device.

For further support, visit www.tcl.com/support

**WE ARE
READY TO
HELP** **contact us first
with any questions**



**TAKE CARE WHEN
REMOVING THE SOUNDBAR**

2019 © TCL Entertainment Solutions Limited.
All rights reserved. This product has been
manufactured by and is sold under the
responsibility of TCL Entertainment Solutions
Limited.

TS5000_EU_EN_UM_V1.0

