

# DS4608

Imaging Scanner



## Product Reference Guide



**ZEBRA**

---

## Copyright

ZEBRA and the stylized Zebra head are trademarks of Zebra Technologies Corporation, registered in many jurisdictions worldwide. All other trademarks are the property of their respective owners. ©2019-2020 Zebra Technologies Corporation and/or its affiliates. All rights reserved.

**COPYRIGHTS & TRADEMARKS:** For complete copyright and trademark information, go to [www.zebra.com/copyright](http://www.zebra.com/copyright).

**WARRANTY:** For complete warranty information, go to [www.zebra.com/warranty](http://www.zebra.com/warranty).

**END USER LICENSE AGREEMENT:** For complete EULA information, go to [www.zebra.com/eula](http://www.zebra.com/eula).

## For Australia Only

For Australia Only. This warranty is given by Zebra Technologies Asia Pacific Pte. Ltd., 71 Robinson Road, #05-02/03, Singapore 068895, Singapore. Our goods come with guarantees that cannot be excluded under the Australia Consumer Law. You are entitled to a replacement or refund for a major failure and compensation for any other reasonably foreseeable loss or damage. You are also entitled to have the goods repaired or replaced if the goods fail to be of acceptable quality and the failure does not amount to a major failure.

Zebra Technologies Corporation Australia's limited warranty above is in addition to any rights and remedies you may have under the Australian Consumer Law. If you have any queries, please call Zebra Technologies Corporation at +65 6858 0722. You may also visit our website: [www.zebra.com](http://www.zebra.com) for the most updated warranty terms.

---

## Terms of Use

- **Proprietary Statement**

This manual contains proprietary information of Zebra Technologies Corporation and its subsidiaries ("Zebra Technologies"). It is intended solely for the information and use of parties operating and maintaining the equipment described herein. Such proprietary information may not be used, reproduced, or disclosed to any other parties for any other purpose without the express, written permission of Zebra Technologies.

- **Product Improvements**

Continuous improvement of products is a policy of Zebra Technologies. All specifications and designs are subject to change without notice.

- **Liability Disclaimer**

Zebra Technologies takes steps to ensure that its published Engineering specifications and manuals are correct; however, errors do occur. Zebra Technologies reserves the right to correct any such errors and disclaims liability resulting therefrom.

- **Limitation of Liability**

In no event shall Zebra Technologies or anyone else involved in the creation, production, or delivery of the accompanying product (including hardware and software) be liable for any damages whatsoever (including, without limitation, consequential damages including loss of business profits, business interruption, or loss of business information) arising out of the use of, the results of use of, or inability to use such product, even if Zebra Technologies has been advised of the possibility of such damages. Some jurisdictions do not allow the exclusion or limitation of incidental or consequential damages, so the above limitation or exclusion may not apply to you.

## Revision History

Changes to the original guide are listed below:

Change	Date	Description
-01 Rev A	6/2019	Initial Release
-02 Rev A	7/2019	Changes from various Jira issues
-03EN Rev A	1/2020	- Added the fast blinking red LED indication in Table 4. - Updated the USB Cert information in Table 8, Table 9, and Table 10.
-04EN Rev A	6/2020	Updated: - 123Scan and Software Tools - Data Formatting: ADF, MDF, Preferred Symbol - Parameter 577 ISBT Concatenation.  Added Electronic Article Surveillance (EAS).
-05EN Rev A	12/2020	Added: - Hands-Free Decode Session Timeout - Data Parsing.

# Table of Contents

Copyright .....	2
For Australia Only .....	2
Terms of Use .....	2
Revision History .....	3
<b>About This Guide</b>	
Introduction .....	22
Configurations .....	22
Accessories .....	23
Chapter Descriptions .....	24
Notational Conventions .....	25
Related Documents and Software .....	25
Service Information .....	26
<b>Getting Started</b>	
Introduction .....	27
Interfaces .....	27
Unpacking .....	27
Features .....	28
Setting Up the Scanner .....	28
Inserting the Interface Cable .....	28
Removing the Interface Cable .....	29
Connecting Power (if required) .....	30
Configuring the Scanner .....	30
<b>123Scan and Software Tools</b>	
Introduction .....	31
123Scan .....	31
Communication with 123Scan .....	32
123Scan Requirements .....	32
123Scan Information .....	32
Scanner SDK, Other Software Tools, and Videos .....	33



**Data Capture**

Introduction ..... 34

Beeper Definitions ..... 34

LED Definitions ..... 36

Scanning ..... 37

    Scanning in Hands-Free (Presentation) Mode ..... 37

        Assemble the Stand ..... 37

        Mounting the Stand (optional) ..... 38

        Scanning with the Stand ..... 38

    Scanning in Hand-Held Mode ..... 39

    Aiming ..... 40

Decode Ranges ..... 41

Electronic Article Surveillance (EAS) ..... 42

    Installing ..... 42

        Checkpoint EAS Model Compatibility ..... 42

        Considerations ..... 43

        Checkpoint Contact Information ..... 43

**Maintenance, Troubleshooting, & Technical Specifications**

Introduction ..... 44

Maintenance ..... 44

    Known Harmful Ingredients ..... 44

    Approved Cleaners for the Imaging Scanner ..... 44

    Approved Disinfectant Cleaners for Healthcare Configurations of the DS4608 Scanners ..... 45

        Cleaning Agents Containing Active Ingredients ..... 45

        Brand Name Disinfectants ..... 45

    Cleaning the Imaging Scanner ..... 45

Troubleshooting ..... 46

Send Versions ..... 49

    Software Version ..... 49

    Serial Number ..... 49

    Manufacturing Information ..... 49

Technical Specifications ..... 50

Imaging Scanner Signal Descriptions ..... 57

**USB Interface**

Introduction ..... 59

Setting Parameters ..... 59

    Scanning Sequence Examples ..... 59

    Errors While Scanning ..... 60

Connecting a USB Interface ..... 60

USB Parameter Defaults ..... 61

USB Host Parameters ..... 62

    USB Device Type ..... 62

        Symbol Native API (SNAPI) Status Handshaking ..... 64

    USB Keystroke Delay ..... 65

    USB Caps Lock Override ..... 65

    Barcodes with Unknown Characters ..... 66

    USB Convert Unknown to Code 39 ..... 66

## Table of Contents

USB Fast HID .....	67
USB Polling Interval .....	68
Keypad Emulation .....	70
Quick Keypad Emulation .....	70
Keypad Emulation with Leading Zero .....	71
USB Keyboard FN1 Substitution .....	71
Function Key Mapping .....	72
Simulated Caps Lock .....	72
Convert Case .....	73
USB Static CDC .....	74
CDC Beep on <BEL> .....	74
TGCS (IBM) USB Direct I/O Beep .....	75
TGCS (IBM) USB Beep Directive .....	75
TGCS (IBM) USB Barcode Configuration Directive .....	76
TGCS (IBM) USB Specification Version .....	76
ASCII Character Sets .....	77

### SSI Interface

Introduction .....	78
Communication .....	78
SSI Commands .....	79
SSI Transactions .....	80
General Data Transactions .....	80
ACK/NAK Handshaking .....	80
Decoded Data Transmission .....	81
ACK/NAK Enabled and Packeted Data .....	81
ACK/NAK Enabled and Unpacketed ASCII Data .....	81
ACK/NAK Disabled and Packeted DECODE_DATA .....	82
ACK/NAK Disabled and Unpacketed ASCII Data .....	82
Communication Summary .....	83
RTS/CTS Lines .....	83
ACK/NAK Option .....	83
Number of Data Bits .....	83
Serial Response Timeout .....	83
Retries .....	83
Baud Rate, Stop Bits, Parity, Response Timeout, ACK/NAK Handshaking .....	83
Errors .....	83
SSI Communication Notes .....	84
Using Time Delay to Low Power Mode with SSI .....	84
Encapsulation of RSM Commands/Responses over SSI .....	85
Command Structure .....	85
Response Structure .....	85
Example Transaction .....	86
Command from Host to Query Packet Size Supported by Device .....	86
Response from Device with Packet Size Information .....	86
Command from Host to Retrieve Diagnostic Information .....	86
Response from Device with Diagnostic Information .....	86
Setting Parameters .....	87
Scanning Sequence Examples .....	87
Errors While Scanning .....	87

## Table of Contents

Simple Serial Interface Parameter Defaults .....	88
SSI Host Parameters .....	89
Select SSI Host .....	89
Baud Rate .....	89
Parity .....	91
Check Parity .....	91
Stop Bits .....	92
Software Handshaking .....	93
Host RTS Line State .....	94
Decode Data Packet Format .....	94
Host Serial Response Timeout .....	95
Host Character Timeout .....	96
Multipacket Option .....	97
Interpacket Delay .....	98
Event Reporting .....	99
Decode Event .....	99
Boot Up Event .....	100
Parameter Event .....	100
<b>RS-232 Interface</b>	
Introduction .....	101
Setting Parameters .....	101
Scanning Sequence Examples .....	102
Errors While Scanning .....	102
Connecting an RS-232 Interface .....	102
RS-232 Parameter Defaults .....	103
RS-232 Host-Specific Parameter Settings .....	104
RS-232 Host-Specific Code ID Characters .....	105
RS-232 Host Types .....	107
Baud Rate .....	109
Parity .....	111
Stop Bits .....	112
Data Bits .....	112
Check Receive Errors .....	113
Hardware Handshaking .....	113
Software Handshaking .....	115
Host Serial Response Timeout .....	117
RTS Line State .....	118
Beep on <BEL> .....	118
Intercharacter Delay .....	119
Nixdorf Beep/LED Options .....	120
Barcodes with Unknown Characters .....	120
ASCII Character Sets .....	121
<b>IBM 468X / 469X Interface</b>	
Introduction .....	122
Setting Parameters .....	122
Scanning Sequence Examples .....	122
Errors While Scanning .....	122

Connecting an IBM 468X/469X Host .....	123
IBM Parameter Defaults .....	124
IBM Host Parameters .....	125
Port Address .....	125
Convert Unknown to Code 39 .....	126
RS-485 Beep Directive .....	126
RS-485 Barcode Configuration Directive .....	127
IBM-485 Specification Version .....	127
<b>Keyboard Wedge Interface</b>	
Introduction .....	128
Setting Parameters .....	128
Scanning Sequence Examples .....	128
Errors While Scanning .....	129
Connecting a Keyboard Wedge Interface .....	129
Keyboard Wedge Parameter Defaults .....	130
Keyboard Wedge Host Parameters .....	131
Keyboard Wedge Host Types .....	131
Barcodes with Unknown Characters .....	131
Keystroke Delay .....	132
Intra-keystroke Delay .....	132
Alternate Numeric Keypad Emulation .....	133
Quick Keypad Emulation .....	133
Simulated Caps Lock .....	134
Caps Lock Override .....	134
Convert Case .....	135
Function Key Mapping .....	136
FN1 Substitution .....	136
Send Make and Break .....	137
Keyboard Map .....	137
ASCII Character Sets .....	137
<b>User Preferences &amp; Miscellaneous Options</b>	
Introduction .....	138
Setting Parameters .....	138
Scanning Sequence Examples .....	138
Errors While Scanning .....	138
User Preferences/Miscellaneous Options Parameter Defaults .....	139
User Preferences .....	142
Default Parameters .....	142
Write to Custom Defaults .....	142
Parameter Barcode Scanning .....	143
Beep After Good Decode .....	144
Beeper Volume .....	145
Beeper Tone .....	146
Beeper Duration .....	147
Suppress Power Up Beeps .....	148
LED on Good Decode .....	149
Direct Decode Indicator .....	149

## Table of Contents

Decode Pager Motor (DS4608-HC Only and DS4608-DPE)	150
Decode Pager Motor Duration (DS4608-HC Only)	151
Night Mode (DS4608-HC and DS4608-DPE Only)	153
Night Mode Trigger (DS4608-HC and DS4608-DPE Only)	154
Night Mode Toggle (DS4608-HC and DS4608-DPE Only)	154
Low Power Mode	155
Time Delay to Low Power Mode	156
Hand-held Trigger Mode	158
Hand-held Decode Aiming Pattern	159
Hands-free (Presentation) Decode Aiming Pattern	160
Hands-free Mode	161
Picklist Mode	162
Continuous Barcode Read	163
Unique Barcode Reporting	164
Decode Session Timeout	164
Hands-Free Decode Session Timeout	165
Timeout Between Decodes, Same Symbol	166
Timeout Between Decodes, Different Symbols	166
Triggered Timeout, Same Symbol	167
Mobile Phone/Display Mode	168
PDF Prioritization	169
PDF Prioritization Timeout	170
Presentation Mode Field of View	171
Decoding Illumination	172
Illumination Brightness	173
Motion Tolerance (Hand-held Trigger Modes Only)	174
Product ID (PID) Type	175
Product ID (PID) Value	175
ECLevel	176
DPM Parameters (DS4608-DPE Only)	177
DPM Illumination Control	177
DPM Mode	178
Miscellaneous Scanner Parameters	179
Enter Key	179
Tab Key	179
Transmit Code ID Character	180
Prefix/Suffix Values	181
Scan Data Transmission Format	182
FN1 Substitution Values	184
Transmit “No Read” Message	185
Unsolicited Heartbeat Interval	186
securPharm Decoding	187
securPharm Output Formatting	188
Sample GS1 Format	188
Sample IFA Format	189
securPharm Output Formatting Barcodes	190
<b>Image Capture Preferences</b>	
Introduction	191
Setting Parameters	191

## Table of Contents

Scanning Sequence Examples .....	192
Errors While Scanning .....	192
Image Capture Preferences Parameter Defaults .....	192
Image Capture Preferences .....	194
Operational Modes .....	194
Decode Mode .....	194
Snapshot Mode .....	194
Video Mode .....	194
Image Capture Illumination .....	195
Image Capture Autoexposure .....	195
Fixed Exposure .....	196
Analog and Digital Gain .....	197
Analog Gain .....	197
Digital Gain .....	197
Snapshot Mode Timeout .....	198
Snapshot Aiming Pattern .....	199
Silence Operational Mode Changes .....	199
Image Cropping .....	200
Crop to Pixel Addresses .....	200
Image Size (Number of Pixels) .....	202
Image Brightness (Target White) .....	203
JPEG Image Options .....	203
JPEG Quality Value .....	204
JPEG Size Value .....	204
Image Enhancement .....	205
Image File Format Selector .....	206
Image Rotation .....	207
Bits Per Pixel .....	208
Signature Capture .....	209
Signature Capture File Format Selector .....	210
Signature Capture Bits Per Pixel .....	211
Signature Capture Width .....	212
Signature Capture Height .....	212
Signature Capture JPEG Quality .....	213
Video Mode Format Selector .....	213
Video View Finder .....	214
Target Video Frame Size .....	214
Video View Finder Image Size .....	215
Video Resolution .....	215

### Symbologies

Introduction .....	216
Setting Parameters .....	216
Scanning Sequence Examples .....	217
Errors While Scanning .....	217
Symbology Parameter Defaults .....	217
Enable/Disable All Code Types .....	224
UPC/EAN/JAN .....	225
UPC-A .....	225
UPC-E .....	225

## Table of Contents

UPC-E1 .....	226
EAN-8/JAN-8 .....	226
EAN-13/JAN-13 .....	227
Bookland EAN .....	227
Bookland ISBN Format .....	228
ISSN EAN .....	229
Decode UPC/EAN/JAN Supplementals .....	230
User-Programmable Supplementals .....	233
UPC/EAN/JAN Supplemental Redundancy .....	233
UPC/EAN/JAN Supplemental AIM ID Format .....	234
Transmit UPC-A Check Digit .....	235
Transmit UPC-E Check Digit .....	235
Transmit UPC-E1 Check Digit .....	236
UPC-A Preamble .....	237
UPC-E Preamble .....	238
UPC-E1 Preamble .....	239
Convert UPC-E to UPC-A .....	240
Convert UPC-E1 to UPC-A .....	240
EAN/JAN Zero Extend .....	241
UCC Coupon Extended Code .....	241
Coupon Report .....	242
UPC Reduced Quiet Zone .....	243
Code 128 .....	243
Set Lengths for Code 128 .....	244
GS1-128 (formerly UCC/EAN-128) .....	245
ISBT 128 .....	246
ISBT Concatenation .....	247
Check ISBT Table .....	248
ISBT Concatenation Redundancy .....	248
Code 128 <FNC4> .....	249
Code 128 Security Level .....	250
Code 128 Reduced Quiet Zone .....	251
Code 39 .....	251
Trioptic Code 39 .....	252
Convert Code 39 to Code 32 .....	252
Code 32 Prefix .....	253
Set Lengths for Code 39 .....	253
Code 39 Check Digit Verification .....	255
Transmit Code 39 Check Digit .....	255
Code 39 Full ASCII Conversion .....	256
Code 39 Security Level .....	257
Code 39 Reduced Quiet Zone .....	259
Code 93 .....	259
Set Lengths for Code 93 .....	260
Code 11 .....	262
Set Lengths for Code 11 .....	262
Code 11 Check Digit Verification .....	264
Transmit Code 11 Check Digits .....	265
Interleaved 2 of 5 (ITF) .....	265
Set Lengths for Interleaved 2 of 5 .....	266
I 2 of 5 Check Digit Verification .....	268

## Table of Contents

Transmit I 2 of 5 Check Digit .....	268
Convert I 2 of 5 to EAN-13 .....	269
Febraban .....	269
I 2 of 5 Security Level .....	270
I 2 of 5 Reduced Quiet Zone .....	271
Discrete 2 of 5 (DTF) .....	271
Set Lengths for Discrete 2 of 5 .....	272
Codabar (NW - 7) .....	274
Set Lengths for Codabar .....	274
CLSI Editing .....	276
NOTIS Editing .....	276
Codabar Security Level .....	277
Codabar Upper or Lower Case Start/Stop Characters .....	278
Codabar Mod 16 Check Digit Verification .....	278
Transmit Codabar Check Digit .....	279
MSI .....	279
Set Lengths for MSI .....	280
MSI Check Digits .....	281
Transmit MSI Check Digit(s) .....	282
MSI Check Digit Algorithm .....	282
MSI Reduced Quiet Zone .....	283
Chinese 2 of 5 .....	283
Matrix 2 of 5 .....	284
Set Lengths for Matrix 2 of 5 .....	284
Matrix 2 of 5 Check Digit .....	286
Transmit Matrix 2 of 5 Check Digit .....	286
Korean 3 of 5 .....	287
Inverse 1D .....	288
GS1 DataBar .....	289
GS1 DataBar Omnidirectional (formerly GS1 DataBar-14) .....	289
GS1 DataBar Limited .....	289
GS1 DataBar Expanded .....	290
Convert GS1 DataBar to UPC/EAN/JAN .....	290
GS1 DataBar Security Level .....	291
GS1 DataBar Limited Margin Check .....	292
GS1 DataBar Expanded Security Level .....	293
Symbology-Specific Security Features .....	294
Redundancy Level .....	294
Security Level .....	296
1D Quiet Zone Level .....	297
Intercharacter Gap Size .....	298
Composite .....	299
Composite CC-C .....	299
Composite CC-A/B .....	299
Composite TLC-39 .....	300
Composite Inverse .....	300
UPC Composite Mode .....	301
Composite Beep Mode .....	302
GS1-128 Emulation Mode for UCC/EAN Composite Codes .....	303
2D Symbologies .....	304
PDF417 .....	304



## Table of Contents

MicroPDF417 .....	304
Code 128 Emulation .....	305
Data Matrix .....	306
GS1 Data Matrix .....	306
Data Matrix Inverse .....	307
Decode Data Matrix Mirror Images .....	308
Maxicode .....	309
QR Code .....	310
GS1 QR .....	310
MicroQR .....	311
Linked QR Mode .....	312
Aztec .....	313
Aztec Inverse .....	314
Han Xin .....	315
Han Xin Inverse .....	316
Grid Matrix .....	317
Grid Matrix Inverse .....	318
Grid Matrix Mirror .....	319
DotCode .....	320
DotCode Inverse .....	321
DotCode Mirrored .....	322
DotCode Prioritize .....	323
Macro PDF Features .....	323
Escape Characters .....	324
Flush Macro PDF Buffer .....	324
Abort Macro PDF Entry .....	324
Postal Codes .....	325
US Postnet .....	325
US Planet .....	325
Transmit US Postal Check Digit .....	326
UK Postal .....	326
Transmit UK Postal Check Digit .....	327
Japan Postal .....	327
Australia Post .....	328
Australia Post Format .....	329
Netherlands KIX Code .....	330
USPS 4CB/One Code/Intelligent Mail .....	330
UPU FICS Postal .....	331
Mailmark .....	331
<b>OCR Programming</b>	
Introduction .....	332
Setting Parameters .....	332
Scanning Sequence Examples .....	332
Errors While Scanning .....	333
OCR Parameter Defaults .....	333
OCR Programming Parameters .....	334
OCR-A .....	334
OCR-A Variant .....	335
OCR-B .....	337

## Table of Contents

OCR-B Variant .....	338
MICR E13B .....	342
US Currency Serial Number .....	343
OCR Orientation .....	343
OCR Lines .....	345
OCR Minimum Characters .....	345
OCR Maximum Characters .....	346
OCR Subset .....	346
OCR Quiet Zone .....	347
OCR Template .....	348
Required Digit (9) .....	348
Required Alpha (A) .....	348
Require and Suppress (0) .....	349
Optional Alphanumeric (1) .....	349
Optional Alpha (2) .....	349
Alpha or Digit (3) .....	350
Any Including Space & Reject (4) .....	350
Any except Space & Reject (5) .....	350
Optional Digit (7) .....	351
Digit or Fill (8) .....	351
Alpha or Fill (F) .....	351
Optional Space ( ) .....	352
Optional Small Special (.) .....	352
Other Template Operators .....	352
Repeat Previous (R) .....	356
Multiple Templates .....	357
Template Examples .....	357
OCR Check Digit Modulus .....	357
OCR Check Digit Multiplier .....	358
OCR Check Digit Validation .....	360
None .....	360
Product Add Left to Right .....	360
Digit Add Left to Right .....	361
Digit Add Right to Left .....	362
Product Add Right to Left Simple Remainder .....	362
Digit Add Right To Left Simple Remainder .....	363
Health Industry - HIBCC43 .....	364
Inverse OCR .....	365
OCR Redundancy .....	366
<b>Intelligent Document Capture (IDC)</b> .....	
Introduction .....	367
The IDC Process .....	367
Barcode Acceptance Test .....	368
Capture Region Determination .....	368
IDC Operating Mode = Anchored .....	368
IDC Operating Mode = Free-Form or Linked .....	369
Image Post Processing .....	369
Data Transmission .....	369
PC Application and Programming Support .....	369

# Table of Contents

Setting Parameters .....	369
Scanning Sequence Examples .....	370
Errors While Scanning .....	370
Image Document Capture Parameter Defaults .....	371
IDC Operating Mode .....	372
IDC Symbology .....	373
IDC X Coordinate .....	374
IDC Y Coordinate .....	374
IDC Width .....	375
IDC Height .....	375
IDC Aspect .....	376
IDC File Format Selector .....	376
IDC Bits Per Pixel .....	377
IDC JPEG Quality .....	378
IDC Find Box Outline .....	378
IDC Minimum Text Length .....	379
IDC Maximum Text Length .....	379
IDC Captured Image Brighten .....	380
IDC Captured Image Sharpen .....	381
IDC Border Type .....	382
IDC Delay Time .....	383
IDC Zoom Limit .....	383
IDC Maximum Rotation .....	384
Quick Start .....	385
Sample IDC Setup .....	385
IDC Demonstrations .....	386
Anchored Mode Demo .....	386
Free-Form Mode Demo .....	386
Linked Mode Demo .....	386
Other Suggestions .....	387
Quick Start Form .....	387
<b>Data Formatting: ADF, MDF, Preferred Symbol</b>	
Introduction .....	388
Advanced Data Formatting (ADF) .....	388
Multicode Data Formatting .....	388
MDF in Hands-Free Mode .....	389
MDF Best Practices .....	390
Preferred Symbol .....	391
Data Parsing (UDI Scan+, Label Parse+ and Blood Bag Parse+) .....	391
Scan a UDI Label using UDI Scan+ .....	391
Scan a GS1 Label using Label Parse+ .....	392
Scan a Blood Bag Label using Blood Bag Parse+ .....	392
<b>Driver's License Set Up (DSXXXX-DL)</b>	
Introduction .....	393
Driver's License Parsing .....	394
Parsing Driver's License Data Fields (Embedded Driver's License Parsing) .....	395
Embedded Driver's License Parsing Criteria - Code Type .....	395

## Table of Contents

Driver's License Parse Field Barcodes .....	396
AAMVA Parse Field Barcodes .....	399
Parser Version ID Barcode .....	409
User Preferences .....	409
Set Default Parameter .....	409
Output Gender as M or F .....	409
Date Format .....	410
No Separator .....	412
Send Keystroke (Control Characters and Keyboard Characters) .....	413
Control Characters .....	413
Keyboard Characters .....	418
Parsing Rule Example .....	434
Embedded Driver's License Parsing ADF Example .....	438
<b>Standard Parameter Defaults</b>	
Introduction .....	440
<b>Numeric Barcodes</b>	
Numeric Barcodes .....	455
Cancel .....	457
<b>Alphanumeric Barcodes</b>	
Cancel .....	458
Alphanumeric Barcodes .....	459
<b>ASCII Character Sets</b>	
<b>Programming Reference</b>	
Symbol Code Identifiers .....	487
AIM Code Identifiers .....	489
<b>Communication Protocol Functionality</b>	
Functionality Supported via Communication (Cable) Interface .....	494
<b>Country Codes</b>	
Introduction .....	496
USB and Keyboard Wedge Country Keyboard Types (Country Codes) .....	496
Country Code Barcodes .....	497
<b>Country Code Pages</b>	
Introduction .....	514
Country Code Page Defaults .....	514
Country Code Page Barcodes .....	518

**CJK Decode Control**

Introduction ..... 538

CJK Control Parameters ..... 539

    Unicode Output Control ..... 539

    CJK Output Method to Windows Host ..... 540

    Non-CJK UTF Barcode Output ..... 546

        Country Keyboard Type Missing Characters ..... 547

Unicode/CJK Decode Setup with Windows Host ..... 548

    Setting Up the Windows Registry Table for Unicode Universal Output ..... 548

    Adding CJK IME on Windows ..... 548

    Selecting the Simplified Chinese Input Method on the Host ..... 549

    Selecting the Traditional Chinese Input Method on the Host ..... 550

**Signature Capture Code**

Introduction ..... 551

Code Structure ..... 551

    Signature Capture Area ..... 551

    CapCode Pattern Structure ..... 552

Start / Stop Patterns ..... 552

Dimensions ..... 553

Data Format ..... 553

Additional Capabilities ..... 553

Signature Boxes ..... 554

**Non-Parameter Attributes**

Introduction ..... 555

Attributes ..... 555

    Model Number ..... 555

    Serial Number ..... 555

    Date of Manufacture ..... 556

    Date of First Programming ..... 556

    Configuration Filename ..... 556

    Beeper/LED ..... 557

    Parameter Defaults ..... 558

    Beep on Next Bootup ..... 558

    Reboot ..... 558

    Host Trigger Session ..... 558

    Firmware Version ..... 559

    Scankit Version ..... 559

**Sample Barcodes**

UPC/EAN ..... 560

    UPC-A, 100% ..... 560

    UPC-A with 2-digit Add-on ..... 560

    UPC-A with 5-digit Add-on ..... 561

    UPC-E ..... 561

    UPC-E with 2-digit Add-on ..... 561

    UPC-E with 5-digit Add-on ..... 562

## Table of Contents

EAN-8 .....	562
EAN-13, 100% .....	562
EAN-13 with 2-digit Add-on .....	563
EAN-13 with 5-digit Add-on .....	563
Code 128 .....	563
GS1-128 .....	564
Code 39 .....	564
Code 93 .....	564
Code 11 with 2 Check Digits .....	565
Interleaved 2 of 5 .....	565
MSI with 2 Check Digits .....	565
Chinese 2 of 5 .....	566
Matrix 2 of 5 .....	566
Korean 3 of 5 .....	566
GS1 DataBar .....	567
GS1 DataBar Omnidirectional (formerly GS1 DataBar-14) .....	567
GS1 DataBar Truncated .....	567
GS1 DataBar Stacked .....	567
GS1 DataBar Stacked Omnidirectional .....	568
GS1 DataBar Limited .....	568
GS1 DataBar Expanded .....	568
GS1 DataBar Expanded Stacked .....	569
2D Symbolologies .....	569
PDF417 .....	569
Data Matrix .....	569
GS1 Data Matrix .....	570
Maxicode .....	570
QR Code .....	570
GS1 QR .....	570
MicroQR .....	571
Aztec .....	571
Grid Matrix .....	571
Han Xin .....	572
Postal Codes .....	572
US Postnet .....	572
UK Postal .....	572
Japan Postal .....	572
Australian Post .....	573
OCR .....	573
OCR-A .....	573
OCR-B .....	573
MICR E13B .....	573
US Currency .....	574

# List of Figures

Figure 1. Parts of the Scanner . . . . .	28
Figure 2. Inserting the Cable . . . . .	29
Figure 3. Removing the Cable . . . . .	29
Figure 4. Assembling the Stand . . . . .	37
Figure 5. Mounting the Stand . . . . .	38
Figure 6. Inserting the Scanner in the Gooseneck Intellistand . . . . .	39
Figure 7. Centering the Aiming Dot on the Barcode . . . . .	39
Figure 8. Aiming Dot . . . . .	40
Figure 9. Scanning Orientation with Aiming Dot . . . . .	40
Figure 10. Acceptable Aiming . . . . .	40
Figure 11. Incorrect Aiming . . . . .	41
Figure 12. Imaging Scanner Cable Pinouts . . . . .	57
Figure 13. USB Connection . . . . .	60
Figure 14. RS-232 Connection . . . . .	102
Figure 15. IBM Connection . . . . .	123
Figure 16. Keyboard Wedge Connection . . . . .	129
Figure 17. IBM PS2 Type Keyboard . . . . .	137
Figure 18. Quick Start Form . . . . .	387
Figure 19. Scanning Label in a Horizontal Orientation . . . . .	389
Figure 20. Scanning Label in a Vertical Orientation . . . . .	390
Figure 21. Figure Match Setting for Output . . . . .	390
Figure 22. CapCode . . . . .	551
Figure 23. CapCode Structure . . . . .	552
Figure 24. Acceptable Signature Boxes . . . . .	554

# List of Tables

Table 1. Scanner Configurations	22
Table 2. Scanner Accessories	23
Table 3. Beeper Definitions	34
Table 4. Standard LED Definitions	36
Table 5. DS4608SR/DL/HD/HC Decode Ranges	41
Table 6. DS4608-DPE Decode Ranges	42
Table 7. Troubleshooting	46
Table 8. Technical Specifications - DS4608-SR/DS4608-DL/DS4608-HD/DS4608-HL	50
Table 9. Technical Specifications - DS4608-HC	52
Table 10. Technical Specifications - DS4608-DPE	55
Table 11. DS4608 Imaging Scanner Signal Pin-outs	58
Table 12. USB Interface Parameter Defaults	61
Table 13. SSI Commands	79
Table 14. Values for Selecting Time Delay to Low Power	84
Table 15. Command Structure	85
Table 16. Response Structure	85
Table 17. SSI Interface Default Table	88
Table 18. Event Codes	99
Table 19. RS-232 Interface Parameter Defaults	103
Table 20. RS-232 Host-Specific Settings	104
Table 21. RS-232 Host-Specific Settings	104
Table 22. RS-232 Host-Specific Code ID Characters	105
Table 23. RS-232 Host-Specific Code ID Characters	106
Table 24. IBM 468X/469X Interface Parameter Defaults	124
Table 25. Keyboard Wedge Interface Parameter Defaults	130
Table 26. User Preferences Parameter Defaults	139
Table 27. Image Capture Preferences Parameter Defaults	192
Table 28. Image Size	202
Table 29. Output File Format	210
Table 30. Resolution and Video Image Sizes	215
Table 31. Symbology Parameter Defaults	217
Table 32. OCR Programming Default Table	333
Table 33. Table of Numeric Value Assignments for Computing HIBC LIC Data Format Check Digit	364
Table 34. Intelligent Document Capture (IDC) Parameter Defaults	371
Table 35. IDC Symbologies	373
Table 36. DL Parsing Parameter Table	393
Table 37. Parameter Defaults	440
Table 38. ASCII Character Set	476
Table 39. ALT Key Character Set	481
Table 40. GUI Key Character Set	482
Table 41. PF Key Character Set	483
Table 42. F Key Character Set	484



## List of Tables

Table 43. Numeric Key Character Set . . . . .	485
Table 44. Extended Key Character Set . . . . .	485
Table 45. Symbol Code Characters . . . . .	487
Table 46. Aim Code Characters . . . . .	489
Table 47. Modifier Characters . . . . .	490
Table 48. Communication Interface Functionality . . . . .	494
Table 49. Country Code Page Defaults . . . . .	514
Table 50. Start / Stop Pattern Definitions . . . . .	552
Table 51. User Defined CapCode Parameters . . . . .	552
Table 52. Data Format. . . . .	553
Table 53. Beeper/LED Values . . . . .	557

# About This Guide

---

## Introduction

The DS4608 scanner Product Reference Guide provides general instructions for setting up, operating, maintaining, and troubleshooting the DS4608 scanner.

---

## Configurations

This guide includes the DS4608 scanner configurations listed in [Table 1](#).

**Table 1** Scanner Configurations

Part Number	Description
DS4608-SR00006ZZWW	Area Imager, Standard Range, White (Scanner Only)
DS4608-SR00007ZZWW	Area Imager, Standard Range, Twilight Black (Scanner Only)
DS4608-SR00007ZZAP	Area Imager, Standard Range, Twilight Black, APAC Only (Scanner Only)
DS4608-SR00007ZZY	Area Imager, Standard Range, Twilight Black, India Only (Scanner Only)
DS4608-DL00006ZZWW	Area Imager, Standard Range, White, Driver's License Parsing U.S. Only (Scanner Only)
DS4608-DL00007ZZWW	Area Imager, Standard Range, Twilight Black, Driver's License Parsing U.S. Only (Scanner Only)
DS4608-HD00007ZZWW	Area Imager, High Density, Twilight Black (Scanner Only)
DS4608-HD00007ZZAP	Area Imager, High Density, Twilight Black, APAC Only (Scanner Only)
DS4608-HD00007ZCWW	Area Imager, High Density, Twilight Black, Checkpoint EAS (Scanner Only)
DS4608-HC4000BZZWW	Area Imager, Healthcare, HC White (Scanner Only)
DS4608-HC4000BZZWW	Area Imager, Healthcare, HC White, APAC Only (Scanner Only)
DS4608-HL00007ZZWW	Area Imager, High Density, Twilight Black, Driver's License Parsing U.S. Only (Scanner Only)

**Table 1** Scanner Configurations (Continued)

Part Number	Description
DS4608-TT00007ZZJP	Area Imager, Standard Range, Twilight Black, Toshiba TEC (Scanner Only)
DS4608-DPE0007VZRW	Area Imager, Electronics DPM, Corded, White Illumination, Twilight Black, Vibration Motor - NA, LA, EMEA Only

## Accessories



**NOTE:** Check Solution Builder for additional information regarding all available accessories, and the latest available configurations.

The scanner ships with the DS4608 Quick Start Guide. The following required accessories must be ordered:

- Interface cable for the appropriate interface. For example, a shielded connector cable when connecting via USB.
- Universal power supply, if the interface requires this.
- Gooseneck Intellistand for hands-free operation of the DS4608.

The product configurations related to the DS4608 scanner are listed in [Table 2](#).

**Table 2** Scanner Accessories

Product Type	Part Number	Description
Cables	For information about cables, cable compatibility, and the full list of supported cables go to the Zebra Partner Portal at: <a href="https://partnerportal.zebra.com/PartnerPortal/product_services/downloads_z/barcode_scanners/Universal-Cable-Guide-Bar-Code-Scanners.xlsx">https://partnerportal.zebra.com/PartnerPortal/product_services/downloads_z/barcode_scanners/Universal-Cable-Guide-Bar-Code-Scanners.xlsx</a> .	
Stands and Holders (optional)	20-71043-04R (Black) 20-71043-0BR (HC White)	Gooseneck Intellistand
	STND-GS00UNC-04 (Black)	Universal Gooseneck Intellistand
	21-71043-04R (Black) 21-71043-0BR (HC White)	Cup
	STND-DC0081-04 (Black)	Document capture stand
	11-66553-06R (Twilight Black)	Wall Mount Hook
	20-70777-01R (Twilight Black)	Desk Holder

**Table 2** Scanner Accessories (Continued)

Product Type	Part Number	Description
Power Supplies (if required)	PWR-WUA5V4W0WW	5.2VDC, 1.1A, All WW Adapter Plugs, Level 6 Compliant
	PWR-WUA5V4W0US	5.2VDC, 1.1A, US Adapter Plug, Level 6 Compliant
	PWR-WUA5V4W0EU	5.2VDC, 1.1A, EU and UK Adapter Plug, Level 6 Compliant
	PWR-WUA5V4W0BR	5.2VDC, 1.1A, Brazil Adapter Plug, Level 6 Compliant
	PWR-WUA5V4W0CN	5.2VDC, 1.1A, China Adapter Plug, Level 6 Compliant
	PWR-WUA5V4W0IN	5.2VDC, 1.1A, India Adapter Plug, Level 6 Compliant
	PWR-WUA5V4W0AU	5.2VDC, 1.1A, Australia Adapter Plug, Level 6 Compliant

## Chapter Descriptions

Topics covered in this guide are as follows:

- [Getting Started](#) provides a product overview, unpacking instructions, and cable connection information.
- [123Scan and Software Tools](#) describes the Zebra software tools available for customizing scanner operation.
- [Data Capture](#) provides beeper and LED definitions, scanning instructions and tips, and decode ranges.
- [Maintenance, Troubleshooting, & Technical Specifications](#) provides suggested scanner maintenance, troubleshooting, technical specifications, and signal descriptions (pinouts).
- [USB Interface](#) describes how to set up the scanner with a USB host.
- [SSI Interface](#) describes the system requirements of the Simple Serial Interface (SSI), which provides a communications link between Zebra decoders and a serial host.
- [RS-232 Interface](#) describes how to set up the scanner with an RS-232 host.
- [IBM 468X / 469X Interface](#) describes how to set up the scanner with an IBM 468X/469X host.
- [Keyboard Wedge Interface](#) describes how to set up a keyboard wedge interface with the scanner.
- [User Preferences & Miscellaneous Options](#) describes each user preference feature and provides programming barcodes for selecting these features.
- [Image Capture Preferences](#) describes imaging preference features and provides programming barcodes for selecting these features.
- [Symbologies](#) describes all symbology features and provides programming barcodes for selecting these features.
- [OCR Programming](#) describes how to set up the scanner for OCR programming.
- [Intelligent Document Capture \(IDC\)](#) describes IDC, an advanced image processing firmware, including IDC functionality, parameter barcodes to control its features, and a quick start procedure.
- [Data Formatting: ADF, MDF, Preferred Symbol](#) describes the Zebra software tools available for customizing scanner operation.
- [Driver's License Set Up \(DSXXXX-DL\)](#) describes how to program the DSXXXX-DL scanner to read and use the data contained in the 2D barcodes on US driver's licenses and AAMVA compliant ID cards.
- [Standard Parameter Defaults](#) provides a table of all host and miscellaneous scanner defaults.

- [Numeric Barcodes](#) includes the numeric barcodes to scan for parameters requiring specific numeric values.
- [Alphanumeric Barcodes](#) includes the alphanumeric barcodes to scan for parameters requiring specific alphanumeric values.
- [ASCII Character Sets](#) provides tables for ASCII character values and other character sets.
- [Programming Reference](#) provides tables for Symbol code identifiers, AIM code identifiers, and modifier characters.
- [Communication Protocol Functionality](#) lists supported scanner functionality by communication protocol.
- [Country Codes](#) provides barcodes for programming the country keyboard type for the USB keyboard (HID) device and the keyboard wedge host.
- [Country Code Pages](#) provides barcodes for selecting code pages for the country keyboard type.
- [CJK Decode Control](#) describes control parameters for Unicode/CJK (Chinese, Japanese, Korean) barcode decode through USB HID Keyboard Emulation mode.
- [Signature Capture Code](#) describes CapCode, a special pattern that encloses a signature area on a document and allows the scanner to capture a signature.
- [Non-Parameter Attributes](#) defines non-parameter attributes.
- [Sample Barcodes](#) includes sample barcodes of various code types.

---

## Notational Conventions

The following conventions are used in this document:

- **Bold** text is used to highlight the following:
  - Parameter names and options
  - Parameter barcode captions
  - Dialog box, window and screen names
  - Drop-down list and list box names
  - Check box and radio button names
  - Icons on a screen
  - Key names on a keypad
  - Button names on a screen.
- Bullets (•) indicate:
  - Action items
  - Lists of alternatives
  - Lists of required steps that are not necessarily sequential.
- Sequential lists (e.g., those that describe step-by-step procedures) appear as numbered lists.

---

## Related Documents and Software

The following documents provide more information about the DS4608 scanner.

- DS4608 Quick Start Guide, p/n MN-003599-xx, provides general information for getting started with the DS4608 scanner, and includes basic set up and operation instructions.

- Advanced Data Formatting Programmer Guide, p/n 72E-69680-xx, provides information on ADF, a means of customizing data before transmission to a host.
- MDF and Preferred Symbol User Guide, p/n MN-002895-xx, provides information on Multicode Data Formatting (MDF), which enables a 2D imaging scanner to scan all barcodes on a label, and then modify and transmit the data to meet host application requirements.
- Attribute Data Dictionary, p/n 72E-149786-xx defines attribute numbers (device configuration parameters, monitored data, and born-on information) and describes management of various attribute domains for barcode scanners and OEM engines.
- Plural Stage Programmer's Guide, p/n 72E-67113-xx, provides the barcodes necessary to program the DS4608 scanner to decode Plural Stage barcodes and enable Supplemental Recognition Characters.
- Toshiba TEC Programmer's Guide, p/n MN-002707-xx, provides information on programming the Toshiba TEC USB device type.

For the latest version of this guide and all guides, go to: [zebra.com/support](http://zebra.com/support).

---

## Service Information

If you have a problem with your equipment, contact Zebra Global Customer Support for your region. Contact information is available at: [zebra.com/support](http://zebra.com/support).

When contacting support, please have the following information available:

- Serial number of the unit
- Model number or product name
- Software type and version number.

Zebra responds to calls by email, telephone or fax within the time limits set forth in support agreements.

If your problem cannot be solved by Zebra Customer Support, you may need to return your equipment for servicing and will be given specific directions. Zebra is not responsible for any damages incurred during shipment if the approved shipping container is not used. Shipping the units improperly can possibly void the warranty.

If you purchased your Zebra business product from a Zebra business partner, contact that business partner for support.

---

## Provide Documentation Feedback

If you have comments, questions, or suggestions about this guide, send an email to [EVM-Techdocs@zebra.com](mailto:EVM-Techdocs@zebra.com).

# Getting Started

---

## Introduction

Whether at your point of sale, on your production line, or in your hospital or other healthcare facility, the DS4600 Series has a scanner that meets your needs; capture a wide range of barcodes and data, on different surfaces, in different conditions, from different distances - all instantly and flawlessly. The DS4600 Series combines performance with versatility, focusing on the task at hand without worrying about capturing data. With the right DS4600 scanner for your environment, let the DS4608 capture your data.

---

## Interfaces

The DS4608 scanner supports:

- USB connection to a host. The scanner autodetects a USB host and defaults to the HID keyboard interface type. Select other USB interface types by scanning programming barcode menus. This interface supports the international keyboards (for Windows® environment) included in the chapter [Country Codes](#).
- Standard RS-232 connection to a host. Scan barcode menus to set up communication of the scanner with the host.
- Connection to IBM 468X/469X hosts. Scan barcode menus to set up communication of the scanner with the IBM terminal.
- Keyboard Wedge connection to a host. The host interprets scanned data as keystrokes. Scan barcode menus to set up communication of the scanner with the host. This interface supports the international keyboards (for Windows® environment) included in the chapter [Country Codes](#).

---

## Unpacking

Remove the digital scanner from its packing and inspect it for damage. If the scanner was damaged in transit, contact support. See [26](#) for information. **KEEP THE PACKING**. It is the approved shipping container; use this to return the equipment for servicing.

---

## Features

Figure 1 Parts of the Scanner

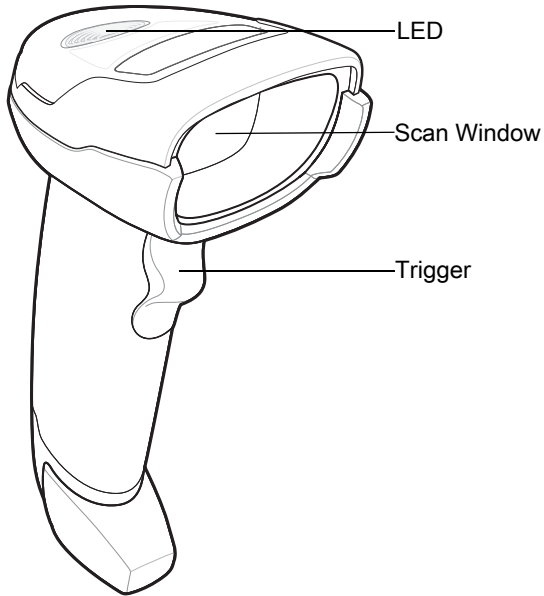

---

## Setting Up the Scanner

### Inserting the Interface Cable



**NOTE:** Different hosts require different cables. The connectors illustrated in each host chapter are examples only. Connectors vary from those illustrated, but the steps to connect the scanner are the same.

1. Insert the interface cable modular connector into the interface cable port on the rear of the digital scanner until you hear a click. Low/medium/high beeps sound, indicating the scanner is operational.



**Figure 2** Inserting the Cable

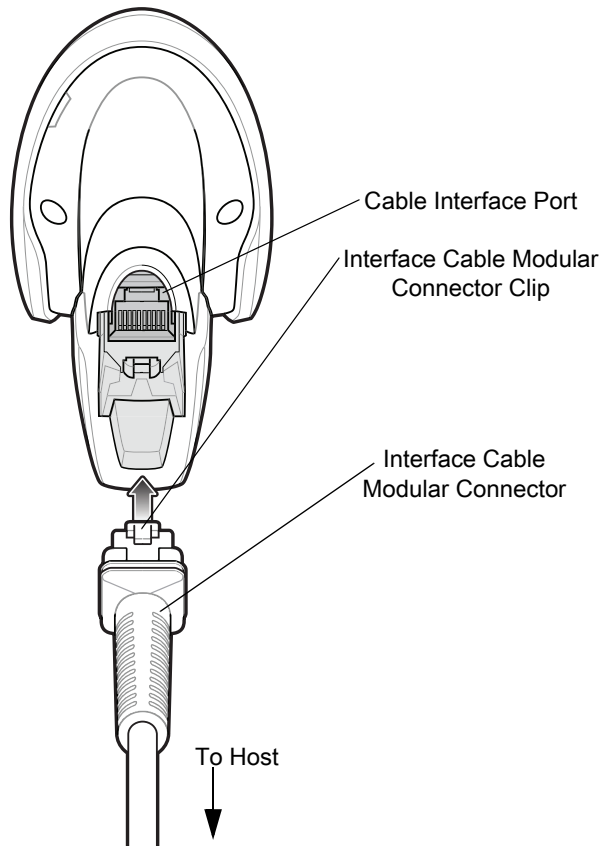

2. Gently tug the cable to ensure the connector is secure.
3. Connect the other end of the interface cable to the host (see the specific host chapter for information on host connections).

## Removing the Interface Cable

1. Press the cable's modular connector clip through the access slot in the digital scanner's base.

**Figure 3** Removing the Cable

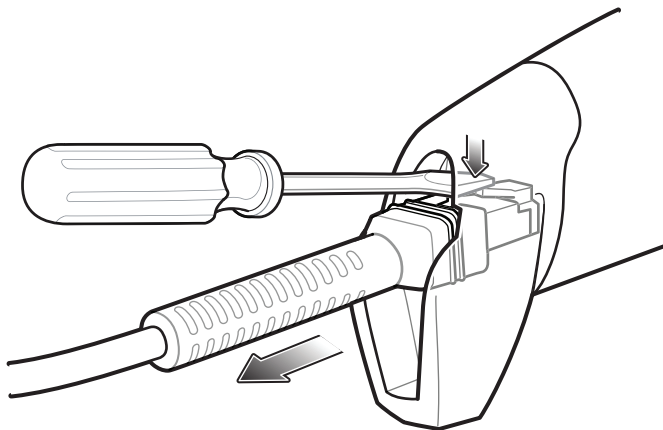

2. Carefully slide out the cable.
3. Follow the steps for [Inserting the Interface Cable](#) to connect a new cable.

### Connecting Power (if required)

If the host does not provide power to the digital scanner, connect an external power supply.

1. Connect the interface cable to the base of the scanner, as described in [Inserting the Interface Cable on page 28](#).
2. Connect the other end of the interface cable to the host (refer to the host manual to locate the correct port).
3. Plug the power supply into the power jack on the interface cable. Plug the other end of the power supply into an AC outlet.

### Configuring the Scanner

To configure the scanner use the barcodes included in this manual or use the 123Scan configuration program. See each host-specific chapter to set up a connection to a specific host type.

# 123Scan and Software Tools

---

## Introduction

This chapter briefly describes the Zebra software tools available for customizing scanner operation.

---

## 123Scan

123Scan is a software tool that simplifies scanner setup and more.

Intuitive enough for first time users, the 123Scan wizard guides users through a streamlined setup process. Settings are saved in a configuration file that can be printed as a single programming barcode for scanning, emailed to a smart phone for scanning from its screen, or downloaded to the scanner using a USB cable.

Through 123Scan a user can:

- Configure a scanner using a wizard.
  - Program the following scanner settings.
    - Beeper tone / volume settings.
    - Enable / disable symbologies.
    - Communication settings.
  - Modify data before transmission to a host using:
    - Advanced Data Formatting (ADF) - Scan one barcode per trigger pull.
    - Multicode Data Formatting (MDF) - Scan many barcodes in one trigger pull (select scanners).
    - Preferred Symbol - Single out one barcode on label of many (select scanners).
- Load parameter settings to a scanner via the following.
  - Barcode scanning.
    - Scan a paper barcode.
    - Scan a barcode from a PC screen.
    - Scan a barcode from a smart phone screen.
  - Download over a USB cable.
    - Load settings to one scanner.
    - Stage up to 10 scanners simultaneously (Powered USB Hub recommended with 0.5 amp / port).

- Validate scanner setup.
  - View scanned data within the utility's **Data** view screen.
  - Capture an image and save to a PC within the utility's **Data** view screen.
  - Review settings using the Parameter Report.
  - Clone settings from an already deployed scanner from the **Start** screen.
- Upgrade scanner firmware.
  - Load settings to one scanner.
  - Stage up to 10 scanners simultaneously (Powered USB Hub recommended with 0.5 amp / port).
- View statistics such as:
  - Asset tracking information.
  - Time and usage information.
  - Barcodes scanned by symbology.
  - Battery diagnostics (select scanners).
- Generate the following reports.
  - Barcode Report - Programming barcode, included parameter settings, and supported scanner models.
  - Parameter Report - Parameters programmed within a configuration file.
  - Inventory Report - Scanner asset tracking information.
  - Validation Report - Scanned data from the **Data** view.
  - Statistics Report - All statistics retrieved from the scanner.

For more information go to: <http://www.zebra.com/123Scan>.

## Communication with 123Scan

Use a USB cable to connect the scanner to a Windows host computer running 123Scan.

## 123Scan Requirements

- Host computer running Windows 7, 8, and 10
- Scanner
- USB cable.

## 123Scan Information

For more information on 123Scan, go to: <http://www.zebra.com/123Scan>

For a 1 minute tour of 123Scan, go to: <http://www.zebra.com/ScannerHowToVideos>

To see a list of all of our software tools, go to: <http://www.zebra.com/scannersoftware>

## Scanner SDK, Other Software Tools, and Videos

Tackle all your scanner programming needs with our diversified set of software tools. Whether you need to simply stage a device, or develop a fully featured application with image and data capture as well as asset management, these tools help you every step of the way.

To download any of the following free tools, go to: <http://www.zebra.com/scannersoftware>.

- 123Scan configuration utility
- SDKs
  - Scanner SDK for Windows
  - Scanner SDK for Linux
  - Scanner SDK for Android
- Drivers
  - OPOS driver
  - JPOS driver
  - USB CDC driver
  - TWAIN driver
- Scanner Management Service (SMS) for Remote Management
  - Windows
  - Linux
- How-To-Videos



**NOTE:** For a list of SDK supported scanner functionality by communication protocol, see [Communication Protocol Functionality](#).

# Data Capture

---

## Introduction

This chapter provides beeper and LED definitions, techniques involved in scanning barcodes, general instructions and tips about scanning, and decode ranges.

---

## Beeper Definitions

The digital scanner issues different beep sequences and patterns to indicate status. [Table 3](#) defines beep sequences that occur during both normal scanning and while programming the digital scanner.

**Table 3** Beeper Definitions

Beeper Sequence	Indication
<b>Standard Use</b>	
Low/medium/high beeps	Power up.
Short beep, tone programmable	A barcode symbol was decoded (if decode beeper is enabled).
4 long low beeps	Transmission error.
5 low beeps	Conversion or format error.
Low/low/low/extra low beeps	RS-232 receive error.
High beep	The digital scanner detected a <BEL> character over RS-232.
<b>Parameter Menu Scanning</b>	
Low/high beeps	Input error; incorrect barcode, programming sequence, or <b>Cancel</b> scanned.
High/low beeps	Keyboard parameter selected. Enter value using numeric barcodes.
High/low/high/low beeps	Successful program exit with change in parameter setting.
<b>ADF Programming</b>	
Low/low beeps	Enter another alphabetic character or scan the <b>End of Message</b> barcode.
Low/high/high beeps	All rules are deleted.
Low/high/low/high beeps	Out of rule memory. Erase some existing rules, then try to save rule again.

**Table 3** Beeper Definitions (Continued)

Beeper Sequence	Indication
Low/high/low beeps	Cancel rule entry. Rule entry mode exited because of an error or the user asked to exit rule entry.
Low/high beeps	Entry error, wrong barcode scanned, or criteria/action list is too long for a rule. Re-enter criterion or action.
Low beep	Delete last saved rule. The current rule is left intact.
High/high beeps	ADF criteria or action is expected. Enter another criterion or action, or scan the <b>Save Rule</b> barcode.
High/low/low beeps	All criteria or actions cleared for current rule, continue entering rule.
High/low/high/low beeps	Rule saved. Rule entry mode exited.
<b>Macro PDF</b>	
2 low beeps	MPDF sequence buffered.
2 long low beeps	File ID error. A barcode not in the current MPDF sequence was scanned.
3 long low beeps	Out of memory. There is not enough buffer space to store the current MPDF symbol.
4 long low beeps	Bad symbology. Scanned a 1D or 2D barcode in a MPDF sequence, a duplicate MPDF label, a label in an incorrect order, or trying to transmit an empty or illegal MPDF field.
5 long low beeps	Flushing MPDF buffer.
Low/high beeps	Flushing an already empty MPDF buffer.
Fast warble beep	Aborting MPDF sequence.
<b>Host Specific</b>	
<b>USB only</b>	
Low/medium/high beeps upon scanning a USB device type	Communication with the host must be established before the digital scanner can operate at the highest power level.
Low/medium/high beeps occur more than once	The USB host can put the digital scanner in a state where power to the scanner is cycled on and off more than once. This is normal and usually happens when the PC cold boots.
<b>RS-232 only</b>	
1 short high beep	A <BEL> character is received and Beep on <BEL> is enabled.

## LED Definitions

In addition to beep sequences, the digital scanner uses a two-color LED to indicate status. [Table 4](#) defines LED colors that display during scanning.

**Table 4** Standard LED Definitions

LED	Indication
<b>Hand-Held Scanning Standard Use</b>	
Green	A barcode was successfully decoded.
Red	Transmission error, conversion or format error, or RS-232 receive error.
Off	No power is applied to the digital scanner, or the scanner is on and ready to scan.
Fast Blinking Red	The scanner is disabled by a host command to the scanner.
<b>Hands-Free (Presentation) Scanning Standard Use</b>	
Green	The scanner is on and ready to scan.
Momentarily Off	A barcode was successfully decoded.
Red	Transmission error, conversion or format error, or RS-232 receive error.
Off	No power is applied to the digital scanner, or the scanner is in low power mode.
<b>Parameter Programming</b>	
Green	Number expected. Enter value using numeric barcodes. Successful program exit with change in parameter setting.
Red	Input error: incorrect barcode, programming sequence, or Cancel scanned.
<b>Firmware Update</b>	
Red, alternating between solid and fast blinking	Firmware download is completing (user should wait for this indicator to complete before using the scanner). This indicator is followed by a low/medium/high power up beep.
<b>ADF Programming</b>	
Green	Enter another digit. Add leading zeros to the front if necessary. Enter another alphabetic character or scan the <b>End of Message</b> barcode. All criteria or actions cleared for current rule, continue entering rule. Delete last saved rule. The current rule is left intact. All rules deleted.
Blinking Green	Enter another criterion or action, or scan the <b>Save Rule</b> barcode.
Green after Blinking	Rule saved. Rule entry mode exited. Cancel rule entry. Rule entry mode exited because of an error or the user asked to exit rule entry.
Red	Out of rule memory. Erase some existing rules, then try to save rule again. Entry error, wrong barcode scanned, or criteria/action list is too long for a rule. Re-enter criterion or action.



## Scanning

The DS4608 digital scanner is in hands-free (presentation) mode when it is placed in the gooseneck Intellistand. In this mode, the digital scanner operates in continuous (constant-on) mode, where it automatically decodes a barcode presented in its field of view.

When the digital scanner is not used for a user-definable period of time, it enters a low power mode in which the LEDs are turned off or illumination blinks at a low duty cycle until the digital scanner detects an image change (e.g. motion).

### Scanning in Hands-Free (Presentation) Mode

The optional stand adds greater flexibility to DS4608 scanning operation. When the scanner is seated in the stand's "cup," the scanner's built-in sensor places the scanner in hands-free (presentation) mode. When the scanner is removed from the stand, it automatically switches to its programmed hand-held triggered mode.

#### Assemble the Stand

To assemble the stand:

1. Unscrew the wing nut from the bottom of the one piece scanner "cup."

**Figure 4** Assembling the Stand

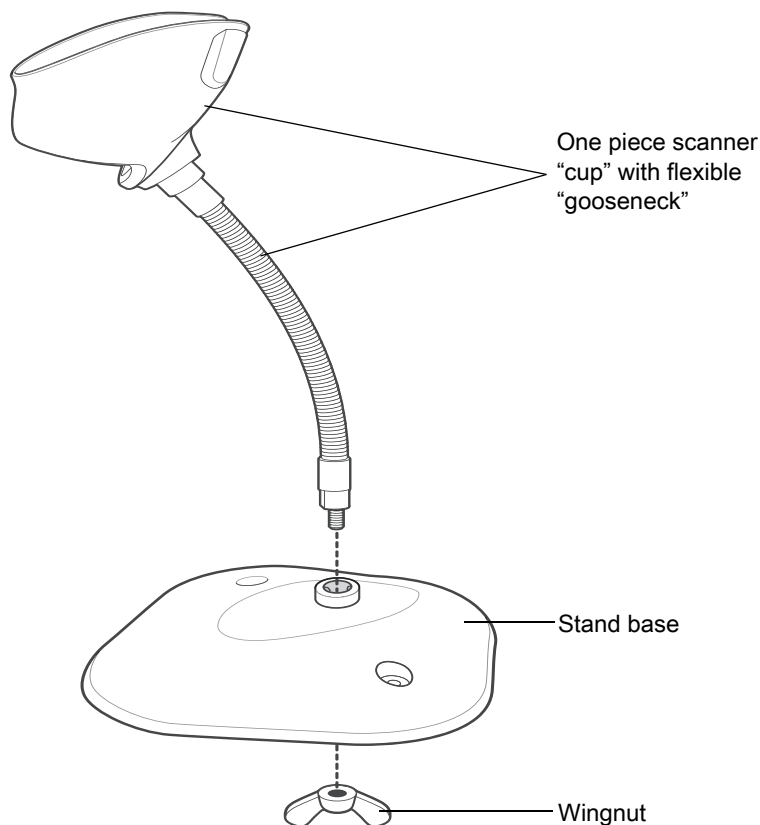

2. Fit the bottom of the gooseneck piece into the opening on the top of the stand base.
3. Tighten the wing nut underneath the base to secure the cup and neck piece to the base.
4. Bend the neck to the desired position for scanning.

## Mounting the Stand (optional)

You can attach the base of the scanner's stand to a flat surface using two screws or double-sided tape (not provided).

**Figure 5** Mounting the Stand

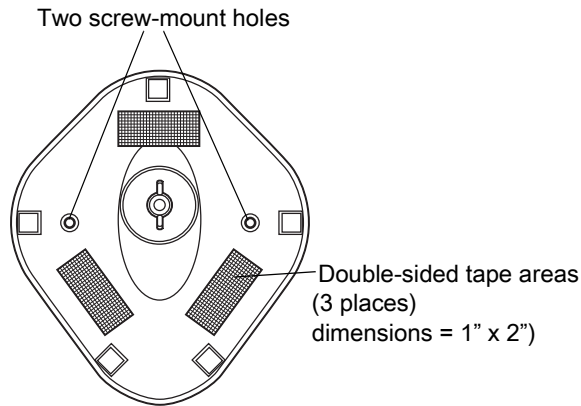

### Screw Mount

1. Position the assembled base on a flat surface.
2. Screw one #10 wood screw into each screw-mount hole until the base of the stand is secure (see [Figure 5](#)).

### Tape Mount

1. Peel the paper liner off one side of each piece of tape and place the sticky surface over each of the three rectangular tape holders.
2. Peel the paper liner off the exposed sides of each piece of tape and press the stand on a flat surface until it is secure (see [Figure 5](#)).

## Scanning with the Stand

When the digital scanner is placed in the gooseneck Intellistand it operates in continuous (constant-on) mode, where it automatically decodes a barcode presented in its field of view.

To operate the scanner in the stand:

1. Ensure the scanner is properly connected to the host (see the appropriate host chapter for information on host connections).
2. Insert the scanner in the gooseneck Intellistand by placing the front of the scanner into the stand's "cup."

**Figure 6** Inserting the Scanner in the Gooseneck Intellistand

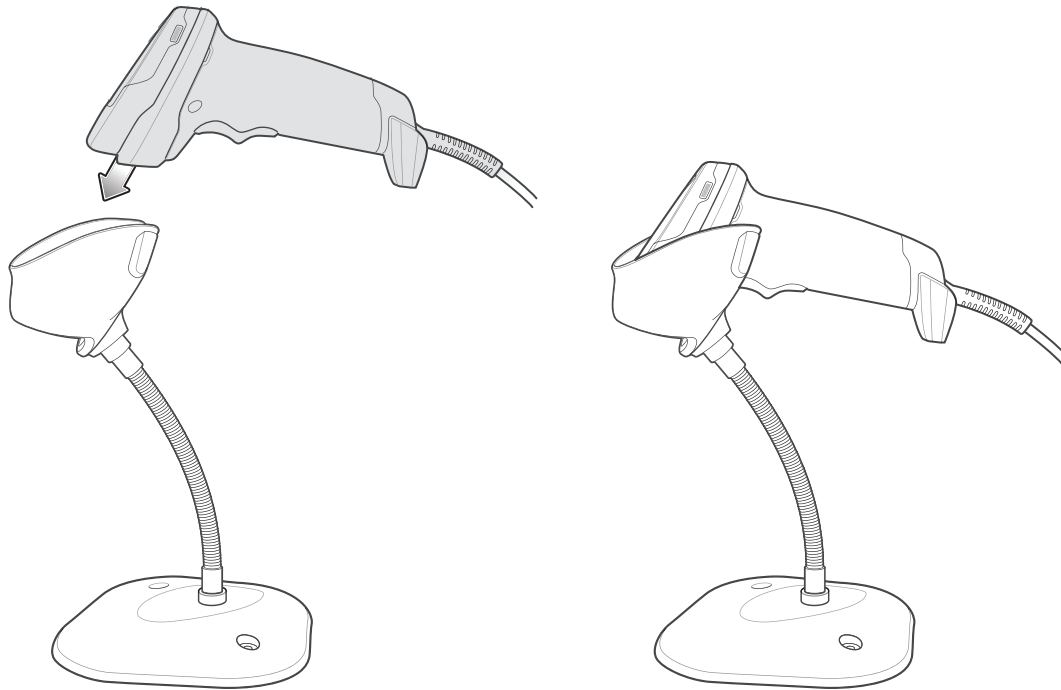

3. Adjust the scan angle by bending the stand's flexible "gooseneck" body.
4. Present the barcode. Upon successful decode, the scanner beeps and the LED momentarily shuts off. For more information about beeper and LED definitions, see [Table 3](#) and [Table 4](#).

## Scanning in Hand-Held Mode

Pick up the digital scanner. The aiming dot displays.

1. Ensure the aiming dot is centered on the barcode. See [Aiming](#) below

**Figure 7** Centering the Aiming Dot on the Barcode

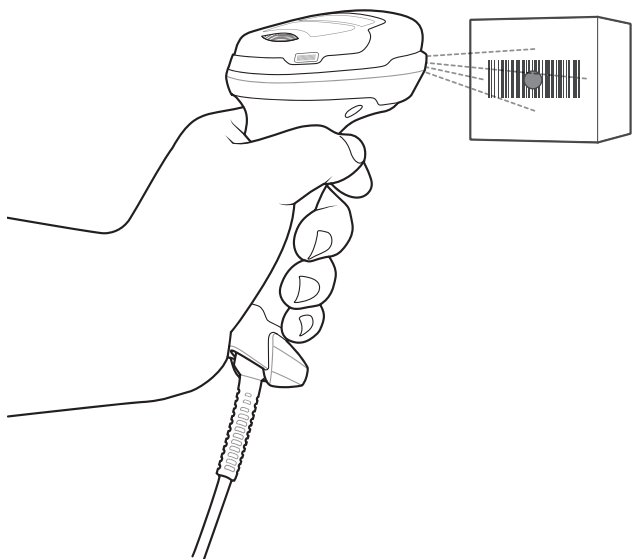

2. Press and hold the trigger until either:
  - a. The digital scanner reads the barcode. The digital scanner beeps, the LED flashes, and the aiming dot turns off.
  - Or
  - b. The digital scanner does not read the barcode and the aiming dot turns off.
3. Release the trigger.

## Aiming

When scanning, the digital scanner projects an LED dot which allows positioning the barcode within its field of view. See [Decode Ranges on page 41](#) for the proper distance to achieve between the digital scanner and a barcode.

**Figure 8** Aiming Dot

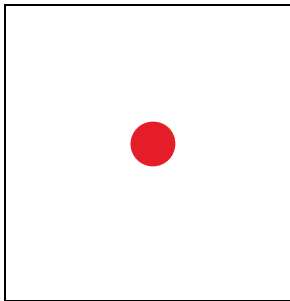

If necessary, the digital scanner turns on its illumination LEDs to illuminate the target barcode.

To scan a barcode, center the symbol and ensure the entire symbol is within the rectangular area formed by the illumination LEDs.

**Figure 9** Scanning Orientation with Aiming Dot

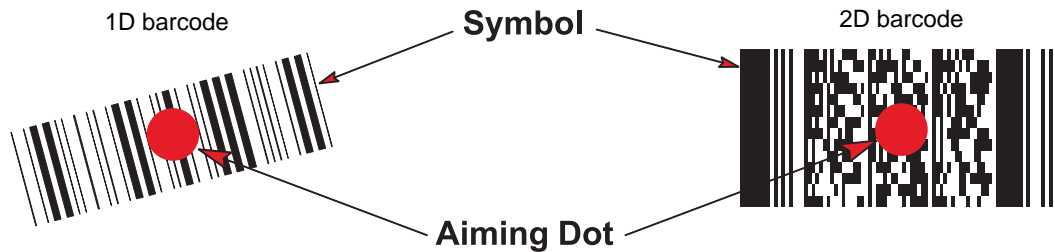

The digital scanner can also read a barcode presented within the aiming dot not centered. The top examples in [Figure](#) show acceptable aiming options, while the bottom examples can not be decoded.

**Figure 10** Acceptable Aiming

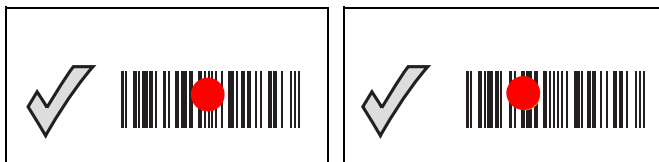

**Figure 11** Incorrect Aiming

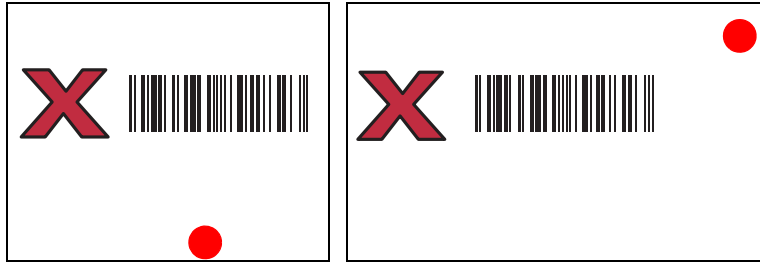

The aiming dot is smaller when the digital scanner is closer to the symbol and larger when it is farther from the symbol. Scan symbols with smaller bars or elements (mil size) closer to the digital scanner, and those with larger bars or elements (mil size) farther from the digital scanner.

The digital scanner beeps to indicate that it successfully decoded the barcode. For more information on beeper and LED definitions, see [Table 3](#) and [Table 4](#).

## Decode Ranges

**Table 5** DS4608SR/DL/HD/HC Decode Ranges

Barcode Type	Symbol Density	DS4608SR/DL Typical Working Ranges		DS4608HD/HC Typical Working Ranges	
		Near (in / cm)	Far (in / cm)	Near (in / cm)	Far (in / cm)
Code 128	3.0 mil	2.7 / 6.8	5.4 / 13.7	1.7 / 4.3	5.0 / 12.7
Code 39	3.0 mil	2.2 / 5.5	5.4 / 13.7	1.3 / 3.3	6.0 / 15.2
	5.0 mil	0.7 / 1.8	11.0 / 27.9	0.1 / 0.2	11.5 / 29.2
	20.0 mil	0.0 / 0.0	44.0 / 111.7	0.6 / 1.5	29.0 / 73.6
100% UPC	13.0 mil	0.0 / 0.0	28.0 / 71.1	0.0 / 0.0	18.0 / 45.7
PDF417	6.6 mil	1.3 / 3.3	10.0 / 25.4	0.6 / 1.5	9.3 / 23.6
Data Matrix	5 mil	2.8 / 7.1	5.0 / 12.7	1.8 / 4.5	5.0 / 12.7
	7.5 mil	2.0 / 5.0	8.5 / 21.5	1.0 / 2.5	8.0 / 20.3
	10.0 mil	1.0 / 2.5	11.5 / 29.2	0.2 / 0.5	9.5 / 24.1
QR Code	10.0 mil	1.0 / 2.5	9.0 / 22.8	0.2 / 0.5	8.5 / 21.5
	20.0 mil	0.0 / 0.0	17.5 / 44.4	0.0 / 0.0	13.5 / 34.3

**Table 6** DS4608-DPE Decode Ranges

Barcode Type	Symbol Density	DS4608-DPE Typical Working Ranges	
		Near (in / cm)	Far (in / cm)
Code 128	2.0 mil	0.3 / 0.8	2.3 / 5.8
	3.0 mil	0.0 / 0.0	3.5 / 8.8
	15 mil	4.2 / 10.7	8.6 / 21.8
Code 39	2.0 mil	0.2 / 0.5	3.0 / 7.6
	3.0 mil	0.0 / 0.0	3.8 / 9.6
	5.0 mil	0.0 / 0.0	5.2 / 13.2
100% UPC	13.0 mil	0.0 / 0.0	8.5 / 21.5
PDF417	4.0 mil	0.0 / 0.0	3.3 / 8.4
	5.0 mil	0.0 / 0.0	3.8 / 9.6
	6.6 mil	0.0 / 0.0	4.5 / 11.4
Data Matrix	4.0 mil	0.2 / 0.5	2.8 / 7.1
	5 mil	0.0 / 0.0	3.4 / 8.6
	10.0 mil	0.0 / 0.0	4.8 / 12.2
QR Code	10.0 mil	0.0 / 0.0	4.5 / 11.4

## Electronic Article Surveillance (EAS)



**NOTE:** EAS is available only on scanner models that support Checkpoint EAS.

Some scanner configurations include an integrated Electronic Article Surveillance (EAS) antenna.

The scanner's integrated EAS deactivation antenna requires an EAS host cable. This Y-cable connects to the scanner's host port at one end, and splits to the host and the EAS system at the other end.

## Installing

### Checkpoint EAS Model Compatibility

The scanner is intended for use with Checkpoint CP-VII, CP-IX, and CP-XI systems. It does not support CP-IV and other low-power receiver-based EAS deactivation systems.

### Considerations

The Checkpoint CP-VII system generates a periodic burst of electromagnetic energy that deactivates EAS tags brought near the scanner. To avoid interference with the scanner's operation, take the following precautions when installing the EAS system:

- Position the EAS antenna box as far as possible from the scanner (at least 6 in. / 15.24 cm.)
- Position the EAS antenna, EAS antenna box, EAS control cable, and EAS controller box as far as possible from the scanner's host and power cables.

EAS range is as dependent on the Checkpoint system (which is calibrated onsite) as it is on the scanner. Therefore, we cannot provide estimated ranges, however these are some of the factors that contribute to EAS range:

- Antenna – Length, gauge, number of turns, placement in the scanner.
- Type of Checkpoint EAS system used (ie. CP-VII, CP-IX, and CP-XI).
- Length of wire connecting antenna to (Checkpoint) EAS (site/installation dependent)
- Settings done within Checkpoint system (site/installation dependent).

### Checkpoint Contact Information

Contact your local Checkpoint representative to install the EAS cable to the Checkpoint Deactivation System.

# Maintenance, Troubleshooting, & Technical Specifications

---

## Introduction

This chapter provides suggested imaging scanner maintenance, troubleshooting, technical specifications, and signal descriptions (pinouts).

---

## Maintenance

### Known Harmful Ingredients

The following chemicals are known to damage the plastics on Zebra scanners and should not come in contact with the device:

- Acetone
- Ammonia solutions
- Aqueous or alcoholic alkaline solutions
- Aromatic and chlorinated hydrocarbons
- Benzene
- Carboic acid
- Compounds of amines or ammonia
- Ethanolamine
- Ethers
- Ketones
- TB-lysoform
- Toluene
- Trichloroethylene.

### Approved Cleaners for the Imaging Scanner

- Isopropyl alcohol 70% (including pre-moistened wipes).



## Approved Disinfectant Cleaners for Healthcare Configurations of the DS4608 Scanners

Only use cleaning agents from the following lists and follow the manufacturer's instructions, where applicable.

### Cleaning Agents Containing Active Ingredients

- Bleach 10% (Sodium Hypoclorite 0.55%) and Water 90% Solution
- Hydrogen Peroxide 3% and Water 97%
- Mild Dish Soap

### Brand Name Disinfectants

- 409® Glass and Surface Cleaner from Clorox
- Clorox Healthcare® Bleach Germicidal Disinfectant Wipes
- Dispatch® Wipes from Clorox
- Sani-Cloth® Bleach Wipes
- Windex® Blue, Windex® with Ammonia D and Windex® Cleansers: Antimicrobial from SC Johnson

## Cleaning the Imaging Scanner

Routinely cleaning the exit window is required. A dirty window may affect scanning accuracy. Do not allow any abrasive material to touch the window.

To clean the scanner:

1. Dampen a soft cloth with one of the approved cleaning agents listed above or use pre-moistened wipes.
2. Gently wipe all surfaces, including the front, back, sides, top and bottom. Never apply liquid directly to the scanner. Be careful not to let liquid pool around the scanner window, trigger, cable connector or any other area on the device.
3. Be sure to clean the trigger and in between the trigger and the housing (use a cotton-tipped applicator to reach tight or inaccessible areas).
4. Do not spray water or other cleaning liquids directly into the exit window.
5. Wipe the scanner exit window with a lens tissue or other material suitable for cleaning optical material such as eyeglasses.
6. Immediately dry the scanner window after cleaning with a soft non-abrasive cloth to prevent streaking.
7. Allow the unit to air dry before use.
8. Scanner connectors:
  - a. Dip the cotton portion of a cotton-tipped applicator in isopropyl alcohol.
  - b. Rub the cotton portion of the cotton-tipped applicator back-and-forth across the connector on the Zebra scanner at least 3 times. Do not leave any cotton residue on the connector.
  - c. Use the cotton-tipped applicator dipped in alcohol to remove any grease and dirt near the connector area.
  - d. Use a dry cotton tipped applicator and rub the cotton portion of the cotton-tipped applicator back-and-forth across the connectors at least 3 times. Do not leave any cotton residue on the connectors.

## Troubleshooting



**NOTE:** If after performing the possible solutions in [Table 7](#) the imaging scanner still experiences problems, contact the distributor or call support.

**Table 7** Troubleshooting

Problem	Possible Causes	Possible Solutions
The illumination does not appear when pressing the trigger.	No power to the imaging scanner.	If the configuration requires a power supply, re-connect the power supply.
	Incorrect host interface cable is used.	Connect the correct host interface cable.
	Interface/power cables are loose.	Re-connect cables.
	Imaging scanner is disabled.	For IBM 468x and USB IBM hand-held, IBM table-top, and OPOS modes, enable the imaging scanner via the host interface. Otherwise, see the technical person in charge of scanning.
	If using RS-232 Nixdorf B mode, CTS is not asserted.	Assert CTS line.
	Illumination is disabled.	Enable the illumination. See <a href="#">Decoding Illumination on page 172</a> .
Imaging scanner emits illumination, but does not decode the barcode.	Imaging scanner is not programmed for the correct barcode type.	Program the imaging scanner to read that type of barcode. See <a href="#">Symbologies</a> .
	Barcode symbol is unreadable.	Scan test symbols of the same barcode type to determine if the barcode is defaced.
	The symbol is not completely inside illumination.	Move the symbol completely within the illumination. Move the symbol completely within the field of view (AIM pattern does NOT define FOV)
	Distance between imaging scanner and barcode is incorrect.	Move the scanner closer to or further from the barcode. See <a href="#">Decode Ranges on page 41</a> .

**Table 7** Troubleshooting (Continued)

Problem	Possible Causes	Possible Solutions
Imaging scanner decodes barcode, but does not transmit the data to the host.	Imaging scanner is not programmed for the correct host type.	Scan the appropriate host type programming barcode. See the chapter corresponding to the host type.
	Interface cable is loose.	Re-connect the cable.
	If the imaging scanner emits four long low beeps, a transmission error occurred. This occurs if a unit is not properly configured or connected to the wrong host type.	Set the scanner's communication parameters to match the host's setting.
	If the imaging scanner emits 5 low beeps, a conversion or format error occurred.	Configure the imaging scanner's conversion parameters properly.
	If the imaging scanner emits low/high/low beeps, it detected an invalid ADF rule.	Program the correct ADF rules. Refer to the Advanced Data Formatting Programmer Guide.
Host displays scanned data incorrectly.	Imaging scanner is not programmed to work with the host.	Scan the appropriate host type programming barcode.
		For RS-232, set the imaging scanner's communication parameters to match the host's settings.
		For a Keyboard Wedge configuration, program the system for the correct keyboard type, and turn off the CAPS LOCK key.
		Program the proper editing options (e.g., UPC-E to UPC-A Conversion).
Imaging scanner emits short low/short medium/short high beep sequence (power-up beep sequence) more than once.	The USB bus may put the imaging scanner in a state where power to the scanner is cycled on and off more than once.	Normal during host reset.
Imaging scanner emits 4 short high beeps during decode attempt.	Imaging scanner has not completed USB initialization.	Wait several seconds and scan again.
Imaging scanner emits Low/low/low/extra low beeps when not in use.	RS-232 receive error.	Normal during host reset. Otherwise, set the imaging scanner's RS-232 parity to match the host setting.
Imaging scanner emits low/high beeps during programming.	Input error, incorrect barcode or <b>Cancel</b> barcode was scanned.	Scan the correct numeric barcodes within range for the parameter programmed.

**Table 7** Troubleshooting (Continued)

Problem	Possible Causes	Possible Solutions
Imaging scanner emits low/high/low/high beeps during programming.	Out of host parameter storage space.	Scan <a href="#">Default Parameters on page 142</a> .
	Out of memory for ADF rules.	Reduce the number of ADF rules or the number of steps in the ADF rules.
	During programming, indicates out of ADF parameter storage space.	Erase all rules and re-program with shorter rules.
Imaging scanner emits low/high/low beeps.	ADF transmit error.	Refer to the Advanced Data Formatting Guide for information.
	Invalid ADF rule is detected.	Refer to the Advanced Data Formatting Guide for information.
Imaging scanner emits a power-up beep after changing USB host type.	The USB bus re-established power to the imaging scanner.	Normal when changing USB host type.
Imaging scanner emits one high beep when not in use.	In RS-232 mode, a <BEL> character was received and Beep on <BEL> option is enabled.	Normal when <b>Beep on &lt;BEL&gt;</b> is enabled and the imaging scanner is in RS-232 mode.
Imaging scanner emits frequent beeps.	Incorrect host interface cable is used.	Verify that the correct host interface cable is used. If not, connect the correct host interface cable.
	Interface/power cables are loose.	Check for loose cable connections and re-connect cables.
Imaging scanner emits five long low beeps after a barcode is decoded.	Conversion or format error was detected. The scanner conversion parameters are not properly configured.	Ensure the scanner conversion parameters are properly configured.
	Conversion or format error was detected. An ADF rule was set up with characters that can't be sent for the host selected.	Change the ADF rule, or change to a host that can support the ADF rule.
	Conversion or format error was detected. A barcode was scanned with characters that can't be sent for that host.	Change the barcode, or change to a host that can support the barcode.

---

## Send Versions

### Software Version

Scan the following barcode to send the version of software installed in the scanner.



**Software Version**

### Serial Number

Scan the following barcode to send the scanner serial number to the host.

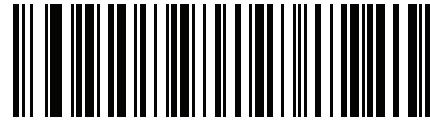

**Serial Number**

### Manufacturing Information

Scan the following barcode to send the scanner manufacturing information to the host.



**Manufacturing Information**

## Technical Specifications

**Table 8** Technical Specifications - DS4608-SR/DS4608-DL/DS4608-HD/DS4608-HL

Item	Description
<b>Physical Characteristics</b>	
Dimensions	6.5 in. H x 2.6 in. W x 3.9 in. D 16.5 cm H x 6.7 cm W x 9.8 cm D
Weight	5.7 oz. /161.9 g
Input Voltage Range	4.5 to 5.5 VDC Host Powered; 4.5 to 5.5 VDC External Power Supply
Operating Current at Nominal Voltage (5.0V)	340 mA (typical)
Standby Current (Idle) at Nominal Voltage (5.0V)	150 mA (typical)
Color	Nova White, Twilight Black
Supported Host Interfaces	USB, RS232, TGCS (IBM) 46XX over RS485
USB Certification	DS4608 is USB2.0 Full Speed Compliant, visit <a href="http://USB.org">USB.org</a> for more details.
Keyboard Support	Supports over 90 international keyboards
Electronic Article Surveillance	Compatible with Checkpoint EAS deactivation system
User Indicators	Direct Decode Indicator, Good Decode LEDs, rear view LEDs, beeper (adjustable tone and volume)
<b>Performance Characteristics</b>	
Light Source	Aiming Pattern: circular 617nm amber LED
Illumination	(2) 660nm Red LEDs
Imager Field of View	36.1° H x 22.6° V nominal
Image Sensor	1280 x 800 pixels
Minimum Print Contrast	15% minimum reflective difference
Skew Tolerance	+/- 60°
Pitch Tolerance	+/- 60°
Roll Tolerance	0°-360°
<b>Imaging Characteristics</b>	
Graphics Format Support	Images can be exported as Bitmap, JPEG or TIFF
Image Quality	96PPI on an A4 document (DS4608-SR)
<sup>1</sup> Printing resolution, contrast, and ambient light dependent	

**Table 8** Technical Specifications - DS4608-SR/DS4608-DL/DS4608-HD/DS4608-HL (Continued)

Item	Description
<b>Environmental</b>	
Operating Temperature	32.0° to 122.0° F / 0.0° to 50.0° C
Storage Temperature	-40.0° to 158.0° F / -40.0° to 70.0° C
Humidity	5% to 95% RH, non-condensing
Drop Specification	Designed to withstand multiple drops at 6.0 ft./1.8 m to concrete
Tumble Specification	Designed to withstand 2,000 tumbles in 1.5 ft./0.5 m tumbler
Environmental Sealing	IP52
Electrostatic Discharge (ESD)	ESD per EN61000-4-2, +/-15 KV Air, +/-8 KV Direct, +/-8 KV Indirect
Ambient Light Immunity	0 to 10,000 foot candles/0 to 107,000 Lux
<b>Accessories</b>	
Gooseneck Intellistand, Cup	
<b>Symbol Decode Capability</b>	
1D	Code 39, Code 128, Code 93, Codabar/NW7, Code 11, MSI Plessey, UPC/EAN, I 2 of 5, Korean 3 of 5, GS1 DataBar, Base 32 (Italian Pharma)
2D	PDF417, Micro PDF417, Composite Codes, TLC-39, Aztec, DataMatrix, MaxiCode, QR Code, Micro QR, Han Xin, Postal Codes, SecurPharm, DotCode, Dotted DataMatrix
OCR	OCR-A, OCR-B, MICR, US Currency
Minimum Element Resolution	Code 39 - 3.0 mil (DS4608-SR)
	DataMatrix - 5.0 mil (DS4608-SR)
	Code 39 - 2.0 mil (DS4608-HD)
	DataMatrix - 4.0 mil (DS4608-HD)
<b>DS4608-SR/DL Decode Ranges (Typical) <sup>1</sup></b>	
<b>Symbology/Resolution</b>	<b>Near/Far</b>
Code 39: 3 mil	2.2 in./5.6 cm to 5.4 in./13.7 cm
Code 39: 5 mil	0.7 in./1.8 cm to 11.0 in./27.9 cm
Code 39: 20 mil	0 in./0 cm to 44.0 in./111.8 cm
Code 128: 5 mil	2.7 in./6.9 cm to 5.4 in./13.7 cm
PDF 417: 6.7 mil	1.3 in./3.3 cm to 10.0 in./25.4 cm
UPC: 13 mil (100%)	0 in./0 cm to 28.0 in./71.1 cm
DataMatrix: 10 mil	1.0 in./2.5 cm to 11.5 in./29.2 cm
QR: 20 mil	0 in./0 cm to 17.5 in./44.5 cm
<sup>1</sup> Printing resolution, contrast, and ambient light dependent	

**Table 8** Technical Specifications - DS4608-SR/DS4608-DL/DS4608-HD/DS4608-HL (Continued)

Item	Description
<b>DS4608-HD/HL Decode Ranges (Typical) <sup>1</sup></b>	
<b>Symbology/Resolution</b>	<b>Near/Far</b>
Code 39: 3 mil	1.3 in./3.3 cm to 6.0 in./15.2 cm
Code 39: 5 mil	0 .1 in./0.3 cm to 11.5 in./29.2 cm
Code 39: 20 mil	0.6 in./1.5 cm to 29.0 in./73.7 cm
Code 128: 5 mil	1.7 in./4.3 cm to 5.0 in./12.7 cm
PDF 417: 6.7 mil	0.6 in./1.5 cm to 9.3 in./23.6 cm
UPC: 13 mil (100%)	0 in./0 cm to 18.0 in./45.7 cm
DataMatrix: 10 mil	0.2 in./0.5 cm to 9.5 in./24.1 cm
QR: 20 mil	0 in./0 cm to 13.5 in./34.3 cm
<b>Utilities and Management</b>	
123Scan	Programs scanner parameters, upgrades firmware, provides scanned barcode data and prints reports. See <a href="#">123Scan and Software Tools</a> . <a href="http://www.zebra.com/123Scan">www.zebra.com/123Scan</a>
Symbol Scanner SDK	Generates a fully-featured scanner application, including documentation, drivers, test utilities and sample source code. <a href="http://www.zebra.com/ScannerSDKforWindows">www.zebra.com/ScannerSDKforWindows</a>
Scanner Management Service (SMS)	Remotely manages your Zebra scanner and queries its asset information. <a href="http://www.zebra.com/sms">www.zebra.com/sms</a>
<sup>1</sup> Printing resolution, contrast, and ambient light dependent	

**Table 9** Technical Specifications - DS4608-HC

Item	Description
<b>Physical Characteristics</b>	
Dimensions	6.5 in. H x 2.6 in. W x 3.9 in. D 16.5 cm H x 6.7 cm W x 9.8 cm D
Weight	5.7 oz. /161.9 g
Input Voltage Range	4.5 to 5.5 VDC Host Powered; 4.5 to 5.5 VDC External Power Supply
Operating Current at Nominal Voltage (5.0V)	375 mA (typical)
Standby Current (Idle) at Nominal Voltage (5.0V)	150 mA (typical)
Color	Healthcare White
Supported Host Interfaces	USB, RS232, TGCS (IBM) 46XX over RS485
<sup>1</sup> Printing resolution, contrast, and ambient light dependent	



**Table 9** Technical Specifications - DS4608-HC (Continued)

Item	Description
USB Certification	DS4608 is USB2.0 Full Speed Compliant, visit <a href="http://USB.org">USB.org</a> for more details.
Keyboard Support	Supports over 90 international keyboards
User Indicators	Direct Decode Indicator, Good Decode LEDs, rear view LEDs, beeper (adjustable tone and volume), haptic/vibration
<b>Performance Characteristics</b>	
Light Source	Aiming Pattern: circular 528nm true green LED
Illumination	(2)warm white LEDs
Imager Field of View	35° H x 22° V nominal
Image Sensor	1280 x 800 pixels
Minimum Print Contrast	15% minimum reflective difference
Skew Tolerance	+/- 60°
Pitch Tolerance	+/- 60°
Roll Tolerance	0° - 360°
<b>Imaging Characteristics</b>	
Graphics Format Support	Images can be exported as Bitmap, JPEG or TIFF
<b>Environmental</b>	
Operating Temperature	32.0° to 122.0° F / 0.0° to 50.0° C
Storage Temperature	-40.0° to 158.0° F / -40.0° to 70.0° C
Humidity	5% to 95% RH, non-condensing
Drop Specification	Designed to withstand multiple drops at 6.0 ft./1.8 m to concrete
Tumble Specification	Designed to withstand 2,000 tumbles in 1.5 ft./0.5 m tumbler
Environmental Sealing	IP52
Approved Cleaners	Disinfectant Ready. See <a href="#">Approved Disinfectant Cleaners for Healthcare Configurations of the DS4608 Scanners on page 45.</a>
Electrostatic Discharge (ESD)	ESD per EN61000-4-2, +/-15 KV Air, +/-8 KV Direct, +/-8 KV Indirect
Ambient Light Immunity	0 to 10,000 foot candles/0 to 107,000 Lux
<b>Accessories</b>	
Gooseneck Intellistand, Cup	
<sup>1</sup> Printing resolution, contrast, and ambient light dependent	

**Table 9** Technical Specifications - DS4608-HC (Continued)

Item	Description																		
<b>Symbol Decode Capability</b>																			
1D	Code 39, Code 128, Code 93, Codabar/NW7, Code 11, MSI Plessey, UPC/EAN, I 2 of 5, Korean 3 of 5, GS1 DataBar, Base 32 (Italian Pharma)																		
2D	PDF417, Micro PDF417, Composite Codes, TLC-39, Aztec, DataMatrix, MaxiCode, QR Code, Micro QR, Han Xin, Postal Codes, SecurPharm																		
OCR	OCR-A, OCR-B, MICR, US Currency																		
Minimum Element Resolution	Code 39 - 2.0 mil DataMatrix - 4.0 mil																		
<b>DS4608-HC Decode Ranges (Typical) <sup>1</sup></b>																			
<table border="0"> <thead> <tr> <th data-bbox="198 690 526 722"><b>Symbology/Resolution</b></th> <th data-bbox="570 690 678 722"><b>Near/Far</b></th> </tr> </thead> <tbody> <tr> <td data-bbox="198 732 375 764">Code 39: 3 mil</td> <td data-bbox="570 732 943 764">1.3 in./3.3 cm to 6.0 in./15.2 cm</td> </tr> <tr> <td data-bbox="198 774 375 806">Code 39: 5 mil</td> <td data-bbox="570 774 959 806">0.1 in./0.3 cm to 11.5 in./29.2 cm</td> </tr> <tr> <td data-bbox="198 816 391 848">Code 39: 20 mil</td> <td data-bbox="570 816 959 848">0.6 in./1.5 cm to 29.0 in./73.7 cm</td> </tr> <tr> <td data-bbox="198 858 391 890">Code 128: 5 mil</td> <td data-bbox="570 858 943 890">1.7 in./4.3 cm to 5.0 in./12.7 cm</td> </tr> <tr> <td data-bbox="198 900 402 932">PDF 417: 6.7 mil</td> <td data-bbox="570 900 943 932">0.6 in./1.5 cm to 9.3 in./23.6 cm</td> </tr> <tr> <td data-bbox="198 942 440 974">UPC: 13 mil (100%)</td> <td data-bbox="570 942 911 974">0 in./0 cm to 18.0 in./45.7 cm</td> </tr> <tr> <td data-bbox="198 984 418 1016">DataMatrix: 10 mil</td> <td data-bbox="570 984 943 1016">0.2 in./0.5 cm to 9.5 in./24.1 cm</td> </tr> <tr> <td data-bbox="198 1026 331 1058">QR: 20 mil</td> <td data-bbox="570 1026 911 1058">0 in./0 cm to 13.5 in./34.3 cm</td> </tr> </tbody> </table>	<b>Symbology/Resolution</b>	<b>Near/Far</b>	Code 39: 3 mil	1.3 in./3.3 cm to 6.0 in./15.2 cm	Code 39: 5 mil	0.1 in./0.3 cm to 11.5 in./29.2 cm	Code 39: 20 mil	0.6 in./1.5 cm to 29.0 in./73.7 cm	Code 128: 5 mil	1.7 in./4.3 cm to 5.0 in./12.7 cm	PDF 417: 6.7 mil	0.6 in./1.5 cm to 9.3 in./23.6 cm	UPC: 13 mil (100%)	0 in./0 cm to 18.0 in./45.7 cm	DataMatrix: 10 mil	0.2 in./0.5 cm to 9.5 in./24.1 cm	QR: 20 mil	0 in./0 cm to 13.5 in./34.3 cm	
<b>Symbology/Resolution</b>	<b>Near/Far</b>																		
Code 39: 3 mil	1.3 in./3.3 cm to 6.0 in./15.2 cm																		
Code 39: 5 mil	0.1 in./0.3 cm to 11.5 in./29.2 cm																		
Code 39: 20 mil	0.6 in./1.5 cm to 29.0 in./73.7 cm																		
Code 128: 5 mil	1.7 in./4.3 cm to 5.0 in./12.7 cm																		
PDF 417: 6.7 mil	0.6 in./1.5 cm to 9.3 in./23.6 cm																		
UPC: 13 mil (100%)	0 in./0 cm to 18.0 in./45.7 cm																		
DataMatrix: 10 mil	0.2 in./0.5 cm to 9.5 in./24.1 cm																		
QR: 20 mil	0 in./0 cm to 13.5 in./34.3 cm																		
<b>Utilities and Management</b>																			
123Scan	Programs scanner parameters, upgrades firmware, provides scanned barcode data and prints reports. See <a href="#">123Scan and Software Tools</a> . <a href="http://www.zebra.com/123Scan">www.zebra.com/123Scan</a>																		
Symbol Scanner SDK	Generates a fully-featured scanner application, including documentation, drivers, test utilities and sample source code. <a href="http://www.zebra.com/ScannerSDKforWindows">www.zebra.com/ScannerSDKforWindows</a>																		
Scanner Management Service (SMS)	Remotely manages your Zebra scanner and queries its asset information. <a href="http://www.zebra.com/sms">www.zebra.com/sms</a>																		
<sup>1</sup> Printing resolution, contrast, and ambient light dependent																			

**Table 10** Technical Specifications - DS4608-DPE

Item	Description
<b>Physical Characteristics</b>	
Dimensions	6.5 in. H x 2.6 in. W x 3.9 in. D 16.5 cm H x 6.7 cm W x 9.8 cm D
Weight	5.7 oz. /161.9 g
Input Voltage Range	4.5 to 5.5 VDC Host Powered; 4.5 to 5.5 VDC External Power Supply
Operating Current at Nominal Voltage (5.0V)	375 mA (typical)
Standby Current (Idle) at Nominal Voltage (5.0V)	150 mA (typical)
Color	Twilight Black
Supported Host Interfaces	USB, RS232, TGCS (IBM) 46XX over RS485
USB Certification	DS4608 is USB2.0 Full Speed Compliant, visit <a href="http://USB.org">USB.org</a> for more details.
Keyboard Support	Supports over 90 international keyboards
User Indicators	Direct Decode Indicator, Good Decode LEDs, rear view LEDs, beeper (adjustable tone and volume), haptic/vibration
<b>Performance Characteristics</b>	
Light Source	Aiming Pattern: circular 528nm true green LED
Illumination	(2) warm white LEDs
Imager Field of View	34° H x 21.6° V nominal
Image Sensor	1280 x 800 pixels
Minimum Print Contrast	15% minimum reflective difference
Skew Tolerance	+/- 60°
Pitch Tolerance	+/- 60°
Roll Tolerance	0°- 360°
<b>Imaging Characteristics</b>	
Graphics Format Support	Images can be exported as Bitmap, JPEG or TIFF
<b>Environmental</b>	
Operating Temperature	32.0° to 122.0° F / 0.0° to 50.0° C
Storage Temperature	-40.0° to 158.0° F / -40.0° to 70.0° C
<sup>1</sup> Printing resolution, contrast, and ambient light dependent	

**Table 10** Technical Specifications - DS4608-DPE (Continued)

Item	Description
Humidity	5% to 95% RH, non-condensing
Drop Specification	Designed to withstand multiple drops at 6.0 ft./1.8 m to concrete
Tumble Specification	Designed to withstand 2,000 tumbles in 1.5 ft./0.5 m tumbler
Environmental Sealing	IP52
Electrostatic Discharge (ESD)	ESD per EN61000-4-2, +/-15 KV Air, +/-8 KV Direct, +/-8 KV Indirect
Ambient Light Immunity	0 to 10,000 Foot Candles / 0 to 107,600 Lux
<b>Accessories</b>	
Gooseneck Intellistand, Cup	
<b>Symbol Decode Capability</b>	
1D	Code 39, Code 128, Code 93, Codabar/NW7, Code 11, MSI Plessey, UPC/EAN, I 2 of 5, Korean 3 of 5, GS1 DataBar, Base 32 (Italian Pharma)
2D	PDF417, Micro PDF417, Composite Codes, TLC-39, Aztec, DataMatrix, DotCode, Dotted DataMatrix, MaxiCode, QR Code, Micro QR, Han Xin, Postal Codes, SecurPharm
Minimum Element Resolution	Code 39 - 2.0 mil DataMatrix - 4.0 mil
<b>DS4608-HC Decode Ranges (Typical) <sup>1</sup></b>	
<b>Symbology/Resolution</b>	<b>Near/Far</b>
Code 128: 2 mil	0.3 in./0.8 cm to 2.3 in./5.8 cm
Code 128: 3 mil	0 in./0 cm to 3.5 in./8.8 cm
Code 128: 15 mil	4.2 in./10.7 cm to 8.6 in./21.8 cm
Code 39: 2 mil	0.2 in./0.5 cm to 3.0 in./7.6 cm
Code 39: 3 mil	0 in./0 cm to 3.8 in./9.6 cm
Code 39: 5 mil	0 in./0 cm to 5.2 in./13.2 cm
PDF 417: 4 mil	0 in./0 cm to 3.3 in./8.4 cm
PDF 417: 5 mil	0 in./0 cm to 3.8 in./9.6 cm
PDF 417: 6.6 mil	0 in./0 cm to 4.5 in./11.4 cm
UPC: 13 mil (100%)	0 in./0 cm to 8.5 in./21.5 cm
Data Matrix: 4 mil	0.2 in./0.5 cm to 2.8 in./7.1 cm
Data Matrix: 5 mil	0 in./0 cm to 3.4 in./8.6 cm
Data Matrix: 10 mil	0 in./0 cm to 4.8 in./12.2 cm
QR Code: 10 mil	0 in./0 cm to 4.5 in./11.4 cm
<b>Utilities and Management</b>	
<sup>1</sup> Printing resolution, contrast, and ambient light dependent	

**Table 10** Technical Specifications - DS4608-DPE (Continued)

Item	Description
123Scan	Programs scanner parameters, upgrades firmware, provides scanned barcode data and prints reports. See <a href="http://www.zebra.com/123Scan">123Scan and Software Tools</a> . <a href="http://www.zebra.com/123Scan">www.zebra.com/123Scan</a>
Symbol Scanner SDK	Generates a fully-featured scanner application, including documentation, drivers, test utilities and sample source code. <a href="http://www.zebra.com/ScannerSDKforWindows">www.zebra.com/ScannerSDKforWindows</a>
Scanner Management Service (SMS)	Remotely manages your Zebra scanner and queries its asset information. <a href="http://www.zebra.com/sms">www.zebra.com/sms</a>
<sup>1</sup> Printing resolution, contrast, and ambient light dependent	

## Imaging Scanner Signal Descriptions

**Figure 12** Imaging Scanner Cable Pinouts

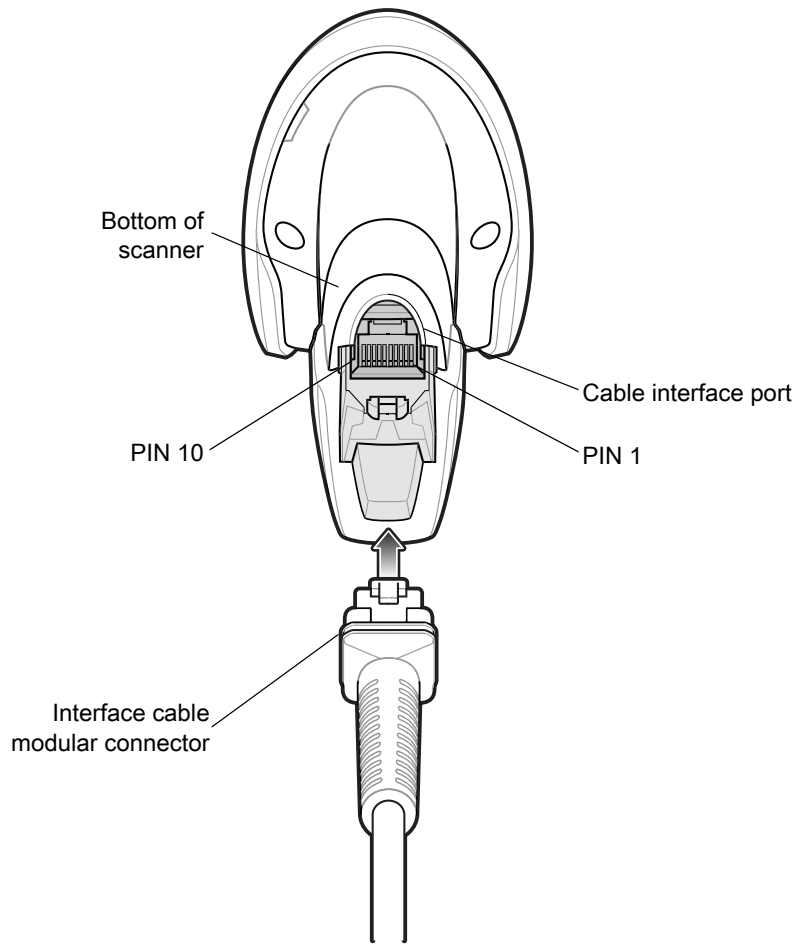

The signal descriptions in [Table 11](#) apply to the connectors on the DS4608 imaging scanner and are for reference only.

**Table 11** DS4608 Imaging Scanner Signal Pin-outs

Pin	IBM	RS-232	Keyboard Wedge	USB
1	Cable ID	Cable ID	Cable ID	Cable ID
2	Power (+5V)	Power (+5V)	Power (+5V)	Power (+5V)
3	Ground	Ground	Ground	Ground
4	IBM_OUT	TxD	KeyClock	Reserved
5	IBM_IN	RxD	TermData	D +
6	IBM_T/R	RTS	KeyData	Reserved
7	Reserved	CTS	TermClock	D -
8	Reserved	Reserved	Reserved	Reserved
9	See note			
10	See note			

Note: EAS configurations use pins 9 and 10 for an EAS antenna. For other configurations pins 9 and 10 are open.

# USB Interface

---

## Introduction

This chapter describes how to set up the scanner with a USB host. The scanner connects directly to a USB host, or a powered USB hub, which powers it. No additional power supply is required.

The scanner ships with the settings shown in [Table 12 on page 61](#) (also see [Standard Parameter Defaults](#) for all defaults). If the default values suit requirements, programming is not necessary.

---

## Setting Parameters

To set feature values, scan a single barcode or a short barcode sequence. The settings are stored in non-volatile memory and are preserved even when the scanner powers down.



**NOTE:** Most computer monitors allow scanning barcodes directly on the screen. When scanning from the screen, be sure to set the document magnification to a level where you can see the barcode clearly, and bars and/or spaces do not merge.

To return all features to default values, scan [Set Factory Defaults on page 142](#). Throughout the programming barcode menus, asterisks (\*) indicate default values.



\* Indicates default      \*Enable Parameter      Feature/option

## Scanning Sequence Examples

In most cases scanning one barcode sets the parameter value. For example, to set the USB keystroke delay to medium, scan the **Medium Delay (20 msec)** barcode under [USB Keystroke Delay on page 65](#). The scanner issues a fast warble beep and the LED turns green, signifying a successful parameter entry.

Other parameters require scanning several barcodes. See the parameter descriptions for this procedure.

## Errors While Scanning

Unless otherwise specified, to correct an error during a scanning sequence, just re-scan the correct parameter.

## Connecting a USB Interface

Figure 13 USB Connection

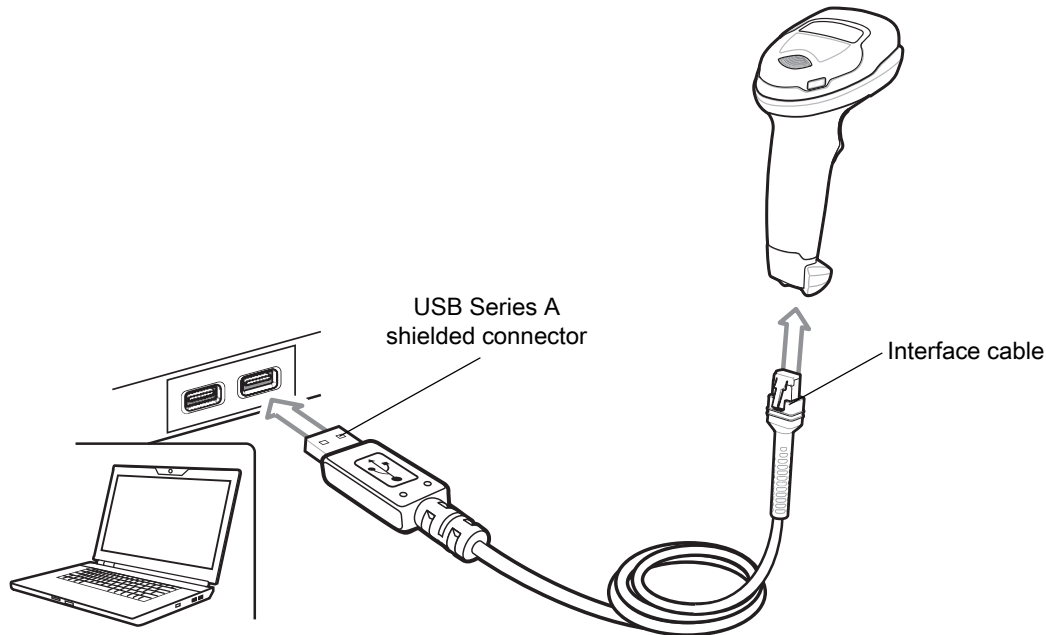

**NOTE:** When connecting via USB use the shielded connector cable (e.g., p/n CBA-U21-S07ZAR). Refer to Solution Builder for guidance about cables.

The scanner connects to USB-capable hosts including:

- TGCS (IBM) terminals
- Apple™ desktop and notebooks
- Other network computers that support more than one keyboard.

The following operating systems support the scanner through USB:

- Windows® XP, 7, 8, 10
- MacOS 8.5 - MacOS 10.6
- IBM 4690 OS.

The scanner also interfaces with other USB hosts that support USB Human Interface Devices (HID).

To set up the scanner:



**NOTE:** Interface cables vary depending on configuration. The connectors illustrated in [Figure 13](#) are examples only. The connectors may be different than those illustrated, but the steps to connect the scanner are the same.



1. Connect the modular connector of the USB interface cable to the cable interface port on the scanner. See [Inserting the Interface Cable on page 28](#).
2. Plug the series A connector in the USB host or hub, or plug the Plus Power connector in an available port of the IBM SurePOS terminal.
3. The scanner automatically detects the host and uses the default USB device type. If the default (\*) does not meet your requirements, select another USB device type by scanning the appropriate barcode from [USB Device Type on page 62](#).
4. On first installation when using Windows, the software may prompt to select or install the Human Interface Device driver. To install this driver, provided by Windows, click **Next** at all choices and click **Finished** on the last choice. The scanner powers up during this installation.
5. To modify any other parameter options, scan the appropriate barcodes in this chapter.

If problems occur with the system, see [Troubleshooting on page 46](#).

## USB Parameter Defaults

[Table 12](#) lists defaults for USB host parameters. Change these values in one of two ways:

- Scan the appropriate barcodes in this chapter. The new value replaces the standard default value in memory. To recall default parameter values, see [Default Parameters on page 142](#).
- Configure the scanner using the 123Scan configuration program. See [123Scan and Software Tools](#).



**NOTE:** See [Standard Parameter Defaults](#) for all user preference, host, symbology, and miscellaneous default parameters.

**Table 12** USB Interface Parameter Defaults

Parameter	Default	Page Number
<b>USB Host Parameters</b>		
USB Device Type	USB HID Keyboard	<a href="#">62</a>
Symbol Native API (SNAPI) Status Handshaking	Enable	<a href="#">64</a>
USB Keystroke Delay	No Delay	<a href="#">65</a>
USB Caps Lock Override	Do Not Override (Disable)	<a href="#">65</a>
Barcodes with Unknown Characters	Send Barcodes with Unknown Characters	<a href="#">66</a>
USB Convert Unknown to Code 39	Disable	<a href="#">66</a>
USB Fast HID	Enable	<a href="#">67</a>
USB Polling Interval	3 msec	<a href="#">68</a>
Keypad Emulation	Enable	<a href="#">70</a>
Quick Keypad Emulation	Enable	<a href="#">70</a>
Keypad Emulation with Leading Zero	Enable	<a href="#">71</a>
USB FN1 Substitution	Disable	<a href="#">71</a>
Function Key Mapping	Disable	<a href="#">72</a>

**Table 12** USB Interface Parameter Defaults (Continued)

Parameter	Default	Page Number
Simulated Caps Lock	Disable	<a href="#">72</a>
Convert Case	None	<a href="#">73</a>
USB Static CDC	Enable	<a href="#">74</a>
CDC Beep on <BEL>	Enable	<a href="#">74</a>
TGCS (IBM) USB Direct I/O Beep	Honor	<a href="#">75</a>
TGCS (IBM) USB Beep Directive	Ignore	<a href="#">75</a>
TGCS (IBM) USB Barcode Configuration Directive	Ignore	<a href="#">76</a>
TGCS (IBM) USB Specification Version	Version 2.2	<a href="#">76</a>

## USB Host Parameters

### USB Device Type

Scan one of the following barcodes to select the USB device type. To select a country keyboard type for the **USB HID Keyboard** host, see [Country Codes](#).



#### NOTES

- When changing USB Device Types, the scanner resets and issues the standard startup beep sequences.
- When connecting two scanners to a host, IBM does not allow selecting two of the same device type. If you require two connections, select **IBM Table-top USB** for one scanner and **IBM Hand-held USB** for the second scanner.
- Select **IBM Hand-held USB** to transmit data only once when an IBM register issues a Scan Disable command. If the register issues a Scan Enable command before the timeout expires, scanning can continue. If a Scan Enable does not occur within the timeout, the scanner issues 4 long low transmission error beeps, and data does not transmit. You can then scan again under the same criteria.

Select **OPOS (IBM Hand-held with Full Disable)** to completely shut off the scanner when an IBM register issues a Scan Disable command, including aim, illumination, decoding, and data transmission.

- Before selecting **USB CDC Host**, install the Zebra USB CDC driver located at <https://www.zebra.com/us/en/support-downloads/software/drivers/usb-cdc-driver.html> on the host.
  - If using Windows XP, this self-contained driver provides functionality but prompts with a warning message as Microsoft no longer re-certifies drivers for this operating system.
  - Windows 10 includes a native CDC driver that supports Zebra scanners. Use this to provide CDC functionality in the Windows 10 environment.
    - To recover a stalled scanner:
      - Install the Zebra USB CDC driver, or,
      - After power-up, hold the trigger for 10 seconds, which allows the scanner to power up using an alternate USB configuration. Upon power-up, scan another USB Device Type.
- To select the Toshiba TEC device type, refer to the Toshiba TEC Programmer's Guide.

## USB Device Type (continued)



**\*USB HID Keyboard**



**IBM Table-top USB**

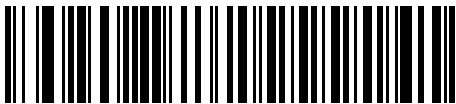

**IBM Hand-held USB**



**OPOS  
(IBM Hand-held with Full Disable)**

## USB Device Type (continued)



**USB CDC Host**



**SSI over USB CDC**



**Symbol Native API (SNAPI) with Imaging Interface**



**Symbol Native API (SNAPI) without Imaging Interface**

## Symbol Native API (SNAPI) Status Handshaking

After selecting a SNAPI interface as the USB device type, scan one of the following barcodes to select whether to enable or disable status handshaking.



**\*Enable SNAPI Status Handshaking**



**Disable SNAPI Status Handshaking**

## USB Keystroke Delay

Scan one of the following barcodes to set the delay, in milliseconds, between emulated keystrokes. Select a longer delay for hosts that require slower data transmission.



**\*No Delay**

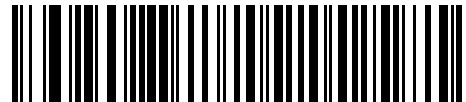

**Medium Delay (20 msec)**

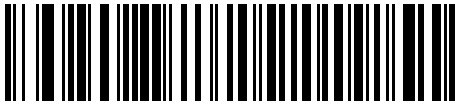

**Long Delay (40 msec)**

## USB Caps Lock Override

This option applies only to the USB HID Keyboard device. Scan **Override Caps Lock Key** to preserve the case of the data regardless of the state of the **Caps Lock** key. This setting is always enabled for the Japanese Windows (ASCII) keyboard type and can not be disabled.



**Override Caps Lock Key  
(Enable)**



**\*Do Not Override Caps Lock Key  
(Disable)**

## Barcodes with Unknown Characters

This option applies only to the USB HID Keyboard and IBM devices. Unknown characters are characters the host does not recognize. Scan **Send Barcodes With Unknown Characters** to send all barcode data except for unknown characters. The scanner issues no error beeps.

Scan **Do Not Send Barcodes With Unknown Characters** for IBM devices to prevent sending barcodes containing at least one unknown character to the host, or for USB HID Keyboard devices to send the barcode characters up to the unknown character. The scanner issues an error beep.

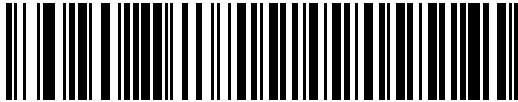

**\*Send Barcodes with Unknown Characters**



**Do Not Send Barcodes with Unknown Characters**

## USB Convert Unknown to Code 39

This option applies only to the IBM hand-held, IBM table-top, and OPOS devices. Scan one of the following barcodes to enable or disable converting unknown barcode type data to Code 39.



**Enable Convert Unknown to Code 39**



**\*Disable Convert Unknown to Code 39**

## USB Fast HID

Scan **Enable USB Fast HID** to transmit USB HID data at a faster rate.



**NOTE:** Disable this if there are problems with transmission.

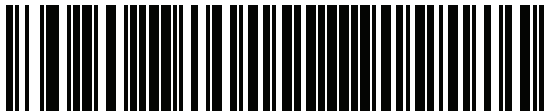

**\*Enable USB Fast HID**

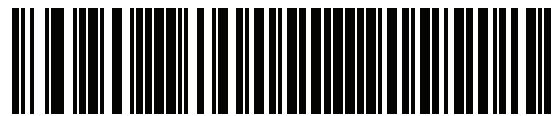

**Disable USB Fast HID**

## USB Polling Interval

Scan one of the following barcodes to set the polling interval, which is the rate at which data transmits between the scanner and host computer. A lower number indicates a faster data rate.



**NOTE:** When changing the USB polling interval, the scanner restarts and issues a power-up beep sequence.



**IMPORTANT:** Ensure the host supports the selected data rate.



1 msec



2 msec



\*3 msec

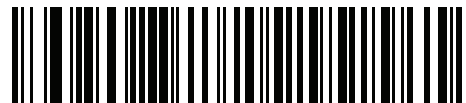

4 msec

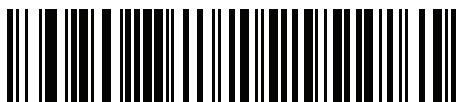

5 msec



## USB Polling Interval (continued)



6 msec

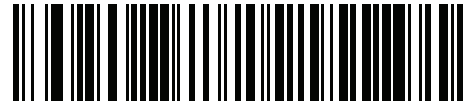

7 msec

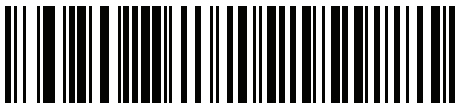

8 msec



9 msec

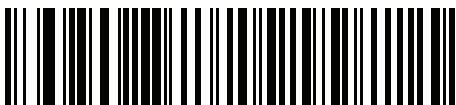

10 msec

## Keypad Emulation

Scan **Enable Keypad Emulation** to send all characters as ASCII sequences over the numeric keypad. For example, ASCII A transmits as “ALT make” 0 6 5 “ALT Break”.



**NOTE:** If your keyboard type is not listed in the country code list (see [Country Codes on page 496](#)), disable [Quick Keypad Emulation](#) and enable **Keypad Emulation**.

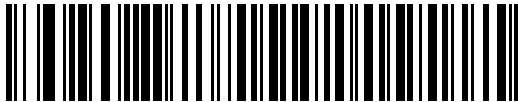

**\*Enable Keypad Emulation**



**Disable Keypad Emulation**

## Quick Keypad Emulation

This option applies only to the USB HID Keyboard device when [Keypad Emulation](#) is enabled. Scan **Enable Quick Keypad Emulation** for a quicker method of emulation using the numeric keypad where ASCII sequences are only sent for ASCII characters not found on the keyboard.



**\*Enable Quick Keypad Emulation**



**Disable Quick Keypad Emulation**

## Keypad Emulation with Leading Zero

Scan **Enable Keypad Emulation with Leading Zero** to send character sequences sent over the numeric keypad as ISO characters which have a leading zero. For example, ASCII A transmits as “ALT MAKE” 0 0 6 5 “ALT BREAK”.



**\*Enable Keypad Emulation with Leading Zero**



**Disable Keypad Emulation with Leading Zero**

## USB Keyboard FN1 Substitution

This option applies only to the USB HID Keyboard device. Scan **Enable USB Keyboard FN1 Substitution** to replace any FN1 character in a GS1 128 barcode with a user-selected Key Category and value. See [FN1 Substitution Values on page 184](#) to set the Key Category and Key Value.



**Enable USB Keyboard FN1 Substitution**

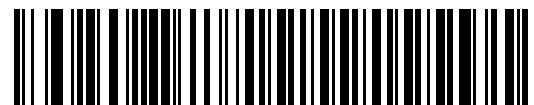

**\*Disable USB Keyboard FN1 Substitution**

## Function Key Mapping

ASCII values under 32 are normally sent as a control-key sequence (see [Table 38 on page 476](#)). Scan **Enable Function Key Mapping** to send the keys in bold in place of the standard key mapping. Table entries that do not have a bold equivalent remain the same regardless of whether you enable this parameter.



**Enable Function Key Mapping**

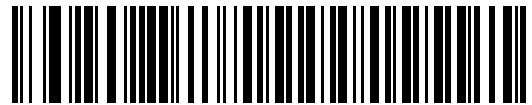

**\*Disable Function Key Mapping**

## Simulated Caps Lock

Scan **Enable Simulated Caps Lock** to invert upper and lower case characters on the barcode as if the Caps Lock state is enabled on the keyboard. This inversion occurs regardless of the keyboard's **Caps Lock** state.



**NOTE:** Simulated Caps Lock applies to ASCII characters only.

Do not enable this if [USB Caps Lock Override on page 65](#) is enabled.

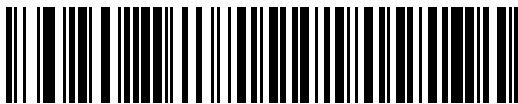

**Enable Simulated Caps Lock**

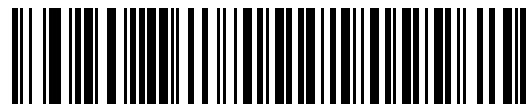

**\*Disable Simulated Caps Lock**

## Convert Case

Scan one of the following barcodes to convert all barcode data to the selected case.



**NOTE:** Convert Case applies to ASCII characters only.

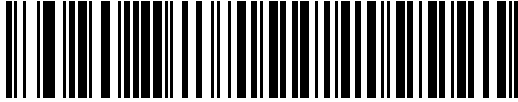

**\*No Case Conversion**

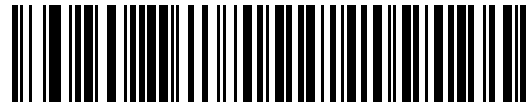

**Convert All to Upper Case**

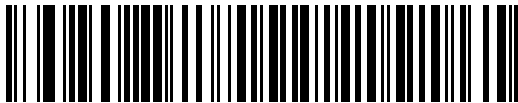

**Convert All to Lower Case**

## USB Static CDC

When disabled, each device connected consumes another COM port (first device = COM1, second device = COM2, third device = COM3, etc.)

When enabled, each device connects to the same COM port.



**\*Enable USB Static CDC**



**Disable USB Static CDC**

## CDC Beep on <BEL>

If you enable this parameter, the scanner issues a beep when it detects a <BEL> character in USB CDC communications. <BEL> indicates an illegal entry or other important event.

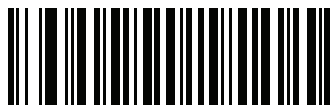

**\*Enable CDC Beep on <BEL>**



**Disable CDC Beep on <BEL>**

## TGCS (IBM) USB Direct I/O Beep

The host can send a direct I/O beep request to the scanner. If you select **Ignore Direct I/O Beep**, the scanner does not sound beeps on this command. All directives are still acknowledged to the USB host as if they were processed.



**\*Honor Direct I/O Beep  
(1)**



**Ignore Direct I/O Beep  
(0)**

## TGCS (IBM) USB Beep Directive

The host can send a beeper configuration request to the scanner. Scan **Ignore Beep Directive** to prevent the scanner from processing the host request. All directives are still acknowledged to the USB host as if they were processed.



**Honor Beep Directive**



**\*Ignore Beep Directive**

## TGCS (IBM) USB Barcode Configuration Directive

The host can enable and disable code types. Scan **Ignore Barcode Configuration Directive** to prevent the scanner from processing the host request. All directives are still acknowledged to the USB host as if they were processed.



**Honor Barcode Configuration Directive**



**\*Ignore Barcode Configuration Directive**

## TGCS (IBM) USB Specification Version

Select **IBM Specification Level Version 0 (Original)** to send the following code types as Unknown:

- Data Matrix
- GS1 Data Matrix
- QR Code
- GS1 QR
- MicroQR Code
- Aztec

Select **IBM Specification Level Version 2.2** to send the code types with the appropriate IBM identifiers.



**IBM Specification Level Version 0 (Original)**



**\*IBM Specification Level Version 2.2**



---

## ASCII Character Sets

See [ASCII Character Sets](#) for the following information:

- [ASCII Character Set on page 476](#)
- [ALT Key Character Set on page 481](#)
- [GUI Key Character Set on page 482](#)
- [PF Key Character Set on page 483](#)
- [F Key Character Set on page 484](#)
- [Numeric Key Character Set on page 485](#)
- [Extended Key Character Set on page 485](#)

# SSI Interface

---

## Introduction

This chapter describes the system requirements of the Simple Serial Interface (SSI), which provides a communications link between Zebra decoders (e.g., scan engines, slot scanners, hand-held scanners, two-dimensional scanners, hands-free scanners, and RF base stations) and a serial host. It provides the means for the host to control the decoder or scanner.

---

## Communication

All communication between the scanner and host occurs over the hardware interface lines using the SSI protocol. Refer to the Simple Serial Interface Programmer's Guide, p/n 72E-40451-xx, for more information on SSI.

The host and the scanner exchange messages in packets. A packet is a collection of bytes framed by the proper SSI protocol formatting bytes. The maximum number of bytes per packet that the SSI protocol allows for any transaction is 257 (255 bytes + 2 byte checksum).

Depending on the configuration, the scanner can send decode data as ASCII data (unpacketed), or as part of a larger message (packeted).

SSI performs the following functions for the host device:

- Maintains a bi-directional interface with the scanner
- Allows the host to send commands that control the scanner
- Passes data from the scanner to a host device in SSI packet format or straight decode message.

The SSI environment consists of a scanner, a serial cable which attaches to the host device, and if required, a power supply.

SSI transmits all decode data including special formatting (e.g., AIM ID). Parameter settings can control the format of the transmitted data.

The scanner can also send parameter information, product identification information, or event codes to the host.

All commands sent between the scanner and host must use the format described in the SSI Message Formats section. [SSI Transactions on page 80](#) describes the required sequence of messages in specific cases.

## SSI Commands

Table 13 lists all the SSI opcodes the scanner supports. The host transmits opcodes designated type H. The scanner (decoder) transmits type D opcodes, and either can transmit Host/Decoder (H/D) types.

**Table 13** SSI Commands

Name	Type	Opcode	Description
AIM_OFF	H	0xC4	Deactivate aiming pattern.
AIM_ON	H	0xC5	Activate aiming pattern.
BEEP	H	0xE6	Sound the beeper.
CAPABILITIES_REPLY	D	0xD4	Reply to CAPABILITIES_REQUEST; contains a list of the capabilities and commands the decoder supports.
CAPABILITIES_REQUEST	H	0xD3	Request capabilities report from the decoder.
CMD_ACK	H/D	0xD0	Positive acknowledgment of received packet.
CMD_NAK	H/D	0xD1	Negative acknowledgment of received packet.
DECODE_DATA	D	0xF3	Decode data in SSI packet format.
EVENT	D	0xF6	Event indicated by associated event code.
LED_OFF	H	0xE8	De-activate LED output.
LED_ON	H	0xE7	Activate LED output.
PARAM_DEFAULTS	H	0xC8	Set parameter default values.
PARAM_REQUEST	H	0xC7	Request values of certain parameters.
PARAM_SEND	H/D	0xC6	Send parameter values.
REPLY_REVISION	D	0xA4	Reply to REQUEST_REVISION, contains the decoder's software/hardware configuration.
REQUEST_REVISION	H	0xA3	Request the decoder's configuration.
SCAN_DISABLE	H	0xEA	Prevent the operator from scanning barcodes.
SCAN_ENABLE	H	0xE9	Permit barcode scanning.
SLEEP	H	0xEB	Request to place the decoder into low power.
START_DECODE	H	0xE4	Tell the decoder to attempt to decode a barcode.
STOP_DECODE	H	0xE5	Tell the decoder to abort a decode attempt.
WAKEUP	H	N/A	Wake the decoder from low power mode.

For details of the SSI protocol, refer to the *Simple Serial Interface Programmer's Guide*.

---

## SSI Transactions

### General Data Transactions

#### ACK/NAK Handshaking

If you enable ACK/NAK handshaking (the default), all packeted messages must have a CMD\_ACK or CMD\_NAK response, unless the command description states otherwise. Zebra recommends leaving this handshaking enabled to provide feedback to the host. Raw decode data and WAKEUP do not use ACK/NAK handshaking since they are not packeted data.

Following is an example of a problem which can occur if you disable ACK/NAK handshaking:

- The host sends a PARAM\_SEND message to the scanner to change the baud rate from 9600 to 19200.
- The scanner cannot interpret the message.
- The scanner does not implement the change the host requested.
- The host assumes that the parameter change occurred and acts accordingly.
- Communication is lost because the change did not occur on both sides.

If you enable ACK/NAK handshaking, the following occurs:

- The host sends a PARAM\_SEND message.
- The scanner cannot interpret the message.
- The scanner CMD\_NAKs the message.
- The host resends the message.
- The scanner receives the message successfully, responds with CMD\_ACK, and implements parameter changes.

## Decoded Data Transmission

The [Decode Data Packet Format](#) parameter controls how decode data is sent to the host. Set this parameter to send the data in a DECODE\_DATA packet. Clear this parameter to transmit the data as raw ASCII data.



**NOTE:** When transmitting decode data as raw ASCII data, ACK/NAK handshaking does not apply regardless of the state of the ACK/NAK handshaking parameter.

### ACK/NAK Enabled and Packeted Data

The scanner sends a DECODE\_DATA message after a successful decode. The scanner waits for a programmable timeout for a CMD\_ACK response. If it does not receive the response, the scanner tries to send two more times before issuing a host transmission error. If the scanner receives a CMD\_NAK from the host, it may attempt a retry depending on the cause field of the CMD\_NAK message.

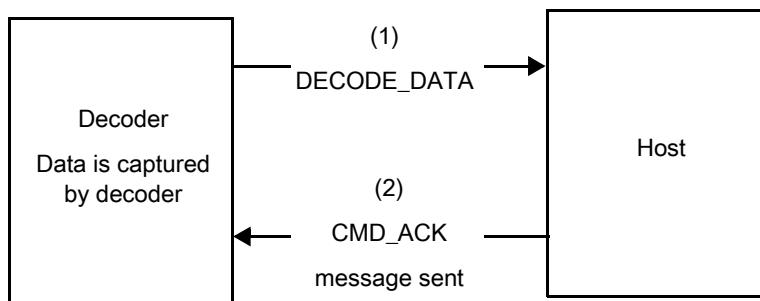

### ACK/NAK Enabled and Unpacketed ASCII Data

Even if ACK/NAK handshaking is enabled, no handshaking occurs because handshaking applies only to packeted data. In this example the packeted\_decode parameter is disabled.

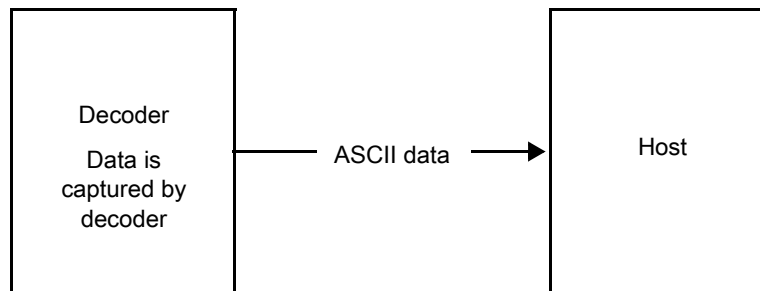

### ACK/NAK Disabled and Packeted DECODE\_DATA

In this example ACK/NAK does not occur even though packeted\_decode is enabled because the ACK/NAK handshaking parameter is disabled.

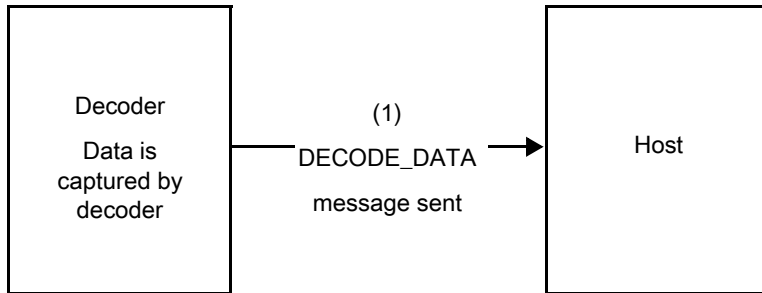

### ACK/NAK Disabled and Unpacketed ASCII Data

The decoder sends captured data to the host.

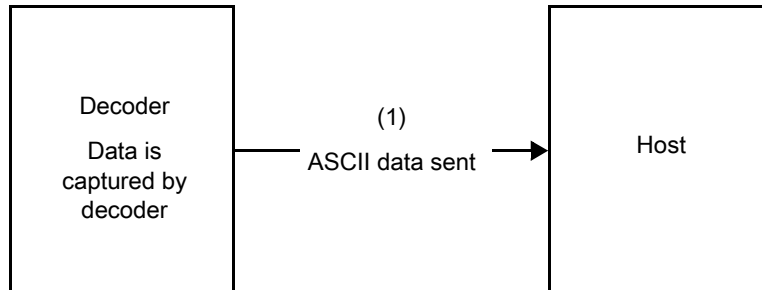

---

## Communication Summary

### RTS/CTS Lines

All communication must use RTS/CTS handshaking as described in the *Simple Serial Interface Programmer's Guide*, p/n 72E-40451-xx. If bypassing hardware handshaking, the host must send the WAKEUP command before all other communication or the first byte of a message can be lost during the scanner wakeup sequence. Zebra recommends not bypassing RTS/CTS hardware handshaking.

### ACK/NAK Option

ACK/NAK handshaking is enabled by default and Zebra recommends leaving it enabled. Disabling this can cause communication problems, as handshaking is the only acknowledgment that a message was received correctly. ACK/NAK is not used with unpacked decode data regardless of whether it is enabled.

### Number of Data Bits

All communication with the scanner must use 8-bit data.

### Serial Response Timeout

The [Host Serial Response Timeout](#) parameter determines how long to wait for a handshaking response before trying again or aborting further attempts. Set the same value for both the host and scanner.



**NOTE:** You can temporarily change the [Host Serial Response Timeout](#) when the host takes longer to process an ACK or longer data string. Zebra does not recommend frequent permanent changes due to limited write cycles of non-volatile memory.

### Retries

The host resends data twice after the initial send if the scanner does not respond with an ACK or NAK (if ACK/NAK handshaking is enabled), or response data (e.g., PARAM\_SEND, REPLY\_REVISION). If the scanner replies with a NAK RESEND, the host resends the data. All resent messages must have the resend bit set in the Status byte.

The scanner resends data two times after the initial send if the host fails to reply with an ACK or NAK (if ACK/NAK handshaking is enabled).

### Baud Rate, Stop Bits, Parity, Response Timeout, ACK/NAK Handshaking

If you use PARAM\_SEND to change these serial parameters, the ACK response to the PARAM\_SEND uses the previous values for these parameters. The new values then take effect for the next transaction.

### Errors

The scanner issues a communication error when:

- The CTS line is asserted when the scanner tries to transmit, and is still asserted on each of two successive retries
- The scanner does not receive an ACK or NAK after initial transmit and two resends.

## SSI Communication Notes

- When not using hardware handshaking, space messages sufficiently apart. The host must not communicate with the scanner if the scanner is transmitting.
- When using hardware handshaking, frame each message properly with handshaking signals. Do not try to send two commands within the same handshaking frame.
- There is a permanent/temporary bit in the PARAM\_SEND message. Removing power from the scanner discards temporary changes. Permanent changes are written to non-volatile memory. Frequent changes shorten the life of the non-volatile memory.

## Using Time Delay to Low Power Mode with SSI

[Time Delay to Low Power Mode on page 156](#) provides options to select a general time delay. To program a more specific delay value, use an SSI command according to [Table 14](#).

**Table 14** Values for Selecting Time Delay to Low Power

Value	Timeout	Value	Timeout	Value	Timeout	Value	Timeout
0x00	15 Min	0x10	1 Sec	0x20	1 Min	0x30	1 Hour
0x01	30 Min	0x11	1 Sec	0x21	1 Min	0x31	1 Hour
0x02	60 Min	0x12	2 Sec	0x22	2 Min	0x32	2 Hours
0x03	90 Min	0x13	3 Sec	0x23	3 Min	0x33	3 Hours
N/A	N/A	0x14	4 Sec	0x24	4 Min	0x34	4 Hours
N/A	N/A	0x15	5 Sec	0x25	5 Min	0x35	5 Hours
N/A	N/A	0x16	6 Sec	0x26	6 Min	0x36	6 Hours
N/A	N/A	0x17	7 Sec	0x27	7 Min	0x37	7 Hours
N/A	N/A	0x18	8 Sec	0x28	8 Min	0x38	8 Hours
N/A	N/A	0x19	9 Sec	0x29	9 Min	0x39	9 Hours
N/A	N/A	0x1A	10 Sec	0x2A	10 Min	0x3A	10 Hours
N/A	N/A	0x1B	15 Sec	0x2B	15 Min	0x3B	15 Hours
N/A	N/A	0x1C	20 Sec	0x2C	20 Min	0x3C	20 Hours
N/A	N/A	0x1D	30 Sec	0x2D	30 Min	0x3D	30 Hours
N/A	N/A	0x1E	45 Sec	0x2E	45 Min	0x3E	45 Hours
N/A	N/A	0x1F	60 Sec	0x2F	60 Min	0x3F	60 Hours



**CAUTION:** With hardware handshaking disabled, the scanner wakes from low power mode upon receiving a character. However, the scanner does not process this character or any others it receives during the 10 ms period following wakeup. Wait at least 10 ms after wakeup to send valid characters.



## Encapsulation of RSM Commands/Responses over SSI

The SSI protocol allows the host to send a command that is variable in length up to 255 bytes. Although there is a provision in the protocol to multi-packet commands from the host, the scanner does not support this. The host must fragment packets using the provisions in the RSM protocol.

### Command Structure

**Table 15** Command Structure

Byte	7	6	5	4	3	2	1	0
0	Length (not including the checksum)							
1	SSI_MGMT_COMMAND (0x80)							
2	Message Source (4 - Host)							
3	Reserved (0)			Reserved (0)		Reserved (0)	Cont'd packet	Retransmit
4	Payload data (see the following example)							
...								
Length -1								
Length	2's complement checksum (MSB)							
Length +1	2's complement checksum (LSB)							

The expected positive response is SSI\_MGMT\_COMMAND which can be a multi-packet response. Devices that do not support this command respond with the standard SSI\_NAK.

### Response Structure

**Table 16** Response Structure

Byte	7	6	5	4	3	2	1	0
0	Length (not including the checksum)							
1	SSI_MGMT_COMMAND (0x80)							
2	Message Source (0 - Decoder)							
3	Reserved (0)			Reserved (0)		Reserved (0)	Cont'd packet	Retransmit
4	Payload data (see the following example)							
...								
Length -1								
Length	2's complement checksum (MSB)							
Length +1	2's complement checksum (LSB)							

## Example Transaction

The following example illustrates how to retrieve diagnostic information (Diagnostic Testing and Reporting (Attribute #10061) decimal) from the scanner using encapsulation of RSM commands over SSI. Before sending an RSM command, the host must send the RSM Get Packet Size command to query the packet size supported by the device.

### Command from Host to Query Packet Size Supported by Device

```
0A 80 04 00 00 06 20 00 FF FF FD 4E
```

Where:

- 0A 80 04 00 is encapsulation of RSM commands over SSI command header
- 00 06 20 00 FF FF is RSM Get Packet Size command
- FD 4E is SSI command checksum

### Response from Device with Packet Size Information

```
0C 80 00 00 00 08 20 00 00 F0 00 F0 FD 6C
```

Where:

- 0C 80 00 00 is encapsulation of RSM command over SSI command header
- 00 08 20 00 00 F0 00 F0 is RSM Get Packet Size response
- FD 6C is SSI response checksum

### Command from Host to Retrieve Diagnostic Information

```
0C 80 04 00 00 08 02 00 27 4D 42 00 FE B0
```

Where:

- 0C 80 04 00 is encapsulation of RSM commands over SSI command header
- 00 08 02 00 27 4D 42 00 is attribute Get command requesting attribute 10061 decimal
- FE B0 is SSI command checksum

### Response from Device with Diagnostic Information

```
21 80 00 00 00 1D 02 00 27 4D 41 01 42 00 0E 00 00 00 00 01 03 02 03 03 03 04 03 05 03 06 03 FF FF FC 15
```

Where:

- 21 80 00 00 00 1D 02 00 27 4D 41 01 42 00 0E 00 00 is encapsulation of RSM responses over SSI command header
- 00 00 01 03 02 03 03 03 04 03 05 03 06 03 is attribute Get response which includes diagnostic report value
- FF FF is attribute Get response, packet termination
- FC 15 is SSI response checksum

## Setting Parameters

This section describes how to set up the scanner with an SSI host. When using SSI, program the scanner via barcode menu or SSI hosts commands.

The scanner ships with the settings shown in [Table 17 on page 88](#) (also see [Standard Parameter Defaults](#) for all defaults). If the default values suit requirements, programming is not necessary.

To set feature values, scan a single barcode or a short barcode sequence. The settings are stored in non-volatile memory and are preserved even when the scanner powers down.



**NOTE:** Most computer monitors allow scanning barcodes directly on the screen. When scanning from the screen, be sure to set the document magnification to a level where you can see the barcode clearly, and bars and/or spaces do not merge.

To return all features to default values, scan [Set Factory Defaults on page 142](#). Throughout the programming barcode menus, asterisks (\*) indicate default values.

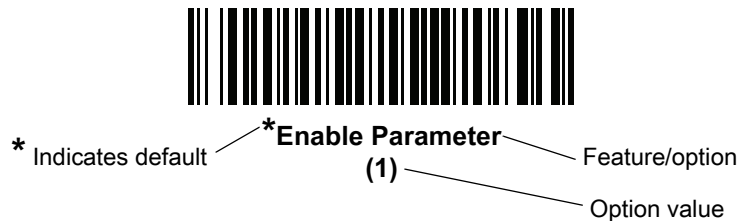

## Scanning Sequence Examples

In most cases scanning one barcode sets the parameter value. For example, to set the baud rate to 19,200, scan the **Baud Rate 19,200** barcode under [Baud Rate on page 89](#). The scanner issues a fast warble beep and the LED turns green, signifying a successful parameter entry.

Other parameters require scanning several barcodes. See the parameter descriptions for this procedure.

## Errors While Scanning

Unless otherwise specified, to correct an error during a scanning sequence, just re-scan the correct parameter.

## Simple Serial Interface Parameter Defaults

Table 13 lists defaults for SSI host parameters. Change these values in one of two ways:

- Scan the appropriate barcodes in this chapter. The new value replaces the standard default value in memory. To recall default parameter values, see [Default Parameters on page 142](#).
- Download data through the device’s serial port using SSI. Hexadecimal parameter numbers appear in this chapter below the parameter title, and option values appear in parenthesis beneath the accompanying barcodes. Refer to the Simple Serial Interface (SSI) Programmer’s Guide for detailed instructions for changing parameters using this method.



**NOTE:** See [Standard Parameter Defaults](#) for all user preference, host, symbology, and miscellaneous default parameters.

**Table 17** SSI Interface Default Table

Parameter	Parameter Number	SSI Number	Default	Page Number
<b>SSI Host Parameters</b>				
Select SSI Host	N/A	N/A	N/A	<a href="#">89</a>
Baud Rate	156	9Ch	9600	<a href="#">89</a>
Parity	158	9Eh	None	<a href="#">91</a>
Check Parity	151	97h	Disable	<a href="#">91</a>
Stop Bits	157	9Dh	1	<a href="#">92</a>
Software Handshaking	159	9Fh	Enable ACK/NAK	<a href="#">93</a>
Host RTS Line State	154	9Ah	Low	<a href="#">94</a>
Decode Data Packet Format	238	EEh	Send Raw Decode Data	<a href="#">94</a>
Host Serial Response Timeout	155	9Bh	2 Seconds	<a href="#">95</a>
Host Character Timeout	239	EFh	200 msec	<a href="#">96</a>
Multipacket Option	334	F0h 4Eh	Option 1	<a href="#">97</a>
Interpacket Delay	335	F0h 4Fh	0 msec	<a href="#">98</a>
<b>Event Reporting</b>				
Decode Event	256	F0h 00h	Disable	<a href="#">99</a>
Boot Up Event	258	F0h 02h	Disable	<a href="#">100</a>
Parameter Event	259	F0h 03h	Disable	<a href="#">100</a>



**NOTE:** SSI interprets Prefix, Suffix1, and Suffix2 values listed in [Table 38 on page 476](#) differently than other interfaces. SSI does not recognize key categories, only the 3-digit decimal value. The default value of 7013 is interpreted as CR only.

## SSI Host Parameters

### Select SSI Host

To select SSI as the host interface, scan the following barcode.



**SSI Host**

### Baud Rate

#### Parameter # 156

#### SSI # 9Ch

Baud rate is the number of bits of data transmitted per second. Scan one of the following barcodes to set the scanner's baud rate to match the baud rate setting of the host device. Otherwise, data may not reach the host device or may reach it in distorted form.



**\*Baud Rate 9600  
(6)**



**Baud Rate 19,200  
(7)**



**Baud Rate 38,400  
(8)**

**Baud Rate (continued)**



**Baud Rate 57,600  
(10)**



**Baud Rate 115,200  
(11)**



**Baud Rate 230,400  
(13)**



**Baud Rate 460,800  
(14)**



**Baud Rate 921,600  
(15)**

## Parity

### Parameter # 158

#### SSI # 9Eh

A parity check bit is the most significant bit of each ASCII coded character. Scan one of the following barcodes to select the parity type according to host device requirements:

- **Odd** - This sets the parity bit value to 0 or 1, based on data, to ensure that the coded character contains an odd number of 1 bits.
- **Even** - This sets the parity bit value to 0 or 1, based on data, to ensure that the coded character contains an even number of 1 bits.
- **None** - No parity bit is required.



**Odd  
(2)**



**Even  
(1)**



**\*None  
(0)**

## Check Parity

### Parameter # 151

#### SSI # 97h

Scan one of the following barcodes to select whether to check the parity of received characters. See [Parity](#) to select the type of parity.



**\*Do Not Check Parity  
(0)**



**Check Parity  
(1)**

## Stop Bits

### Parameter # 157

### SSI # 9Dh

The stop bit(s) at the end of each transmitted character marks the end of transmission of one character and prepares the receiving device for the next character in the serial data stream. Scan one of the following barcodes to set the number of stop bits (one or two) based on the number the receiving host can accommodate.



**\*1 Stop Bit  
(1)**



**2 Stop Bits  
(2)**



## Software Handshaking

### Parameter # 159

#### SSI # 9Fh

This parameter offers control of data transmission in addition to the control hardware handshaking offers. Hardware handshaking is always enabled; you cannot disable it.

Options:

- **Disable ACK/NAK Handshaking** - The scanner neither generates nor expects ACK/NAK handshaking packets.
- **Enable ACK/NAK Handshaking** - After transmitting data, the scanner expects either an ACK or NAK response from the host. The scanner also ACKs or NAKs messages from the host.

The scanner waits up to the programmable [Host Serial Response Timeout](#) to receive an ACK or NAK. If the scanner does not get a response in this time, it resends its data up to two times before discarding the data and declaring a transmission error.



**Disable ACK/NAK  
(0)**



**\*Enable ACK/NAK  
(1)**

## Host RTS Line State

### Parameter # 154

#### SSI # 9Ah

Scan one of the following barcodes to set the expected idle state of the Serial Host RTS line.

The SSI interface is used with host applications which also implement the SSI protocol. However, you can use the scanner in a "scan-and-transmit" mode to communicate with any standard serial communication software on a host PC (see [Decode Data Packet Format on page 94](#)). If transmission errors occur in this mode, the host PC may be asserting hardware handshaking lines which interfere with the SSI protocol. Scan the **High** barcode to address this problem.



**\*Low  
(0)**



**High  
(1)**

## Decode Data Packet Format

### Parameter # 238

#### SSI # EEh

Scan one of the following barcodes to select whether to transmit decoded data in raw format (unpacked), or with the packet format defined by the serial protocol.

Selecting the raw format disables ACK/NAK handshaking for decode data.



**\*Send Raw Decode Data  
(0)**



**Send Packeted Decode Data  
(1)**

## Host Serial Response Timeout

### Parameter # 155

#### SSI # 9Bh

Scan one of the following barcodes to specify how long the scanner waits for an ACK or NAK before resending. Also, if the scanner wants to send, and the host has already been granted permission to send, the scanner waits for the designated timeout before declaring an error.



**NOTE:** Other values are available via SSI command.



**\*Low - 2 Seconds  
(20)**



**Medium - 5 Seconds  
(50)**



**High - 7.5 Seconds  
(75)**



**Maximum - 9.9 Seconds  
(99)**

## Host Character Timeout

### Parameter # 239

#### SSI # EFh

Scan one of the following barcodes to specify the maximum time the scanner waits between characters transmitted by the host before discarding the received data and declaring an error.



**NOTE:** Other values are available via SSI command.



**\*Low - 200 msec  
(20)**



**Medium - 500 msec  
(50)**



**High - 750 msec  
(75)**



**Maximum - 990 msec  
(99)**

## Multipacket Option

### Parameter # 334

### SSI # F0h 4Eh

Scan one of the following barcodes to control ACK/NAK handshaking for multi-packet transmissions:

- **Multi-Packet Option 1** - The host sends an ACK/NAK for each data packet during a multi-packet transmission.
- **Multi-Packet Option 2** - The scanner sends data packets continuously, with no ACK/NAK handshaking to pace the transmission. The host, if overrun, can use hardware handshaking to temporarily delay scanner transmissions. At the end of transmission, the scanner waits for a CMD\_ACK or CMD\_NAK.
- **Multi-Packet Option 3** - This is the same as option 2 with the addition of a programmable interpacket delay. See [Interpacket Delay on page 98](#) to set this delay.



**\*Multipacket Option 1  
(0)**



**Multipacket Option 2  
(1)**



**Multipacket Option 3  
(2)**

## Interpacket Delay

### Parameter # 335

### SSI # F0h 4Fh

Scan one of the following barcodes to specify the interpacket delay if you selected **Multipacket Option 3**.



**NOTE:** Other values are available via SSI command.



**\*Minimum - 0 msec  
(0)**



**Low - 25 msec  
(25)**



**Medium - 50 msec  
(50)**



**High - 75 msec  
(75)**



**Maximum - 99 msec  
(99)**

## Event Reporting

The host can request the scanner to provide certain information (events) relative to scanner behavior. Scan the following barcodes to enable or disable the events listed in [Table 18](#) and on the following pages.

**Table 18** Event Codes

Event Class	Event	Code Reported
Decode Event	Non-parameter decode	0x01
Boot Up Event	System power-up	0x03
Parameter Event	Parameter entry error	0x07
	Parameter stored	0x08
	Defaults set (and parameter event is enabled by default)	0x0A
	Number expected	0x0F

### Decode Event

#### Parameter # 256

#### SSI # F0h 00h

Scan one of the following barcodes to enable or disable Decode Event.

- **Enable Decode Event** - The scanner generates a message to the host upon a successful barcode decode.
- **Disable Decode Event** - No notification is sent.

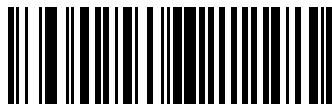

**Enable Decode Event  
(1)**

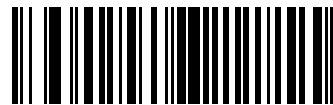

**\*Disable Decode Event  
(0)**

## Boot Up Event

### Parameter # 258

#### SSI # F0h 02h

Scan one of the following barcodes to enable or disable Boot Up Event:

- **Enable Boot Up Event** - The scanner generates a message to the host whenever power is applied.
- **Disable Boot Up Event** - No notification is sent.

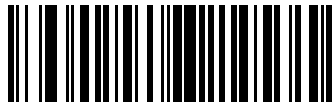

**Enable Boot Up Event  
(1)**

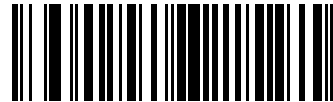

**\*Disable Boot Up Event  
(0)**

## Parameter Event

### Parameter # 259

#### SSI # F0h 03h

Scan one of the following barcodes to enable or disable Parameter Event:

- **Enable Parameter Event** - The scanner generates a message to the host when one of the events specified in [Table 18 on page 99](#) occurs.
- **Disable Parameter Event** - No notification is sent.

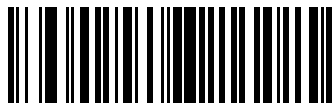

**Enable Parameter Event  
(1)**

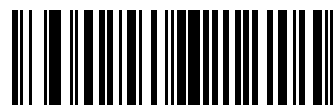

**\*Disable Parameter Event  
(0)**



# RS-232 Interface

---

## Introduction

This chapter describes how to set up the scanner with an RS-232 host. The scanner uses the RS-232 interface to connect to point-of-sale devices, host computers, or other devices with an available RS-232 port (e.g., com port).

The scanner ships with the settings shown in [Table 19 on page 103](#) (also see [Standard Parameter Defaults](#) for all defaults). If the default values suit requirements, programming is not necessary.

If your host does not appear in [Table 20](#), refer to the documentation for the host device to set communication parameters to match the host.



**NOTE:** The scanner uses TTL RS-232 signal levels, which interface with most system architectures. For system architectures requiring RS-232C signal levels, Zebra offers different cables providing TTL-to-RS-232C conversion. Contact support for more information.

---

## Setting Parameters

To set feature values, scan a single barcode or a short barcode sequence. The settings are stored in non-volatile memory and are preserved even when the scanner powers down.



**NOTE:** Most computer monitors allow scanning barcodes directly on the screen. When scanning from the screen, be sure to set the document magnification to a level where you can see the barcode clearly, and bars and/or spaces do not merge.

To return all features to default values, scan [Set Factory Defaults on page 142](#). Throughout the programming barcode menus, asterisks (\*) indicate default values.



\* Indicates default      \*Enable Parameter      Feature/option

## Scanning Sequence Examples

In most cases scanning one barcode sets the parameter value. For example, to set the baud rate to 19,200, scan the **Baud Rate 19,200** barcode under [Baud Rate on page 109](#). The scanner issues a fast warble beep and the LED turns green, signifying a successful parameter entry.

Other parameters require scanning several barcodes. See the parameter descriptions for this procedure.

## Errors While Scanning

Unless otherwise specified, to correct an error during a scanning sequence, just re-scan the correct parameter.

---

## Connecting an RS-232 Interface

Connect the scanner directly to the host computer.

**Figure 14** RS-232 Connection

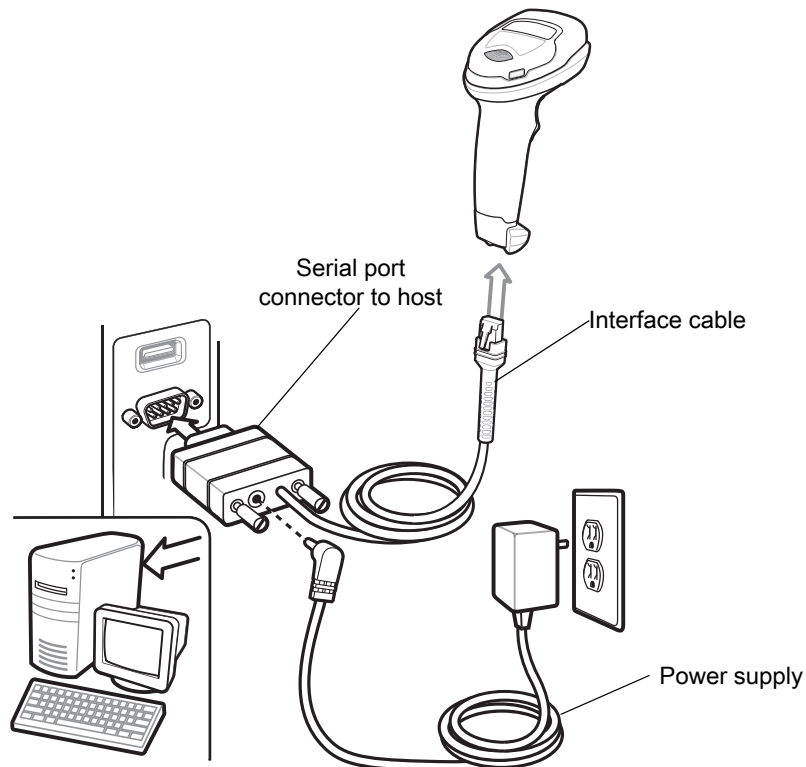

**NOTE:** Interface cables vary depending on configuration. The connectors can be different than those illustrated in [Figure 14](#), but the steps to connect the scanner are the same.

1. Attach the modular connector of the RS-232 interface cable to the cable interface port on the scanner. See [Inserting the Interface Cable on page 28](#).
2. Connect the other end of the RS-232 interface cable to the serial port on the host.
3. If required, connect the power supply to the serial connector end of the RS-232 interface cable. Plug the power supply into an appropriate outlet.

4. The scanner automatically detects the host interface type and uses the default setting. If the default (\*) does not meet your requirements, select another RS-232 host type by scanning the appropriate barcode from [RS-232 Host Types on page 107](#).
5. To modify any other parameter options, scan the appropriate barcodes in this chapter.

If problems occur with the system, see [Troubleshooting on page 46](#).

## RS-232 Parameter Defaults

[Table 19](#) lists defaults for RS-232 host parameters. Change these values in one of two ways:

- Scan the appropriate barcodes in this chapter. The new value replaces the standard default value in memory. To recall default parameter values, see [Default Parameters on page 142](#).
- Configure the scanner using the 123Scan configuration program. See [123Scan and Software Tools](#).



**NOTE:** See [Standard Parameter Defaults](#) for all user preference, host, symbology, and miscellaneous default parameters.

**Table 19** RS-232 Interface Parameter Defaults

Parameter	Default	Page Number
<b>RS-232 Host Parameters</b>		
RS-232 Host Types	Standard	<a href="#">107</a>
Baud Rate	9600	<a href="#">109</a>
Parity	None	<a href="#">111</a>
Stop Bits	1 Stop Bit	<a href="#">112</a>
Data Bits	8-bit	<a href="#">112</a>
Check Receive Errors	Enable	<a href="#">113</a>
Hardware Handshaking	None	<a href="#">113</a>
Software Handshaking	None	<a href="#">115</a>
Host Serial Response Timeout	2 Seconds	<a href="#">117</a>
RTS Line State	Low RTS	<a href="#">118</a>
Beep on <BEL>	Disable	<a href="#">118</a>
Intercharacter Delay	0 msec	<a href="#">119</a>
Nixdorf Beep/LED Options	Normal Operation	<a href="#">120</a>
Barcodes with Unknown Characters	Send Barcode With Unknown Characters	<a href="#">120</a>

## RS-232 Host-Specific Parameter Settings

Various RS-232 hosts use their own parameter default settings. Selecting standard, ICL, Fujitsu, Wincor-Nixdorf Mode A or B, OPOS/JPOS, Olivetti, Omron, or Common Use Terminal Equipment (CUTE-LP/LG barcode readers) sets the defaults listed in [Table 20](#) and [Table 21](#).

**Table 20** RS-232 Host-Specific Settings

Parameter	ICL	Fujitsu	Wincor-Nixdorf Mode A	Wincor-Nixdorf Mode B/ OPOS/JPOS
Baud Rate	9600	9600	9600	9600
Parity	Even	None	Odd	Odd
Stop Bits	One	One	One	One
Data Bits	8-bit	8-bit	8-bit	8-bit
Hardware Handshaking	RTS/CTS Option 3	None	RTS/CTS Option 3	RTS/CTS Option 3
Software Handshaking	None	None	None	None
Serial Response Timeout	9.9 Seconds	2 Seconds	None	None
RTS Line State	High	Low	Low	Low = No data to send
Beep On <BEL>	Disable	Disable	Disable	Disable
Transmit Code ID	Yes	Yes	Yes	Yes
Data Transmission Format	Data/Suffix	Data/Suffix	Data/Suffix	Data/Suffix
Prefix	None	None	None	None
Suffix	CR (1013)	CR (1013)	CR (1013)	CR (1013)

In the Wincor-Nixdorf Mode A/B, when CTS is low, scanning is disabled and when CTS is high, scanning is enabled.

If you scan Wincor-Nixdorf RS-232 Mode A/B without connecting the scanner to the proper host, it may appear unable to scan. In this case, scan a different RS-232 host type within 5 seconds of cycling power to the scanner.

**Table 21** RS-232 Host-Specific Settings

Parameter	Olivetti	Omron	CUTE
Baud Rate	9600	9600	9600
Parity	Even	None	None
Stop Bits	One	One	One
Data Bits	7-bit	8-bit	8-bit

The CUTE host disables all parameter scanning, including Set Defaults. If you inadvertently select CUTE, scan [\\*Enable Parameter Barcode Scanning \(1\)](#) on page 143, and then change the host selection.

**Table 21** RS-232 Host-Specific Settings (Continued)

Parameter	Olivetti	Omron	CUTE
Hardware Handshaking	None	None	None
Software Handshaking	ACK/NAK	None	None
Serial Response Timeout	9.9 Seconds	9.9 Seconds	9.9 Seconds
RTS Line State	Low	High	High
Beep On <BEL>	Disable	Disable	Disable
Transmit Code ID	Yes	Yes	Yes
Data Transmission Format	Prefix/Data/ Suffix	Data/Suffix	Prefix/Data/ Suffix
Prefix	STX (1003)	None	STX (1002)
Suffix	ETX (1002)	CR (1013)	CR (1013) ETX (1003)

The CUTE host disables all parameter scanning, including Set Defaults. If you inadvertently select CUTE, scan [\\*Enable Parameter Barcode Scanning \(1\) on page 143](#), and then change the host selection.

## RS-232 Host-Specific Code ID Characters

Selecting ICL, Fujitsu, Wincor-Nixdorf Mode A or B, OPOS/JPOS, Olivetti, Omron, or CUTE transmits the code ID characters listed in [Table 22](#) and [Table 23](#). These characters are not programmable and are separate from the Transmit Code ID feature. Do not enable the Transmit Code ID feature for these hosts.

**Table 22** RS-232 Host-Specific Code ID Characters

Code Type	ICL	Fujitsu	Wincor-Nixdorf Mode A	Wincor-Nixdorf Mode B/ OPOS/JPOS
UPC-A	A	A	A	A
UPC-E	E	E	C	C
EAN-8/JAN-8	FF	FF	B	B
EAN-13/JAN-13	F	F	A	A
Bookland EAN	F	F	A	A
Code 128	L <len>	None	K	K
GS1-128	L <len>	None	P	P
Code 39	C <len>	None	M	M
Code 39 Full ASCII	None	None	M	M
Trioptic	None	None	None	None
Code 32	None	None	None	None
Code 93	None	None	L	L

**Table 22** RS-232 Host-Specific Code ID Characters (Continued)

Code Type	ICL	Fujitsu	Wincor-Nixdorf Mode A	Wincor-Nixdorf Mode B/ OPOS/JPOS
I 2 of 5	I <len>	None	I	I
D 2 of 5	H <len>	None	H	H
IATA	H<len>	None	H	H
Codabar	N <len>	None	N	N
MSI	None	None	O	O
GS1 DataBar Variants	None	None	E	E
PDF417	None	None	Q	Q
MicroPDF417	None	None	S	S
Data Matrix	None	None	R	R
GS1 Data Matrix	None	None	W	W
Maxicode	None	None	T	T
QR Code	None	None	U	U
GS1 QR	None	None	X	X
Aztec/Aztec Rune	None	None	V	V

**Table 23** RS-232 Host-Specific Code ID Characters

Code Type	Olivetti	Omron	CUTE
UPC-A	A	A	A
UPC-E	C	E	None
EAN-8/JAN-8	B	FF	None
EAN-13/JAN-13	A	F	A
Bookland EAN	A	F	None
Code 128	K <len>	L <len>	5
GS1-128	P <len>	L <len>	5
Code 39	M <len>	C <len>	3
Code 39 Full ASCII	None	None	3
Trioptic	None	None	None
Code 32	None	None	None
Code 93	L <len>	None	None

\*This host does not support 2D barcodes.

**Table 23** RS-232 Host-Specific Code ID Characters (Continued)

Code Type	Olivetti	Omron	CUTE
I 2 of 5	I <len>	I <len>	1
D 2 of 5	H <len>	H <len>	2
IATA	H<len>	H<len>	2
Codabar	N <len>	N <len>	None
MSI	O <len>	None	None
GS1 DataBar Variants	None	None	None
PDF417	None	None	6
MicroPDF417	None	None	6
Data Matrix	None	None	4
QR Code	None	None	7
Aztec/Aztec Rune	None	None	8

\*This host does not support 2D barcodes.

## RS-232 Host Types

To select an RS-232 host interface, scan one of the following barcodes.



**NOTES 1** For a list of supported scanner functionality by communication protocol, see [Communication Protocol Functionality](#).

2. Scanning **Standard RS-232** activates the RS-232 driver, but does not change port settings (e.g., parity, data bits, handshaking). Selecting another RS-232 host type barcode changes these settings.

3. The CUTE host disables all parameter scanning, including Set Defaults. If you inadvertently select **CUTE**, scan [\\*Enable Parameter Barcode Scanning \(1\) on page 143](#), and then change the host selection.

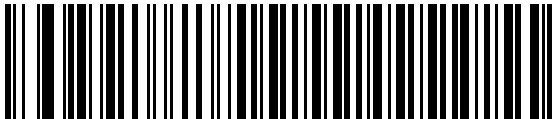

**\*Standard RS-232**

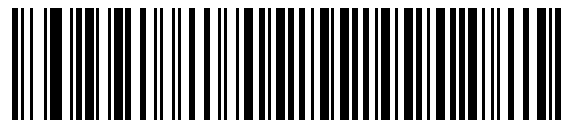

**ICL RS-232**

### RS-232 Host Types (continued)

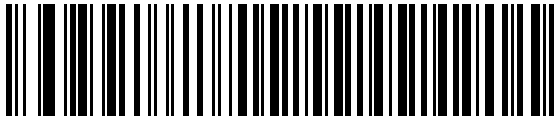

Wincor-Nixdorf RS-232 Mode A

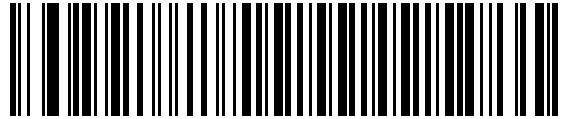

Wincor-Nixdorf RS-232 Mode B

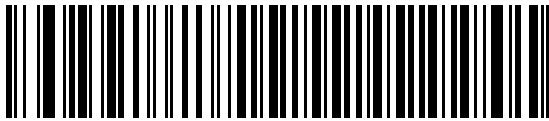

Olivetti ORS4500

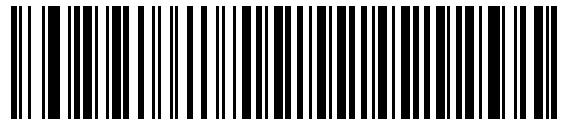

Omron

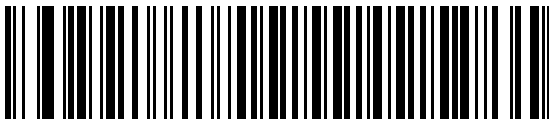

OPOS/JPOS



Fujitsu RS-232



CUTE



## Baud Rate

Baud rate is the number of bits of data transmitted per second. Scan one of the following barcodes to set the scanner's baud rate to match the baud rate setting of the host device. Otherwise, data may not reach the host device or may reach it in distorted form.



**NOTE:** The scanner does not support baud rates below 9600.



**\*Baud Rate 9600**



**Baud Rate 19,200**



**Baud Rate 38,400**



**Baud Rate 57,600**

**Baud Rate (continued)**



**Baud Rate 115,200**

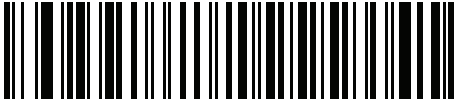

**Baud Rate 230,400**



**Baud Rate 460,800**

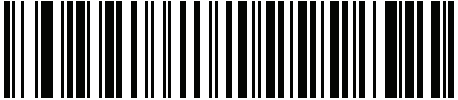

**Baud Rate 921,600**

## Parity

A parity check bit is the most significant bit of each ASCII coded character. Scan one of the following barcodes to select the parity type according to host device requirements:

- **Odd** - This sets the parity bit value to 0 or 1, based on data, to ensure that the coded character contains an odd number of 1 bits.
- **Even** - This sets the parity bit value to 0 or 1, based on data, to ensure that the coded character contains an even number of 1 bits.
- **None** - No parity bit is required.



**Odd**



**Even**



**\*None**

## Stop Bits

The stop bit(s) at the end of each transmitted character marks the end of transmission of one character and prepares the receiving device for the next character in the serial data stream. Scan one of the following barcodes to set the number of stop bits (one or two) based on the number the receiving host can accommodate.

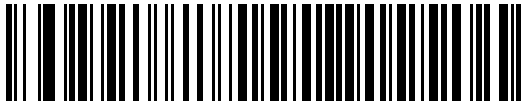

**\*1 Stop Bit**

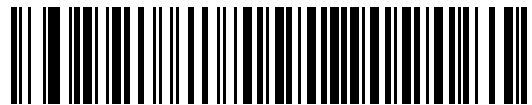

**2 Stop Bits**

## Data Bits

This parameter allows the scanner to interface with devices requiring a 7-bit or 8-bit ASCII protocol.

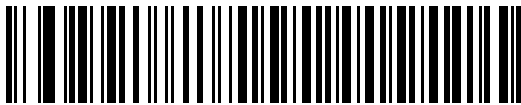

**7-bit**

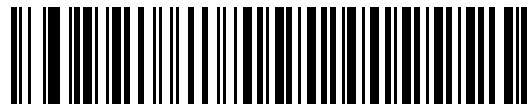

**\*8-bit**

## Check Receive Errors

Scan one of the following barcodes to set whether to check the parity, framing, and overrun of received characters. The parity value of received characters is verified against the value set for [Parity on page 111](#).

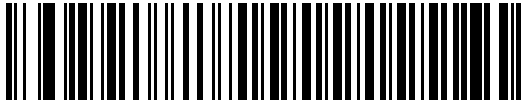

**\*Check For Received Errors**

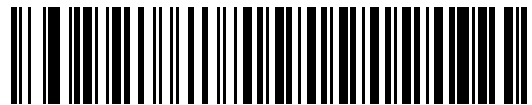

**Do Not Check For Received Errors**

## Hardware Handshaking

The data interface consists of an RS-232 port designed to operate either with or without the hardware handshaking lines Request to Send (RTS) and Clear to Send (CTS).

If hardware handshaking and software handshaking are both enabled, hardware handshaking takes precedence.



**NOTE:** The DTR signal is jumpered to the active state.

Options:

- **None** - This disables hardware handshaking and transmits scan data as it becomes available.
- **Standard RTS/CTS** - This sets standard RTS/CTS hardware handshaking and transmits scanned data according to the following sequence:
  - a. The scanner reads the CTS line for activity:
    - If the CTS line is de-asserted, the scanner asserts the RTS line and waits up to [Host Serial Response Timeout on page 117](#) for the host to assert CTS, and then transmits data when asserted. If, after the timeout, the CTS line is not asserted, the scanner sounds a transmit error and discards the data.
    - If CTS is asserted, the scanner waits up to [Host Serial Response Timeout](#) for the host to de-assert CTS. If after this timeout the CTS line is still asserted, the scanner sounds a transmit error and discards the scanned data.
  - b. The scanner de-asserts RTS after sending the last character of data.
  - c. The host negates CTS. The scanner checks for a de-asserted CTS upon the next data transmission.

During data transmission, if CTS is deasserted for more than 50 ms between characters, the scanner sounds a transmit error and discards the data. The data must be re-scanned.

- **RTS/CTS Option 1** - The scanner asserts RTS before transmitting and ignores the state of CTS. The scanner de-asserts RTS when transmission completes.
- **RTS/CTS Option 2** - RTS is always high or low (user-programmed logic level). However, the scanner waits for the host to assert CTS before transmitting data. If CTS is not asserted within the [Host Serial](#)

**Response Timeout**, the scanner sounds a transmit error and discards the data. During data transmission, if CTS is deasserted for more than 50 ms between characters, the scanner sounds a transmit error and discards the data.

- **RTS/CTS Option 3** - This transmits scanned data according to the following sequence:
  - d. The scanner asserts RTS before data transmission, regardless of the state of CTS.
  - e. The scanner waits up to the **Host Serial Response Timeout** for the host to assert CTS, and then transmits data when asserted. If, after the timeout, the CTS line is not asserted, the scanner sounds a transmit error and discards the data.
  - f. The scanner de-asserts RTS after sending the last character of data.
  - g. The host negates CTS. The scanner checks for a de-asserted CTS upon the next data transmission.

During data transmission, if CTS is deasserted for more than 50 ms between characters, the scanner sounds a transmit error and discards the data. The data must be re-scanned.



**\*None**



**Standard RTS/CTS**

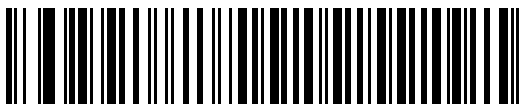

**RTS/CTS Option 1**



**RTS/CTS Option 2**



**RTS/CTS Option 3**

## Software Handshaking

This parameter offers control of data transmission in addition to, or instead of, that offered by hardware handshaking. If software handshaking and hardware handshaking are both enabled, hardware handshaking takes precedence.

Options:

- **None** - This transmits data immediately. The scanner expects no response from the host.
- **ACK/NAK** - After transmitting data, the scanner waits for an ACK or NAK response from the host. If it receives a NAK, the scanner transmits the data again and waits for an ACK or NAK. After three unsuccessful attempts to send data after receiving NAKs, the scanner sounds a transmit error and discards the data.

The scanner waits up to the programmable [Host Serial Response Timeout](#) to receive an ACK or NAK. If the scanner does not get a response in this time, it sounds a transmit error and discards the data. There are no reattempts.

- **ENQ** - The scanner waits for an ENQ character from the host before transmitting data. If it does not receive an ENQ within the [Host Serial Response Timeout](#), the scanner sounds a transmit error and discards the data. The host must transmit an ENQ character at least every [Host Serial Response Timeout](#) to prevent transmission errors.
- **ACK/NAK with ENQ** - This combines the two previous options. An additional ENQ is not required to re-transmit data due to a NAK from the host.
- **XON/XOFF** - An XOFF character stops data transmission until the scanner receives an XON character. There are two situations for XON/XOFF:
  - The scanner receives an XOFF before it has data to send. When the scanner has data, it waits up to the [Host Serial Response Timeout](#) for an XON character before transmitting. If it does not receive the XON within this time, the scanner sounds a transmit error and discards the data.
  - The scanner receives an XOFF during data transmission and stops transmission after sending the current byte. When the scanner receives an XON character, it sends the rest of the data. The scanner waits indefinitely for the XON.

Software Handshaking (continued)



\*None

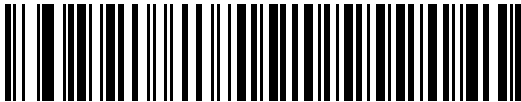

ACK/NAK

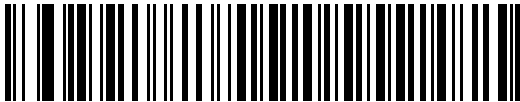

ENQ

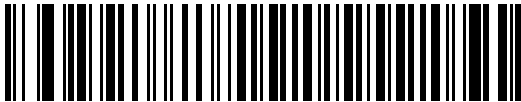

ACK/NAK with ENQ

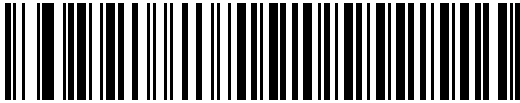

XON/XOFF



## Host Serial Response Timeout

Scan one of the following barcodes to specify how long the scanner waits for an ACK, NAK, or CTS before determining that a transmission error occurred. This only applies when in one of the ACK/NAK software handshaking modes, or RTS/CTS hardware handshaking mode,



**\*Minimum: 2 Seconds**

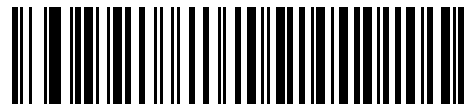

**Low: 2.5 Seconds**



**Medium: 5 Seconds**

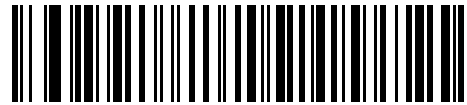

**High: 7.5 Seconds**

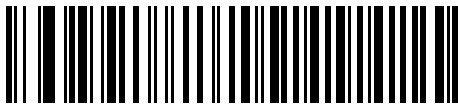

**Maximum: 9.9 Seconds**

## RTS Line State

Scan one of the following barcodes to set the idle state of the serial host RTS line to **Low RTS** or **High RTS**.



**\*Host: Low RTS**

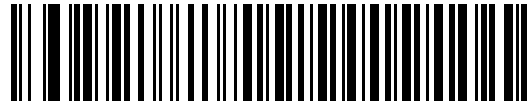

**Host: High RTS**

## Beep on <BEL>

Scan one of the following barcodes to set whether the scanner issues a beep when it detects a <BEL> character on the RS-232 serial line. <BEL> indicates an illegal entry or other important event.

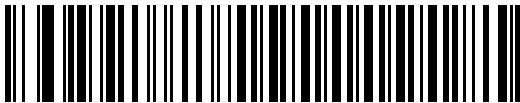

**Beep On <BEL> Character  
(Enable)**

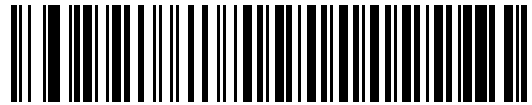

**\*Do Not Beep On <BEL> Character  
(Disable)**

## Intercharacter Delay

Scan one of the following barcodes to specify the intercharacter delay inserted between character transmissions.



**\*Minimum: 0 msec**



**Low: 25 msec**

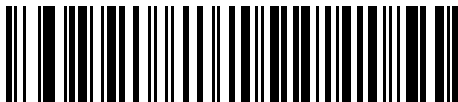

**Medium: 50 msec**



**High: 75 msec**

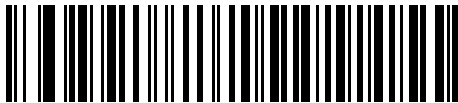

**Maximum: 99 msec**

## Nixdorf Beep/LED Options

If you selected Nixdorf Mode B, scan one of the following barcodes to indicate when the scanner beeps and turns on its LED after a decode.



**\*Normal Operation**  
(Beep/LED Immediately After Decode)

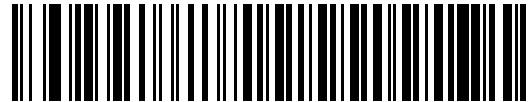

**Beep/LED After Transmission**

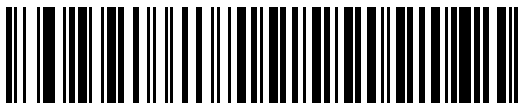

**Beep/LED After CTS Pulse**

## Barcodes with Unknown Characters

Unknown characters are characters the host does not recognize. Scan **Send Barcodes With Unknown Characters** to send all barcode data except for unknown characters. The scanner issues no error beeps.

Scan **Do Not Send Barcodes With Unknown Characters** to send barcode data up to the first unknown character. The scanner issues an error beep.

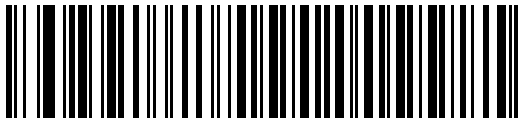

**\*Send Barcodes With Unknown Characters**



**Do Not Send Barcodes With Unknown Characters**

---

## ASCII Character Sets

See [ASCII Character Set on page 476](#) for prefix/suffix values.

# IBM 468X / 469X Interface

---

## Introduction

This chapter describes how to set up the scanner with an IBM 468X/469X host.

The scanner ships with the settings shown in [Table 24 on page 124](#) (also see [Standard Parameter Defaults](#) for all defaults). If the default values suit requirements, programming is not necessary.

---

## Setting Parameters

To set feature values, scan a single barcode or a short barcode sequence. The settings are stored in non-volatile memory and are preserved even when the scanner powers down.



**NOTE:** Most computer monitors allow scanning barcodes directly on the screen. When scanning from the screen, be sure to set the document magnification to a level where you can see the barcode clearly, and bars and/or spaces do not merge.

To return all features to default values, scan [Set Factory Defaults on page 142](#). Throughout the programming barcode menus, asterisks (\*) indicate default values.

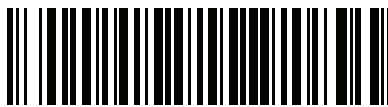

\* Indicates default      \*Enable Parameter      Feature/option

## Scanning Sequence Examples

In most cases scanning one barcode sets the parameter value. For example, to select the Port 9B address, scan the **Hand-held Scanner Emulation (Port 9B)** barcode under [Port Address on page 125](#). The scanner issues a fast warble beep and the LED turns green, signifying a successful parameter entry.

Other parameters require scanning several barcodes. See the parameter descriptions for this procedure.

## Errors While Scanning

Unless otherwise specified, to correct an error during a scanning sequence, just re-scan the correct parameter.

## Connecting an IBM 468X/469X Host

Connect the scanner directly to the host computer.

**Figure 15** IBM Connection

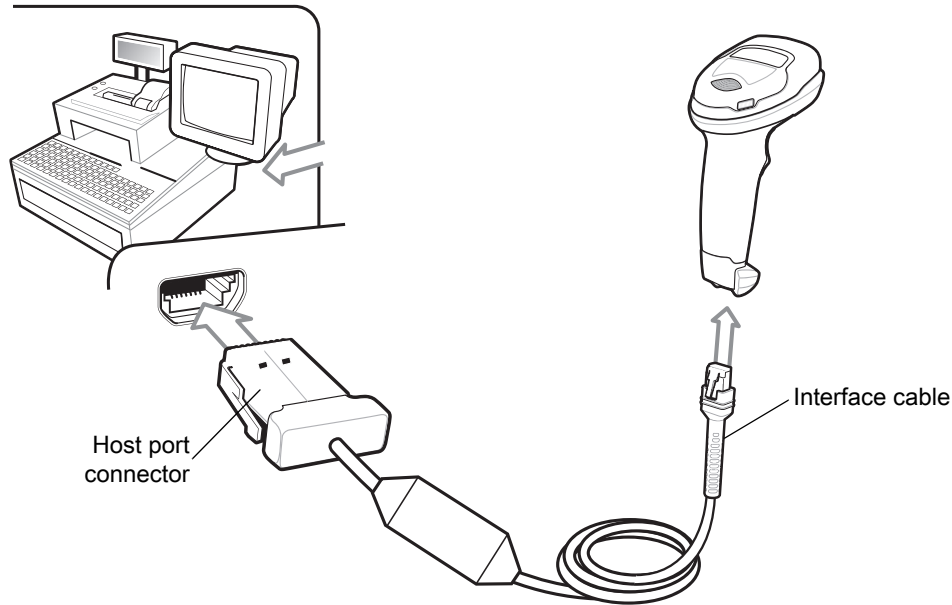

**NOTE:** Interface cables vary depending on configuration. The connectors can be different than those illustrated in [Figure 15](#), but the steps to connect the scanner are the same.

1. Attach the modular connector of the IBM 46XX interface cable to the cable interface port on the scanner. See [Inserting the Interface Cable on page 28](#).
2. Connect the other end of the IBM 46XX interface cable to the appropriate port on the host (typically Port 9).
3. The scanner automatically detects the host interface type, but there is no default setting. Scan the appropriate barcode from [Port Address on page 125](#) to select the port address.
4. To modify any other parameter options, scan the appropriate barcodes in this chapter.



**NOTE:** The only required configuration is the port address. The IBM system typically controls other scanner parameters.

If problems occur with the system, see [Troubleshooting on page 46](#).

## IBM Parameter Defaults

Table 24 lists defaults for IBM host parameters. Change these values in one of two ways:

- Scan the appropriate barcodes in this chapter. The new value replaces the standard default value in memory. To recall default parameter values, see [Default Parameters on page 142](#).
- Configure the scanner using the 123Scan configuration program. See [123Scan and Software Tools](#).



**NOTE:** See [Standard Parameter Defaults](#) for all user preference, host, symbology, and miscellaneous default parameters.

**Table 24** IBM 468X/469X Interface Parameter Defaults

Parameter	Default	Page Number
<b>IBM 468X/469X Host Parameters</b>		
Port Address	None	<a href="#">125</a>
Convert Unknown to Code 39	Disable	<a href="#">126</a>
RS-485 Beep Directive	Ignore	<a href="#">126</a>
RS-485 Barcode Configuration Directive	Ignore	<a href="#">127</a>
IBM-485 Specification Version	Original Specification	<a href="#">127</a>



---

## IBM Host Parameters

### Port Address

Scan one of the following barcodes to select the IBM 468X/469X port.



- NOTES**
- 4 Scanning a Port Address barcode enables the RS-485 interface on the scanner.
  5. For a list of supported scanner functionality by communication protocol, see [Communication Protocol Functionality](#).

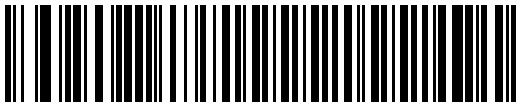

\*None

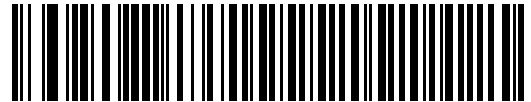

Hand-held Scanner Emulation (Port 9B)

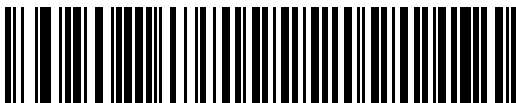

Non-IBM Scanner Emulation (Port 5B)

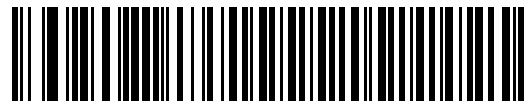

Table-top Scanner Emulation (Port 17)

## Convert Unknown to Code 39

Scan one of the following barcodes to enable or disable converting unknown barcode type data to Code 39.



**Enable Convert Unknown to Code 39**

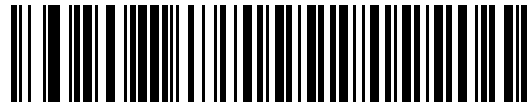

**\*Disable Convert Unknown to Code 39**

## RS-485 Beep Directive

The IBM RS-485 host can send a beeper configuration request to the scanner. Scan **Ignore Beep Directive** to prevent the scanner from processing the host request. All directives are still acknowledged to the host as if they were processed.

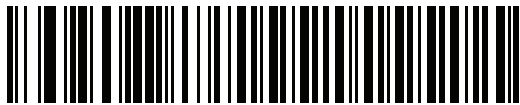

**Honor Beep Directive**



**\*Ignore Beep Directive**

## RS-485 Barcode Configuration Directive

The IBM RS-485 host can enable and disable code types. Scan **Ignore Barcode Configuration Directive** to prevent the scanner from processing the host request. All directives are still acknowledged to the IBM RS-485 host as if they were processed.

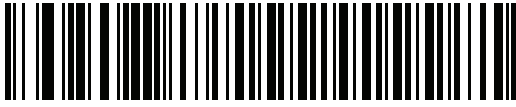

**Honor Barcode Configuration Directive**

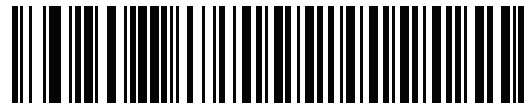

**\*Ignore Barcode Configuration Directive**

## IBM-485 Specification Version

**Parameter # 1729**

**SSI # F8h 06h C1h**

Select **IBM-485 Original Specification** to report only symbologies historically supported on each port as known.

Select **IBM-485 Version 2.2** to report all symbologies supported in the new IBM specification as known with the respective code types.

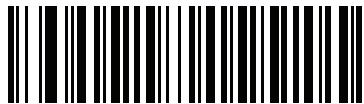

**\*IBM-485 Original Specification  
(0)**

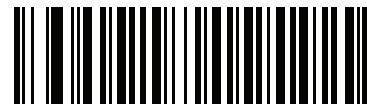

**IBM-485 (Version 2.2)  
(1)**

# Keyboard Wedge Interface

---

## Introduction

This chapter describes how to set up a keyboard wedge interface with the scanner. The scanner connects between the keyboard and host computer and translates barcode data into keystrokes, which the host accepts as if they originated from the keyboard. This mode adds barcode reading functionality to a system designed for manual keyboard input. Keyboard keystrokes are simply passed through.

The scanner ships with the settings shown in [Table 25 on page 130](#) (also see [Standard Parameter Defaults](#) for all defaults). If the default values suit requirements, programming is not necessary.

---

## Setting Parameters

To set feature values, scan a single barcode or a short barcode sequence. The settings are stored in non-volatile memory and are preserved even when the scanner powers down.



**NOTE:** Most computer monitors allow scanning barcodes directly on the screen. When scanning from the screen, be sure to set the document magnification to a level where you can see the barcode clearly, and bars and/or spaces do not merge.

To return all features to default values, scan a barcode in [Default Parameters on page 142](#). Throughout the programming barcode menus, asterisks (\*) indicate default values.



\* Indicates default      \*Enable Parameter      Feature/option

## Scanning Sequence Examples

In most cases, scanning one barcode sets the parameter value. For example, to select a medium keystroke delay, scan the **Medium Delay (20 msec)** barcode under [Keystroke Delay on page 132](#). The scanner issues a fast warble beep and the LED turns green, signifying a successful parameter entry.

Other parameters require scanning several barcodes. See the parameter descriptions for this procedure.

## Errors While Scanning

Unless otherwise specified, to correct an error during a scanning sequence, just re-scan the correct parameter.

## Connecting a Keyboard Wedge Interface

**Figure 16** Keyboard Wedge Connection

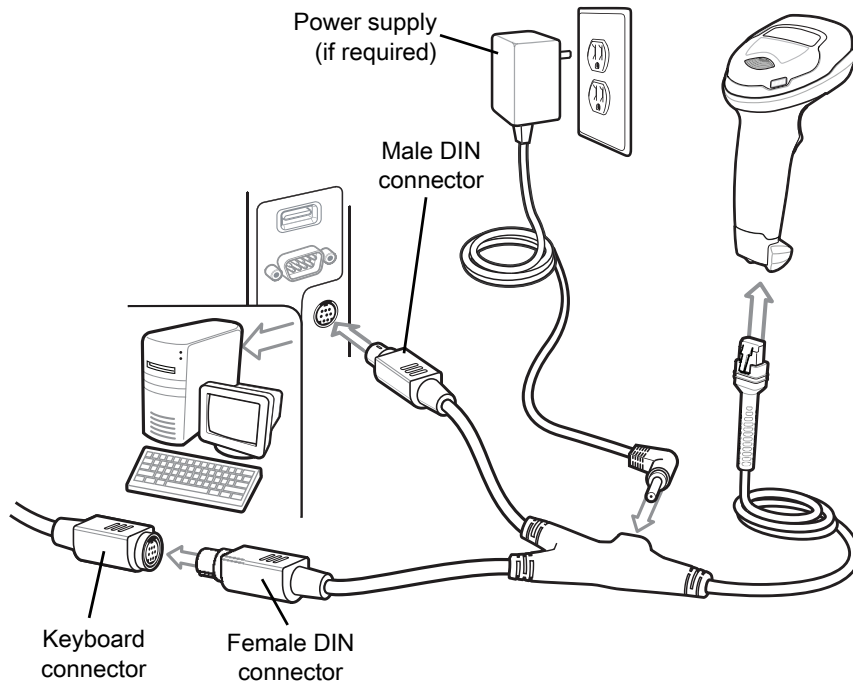

**NOTE:** Interface cables vary depending on configuration. The connectors can be different than those illustrated in [Figure 16](#), but the steps to connect the scanner are the same.

1. Turn off the host and unplug the keyboard connector.
2. Attach the modular connector of the Y-cable to the cable interface port on the scanner. See [Inserting the Interface Cable on page 28](#).
3. Connect the round male DIN host connector of the Y-cable to the keyboard port on the host device.
4. Connect the round female DIN keyboard connector of the Y-cable to the keyboard connector.
5. If required, attach the optional power supply to the connector in the middle of the Y-cable.
6. Ensure that all connections are secure.
7. Turn on the host system.
8. The scanner automatically detects the host interface type and uses the default setting. If the default (\*) does not meet your requirements, scan [IBM PC/AT & IBM PC Compatibles on page 131](#).
9. To modify other parameter options, scan the appropriate barcodes in this guide.

If problems occur with the system, see [Troubleshooting on page 46](#).

## Keyboard Wedge Parameter Defaults

Table 25 lists defaults for keyboard wedge host parameters. Change these values in one of two ways:

- Scan the appropriate barcodes in this chapter. The new value replaces the standard default value in memory. To recall default parameter values, see [Default Parameters on page 142](#).
- Configure the scanner using the 123Scan configuration program. See [123Scan and Software Tools](#).



**NOTE:** See [Standard Parameter Defaults](#) for all user preference, host, symbology, and miscellaneous default parameters.

**Table 25** Keyboard Wedge Interface Parameter Defaults

Parameter	Default	Page Number
<b>Keyboard Wedge Host Parameters</b>		
Keyboard Wedge Host Type	IBM AT Notebook	<a href="#">131</a>
Barcodes with Unknown Characters	Send Barcodes with Unknown Characters	<a href="#">131</a>
Keystroke Delay	No Delay	<a href="#">132</a>
Intra-keystroke Delay	Disable	<a href="#">132</a>
Alternate Numeric Keypad Emulation	Enable	<a href="#">133</a>
Quick Keypad Emulation	Enable	<a href="#">133</a>
Simulated Caps Lock	Disable	<a href="#">134</a>
Caps Lock Override	Disable	<a href="#">134</a>
Convert Case	Do Not Convert	<a href="#">135</a>
Function Key Mapping	Disable	<a href="#">136</a>
FN1 Substitution	Disable	<a href="#">136</a>
Send Make and Break	Send	<a href="#">137</a>

## Keyboard Wedge Host Parameters

### Keyboard Wedge Host Types

Scan one of the following barcodes to select the keyboard wedge host.



**NOTE:** For a list of supported scanner functionality by communication protocol, see [Communication Protocol Functionality](#).

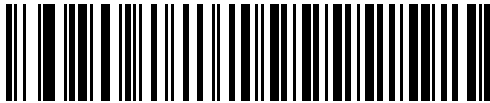

**IBM PC/AT & IBM PC Compatibles**

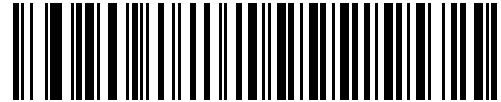

**\*IBM AT Notebook**

### Barcodes with Unknown Characters

Unknown characters are characters the host does not recognize. Scan **Send Barcodes With Unknown Characters** to send all barcode data except for unknown characters. The scanner issues no error beeps.

Scan **Do Not Send Barcodes With Unknown Characters** to send barcode data up to the first unknown character. The scanner issues an error beep.

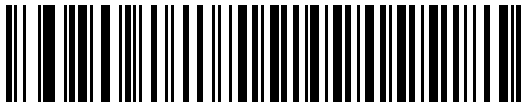

**\*Send Barcodes with Unknown Characters**



**Do Not Send Barcodes with Unknown Characters**

## Keystroke Delay

This is the delay in milliseconds between emulated keystrokes. Scan one of the following barcodes to increase the delay when hosts require a slower data transmission.



**\*No Delay**



**Medium Delay (20 msec)**

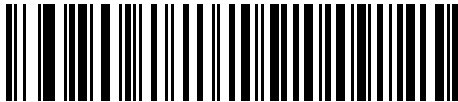

**Long Delay (40 msec)**

## Intra-keystroke Delay

Scan **Enable Intra-keystroke Delay** to insert an additional delay between each emulated key press and release. This also sets [Keystroke Delay](#) to a minimum of 5 msec.

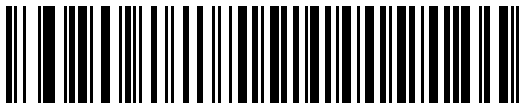

**Enable Intra-keystroke Delay**



**\*Disable Intra-keystroke Delay**



## Alternate Numeric Keypad Emulation

This allows emulation of most other country keyboard types not listed in [Country Codes](#) in a Microsoft® operating system environment.



**NOTE:** If your keyboard type is not listed in the country code list (see [Country Codes on page 496](#)), disable [Quick Keypad Emulation on page 133](#) and ensure [Alternate Numeric Keypad Emulation on page 133](#) is enabled.



**\*Enable Alternate Numeric Keypad**

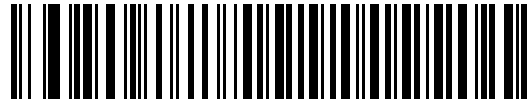

**Disable Alternate Numeric Keypad**

## Quick Keypad Emulation

This enables faster keypad emulation where character value sequences are only sent for characters not found on the keyboard.



**NOTE:** This option applies only when [Alternate Numeric Keypad Emulation](#) is enabled.



**\*Enable Quick Keypad Emulation**



**Disable Quick Keypad Emulation**

## Simulated Caps Lock

Scan **Enable Caps Lock** to invert upper and lower case characters on the barcode as if the Caps Lock state is enabled on the keyboard. This inversion occurs regardless of the keyboard's Caps Lock state. Note that this only applies to alpha characters.

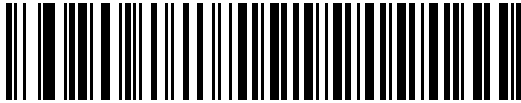

**Enable Caps Lock**

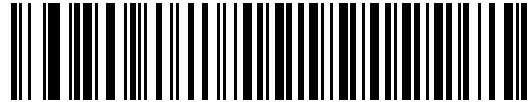

**\*Disable Caps Lock**

## Caps Lock Override

Scan **Enable Caps Lock Override** for AT or AT Notebook hosts to preserve the case of the data regardless of the state of the Caps Lock key. Therefore, an 'A' in the barcode transmits as an 'A' regardless of the setting of the keyboard's Caps Lock key.



**Enable Caps Lock Override**



**\*Disable Caps Lock Override**



**NOTE:** If both Simulated Caps Lock and Caps Lock Override are enabled, Caps Lock Override takes precedence.

## Convert Case

Scan one of the following barcodes to convert all barcode data to the selected case.



**NOTE:** Convert Case applies to ASCII characters only.

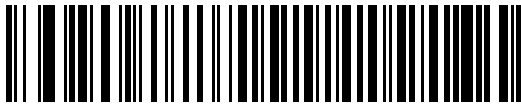

**Convert to Upper Case**

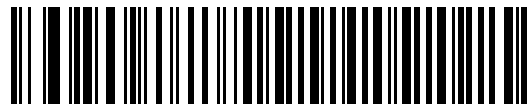

**Convert to Lower Case**



**\*Do Not Convert**

## Function Key Mapping

ASCII values under 32 are normally sent as control key sequences (see [Table 38 on page 476](#)). Scan **Enable Function Key Mapping** to send the keys in bold in place of the standard key mapping. Table entries that do not have a bold entry remain the same whether or not you enable this parameter.

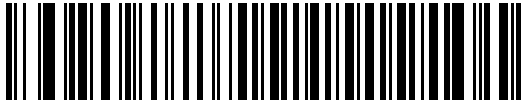

**Enable Function Key Mapping**

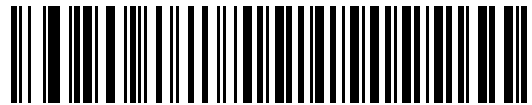

**\*Disable Function Key Mapping**

## FN1 Substitution

Scan **Enable FN1 Substitution** to replace FN1 characters in an EAN128 barcode with a user-selected keystroke (see [FN1 Substitution Values on page 184](#)).

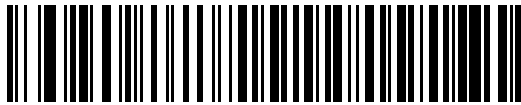

**Enable FN1 Substitution**



**\*Disable FN1 Substitution**

## Send Make and Break

Scan **Send Make and Break Scan Codes** to prevent sending the scan codes for releasing a key.



**\*Send Make and Break Scan Codes**

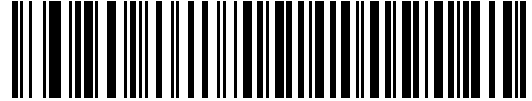

**Send Make Scan Code Only**



**NOTE:** Windows-based systems must use **Send Make and Break Scan Codes**.

## Keyboard Map

The following keyboard map is a reference for prefix/suffix keystroke parameters. To program the prefix/suffix values, see the barcodes on [page 181](#).

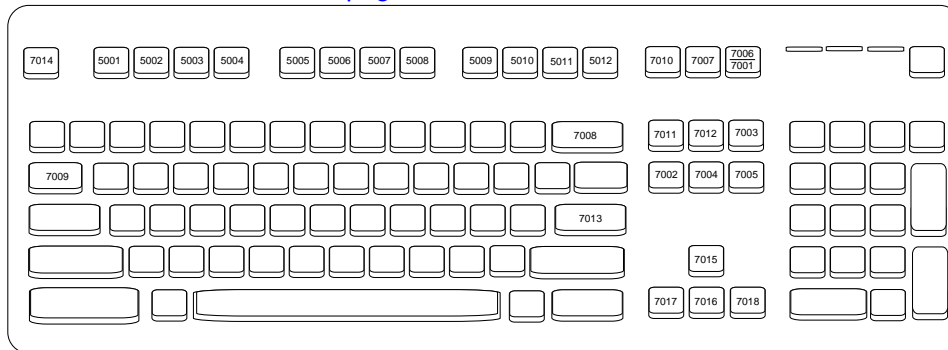

**Figure 17** IBM PS2 Type Keyboard

## ASCII Character Sets

See [ASCII Character Sets](#) for the following information:

- [ASCII Character Set on page 476](#)
- [ALT Key Character Set on page 481](#)
- [GUI Key Character Set on page 482](#)
- [PF Key Character Set on page 483](#)
- [F Key Character Set on page 484](#)
- [Numeric Key Character Set on page 485](#)
- [Extended Key Character Set on page 485](#)

# User Preferences & Miscellaneous Options

---

## Introduction

You can program the scanner to perform various functions, or activate different features. This chapter describes user preference features and provides programming barcodes for selecting these features.

The scanner ships with the settings shown in [Table 26 on page 139](#) (also see [Standard Parameter Defaults](#) for all defaults). If the default values suit requirements, programming is not necessary.

---

## Setting Parameters

To set feature values, scan a single barcode or a short barcode sequence. The settings are stored in non-volatile memory and are preserved even when the scanner powers down.



**NOTE:** Most computer monitors allow scanning barcodes directly on the screen. When scanning from the screen, be sure to set the document magnification to a level where you can see the barcode clearly, and bars and/or spaces do not merge.

If not using the default host, select the host type (see each host chapter for specific host information) after the power-up beeps sound. This is only necessary upon the first power-up when connected to a new host.

To return all features to default values, see [Default Parameters on page 142](#). Throughout the programming barcode menus, asterisks indicate (\*) default values.

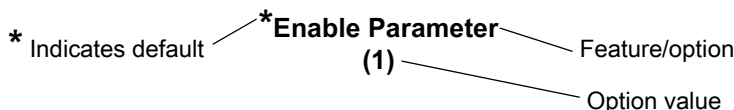

## Scanning Sequence Examples

In most cases, scanning one barcode sets the parameter value. For example, to set the beeper tone to high, scan the **High Frequency** (beeper tone) barcode listed under [Beeper Tone on page 146](#). The scanner issues a fast warble beep and the LED turns green, signifying a successful parameter entry.

Other parameters require scanning several barcodes. See the parameter descriptions for this procedure.

## Errors While Scanning

Unless otherwise specified, to correct an error during a scanning sequence, just re-scan the correct parameter.

## User Preferences/Miscellaneous Options Parameter Defaults

Table 26 lists defaults for user preferences parameters. Change these values in one of two ways:

- Scan the appropriate barcodes in this chapter. The new value replaces the standard default value in memory. To recall default parameter values, see [Default Parameters on page 142](#).
- Configure the scanner using the 123Scan configuration program. See [123Scan and Software Tools](#).



**NOTE:** See [Standard Parameter Defaults](#) for all user preference, host, symbology, and miscellaneous default parameters.

**Table 26** User Preferences Parameter Defaults

Parameter	Parameter Number <sup>1</sup>	SSI Number <sup>2</sup>	Default	Page Number
<b>User Preferences</b>				
Set Default Parameter	N/A	N/A	N/A	<a href="#">142</a>
Parameter Barcode Scanning	236	ECh	Enable	<a href="#">143</a>
Beep After Good Decode	56	38h	Enable	<a href="#">144</a>
Beeper Volume	140	8Ch	High	<a href="#">145</a>
Beeper Tone	145	91h	Medium	<a href="#">146</a>
Beeper Duration	628	F1h 74h	Medium	<a href="#">147</a>
Suppress Power Up Beeps	721	F1h D1h	Do Not Suppress	<a href="#">148</a>
LED on Good Decode	744	F1h E8h	Enable	<a href="#">149</a>
Direct Decode Indicator	859	F2h 5Bh	Disable	<a href="#">149</a>
Decode Pager Motor (DS4608-HC and DS4608-DPE Only)	613	F1h 65h	Enable	<a href="#">150</a>
Decode Pager Motor Duration (DS4608-HC Only)	626	F1h 72h	150 msec	<a href="#">151</a>
Night Mode Trigger (DS4608-HC and DS4608-DPE Only)	1215	F8h 04h BFh	DS4608-HC: Enable DS4608-DPE: Disable	<a href="#">154</a>
Night Mode Toggle (DS4608-HC Only DS4608-DPE)	N/A	N/A	N/A	<a href="#">154</a>
Low Power Mode	128	80h	Disable	<a href="#">155</a>
Time Delay to Low Power Mode	146	92h	1 Hour	<a href="#">156</a>
Trigger Mode (or Hand-held Trigger Mode)	138	8Ah	Auto Aim	<a href="#">158</a>
Hand-held Decode Aiming Pattern	306	F0h 32h	Enable	<a href="#">159</a>

1. Parameter number decimal values are used for programming via RSM commands.

2. SSI number hex values are used for programming via SSI commands.

**Table 26** User Preferences Parameter Defaults (Continued)

Parameter	Parameter Number <sup>1</sup>	SSI Number <sup>2</sup>	Default	Page Number
Hands-free (Presentation) Decode Aiming Pattern	590	F1h 4Eh	Disable Hands-free (Presentation) Decode Aiming Pattern	<a href="#">160</a>
Hands-free Mode	630	F1h 76h	Enable	<a href="#">161</a>
Picklist Mode	402	F0h 92h	Disable Picklist Mode Always	<a href="#">162</a>
Continuous Barcode Read	649	F1h 89h	Disable	<a href="#">163</a>
Unique Barcode Reporting	723	F1h D3h	Enable	<a href="#">164</a>
Decode Session Timeout	136	88h	9.9 Seconds	<a href="#">164</a>
Hands-Free Decode Session Timeout	400	F0 90	15	<a href="#">165</a>
Timeout Between Decodes, Same Symbol	137	89h	0.5 Seconds	<a href="#">166</a>
Timeout Between Decodes, Different Symbols	144	90h	0.1 Seconds	<a href="#">166</a>
Triggered Timeout, Same Symbol	724	F1h D4h	Disable	<a href="#">167</a>
Mobile Phone/Display Mode	716	F1h CCh	Normal	<a href="#">168</a>
PDF Prioritization	719	F4h F1h CFh	Disable	<a href="#">169</a>
PDF Prioritization Timeout	720	F1h D0h	200 ms	<a href="#">169</a>
Presentation Mode Field of View	609	F1h 61h	Full	<a href="#">171</a>
Decoding Illumination	298	F0h 2Ah	Enable	<a href="#">172</a>
Illumination Brightness	669	F1h 9Dh	High	<a href="#">173</a>
Motion Tolerance (Hand-held Trigger Mode Only)	858	F2h 5Ah	Less	<a href="#">174</a>
Product ID (PID) Type	1281	F8h 05h 01h	Host Type Unique	<a href="#">175</a>
Product ID (PID) Value	1725	F8h 06h BDh	0	<a href="#">175</a>
ECLevel	1710	F8h 06h AEh	0	<a href="#">176</a>
<b>DPM Parameters (DS4608-DPE Only)</b>				
DPM Illumination	429	F0h ADh	Cycle Illumination	<a href="#">177</a>

1. Parameter number decimal values are used for programming via RSM commands.
2. SSI number hex values are used for programming via SSI commands.



**Table 26** User Preferences Parameter Defaults (Continued)

Parameter	Parameter Number <sup>1</sup>	SSI Number <sup>2</sup>	Default	Page Number
DPM Mode	1438	F8h 05h 9Eh	Enable	<a href="#">178</a>
<b>Miscellaneous Options</b>				
Enter Key	N/A	N/A	N/A	<a href="#">179</a>
Tab Key	N/A	N/A	N/A	<a href="#">179</a>
Transmit Code ID Character	45	2Dh	None	<a href="#">180</a>
Prefix Value	99, 105	63h, 69h	7013 <CR><LF>	<a href="#">181</a>
Suffix 1 Value	98, 104	62h, 68h	7013 <CR><LF>	<a href="#">181</a>
Suffix 2 Value	100, 106	64h, 6Ah		
Scan Data Transmission Format	235	EBh	Data As Is	<a href="#">182</a>
FN1 Substitution Values	103, 109	67h, 6Dh	7013 <CR><LF>	<a href="#">184</a>
Transmit "No Read" Message	94	5E	Disable	<a href="#">185</a>
Unsolicited Heartbeat Interval	1118	F8h 04h 5Eh	Disable	<a href="#">186</a>
securPharm Decoding	1752	F8h 06h D8h	Disable	<a href="#">187</a>
securPharm Output Formatting	1753	F8h 06h D9h	No Formatting	<a href="#">188</a>

1. Parameter number decimal values are used for programming via RSM commands.
2. SSI number hex values are used for programming via SSI commands.

---

## User Preferences

### Default Parameters

Scan one of the following barcodes to reset the scanner to its default settings as follows:

- **Restore Defaults** resets all default parameters as follows:
  - If you configured custom default parameter values via the **Write to Custom Defaults** barcode, scanning the **Restore Defaults** barcode restores these custom values.
  - If you did not configure custom default parameter values, scanning the **Restore Defaults** barcode restores the factory default values. See [Standard Parameter Defaults](#) for these values.
- **Set Factory Defaults** clears all custom default values and sets the factory default values. See [Standard Parameter Defaults](#) for these values.

### Write to Custom Defaults

To create a set of custom defaults, select the desired parameter values in this guide, and then scan **Write to Custom Defaults**.



**Restore Defaults**



**Set Factory Defaults**



**Write to Custom Defaults**

## Parameter Barcode Scanning

### Parameter # 236

#### SSI # ECh

Scan one of the following barcodes to select whether to enable or disable the decoding of parameter barcodes, including the **Set Defaults** barcodes.



**\*Enable Parameter Barcode Scanning  
(1)**



**Disable Parameter Barcode Scanning  
(0)**

## Beep After Good Decode

### Parameter # 56

### SSI # 38h

Scan one of the following barcodes to select whether or not the scanner beeps after a good decode. If you select **Disable Beep After Good Decode**, the beeper still operates during parameter menu scanning and to indicate error conditions.



**\*Enable Beep After Good Decode**  
(1)

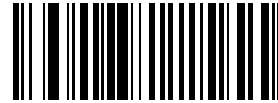

**Disable Beep After Good Decode**  
(0)

## Beeper Volume

Parameter # 140

SSI # 8Ch

Scan one of the following barcodes to select a beeper volume.



**Low Volume**  
(2)



**Medium Volume**  
(1)



**\*High Volume**  
(0)

## Beeper Tone

Parameter # 145

SSI # 91h

Scan one of the following barcodes to select a beeper tone for the good decode beep.



**Disable Tone**  
(3)

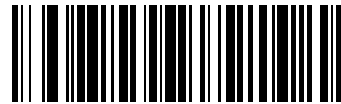

**Low Tone**  
(2)

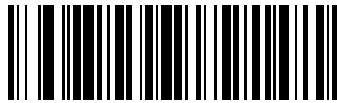

**\*Medium Tone**  
(1)

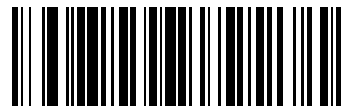

**High Tone**  
(0)



**Medium to High Tone (2-tone)**  
(4)

## Beeper Duration

Parameter # 628

SSI # F1h 74h

Scan one of the following barcodes to select the duration for the good decode beep.

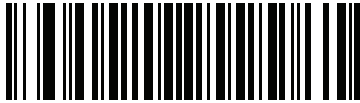

**Short Duration  
(0)**



**\*Medium Duration  
(1)**

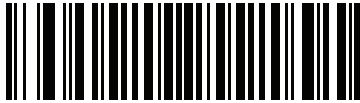

**Long Duration  
(2)**

## Suppress Power Up Beeps

Parameter # 721

SSI # F1h D1h

Scan one of the following barcodes to select whether or not to suppress the scanner's power-up beeps.



**\*Do Not Suppress Power Up Beeps  
(0)**



**Suppress Power Up Beeps  
(1)**



## LED on Good Decode

### Parameter # 744

#### SSI # F1h E8h

Scan one of the following barcodes to select whether or not the LED blinks on a good decode.



**\*Enable LED on Good Decode  
(2)**



**Disable LED on Good Decode  
(0)**

## Direct Decode Indicator

### Parameter # 859

#### SSI # F2h 5Bh

This parameter is only supported in Auto Aim and Standard (Level) [Hand-held Trigger Mode](#). Scan one of the following barcodes to select optional blinking of the illumination on a successful decode if you continue to hold the trigger. If you release the trigger upon decode, the blinking does not occur. This allows you to choose additional feedback for a successful decode by holding the trigger, or to continue to scan as normal.

- **\*Disable Direct Decode Indicator** - Illumination does not blink on a successful decode.
- **1 Blink** - Illumination blinks once upon a successful decode.
- **2 Blinks** - Illumination blinks twice upon a successful decode.



**\*Disable Direct Decode Indicator  
(0)**



**1 Blink  
(1)**



**2 Blinks  
(2)**

## Decode Pager Motor (DS4608-HC Only and DS4608-DPE)

### Parameter # 613

### SSI # F1h 65h

The scanner includes a pager motor which, when enabled, vibrates the scanner for a period of time when a successful decode occurs.



**NOTE:** While the scanner is in the Intellistand, the pager motor is disabled.

Scan one of the following barcodes to enable or disable the pager motor. If enabled, scan a [Decode Pager Motor Duration \(DS4608-HC Only\)](#) barcode to set the duration of the pager motor vibration.



**\*Enable Pager Motor  
(1)**

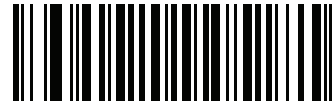

**Disable Pager Motor  
(0)**

## Decode Pager Motor Duration (DS4608-HC Only)

### Parameter # 626

### SSI # F1h 72h

If you enabled [Decode Pager Motor \(DS4608-HC Only and DS4608-DPE\)](#), scan one of the following barcodes to set the duration of the pager motor vibration.

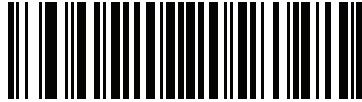

**\*150 msec  
(15)**



**200 msec  
(20)**

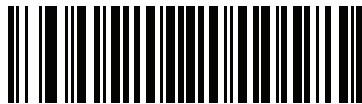

**250 msec  
(25)**



**300 msec  
(30)**

## Decode Pager Motor Duration (continued)



**400 msec**  
**(40)**

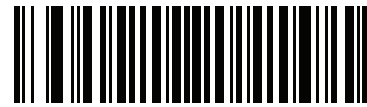

**500 msec**  
**(50)**

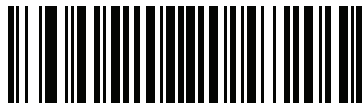

**600 msec**  
**(60)**



**750 msec**  
**(75)**

### Night Mode (DS4608-HC and DS4608-DPE Only)

The Night Mode feature allows you to easily switch to a “quiet mode” in order to use the pager motor with the beeper off. Enter and exit Night Mode in one of two ways:

- If [Night Mode Trigger \(DS4608-HC and DS4608-DPE Only\)](#) is enabled, you can use the trigger to toggle between entering and exiting Night Mode. To do this, point the scanner away from a barcode and press the trigger until the beam goes off. Hold the trigger for an additional 5 seconds.



**NOTE:** After decoding a barcode, holding the trigger an additional 5 seconds has no affect.

- Scan the [Night Mode Toggle \(DS4608-HC and DS4608-DPE Only\)](#) barcode to enter or exit Night Mode, regardless of the state of the [Night Mode Trigger \(DS4608-HC and DS4608-DPE Only\)](#) parameter.

Entering Night Mode enables [Decode Pager Motor \(DS4608-HC Only and DS4608-DPE\)](#), and disables [Beep After Good Decode](#).

Also note the following scanner behavior regarding Night Mode:

- Exiting Night Mode returns the scanner to the previously programmed states for the three parameters changed. For example, if [Beep After Good Decode](#) was enabled before entering Night Mode, it returns to enabled upon exiting Night Mode.
- When entering Night Mode, the pager motor vibrates. When exiting Night Mode, the scanner emits two short beeps.
- Scanning a [Default Parameters](#) barcode causes the scanner to exit Night Mode.
- For scanners that do not use a pager motor, scanning any of the Night Mode parameters or the pager motor parameters results in an error beep.
- If the scanner loses power while in Night Mode because a cable is disconnected, on the next power up the scanner exits Night Mode and resumes normal operation.

**Night Mode Trigger (DS4608-HC and DS4608-DPE Only)**

**Parameter # 1215**

**SSI # F8h 04h BFh**

Scan **Enable Night Mode Trigger** to use the trigger to toggle between entering and exiting Night Mode. To toggle, point the scanner away from a barcode, press the trigger until the beam goes off, and then hold the trigger for an additional 5 seconds. Note that pressing the trigger an additional 5 seconds after decoding a barcode has no affect.

When entering Night Mode, the pager motor vibrates. When exiting Night Mode, the scanner emits two short beeps.



**\*Enable Night Mode Trigger DS4608-HC  
(1)**



**\*Disable Night Mode Trigger DS4608-DPE  
(0)**

**Night Mode Toggle (DS4608-HC and DS4608-DPE Only)**

Scan this barcode to toggle between entering and exiting Night Mode without using the trigger. This functions regardless of the state of the **Night Mode Trigger** parameter.

When entering Night Mode, the pager motor vibrates. When exiting Night Mode, the scanner emits two short beeps.



**Toggle Night Mode**

## Low Power Mode

### Parameter # 128

### SSI # 80h



**NOTE:** The Low Power Mode parameter only applies for non-USB and non-RS485 host interfaces, and when [Hand-held Trigger Mode on page 158](#) is set to **Level (Standard)**.

Scan one of the following barcodes to select whether or not the scanner enters low power mode after a decode attempt or host communication. This applies to serial and keyboard wedge connections. If disabled, power remains on after each decode attempt.

If you enable this, see [Time Delay to Low Power Mode](#) to set the inactivity time period.



**Enable Low Power Mode  
(1)**



**\*Disable Low Power Mode  
(0)**

## Time Delay to Low Power Mode

Parameter # 146

SSI # 92h



**NOTE:** This parameter only applies when [Low Power Mode](#) is enabled.

Scan one of the following barcodes to set the time the scanner remains active before entering low power mode. The scanner wakes upon trigger press or when the host attempts to communicate with the scanner.



**1 Second**  
(17)

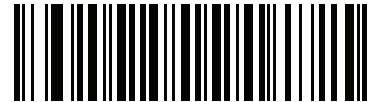

**10 Seconds**  
(26)



**1 Minute**  
(33)



**5 Minutes**  
(37)



**15 Minutes**  
(43)



Time Delay to Low Power Mode (continued)



**30 Minutes  
(45)**

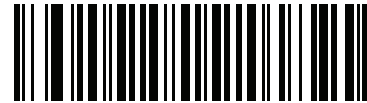

**45 Minutes  
(46)**



**\*1 Hour  
(49)**

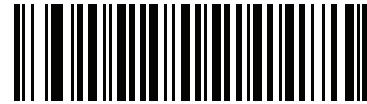

**3 Hours  
(51)**

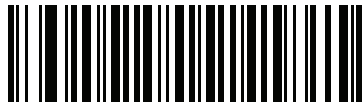

**6 Hours  
(54)**

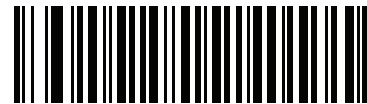

**9 Hours  
(57)**

## Hand-held Trigger Mode

### Parameter # 138

#### SSI # 8Ah

Scan one of the following barcodes to select a trigger mode for the scanner:

- **Standard (Level)** - A trigger press activates decode processing. Decode processing continues until the barcode decodes, you release the trigger, or the [Decode Session Timeout on page 164](#) occurs.
- **Presentation (Blink)** - The scanner activates decode processing when it detects a barcode in its field of view. After a period of non-use, the LEDs turn off until the scanner senses motion.
- **\*Auto Aim** - The scanner projects the aiming pattern when lifted. A trigger press activates decode processing. After a period of inactivity the aiming pattern shuts off.

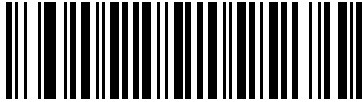

**Standard (Level)**  
(0)

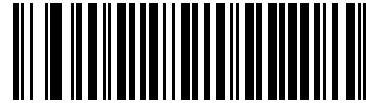

**Presentation (Blink)**  
(7)



**\*Auto Aim**  
(9)

## Hand-held Decode Aiming Pattern

### Parameter # 306

### SSI # F0h 32h

Scan one of the following barcodes to select when to project the aiming pattern in hand-held mode:

- **Enable Hand-held Decode Aiming Pattern** - This projects the aiming pattern during barcode capture.
- **Disable Hand-held Decode Aiming Pattern** - This turns the aiming pattern off.
- **Enable Hand-held Decode Aiming Pattern on PDF** - This projects the aiming pattern when the scanner detects a PDF barcode.



**NOTE:** With [Picklist Mode on page 162](#) enabled, the decode aiming pattern flashes even if you disable the **Hand-held Decode Aiming Pattern**.

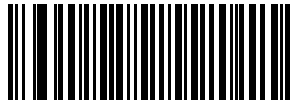

**\*Enable Hand-held Decode Aiming Pattern  
(2)**

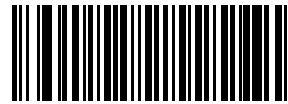

**Disable Hand-held Decode Aiming Pattern  
(0)**



**Enable Hand-held Decode Aiming Pattern on PDF  
(3)**

## Hands-free (Presentation) Decode Aiming Pattern

### Parameter # 590

### SSI # F1h 4Eh

Scan one of the following barcodes to select when to project the aiming pattern in hands-free mode:

- **Enable Hands-free (Presentation) Decode Aiming Pattern** - This projects the aiming pattern during barcode capture.
- **Disable Hands-free (Presentation) Decode Aiming Pattern** - This turns the aiming pattern off.
- **Enable Hands-free (Presentation) Decode Aiming Pattern on PDF** - This projects the aiming pattern when the scanner detects a PDF barcode.



**NOTE:** With [Picklist Mode on page 162](#) enabled, the decode aiming pattern flashes even when you disable the **Hands-free Decode Aiming Pattern**.



**Enable Hands-free (Presentation)  
Decode Aiming Pattern  
(1)**



**\*Disable Hands-free (Presentation)  
Decode Aiming Pattern  
(0)**



**Enable Hands-free (Presentation)  
Decode Aiming Pattern on PDF  
(2)**

## Hands-free Mode

### Parameter # 630

### SSI # F1h 76h

Scan one of the following barcodes to enable or disable hands-free mode:

- **Enable Hands-free Mode** - When you place the scanner in a hands-free stand, it automatically triggers when presented with a barcode. Removing the scanner from the stand or pulling the trigger causes it to behave according to the setting of the [Hand-held Trigger Mode on page 158](#).
- **Disable Hands-free Mode** - The scanner behaves according to the setting of the [Hand-held Trigger Mode on page 158](#) regardless of whether it is hand-held or in a stand.



**\*Enable Hands-free Mode  
(1)**



**Disable Hands-free Mode  
(0)**

## Picklist Mode

### Parameter # 402

#### SSI # F0h 92h

Scan one of the following barcodes to select a Picklist Mode. In this mode, you can pick out and decode a barcode from a group of barcodes that are printed close together by placing the aiming pattern on the barcode you want to decode.



**NOTE:** Enabling Picklist Mode overrides the Disable Decode Aiming Pattern options. You can not disable the decode aiming pattern when Picklist Mode is enabled.

Enabling Picklist Mode can slow decode speed and hinder the ability to decode longer barcodes.

- **Enable Picklist Mode Always** - Picklist Mode is always enabled.
- **Enable Picklist Mode in Hand-held Mode** - Picklist Mode is enabled when the scanner is out of hands-free mode and disabled when the scanner is in presentation mode.
- **Enable Picklist Mode in Hands-free Mode** - Picklist Mode is enabled when the scanner is in hands-free mode only.
- **Disable Picklist Mode Always** - Picklist Mode is always disabled.

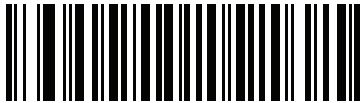

**Enable Picklist Mode Always  
(2)**



**Enable Picklist Mode in Hand-held Mode  
(1)**



**Enable Picklist Mode in Hands-free Mode  
(3)**



**\*Disable Picklist Mode Always  
(0)**

## Continuous Barcode Read

Parameter # 649

SSI # F1h 89h

Scan **Enable Continuous Barcode Read** to report every barcode while the trigger is pressed.



**NOTE:** We strongly recommend enabling [Picklist Mode on page 162](#) with this parameter. Disabling Picklist Mode can cause accidental decodes when more than one barcode is in the scanner's field of view.



**Enable Continuous Barcode Read**  
(1)

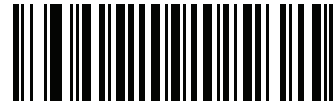

**\*Disable Continuous Barcode Read**  
(0)

## Unique Barcode Reporting

Parameter # 723

SSI # F1h D3h

Scan **Enable Continuous Barcode Read Uniqueness** to report only unique barcodes while the trigger is pressed. This option only applies when [Continuous Barcode Read](#) is enabled.



**\*Enable Unique Barcode Reporting  
(1)**



**Disable Unique Barcode Reporting  
(0)**

## Decode Session Timeout

Parameter # 136

SSI # 88h

This parameter sets the maximum time decode processing continues during a scan attempt. It is programmable in 0.1 second increments from 0.5 to 9.9 seconds. The default timeout is 9.9 seconds.

To set a Decode Session Timeout, scan the following barcode, and then scan two barcodes from [Numeric Barcodes](#) that correspond to the desired on time. Enter a leading zero for single digit numbers. For example, to set a Decode Session Timeout of 0.5 seconds, scan this barcode, and then scan the **0** and **5** barcodes. To correct an error or change the selection, scan [Cancel on page 457](#).



**Decode Session Timeout**



## Hands-Free Decode Session Timeout

### Parameter # 400

#### SSI # F0 90

This parameter is the hands-free compliment to the **Decode Session Timeout**. It configures the minimum and maximum decode processing time during a hands-free scan attempt. It only applies to the hands-free trigger mode or when a scanner is place in the gooseneck stand. The default is 15; range = 2 - 255.

The minimum decode processing time is defined as the time in which the scanner stops decoding when an object is removed or left stationary in the imaging field of view.

The maximum decode processing time is defined as the time in which the scanner stops decoding when an object is left in or is moving in the field of view.

Both the maximum and minimum times are configured using a single setting. The relationship of this setting is as follows:

Setting Value <sup>1</sup>	Minimum Time	Maximum Time
X < 25	250 ms	2.5 Seconds
X >= 25	X * 10 ms	X * 100 ms

<sup>1</sup>Setting value must be three digits.

For example, a setting value of 100 results in the scanner turning off approximately 1 second after an object is removed from the field of view or 10 seconds while an object is in the field of view moving.

The default value of the setting is 15 which results in a minimum time of 250 ms and maximum time of 2.5 seconds.

Adjust this setting based on your requirements. For example, when doing PDF prioritization, this parameter should be set to a value where the maximum time is above the PDF prioritization timeout.

To set a three digit value scan the following barcode, and then scan three barcodes from [Numeric Barcodes](#). Enter a leading zero for single digit numbers. To correct an error or change a selection, scan [Cancel on page 457](#).

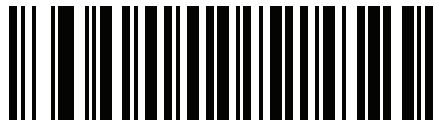

Hands-Free Decode Session Timeout

## Timeout Between Decodes, Same Symbol

### Parameter # 137

#### SSI # 89h

Use this option in presentation mode or [Continuous Barcode Read](#) mode to prevent the scanner from continuously decoding the same barcode when it is left in the scanner's field of view. The barcode must be out of the field of view for the timeout period before the scanner reads the same consecutive symbol. It is programmable in 0.1 second increments from 0.0 to 9.9 seconds. The default interval is 0.5 seconds.

To select the timeout between decodes for the same symbol, scan the following barcode, and then scan two barcodes from [Numeric Barcodes](#) that correspond to the desired interval, in 0.1 second increments.



Timeout Between Decodes, Same Symbol

## Timeout Between Decodes, Different Symbols

### Parameter # 144

#### SSI # 90h

Use this option in presentation mode or [Continuous Barcode Read](#) to control the time the scanner waits before decoding a different symbol. It is programmable in 0.1 second increments from 0.1 to 9.9 seconds. The default is 0.1 seconds.

To select the timeout between decodes for different symbols, scan the following barcode, and then scan two barcodes from [Numeric Barcodes](#) that correspond to the desired interval, in 0.1 second increments.



**NOTE:** Timeout Between Decodes, Different Symbols cannot be greater than or equal to the [Decode Session Timeout](#).



Timeout Between Decodes, Different Symbols

## Triggered Timeout, Same Symbol

Parameter # 724

SSI # F1h D4h



**NOTE:** This feature does not apply to Timeout Between Decodes, Different Symbols.



**NOTE:** **Timeout Between Decodes, Same Symbol** cannot be greater than or equal to the **Time Delay to Low Power Mode** (parameter #146 on page 156).

Scan **Enable Triggered Timeout, Same Symbol** below to apply **Timeout Between Decodes, Same Symbol** (parameter #137 on page 166) in hand-held trigger mode. Subsequent scans of **Enable Triggered Timeout, Same Symbol** are ignored until **Timeout Between Decodes, Same Symbol** expires.



**Enable Triggered Timeout, Same Symbol**  
(1)



**\* Disable Triggered Timeout, Same Symbol**  
(0)

## Mobile Phone/Display Mode

### Parameter # 716

#### SSI # F1h CCh

This mode improves barcode reading performance off mobile phones and electronic displays. Scan one of the following barcodes to select the desired mode.

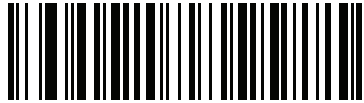

**\*Normal Mobile Phone/Display Mode  
(0)**

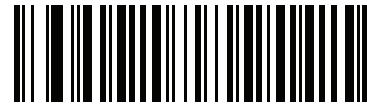

**Enhanced in Hand-held Mode  
(1)**

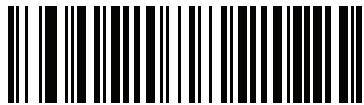

**Enhanced in Hands-free Mode  
(2)**



**Enhanced in Both Modes  
(3)**

## PDF Prioritization

### Parameter # 719

#### SSI # F4h F1h CFh

Scan **Enable PDF Prioritization** to delay decoding certain 1D barcodes (see Note below) by the value specified in **PDF Prioritization Timeout**. During that time the scanner attempts to decode a PDF417 symbol (e.g., on a US driver's license), and if successful, reports this only. If it does not decode (can not find) a PDF417 symbol, it reports the 1D symbol after the timeout. The 1D symbol must be in the device's field of view for the scanner to report it. This parameter does not affect decoding other symbologies.



**NOTE:** The 1D Code 128 barcode lengths include the following:

- 7 to 10 characters
- 14 to 22 characters
- 27 to 28 characters

In addition, a Code 39 barcode with the following lengths are considered to potentially be part of a US driver's license:

- 8 characters
- 12 characters



**Enable PDF Prioritization  
(1)**



**\*Disable PDF Prioritization  
(0)**

## PDF Prioritization Timeout

### Parameter # 720

### SSI # F1h D0h

If you enabled [PDF Prioritization](#), set this timeout to indicate how long the scanner attempts to decode a PDF417 symbol before reporting the 1D barcode in the field of view.

Scan the following barcode, and then scan four barcodes from [Numeric Barcodes](#) that specify the timeout in milliseconds. For example, to enter 400 ms, scan the following barcode, and then scan 0400. The range is 0 to 5000 ms, and the default is 200 ms.



**PDF Prioritization Timeout**

## Presentation Mode Field of View

### Parameter # 609

### SSI # F1h 61h

In presentation mode, by default the scanner searches the larger area of the aiming pattern (**Full Field of View**).

Select **Small Field of View** or **Medium Field of View** to search for a barcode in a smaller region around the aiming pattern's center in order to speed search time.

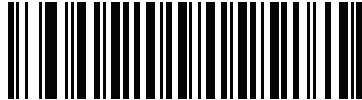

**Small Field of View**  
(0)

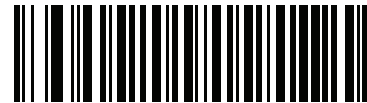

**Medium Field of View**  
(1)

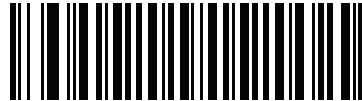

**\*Full Field of View**  
(2)

## Decoding Illumination

### Parameter # 298

### SSI # F0h 2Ah

Scan one of the following barcodes to determine whether the scanner turns on illumination to aid decoding. Enabling illumination usually results in superior images and better decode performance. The effectiveness of the illumination decreases as the distance to the target increases.



**\*Enable Decoding Illumination  
(1)**



**Disable Decoding Illumination  
(0)**



## Illumination Brightness

### Parameter # 669

### SSI # F1h 9Dh

Scan one of the following barcodes to set the illumination brightness used during an active decode session. This only applies in hand-held mode (not in presentation mode).



**NOTE:** Selecting a lower brightness level can affect decode performance.



**Low Illumination Brightness  
(0)**



**Medium Illumination Brightness  
(3)**



**\*High Illumination Brightness  
(10)**

## Motion Tolerance (Hand-held Trigger Modes Only)

### Parameter # 858

### SSI # F2h 5Ah

Scan one of the following barcodes to select a motion tolerance option:

- **Less Motion Tolerance** - This provides optimal decoding performance on 1D barcodes.
- **More Motion Tolerance** - This increases motion tolerance and speeds decoding when scanning a series of 1D barcodes in rapid progression.



**\*Less Motion Tolerance  
(0)**



**More Motion Tolerance  
(1)**

## Product ID (PID) Type

Parameter # 1281

SSI # F8h 05h 01h

Scan one of the following barcodes to define the PID value reported in USB enumeration.

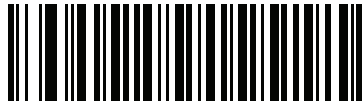

\*Host Type Unique  
(0)



Product Unique  
(1)

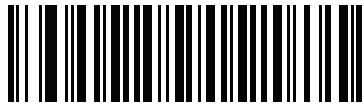

IBM Unique  
(2)

## Product ID (PID) Value

Parameter # 1725

SSI # F8h 06h BDh

To set a Product ID value, scan **Set PID Value**, and then scan four numeric barcodes in [Numeric Barcodes](#) that correspond to the value. Enter a leading zero for single digit numbers. To correct an error, or change a selection, scan [Cancel on page 457](#). The range is (0,1600-1649).



**NOTE:** This parameter applies to customers using a Firmware Flash Update per the Toshiba Global Commerce Solutions (TGCS) Universal Serial Bus OEM Point-of-Sale Device Interface.



Set PID Value

## ECLevel

### Parameter # 1710

### SSI # F8h 06h AEh

To set an ECLevel value, scan **Set ECLevel**, and then scan five numeric barcodes in [Numeric Barcodes](#) that correspond to the desired level. Enter a leading zero for single digit numbers. To correct an error, or change a selection, scan [Cancel on page 457](#).



**NOTE:** This parameter applies to customers using a Firmware Flash Update per the Toshiba Global Commerce Solutions (TGCS) Universal Serial Bus OEM Point-of-Sale Device Interface. It allows defining an ECLevel value to manage and control Flash Update operations on the 4690 operating system.

Contact the Zebra Customer Support Center online at: [www.zebra.com/support](http://www.zebra.com/support) for more information.



**Set ECLevel**

---

## DPM Parameters (DS4608-DPE Only)

### DPM Illumination Control

#### Parameter # 429

#### SSI # F0h ADh

This parameter controls the Illumination for DPM barcode reading.

- Direct Illumination - scanner uses only the direct illumination.
- Indirect Illumination - scanner uses only the Diffused illumination.
- Cycle Illumination - scanner cycles alternately between direct and indirect illumination. The scanner starts with the illumination used during the last successful decode.



**Direct Illumination**  
**(0)**



**Indirect Illumination**  
**(1)**



**\* Cycle Illumination**  
**(3)**

## DPM Mode

### Parameter # 1438

### SSI # F8h 05h 9Eh

Unlike barcodes typically printed on labels, a direct part mark (DPM) is a symbol that is marked, using methods such as laser etching and dot peening, directly on an item surface for permanent identification. A DPM reader can scan these types of symbols. Scan one of the following barcodes to select a DPM mode:

- **Disable DPM Mode** - No special processing occurs.



**NOTE:** If you enable a **DPM Mode**, disable [Picklist Mode on page 162](#) when scanning a DPM barcode. Picklist performance is not guaranteed for DPM barcodes.

If you enable a **DPM Mode**, the decoder behaves as if the **Data Matrix Inverse Autodetect** setting is selected. If you disable DPM, the previous (user-selected) **Data Matrix Inverse** setting remains in effect. See [Data Matrix Inverse on page 307](#).



**Disable DPM Mode  
(0)**



**\*Enable DPM Mode  
(1)**

---

## Miscellaneous Scanner Parameters

### Enter Key

Scan the following barcode to add an Enter key (carriage return/line feed) after scanned data. To program other prefixes and/or suffixes, see [Prefix/Suffix Values on page 181](#).

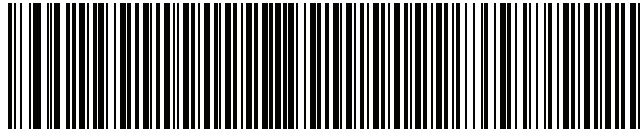

**Add Enter Key (Carriage Return/Line Feed)**

### Tab Key

Scan the following barcode to add a Tab key after scanned data.

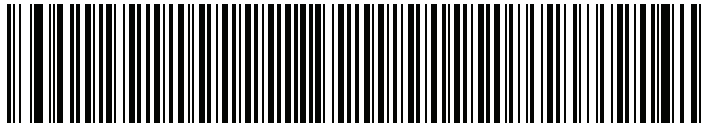

**Tab Key**

## Transmit Code ID Character

### Parameter # 45

#### SSI # 2Dh

A Code ID character identifies the code type of a scanned barcode. This is useful when decoding more than one code type. In addition to any single character prefix selected, the Code ID character is inserted between the prefix and the decoded symbol.

Select no Code ID character, a Symbol Code ID character, or an AIM Code ID character. For Code ID characters, see [Symbol Code Identifiers on page 487](#) and [AIM Code Identifiers on page 489](#).



**NOTE:** If you enable Symbol Code ID Character or AIM Code ID Character, and enable [Transmit "No Read" Message on page 185](#), the scanner appends the code ID for Code 39 to the NR message.

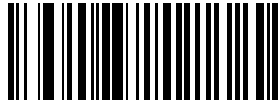

Symbol Code ID Character  
(2)

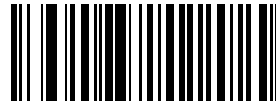

AIM Code ID Character  
(1)

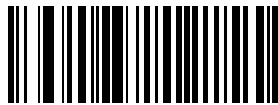

\*None  
(0)



### Prefix/Suffix Values

**Key Category Parameter # P = 99, S1 = 98, S2 = 100**

**SSI # P = 63h, S1 = 62h, S2 = 64h**

**Decimal Value Parameter # P = 105, S1 = 104, S2 = 106**

**SSI # P = 69h, S1 = 68h, S2 = 6Ah**

You can append a prefix and/or one or two suffixes to scan data for use in data editing. To set a value for a prefix or suffix, scan one of the following barcodes, and then scan four barcodes from [Numeric Barcodes](#) that correspond to that value. See [ASCII Character Sets](#) for the four-digit codes.

When using host commands to set the prefix or suffix, set the key category parameter to 1, and then set the 3-digit decimal value. See [ASCII Character Sets](#) for the four-digit codes.

The default prefix and suffix value is 7013 <CR><LF> (Enter key). To correct an error or change a selection, scan [Cancel on page 457](#).



**NOTE:** To use Prefix/Suffix values, first set the [Scan Data Transmission Format on page 182](#).

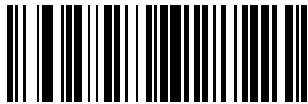

**Scan Prefix  
(7)**

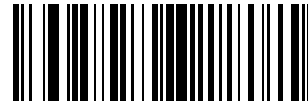

**Scan Suffix 1  
(6)**



**Scan Suffix 2  
(8)**



**Data Format Cancel**

## Scan Data Transmission Format

### Parameter # 235

#### SSI # EBh

To change the scan data format, scan one of the following barcodes corresponding to the desired format.



**NOTE:** If using this parameter do not use ADF rules to set the prefix/suffix.

To set values for the prefix and/or suffix, see [Prefix/Suffix Values on page 181](#).



**\*Data As Is**  
(0)



**<DATA> <SUFFIX 1>**  
(1)



**<DATA> <SUFFIX 2>**  
(2)



**<DATA> <SUFFIX 1> <SUFFIX 2>**  
(3)

## Scan Data Transmission Format (continued)



<PREFIX> <DATA >  
(4)



<PREFIX> <DATA> <SUFFIX 1>  
(5)



<PREFIX> <DATA> <SUFFIX 2>  
(6)



<PREFIX> <DATA> <SUFFIX 1> <SUFFIX 2>  
(7)

## FN1 Substitution Values

### Key Category Parameter # 103

### Key Category SSI # 67h

### Decimal Value Parameter # 109

### Decimal Value SSI # 6Dh

Keyboard wedge and USB HID keyboard hosts support a FN1 substitution feature. Enabling this substitutes any FN1 character (0x1b) in an EAN128 barcode with a value. This value defaults to 7013 <CR><LF> (Enter key).

When using host commands to set the FN1 substitution value, set the key category parameter to 1, and then set the 3-digit keystroke value. See the ASCII Character Set table for the current host interface for the desired value.

To select a FN1 substitution value via barcode menus:

1. Scan the following barcode.

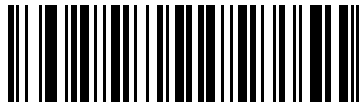

**Set FN1 Substitution Value**

2. Locate the keystroke desired for FN1 Substitution in the ASCII Character Set table for the current host interface, and enter the 4-digit ASCII value by scanning four barcodes from [Numeric Barcodes](#).

To correct an error or change the selection, scan **Cancel**.

To enable FN1 substitution for USB HID keyboard, scan the **Enable FN1 Substitution** barcode on page [184](#).

## Transmit “No Read” Message

### Parameter # 94

### SSI # 5Eh

Scan one of the following barcodes to set an option for transmitting the No Read (NR) characters:



**NOTES** 1 If you enable **Transmit No Read**, and also enable Symbol Code ID Character or AIM Code ID Character for [Transmit Code ID Character on page 180](#), the scanner appends the code ID for Code 39 to the NR message.

2. This does not apply in presentation mode.

- **Enable No Read** - This transmits the characters NR when a successful decode does not occur before trigger release or the **Decode Session Timeout** expires. See [Decode Session Timeout on page 164](#).
- **Disable No Read** - This sends nothing to the host if a symbol does not decode.



**Enable No Read  
(1)**



**\*Disable No Read  
(0)**

## Unsolicited Heartbeat Interval

### Parameter # 1118

### SSI # F8h 04h 5Eh

The scanner can send unsolicited heartbeat messages to assist in diagnostics. To enable this parameter and set the desired unsolicited heartbeat interval, scan one of the following time interval barcodes, or scan **Set Another Interval** followed by four barcodes from [Numeric Barcodes](#) that correspond to the desired number of seconds. The range is 0 - 9999.

Scan **Disable Unsolicited Heartbeat Interval** to turn off the feature.

The heartbeat event is sent as decode data (with no decode beep) in the form of:

MOTEVTHB:nnn

where **nnn** is a three-digit sequence number starting at 001 and wrapping after 100.



**10 Seconds**  
(10)

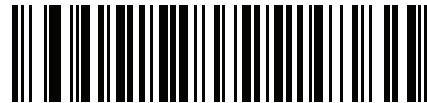

**1 Minute**  
(60)



**Set Another Interval**



**\*Disable Unsolicited Heartbeat Interval**  
(0)

## securPharm Decoding

### Parameter # 1752

#### SSI # F8h 06h D8h

securPharm implements the IFA and GS1 Coding System for the European pharmaceutical industry. securPharm code is used to prevent pharmaceutical counterfeiting.

When this feature is enabled, if a GS1 symbol is decoded and includes any aspects of the Application Identifier associated with the securPharm GS1 specifications, the entire GS1 symbol is processed as a securPharm symbol. For this reason, it is expected that under certain circumstances, a GS1 barcode that is a securPharm symbol may not be processed properly; if the GS1 symbol is not created as per the specification. The output cannot be guaranteed as valid.

Although the GS1-128 type and the GS1 DataBar family are not specifically indicated in the IFA specification, they are supported.

The securPharm output is in XML format and can include the product number, serial number, lot number, expiration and Date of Manufacturing. The XML tags can be arranged in any order. Tags that are not in the barcode are omitted. For example:

```
<content dfi="value_dfi" >
<Daten_1>value_Daten_1</Daten_1>
<Daten_2>value_Daten_2</Daten_2>
<Daten_n>value_Daten_n</Daten_n>
</content>
```

Where:

value\_dfi = IFA or GS1

Daten\_1 to Daten\_n is the production number, serial number, etc.

Scan a barcode below to enable or disable the ability to process pharmaceutical type barcodes.



**\*Disable securPharm Decoding  
(0)**



**Enable securPharm Decoding  
(1)**

## securPharm Output Formatting

### Parameter # 1753

### SSI # F8h 06h D9h



**NOTE:** securPharm output formatting is effective only when [securPharm Decoding on page 187](#) is enabled.

**securPharm Output Formatting** parameter options represent bit positions. Therefore, any combination of formatting can be used.

When you scan a securPharm Output Formatting barcode, the securPharm output is formatted in a number of ways.

#### Sample GS1 Format

Product Number: GTIN Data Identifier DI Data Format Identifier: GS1

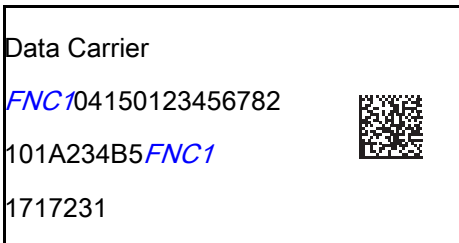

> Scanned Barcode >

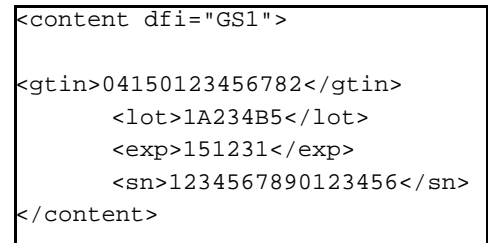

#### Sample GS1 Output - Feature Disabled

The output has no format:

0104150123456782101A234B517151231211234567890123456

#### Sample GS1 Output - No Formatting (0)

The output is a single line of characters:

```
<content
dfi="GS1"><gtin>04150123456782</gtin><lot>1A234B5</lot><exp>151231</exp><sn>1234567890123456</sn></content>
```

#### Sample GS1 Output - Insert Tab (1)

The output is a single line of characters with a tab inserted in the XML body:

```
<content
dfi="GS1">[tab]<gtin>04150123456782</gtin>[tab]<lot>1A234B5</lot>[tab]<exp>151231</exp>[tab]<sn>1234567890123456</sn></content>
```

#### Sample GS1 Output - Insert New Line (2)

The output consists of multiple lines of characters with a new line character at the end of each line.

```
<content dfi="GS1">
<gtin>04150123456782</gtin>
<lot>1A234B5</lot>
<exp>151231</exp>
<sn>1234567890123456</sn>
</content>
```



### Sample GS1 Output - Insert Tab and New Line (3)

The output consists of multiple lines of characters with tabs and a new line character at the end of each line.

```
<content dfi="GS1">
[tab]<gt;n>04150123456782</gti n>
[tab]<l ot>1A234B5</l ot>
[tab]<exp>151231</exp>
[tab]<sn>1234567890123456</sn>
</content>
```

### Sample IFA Format

Product Number: PPNData Identifier DI Data Format Identifier: IFA

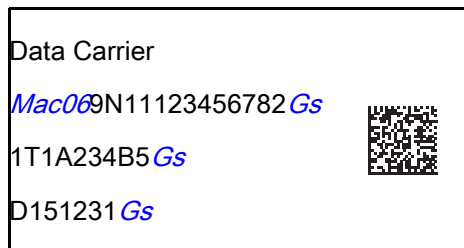

> Scanned Barcode >

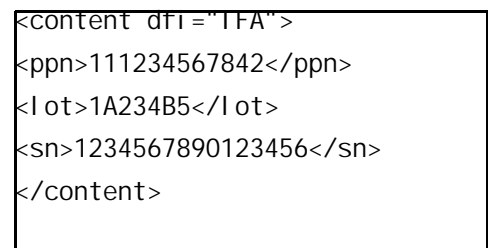

### Sample GS1 Output - Feature Disabled

The output has no format:

```
[ ]>069N1112345678421T1A234B5S1234567890123456
```

### Sample GS1 Output - No Formatting (0)

The output is a single line of characters:

```
<content
dfi="IFA"><ppn>111234567842</ppn><l ot>1A234B5</l ot><sn>1234567890123456</sn></content>
```

### Sample GS1 Output - Insert Tab (1)

The output is a single line of characters with a tab inserted in the XML body:

```
<content
dfi="IFA">[tab]<ppn>111234567842</ppn>[tab]<l ot>1A234B5</l ot>[tab]<sn>1234567890123456</sn></content>
```

### Sample GS1 Output - Insert New Line (2)

The output consists of multiple lines of characters with a new line character at the end of each line.

```
<content dfi="IFA">
<ppn>111234567842</ppn>
<l ot>1A234B5</l ot>
<sn>1234567890123456</sn>
</content>
```

### Sample GS1 Output - Insert Tab and New Line (3)

The output consists of multiple lines of characters with tabs and a new line character at the end of each line.

```
<content dfi="IFA">  
[tab]<ppn>111234567842</ppn>  
[tab]<l ot>1A234B5</l ot>  
[tab]<sn>1234567890123456</sn>  
</content>
```

### securPharm Output Formatting Barcodes

Scan a barcode below to format the securPharm output.



**\*No Formatting  
(0)**



**Insert Tab  
(1)**



**Insert New Line  
(2)**



**Insert Tab and New Line  
(3)**

# Image Capture Preferences

---

## Introduction

You can program the imager to perform various functions, or activate different features. This chapter describes image capture preference features and provides programming barcodes for selecting these features.



**NOTE:** Only the Symbol Native API (SNAPI) with Imaging interface supports image capture. See [USB Device Type on page 62](#) to enable this host.

The imager ships with the settings shown in [Table 27 on page 192](#) (also see [Standard Parameter Defaults](#) for all defaults). If the default values suit requirements, programming is not necessary.

---

## Setting Parameters

To set feature values, scan a single barcode or a short barcode sequence. The settings are stored in non-volatile memory and are preserved even when the imager powers down.



**NOTE:** Most computer monitors allow scanning barcodes directly on the screen. When scanning from the screen, be sure to set the document magnification to a level where you can see the barcode clearly, and bars and/or spaces do not merge.

To return all features to default values, scan the [Set Factory Defaults on page 142](#). Throughout the programming barcode menus, asterisks (\*) indicate default values.

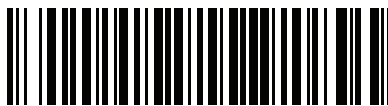

\* Indicates default — \*Enable Parameter — Feature/option  
(1) — Option value

## Scanning Sequence Examples

In most cases scanning one barcode sets the parameter value. For example, to disable image capture illumination, scan the **Disable Image Capture Illumination** barcode under [Image Capture Illumination on page 195](#). The imager issues a fast warble beep and the LED turns green, signifying a successful parameter entry.

Other parameters require scanning several barcodes. See the parameter descriptions for this procedure.

## Errors While Scanning

Unless otherwise specified, to correct an error during a scanning sequence, just re-scan the correct parameter.

## Image Capture Preferences Parameter Defaults

[Table 27](#) lists defaults for image capture preference parameters. Change these values in one of two ways:

- Scan the appropriate barcodes in this chapter. The new value replaces the standard default value in memory. To recall default parameter values, see [Default Parameters on page 142](#).
- Configure the scanner using the 123Scan configuration program. See [123Scan and Software Tools](#).



**NOTE:** See [Standard Parameter Defaults](#) for all user preference, host, symbology, and miscellaneous default parameters.

**Table 27** Image Capture Preferences Parameter Defaults

Parameter	Parameter Number <sup>1</sup>	SSI Number <sup>2</sup>	Default	Page Number
<b>Image Capture Preferences</b>				
Operational Modes	N/A	N/A	N/A	<a href="#">194</a>
Image Capture Illumination	361	F0h 69h	Enable	<a href="#">195</a>
Image Capture Autoexposure	360	F0h 68h	Enable	<a href="#">195</a>
Fixed Exposure	567	F4h F1h 37h	100	<a href="#">196</a>
Analog Gain	1232	F4h D0h	Analog Gain x 2	<a href="#">197</a>
Digital Gain	1233	F4h D1h	32	<a href="#">197</a>
Snapshot Mode Timeout	323	F0h 43h	0 (30 seconds)	<a href="#">198</a>
Snapshot Aiming Pattern	300	F0h 2Ch	Enable	<a href="#">199</a>
Silence Operational Mode Changes	1293	F8h 05h 0Dh	Disable (do not silence)	<a href="#">199</a>
Image Cropping	301	F0h 2Dh	Disable	<a href="#">200</a>

1. Parameter number decimal values are used for programming via RSM commands.

2. SSI number hex values are used for programming via SSI commands.

## Image Capture Preferences

**Table 27** Image Capture Preferences Parameter Defaults (Continued)

Parameter	Parameter Number <sup>1</sup>	SSI Number <sup>2</sup>	Default	Page Number
Crop to Pixel Addresses	315 316 317 318	F4h F0h 3Bh F4h F0h 3Ch F4h F0h 3Dh F4h F0h 3Eh	0 top 0 left 799 bottom 1279 right	200
Image Size (Number of Pixels)	302	F0h 2Eh	Full	202
Image Brightness (Target White)	390	F0h 86h	180	203
JPEG Image Options	299	F0h 2Bh	Quality	203
JPEG Quality Value	305	F0h 31h	65	204
JPEG Size Value	561	F1h 31h	160 kB	204
Image Enhancement	564	F1h 34h	Low (1)	205
Image File Format Selection	304	F0h 30h	JPEG	206
Image Rotation	665	F1h 99h	0	207
Bits per Pixel (BPP)	303	F0h 2Fh	8 BPP	208
Signature Capture	93	5Dh	Disable	209
Signature Capture Image File Format Selection	313	F0h 39h	JPEG	210
Signature Capture Bits per Pixel (BPP)	314	F0h 3Ah	8 BPP	211
Signature Capture Width	366	F4h F0h 6Eh	400	212
Signature Capture Height	367	F4h F0h 6Fh	100	212
Signature Capture JPEG Quality	421	F0h A5h	65	213
Video Mode Format Selector	916	F2h 94h	JPEG	213
Video View Finder	324	F0h 44h	Disable	214
Target Video Frame Size	328	F0h 48h	2200 bytes	214
Video View Finder Image Size	329	F0h 49h	1700 bytes	215
Video Resolution	667	F1h 9Bh	1/4 resolution	215

1. Parameter number decimal values are used for programming via RSM commands.

2. SSI number hex values are used for programming via SSI commands.

## Image Capture Preferences

The parameters in this chapter control image capture characteristics.

### Operational Modes

The imager has three modes of operation:

- Decode Mode
- Snapshot Mode
- Video Mode.

#### Decode Mode

By default, when you press the trigger the imager attempts to locate and decode enabled barcodes within its field of view. The imager remains in this mode until it decodes a barcode or you release the trigger.

#### Snapshot Mode

Use Snapshot Mode to capture a high-quality image and transmit it to the host. Scan the **Snapshot Mode** barcode to temporarily enter this mode. While in this mode the imager blinks the green LED at one-second intervals to indicate it is not in standard operating (decode) mode.

In Snapshot Mode, the imager turns on its aiming pattern to highlight the area to capture in the image. The next trigger press instructs the imager to capture a high quality image and transmit it to the host. A short time may pass (less than two seconds) between when the trigger is pressed and the image is captured as the imager adjusts to lighting conditions. Hold the imager steady until a single beep indicates that it captured the image.

If you do not press the trigger within the Snapshot Mode Timeout period, the imager returns to Decode Mode. Use [Snapshot Mode Timeout on page 198](#) to adjust this timeout period. The default timeout period is 30 seconds.

To disable the aiming pattern during Snapshot Mode, see [Snapshot Aiming Pattern on page 199](#).



**Snapshot Mode**

#### Video Mode

In this mode the imager behaves as a video camera as long as you press the trigger. Release the trigger to return to Decode Mode. Scan this barcode to temporarily enter Video Capture Mode.



**Video Mode**

## Image Capture Illumination

**Parameter # 361**

**SSI # F0h 69h**

Scan **Enable Image Capture Illumination** to turn on illumination during every image capture. This usually results in superior images. The effectiveness of illumination decreases as the distance to the target increases.

Scan **Disable Image Capture Illumination** to prevent the imager from using illumination.

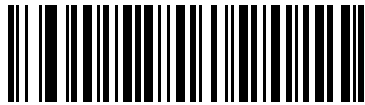

**\*Enable Image Capture Illumination  
(1)**

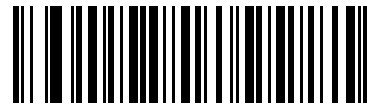

**Disable Image Capture Illumination  
(0)**

## Image Capture Autoexposure

**Parameter # 360**

**SSI # F0h 68h**

Scan **Enable Image Capture Autoexposure** to allow the imager to control gain settings and exposure (integration) time to best capture an image for the selected operation mode.

Scan **Disable Image Capture Autoexposure** to manually adjust the gain and exposure time (see the following pages). This option is only recommended for advanced users with difficult image capture situations.



**\*Enable Image Capture Autoexposure  
(1)**

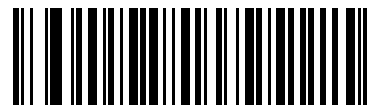

**Disable Image Capture Autoexposure  
(0)**

## Fixed Exposure

### Parameter # 567

### SSI # F4h F1h 37h

Type: Word

Range: 1 - 1000

This parameter configures the exposure used in manual mode for Snapshot and Video modes.

Each integer value represents 100  $\mu$ s of exposure. The default value is 100 which results in an exposure setting of 10 ms.

To set the exposure, scan the **Fixed Exposure** barcode, and then scan four numeric barcodes from [Numeric Barcodes](#) representing the value. Leading zeros are required. For example, to set a Fixed Exposure value of 99, scan 0, 0, 9, 9.



**Fixed Exposure**  
**(4 digits)**



## Analog and Digital Gain

If you disable [Image Capture Autoexposure](#) you can modify the engine's analog and digital gain using these parameters. Total gain = analog gain x digital gain.

### Analog Gain

Parameter # 1232

SSI # F4h D0h

Select an option to set an analog gain value.



Analog Gain x 1  
(00h)

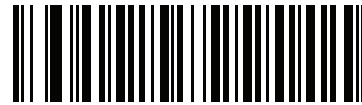

\*Analog Gain x 2  
(01h)



Analog Gain x 4  
(02h)

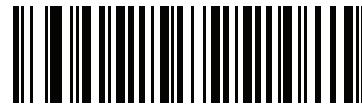

Analog Gain x 8  
(03h)

### Digital Gain

Parameter # 1233

SSI # F4h D1h

To set the digital gain, scan the following barcode, then scan two barcodes from [Numeric Barcodes](#) to enter a 2-digit value for the digital gain. The default is 32.

A value of 32 = x 1 digital gain; i.e., digital gain = 1/32 x digital gain parameter value.



Digital Gain

## Snapshot Mode Timeout

### Parameter # 323

### SSI # F0h 43h

This parameter sets the amount of time the imager remains in Snapshot Mode. The imager exits Snapshot Mode when you press the trigger, or when the Snapshot Mode Timeout elapses. To set this timeout value, scan the **Set Snapshot Mode Timeout** barcode, and then scan a barcode from [Numeric Barcodes](#). The default value is 0 which represents 30 seconds; values increment by 30. For example, 1 = 60 seconds, 2 = 90 seconds.

To quickly re-set the default timeout to 30 seconds, scan the **30 Seconds** barcode.

If you scan **No Timeout**, the imager remains in Snapshot Mode until you press the trigger.



**Set Snapshot Mode Timeout**

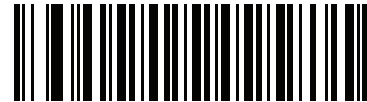

**\*30 Seconds**

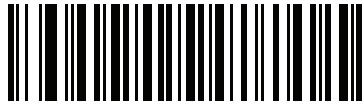

**No Timeout**

## Snapshot Aiming Pattern

Parameter # 300

SSI # F0h 2Ch

Scan one of the following barcodes to select whether or not to project the aiming pattern when in Snapshot Mode.



**NOTE:** If enabled, the aiming pattern frames the image for aiming purposes and does not appear in the captured image.



**\*Enable Snapshot Aiming Pattern  
(1)**



**Disable Snapshot Aiming Pattern  
(0)**

## Silence Operational Mode Changes

Parameter # 1293

SSI # F8h 05h 0Dh

Scan **Silence Operational Mode Changes** to silence the beeper when switching between operational modes (e.g., from Decode Mode to Snapshot Mode).



**Silence Operational Mode Changes (Enable)  
(1)**



**\*Do Not Silence Operational Mode Changes  
(Disable)  
(0)**

## Image Cropping

### Parameter # 301

#### SSI # F0h 2Dh

Scan the **Enable Image Cropping** barcode to crop a captured image to the pixel addresses set in [Crop to Pixel Addresses on page 200](#). Scan **Disable Image Cropping** to present the full 1280 x 800 pixels.



**Enable Image Cropping  
(1)**



**\*Disable Image Cropping  
(Use Full 1280 x 800 Pixels)  
(0)**

## Crop to Pixel Addresses

### Parameter # 315

#### SSI # F4h F0h 3Bh (Top)

### Parameter # 316

#### SSI # F4h F0h 3Ch (Left)

### Parameter # 317

#### SSI # F4h F0h 3Dh (Bottom)

### Parameter # 318

#### SSI # F4h F0h 3Eh (Right)

If you enabled [Image Cropping](#), set the pixel addresses from (0,0) to (1279 x 799) to crop to.

Columns are numbered from 0 to 1279, rows from 0 to 799. Specify values for Top, Left, Bottom, and Right, where Top and Bottom correspond to row pixel addresses, and Left and Right correspond to column pixel addresses. For example, for a 4 row x 8 column image in the extreme bottom-right section of the image, set the following values:

Top = 796, Bottom = 799, Left = 1272, Right = 1279

To set the pixel addresses, scan each of the following barcodes, and then scan four numeric barcodes from [Numeric Barcodes](#) representing the value. Leading zeros are required. For example, to crop the top pixel address to 3, scan 0, 0, 0, 3. The defaults are:

Top = 0, Bottom = 799, Left = 0, Right = 1279



**NOTE:** The imager has a cropping resolution of 4 pixels. Setting the cropping area to less than 4 pixels (after resolution adjustment, see [Image Size \(Number of Pixels\) on page 202](#)) transfers the entire image.

**Crop to Pixel Address (continued)**



**Top Pixel Address**  
(0 - 799 Decimal)



**Left Pixel Address**  
(0 - 1279 Decimal)

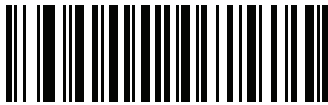

**Bottom Pixel Address**  
(0 - 799 Decimal)

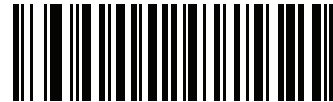

**Right Pixel Address**  
(0 - 1279 Decimal)

## Image Size (Number of Pixels)

### Parameter # 302

### SSI # F0h 2Eh

This option alters image resolution before compression. Multiple pixels are combined to one pixel, resulting in a smaller image containing the original content with reduced resolution.

Scan one of the following barcodes to select an image size.

**Table 28** Image Size

Resolution Value	Uncropped Image Size
Full	1280 x 800
1/2	640 x 400
1/4	320 x 200



**\*Full Resolution  
(0)**



**1/2 Resolution  
(1)**



**1/4 Resolution  
(3)**

## Image Brightness (Target White)

### Parameter # 390

### SSI # F0h 86h

Type: Byte

Range: 1 - 240

This parameter sets the Target White value used in Snapshot and Video Viewfinder modes when using autoexposure. White and black are defined as 240 decimal and 1, respectively. Setting the value to the factory default of 180 sets the white level of the image to ~180.

Scan the **Image Brightness** barcode, and then scan three numeric barcodes from [Numeric Barcodes](#) representing the value. Leading zeros are required. For example, to set an Image Brightness value of 99, scan 0, 9, 9.



\*180



Image Brightness  
(3 digits)

## JPEG Image Options

### Parameter # 299

### SSI # F0h 2Bh

Scan one of the following barcodes to optimize JPEG images for either size or quality:

- **JPEG Quality Selector** - Enter a quality value via the [JPEG Quality Value](#) parameter; the imager then selects the corresponding image size.
- **JPEG Size Selector** - Enter a size value via the [JPEG Size Value](#) parameter; the imager then selects the best image quality.



\*JPEG Quality Selector  
(1)



JPEG Size Selector  
(0)

## JPEG Quality Value

### Parameter # 305

### SSI # F0h 31h

If you selected **JPEG Quality Selector**, scan the **JPEG Quality Value** barcode, and then scan three barcodes from [Numeric Barcodes](#) corresponding to a value from 5 to 100, where 100 represents the highest quality image. Leading zeros are required. For example, to set an image quality value of 55, scan 0, 5, 5.



**JPEG Quality Value**  
(Default: 065)  
(5 - 100 Decimal)

## JPEG Size Value

### Parameter # 561

### SSI # F1h 31h

Type: Word

Range: 5-350

If you selected **JPEG Size Selector**, scan the **JPEG Size Value** barcode, and then scan three numeric barcodes from [Numeric Barcodes](#) representing the target JPEG file size in kilobytes (KB). Leading zeros are required. For example, to set an image file size value of 99, scan 0, 9, 9.



**CAUTION:** JPEG compression may take 10 to 15 seconds based on the amount of information in the target image. Scanning **JPEG Quality Selector** (default setting) on [page 203](#) produces a compressed image that is consistent in quality and compression time.



**JPEG Size Value**  
(Default: 160)  
(3 digits)



## Image Enhancement

### Parameter # 564

### SSI # F1h 34h

This parameter uses a combination of edge sharpening and contrast enhancement to produce an image that is visually pleasing.

Scan one of the following barcodes to select the level of image enhancement:

- Off (0)
- Low (1) - Default
- Medium (2)
- High (3)



**Off  
(0)**



**\*Low  
(1)**



**Medium  
(2)**



**High  
(3)**

## Image File Format Selector

### Parameter # 304

### SSI # F0h 30h

Scan one of the following barcodes to select an image format appropriate for the system (BMP, TIFF, or JPEG). The imager stores captured images in the selected format.



**BMP File Format**  
**(3)**



**\*JPEG File Format**  
**(1)**



**TIFF File Format**  
**(4)**

## Image Rotation

Parameter # 665

SSI # F1h 99h

Scan one of the following barcodes to rotate the image 0, 90, 180, or 270 degrees.



**\*Rotate 0°**  
**(0)**



**Rotate 90°**  
**(1)**



**Rotate 180°**  
**(2)**

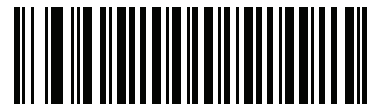

**Rotate 270°**  
**(3)**

## Bits Per Pixel

### Parameter # 303

### SSI # F0h 2Fh

Scan one of the following barcodes to select the number of significant bits per pixel (BPP) to use when capturing an image:

- **1 BPP** - For a black and white image.
- **4 BPP** - Assigns 1 of 16 levels of grey to each pixel.
- **8 BPP** - Assigns 1 of 256 levels of grey to each pixel.



**NOTE:** The imager ignores these settings for JPEG file formats, which only support **8 BPP**. TIFF file formats only support **4 BPP** and **8 BPP**. Selecting **1 BPP** for TIFF applies the **4 BPP** option.



**1 BPP**  
**(0)**



**4 BPP**  
**(1)**



**\*8 BPP**  
**(2)**

## Signature Capture

### Parameter # 93

#### SSI # 5Dh

A signature capture barcode is a special-purpose symbology which delineates a signature capture area in a document with a machine-readable format. The recognition pattern is variable so it can optionally provide an index to various signatures. The region inside the barcode pattern is considered the signature capture area. See [Signature Capture Code](#) for more information.

Scan one of the following barcodes to enable or disable Signature Capture.



**Enable Signature Capture  
(1)**



**\*Disable Signature Capture  
(0)**

## Signature Capture File Format Selector

### Parameter # 313

### SSI # F0h 39h

Decoding a signature capture barcode de-skews the signature image and converts the image to a BMP, JPEG, or TIFF file format. The output data includes the file descriptor followed by the formatted signature image.

**Table 29** Output File Format

File Descriptor			Signature Image
Output Format (1 byte)	Signature Type (1 byte)	Signature Image Size (4 bytes) (BIG Endian)	
JPEG - 1	1-8	0x00000400	0x00010203....
BMP - 3			
TIFF - 4			

Scan one of the following barcodes to select a signature file format appropriate for the system (BMP, TIFF, or JPEG). The imager stores captured signatures in the selected format.



**BMP Signature Format  
(3)**



**\*JPEG Signature Format  
(1)**



**TIFF Signature Format  
(4)**

## Signature Capture Bits Per Pixel

### Parameter # 314

### SSI # F0h 3Ah

Scan one of the following barcodes to select the number of significant bits per pixel (BPP) to use when capturing a signature:

- **1 BPP** - For a black and white image.
- **4 BPP** - Assigns 1 of 16 levels of grey to each pixel.
- **8 BPP** - Assigns 1 of 256 levels of grey to each pixel.



**NOTE:** The imager ignores these settings for JPEG file formats, which only support **8 BPP**.



**1 BPP**  
**(0)**



**4 BPP**  
**(1)**



**\*8 BPP**  
**(2)**

## Signature Capture Width

**Parameter # 366**

**SSI # F4h F0h 6Eh**

The aspect ratio of the Signature Capture Width and Signature Capture Height parameters must match that of the signature capture area. For example, a 4 x 1 inch signature capture area requires a 4 to 1 aspect ratio of width to height.

To set the width of the signature capture box, scan the **Signature Capture Width** barcode, and then scan four barcodes from [Numeric Barcodes](#) corresponding to a value in the range of 001 to 1280 decimal.



**Signature Capture Width (Default: 400)**  
(001 - 1280 Decimal)

## Signature Capture Height

**Parameter # 367**

**SSI # F4h F0h 6Fh**

To set the height of the signature capture box, scan the **Signature Capture Height** barcode, and then scan three barcodes from [Numeric Barcodes](#) corresponding to a value in the range of 001 to 800 decimal.



**Signature Capture Height (Default: 100)**  
(001 - 800 Decimal)



## Signature Capture JPEG Quality

Parameter # 421

SSI # F0h A5h

Scan the **JPEG Quality Value** barcode, and then scan three barcodes from [Numeric Barcodes](#) corresponding to a value from 005 to 100, where 100 represents the highest quality image.



**JPEG Quality Value (Default: 065)**  
(5 - 100 Decimal)

## Video Mode Format Selector

Parameter # 916

SSI # F2h 94h

When the imager is in Video Mode, scan one of the following barcodes to select whether to send data in BMP or JPEG format.

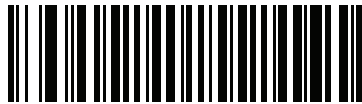

**BMP File Format**  
(3)



**\*JPEG File Format**  
(1)

## Video View Finder

Parameter # 324

SSI # F0h 44h

Scan one of the following barcodes to select whether to project the video view finder while in Snapshot Mode.

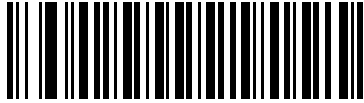

Enable Video View Finder  
(1)

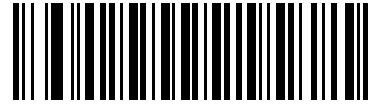

\*Disable Video View Finder  
(0)

## Target Video Frame Size

Parameter # 328

SSI # F0h 48h

This parameter sets the number of 100-byte blocks to transmit per second. A smaller value transmits more frames per second but reduces video quality, while a larger value increases video quality but slows transmission.

Scan the **Target Video Frame Size** barcode, and then scan three barcodes from [Numeric Barcodes](#) corresponding to the 100-byte value from 800 to 20,000 bytes. For example, to select 1500 bytes, enter 0, 1, 5. To select 900 bytes, enter 0, 0, 9. The default is 2200 bytes.

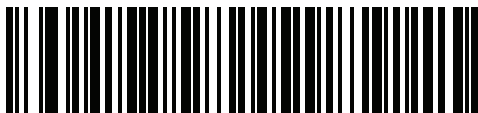

Target Video Frame Size

## Video View Finder Image Size

### Parameter # 329

#### SSI # F0h 49h

This parameter sets the number of 100-byte blocks. Values range from 800 to 12,000 bytes. A smaller value transmits more frames per second, while a larger value increases video quality.

Scan the **Video View Finder Image Size** barcode, and then scan three barcodes from [Numeric Barcodes](#) corresponding to the 100-byte value from 800 to 12,000 bytes. For example, to select 1500 bytes, enter 0, 1, 5. To select 900 bytes, enter 0, 0, 9. The default is 1700 bytes.



Video View Finder Image Size

## Video Resolution

### Parameter # 667

#### SSI # F1h 9Bh

This parameter alters the video resolution before transmission. Rows and columns are removed from the image, resulting in a smaller video image containing the original content with reduced resolution.

Scan one of the following barcodes to select a value:

**Table 30** Resolution and Video Image Sizes

Resolution Value	Video Image Size
Full	1280 x 800
1/2	640 x 400
1/4	320 x 200



Full Resolution  
(0)



1/2 Resolution  
(1)



\*1/4 Resolution  
(3)

# Symbologies

---

## Introduction

You can program the scanner to perform various functions, or activate different features. This chapter describes symbology features and provides programming barcodes for selecting these features.

The scanner ships with the settings shown in [Table 31 on page 217](#) (also see [Standard Parameter Defaults](#) for all defaults). If the default values suit requirements, programming is not necessary.

---

## Setting Parameters

To set feature values, scan a single barcode or a short barcode sequence. The settings are stored in non-volatile memory and are preserved even when the scanner powers down.



**NOTE:** Most computer monitors allow scanning barcodes directly on the screen. When scanning from the screen, be sure to set the document magnification to a level where you can see the barcode clearly, and bars and/or spaces do not merge.

If not using a USB cable, select a host type (see each host chapter for specific host information) after the power-up beeps sound. This is only necessary upon the first power-up when connected to a new host.

To return all features to default values, see [Default Parameters on page 142](#). Throughout the programming barcode menus, asterisks (\*) indicate default values.



\* Indicates default — **\*Enable Parameter** — Feature/option  
(1) — Option value

## Scanning Sequence Examples

In most cases, scanning one barcode sets the parameter value. For example, to transmit barcode data without the UPC-A check digit, scan the **Do Not Transmit UPC-A Check Digit** barcode under [Transmit UPC-A Check Digit on page 235](#). The scanner issues a fast warble beep and the LED turns green, signifying a successful parameter entry.

Other parameters require scanning several barcodes. See the parameter descriptions for this procedure.

## Errors While Scanning

Unless otherwise specified, to correct an error during a scanning sequence, just re-scan the correct parameter.

## Symbology Parameter Defaults

[Table 31](#) lists defaults for all symbology parameters. Change these values in one of two ways:

- Scan the appropriate barcodes in this chapter. The new value replaces the standard default value in memory. To recall the default parameter values, see [Default Parameters on page 142](#).
- Configure the scanner using the 123Scan configuration program. See [123Scan and Software Tools](#).



**NOTE:** See [Standard Parameter Defaults](#) for all user preference, host, symbology, and miscellaneous default parameters.

**Table 31** Symbology Parameter Defaults

Parameter	Parameter Number <sup>1</sup>	SSI Number <sup>2</sup>	Default	Page Number
<b>Enable/Disable All Code Types</b>				<a href="#">224</a>
<b>1D Symbologies</b>				
<b>UPC/EAN/JAN</b>				
UPC-A	1	01h	Enable	<a href="#">225</a>
UPC-E	2	02h	Enable	<a href="#">225</a>
UPC-E1	12	0Ch	Disable	<a href="#">226</a>
EAN-8/JAN 8	4	04h	Enable	<a href="#">226</a>
EAN-13/JAN 13	3	03h	Enable	<a href="#">227</a>
Bookland EAN	83	53h	Disable	<a href="#">227</a>
Bookland ISBN Format	576	F1h 40h	ISBN-10	<a href="#">228</a>
ISSN EAN	617	F1h 69h	Disable	<a href="#">229</a>
Decode UPC/EAN/JAN Supplementals (2 and 5 digits)	16	10h	Ignore	<a href="#">230</a>

1. Parameter number decimal values are used for programming via RSM commands.

2. SSI number hex values are used for programming via SSI commands.

**Table 31** Symbology Parameter Defaults (Continued)

Parameter	Parameter Number <sup>1</sup>	SSI Number <sup>2</sup>	Default	Page Number
User-Programmable Supplementals			000	<a href="#">233</a>
Supplemental 1:	579	F4h F1h 43h		
Supplemental 2:	580	F4h F1h 44h		
UPC/EAN/JAN Supplemental Redundancy	80	50h	10	<a href="#">233</a>
Decode UPC/EAN/JAN Supplemental AIM ID	672	F1h A0h	Combined	<a href="#">234</a>
Transmit UPC-A Check Digit	40	28h	Enable	<a href="#">235</a>
Transmit UPC-E Check Digit	41	29h	Enable	<a href="#">235</a>
Transmit UPC-E1 Check Digit	42	2Ah	Enable	<a href="#">236</a>
UPC-A Preamble	34	22h	System Character	<a href="#">237</a>
UPC-E Preamble	35	23h	System Character	<a href="#">238</a>
UPC-E1 Preamble	36	24h	System Character	<a href="#">239</a>
Convert UPC-E to A	37	25h	Disable	<a href="#">240</a>
Convert UPC-E1 to A	38	26h	Disable	<a href="#">240</a>
EAN/JAN Zero Extend	39	27h	Disable	<a href="#">241</a>
UCC Coupon Extended Code	85	55h	Disable	<a href="#">241</a>
Coupon Report	730	F1h DAh	New Coupon Format	<a href="#">242</a>
UPC Reduced Quiet Zone	1289	F8h 05h 09h	Disable	<a href="#">243</a>
<b>Code 128</b>				
Code 128	8	08h	Enable	<a href="#">243</a>
Set Length(s) for Code 128	209, 210	D1h, D2h	Any Length	<a href="#">244</a>
GS1-128 (formerly UCC/EAN-128)	14	0Eh	Enable	<a href="#">245</a>
ISBT 128	84	54h	Enable	<a href="#">246</a>
ISBT Concatenation	577	F1h 41h	Disable Enable for DS4608-HC	<a href="#">247</a>
Check ISBT Table	578	F1h 42h	Enable	<a href="#">248</a>
ISBT Concatenation Redundancy	223	DFh	10	<a href="#">248</a>
Code 128 <FNC4>	1254	F8h 04h E6h	Honor	<a href="#">249</a>

1. Parameter number decimal values are used for programming via RSM commands.

2. SSI number hex values are used for programming via SSI commands.

**Table 31** Symbology Parameter Defaults (Continued)

Parameter	Parameter Number <sup>1</sup>	SSI Number <sup>2</sup>	Default	Page Number
Code 128 Security Level	751	F1h EFh	Security Level 1 Security Level 2 for DS4608-HC	<a href="#">250</a>
Code 128 Reduced Quiet Zone	1208	F8h 04h B8h	Disable	<a href="#">251</a>
<b>Code 39</b>				
Code 39	0	00h	Enable	<a href="#">251</a>
Trioptic Code 39	13	0Dh	Disable	<a href="#">252</a>
Convert Code 39 to Code 32 (Italian Pharmacy Code)	86	56h	Disable	<a href="#">252</a>
Code 32 Prefix	231	E7h	Disable	<a href="#">253</a>
Set Length(s) for Code 39	18, 19	12h, 13h	1 to 55	<a href="#">253</a>
Code 39 Check Digit Verification	48	30h	Disable	<a href="#">255</a>
Transmit Code 39 Check Digit	43	2Bh	Disable	<a href="#">255</a>
Code 39 Full ASCII Conversion	17	11h	Disable	<a href="#">256</a>
Code 39 Security Level	750	F1h EEh	Security Level 1	<a href="#">257</a>
Code 39 Reduced Quiet Zone	1209	F8h 04h B9h	Disable	<a href="#">259</a>
<b>Code 93</b>				
Code 93	9	09h	Enable	<a href="#">259</a>
Set Length(s) for Code 93	26, 27	1Ah, 1Bh	1 to 55	<a href="#">260</a>
<b>Code 11</b>				
Code 11	10	0Ah	Disable	<a href="#">262</a>
Set Lengths for Code 11	28, 29	1Ch, 1Dh	4 to 55	<a href="#">262</a>
Code 11 Check Digit Verification	52	34h	Disable	<a href="#">264</a>
Transmit Code 11 Check Digit(s)	47	2Fh	Disable	<a href="#">265</a>
<b>Interleaved 2 of 5 (ITF)</b>				
Interleaved 2 of 5 (ITF)	6	06h	Enable	<a href="#">265</a>
Set Lengths for I 2 of 5	22, 23	16h, 17h	6 to 55	<a href="#">266</a>
I 2 of 5 Check Digit Verification	49	31h	Disable	<a href="#">268</a>
Transmit I 2 of 5 Check Digit	44	2Ch	Disable	<a href="#">268</a>
Convert I 2 of 5 to EAN 13	82	52h	Disable	<a href="#">269</a>

1. Parameter number decimal values are used for programming via RSM commands.

2. SSI number hex values are used for programming via SSI commands.

**Table 31** Symbology Parameter Defaults (Continued)

Parameter	Parameter Number <sup>1</sup>	SSI Number <sup>2</sup>	Default	Page Number
Febraban	1750	F8h 06h D6h	Disable	<a href="#">269</a>
I 2 of 5 Security Level	1121	F8h 04h 61h	Security Level 1	<a href="#">270</a>
I 2 of 5 Reduced Quiet Zone	1210	F8h 04h BAh	Disable	<a href="#">271</a>
<b>Discrete 2 of 5 (DTF)</b>				
Discrete 2 of 5	5	05h	Disable	<a href="#">271</a>
Set Length(s) for D 2 of 5	20, 21	14h 15h	1 to 55	<a href="#">272</a>
<b>Codabar (NW - 7)</b>				
Codabar	7	07h	Enable	<a href="#">274</a>
Set Lengths for Codabar	24, 25	18h, 19h	4 to 55	<a href="#">274</a>
CLSI Editing	54	36h	Disable	<a href="#">276</a>
NOTIS Editing	55	37h	Disable	<a href="#">276</a>
Codabar Security Level	1776	F8h 06h F0h	Security Level 1	<a href="#">277</a>
Codabar Upper or Lower Case Start/ Stop Characters Detection	855	F2h 57h	Upper Case	<a href="#">278</a>
Codabar Mod 16 Check Digit Verification	1784	F8h 06h F8h	Disable	<a href="#">278</a>
Transmit Codabar Check Digit	704	F1h C0h	Disable	<a href="#">279</a>
<b>MSI</b>				
MSI	11	0Bh	Disable	<a href="#">279</a>
Set Length(s) for MSI	30, 31	1Eh, 1Fh	4 to 55	<a href="#">280</a>
MSI Check Digits	50	32h	One	<a href="#">281</a>
Transmit MSI Check Digit	46	2Eh	Disable	<a href="#">282</a>
MSI Check Digit Algorithm	51	33h	Mod 10/Mod 10	<a href="#">282</a>
MSI Reduced Quiet Zone	1392	F8h 05h 70h	Disable	<a href="#">283</a>
<b>Chinese 2 of 5</b>				
Chinese 2 of 5	408	F0h 98h	Disable	<a href="#">283</a>
<b>Matrix 2 of 5</b>				
Matrix 2 of 5	618	F1h 6Ah	Disable	<a href="#">284</a>
Matrix 2 of 5 Lengths	619 620	F1h 6Bh F1h 6Ch	4 to 55	<a href="#">284</a>
Matrix 2 of 5 Check Digit	622	F1h 6Eh	Disable	<a href="#">286</a>

1. Parameter number decimal values are used for programming via RSM commands.

2. SSI number hex values are used for programming via SSI commands.



**Table 31** Symbology Parameter Defaults (Continued)

Parameter	Parameter Number <sup>1</sup>	SSI Number <sup>2</sup>	Default	Page Number
Transmit Matrix 2 of 5 Check Digit	623	F1h 6Fh	Disable	<a href="#">286</a>
<b>Korean 3 of 5</b>				
Korean 3 of 5	581	F1h 45h	Disable	<a href="#">287</a>
<b>Inverse 1D</b>	586	F1h 4Ah	Regular	<a href="#">288</a>
<b>GS1 DataBar</b>				
GS1 DataBar Omnidirectional	338	F0h 52h	Enable	<a href="#">289</a>
GS1 DataBar Limited	339	F0h 53h	Enable	<a href="#">289</a>
GS1 DataBar Expanded	340	F0h 54h	Enable	<a href="#">290</a>
Convert GS1 DataBar to UPC/EAN/JAN	397	F0h 8Dh	Disable	<a href="#">290</a>
GS1 DataBar Security Level	1706	F8h 06h AAh	Level 1	<a href="#">291</a>
GS1 DataBar Limited Margin Check	728	F1h D8h	Level 3	<a href="#">292</a>
<b>Symbology-Specific Security Features</b>				
Redundancy Level	78	4Eh	1	<a href="#">294</a>
Security Level	77	4Dh	1	<a href="#">296</a>
1D Quiet Zone Level	1288	F8h 05h 08h	1	<a href="#">297</a>
Intercharacter Gap Size	381	F0h 7Dh	Normal	<a href="#">298</a>
<b>Composite Codes</b>				
Composite CC-C	341	F0h 55h	Disable	<a href="#">299</a>
Composite CC-A/B	342	F0h 56h	Disable	<a href="#">299</a>
Composite TLC-39	371	F0h 73h	Disable	<a href="#">300</a>
Composite Inverse	1113	F8h 04h 59h	Regular	<a href="#">300</a>
UPC Composite Mode	344	F0h 58h	UPC Never Linked	<a href="#">301</a>
Composite Beep Mode	398	F0h 8Eh	Beep As Each Code Type is Decoded	<a href="#">302</a>
GS1-128 Emulation Mode for UCC/EAN Composite Codes	427	F0h ABh	Disable	<a href="#">303</a>
<p>1. Parameter number decimal values are used for programming via RSM commands.</p> <p>2. SSI number hex values are used for programming via SSI commands.</p>				

**Table 31** Symbology Parameter Defaults (Continued)

Parameter	Parameter Number <sup>1</sup>	SSI Number <sup>2</sup>	Default	Page Number
<b>2D Symbologies</b>				
PDF417	15	0Fh	Enable	304
MicroPDF417	227	E3h	Disable	304
Code 128 Emulation	123	7Bh	Disable	305
Data Matrix	292	F0h 24h	Enable	306
GS1 Data Matrix	1336	F8h 05h 38h	Disable	306
Data Matrix Inverse	588	F1h 4Ch	Inverse Autodetect	307
Decode Data Matrix Mirror Images	537	F1h 19h	Auto	308
Maxicode	294	F0h 26h	Disable	309
QR Code	293	F0h 25h	Enable	310
GS1 QR	1343	F8h 05h 3Fh	Enable	310
MicroQR	573	F1h 3Dh	Enable	311
Linked QR Mode	1847	737h	Linked QR Only	312
Aztec	574	F1h 3Eh	Enable	313
Aztec Inverse	589	F1h 4Dh	Inverse Autodetect	314
Han Xin	1167	F8h 04h 8Fh	Disable	315
Han Xin Inverse	1168	F8h 04h 90h	Regular	316
Grid Matrix	1718	F8h 06h B6h	Disable	317
Grid Matrix Inverse	1719	F8h 06h B7h	Regular	318
Grid Matrix Mirror	1736	F8h 06h C8h	Regular Only	319
DotCode	1906	F8 07 72h	Disable	320
DotCode Inverse	1907	F8 07 73h	Inverse Autodetect	321
DotCode Mirrored	1908	F8 07 74h	Autodetect	322
DotCode Prioritize	1937	F8 07 91h	Enable	323
<b>Macro PDF</b>				
Flush Macro PDF Buffer	N/A	N/A	N/A	324
Abort Macro PDF Entry	N/A	N/A	N/A	324
<b>Postal Codes</b>				
US Postnet	89	59h	Disable	325
1. Parameter number decimal values are used for programming via RSM commands.				
2. SSI number hex values are used for programming via SSI commands.				

**Table 31** Symbology Parameter Defaults (Continued)

Parameter	Parameter Number <sup>1</sup>	SSI Number <sup>2</sup>	Default	Page Number
US Planet	90	5Ah	Disable	<a href="#">325</a>
Transmit US Postal Check Digit	95	5Fh	Enable	<a href="#">326</a>
UK Postal	91	5Bh	Disable	<a href="#">326</a>
Transmit UK Postal Check Digit	96	60h	Enable	<a href="#">327</a>
Japan Postal	290	F0h 22h	Disable	<a href="#">327</a>
Australia Post	291	F0h 23h	Disable	<a href="#">328</a>
Australia Post Format	718	F1h CEh	Autodiscriminate	<a href="#">329</a>
Netherlands KIX Code	326	F0h 46h	Disable	<a href="#">330</a>
USPS 4CB/One Code/Intelligent Mail	592	F1h 50h	Disable	<a href="#">330</a>
UPU FICS Postal	611	F1h 63h	Disable	<a href="#">331</a>
Mailmark	1337	F8h 05h 39h	Disable	<a href="#">331</a>

1. Parameter number decimal values are used for programming via RSM commands.  
2. SSI number hex values are used for programming via SSI commands.

---

## Enable/Disable All Code Types

Scan the **Disable All Code Types** barcode to disable all symbologies. This is useful when enabling only a few code types.

Scan **Enable All Code Types** to enable all symbologies. This is useful if you need to disable only a few code types.

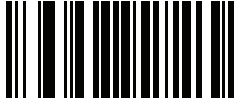

**Disable All Code Types**



**Enable All Code Types**

---

## UPC/EAN/JAN

### UPC-A

#### Parameter # 1

#### SSI # 01h

Scan one of the following barcodes to enable or disable UPC-A.

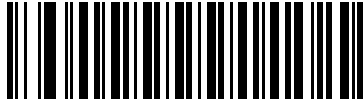

**\*Enable UPC-A  
(1)**



**Disable UPC-A  
(0)**

### UPC-E

#### Parameter # 2

#### SSI # 02h

Scan one of the following barcodes to enable or disable UPC-E.

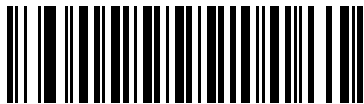

**\*Enable UPC-E  
(1)**



**Disable UPC-E  
(0)**

## UPC-E1

Parameter # 12

SSI # 0Ch

Scan one of the following barcodes to enable or disable UPC-E1.



**NOTE:** UPC-E1 is not a UCC (Uniform Code Council) approved symbology.

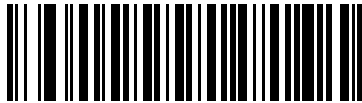

Enable UPC-E1  
(1)

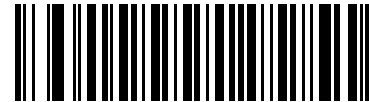

\*Disable UPC-E1  
(0)

## EAN-8/JAN-8

Parameter # 4

SSI # 04h

Scan one of the following barcodes to enable or disable EAN-8/JAN-8.



\*Enable EAN-8/JAN-8  
(1)



Disable EAN-8/JAN-8  
(0)

## EAN-13/JAN-13

Parameter # 3

SSI # 03h

Scan one of the following barcodes to enable or disable EAN-13/JAN-13.

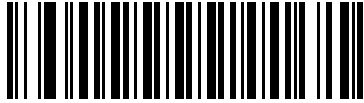

**\*Enable EAN-13/JAN-13  
(1)**

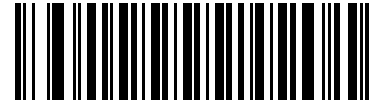

**Disable EAN-13/JAN-13  
(0)**

## Bookland EAN

Parameter # 83

SSI # 53h

Scan one of the following barcodes to enable or disable Bookland EAN.

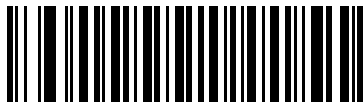

**Enable Bookland EAN  
(1)**



**\*Disable Bookland EAN  
(0)**



**NOTE:** If you enable Bookland EAN, select a [Bookland ISBN Format](#). Also set [Decode UPC/EAN/JAN Supplementals on page 230](#) to either Decode UPC/EAN/JAN with Supplementals Only, Autodiscriminate UPC/EAN/JAN With Supplementals, or Enable 978/979 Supplemental Mode.

## Bookland ISBN Format

### Parameter # 576

### SSI # F1h 40h

If you enabled Bookland EAN using [Bookland EAN on page 227](#), select one of the following formats for Bookland data:

- **Bookland ISBN-10** - The scanner reports Bookland data starting with 978 in traditional 10-digit format with the special Bookland check digit for backward-compatibility. Data starting with 979 is not considered Bookland in this mode.
- **Bookland ISBN-13** - The scanner reports Bookland data (starting with either 978 or 979) as EAN-13 in 13-digit format to meet the 2007 ISBN-13 protocol.



\*Bookland ISBN-10  
(0)



Bookland ISBN-13  
(1)



**NOTE:** For Bookland EAN to function properly, first enable Bookland EAN using [Bookland EAN on page 227](#), and then set [Decode UPC/EAN/JAN Supplementals on page 230](#) to either Decode UPC/EAN/JAN with Supplementals Only, Autodiscriminate UPC/EAN/JAN With Supplementals, or Enable 978/979 Supplemental Mode.



## ISSN EAN

Parameter # 617

SSI # F1h 69h

Scan one of the following barcodes to enable or disable ISSN EAN.



Enable ISSN EAN  
(1)

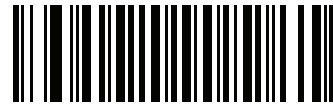

\*Disable ISSN EAN  
(0)

## Decode UPC/EAN/JAN Supplementals

### Parameter # 16

### SSI # 10h

Supplementals are barcodes appended according to specific format conventions (e.g., UPC A+2, UPC E+2, EAN 13+2). The following options are available:

- **Decode UPC/EAN/JAN with Supplementals Only** - The scanner only decodes UPC/EAN/JAN symbols with supplemental characters, and ignores symbols without supplementals.
- **Ignore UPC/EAN/JAN Supplementals** - When presented with a UPC/EAN/JAN plus supplemental symbol, the scanner decodes UPC/EAN/JAN and ignores the supplemental characters.
- **Autodiscriminate UPC/EAN/JAN with Supplementals** - The scanner decodes UPC/EAN/JAN symbols with supplemental characters immediately. If the symbol does not have a supplemental, the scanner must decode the barcode the number of times set via [UPC/EAN/JAN Supplemental Redundancy on page 233](#) before transmitting its data to confirm that there is no supplemental.

Select one of the following **Supplemental Mode** options to immediately transmit EAN-13 barcodes starting with that prefix that have supplemental characters. If the symbol does not have a supplemental, the scanner must decode the barcode the number of times set via [UPC/EAN/JAN Supplemental Redundancy on page 233](#) before transmitting the data to confirm that there is no supplemental. The scanner transmits UPC/EAN/JAN barcodes that do not have that prefix immediately.

- **Enable 378/379 Supplemental Mode**
- **Enable 978/979 Supplemental Mode**



**NOTE:** If you select 978/979 Supplemental Mode and are scanning Bookland EAN barcodes, see [Bookland EAN on page 227](#) to enable Bookland EAN, and select a format using [Bookland ISBN Format on page 228](#).

- **Enable 977 Supplemental Mode**
- **Enable 414/419/434/439 Supplemental Mode**
- **Enable 491 Supplemental Mode**
- **Enable Smart Supplemental Mode** - This applies to EAN-13 barcodes starting with any prefix listed previously.
- **Supplemental User-Programmable Type 1** - This applies to EAN-13 barcodes starting with a 3-digit user-defined prefix. Set this using [User-Programmable Supplementals on page 233](#).
- **Supplemental User-Programmable Type 1 and 2** - This applies to EAN-13 barcodes starting with either of two 3-digit user-defined prefixes. Set the prefixes using [User-Programmable Supplementals on page 233](#).
- **Smart Supplemental Plus User-Programmable 1** - This applies to EAN-13 barcodes starting with any prefix listed previously or the prefix set using [User-Programmable Supplementals on page 233](#).
- **Smart Supplemental Plus User-Programmable 1 and 2** - This applies to EAN-13 barcodes starting with any prefix listed previously or one of the two user-defined prefixes set using [User-Programmable Supplementals on page 233](#).



**NOTE:** To minimize the risk of invalid data transmission, select either to decode or ignore supplemental characters.

## Decode UPC/EAN/JAN Supplementals (continued)

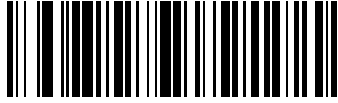

**Decode UPC/EAN/JAN With Supplementals Only  
(1)**



**\*Ignore UPC/EAN/JAN Supplementals  
(0)**

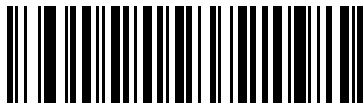

**Autodiscriminate UPC/EAN/JAN with  
Supplementals  
(2)**



**Enable 378/379 Supplemental Mode  
(4)**



**Enable 978/979 Supplemental Mode  
(5)**



**Enable 977 Supplemental Mode  
(7)**

## Decode UPC/EAN/JAN Supplementals (continued)



Enable 414/419/434/439 Supplemental Mode  
(6)



Enable 491 Supplemental Mode  
(8)



Enable Smart Supplemental Mode  
(3)



Supplemental User-Programmable Type 1  
(9)



Supplemental User-Programmable Type 1 and 2  
(10)



Smart Supplemental Plus User-Programmable 1  
(11)



Smart Supplemental Plus  
User-Programmable 1 and 2  
(12)

## User-Programmable Supplementals

### Supplemental 1: Parameter # 579

SSI # F4h F1h 43h

### Supplemental 2: Parameter # 580

SSI # F4h F1h 44h

If you selected a Supplemental User-Programmable option from [Decode UPC/EAN/JAN Supplementals on page 230](#), scan **User-Programmable Supplemental 1**, and then scan three barcodes from [Numeric Barcodes](#) to set the 3-digit prefix. To set a second 3-digit prefix, scan **User-Programmable Supplemental 2**, and then scan three barcodes from [Numeric Barcodes](#). The default is 000 (zeroes).



User-Programmable Supplemental 1



User-Programmable Supplemental 2

## UPC/EAN/JAN Supplemental Redundancy

### Parameter # 80

SSI # 50h

If you selected **Autodiscriminate UPC/EAN/JAN with Supplementals**, this option sets the number of times to decode a symbol without supplementals before transmission. The range is from two to 30. Five or above is recommended when decoding a mix of UPC/EAN/JAN symbols with and without supplementals. The default is 10.

To set a redundancy value, scan the following barcode, and then scan two barcodes from [Numeric Barcodes](#). Enter a leading zero for single digit numbers. To correct an error or change a selection, scan [Cancel on page 457](#).



UPC/EAN/JAN Supplemental Redundancy

## UPC/EAN/JAN Supplemental AIM ID Format

### Parameter # 672

### SSI # F1h A0h

If [Transmit Code ID Character on page 180](#) is set to **AIM Code ID Character**, scan one of the following barcodes to select an output format when reporting UPC/EAN/JAN barcodes with supplementals:

- **Separate** - Transmit UPC/EAN/JAN with supplementals with separate AIM IDs but one transmission, i.e.,  
]E<0 or 4><data>]E<1 or 2>[supplemental data]
- **Combined** – Transmit UPC/EAN/JAN with supplementals with one AIM ID and one transmission, i.e.,  
]E3<data+supplemental data>
- **Separate Transmissions** - Transmit UPC/EAN/JAN with supplementals with separate AIM IDs and separate transmissions, i.e.,

]E<0 or 4><data>

]E<1 or 2>[supplemental data]



**Separate  
(0)**



**\*Combined  
(1)**



**Separate Transmissions  
(2)**

## Transmit UPC-A Check Digit

Parameter # 40

SSI # 28h

The check digit is the last character of the symbol used to verify the integrity of the data. Scan one of the following barcodes to transmit the barcode data with or without the UPC-A check digit. It is always verified to guarantee the integrity of the data.

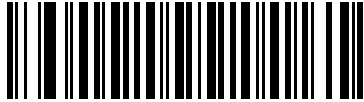

**\*Transmit UPC-A Check Digit  
(1)**

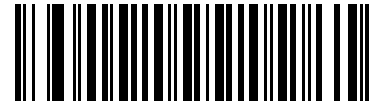

**Do Not Transmit UPC-A Check Digit  
(0)**

## Transmit UPC-E Check Digit

Parameter # 41

SSI # 29h

The check digit is the last character of the symbol used to verify the integrity of the data. Scan one of the following barcodes to transmit the barcode data with or without the UPC-E check digit. It is always verified to guarantee the integrity of the data.

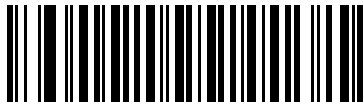

**\*Transmit UPC-E Check Digit  
(1)**



**Do Not Transmit UPC-E Check Digit  
(0)**

## Transmit UPC-E1 Check Digit

**Parameter # 42**

**SSI # 2Ah**

The check digit is the last character of the symbol used to verify the integrity of the data. Scan one of the following barcodes to transmit the barcode data with or without the UPC-E1 check digit. It is always verified to guarantee the integrity of the data.

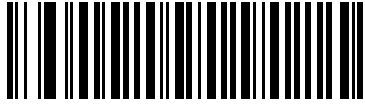

**\*Transmit UPC-E1 Check Digit  
(1)**



**Do Not Transmit UPC-E1 Check Digit  
(0)**



## UPC-A Preamble

### Parameter # 34

### SSI # 22h

Preamble characters are part of the UPC symbol, and include Country Code and System Character. Select the appropriate option for transmitting a UPC-A preamble to match the host system:

- Transmit System Character only
- Transmit System Character and Country Code ("0" for USA)
- Transmit no preamble.

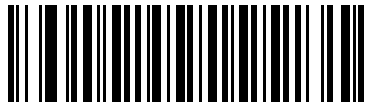

**No Preamble (<DATA>)**  
(0)

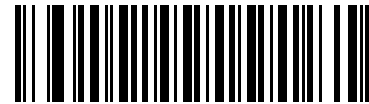

**\*System Character**  
**(<SYSTEM CHARACTER> <DATA>)**  
(1)

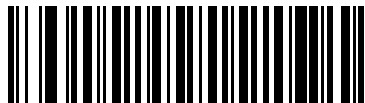

**System Character & Country Code**  
**(< COUNTRY CODE> <SYSTEM CHARACTER> <DATA>)**  
(2)

## UPC-E Preamble

### Parameter # 35

### SSI # 23h

Preamble characters are part of the UPC symbol, and include Country Code and System Character. Select the appropriate option for transmitting a UPC-E preamble to match the host system:

- Transmit System Character only
- Transmit System Character and Country Code ("0" for USA)
- Transmit no preamble.

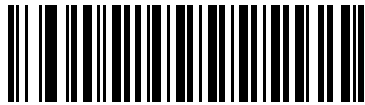

**No Preamble (<DATA>)**  
(0)

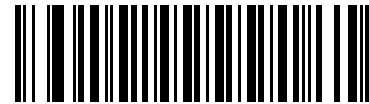

**\*System Character**  
**(<SYSTEM CHARACTER> <DATA>)**  
(1)

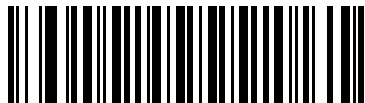

**System Character & Country Code**  
**(<COUNTRY CODE> <SYSTEM CHARACTER> <DATA>)**  
(2)

**UPC-E1 Preamble****Parameter # 36****SSI # 24h**

Preamble characters are part of the UPC symbol, and include Country Code and System Character. Select the appropriate option for transmitting a UPC-E1 preamble to match the host system:

- Transmit System Character only
- Transmit System Character and Country Code ("0" for USA)
- Transmit no preamble.

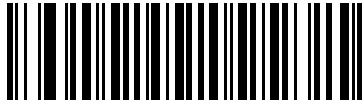

**No Preamble (<DATA>)**  
(0)

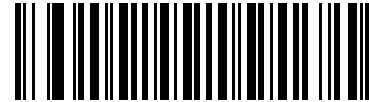

**\*System Character**  
**(<SYSTEM CHARACTER> <DATA>)**  
(1)

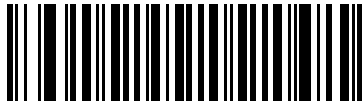

**System Character & Country Code**  
**(<COUNTRY CODE> <SYSTEM CHARACTER> <DATA>)**  
(2)

**Convert UPC-E to UPC-A****Parameter # 37****SSI # 25h**

Enable this to convert UPC-E (zero suppressed) decoded data to UPC-A format before transmission. After conversion, the data follows UPC-A format and is affected by UPC-A programming selections (e.g., Preamble, Check Digit).

Disable this to transmit UPC-E decoded data as UPC-E data, without conversion.

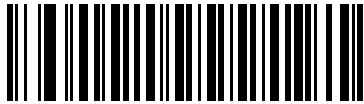

**Convert UPC-E to UPC-A (Enable)**  
(1)

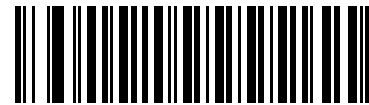

**\*Do Not Convert UPC-E to UPC-A (Disable)**  
(0)

**Convert UPC-E1 to UPC-A****Parameter # 38****SSI # 26h**

Scan **Convert UPC-E1 to UPC-A (Enable)** to convert UPC-E1 decoded data to UPC-A format before transmission. After conversion, the data follows UPC-A format and is affected by UPC-A programming selections (e.g., Preamble, Check Digit).

Scan **Do Not Convert UPC-E1 to UPC-A (Disable)** to transmit UPC-E1 decoded data as UPC-E1 data, without conversion.

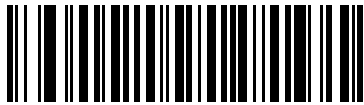

**Convert UPC-E1 to UPC-A (Enable)**  
(1)

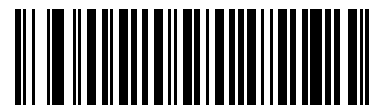

**\*Do Not Convert UPC-E1 to UPC-A (Disable)**  
(0)

## EAN/JAN Zero Extend

### Parameter # 39

### SSI # 27h

Scan **Enable EAN/JAN Zero Extend** to add five leading zeros to decoded EAN-8 symbols to make them compatible in length to EAN-13 symbols. Scan **Disable EAN/JAN Zero Extend** to transmit EAN-8 symbols as is.



Enable EAN/JAN Zero Extend  
(1)

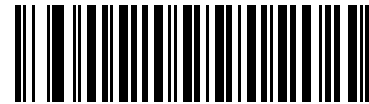

\*Disable EAN/JAN Zero Extend  
(0)

## UCC Coupon Extended Code

### Parameter # 85

### SSI # 55h

Scan **Enable UCC Coupon Extended Code** to decode UPC-A barcodes starting with digit '5', EAN-13 barcodes starting with digit '99', and UPC-A/GS1-128 coupon codes. UPC-A, EAN-13, and GS1-128 must be enabled to use this feature.

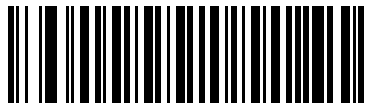

Enable UCC Coupon Extended Code  
(1)

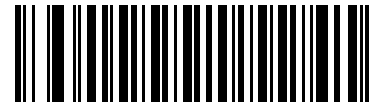

\*Disable UCC Coupon Extended Code  
(0)



**NOTE:** See [UPC/EAN/JAN Supplemental Redundancy on page 233](#) to control autodiscrimination of the GS1-128 portion (right half) of a coupon code.

## Coupon Report

### Parameter # 730

### SSI # F1h DAh

Scan one of the following barcodes to select the type of coupon format to support.

- **Old Coupon Format** - Support UPC-A/GS1-128 and EAN-13/GS1-128.
- **New Coupon Format** - An interim format to support UPC-A/GS1-DataBar and EAN-13/GS1-DataBar.
- **Autodiscriminate Format** - Support both **Old Coupon Format** and **New Coupon Format**.



**Old Coupon Format  
(0)**

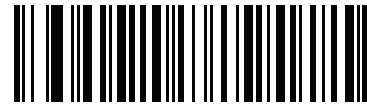

**\*New Coupon Format  
(1)**



**Autodiscriminate Coupon Format  
(2)**

## UPC Reduced Quiet Zone

Parameter # 1289

SSI # F8h 05h 09h

Scan one of the following barcodes to enable or disable decoding UPC barcodes with reduced quiet zones (the margins on either side of the barcode). If you select **Enable**, select a [1D Quiet Zone Level on page 297](#).



Enable UPC Reduced Quiet Zone  
(1)

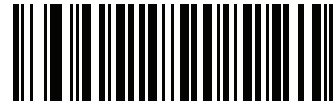

\*Disable UPC Reduced Quiet Zone  
(0)

---

## Code 128

Parameter # 8

SSI # 08h

Scan one of the following barcodes to enable or disable Code 128.

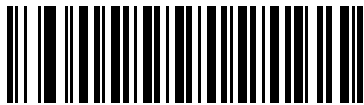

\*Enable Code 128  
(1)



Disable Code 128  
(0)

## Set Lengths for Code 128

**L1 = Parameter # 209**

**SSI # D1h**

**L2 = Parameter # 210**

**SSI # D2h**

The length of a code refers to the number of characters (i.e., human readable characters), including check digit(s) the code contains. Set lengths for Code 128 to any length, one or two discrete lengths, or lengths within a specific range. The maximum range is 128. The default is **Any Length**.



**NOTE:** When setting lengths, enter a leading zero for single digit numbers.

Scan one of the following barcodes to select a length option:

- **One Discrete Length** - Decode only Code 128 symbols containing a selected length. Select the length using the barcodes in [Numeric Barcodes](#). For example, to decode only Code 128 symbols with 14 characters, scan **Code 128 - One Discrete Length**, and then scan **1, 4**. To correct an error or change the selection, scan [Cancel on page 457](#).
- **Two Discrete Lengths** - Decode only Code 128 symbols containing either of two lengths. Select lengths using the barcodes in [Numeric Barcodes](#). For example, to decode only Code 128 symbols containing either 2 or 14 characters, scan **Code 128 - Two Discrete Lengths**, and then scan **0, 2, 1, 4**. To correct an error or change the selection, scan [Cancel on page 457](#).
- **Length Within Range** - Decode Code 128 symbols with a specific length range. Select lengths using the barcodes in [Numeric Barcodes](#). For example, to decode Code 128 symbols containing between 4 and 12 characters, scan **Code 128 - Length Within Range**, and then scan **0, 4, 1, 2**. To correct an error or change the selection, scan [Cancel on page 457](#).
- **Any Length** - Decode Code 128 symbols containing any number of characters within the scanner's capability.

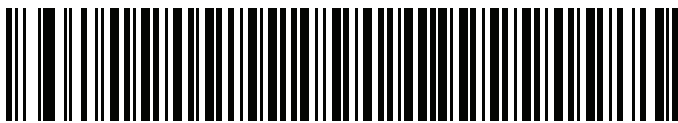

**Code 128 - One Discrete Length**

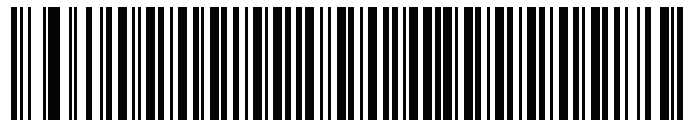

**Code 128 - Two Discrete Lengths**



### Set Lengths for Code 128 (continued)

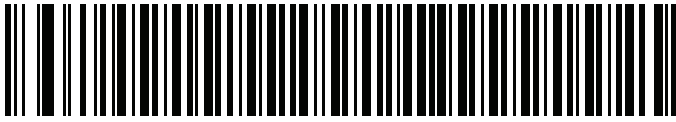

Code 128 - Length Within Range

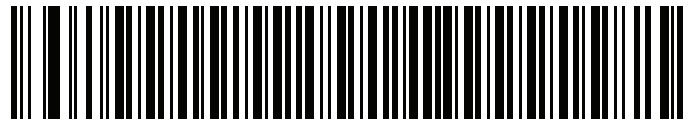

\*Code 128 - Any Length

### GS1-128 (formerly UCC/EAN-128)

Parameter # 14

SSI # 0Eh

Scan one of the following barcodes to enable or disable GS1-128.

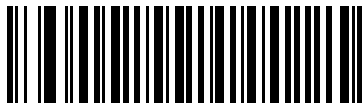

\*Enable GS1-128  
(1)

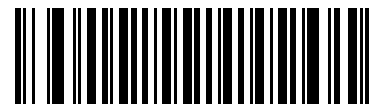

Disable GS1-128  
(0)

## ISBT 128

### Parameter # 84

### SSI # 54h

ISBT 128 is a variant of Code 128 used in the blood bank industry. Scan one of the following barcodes to enable or disable ISBT 128.



**\*Enable ISBT 128  
(1)**



**Disable ISBT 128  
(0)**

## ISBT Concatenation

### Parameter # 577

### SSI # F1h 41h

Select an option for concatenating pairs of ISBT code types:

- **Enable ISBT Concatenation** - There must be two ISBT codes in order for the scanner to decode and perform concatenation. The scanner does not decode single ISBT symbols.
- **Disable ISBT Concatenation** - The scanner does not concatenate pairs of ISBT codes it encounters.
- **Autodiscriminate ISBT Concatenation** - The scanner decodes and concatenates pairs of ISBT codes immediately. If only a single ISBT symbol is present, the scanner must decode the symbol the number of times set via [ISBT Concatenation Redundancy on page 248](#) before transmitting its data to confirm that there is no additional ISBT symbol. For ISBT AutoDetect to operate as expected, both barcodes must be in the field of view simultaneously. This may be difficult to achieve in presentation mode.



**NOTE:** For ISBT AutoDetect to operate as expected, both barcodes must be in the field of view simultaneously. This may be difficult to achieve in presentation mode.



**NOTE:** When enabling ISBT Concatenation or Autodiscriminate ISBT Concatenation set Code 128 Security Level to Level 2.



**\*Enable ISBT Concatenation  
(1)  
(Default for DS4608-HC only)**

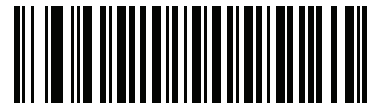

**\*Disable ISBT Concatenation  
(0)**

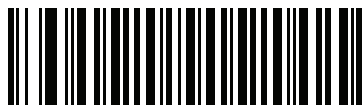

**Autodiscriminate ISBT Concatenation  
(2)**

## Check ISBT Table

### Parameter # 578

#### SSI # F1h 42h

The ISBT specification includes a table that lists several types of ISBT barcodes that are commonly used in pairs. If you set **ISBT Concatenation** to **Enable**, enable **Check ISBT Table** to concatenate only those pairs found in this table. Other types of ISBT codes are not concatenated.



\*Enable Check ISBT Table  
(1)

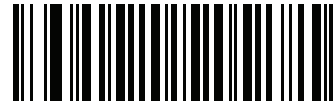

Disable Check ISBT Table  
(0)

## ISBT Concatenation Redundancy

### Parameter # 223

#### SSI # DFh

If you set [ISBT Concatenation on page 247](#) to **Autodiscriminate** (the default), use this parameter to set the number of times the scanner must decode an ISBT symbol before determining that there is no additional symbol.

Scan the following barcode, and then scan barcodes in [Numeric Barcodes](#) to set a value between 2 and 20. Enter a leading zero for single digit numbers. To correct an error or change a selection, scan [Cancel on page 457](#). The default is 10.



ISBT Concatenation Redundancy

**Code 128 <FNC4>****Parameter # 1254****SSI # F8h 04h E6h**

This feature applies to Code 128 barcodes with an embedded <FNC4> character. Select **Ignore Code 128 <FNC4>** to strip the <FNC4> character from the decode data. The remaining characters are sent to the host unchanged. When disabled, the <FNC4> character is processed normally as per Code 128 standard.



**\*Honor Code 128 <FNC4>**  
**(0)**



**Ignore Code 128 <FNC4>**  
**(1)**

## Code 128 Security Level

### Parameter # 751

### SSI # F1h EFh

Code 128 barcodes are vulnerable to misdecodes, particularly when Code 128 Lengths is set to **Any Length**. The scanner offers four levels of decode security for Code 128 barcodes. There is an inverse relationship between security and scanner aggressiveness. Increasing the level of security can reduce scanning aggressiveness, so select only the level of security necessary.

- **Code 128 Security Level 0** - The scanner operates in its most aggressive state, while providing sufficient security in decoding most in-spec barcodes.
- **Code 128 Security Level 1** - This option eliminates most misdecodes while maintaining reasonable aggressiveness.
- **Code 128 Security Level 2** - This option applies greater barcode security requirements if **Security Level 1** fails to eliminate misdecodes.
- **Code 128 Security Level 3** - If you selected **Security Level 2**, and misdecodes still occur, select this security level to apply the highest safety requirements.



**NOTE:** Selecting this option is an extreme measure against mis-decoding severely out-of-spec barcodes, and significantly impairs the decoding ability of the scanner. If this level of security is required, try to improve the quality of the barcodes.

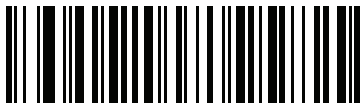

**Code 128 Security Level 0**  
(0)



**\*Code 128 Security Level 1**  
(1)

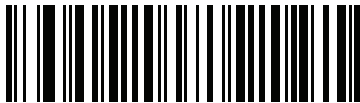

**\*Code 128 Security Level 2**  
(2)  
(Default for DS4608-HC only)



**Code 128 Security Level 3**  
(3)

## Code 128 Reduced Quiet Zone

Parameter # 1208

SSI # F8h 04h B8h

Scan one of the following barcodes to enable or disable decoding Code 128 barcodes with reduced quiet zones (the margins on either side of the barcode). If you select **Enable**, select a [1D Quiet Zone Level on page 297](#).



Enable Code 128 Reduced Quiet Zone  
(1)



\*Disable Code 128 Reduced Quiet Zone  
(0)

---

## Code 39

Parameter # 0

SSI # 00h

Scan one of the following barcodes to enable or disable Code 39.

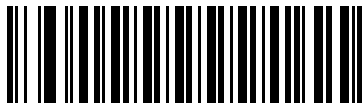

\*Enable Code 39  
(1)



Disable Code 39  
(0)

## Trioptic Code 39

### Parameter # 13

#### SSI # 0Dh

Trioptic Code 39 is a variant of Code 39 used in the marking of computer tape cartridges. Trioptic Code 39 symbols always contain six characters. Scan one of the following barcodes to enable or disable Trioptic Code 39.

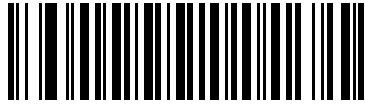

Enable Trioptic Code 39  
(1)

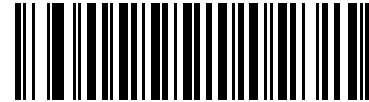

\*Disable Trioptic Code 39  
(0)



**NOTE:** You cannot enable Trioptic Code 39 and Code 39 Full ASCII simultaneously.

## Convert Code 39 to Code 32

### Parameter # 86

#### SSI # 56h

Code 32 is a variant of Code 39 used by the Italian pharmaceutical industry. Scan one of the following barcodes to enable or disable converting Code 39 to Code 32.



**NOTE:** Code 39 must be enabled for this parameter to function.

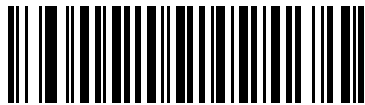

Enable Convert Code 39 to Code 32  
(1)

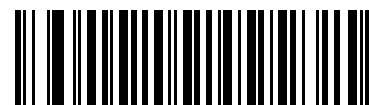

\*Disable Convert Code 39 to Code 32  
(0)



## Code 32 Prefix

### Parameter # 231

### SSI # E7h

Scan one of the following barcodes to enable or disable adding the prefix character “A” to all Code 32 barcodes.



**NOTE:** Convert Code 39 to Code 32 must be enabled for this parameter to function.

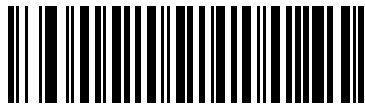

Enable Code 32 Prefix  
(1)

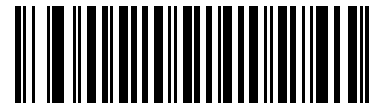

\*Disable Code 32 Prefix  
(0)

## Set Lengths for Code 39

### L1 = Parameter # 18

### SSI # 12h

### L2 = Parameter # 19

### SSI # 13h

The length of a code refers to the number of characters (i.e., human readable characters), including check digit(s) the code contains. Set lengths for Code 39 to any length, one or two discrete lengths, or lengths within a specific range. If Code 39 Full ASCII is enabled, **Length Within Range** or **Any Length** are the preferred options. The maximum range is 80. The default is **Length Within Range: 1 to 55**.



**NOTE:** When setting lengths, enter a leading zero for single digit numbers.

Scan one of the following barcodes to select a length option:

- **One Discrete Length** - Decode only Code 39 symbols containing a selected length. Select the length using the barcodes in [Numeric Barcodes](#). For example, to decode only Code 39 symbols with 14 characters, scan **Code 39 - One Discrete Length**, and then scan **1, 4**. To correct an error or change the selection, scan [Cancel on page 457](#).
- **Two Discrete Lengths** - Decode only Code 39 symbols containing either of two lengths. Select lengths using the barcodes in [Numeric Barcodes](#). For example, to decode only Code 39 symbols

containing either 2 or 14 characters, scan **Code 39 - Two Discrete Lengths**, and then scan **0, 2, 1, 4**. To correct an error or change the selection, scan [Cancel on page 457](#).

- **Length Within Range** - Decode Code 39 symbols with a specific length range. Select lengths using the barcodes in [Numeric Barcodes](#). For example, to decode Code 39 symbols containing between 4 and 12 characters, scan **Code 39 - Length Within Range**, and then scan **0, 4, 1, 2**. To correct an error or change the selection, scan [Cancel on page 457](#).
- **Any Length** - Decode Code 39 symbols containing any number of characters within the scanner's capability.



**Code 39 - One Discrete Length**



**Code 39 - Two Discrete Lengths**



**\*Code 39 - Length Within Range**  
(Default: 1 to 55)



**Code 39 - Any Length**

## Code 39 Check Digit Verification

### Parameter # 48

#### SSI # 30h

Scan **Enable Code 39 Check Digit** to check the integrity of all Code 39 symbols to verify that the data complies with specified check digit algorithm. Only Code 39 symbols which include a modulo 43 check digit are decoded. Enable this feature if the Code 39 symbols contain a Modulo 43 check digit.

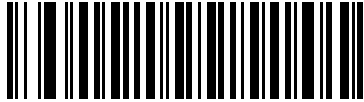

**Enable Code 39 Check Digit  
(1)**

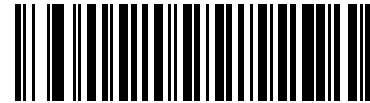

**\*Disable Code 39 Check Digit  
(0)**

## Transmit Code 39 Check Digit

### Parameter # 43

#### SSI # 2Bh

Scan one of the following barcodes to transmit Code 39 data with or without the check digit.

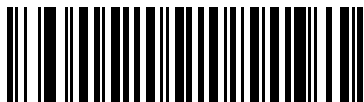

**Transmit Code 39 Check Digit (Enable)  
(1)**



**\*Do Not Transmit Code 39 Check Digit (Disable)  
(0)**



**NOTE:** [Code 39 Check Digit Verification](#) must be enabled for this parameter to function.

## Code 39 Full ASCII Conversion

### Parameter # 17

### SSI # 11h

Code 39 Full ASCII is a variant of Code 39 which pairs characters to encode the full ASCII character set. Scan one of the following barcodes to enable or disable Code 39 Full ASCII.



**Enable Code 39 Full ASCII  
(1)**

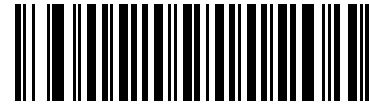

**\*Disable Code 39 Full ASCII  
(0)**



**NOTES** 1 You cannot enable Trioptic Code 39 and Code 39 Full ASCII simultaneously.

2. Code 39 Full ASCII to Full ASCII Correlation is host-dependent, and is therefore described in the ASCII character set table for the appropriate interface. See [Table 38 on page 476](#).

## Code 39 Security Level

### Parameter # 750

#### SSI # F1h EEh

The scanner offers four levels of decode security for Code 39 barcodes. There is an inverse relationship between security and scanner aggressiveness. Increasing the level of security can reduce scanning aggressiveness, so select only the level of security necessary.

- **Code 39 Security Level 0:** The scanner operates in its most aggressive state, while providing sufficient security in decoding most in-spec barcodes.
- **Code 39 Security Level 1:** This default setting eliminates most misdecodes.
- **Code 39 Security Level 2:** This option applies greater barcode security requirements if **Security Level 1** fails to eliminate misdecodes.
- **Code 39 Level 3:** If you selected **Security Level 2**, and misdecodes still occur, select this security level to apply the highest safety requirements.



**NOTE:** Selecting this option is an extreme measure against mis-decoding severely out-of-spec barcodes, and significantly impairs the decoding ability of the scanner. If this level of security is required, try to improve the quality of the barcodes

## Code 39 Security Level (continued)



**Code 39 Security Level 0  
(0)**



**\*Code 39 Security Level 1  
(1)**

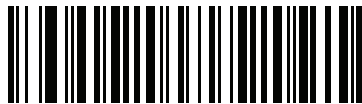

**Code 39 Security Level 2  
(2)**



**Code 39 Security Level 3  
(3)**

## Code 39 Reduced Quiet Zone

Parameter # 1209

SSI # F8h 04h B9h

Scan one of the following barcodes to enable or disable decoding Code 39 barcodes with reduced quiet zones (the margins on either side of the barcode). If you select **Enable**, select a [1D Quiet Zone Level on page 297](#).



Enable Code 39 Reduced Quiet Zone  
(1)

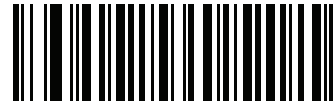

\*Disable Code 39 Reduced Quiet Zone  
(0)

---

## Code 93

Parameter # 9

SSI # 09h

Scan one of the following barcodes to enable or disable Code 93.

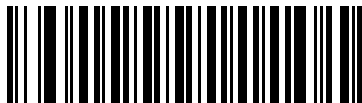

\*Enable Code 93  
(1)



Disable Code 93  
(0)

## Set Lengths for Code 93

**L1 = Parameter # 26**

**SSI # 1Ah**

**L2 = Parameter # 27**

**SSI # 1Bh**

The length of a code refers to the number of characters (i.e., human readable characters), including check digit(s) the code contains. Set lengths for Code 93 to any length, one or two discrete lengths, or lengths within a specific range. The maximum range is 80. The default is **Length Within Range: 1 to 55**.



**NOTE:** When setting lengths, enter a leading zero for single digit numbers.

Scan one of the following barcodes to select a length option:

- **One Discrete Length** - Decode only Code 93 symbols containing a selected length. Select the length using the barcodes in [Numeric Barcodes](#). For example, to decode only Code 93 symbols with 14 characters, scan **Code 93 - One Discrete Length**, and then scan **1, 4**. To correct an error or change the selection, scan [Cancel on page 457](#).
- **Two Discrete Lengths** - Decode only Code 93 symbols containing either of two lengths. Select lengths using the barcodes in [Numeric Barcodes](#). For example, to decode only Code 93 symbols containing either 2 or 14 characters, scan **Code 93 - Two Discrete Lengths**, and then scan **0, 2, 1, 4**. To correct an error or change the selection, scan [Cancel on page 457](#).
- **Length Within Range** - Decode Code 93 symbols with a specific length range. Select lengths using the barcodes in [Numeric Barcodes](#). For example, to decode Code 93 symbols containing between 4 and 12 characters, scan **Code 93 - Length Within Range**, and then scan **0, 4, 1, 2**. To correct an error or change the selection, scan [Cancel on page 457](#).
- **Any Length** - Decode Code 93 symbols containing any number of characters within the scanner's capability.



## Set Lengths for Code 93 (continued)



**Code 93 - One Discrete Length**



**Code 93 - Two Discrete Lengths**



**\*Code 93 - Length Within Range  
(Default: 1 to 55)**



**Code 93 - Any Length**

## Code 11

### Parameter # 10

### SSI # 0Ah

Scan one of the following barcodes to enable or disable Code 11

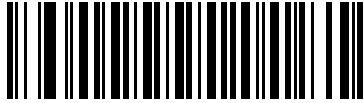

**Enable Code 11**  
(1)

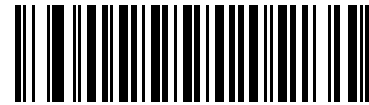

**\*Disable Code 11**  
(0)

## Set Lengths for Code 11

### L1 = Parameter # 28

### SSI # 1Ch

### L2 = Parameter # 29

### SSI # 1Dh

The length of a code refers to the number of characters (i.e., human readable characters), including check digit(s) the code contains. Set lengths for Code 11 to any length, one or two discrete lengths, or lengths within a specific range. The maximum range is 80. The default is **Length Within Range: 4 to 55**.



**NOTE:** When setting lengths, enter a leading zero for single digit numbers.

Scan one of the following barcodes to select a length option:

- **One Discrete Length** - Decode only Code 11 symbols containing a selected length. Select the length using the barcodes in [Numeric Barcodes](#). For example, to decode only Code 11 symbols with 14 characters, scan **Code 11 - One Discrete Length**, and then scan **1, 4**. To correct an error or change the selection, scan [Cancel on page 457](#).
- **Two Discrete Lengths** - Decode only Code 11 symbols containing either of two lengths. Select lengths using the barcodes in [Numeric Barcodes](#). For example, to decode only Code 11 symbols containing either 2 or 14 characters, scan **Code 11 - Two Discrete Lengths**, and then scan **0, 2, 1, 4**. To correct an error or change the selection, scan [Cancel on page 457](#).
- **Length Within Range** - Decode Code 11 symbols with a specific length range. Select lengths using the barcodes in [Numeric Barcodes](#). For example, to decode Code 11 symbols containing between 4 and 12 characters, scan **Code 11 - Length Within Range**, and then scan **0, 4, 1, 2**. To correct an error or change the selection, scan [Cancel on page 457](#).
- **Any Length** - Decode Code 11 symbols containing any number of characters within the scanner's capability.

## Set Lengths for Code 11 (continued)



**Code 11 - One Discrete Length**



**Code 11 - Two Discrete Lengths**



**\*Code 11 - Length Within Range  
(Default: 4 to 55)**



**Code 11 - Any Length**

## Code 11 Check Digit Verification

### Parameter # 52

### SSI # 34h

This feature allows the scanner to check the integrity of all Code 11 symbols to verify that the data complies with the specified check digit algorithm.

Scan one of the following barcodes to specify the number of check digits encoded in the Code 11 symbols, or to disable this feature.

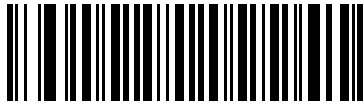

**\*Disable  
(0)**



**One Check Digit  
(1)**

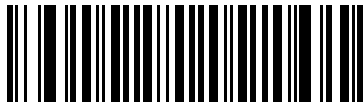

**Two Check Digits  
(2)**

## Transmit Code 11 Check Digits

Parameter # 47

SSI # 2Fh

Scan one of the following barcodes to select whether or not to transmit the Code 11 check digit(s).

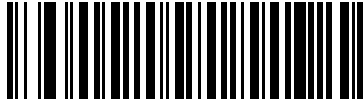

Transmit Code 11 Check Digit(s) (Enable)  
(1)

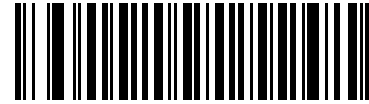

\*Do Not Transmit Code 11 Check Digit(s) (Disable)  
(0)



**NOTE:** [Code 11 Check Digit Verification](#) must be enabled for this parameter to function.

---

## Interleaved 2 of 5 (ITF)

Parameter # 6

SSI # 06h

Scan one of the following barcodes to enable or disable Interleaved 2 of 5.



\*Enable Interleaved 2 of 5  
(1)



Disable Interleaved 2 of 5  
(0)

## Set Lengths for Interleaved 2 of 5

**L1 = Parameter # 22**

**SSI # 16h**

**L2 = Parameter # 23**

**SSI # 17h**

The length of a code refers to the number of characters (i.e., human readable characters), including check digit(s) the code contains. Set lengths for I 2 of 5 to any length, one or two discrete lengths, or lengths within a specific range. The maximum range is 80. The default is **Length Within Range: 6 to 55**.



**NOTE:** When setting lengths, enter a leading zero for single digit numbers.

Scan one of the following barcodes to select a length option:

- **One Discrete Length** - Decode only I 2 of 5 symbols containing a selected length. Select the length using the barcodes in [Numeric Barcodes](#). For example, to decode only I 2 of 5 symbols with 14 characters, scan **I 2 of 5 - One Discrete Length**, and then scan **1, 4**. To correct an error or change the selection, scan [Cancel on page 457](#).
- **Two Discrete Lengths** - Decode only I 2 of 5 symbols containing either of two lengths. Select lengths using the barcodes in [Numeric Barcodes](#). For example, to decode only I 2 of 5 symbols containing either 2 or 14 characters, scan **I 2 of 5 - Two Discrete Lengths**, and then scan **0, 2, 1, 4**. To correct an error or change the selection, scan [Cancel on page 457](#).
- **Length Within Range** - Decode I 2 of 5 symbols with a specific length range. Select lengths using the barcodes in [Numeric Barcodes](#). For example, to decode I 2 of 5 symbols containing between 4 and 12 characters, scan **I 2 of 5 - Length Within Range**, and then scan **0, 4, 1, 2**. To correct an error or change the selection, scan [Cancel on page 457](#).

## Set Lengths for Interleaved 2 of 5 (continued)

- **Any Length** - Decode 1 2 of 5 symbols containing any number of characters within the scanner's capability.



**NOTE:** Due to the construction of the 1 2 of 5 symbology, it is possible for a scan line covering only a portion of the code to transmit as a complete scan, yielding less data than is encoded in the barcode. To prevent this, select specific lengths (1 2 of 5 - One Discrete Length, Two Discrete Lengths) for 1 2 of 5 applications, or increase the [1 2 of 5 Security Level on page 270](#).



**1 2 of 5 - One Discrete Length**



**1 2 of 5 - Two Discrete Lengths**



**\*1 2 of 5 - Length Within Range  
(Default: 6 to 55)**



**1 2 of 5 - Any Length**

## I 2 of 5 Check Digit Verification

### Parameter # 49

#### SSI # 31h

Scan one of the following barcodes to check the integrity of all I 2 of 5 symbols to verify the data complies with either the specified Uniform Symbology Specification (USS), or the Optical Product Code Council (OPCC) check digit algorithm.



**\*Disable  
(0)**



**USS Check Digit  
(1)**



**OPCC Check Digit  
(2)**

## Transmit I 2 of 5 Check Digit

### Parameter # 44

#### SSI # 2Ch

Scan one of the following barcodes to transmit I 2 of 5 data with or without the check digit.



**Transmit I 2 of 5 Check Digit (Enable)  
(1)**

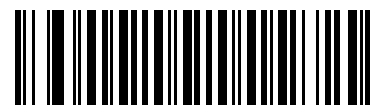

**\*Do Not Transmit I 2 of 5 Check Digit (Disable)  
(0)**



## Convert I 2 of 5 to EAN-13

### Parameter # 82

### SSI # 52h

Scan **Convert I 2 of 5 to EAN-13 (Enable)** to convert 14-character I 2 of 5 codes to EAN-13, and transmit to the host as EAN-13. To accomplish this, the I 2 of 5 code must be enabled, and the code must have a leading zero and a valid EAN-13 check digit.

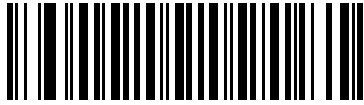

Convert I 2 of 5 to EAN-13 (Enable)  
(1)

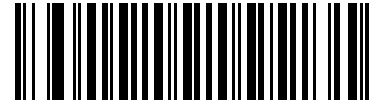

\*Do Not Convert I 2 of 5 to EAN-13 (Disable)  
(0)

## Febraban

### Parameter # 1750

### SSI # F8h 06h D6h

Febraban is an Interleaved 2 of 5 barcode of length 44 that requires inserting special check characters in the transmitted data stream. Enabling this disables the I 2 of 5 internal check digit calculation and transmission.

Recommendations for length settings:

- **Interleaved 2 of 5 Length 1:** Larger of the fixed length and the Febraban length (==44).
- **Interleaved 2 of 5 Length 2:** Smaller of the fixed length and the Febraban length (==44).



Enable Febraban  
(1)



\*Disable Febraban  
(0)

## I 2 of 5 Security Level

### Parameter # 1121

### SSI # F8h 04h 61h

Interleaved 2 of 5 barcodes are vulnerable to misdecodes, particularly when I 2 of 5 Lengths is set to **Any Length**. The scanner offers four levels of decode security for Interleaved 2 of 5 barcodes. There is an inverse relationship between security and scanner aggressiveness. Increasing the level of security can reduce scanning aggressiveness, so select only the level of security necessary.

- **I 2 of 5 Security Level 0:** The scanner operates in its most aggressive state, while providing sufficient security in decoding most in-spec barcodes.
- **I 2 of 5 Security Level 1:** A barcode must be successfully read twice, and satisfy certain safety requirements before being decoded. This default setting eliminates most misdecodes.
- **I 2 of 5 Security Level 2:** This option applies greater barcode security requirements if **Security Level 1** fails to eliminate misdecodes.
- **I 2 of 5 Security Level 3:** If you selected **Security Level 2**, and misdecodes still occur, select this security level. The highest safety requirements are applied. A barcode must be successfully read three times before being decoded.



**NOTE:** Selecting this option is an extreme measure against mis-decoding severely out-of-spec barcodes, and significantly impairs the decoding ability of the scanner. If this level of security is required, try to improve the quality of the barcodes.

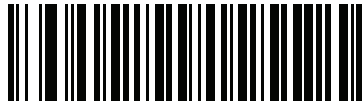

I 2 of 5 Security Level 0  
(0)

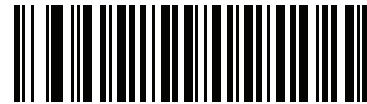

\*I 2 of 5 Security Level 1  
(1)



I 2 of 5 Security Level 2  
(2)



I 2 of 5 Security Level 3  
(3)

## I 2 of 5 Reduced Quiet Zone

Parameter # 1210

SSI # F8h 04h BAh

Scan one of the following barcodes to enable or disable decoding I 2 of 5 barcodes with reduced quiet zones (the margins on either side of the barcode). If you select **Enable**, select a [1D Quiet Zone Level on page 297](#).



Enable I 2 of 5 Reduced Quiet Zone  
(1)

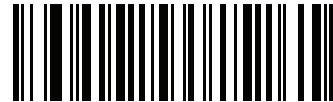

\*Disable I 2 of 5 Reduced Quiet Zone  
(0)

---

## Discrete 2 of 5 (DTF)

Parameter # 5

SSI # 05h

Scan one of the following barcodes to enable or disable Discrete 2 of 5.

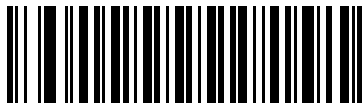

Enable Discrete 2 of 5  
(1)



\*Disable Discrete 2 of 5  
(0)

## Set Lengths for Discrete 2 of 5

**L1 = Parameter # 20**

**SSI # 14h**

**L2 = Parameter # 21**

**SSI # 15h**

The length of a code refers to the number of characters (i.e., human readable characters), including check digit(s) the code contains. Set lengths for D 2 of 5 to any length, one or two discrete lengths, or lengths within a specific range. The maximum range is 55. The default is **Length Within Range: 1 to 55**.



**NOTE:** When setting lengths, enter a leading zero for single digit numbers.

Scan one of the following barcodes to select a length option:

- **One Discrete Length** - Decode only D 2 of 5 symbols containing a selected length. Select the length using the barcodes in [Numeric Barcodes](#). For example, to decode only D 2 of 5 symbols with 14 characters, scan **D 2 of 5 - One Discrete Length**, and then scan **1, 4**. To correct an error or change the selection, scan [Cancel on page 457](#).
- **Two Discrete Lengths** - Decode only D 2 of 5 symbols containing either of two lengths. Select lengths using the barcodes in [Numeric Barcodes](#). For example, to decode only D 2 of 5 symbols containing either 2 or 14 characters, scan **D 2 of 5 - Two Discrete Lengths**, and then scan **0, 2, 1, 4**. To correct an error or change the selection, scan [Cancel on page 457](#).
- **Length Within Range** - Decode D 2 of 5 symbols with a specific length range. Select lengths using the barcodes in [Numeric Barcodes](#). For example, to decode D 2 of 5 symbols containing between 4 and 12 characters, scan **D 2 of 5 - Length Within Range**, and then scan **0, 4, 1, 2**. To correct an error or change the selection, scan [Cancel on page 457](#).

## Set Lengths for Discrete 2 of 5 (continued)

- **Any Length** - Decode D 2 of 5 symbols containing any number of characters within the scanner's capability.



**NOTE:** Due to the construction of the D 2 of 5 symbology, it is possible for a scan line covering only a portion of the code to transmit as a complete scan, yielding less data than is encoded in the barcode. To prevent this, select specific lengths (D 2 of 5 - One Discrete Length, Two Discrete Lengths) for D 2 of 5 applications.



**D 2 of 5 - One Discrete Length**



**D 2 of 5 - Two Discrete Lengths**



**\*D 2 of 5 - Length Within Range  
(Default: 1 to 55)**



**D 2 of 5 - Any Length**

## Codabar (NW - 7)

### Parameter # 7

### SSI # 07h

Scan one of the following barcodes to enable or disable Codabar.

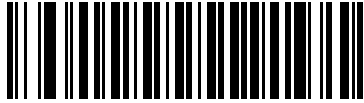

\*Enable Codabar  
(1)

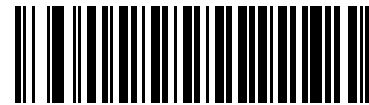

Disable Codabar  
(0)

## Set Lengths for Codabar

### L1 = Parameter # 24

### SSI # 18h

### L2 = Parameter # 25

### SSI # 19h

The length of a code refers to the number of characters (i.e., human readable characters), including check digit(s) the code contains. Set lengths for Codabar to any length, one or two discrete lengths, or lengths within a specific range. The maximum range is 60. The default is **Length Within Range: 4 to 55**.



**NOTE:** When setting lengths, enter a leading zero for single digit numbers.

Scan one of the following barcodes to select a length option:

- **One Discrete Length** - Decode only Codabar symbols containing a selected length. Select the length using the barcodes in [Numeric Barcodes](#). For example, to decode only Codabar symbols with 14 characters, scan **Codabar - One Discrete Length**, and then scan **1, 4**. To correct an error or change the selection, scan [Cancel on page 457](#).
- **Two Discrete Lengths** - Decode only Codabar symbols containing either of two lengths. Select lengths using the barcodes in [Numeric Barcodes](#). For example, to decode only Codabar symbols containing either 2 or 14 characters, scan **Codabar - Two Discrete Lengths**, and then scan **0, 2, 1, 4**. To correct an error or change the selection, scan [Cancel on page 457](#).
- **Length Within Range** - Decode Codabar symbols with a specific length range. Select lengths using the barcodes in [Numeric Barcodes](#). For example, to decode Codabar symbols containing between 4 and 12 characters, scan **Codabar - Length Within Range**, and then scan **0, 4, 1, 2**. To correct an error or change the selection, scan [Cancel on page 457](#).
- **Any Length** - Decode Codabar symbols containing any number of characters within the scanner's capability.

## Set Lengths for Codabar (continued)



**Codabar - One Discrete Length**



**Codabar - Two Discrete Lengths**



**\*Codabar - Length Within Range  
(Default: 4 to 55)**



**Codabar - Any Length**

## CLSI Editing

### Parameter # 54

### SSI # 36h

Scan **Enable CLSI Editing** to strip the start and stop characters and insert a space after the first, fifth, and tenth characters of a 14-character Codabar symbol if the host system requires this data format.



**NOTE:** Symbol length does not include start and stop characters.

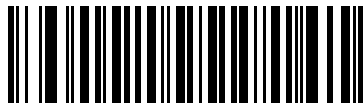

**Enable CLSI Editing  
(1)**

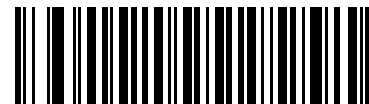

**\*Disable CLSI Editing  
(0)**

## NOTIS Editing

### Parameter # 55

### SSI # 37h

Scan **Enable NOTIS Editing** to strip the start and stop characters from a decoded Codabar symbol if the host system requires this data format.



**Enable NOTIS Editing  
(1)**

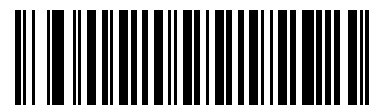

**\*Disable NOTIS Editing  
(0)**



## Codabar Security Level

Parameter # 1776

SSI # F8h 06h F0h

The scanner offers four levels of decode security for Codabar barcodes. There is an inverse relationship between security and scanner aggressiveness. Increasing the level of security can reduce scanning aggressiveness, so select only the level of security necessary.

- **Codabar Security Level 0:** This setting allows the scanner to operate in its most aggressive state, while providing sufficient security in decoding most in-spec barcodes.
- **Codabar Security Level 1:** This default setting eliminates most misdecodes.
- **Codabar Security Level 2:** Select this option with greater barcode security requirements if **Security Level 1** fails to eliminate misdecodes.
- **Codabar Security Level 3:** If you selected **Security Level 2**, and misdecodes still occur, select this security level to apply the highest safety requirements.



**NOTE:** Selecting this option is an extreme measure against mis-decoding severely out-of-spec barcodes, and significantly impairs the decoding ability of the scanner. If this level of security is required, try to improve the quality of the barcodes.



Codabar Security Level 0  
(0)



\*Codabar Security Level 1  
(1)



Codabar Security Level 2  
(2)



Codabar Security Level 3  
(3)

## Codabar Upper or Lower Case Start/Stop Characters

Parameter # 855

SSI # F2h 57h

Scan one of the following barcodes to select whether to transmit upper case or lower case Codabar start/stop characters.



Lower Case  
(1)

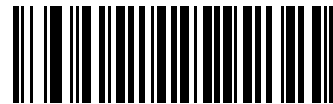

\*Upper Case  
(0)

## Codabar Mod 16 Check Digit Verification

Parameter # 1784

SSI # F8h 06h F8h

Enable this feature to check the Codabar Mod 16 Check Digit to verify that the data complies with the specified check digit algorithm.



Enable Codabar Mod 16 Check Digit  
(1)



\* Disable Codabar Mod 16 Check Digit  
(0)

## Transmit Codabar Check Digit

Parameter # 704

SSI # F1h C0h

Scan one of the following barcodes to select whether or not to transmit the Codabar check digit(s).



**NOTE:** [Codabar Mod 16 Check Digit Verification](#) must be enabled for this parameter to function.



**Enable Codabar Check Digit Transmission**  
(1)



**\* Disable Codabar Check Digit Transmission**  
(0)

---

## MSI

Parameter # 11

SSI # 0Bh

Scan one of the following barcodes to enable or disable MSI.

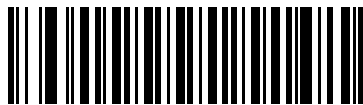

**Enable MSI**  
(1)

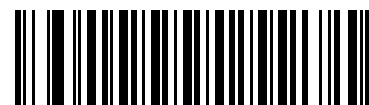

**\*Disable MSI**  
(0)

## Set Lengths for MSI

**L1 = Parameter # 30**

**SSI # 1Eh**

**L2 = Parameter # 31**

**SSI # 1Fh**

The length of a code refers to the number of characters (i.e., human readable characters), including check digit(s) the code contains. Set lengths for MSI to any length, one or two discrete lengths, or lengths within a specific range. The maximum range is 55. The default is **Length Within Range: 4 to 55**.



**NOTE:** When setting lengths, enter a leading zero for single digit numbers.

Scan one of the following barcodes to select a length option:

- **One Discrete Length** - Decode only MSI symbols containing a selected length. Select the length using the barcodes in [Numeric Barcodes](#). For example, to decode only MSI symbols with 14 characters, scan **MSI - One Discrete Length**, and then scan **1, 4**. To correct an error or change the selection, scan [Cancel on page 457](#).
- **Two Discrete Lengths** - Decode only MSI symbols containing either of two lengths. Select lengths using the barcodes in [Numeric Barcodes](#). For example, to decode only MSI symbols containing either 2 or 14 characters, scan **MSI - Two Discrete Lengths**, and then scan **0, 2, 1, 4**. To correct an error or change the selection, scan [Cancel on page 457](#).
- **Length Within Range** - Decode MSI symbols with a specific length range. Select lengths using the barcodes in [Numeric Barcodes](#). For example, to decode MSI symbols containing between 4 and 12 characters, scan **MSI - Length Within Range**, and then scan **0, 4, 1, 2**. To correct an error or change the selection, scan [Cancel on page 457](#).
- **Any Length** - Decode MSI symbols containing any number of characters within the scanner's capability.



**NOTE:** Due to the construction of the MSI symbology, it is possible for a scan line covering only a portion of the code to transmit as a complete scan, yielding less data than is encoded in the barcode. To prevent this, select specific lengths (**MSI - One Discrete Length, Two Discrete Lengths**) for MSI applications.

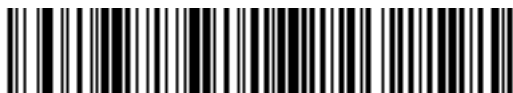

**MSI - One Discrete Length**



**MSI - Two Discrete Lengths**

## Set Lengths for MSI (continued)



\*MSI - Length Within Range  
(Default: 4 to 55)

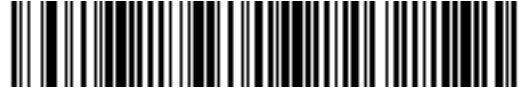

MSI - Any Length

## MSI Check Digits

### Parameter # 50

### SSI # 32h

With MSI symbols, one check digit is mandatory and always verified by the reader. The second check digit is optional. If the MSI codes include two check digits, scan the **Two MSI Check Digits** barcode to enable verification of the second check digit.

- 0 - Does not check the MSI check digit; decodes MSI with no check digit.
- 1 - This is for MSI barcodes with one check digit. This is the default.
- 2 - This is for MSI barcodes with two check digits.

See [MSI Check Digit Algorithm on page 282](#) to select second digit algorithms.

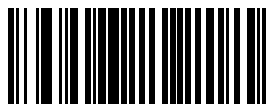

No MSI Check Digit  
(0)

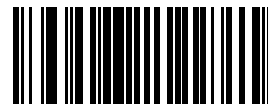

\*One MSI Check Digit  
(1)

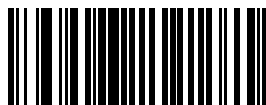

Two MSI Check Digits  
(2)

**Transmit MSI Check Digit(s)****Parameter # 46****SSI # 2Eh**

Scan one of the following barcodes to transmit MSI data with or without the check digit.



**Transmit MSI Check Digit(s) (Enable)**  
(1)

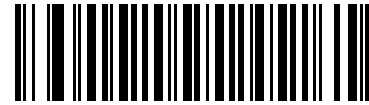

**\*Do Not Transmit MSI Check Digit(s) (Disable)**  
(0)

**MSI Check Digit Algorithm****Parameter # 51****SSI # 33h**

Two algorithms are available for verifying the second MSI check digit. Scan one of the following barcodes to select the algorithm used to encode the check digit.

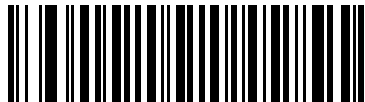

**MOD 11/MOD 10**  
(0)

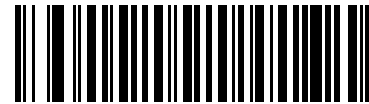

**\*MOD 10/MOD 10**  
(1)

## MSI Reduced Quiet Zone

Parameter # 1392

SSI # F8h 05h 70h

Scan one of the following barcodes to enable or disable decoding MSI barcodes with reduced quiet zones. If you select **Enable**, select a [1D Quiet Zone Level on page 297](#).

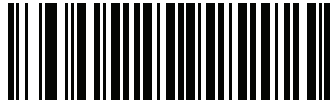

**\*Disable MSI Reduced Quiet Zone  
(0)**

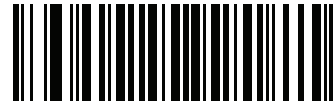

**Enable MSI Reduced Quiet Zone  
(1)**

---

## Chinese 2 of 5

Parameter # 408

SSI # F0h 98h

Scan one of the following barcodes to enable or disable Chinese 2 of 5.



**Enable Chinese 2 of 5  
(1)**

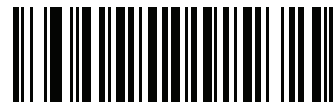

**\*Disable Chinese 2 of 5  
(0)**

## Matrix 2 of 5

**Parameter # 618**

**SSI # F1h 6Ah**

Scan one of the following barcodes to enable or disable Matrix 2 of 5.



**Enable Matrix 2 of 5  
(1)**



**\*Disable Matrix 2 of 5  
(0)**

## Set Lengths for Matrix 2 of 5

**L1 = Parameter # 619**

**SSI # F1h 6Bh**

**L2 = Parameter # 620**

**SSI # F1h 6Ch**

The length of a code refers to the number of characters (i.e., human readable characters), including check digit(s) the code contains. Set lengths for Matrix 2 of 5 to any length, one or two discrete lengths, or lengths within a specific range. The maximum range is 80. The default is **Length Within Range: 4 to 55**.



**NOTE:** When setting lengths, enter a leading zero for single digit numbers.

Scan one of the following barcodes to select a length option:

- **One Discrete Length** - Decode only Matrix 2 of 5 symbols containing a selected length. Select the length using the barcodes in [Numeric Barcodes](#). For example, to decode only Matrix 2 of 5 symbols with 14 characters, scan **Matrix 2 of 5 - One Discrete Length**, and then scan **1, 4**. To correct an error or change the selection, scan [Cancel on page 457](#).
- **Two Discrete Lengths** - Decode only Matrix 2 of 5 symbols containing either of two lengths. Select lengths using the barcodes in [Numeric Barcodes](#). For example, to decode only Matrix 2 of 5 symbols containing either 2 or 14 characters, scan **Matrix 2 of 5 - Two Discrete Lengths**, and then scan **0, 2, 1, 4**. To correct an error or change the selection, scan [Cancel on page 457](#).
- **Length Within Range** - Decode Matrix 2 of 5 symbols with a specific length range. Select lengths using the barcodes in [Numeric Barcodes](#). For example, to decode Matrix 2 of 5 symbols containing between 4 and 12 characters, scan **Matrix 2 of 5 - Length Within Range**, and then scan **0, 4, 1, 2**. To correct an error or change the selection, scan [Cancel on page 457](#).



## Set Lengths for Matrix 2 of 5 (continued)

- **Any Length** - Decode Matrix 2 of 5 symbols containing any number of characters within the scanner's capability.



**Matrix 2 of 5 - One Discrete Length**



**Matrix 2 of 5 - Two Discrete Lengths**



**\*Matrix 2 of 5 - Length Within Range  
(Default: 4 to 55)**



**Matrix 2 of 5 - Any Length**

## Matrix 2 of 5 Check Digit

Parameter # 622

SSI # F1h 6Eh

The check digit is the last character of the symbol used to verify the integrity of the data. Scan one of the following barcodes to determine whether to include the Matrix 2 of 5 check digit with the barcode data.



Enable Matrix 2 of 5 Check Digit  
(1)



\*Disable Matrix 2 of 5 Check Digit  
(0)

## Transmit Matrix 2 of 5 Check Digit

Parameter # 623

SSI # F1h 6Fh

Scan one of the following barcodes to transmit Matrix 2 of 5 data with or without the check digit.



Transmit Matrix 2 of 5 Check Digit  
(1)



\*Do Not Transmit Matrix 2 of 5 Check Digit  
(0)

## Korean 3 of 5

**Parameter # 581**

**SSI # F1h 45h**

Scan one of the following barcodes to enable or disable Korean 3 of 5.



**NOTE:** The length for Korean 3 of 5 is fixed at 6.



**Enable Korean 3 of 5  
(1)**



**\*Disable Korean 3 of 5  
(0)**

## Inverse 1D

### Parameter # 586

### SSI # F1h 4Ah

Scan one of the following barcodes to set the 1D inverse decoder setting:

- **Regular Only** - The scanner decodes regular 1D barcodes only.
- **Inverse Only** - The scanner decodes inverse 1D barcodes only.
- **Inverse Autodetect** - The scanner decodes both regular and inverse 1D barcodes.



**NOTES** 1 This parameter does not apply to GS1 DataBarcode types.  
2. The Inverse 1D setting may impact Composite or Inverse Composite decoding.  
See [Composite Inverse on page 300](#).



**\*Regular  
(0)**



**Inverse Only  
(1)**



**Inverse Autodetect  
(2)**

## GS1 DataBar

The variants of GS1 DataBar are DataBar Omnidirectional, DataBar Limited, and DataBar Expanded. The limited and expanded versions have stacked variants. Scan the appropriate barcodes to enable or disable each variant of GS1 DataBar.

### GS1 DataBar Omnidirectional (formerly GS1 DataBar-14)

**Parameter # 338**

**SSI # F0h 52h**

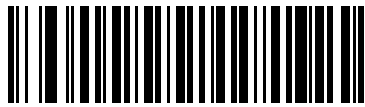

**\*Enable GS1 DataBar Omnidirectional  
(1)**



**Disable GS1 DataBar Omnidirectional  
(0)**

### GS1 DataBar Limited

**Parameter # 339**

**SSI # F0h 53h**

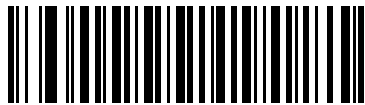

**\*Enable GS1 DataBar Limited  
(1)**

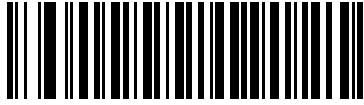

**Disable GS1 DataBar Limited  
(0)**

**GS1 DataBar Expanded****Parameter # 340****SSI # F0h 54h**

**\*Enable GS1 DataBar Expanded**  
(1)

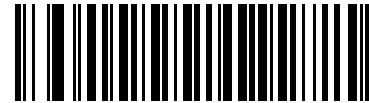

**Disable GS1 DataBar Expanded**  
(0)

**Convert GS1 DataBar to UPC/EAN/JAN****Parameter # 397****SSI # F0h, 8Dh**

This parameter only applies to GS1 DataBar Omnidirectional and GS1 DataBar Limited symbols not decoded as part of a Composite symbol. Scan **Enable Convert GS1 DataBar to UPC/EAN/JAN** to strip the leading '010' from DataBar Omnidirectional and DataBar Limited symbols encoding a single zero as the first digit, and report the barcode as EAN-13.

For barcodes beginning with between two and five zeros, this strips the leading '0100' and reports the barcode as UPC-A. The [UPC-A Preamble](#) option that transmits the system character and country code applies to converted barcodes. Note that neither the system character nor the check digit can be stripped.



**Enable Convert GS1 DataBar to UPC/EAN/JAN**  
(1)



**\*Disable Convert GS1 DataBar to UPC/EAN/JAN**  
(0)

## GS1 DataBar Security Level

### Parameter # 1706

### SSI # F8h 06h AAh

The scanner offers four levels of decode security for GS1 DataBar (GS1 DataBar Omnidirectional, GS1 DataBar Limited, GS1 DataBar Expanded) barcodes.

- **Security Level 0** - The scanner operates in its most aggressive state, while providing sufficient security decoding most in-spec barcodes.
- **Security Level 1** - This setting eliminates most misdecodes while maintaining reasonable aggressiveness.
- **Security Level 2** - Select this option with greater barcode security requirements if Security Level 1 fails to eliminate misdecodes.
- **Security Level 3** - If you selected Security Level 2 and misdecodes still occur, select this security level to apply the highest safety requirements.



**GS1 DataBar Security Level 0**  
(0)



**\*GS1 DataBar Security Level 1**  
(1)



**GS1 DataBar Security Level 2**  
(2)



**GS1 DataBar Security Level 3**  
(3)

## GS1 DataBar Limited Margin Check

Parameter # 728

SSI # F1h D8h

The scanner offers four levels of decode security for GS1 DataBar Limited barcodes. There is an inverse relationship between the level of margin check and scanner aggressiveness. Increasing the level of margin check can reduce scanning aggressiveness, so select only the level of margin check necessary.

- **Margin Check Level 1** – No clear margin required. This complies with the original GS1 standard, yet can result in erroneous decoding of a DataBar Limited barcode when scanning some UPC symbols that start with digits **9** and **7**.
- **Margin Check Level 2** – Automatic risk detection. This level of margin check can result in erroneous decoding of DataBar Limited barcodes when scanning some UPC symbols. If a misdecode is detected, the scanner operates in Level 3 or Level 1.
- **Margin Check Level 3** – Margin check level reflects the newly proposed GS1 standard that requires a five times trailing clear margin.
- **Margin Check Level 4** – Margin check level extends beyond the standard required by GS1. This level of margin check requires a five times leading and trailing clear margin.



GS1 DataBar Limited Margin Check Level 1  
(1)



GS1 DataBar Limited Margin Check Level 2  
(2)



\*GS1 DataBar Limited Margin Check Level 3  
(3)



GS1 DataBar Limited Margin Check Level 4  
(4)



## GS1 DataBar Expanded Security Level

Parameter # 1707

SSI # F8h 06h ABh

The scanner offers four levels of decode security for GS1 DataBar Expanded barcodes.

- **Security Level 0** - The scanner operates in its most aggressive state, while providing sufficient security decoding most in-spec barcodes.
- **Security Level 1** - This setting eliminates most misdecodes while maintaining reasonable aggressiveness.
- **Security Level 2** - Select this option with greater barcode security requirements if Security Level 1 fails to eliminate misdecodes.
- **Security Level 3** - If you selected Security Level 2 and misdecodes still occur, select this security level to apply the highest safety requirements.



GS1 DataBar Expanded Security Level 0  
(0)



\*GS1 DataBar Expanded Security Level 1  
(1)



GS1 DataBar Expanded Security Level 2  
(2)



GS1 DataBar Expanded Security Level 3  
(3)

---

## Symbology-Specific Security Features

### Redundancy Level

#### Parameter # 78

#### SSI # 4Eh

The scanner offers four levels of decode redundancy. Select higher redundancy levels for decreasing levels of barcode quality. As redundancy levels increase, the scanner's aggressiveness decreases.

Scan one of the following barcodes to select the redundancy level appropriate for the barcode quality:

- **Redundancy Level 1** - The scanner must read the following code types twice before decoding:
  - Codabar (8 characters or less)
  - MSI (4 characters or less)
  - D 2 of 5 (8 characters or less)
  - I 2 of 5 (8 characters or less)
- **Redundancy Level 2** - The scanner must read all code types twice before decoding.
- **Redundancy Level 3** - The scanner must read code types other than the following twice before decoding, but must read the following codes three times:
  - Codabar (8 characters or less)
  - MSI (4 characters or less)
  - D 2 of 5 (8 characters or less)
  - I 2 of 5 (8 characters or less)
- **Redundancy Level 4** - The scanner must read all code types three times before decoding.

## Redundancy Level (continued)

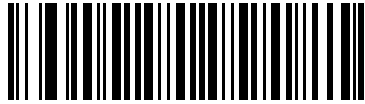

**\*Redundancy Level 1  
(1)**



**Redundancy Level 2  
(2)**

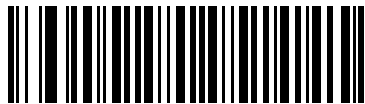

**Redundancy Level 3  
(3)**

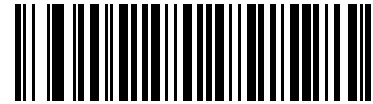

**Redundancy Level 4  
(4)**

## Security Level

### Parameter # 77

#### SSI # 4Dh

The scanner offers four levels of decode security for delta barcodes, which include the Code 128 family, UPC/EAN/JAN, and Code 93. Select increasing levels of security for decreasing levels of barcode quality. There is an inverse relationship between security and scanner aggressiveness, so choose only that level of security necessary for the application.

- **Security Level 0** - The scanner operates in its most aggressive state, while providing sufficient security decoding most in-spec barcodes.
- **Security Level 1** - This default setting eliminates most misdecodes.
- **Security Level 2** - Select this option if Security Level 1 fails to eliminate misdecodes.
- **Security Level 3** - If you selected Security Level 2 and misdecodes still occur, select this security level.



**NOTE:** Selecting this option is an extreme measure against mis-decoding severely out-of-spec barcodes, and significantly impairs the decoding ability of the scanner. If this level of security is required, try to improve the quality of the barcodes.

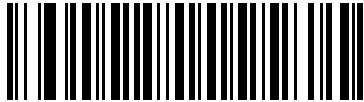

**Security Level 0**  
(0)



**\*Security Level 1**  
(1)

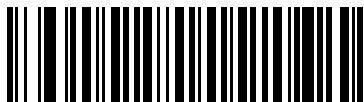

**Security Level 2**  
(2)



**Security Level 3**  
(3)

## 1D Quiet Zone Level

Parameter # 1288

SSI # F8h 05h 08h

This feature sets the level of aggressiveness when decoding barcodes with a reduced quiet zone (the margin on either side of a barcode), and applies to symbologies enabled by a Reduced Quiet Zone parameter. Because higher levels increase the decoding time and risk of misdecodes, Zebra strongly recommends enabling only the symbologies which require higher quiet zone levels, and leaving Reduced Quiet Zone disabled for all other symbologies. Options are:

- **1D Quiet Zone Level 0** - The scanner performs normally in terms of quiet zone.
- **1D Quiet Zone Level 1** - The scanner performs more aggressively in terms of quiet zone.
- **1D Quiet Zone Level 2** - The scanner only requires a quiet zone at the end of barcode for decoding.
- **1D Quiet Zone Level 3** - The scanner decodes anything in terms of quiet zone or end of barcode.

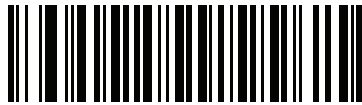

1D Quiet Zone Level 0  
(0)

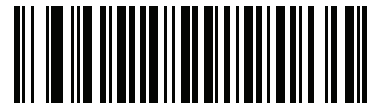

\*1D Quiet Zone Level 1  
(1)

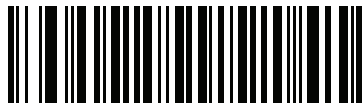

1D Quiet Zone Level 2  
(2)



1D Quiet Zone Level 3  
(3)

## Intercharacter Gap Size

### Parameter # 381

### SSI # F0h, 7Dh

The Code 39 and Codabar symbologies have an intercharacter gap that is typically quite small. Due to various barcode printing technologies, this gap can grow larger than the maximum size allowed, preventing the scanner from decoding the symbol. If this problem occurs, scan the **Large Intercharacter Gaps** parameter to tolerate these out-of-specification barcodes.



**\*Normal Intercharacter Gaps  
(6)**



**Large Intercharacter Gaps  
(10)**

---

## Composite

### Composite CC-C

Parameter # 341

SSI # F0h 55h

Scan one of the following barcodes to enable or disable Composite barcodes of type CC-C.

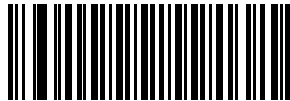

Enable CC-C  
(1)

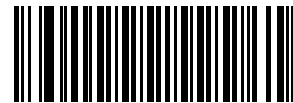

\*Disable CC-C  
(0)

### Composite CC-A/B

Parameter # 342

SSI # F0h 56h

Scan one of the following barcodes to enable or disable Composite barcodes of type CC-A/B.

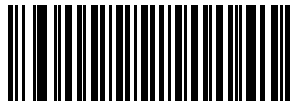

Enable CC-A/B  
(1)

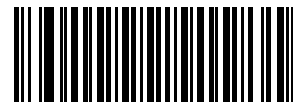

\*Disable CC-A/B  
(0)

**Composite TLC-39****Parameter # 371****SSI # F0h 73h**

Scan one of the following barcodes to enable or disable Composite barcodes of type TLC-39.

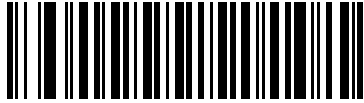

**Enable TLC39  
(1)**



**\*Disable TLC39  
(0)**

**Composite Inverse****Parameter # 1113****SSI # F8h 04h 59h**

Select an option to set Composite for either regular decode or inverse decode.

- **Regular Only** - The scanner decodes regular Composite barcodes only. Before selecting this, set [Inverse 1D on page 288](#) to **Regular Only** or **Inverse Autodetect**.
- **Inverse Only** - The scanner decodes inverse Composite barcodes only. This mode only supports Composite Inverse that includes DataBar combined with CCAB, and does not support other 1D/2D combinations. Before selecting this, first enable [Composite CC-A/B on page 299](#), and set [Inverse 1D on page 288](#) to **Inverse Only** or **Inverse Autodetect**.



**\*Regular Only  
(0)**



**Inverse Only  
(1)**



## UPC Composite Mode

### Parameter # 344

### SSI # F0h 58h

Select an option for linking UPC symbols with a 2D symbol during transmission as if they were one symbol:

- **UPC Never Linked** - Transmit UPC barcodes regardless of whether a 2D symbol is detected.
- **UPC Always Linked** - Transmit UPC barcodes and the 2D portion. If 2D is not present, do not transmit the barcode.
- **Autodiscriminate UPC Composites** - The scanner determines if there is a 2D portion, then transmits the UPC, as well as the 2D portion if present.



**\*UPC Never Linked  
(0)**

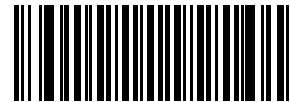

**UPC Always Linked  
(1)**



**Autodiscriminate UPC Composites  
(2)**

## Composite Beep Mode

Parameter # 398

SSI # F0h, 8Eh

Scan one of the following barcodes to select the number of decode beeps that sound upon decoding a Composite barcode.

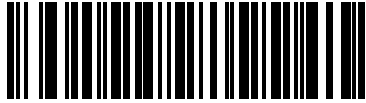

Single Beep After Both are Decoded  
(0)

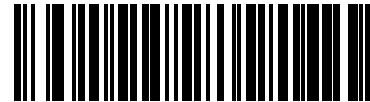

\*Beep as Each Code Type is Decoded  
(1)

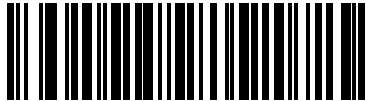

Double Beep After Both are Decoded  
(2)

## GS1-128 Emulation Mode for UCC/EAN Composite Codes

Parameter # 427

SSI # F0h, ABh

Scan one of the following barcodes to enable or disable this mode.



**Enable GS1-128 Emulation Mode for  
UCC/EAN Composite Codes  
(1)**



**\*Disable GS1-128 Emulation Mode for  
UCC/EAN Composite Codes  
(0)**

---

## 2D Symbologies

### PDF417

Parameter # 15

SSI # 0Fh

Scan one of the following barcodes to enable or disable PDF417.



**\*Enable PDF417**  
**(1)**



**Disable PDF417**  
**(0)**

### MicroPDF417

Parameter # 227

SSI # E3h

Scan one of the following barcodes to enable or disable MicroPDF417.



**Enable MicroPDF417**  
**(1)**



**\*Disable MicroPDF417**  
**(0)**

## Code 128 Emulation

### Parameter # 123

### SSI # 7Bh

Enable this parameter to transmit data from certain MicroPDF417 symbols as Code 128. You must enable [AIM Code ID Character \(1\) on page 180](#) for this parameter to work.

Enable Code 128 Emulation to transmit these MicroPDF417 symbols with one of the following prefixes:

- ]C1if the first codeword is 903-905
- ]C2if the first codeword is 908 or 909
- ]C0if the first codeword is 910 or 911

Disable Code 128 Emulation to transmit these MicroPDF417 symbols with one of the following prefixes:

- ]L3if the first codeword is 903-905
- ]L4if the first codeword is 908 or 909
- ]L5if the first codeword is 910 or 911

Scan one of the following barcodes to enable or disable Code 128 Emulation.



**NOTE:** Linked MicroPDF codewords 906, 907, 912, 914, and 915 are not supported. Use GS1 Composites instead.



**Enable Code 128 Emulation  
(1)**



**\*Disable Code 128 Emulation  
(0)**

## Data Matrix

Parameter # 292

SSI # F0h, 24h

Scan one of the following barcodes to enable or disable Data Matrix.



**\*Enable Data Matrix  
(1)**



**Disable Data Matrix  
(0)**

## GS1 Data Matrix

Parameter # 1336

SSI # F8h 05h 38h

Scan one of the following barcodes to enable or disable GS1 Data Matrix.

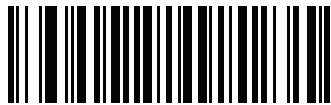

**Enable GS1 Data Matrix  
(1)**



**\*Disable GS1 Data Matrix  
(0)**

## Data Matrix Inverse

### Parameter # 588

### SSI # F1h 4Ch

Scan one of the following barcodes to select the Data Matrix inverse decoder setting:

- **Regular Only** - The scanner decodes regular Data Matrix barcodes only.
- **Inverse Only** - The scanner decodes inverse Data Matrix barcodes only.
- **Inverse Autodetect** - The scanner decodes both regular and inverse Data Matrix barcodes.



**Regular Only**  
(0)



**Inverse Only**  
(1)



**\*Inverse Autodetect**  
(2)

## Decode Data Matrix Mirror Images

### Parameter # 537

### SSI # F1h 19h

Scan one of the following barcodes to select an option for decoding mirror image Data Matrix barcodes:

- **Never** - Do not decode Data Matrix barcodes that are mirror images.
- **Always** - Decode only Data Matrix barcodes that are mirror images.
- **Auto** - Decode both mirrored and unmirrored Data Matrix barcodes.



**Never**  
(0)



**Always**  
(1)



**\*Auto**  
(2)



## Maxicode

Parameter # 294

SSI # F0h, 26h

Scan one of the following barcodes to enable or disable Maxicode.



**Enable Maxicode  
(1)**



**\*Disable Maxicode  
(0)**

## QR Code

Parameter # 293

SSI # F0h, 25h

Scan one of the following barcodes to enable or disable QR Code.



**NOTE:** Enabling this also enables [Linked QR Mode](#).



**\*Enable QR Code  
(1)**



**Disable QR Code  
(0)**

## GS1 QR

Parameter # 1343

SSI # F8h 05h 3Fh

Scan one of the following barcodes to enable or disable GS1 QR.



**\*Enable GS1 QR  
(1)**



**Disable GS1 QR  
(0)**

## MicroQR

Parameter # 573

SSI # F1h 3Dh

Scan one of the following barcodes to enable or disable MicroQR.



**\*Enable MicroQR  
(1)**



**Disable MicroQR  
(0)**

## Linked QR Mode

Parameter # 1847

SSI # 737h

Scan one of the following barcodes to select a linked QR mode:

- **Linked QR Only** - The scanner does not decode individual QR symbols from a set of linked QR codes.
- **Individual QR With Headers** - The scanner decodes individual QR symbols from a set of linked QR codes and retains the header information and data.
- **Individual QR No Headers** - The scanner decodes individual QR symbols from a set of linked QR codes and transmits the data without header information.

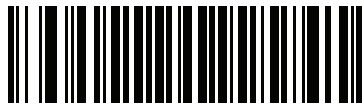

\*Linked QR Only  
(0)



Individual QR With Headers  
(1)

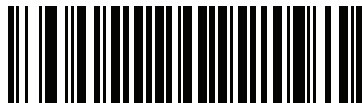

Individual QR No Headers  
(2)

## Aztec

**Parameter # 574**

**SSI # F1h 3Eh**

Scan one of the following barcodes to enable or disable Aztec.



**NOTE:** Enabling this also enables Linked Aztec.



**\*Enable Aztec  
(1)**



**Disable Aztec  
(0)**

## Aztec Inverse

### Parameter # 589

### SSI # F1h 4Dh

Scan one of the following barcodes to select the Aztec inverse decoder setting:

- **Regular Only** - The scanner decodes regular Aztec barcodes only.
- **Inverse Only** - The scanner decodes inverse Aztec barcodes only.
- **Inverse Autodetect** - The scanner decodes both regular and inverse Aztec barcodes.



**Regular Only**  
(0)



**Inverse Only**  
(1)



**\*Inverse Autodetect**  
(2)

## Han Xin

**Parameter # 1167**

**SSI # F8h 04h 8Fh**

Scan one of the following barcodes to enable or disable Han Xin.



**Enable Han Xin  
(1)**

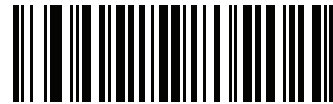

**\*Disable Han Xin  
(0)**

## Han Xin Inverse

**Parameter # 1168**

**SSI # F8h 04h 90h**

Scan one of the following barcodes to select a Han Xin inverse decoder setting:

- **Regular Only** - The scanner decodes Han Xin barcodes with normal reflectance only.
- **Inverse Only** - The scanner decodes Han Xin barcodes with inverse reflectance only.
- **Inverse Autodetect** - The scanner decodes both regular and inverse Han Xin barcodes.



**\*Regular Only  
(0)**

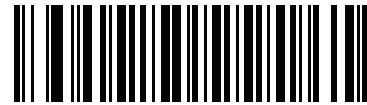

**Inverse Only  
(1)**



**Inverse Autodetect  
(2)**



## Grid Matrix

Parameter # 1718

SSI # F8h 06h B6h

To enable or disable Grid Matrix, scan one of the following barcodes.



**Enable Grid Matrix  
(1)**



**\*Disable Grid Matrix  
(0)**

## Grid Matrix Inverse

### Parameter # 1719

### SSI # F8h 06h B7h

Select a Grid Matrix inverse decoder setting:

- **Regular Only** - the imager decodes Grid Matrix barcodes with normal reflectance only.
- **Inverse Only** - the imager decodes Grid Matrix barcodes with inverse reflectance only.
- **Inverse Autodetect** - the imager decodes both regular and inverse Grid Matrix barcodes.



**\*Regular**  
**(0)**

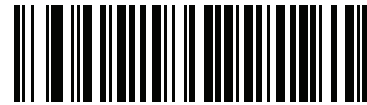

**Inverse Only**  
**(1)**



**Inverse Autodetect**  
**(2)**

## Grid Matrix Mirror

Parameter # 1736

SSI # F8h 06h C8h

Select a mirror image Grid Matrix setting:

- **Regular Only** - the imager decodes non-mirrored Grid Matrix barcodes only.
- **Mirrored Only** - the imager decodes mirrored Grid Matrix barcodes only.
- **Autodiscriminate** - the imager decodes both mirrored and non-mirrored Grid Matrix barcodes.

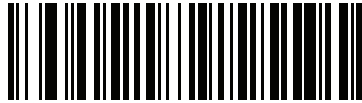

**\*Regular Only**  
(0)

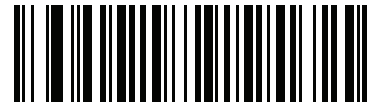

**Mirrored Only**  
(1)



**Autodiscriminate**  
(2)

**DotCode**

**Parameter # 1906**

**SSI # F8 07 72h**

Scan one of the following barcodes to enable or disable DotCode.

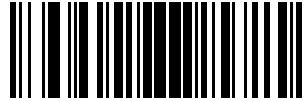

**\* Disable DotCode  
(0)**

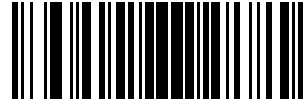

**Enable DotCode  
(1)**

## DotCode Inverse

Parameter # 1907

SSI # F8 07 73h

Scan one of the following barcodes to select a DotCode Inverse decoder setting. Setting options are:

- **Regular Only** - Decoder decodes DotCode barcodes with normal reflectance only.
- **Inverse Only** - Decoder decodes DotCode barcodes with inverse reflectance only.
- **Inverse Autodetect** - Decoder decodes both regular and inverse DotCode barcodes.

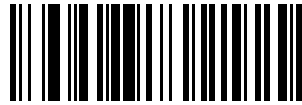

**Regular**  
**(0)**

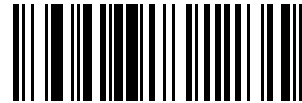

**Inverse Only**  
**(1)**

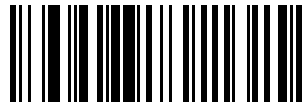

**\* Inverse Autodetect**  
**(2)**

## DotCode Mirrored

Parameter # 1908

SSI # F8 07 74h

Scan one of the following barcodes to select a DotCode Mirror decoder setting:

- **Non-Mirrored Only** - Digital scanner decodes non-mirrored DotCode barcodes only.
- **Mirrored Only** - Digital scanner decodes mirrored DotCode barcodes only.
- **Autodetect** - Digital scanner decodes both mirrored and non-mirrored DotCode barcodes.



**Non-Mirrored Only**  
(0)



**Mirrored Only**  
(1)

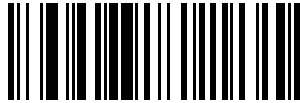

**\* Autodetect**  
(2)

## DotCode Prioritize

Parameter # 1937

SSI # F8 07 91h

Enable DotCode Prioritize to give priority to DotCode decoding as compared to other symbologies.



Disable



\* Enable

---

## Macro PDF Features

Macro PDF is a special feature for concatenating multiple PDF symbols into one file. The scanner can decode symbols encoded with this feature, and can store more than 64 Kb of decoded data from up to 50 MacroPDF symbols.



**CAUTION:** When printing, keep each Macro PDF sequence separate, as each sequence has unique identifiers. Do not mix barcodes from several Macro PDF sequences, even if they encode the same data. When scanning a Macro PDF sequence, scan the entire sequence without interruption. When scanning a mixed sequence, two long low beeps (low / low) indicate an inconsistent file ID or inconsistent symbology error.

## Escape Characters

### Parameter # 233

#### SSI # E9h

This enables the backslash (\) character as an Escape character for systems that can process transmissions containing special data sequences. Scan one of the following barcodes to either format special data according to the GLI (Global Label Identifier) protocol, or to disable this parameter. This parameter only affects the data portion of a Macro PDF symbol transmission; the Macro PDF Control Header (if enabled) is always sent with GLI formatting.



**GLI Protocol  
(2)**



**\*None  
(0)**

## Flush Macro PDF Buffer

Scan the following barcode to flush the buffer of all decoded Macro PDF data stored to that point, transmit it to the host device, and abort from Macro PDF mode.

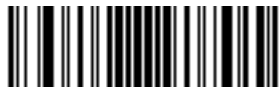

**Flush Macro PDF Buffer**

## Abort Macro PDF Entry

Scan the following barcode to clear all currently-stored Macro PDF data in the buffer without transmission and abort from Macro PDF mode.



**Abort Macro PDF Entry**



---

## Postal Codes

### US Postnet

Parameter # 89

SSI # 59h

Scan one of the following barcodes to enable or disable US Postnet.



Enable US Postnet  
(1)



\*Disable US Postnet  
(0)

### US Planet

Parameter # 90

SSI # 5Ah

Scan one of the following barcodes to enable or disable US Planet.



Enable US Planet  
(1)



\*Disable US Planet  
(0)

## Transmit US Postal Check Digit

Parameter # 95

SSI # 5Fh

Scan one of the following barcodes to select whether to transmit US Postal data, which includes both US Postnet and US Planet, with or without the check digit.

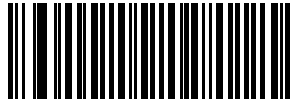

**\*Transmit US Postal Check Digit  
(1)**

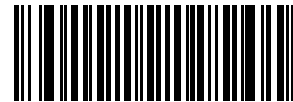

**Do Not Transmit US Postal Check Digit  
(0)**

## UK Postal

Parameter # 91

SSI # 5Bh

Scan one of the following barcodes to enable or disable UK Postal.



**Enable UK Postal  
(1)**

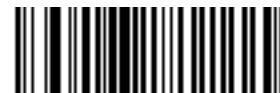

**\*Disable UK Postal  
(0)**

## Transmit UK Postal Check Digit

Parameter # 96

SSI # 60h

Scan one of the following barcodes to select whether to transmit UK Postal data with or without the check digit.



**\*Transmit UK Postal  
Check Digit  
(1)**



**Do Not Transmit UK Postal Check Digit  
(0)**

## Japan Postal

Parameter # 290

SSI # F0h, 22h

Scan one of the following barcodes to enable or disable Japan Postal.



**Enable Japan Postal  
(1)**



**\*Disable Japan Postal  
(0)**

## Australia Post

Parameter # 291

SSI # F0h, 23h

Scan one of the following barcodes to enable or disable Australia Post.



**Enable Australia Post  
(1)**



**\*Disable Australia Post  
(0)**

## Australia Post Format

### Parameter # 718

### SSI # F1h, CEh

Scan one of the following barcodes to select a format for Australia Post:

- **Autodiscriminate** (or Smart mode) - Decode the Customer Information Field using the N and C Encoding Tables.



**NOTE:** This option increases the risk of misdecodes because the encoded data format does not specify the Encoding Table used for encoding.

- **Raw Format** - Output raw bar patterns as a series of numbers 0 through 3.
- **Alphanumeric Encoding** - Decode the Customer Information Field using the C Encoding Table.
- **Numeric Encoding** - Decode the Customer Information Field using the N Encoding Table.

For more information on Australia Post Encoding Tables, refer to the Australia Post Customer Barcoding Technical Specifications available at <http://www.auspost.com.au>.



**\*Autodiscriminate  
(0)**



**Raw Format  
(1)**



**Alphanumeric Encoding  
(2)**



**Numeric Encoding  
(3)**

## Netherlands KIX Code

Parameter # 326

SSI # F0h, 46h

Scan one of the following barcodes to enable or disable Netherlands KIX Code.



Enable Netherlands KIX Code  
(1)



\*Disable Netherlands KIX Code  
(0)

## USPS 4CB/One Code/Intelligent Mail

Parameter # 592

SSI # F1h 50h

Scan one of the following barcodes to enable or disable USPS 4CB/One Code/Intelligent Mail.



Enable USPS 4CB/One Code/Intelligent Mail  
(1)



\*Disable USPS 4CB/One Code/Intelligent Mail  
(0)

## UPU FICS Postal

Parameter # 611

SSI # F1h 63h

Scan one of the following barcodes to enable or disable UPU FICS Postal.



Enable UPU FICS Postal  
(1)



\*Disable UPU FICS Postal  
(0)

## Mailmark

Parameter # 1337

SSI # F8h 05h 39h

Scan one of the following barcodes to enable or disable Mailmark.

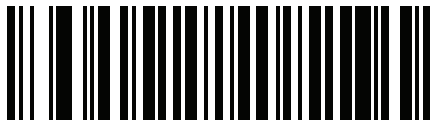

\*Disable Mailmark  
(0)

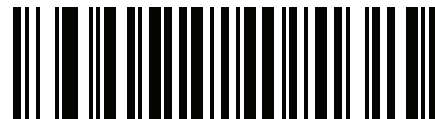

Enable Mailmark  
(1)

# OCR Programming

---

## Introduction

This chapter describes how to set up the scanner for OCR programming. The scanner can read 6 to 60 point OCR typeface. It supports font types OCR-A, OCR-B, MICR-E13B, and US Currency Serial Number.

OCR is not as secure as a barcode. To decrease OCR misdecodes and speed OCR reading, set an accurate OCR template and character subset, and use a check digit.

All OCR fonts are disabled by default. You can enable OCR-A and OCR-B at the same time, but not other combined font types.

---

## Setting Parameters

To set feature values, scan a single barcode or a short barcode sequence. The settings are stored in non-volatile memory and are preserved even when the imager powers down.



**NOTE:** Most computer monitors allow scanning barcodes directly on the screen. When scanning from the screen, be sure to set the document magnification to a level where you can see the barcode clearly, and bars and/or spaces do not merge.

To return all features to default values, scan the [Set Factory Defaults on page 142](#). Throughout the programming barcode menus, asterisks (\*) indicate default values.

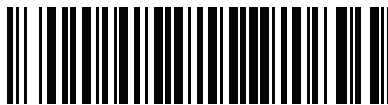

\* Indicates default      \*Enable Parameter      Feature/option  
(1)      Option value

## Scanning Sequence Examples

In most cases scanning one barcode sets the parameter value. For example, to enable OCR-B, scan the **Enable OCR-B** barcode under [OCR-B on page 337](#). The scanner issues a fast warble beep and the LED turns green, signifying a successful parameter entry.

Other parameters require scanning several barcodes. See the parameter descriptions for this procedure.



## Errors While Scanning

Unless otherwise specified, to correct an error during a scanning sequence, just re-scan the correct parameter.

## OCR Parameter Defaults

Table 32 lists the defaults for OCR parameters. Change these values in one of two ways:

- Scan the appropriate barcodes in this chapter. The new value replaces the standard default value in memory. To recall default parameter values, see [Default Parameters on page 142](#).
- Configure the scanner using the 123Scan configuration program. See [123Scan and Software Tools](#).



**NOTE:** See [Standard Parameter Defaults](#) for all user preference, host, symbology, and miscellaneous default parameters.

**Table 32** OCR Programming Default Table

Parameter	Parameter Number	SSI Number	Default	Page Number
<b>OCR Programming Parameters</b>				
OCR-A	680	F1h A8h	Disable	<a href="#">334</a>
OCR-A Variant	684	F1h ACh	Full ASCII	<a href="#">335</a>
OCR-B	681	F1h A9h	Disable	<a href="#">337</a>
OCR-B Variant	685	F1h ADh	Full ASCII	<a href="#">338</a>
MICR E13B	682	F1h AAh	Disable	<a href="#">342</a>
US Currency	683	F1h ABh	Disable	<a href="#">343</a>
OCR Orientation	687	F1h AFh	0°	<a href="#">343</a>
OCR Lines	691	F1h B3h	1	<a href="#">345</a>
OCR Minimum Characters	689	F1h B1h	3	<a href="#">345</a>
OCR Maximum Characters	690	F1h B2h	100	<a href="#">346</a>
OCR Subset	686	F1h AEh	Selected font variant	<a href="#">346</a>
OCR Quiet Zone	695	F1h B7h	50	<a href="#">347</a>
OCR Template	547	F1h 23h	99999999	<a href="#">348</a>
OCR Check Digit Modulus	688	F1h B0h	1	<a href="#">357</a>
OCR Check Digit Multiplier	700	F1h BCh	121212121212	<a href="#">358</a>
OCR Check Digit Validation	694	F1h B6h	None	<a href="#">360</a>
Inverse OCR	856	F2h 58h	Regular	<a href="#">365</a>
OCR Redundancy	1770	F8h 06h EAh	Level 1	<a href="#">366</a>

---

## OCR Programming Parameters

### OCR-A

#### Parameter # 680

#### SSI # F1h A8h

Scan one of the following barcodes to enable or disable OCR-A.



**NOTES** 1 OCR is not as secure as a barcode. To decrease OCR misdecodes and speed OCR reading, set an accurate OCR template and character subset, and use a check digit. See [OCR Subset on page 346](#) and [OCR Template on page 348](#).

2. All OCR fonts are disabled by default.



Enable OCR-A  
(1)

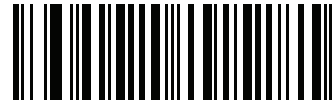

\*Disable OCR-A  
(0)

## OCR-A Variant

### Parameter # 684

#### SSI # F1 ACh

The font variant sets a processing algorithm and default character subset for the given font. To choose a variant, scan one of the following barcodes. Select the most appropriate font variant to optimize performance and accuracy.

OCR-A supports the following variants:

- OCR-A Full ASCII

!"#\$()\*+,-./0123456789<>ABCDEFGHIJKLMNOPQRSTUVWXYZ^

- OCR-A Reserved 1

\$\*+,-./0123456789ABCDEFGHIJKLMNOPQRSTUVWXYZ

- OCR-A Reserved 2

\$\*+,-./0123456789<>ABCDEFGHIJKLMNOPQRSTUVWXYZ

- OCR-A Banking

-0123456789<> Ψ ϣ ϣ

Special banking characters output as the following representative characters:

Ψ outputs as f

ϣ outputs as c

ϣ outputs as h



**NOTE:** Enable OCR-A before setting this parameter. If disabling OCR-A, set the variant to its default (OCR-A Full ASCII).

**OCR-A Variant (continued)**



**\*OCR-A Full ASCII  
(0)**

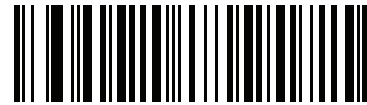

**OCR-A Reserved 1  
(1)**



**OCR-A Reserved 2  
(2)**

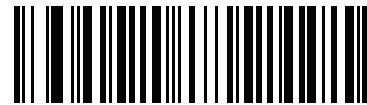

**OCR-A Banking  
(3)**

## OCR-B

### Parameter # 681

### SSI # F1h A9h

Scan one of the following barcodes to enable or disable OCR-B.



**NOTES** 1 OCR is not as secure as a barcode. To decrease OCR misdecodes and speed OCR reading, set an accurate OCR template and character subset, and use a check digit. See [OCR Subset on page 346](#) and [OCR Template on page 348](#).

2. All OCR fonts are disabled by default.



**Enable OCR-B**  
(1)



**\*Disable OCR-B**  
(0)

## OCR-B Variant

### Parameter # 685

### SSI # F1h ADh

OCR-B has the following variants. Select the most appropriate font variant to optimize performance and accuracy.

- OCR-B Full ASCII

!#\$%()\*+,-./0123456789<>ABCDEFGHIJKLMNOPQRSTUVWXYZ^|ñ

- OCR-B Banking

#+-0123456789<>JNP|

- OCR-B Limited

+,-./0123456789<>ACENPSTVX

- OCR-B ISBN 10-Digit Book Numbers

-0123456789>BCEINPSXz

- OCR-B ISBN 10 or 13-Digit Book Numbers

-0123456789>BCEINPSXz

- OCR-B Travel Document Version 1 (TD1) 3-Line ID Cards

-0123456789<ABCDEFGHIJKLMNOPQRSTUVWXYZ

- OCR-B Travel Document Version 2 (TD2) 2-Line ID Cards

-0123456789<ABCDEFGHIJKLMNOPQRSTUVWXYZ

- OCR-B Travel Document 2 or 3-Line ID Cards Auto-Detect

!#\$%()\*+,-./0123456789<>ABCDEFGHIJKLMNOPQRSTUVWXYZ^|ñ

- OCR-B Passport

-0123456789<ABCDEFGHIJKLMNOPQRSTUVWXYZñ

- OCR-B Visa Type A

-0123456789<ABCDEFGHIJKLMNOPQRSTUVWXYZ

- OCR-B Visa Type B

-0123456789<ABCDEFGHIJKLMNOPQRSTUVWXYZñ

- OCR-B ICAO Travel Documents

This allows reading either TD1, TD2, Passport, Visa Type A, or Visa Type B without switching between these options. It automatically recognizes the travel document read.

Selecting one of the ISBN Book Numbers automatically applies the appropriate ISBN checksum, so setting this is not required.

## OCR-B Variant (continued)

To choose a variant, scan one of the following barcodes. Selecting the following OCR-B variants automatically sets the appropriate [OCR Lines on page 345](#). These five variants invoke extensive special algorithms and checking for that particular document type:

Passport	2
TD1 ID Cards	3
TD2 ID Cards	2
Visa Type A	2
Visa Type B	2

If you set one of these variants with both OCR-A and OCR-B enabled, only the specified travel document is read without reading OCR-A. Returning OCR-B variant to its default (Full ASCII) allows reading OCR-A.

For the best performance in passport reading, fix the target passport and the scanner in place (6.5 - 7.5”).



**NOTE:** Enable OCR-B before setting this parameter. If disabling OCR-B, set the variant to its default (OCR-B Full ASCII).



**\*OCR-B Full ASCII  
(0)**



**OCR-B Banking  
(1)**



**OCR-B Limited  
(2)**



**OCR-B ISBN 10-Digit Book Numbers  
(6)**

## OCR-B Variant (continued)



OCR-B ISBN 10 or 13-Digit Book Numbers  
(7)



OCR-B Travel Document Version 1 (TD1)  
3 Line ID Cards  
(3)

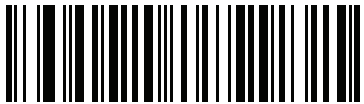

OCR-B Travel Document Version 2 (TD2)  
2-Line ID Cards  
(8)



Travel Document 2 or 3-Line ID Cards Auto-Detect  
(20)



OCR-B Passport  
(4)



OCR-B Visa Type A  
(9)



**OCR-B Variant (continued)**



**OCR-B Visa Type B  
(10)**



**OCR-B ICAO Travel Documents  
(11)**

## MICR E13B

### Parameter # 682

### SSI # F1h AAh

Scan one of the following barcodes to enable or disable MICR E13B.

MICR E 13B uses the following characters:

0 1 2 3 4 5 6 7 8 9 t a o d

TOAD characters (Transit, On Us, Amount, and Dash) output as the following representative characters:

t outputs as t

a outputs as a

o outputs as o

d outputs as d



**NOTES** 1 OCR is not as secure as a barcode. To decrease OCR misdecodes and speed OCR reading, set an accurate OCR template and character subset, and use a check digit. See [OCR Subset on page 346](#) and [OCR Template on page 348](#).

2. All OCR fonts are disabled by default.



Enable MICR E13B  
(1)



\*Disable MICR E13B  
(0)

## US Currency Serial Number

### Parameter # 683

### SSI # F1h ABh

Scan one of the following barcodes to enable or disable US Currency Serial Number.



**NOTES** 1 OCR is not as secure as a barcode. To decrease OCR misdecodes and speed OCR reading, set an accurate OCR template and character subset, and use a check digit. See [OCR Subset on page 346](#) and [OCR Template on page 348](#).

2. All OCR fonts are disabled by default.



**Enable US Currency  
(1)**

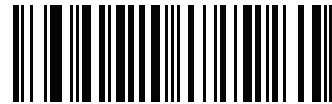

**\*Disable US Currency  
(0)**

## OCR Orientation

### Parameter # 687

### SSI # F1h AFh

Select one of five options to specify the orientation of the OCR to read:

- 0° to the imaging engine (default)
- 270° clockwise (or 90° counterclockwise) to the imaging engine
- 180° (upside down) to the imaging engine
- 90° clockwise to the imaging engine
- Omnidirectional

Setting an incorrect orientation can cause misdecodes.

## OCR Orientation (continued)



**\*OCR Orientation 0°  
(0)**



**OCR Orientation 270° Clockwise  
(1)**



**OCR Orientation 180° Clockwise  
(2)**



**OCR Orientation 90° Clockwise  
(3)**



**OCR Orientation Omnidirectional  
(4)**

## OCR Lines

### Parameter # 691

#### SSI # F1h B3h

To select the number of OCR lines to decode, scan one of the following barcodes. Selecting Visas, TD1, or TD2 ID cards automatically sets the appropriate **OCR Lines**. Also see [OCR-B Variant on page 338](#).



**\*OCR 1 Line  
(1)**

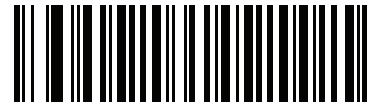

**OCR 2 Lines  
(2)**



**OCR 3 Lines  
(3)**

## OCR Minimum Characters

### Parameter # 689

#### SSI # F1h B1h

To select the minimum number of OCR characters (not including spaces) per line to decode, scan the following barcode, then scan a three-digit number between 003 and 100 using the barcodes in [Numeric Barcodes](#) representing the number of OCR characters to decode. Strings of OCR characters less than the minimum are ignored. The default is 003.



**OCR Minimum Characters**

## OCR Maximum Characters

### Parameter # 690

### SSI # F1h B2h

To select the maximum number of OCR characters (including spaces) per line to decode, scan the following barcode, then scan a three-digit number between 003 and 100 using the barcodes in [Numeric Barcodes](#) representing the number of OCR characters to decode. Strings of OCR characters greater than the maximum are ignored. The default is 100.

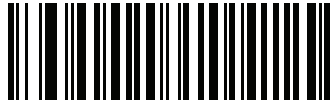

OCR Maximum Characters

## OCR Subset

### Parameter # 686

### SSI # F1h AEh

Create an OCR subset to define a custom group of characters in place of a preset font variant. For example, if scanning only numbers and the letters A, B, and C, create a subset of just these characters to speed decoding. This applies a designated OCR Subset across all enabled OCR fonts.

To set or modify the OCR font subset:

1. Enable the appropriate OCR font(s).
2. Scan the **OCR Subset** barcode.
3. Scan numbers and letters to form the OCR Subset from [Alphanumeric Barcodes](#).
4. Scan [End of Message on page 465](#).



OCR Subset

To cancel an OCR subset, for OCR-A or OCR-B, scan OCR-A variant **Full ASCII**, or OCR-B variant **Full ASCII**.

For MICR E13B or US Currency Serial Number, create a subset which includes all allowed characters in that character set, or scan an option from the [Default Parameters on page 142](#) and re-program the scanner.

## OCR Quiet Zone

### Parameter # 695

### SSI # F1h B7h

This option sets the OCR quiet zone. The scanner stops scanning a field when it detects a sufficiently wide blank space. The width of this space is defined by the End of Field option. Used with parsers that tolerate slanted characters, the End of Field count is approximately a count of 8 for a character width. For example, if set to 15, then two character widths are an end of line indicator for the parser. Larger end of field numbers require bigger quiet zones at each end of text line.

To set a quiet zone, scan the following barcode, then scan a two-digit number using the numeric keypad in [Alphanumeric Barcodes](#). The range of the quiet zone is 20 - 99 and the default is 50, indicating a six character width quiet zone.



OCR Quiet Zone

## OCR Template

### Parameter # 547

### SSI # F1h 23h

This option creates a template for precisely matching scanned OCR characters to a desired input format. Carefully constructing an OCR template eliminates scanning errors.

To set or modify the OCR decode template, scan the [OCR Template](#) barcode, and then scan barcodes on the following pages that correspond to numbers and letters to form the template expression. Then scan **End of Message**. The default is **99999999** which accepts OCR strings containing any character.

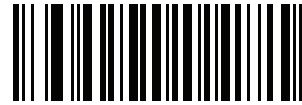

OCR Template



End of Message

### Required Digit (9)

Only a numeric character is allowed in this position.

Template	Valid data	Valid data	Invalid data
99999	12987	30517	123AB



9

### Required Alpha (A)

Only an alpha character is allowed in this position.

Template	Valid data	Valid data	Invalid data
AAAAA	ABCDE	UVWXY	12FGH





A

**Require and Suppress (0)**

Any character in this position, including space or reject, is suppressed from the output.

Template	Incoming data	Output
990AA	12QAB	12AB

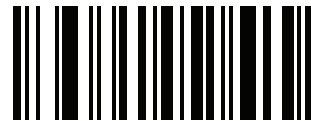

0

**Optional Alphanumeric (1)**

An alphanumeric character is accepted in this position if present. Optional characters are not allowed as the first character(s) in a field of like characters.

Template	Valid data	Valid data	Invalid data
99991	1234A	12345	1234<



1

**Optional Alpha (2)**

An alpha character is accepted in this position if present. Optional characters are not allowed as the first character(s) in a field of like characters.

Template	Valid data	Valid data	Invalid data
AAAA2	ABCDE	WXYZ	ABCD6



2

**Alpha or Digit (3)**

An alphanumeric character is required in this position to validate the incoming data.

Template	Valid data	Valid data	Invalid data
33333	12ABC	WXY34	12AB<



3

**Any Including Space & Reject (4)**

Any character is accepted in this position, including space and reject. An underscore ( \_ ) represents rejects in the output. This is a good selection for troubleshooting.

Template	Valid data	Valid data
99499	12\$34	34 98



4

**Any except Space & Reject (5)**

Any character is accepted in this position, except a space or reject.

Template	Valid data	Valid data	Invalid data
55999	A.123	*Z456	A BCD



5

### Optional Digit (7)

A numeric character is accepted if present. Optional characters are not allowed as the first character(s) in a field of like characters.

Template	Valid data	Valid data	Invalid data
99977	12345	789	789AB



7

### Digit or Fill (8)

Any numeric or fill character is accepted in this position.

Template	Valid data	Valid data	Valid data
88899	12345	>>789	<<789



8

### Alpha or Fill (F)

Any alpha or fill character is accepted in this position.

Template	Valid data	Valid data	Valid data
AAFF	ABCXY	LMN>>	ABC<5



F

### Optional Space ( )

A space is accepted if present. Optional characters are not allowed as the first character(s) in a field of like characters.

Template	Valid data	Valid data	Invalid data
99 99	12 34	1234	67891



Space

### Optional Small Special (.)

A special character is accepted if present. Optional characters are not allowed as the first character(s) in a field of like characters. Small special characters are - , and .

Template	Valid data	Valid data	Invalid data
AA.99	MN.35	XY98	XYZ12



.

### Other Template Operators

These template operators assist in capturing, delimiting, and formatting scanned OCR data.

#### Literal String (" and +)

Use either of these delimiting characters surrounding characters from the alphanumeric keyboard in [Alphanumeric Barcodes](#) to define a literal string within a template that must be present in scanned OCR data. There are two

characters used to delimit required literal strings; if one of the delimiter characters is present in the desired literal string, use the other delimiter.

Template	Valid data	Invalid data
"35+BC"	35+BC	AB+22



“



+

### New Line (E)

To create a template of multiple lines, add **E** between the template of each single line.

Template	Valid data	Valid data	Invalid data
999EAAAA	321	987	XYZW
	BCAD	ZXYW	12



E

### String Extract (C)

This operator combined with others defines a string of characters to extract from the scanned data. The string extract is structured as follows:

CbPe

Where:

- **C** is the string extract operator
- **b** is the string begin delimiter
- **P** is the category (one or more numeric or alpha characters) describing the string representation
- **e** is the string end delimiter

Values for *b* and *e* can be any scannable character. They are included in the output stream.

Template	Incoming data	Output
C>A>	XQ3>ABCDE>	>ABCDE>
	->ATHRUZ>123	>ATHRUZ>
	1ABCZXYZ	No Output



**C**

### Ignore to End of Field (D)

This operator causes all characters after a template to be ignored. Use this as the last character in a template expression. Examples for the template 999D:

Template	Incoming data	Output
999D	123-PED	123
	357298	357
	193	193



**D**

### Skip Until (P1)

This operator skips over characters until a specific character type or a literal string is detected. It can be used in two ways:

P1ct

Where:

- P1 is the Skip Until operator
- c is the type of character that triggers the start of output
- t is one or more template characters

P1"s"t

Where:

- P1 is the Skip Until operator

- "s" is one or more literal string characters (see [Literal String \(" and +\) on page 352](#)) that trigger the start of output
- t is one or more template characters

The trigger character or literal string is included in output from a Skip Until operator, and the first character in the template should accommodate this trigger.

Template	Incoming data	Output
P1"PN"AA9999	123PN9876	PN9876
	PN1234	PN1234
	X-PN3592	PN3592



P



1

### Skip Until Not (P0)

This operator skips over characters until a specific character type or a literal string is not matched in the output stream. It can be used in two ways:

P0ct

Where:

- P0 is the Skip Until Not operator
- c is the type of character that triggers the start of output
- t is one or more template characters

P0"s"t

Where:

- P0 is the Skip Until Not operator
- "s" is one or more literal string characters (see [Literal String \(" and +\) on page 352](#)) that trigger the start of output
- t is one or more template characters

The trigger character or literal string is not included in output from a Skip Until Not operator.

Template	Incoming data	Output
P0A9999	BPN3456	3456
	PN1234	1234
	5341	No output

Template	Incoming data	Output
P0"PN"9999	PN3456	3456
	5341	No output
	PNPN7654	7654



**P**



**0**

## Repeat Previous (R)

This operator allows a template character to repeat one or more times, allowing the capture of variable-length scanned data. The following examples capture two required alpha characters followed by one or more required digits:

Template	Incoming data	Output
AA9R	AB3	AB3
	PN12345	PN12345
	32RM52700	No output



**R**



## Scroll Until Match (S)

This operator steps through scanned data one character at a time until the data matches the template.

Template	Incoming data	Output
S99999	AB3	No Output
	PN12345	12345
	32RM52700	52700



S

## Multiple Templates

This feature sets up multiple templates for OCR decoding. To do this, follow the procedure described in [OCR Template on page 348](#) (scan the [OCR Template](#) barcode, and then barcodes corresponding to numbers and letters to form the template expression, and then **End of Message**) for each template in the multiple template string, using a capital letter **X** as a separator between templates.

For example, set the [OCR Template](#) as **99999XAAAAA** to decode OCR strings of either **12345** or **ABCDE**.

## Template Examples

Following are sample templates with descriptions of valid data for each definition.

Field Definition	Description
"M"99977	<b>M</b> followed by three digits and two optional digits.
"X"997777"X"	<b>X</b> followed by two digits, four optional digits, and an <b>X</b> .
9959775599	Two digits followed by any character, a digit, two optional digits, any two characters, and two digits.
A55"-"999"-"99	A letter followed by two characters, a dash, three digits, a dash, and two digits.
33A"."99	Two alphanumeric characters followed by a letter, a period, and two digits.
999992991	Five digits followed by an optional alpha, two digits, and an optional alphanumeric.
"PN98"	Literal field - <b>PN98</b>

## OCR Check Digit Modulus

### Parameter # 688

### SSI # F1h B0h

The check digit is the last digit (in the right-most position) in an OCR string and improves the accuracy of the collected data. This option sets OCR module check digit calculation. The calculation is performed on incoming data

to determine this check digit, based on the numeric weight of the alpha and numeric characters. See [OCR Check Digit Multiplier on page 358](#). If the incoming data does not match the check digit, the data is considered corrupt.

The selected check digit option does not take effect until you set [OCR Check Digit Validation on page 360](#).

To choose the Check Digit Modulus, such as 10 for Modulus 10, scan the following barcode, and then scan a three-digit number from 001 to 099 representing the check digit using the numeric keypad in [Alphanumeric Barcodes](#). The default is 1.



**OCR Check Digit**

## OCR Check Digit Multiplier

### Parameter # 700

#### SSI # F1h BCh

This option sets OCR check digit multipliers for character positions. For check digit validation, each character in scanned data has an assigned weight to use in calculating the check digit. The scanner OCR ships with the following weight equivalents:

0 = 0	A = 10	K = 20	U = 30
1 = 1	B = 11	L = 21	V = 31
2 = 2	C = 12	M = 22	W = 32
3 = 3	D = 13	N = 23	X = 33
4 = 4	E = 14	O = 24	Y = 34
5 = 5	F = 15	P = 25	Z = 35
6 = 6	G = 16	Q = 26	Space = 0
7 = 7	H = 17	R = 27	
8 = 8	I = 18	S = 28	
9 = 9	J = 19	T = 29	

All other characters are equivalent to one (1).

You can define the multiplier string if it is different from the default.

121212121212 (default)

123456789A (for ISBN, Product Add Right to Left. See [OCR Check Digit Validation on page 360](#))

For example:

ISBN	0	2	0	1	1	8	3	9	9	4	
Multiplier	10	9	8	7	6	5	4	3	2	1	
Product	0	18	0	7	6	40	12	27	18	4	
Product add	0+	18+	0+	7+	6+	40+	12+	27+	18+	4=	132

ISBN uses Modulus 11 for the check digit. In this case, 132 is divisible by 11, so it passes the check digit.

To set the check digit multiplier, scan the following barcode, and then scan numbers and letters to form the multiplier string from [Alphanumeric Barcodes](#). Then scan [End of Message on page 465](#).



**OCR Check Digit Multiplier**

## OCR Check Digit Validation

### Parameter # 694

### SSI # F1h B6h

Use the following options to protect against scanning errors by applying a check digit validation scheme.

#### None

No check digit validation, indicating no check digit is applied. This is the default.



**\*No Check Digit  
(0)**

#### Product Add Left to Right

Each character in the scanned data is assigned a numeric value (see [OCR Check Digit Multiplier on page 358](#)). Each digit representing a character in the scanned data is multiplied by its corresponding digit in the multiplier, and the sum of these products is computed. The check digit passes if this sum modulo Check Digit Modulus is zero.

Example:

Scanned data numeric value is 132456 (check digit is 6)

Check digit multiplier string is 123456

Digit	1	3	2	4	5	6	
Multiplier	1	2	3	4	5	6	
Product	1	6	6	16	25	36	
Product add	1+	6+	6+	16+	25+	36=	90

The Check Digit Modulus is 10. It passes because 90 is divisible by 10 (the remainder is zero).

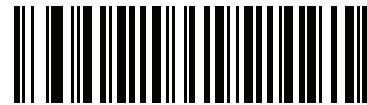

**Product Add Left to Right  
(3)**

### Product Add Right to Left

Each character in the scanned data is assigned a numeric value (see [OCR Check Digit Multiplier on page 358](#)). The check digit multiplier is reversed in order. Each value representing a character in the scanned data is multiplied by its corresponding digit in the reversed multiplier, resulting in a product for each character in the scanned data. The sum of these products is computed. The check digit passes if this sum modulo Check Digit Modulus is zero.

Example:

Scanned data numeric value is 132459 (check digit is 9)

Check digit multiplier string is 123456

Digit	1	3	2	4	5	9	
Multiplier	6	5	4	3	2	1	
Product	6	15	8	12	10	9	
Product add	6+	15+	8+	12+	10+	9=	60

The Check Digit Modulus is 10. It passes because 60 is divisible by 10 (the remainder is 0).



**Product Add Right to Left  
(1)**

### Digit Add Left to Right

Each character in the scanned data is assigned a numeric value (see [OCR Check Digit Multiplier on page 358](#)). Each value representing a character in the scanned data is multiplied by its corresponding digit in the multiplier, resulting in a product for each character in the scanned data. The sum of each individual digit in all of the products is then calculated. The check digit passes if this sum modulo Check Digit Modulus is zero.

Example:

Scanned data numeric value is 132456 (check digit is 6)

Check digit multiplier string is 123456

Digit	1	3	2	4	5	6	
Multiplier	1	2	3	4	5	6	
Product	1	6	6	16	25	36	
Digit add	1+	6+	6+	1+6+	2+5+	3+6=	36

The Check Digit Modulus is 12. It passes because 36 is divisible by 12 (the remainder is 0).



**Digit Add Left to Right  
(4)**

## Digit Add Right to Left

Each character in the scanned data is assigned a numeric value (see [OCR Check Digit Multiplier on page 358](#)). The check digit multiplier is reversed in order. Each value representing a character in the scanned data is multiplied by its corresponding digit in the reversed multiplier, resulting in a product for each character in the scanned data. The sum of each individual digit in all of the products is then calculated. The check digit passes if this sum modulo Check Digit Modulus is zero.

Example:

Scanned data numeric value is 132456 (check digit is 6)

Check digit multiplier string is 123456

Digit	1	3	2	4	5	6	
Multiplier	6	5	4	3	2	1	
Product	6	15	8	12	10	6	
Digit add	6+	1+5+	8+	1+2+	1+0+	6=	30

The Check Digit Modulus is 10. It passes because 30 is divisible by 10 (the remainder is 0).



**Digit Add Right to Left  
(2)**

## Product Add Right to Left Simple Remainder

Each character in the scanned data is assigned a numeric value (see [OCR Check Digit Multiplier on page 358](#)). The check digit multiplier is reversed in order. Each value representing a character in the scanned data is multiplied by its corresponding digit in the reversed multiplier, resulting in a product for each character in the scanned data. The sum of these products **except for the check digit's product** is computed. The check digit passes if this sum modulo Check Digit Modulus is equal to the check digit's product.

Example:

Scanned data numeric value is 122456 (check digit is 6)

Check digit multiplier string is 123456

Digit	1	2	2	4	5		6
Multiplier	6	5	4	3	2		1
Product	6	10	8	12	10		6
Product add	6+	10+	8+	12+	10=	46	6

The Check Digit Modulus is 10. It passes because 46 divided by 10 leaves a remainder of 6.



**Product Add Right to Left Simple Remainder  
(5)**

## Digit Add Right To Left Simple Remainder

Each character in the scanned data is assigned a numeric value (see [OCR Check Digit Multiplier on page 358](#)). The check digit multiplier is reversed in order. Each value representing a character in the scanned data is multiplied by its corresponding digit in the reversed multiplier, resulting in a product for each character in the scanned data. The sum of each individual digit in all of the products **except for the check digit's product** is then calculated. The check digit passes if this sum modulo Check Digit Modulus is equal to the check digit's product.

Example:

Scanned data numeric value is 122459 (check digit is 6)

Check digit multiplier string is 123456

Digit	1	2	2	4	5		9
Multiplier	6	5	4	3	2		1
Product	6	10	8	12	10		9
Digit add	6+	1+0+	8+	1+2+	1+0=	19	9

The Check Digit Modulus is 10. It passes because 19 divided by 10 leaves a remainder of 9.



**Digit Add Right to Left Simple Remainder  
(6)**

### Health Industry - HIBCC43

This is the health industry module 43 check digit standard. The check digit is the modulus 43 sum of all the character values in a given message, and is printed as the last character in a given message.

Example:

Supplier Labelling Data Structure: + A 1 2 3 B J C 5 D 6 E 7 1

Sum of values:  $41+10+1+2+3+11+19+12+5+13+6+14+7+1 = 145$

Divide 145 by 43. The quotient is 3 with a remainder of 16. The check digit is the character corresponding to the value of the remainder (see Table 33), which in this example is 16, or **G**. The complete Supplier Labeling Data Structure, including the check digit, therefore is:

A 1 2 3 B J C 5 D 6 E 7 1 G

**Table 33** Table of Numeric Value Assignments for Computing HIBC LIC Data Format Check Digit

0 = 0	9 = 9	I = 18	R = 27	- = 36
1 = 1	A = 10	J = 19	S = 28	. = 37
2 = 2	B = 11	K = 20	T = 29	Space = 38
3 = 3	C = 12	L = 21	U = 30	\$ = 39
4 = 4	D = 13	M = 22	V = 31	/ = 40
5 = 5	E = 14	N = 23	W = 32	+ = 41
6 = 6	F = 15	O = 24	X = 33	% = 42
7 = 7	G = 16	P = 25	Y = 34	
8 = 8	H = 17	Q = 26	Z = 35	



Health Industry - HIBCC43  
(9)



## Inverse OCR

### Parameter # 856

### SSI # F2h 58h

Inverse OCR is white or light words on a black or dark background. Select an option for decoding inverse OCR:

- **Regular Only** - Decode regular OCR (black on white) strings only.
- **Inverse Only** - Decode inverse OCR (white on black) strings only.
- **Autodiscriminate** - Decode both regular and inverse OCR strings.



**\*Regular Only**  
(0)



**Inverse Only**  
(1)



**Autodiscriminate**  
(2)

## OCR Redundancy

### Parameter # 1770

### SSI # F8h 06h EAh

This option adjusts the number of times to decode an OCR text string before transmission. There are three levels of OCR decode redundancy. There is an inverse relationship between the redundancy level and OCR decoding aggressiveness. Increasing the level of the redundancy can reduce OCR scanning aggressiveness, so select only the level of redundancy necessary.

- **OCR Redundancy Level 1:** This default setting allows the scanner to operate in its most aggressive state while providing sufficient accuracy in decoding most in-spec OCR text strings.
- **OCR Redundancy Level 2:** This setting eliminates most misdecodes while maintaining reasonable aggressiveness.
- **OCR Redundancy Level 3:** Select this option with greater redundancy requirements if OCR Redundancy Level 2 fails to eliminate misdecodes.



**\*OCR Redundancy Level 1**  
(1)



**OCR Redundancy Level 2**  
(2)



**OCR Redundancy Level 3**  
(3)

# Intelligent Document Capture (IDC)

---

## Introduction

Intelligent Document Capture (IDC) is Zebra advanced image processing firmware for select imager based scanners. This chapter describes the IDC functionality, provides parameter barcodes to control IDC features, and includes a quick start procedure.

---

## The IDC Process

Intelligent Document Capture:

1. Verifies a barcode is appropriate to use as an IDC anchor or link. See [Barcode Acceptance Test](#).
2. Determines the rectangular region to capture as an image. See [Capture Region Determination on page 368](#).
3. Processes the captured image. See [Image Post Processing on page 369](#).
4. Transmits the data. See [Data Transmission on page 369](#).

## Barcode Acceptance Test

Upon decoding a barcode, the scanner checks that the barcode fits the description of a barcode that anchors or links to an IDC form. To be accepted as an IDC barcode:

- The symbology must be enabled for decode, and also enabled via [IDC Symbology on page 373](#). The IDC firmware allows enabling between zero and eight symbologies simultaneously: Code 128, Code 39, Interleaved 2 of 5, Discrete 2 of 5, Codabar, PDF417, Data Matrix, and EAN-128.
- The decoded data must satisfy the values set in the [IDC Minimum Text Length](#) and [IDC Maximum Text Length](#) parameters. To disable either of these checks, set the value to zero.

If the barcode does not satisfy both requirements, it is sent as a normal (non-IDC) decode.

An IDC barcode is required when [IDC Operating Mode on page 372](#) is set to **Anchored** or **Linked**.

**Free-Form** operating mode does not require a barcode, but transmits decoded data if one is found and satisfies the requirements. If no barcode is decoded, the document capture process starts but may require specifying a non-zero value for the [IDC Delay Time on page 383](#). The scanner must wait for at least this amount of time after trigger pull before capturing a document, unless a barcode is decoded before the time expires.

If [Picklist Mode on page 162](#) is enabled, the barcode must be directly under the aiming pattern and within the scanner's decode range, and the region to capture must be completely within the scanner's field-of-view.

## Capture Region Determination

After accepting an IDC barcode, the firmware establishes the region to capture as an image. The method used depends on the setting of the [IDC Operating Mode](#) as follows.

The IDC firmware emits a single low beep after successfully capturing a region. The scanner is then no longer capturing images and can be moved without disturbing the IDC output. Be sure to hold the trigger button until the decode beep, otherwise the IDC process may be aborted.

### IDC Operating Mode = Anchored

A coordinate system is built based on the barcode in its rectified (de-skewed) form. The origin is the center of the barcode, and the x-axis is set toward the right, from the barcode's point of view. The unit module width of the barcode is the unit for x. Similarly, the y-axis is set toward the up direction. The unit for the y-axis is specified via the parameter [IDC Aspect on page 376](#). This is the aspect ratio of a thin bar or space - the barcode's height is divided by this value to get this unit. Set [IDC Aspect](#) to zero to automatically calculate the aspect ratio. The barcode can be of different sizes for the same form, as long as the center of the barcode is the same when the barcode's length changes.

From this coordinate system, the IDC area is determined using four parameters: offsets in x and y ([IDC X Coordinate](#), [IDC Y Coordinate](#)) to the region's top-left corner, and width and height ([IDC Width](#), [IDC Height](#)).

If the capture area is relatively large as compared to the barcode area, the calculation to obtain the capture area is prone to significant errors. A recommended solution is to enclose the form with a single black-lined rectangular border (a box), which is not in contact with any other line on the outside of the form (although it can be connected to lines on the inside of the form). When the [IDC Find Box Outline](#) is set, the firmware searches for the box, and does not decode if any edges are broken (such as by a protruding thumb).

The [IDC Zoom Limit](#) parameter controls the quality of the captured form. The IDC firmware rejects capturing a form unless the width is at least the [IDC Zoom Limit](#) percentage of the [IDC Width](#) parameter. For example, if [IDC Zoom Limit](#) is set to 100 and [IDC Width](#) is set to 150, the form must be at least 300 pixels wide before it is captured (each unit module is scaled to two pixels).

The [IDC Maximum Rotation](#) parameter controls the maximum rotation any edge of the form can have in relation to the scanner's horizontal or vertical axis.

## IDC Operating Mode = Free-Form or Linked

The document capture region is a rectangular piece of paper, or a portion of it enclosed by a rectangular border. In either case, all four sides of the capture region must be completely within the scanner's field-of-view, and there must be sufficient contrast at the border of the capture region. For example, if a piece of white paper contains the document to capture, it must be put in front of a dark background.

By default, the scanner captures the largest rectangular region within the field-of-view. To specify a particular border type, use the [IDC Border Type](#) parameter.

The region must contain at least 10% of the field-of-view in two dimensions.

If an IDC barcode is decoded, IDC uses its location to start the search for the capture region. Otherwise, it searches the capture region from the center of the field-of-view. IDC also uses the orientation of a decoded IDC barcode to orient the output image.

## Image Post Processing

After determining the document capture region, the firmware de-skews and re-samples the region as follows. Enabling [IDC Captured Image Brighten](#) calls normalization, which makes the brightness of the image uniform, and enhances contrast as a large percent of background pixels is made completely white (a smaller percent of pixels is made completely black if the firmware determines there is no danger of enhancing the contrast of a very bland area). Enabling [IDC Captured Image Sharpen](#) enhances the sharpness of the image.

IDC re-samples the image about one output pixel per input pixel for **Free-Form** or **Linked** modes and two pixels-per-module in **Anchored** mode.

IDC compresses and transmits the image in one of the standard image formats selected by the [IDC File Format Selector](#), [IDC Bits Per Pixel](#), and [IDC JPEG Quality](#) parameters.

Note that it may take several seconds for post processing to complete, depending on the size of the captured region, the options enabled, and the scanner model.

## Data Transmission

After processing the captured image, IDC assembles the image with the decoded barcode data (if applicable) into an ISO/IEC 15434 style packet and transmits it to the host. The scanner issues the standard decode beep and the trigger can be released. Be sure to set the [USB Device Type on page 62](#) to **Symbol Native API (SNAPI) with Imaging Interface**.

---

## PC Application and Programming Support

For a sample application running on the Microsoft Windows operating system, contact your Zebra representative. This application displays barcode data and/or captured images from Intelligent Document Capture enabled scanners and allows setting and reading IDC parameters. Complete source code and documentation are also provided for developing custom applications. The application includes documentation for the ISO/IEC 15434 format as used by the IDC firmware and C# code to process it.

---

## Setting Parameters

This section describes the parameters controlling the IDC firmware and provides programming barcodes for setting them.

The scanner ships with the settings shown in [Table 34 on page 371](#) (also see [Standard Parameter Defaults](#) for all defaults). If the default values suit requirements, programming is not necessary.

To set feature values, scan a single barcode or a short barcode sequence. The settings are stored in non-volatile memory and are preserved even when the imager powers down.



**NOTE:** Most computer monitors allow scanning barcodes directly on the screen. When scanning from the screen, be sure to set the document magnification to a level where you can see the barcode clearly, and bars and/or spaces do not merge.

To return all features to default values, scan the [Set Factory Defaults on page 142](#). Throughout the programming barcode menus, asterisks (\*) indicate default values.

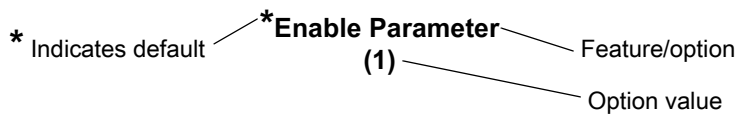
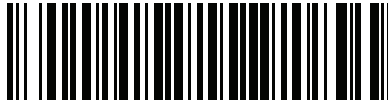

## Scanning Sequence Examples

In most cases scanning one barcode sets the parameter value. For example, to set the document capture file format to BMP, scan the **BMP** barcode under [IDC File Format Selector on page 376](#). The scanner issues a fast warble beep and the LED turns green, signifying a successful parameter entry.

Other parameters require scanning several barcodes. See the parameter descriptions for this procedure.

## Errors While Scanning

Unless otherwise specified, to correct an error during a scanning sequence, just re-scan the correct parameter.

## Image Document Capture Parameter Defaults

Table 34 lists defaults for IDC parameters. Change these values in one of two ways:

- Scan the appropriate barcodes in this chapter. The new value replaces the standard default value in memory. To recall default parameter values, see [Default Parameters on page 142](#).
- Configure the scanner using the 123Scan configuration program. See [123Scan and Software Tools](#).



**NOTE:** See [Standard Parameter Defaults](#) for all user preference, host, symbology, and miscellaneous default parameters.

Alternatively, use the sample application to set parameters using the parameter name. The application provides prompts and error checking to assist in setting the parameters correctly and easily. You must use an application to set a parameter to a negative value, as the [IDC X Coordinate](#) can require.

**Table 34** Intelligent Document Capture (IDC) Parameter Defaults

Parameter	Parameter Name	Parameter Number <sup>1</sup>	SSI Number <sup>2</sup>	Default	Page Number
<b>Intelligent Document Capture (IDC) Parameters</b>					
IDC Operating Mode	DocCap_MODE	594	F1h 52h	Off	<a href="#">372</a>
IDC Symbology	DocCap_SYMBLOGY	655	F1h 8Fh	001	<a href="#">373</a>
IDC X Coordinate	DocCap_X	596	F4h F1h 54h	-151	<a href="#">374</a>
IDC Y Coordinate	DocCap_Y	597	F4h F1h 55h	-050	<a href="#">374</a>
IDC Width	DocCap_WIDTH	598	F1h 56h	0300	<a href="#">375</a>
IDC Height	DocCap_HEIGHT	599	F1h 57h	0050	<a href="#">375</a>
IDC Aspect	DocCap_ASPECT	595	F1h 53h	000	<a href="#">376</a>
IDC File Format Selector	DocCap_FMT	601	F1h 59h	JPEG	<a href="#">376</a>
IDC Bits Per Pixel	DocCap_BPP	602	F1h 5Ah	8 BPP	<a href="#">377</a>
IDC JPEG Quality	DocCap_JPEG_Qual	603	F1h 5Bh	065	<a href="#">378</a>
IDC Find Box Outline	Sig_FINDBOX	727	F1h D7h	Disable	<a href="#">378</a>
IDC Minimum Text Length	DocCap_MIN_TEXT	656	F1h 90h	00	<a href="#">379</a>
IDC Maximum Text Length	DocCap_MAX_TEXT	657	F1h 91h	00	<a href="#">379</a>
IDC Captured Image Brighten	Sig_BRIGHTEN	654	F1h 8Eh	Enable	<a href="#">380</a>
IDC Captured Image Sharpen	Sig_SHARPEN	658	F1h 92h	Enable	<a href="#">381</a>
IDC Border Type	DocCap_BORDER	829	F2h 3Dh	None	<a href="#">382</a>
IDC Delay Time	DocCap_DELAY	830	F2h 3Eh	000	<a href="#">383</a>
IDC Zoom Limit	Sig_MIN_PERCENT	651	F1h 8Bh	000	<a href="#">383</a>
IDC Maximum Rotation	Sig_MAX_ROT	652	F1h 8Ch	00	<a href="#">384</a>

1. Parameter number decimal values are used for programming via RSM commands.

2. SSI number hex values are used for programming via SSI commands.

## IDC Operating Mode

Parameter Name: DocCap\_MODE

Parameter # 594

SSI # F1h 52h

Select the operating mode of the Intelligent Document Capture firmware:

- **Off** - Disables the IDC feature.
- **Anchored** - Requires a barcode decode. The image capture region is based off this barcode.
- **Free-Form** - A printed border or page edge defines the image capture region. A barcode is optional.
- **Linked** - A printed border or page edge defines the image capture region. A barcode is required.



\*Off  
(0)



Anchored  
(1)

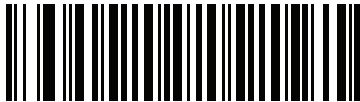

Free-Form  
(2)



Linked  
(3)



## IDC Symbology

**Parameter Name: DocCap\_SYMBOLOGY**

**Parameter # 655**

**SSI # F1h 8Fh**

Select the barcode type(s) to use when Document Capture mode is not set to **Off**. To enable more than one symbology at a time, simply add the values together. For example, to enable PDF417, Data Matrix, and Code 39 write a value of 98 (32 + 64 + 2).

Scan the following barcode, and then scan three barcodes from [Numeric Barcodes](#) in the range of 000 to 255 decimal. The default is 001.

**Table 35** IDC Symbologies

Symbology	Value (Decimal)
Code 128	1
Code 39	2
I 2 of 5	4
D 2 of 5	8
Codabar	16
PD 417	32
Data Matrix	64
EAN 128	128
Aztec	256



**IDC Symbology**

## IDC X Coordinate

**Parameter Name: DocCap\_X**

**Parameter # 596**

**SSI # F4h F1h 54h**

This parameter only applies when [IDC Operating Mode](#) is set to **Anchored**. Specify the horizontal offset to the top left corner of the region to capture relative to the center of the barcode. Negative values move toward the left.

Scan the following barcode, and then scan four barcodes from [Numeric Barcodes](#) in the range of +/- 1279. The default is -151. Note that you must use an application to set a negative value.



**IDC X Coordinate**

## IDC Y Coordinate

**Parameter Name: DocCap\_Y**

**Parameter # 597**

**SSI # F4h F1h 55h**

This parameter only applies when [IDC Operating Mode](#) is set to **Anchored**. Specify the vertical offset to the top left corner of the region to capture relative to the center of the barcode. Negative values move toward the top.

Scan the following barcode, and then scan four barcodes from [Numeric Barcodes](#) in the range of +/- 1023. The default is -050. Note that you must use an application to set a negative value.



**IDC Y Coordinate**

## IDC Width

**Parameter Name: DocCap\_WIDTH**

**Parameter # 598**

**SSI # F1h 56h**

This parameter only applies when [IDC Operating Mode](#) is set to **Anchored**. Specify the width of the region to capture.

Scan the following barcode, and then scan four barcodes from [Numeric Barcodes](#) in the range of 0000 to 1279. The default is 0300.



IDC Width

## IDC Height

**Parameter Name: DocCap\_HEIGHT**

**Parameter # 599**

**SSI # F1h 57h**

This parameter only applies when [IDC Operating Mode](#) is set to **Anchored**. Specify the height of the region to capture.

Scan the following barcode, and then scan four barcodes from [Numeric Barcodes](#) in the range of 0000 to 1279. The default is 0050.



IDC Height

## IDC Aspect

**Parameter Name: DocCap\_ASPECT**

**Parameter # 595**

**SSI # F1h 53h**

This parameter only applies when [IDC Operating Mode](#) is set to **Anchored**. Specify the barcode's aspect ratio of a thin bar or space. The barcode's height is divided by this value to obtain the unit in the y-axis. Set this parameter to zero to calculate the aspect value automatically.

Scan the following barcode, and then scan three barcodes from [Numeric Barcodes](#) in the range of 000 to 255. The default is 000.



**IDC Aspect**

## IDC File Format Selector

**Parameter Name: DocCap\_FMT**

**Parameter # 601**

**SSI # F1h 59h**

Select a document capture file format appropriate for your system (BMP, TIFF, or JPEG). The scanner stores captured areas in the selected format.

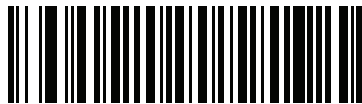

**\*JPEG  
(1)**



**BMP  
(3)**



**TIFF  
(4)**

## IDC Bits Per Pixel

Parameter Name: DocCap\_BPP

Parameter # 602

SSI # F1h 5Ah

Select the number of significant bits per pixel (BPP) to use when capturing an image. Select 1 BPP for a black and white image, 4 BPP to assign 1 of 16 levels of grey to each pixel, or 8 BPP to assign 1 of 256 levels of grey to each pixel.



**NOTE:** The scanner ignores these settings for JPEG file formats, which only support 8 BPP.



**1 BPP**  
(0)



**4 BPP**  
(1)



**\*8 BPP**  
(2)

## IDC JPEG Quality

**Parameter Name: DocCap\_JPEG\_Qual**

**Parameter # 603**

**SSI # F1h 5Bh**

Set the amount of JPEG compression to perform on the captured image. Higher numbers produce a better quality image but larger files.

Scan the following barcode, and then scan three barcodes from [Numeric Barcodes](#) in the range of 005 to 100 decimal. The default is 065.



**IDC JPEG Quality**

## IDC Find Box Outline

**Parameter Name: Sig\_FINDBOX**

**Parameter # 727**

**SSI # F1h D7h**

This parameter only applies when [IDC Operating Mode](#) is set to **Anchored**. Scan **Enable Find Box Outline** to search for a rectangular border during document capture.



**Enable Find Box Outline  
(1)**



**\*Disable Find Box Outline  
(0)**

## IDC Minimum Text Length

**Parameter Name: DocCap\_MIN\_TEXT**

**Parameter # 656**

**SSI # F1h 90h**

Specify the minimum number of characters encoded in a barcode for the IDC firmware to use it as an anchored or linked barcode. Set this to zero (the default) to disable all checking and use all barcodes.

Scan the following barcode, and then scan two barcodes from [Numeric Barcodes](#) in the range of 00 to 55 decimal. The default is 00.



**IDC Minimum Text Length**

## IDC Maximum Text Length

**Parameter Name: DocCap\_MAX\_TEXT**

**Parameter # 657**

**SSI # F1h 91h**

Specify the maximum number of characters encoded in a barcode for the IDC firmware to use it as an anchored or linked barcode. Set this to zero (the default) to disable all checking and use all barcodes.

Scan the following barcode, and then scan two barcodes from [Numeric Barcodes](#) in the range of 00 to 55 decimal. The default is 00.



**IDC Maximum Text Length**

## IDC Captured Image Brighten

**Parameter Name: Sig\_BRIGHTEN**

**Parameter # 654**

**SSI # F1h 8Eh**

Enable **Captured Image Brighten** to make image brightness uniform and enhance contrast such that a large percent of the background pixels is made completely white (a smaller percent of pixels is made completely black if the program determines there is no danger of enhancing the contrast of a very bland area).



**NOTE:** This parameter is also used for Signature Capture.



**\*Enable Captured Image Brighten  
(1)**



**Disable Captured Image Brighten  
(0)**



## IDC Captured Image Sharpen

Parameter Name: Sig\_SHARPEN

Parameter # 658

SSI # F1h 92h

Enable this to enhance the sharpness of the image.



**NOTE:** This parameter is also used for Signature Capture.



**\*Enable Captured Image Sharpen  
(1)**



**Disable Captured Image Sharpen  
(0)**

## IDC Border Type

Parameter Name: DocCap\_BORDER

Parameter # 829

SSI # F2h 3Dh

This parameter only applies when [IDC Operating Mode](#) is set to **Free-Form** or **Linked**. Select the style of border used to determine the outline of the capture region:

- **None** - Capture the largest rectangular region within the field-of-view.
- **Black** - The border must be black (such as a printed rectangular border).
- **White** - The border must be white (e.g., paper edge on a dark background).
- **Advanced Edge Detection (AED)** - Capture a region defined by edges of any color and potentially broken.

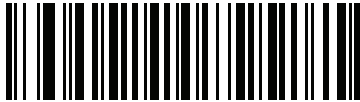

**\*None**  
(0)



**Black**  
(1)



**White**  
(2)



**Advanced Edge Detection (AED)**  
(3)

## IDC Delay Time

**Parameter Name: DocCap\_DELAY**

**Parameter # 830**

**SSI # F2h 3Eh**

This parameter only applies when [IDC Operating Mode](#) is set to **Free-Form**. Set the delay for capturing a document after a trigger pull. Decoding a barcode aborts this delay.

Scan the following barcode, and then scan three barcodes from [Numeric Barcodes](#) in the range of 000 to 200 decimal in units of 10 msec. The default is 000.



IDC Delay Time

## IDC Zoom Limit

**Parameter Name: Sig\_MIN\_PERCENT**

**Parameter # 651**

**SSI # F1h 8Bh**

This parameter only applies when [IDC Operating Mode](#) is set to **Anchored**. Set the minimal "zoom" percentage value of a form for it to be considered for capture. This controls the quality of the captured form. The IDC firmware rejects capturing a form unless the width is at least the [IDC Zoom Limit](#) percentage of the [IDC Width](#) parameter. For example, if you set this parameter to 100 and [IDC Width](#) to 150, the form must be at least 300 pixels wide before it is captured (each unit module is scaled to two pixels).

Set this to zero (the default) to disable all checking.

Scan the following barcode, and then scan three barcodes from [Numeric Barcodes](#) in the range of 000 to 100 percent. The default is 000.



IDC Zoom Limit

## IDC Maximum Rotation

**Parameter Name: Sig\_MAX\_ROT**

**Parameter # 652**

**SSI # F1h 8Ch**

This parameter only applies when [IDC Operating Mode](#) is set to **Anchored**. Set the maximum rotation any edge of the form can have in relation to the scanner's horizontal or vertical axis for it to be considered for capture. Set this to zero (the default) to disable all checking.

Scan the following barcode, and then scan two barcodes from [Numeric Barcodes](#) in the range of 00 to 45 decimal. The default is 00.



**IDC Maximum Rotation**

## Quick Start

This section familiarizes you with some of the Intelligent Document Capture features. [IDC Demonstrations on page 386](#) includes instructions to demonstrate the Anchored, Free-Form, and Linked modes using a sample form to provide an understanding of how to use IDC. These examples do not illustrate all capabilities of the advanced IDC firmware. Build upon these using different parameter settings and forms.

## Sample IDC Setup

To set up IDC:

1. Connect a scanner equipped with IDC to the host computer's USB port.
2. To set the scanner to the default settings and proper USB host type, scan **Set Defaults** followed by the **Symbol Native API (SNAPI) with Imaging Interface** barcode. Allow time for the scanner to reset and the USB connection to remunerate after each scan before continuing.



**Set Defaults**



**Symbol Native API (SNAPI) with Imaging Interface**

3. Start the sample application and select the scanner in the **SNAPI Scanners** drop-down menu.
4. Set parameters as specified in [IDC Demonstrations on page 386](#) using the sample application or by scanning parameter barcodes in this guide. The barcode in the sample form is Code 128, which is enabled by default for decoding and as a Document Capture symbology. You can change these settings for your IDC application.
5. Perform each demo. When scanning, aim the scanner at the barcode in the center of the rectangle. Pull the scanner back so the rectangle is fully contained in the aiming pattern. When you pull the trigger, the scanner emits a low tone to indicate that the IDC firmware identified and captured an image, then a decode beep to indicate that the data transmitted. There may be several seconds between the two beeps, depending on the size of the captured image and options selected (de-skew, brighten, etc). You can move the scanner after the first beep, but continue to hold the trigger or the scanner may end the session before sending the data.

## IDC Demonstrations

### Anchored Mode Demo

- Set [IDC Operating Mode on page 372](#) to **Anchored**.
- Set parameters to these values:
  - Set [IDC Height on page 375](#) to **100**.
  - Set [IDC Width on page 375](#) to **90**.
  - Set [IDC X Coordinate on page 374](#) to **-175**.
  - Set [IDC Y Coordinate on page 374](#) to **-50**.
- Pull the trigger. The scanner decodes the barcode and captures an image of the text scroll.
- Rotate the form clockwise so the word **Capture** is along the bottom edge, and pull the trigger. The scanner decodes the barcode and captures the same image, including orientation. (This example also works with the form rotated counter-clockwise or upside down).
- Modify the values for height, width, x, and y. Pull the trigger. The captured area changes in size and location.
- Cover the barcode with a small piece of paper (or your finger) and pull the trigger. The scanner does not decode the barcode or capture an image.

#### What This Demonstrates

Anchored mode captures an image of fixed size and location relative to a barcode on the page. Parameters control the height, width, and location. The IDC firmware requires that a barcode is present in order to capture an image. It decodes the barcode and uses it to adjust the image to the upright orientation.

### Free-Form Mode Demo

- Set [IDC Operating Mode on page 372](#) to **Free-Form**.
- Pull the trigger. The scanner decodes the barcode and captures an image of the entire rectangle, including the contents.
- Modify the values for height, width, x, and y. Pull the trigger. Note that the captured image is not affected.
- Rotate the form clockwise so the word **Capture** is along the bottom edge, and pull the trigger. The scanner decodes the barcode and captures the same image, including orientation. (This example also works with the form rotated counterclockwise or upside down).
- Cover the barcode with a small piece of paper and pull the trigger. The scanner does not decode the barcode and does not re-orient the captured image to the normal position, i.e., with the logo in the upper-left corner.

#### What This Demonstrates

Free-Form mode captures an image where a rectangular border on the page determines the size and position. It adjusts the image to the upright orientation if a barcode is found and decoded in the image.

### Linked Mode Demo

Set [IDC Operating Mode on page 372](#) to **Linked**.

Use the examples from the [Free-Form Mode Demo](#), noting that the last item (covering the barcode) does not decode the barcode or capture an image.

**What This Demonstrates**

Linked mode captures an image where a rectangular border on the page determines the size and position. The IDC firmware requires that a barcode is present in order to capture an image. It decodes the barcode and uses it to adjust the image to the upright orientation.

**Other Suggestions**

Hold the scanner at an angle (up/down or side to side) to the page instead of perpendicular to it. The IDC firmware de-skews and adjusts the brightness (enabled by default) to produce a quality image when the scanner is held at less than ideal conditions.

**Quick Start Form**

Figure 18 Quick Start Form

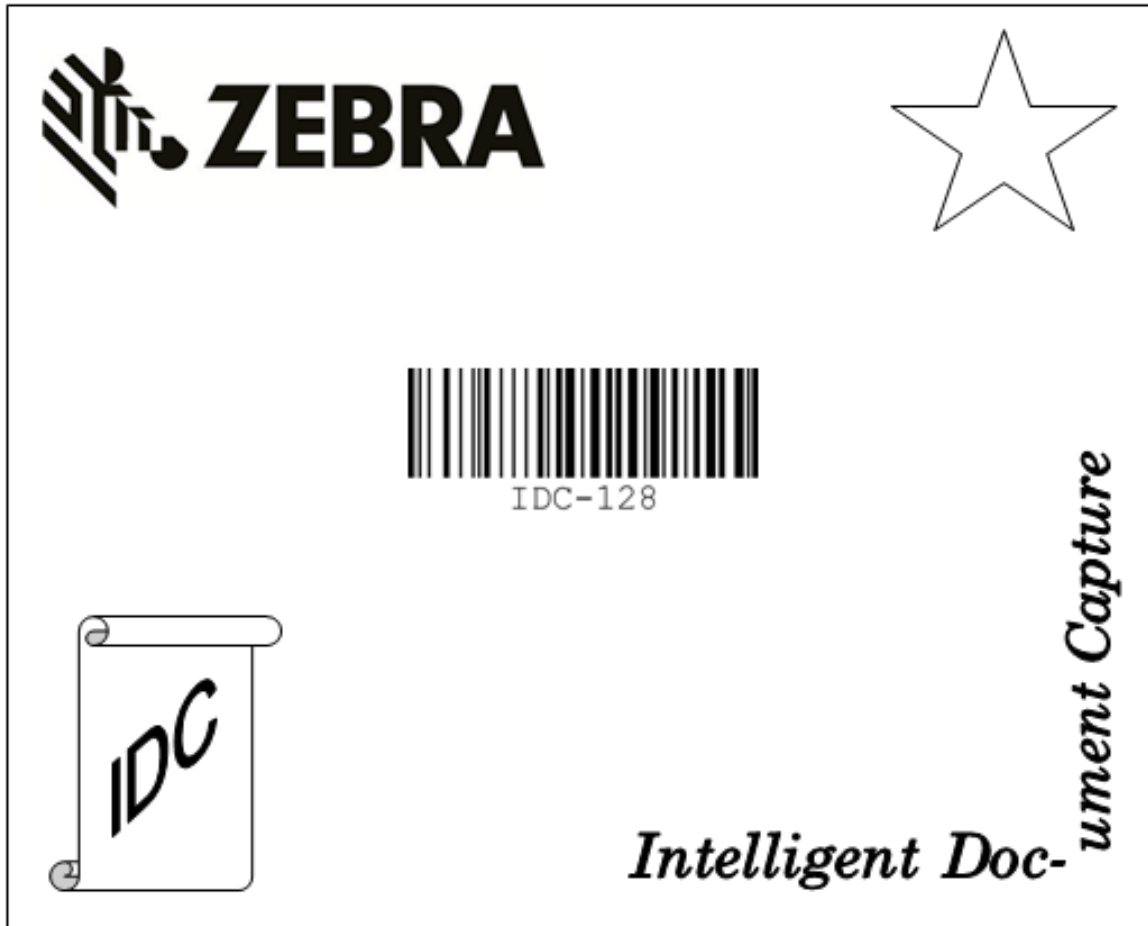

# Data Formatting: ADF, MDF, Preferred Symbol

---

## Introduction

This chapter briefly describes the Zebra features available for customizing scanner operation.

---

## Advanced Data Formatting (ADF)

Advanced Data Formatting (ADF) allows customizing data before transmission to the host device. Use ADF to edit scanned data to suit the host application's requirements. With ADF you scan one barcode per trigger pull. ADF is programmed using 123Scan.

For a video on Creating an Advanced Data Formatting (ADF) Rule using 123Scan, go to: [www.zebra.com/ScannerHowToVideos](http://www.zebra.com/ScannerHowToVideos).

For additional information, refer to the Advanced Data Formatting Programmer Guide.

---

## Multicode Data Formatting

Multicode Data Formatting (MDF) enables a 2D scanner to scan all barcodes on a label with a single trigger pull, and then modify and transmit the data to meet host application requirements. MDF supports programming up to nine unique labels into one scanner. MDF also supports scanning multiple barcodes on opposite sides of a box by holding the trigger.

Programming options include:

- Output all or specific barcodes
- Control the barcode output sequence
- Apply unique multicode data formatting (MDF) to each output barcode
- Discard scanned data if all required barcodes are not present

For more information, refer to the *MDF and Preferred Symbol User Guide*.

To watch a video on Creating an Multicode Data Formatting (MDF) Rule using 123Scan, go to: [www.zebra.com/ScannerHowToVideos](http://www.zebra.com/ScannerHowToVideos)



## MDF in Hands-Free Mode

MDF in a hands-free scanning mode may yield multiple unexpected and undesired outputs when a label (most likely on a complex label) passes through the scanner's field of view. This problem happens when the complex label's barcodes can be matched by more than one group (for example, Group 1 represents all barcodes present and Group 2 represent some barcodes present).



**NOTE:** A similar problem can also occur in the hand-held trigger mode. If multiple MDF rules/groups exist and all the label is not in the field of view when pressing the trigger, the output may vary depending on which MDF rules/groups match.

The problem is demonstrated in [Figure 19](#) and as follows:

1. As the label is moving through the field of view, it is first partially read (some of the barcodes in the field of view in Frame 2).
2. Then, the second decode occurs as it is fully read (all the barcodes in the field of view in Frame 3).
3. This yields two different outputs (instead of the expected single output) from the presentation of a label. This problem is driven by a complex label inadvertently matching two different MDF rules/groups, thereby yielding two outputs.

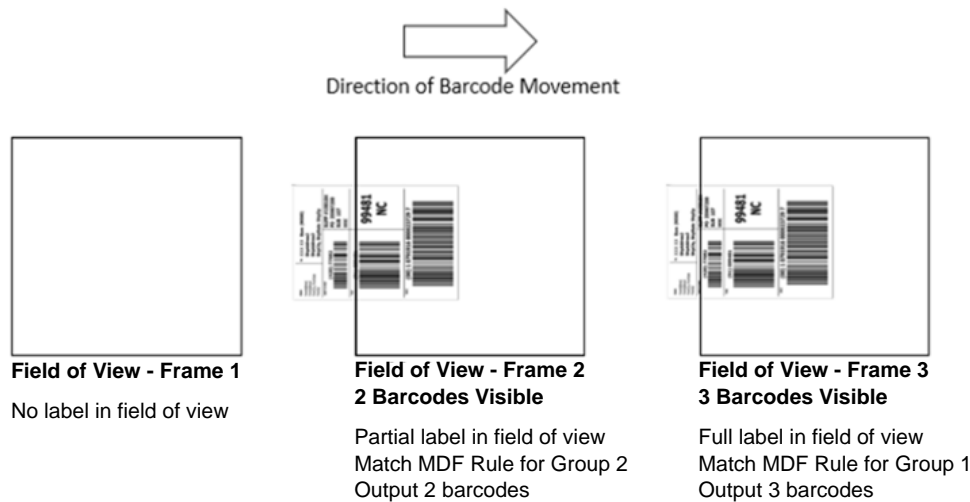

**Figure 19** Scanning Label in a Horizontal Orientation



**NOTE:** To minimize issues associated with MDF hands-free mode, see [MDF Best Practices on page 390](#).

## MDF Best Practices

Suggestions to minimize the undesired multiple outputs during the MDF scanning in hands-free mode are as follows:

- Scan barcodes in a vertical orientation (see [Figure 20](#)).

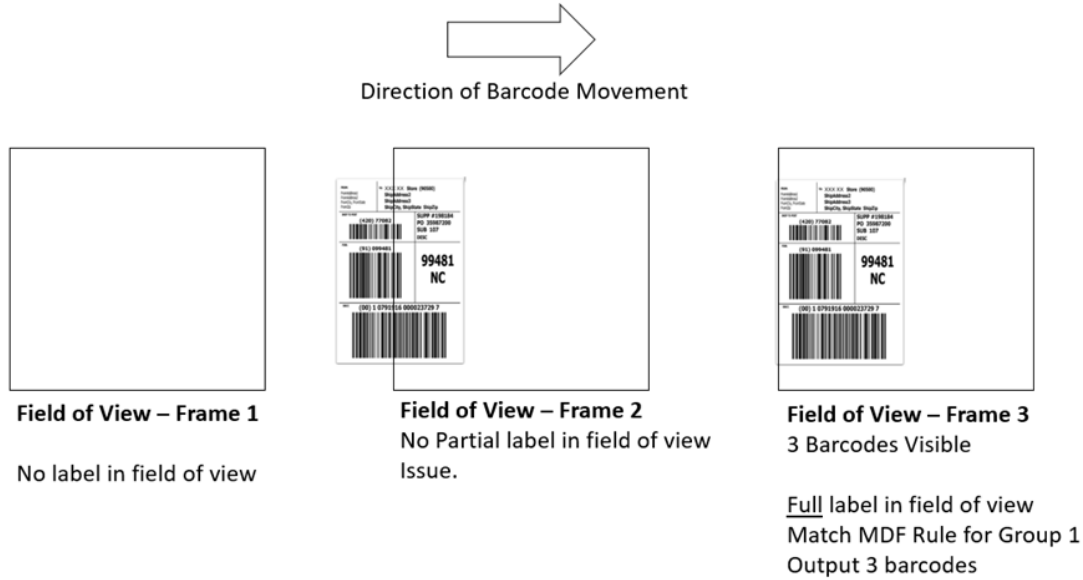

**Figure 20** Scanning Label in a Vertical Orientation

- When creating the MDF programming with multiple groups, the Group 1's pattern match should be the most complicated (hardest to match), which equals to the most number of barcodes and criteria. Then Group 2, 3, and so on should be progressively matched more easily.
- When defining criteria, avoid enabling an output when the pattern is not matched. Set **Output if NO pattern match set** as **Discard bar code** (see [Figure 21](#)).

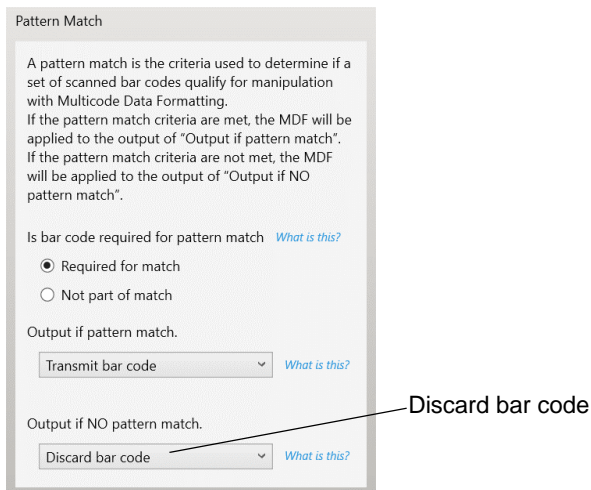

**Figure 21** Figure Match Setting for Output

- Select **Discard barcode(s) NOT within the pattern match** in the 123Scan MDF setting. For more details, select **What is this?** located next to this selection.

Discard scanned bar code(s) NOT within pattern match [What is this?](#)

- To prevent double decodes of the same symbol, increase the **Timeout Between Same Symbols** setting. See [Timeout Between Decodes, Same Symbol on page 166](#) for more details.
- Turn the scanner's aimer on to assist operators in scanning the barcode in a more consistent manner.
- Other reasons a label/barcode may not be decoded while in the field of view are as follows:
- The label out of focus (too close or too far away). See [Decode Ranges on page 41](#) for correct working range.
- Specular reflection (reflection off a shiny surface).
- The label is presented at extreme angle to scanner.

---

## Preferred Symbol

Preferred Symbol is a barcode prioritization technique that enables favored decoding of high priority barcode(s). The Preferred Symbol is the only barcode that is decoded and output within the preset Preferred Symbol Timeout. During this time, the scanner attempts to decode the prioritized barcode and reports only this barcode.

For more information, refer to the Multicode Data Formatting and Preferred Symbol User Guide, p/n MN-002895-xx.

To program Preferred Symbol via 123Scan, select 123Scan > Configuration Wizard > Symbologies screen, and then select Preferred Symbol from the drop-down menu. Preferred Symbol programming is saved in the 123Scan configuration file.

---

## Data Parsing (UDI Scan+, Label Parse+ and Blood Bag Parse+)

Data Parsing allows a Zebra scanner to scan a UDI label, GS1 label, or Blood Bags with one or more barcodes encoded with multiple data fields (such as date of manufacture, expiration date, batch number, GTIN, and SSCC) and transmit select data fields and not others, in a specific order to a host application. Simply wave the scanner over all the barcodes while holding the trigger and the scanner takes care of the rest.

The scanner finds and transmits only the required data fields, even if they are spread across multiple barcodes and on different sides of the container. In addition, the scanner can insert field separators (such as tab, enter, and slash) to automate data entry into a host application.

Programming your scanner is easy using 123Scan's intuitive drag and drop interface. For more information on writing a Data Parsing Rule, refer to the Data Parsing (UDI, GS1 Label, Blood Bag) on Zebra Scanners User Guide available at: [www.zebra.com/support](http://www.zebra.com/support).

To watch a video on Creating a Data Parsing Rule using 123Scan, go to: [www.zebra.com/ScannerHowToVideos](http://www.zebra.com/ScannerHowToVideos).

## Scan a UDI Label using UDI Scan+

Government regulatory agencies<sup>1</sup> establish Unique Device Identification (UDI) standards to identify and monitor the distribution and use of medical devices within healthcare environments. These UDI standards identify medical devices from manufacturing through distribution to patient use - enabling complete traceability of the millions of individual medical devices utilized for patient care. To enable UDI compliance, all medical devices must carry a UDI label to enable "track and trace" from the point of production, during shipment, through the product's use and disposal.



**NOTE:** <sup>1</sup> United States Food and Drug Administration (FDA), European Commission, International Medical Device Regulatory Forum.

## Scan a GS1 Label using Label Parse+

The GS1 Organization, an international standards body, has released specifications used worldwide for generating shipping labels. These labels are used when shipping packages (logistics), raw materials and produce.

## Scan a Blood Bag Label using Blood Bag Parse+

The ICCBBA Organization, an international standards body, has released a specification used worldwide for generating blood bag labels. These labels are used when shipping, storing and using blood bags. For more information, go to: [www.iccbba.org/tech-library/iccbba-documents/standards-documents/standard-labeling-blood2](http://www.iccbba.org/tech-library/iccbba-documents/standards-documents/standard-labeling-blood2).

# Driver's License Set Up (DSXXX-DL)

## Introduction

The scanner uses internally embedded algorithms to parse out barcode information from standard US driver's licenses and certain other American Association of Motor Vehicle Administrators (AAMVA) compliant ID cards. Scanning these barcodes produces formatted data for use in age verification, credit card application information, and more.

[Set Factory Defaults on page 142](#). Throughout the programming barcode menus, asterisks (\*) indicate default values.

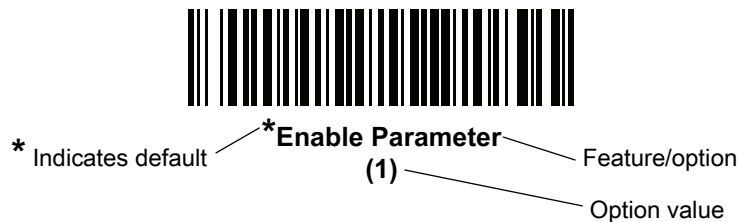

This chapter describes how to program the scanner to read and use the data contained in the 2D barcodes on US driver's licenses and AAMVA compliant ID cards.

**Table 36** DL Parsing Parameter Table

Parameter			Default	Page Number
<b>DL Parsing Parameters</b>				
Driver's License Parsing			No Driver's License Parsing	<a href="#">394</a>
Parsing Driver's License Data Fields			N/A	<a href="#">395</a>
Driver's License Parse Field Barcodes			N/A	<a href="#">396</a>
AAMVA Parse Field Barcodes			N/A	<a href="#">399</a>
Set Default Parameter			N/A	<a href="#">409</a>
Output Gender as M or F			N/A	<a href="#">409</a>

**Table 36** DL Parsing Parameter Table (Continued)

Parameter			Default	Page Number
Date Format			CCYYMMDD	410
No Separator			N/A	412
Send Keystroke			N/A	413
Control Characters				413
Keyboard Characters				418
Parsing Rule Example			N/A	434
Embedded Driver's License Parsing ADF Example			N/A	438

## Driver's License Parsing

To enable driver's license parsing on the scanner, scan the **Embedded Driver's License Parsing** barcode. This does not require Zebra software (.DLL).

Scan the barcodes on the following pages in the order indicating the sequence of data fields that the scanner outputs. See [Parsing Driver's License Data Fields \(Embedded Driver's License Parsing\)](#) on page 395 for more information.

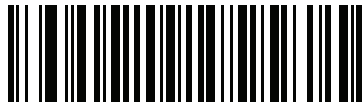

**\*No Driver's License Parsing**



**Embedded Driver's License Parsing**

## Parsing Driver's License Data Fields (Embedded Driver's License Parsing)

To program a parsing rule:

1. Scan [Begin New Driver's License Parse Rule on page 396](#).
2. Scan any of the field barcodes on the following pages, or [Send Keystroke \(Control Characters and Keyboard Characters\) on page 413](#).
3. After entering the entire rule, scan [Save Driver's License Parse Rule on page 396](#) to save the rule.



**NOTE:** The scanner stores only one driver's license parsing rule in memory at a time. Saving a new rule replaces the prior rule.

To abort the programming sequence at any time during programming, scan [Quit Entering Driver's License Rule on page 396](#). Any previously saved rule is retained.

To erase a saved rule, scan [Erase Driver's License Parse Rules on page 396](#).

### Embedded Driver's License Parsing Criteria - Code Type

After specifying the fields and their order for the parsed driver's license, you can also apply standard ADF rules to the parsed data using the **Parsed Driver's License** criterion barcode in the Advanced Data Formatting Programmer Guide.



**NOTE:** Only create standard ADF rules on parsed driver's license data when configured for Embedded Driver's License Parsing.

See [Embedded Driver's License Parsing ADF Example on page 438](#) for a sample ADF rule using this code type criterion.

## Driver's License Parse Field Barcodes



**Begin New Driver's License Parse Rule**



**Save Driver's License Parse Rule**



**Quit Entering Driver's License Rule**



**Erase Driver's License Parse Rules**



## Driver's License Parse Field Barcodes (continued)

The supported parse fields begin below. Not all IDs present data in the same format. For example, some IDs can have separate fields for first name, last name, and middle initial, while others have a single field with the entire name. Also, some IDs expire on the subject's birth date while the expiration date field only indicates the year. To present data in a consistent format, use the following nine barcodes to return data calculated from the actual data contained in the ID barcode.



**First Name**

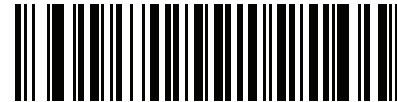

**Middle Name/Initial**



**Last Name**



**Name Suffix**



**Name Prefix**



**Expiration Date**

## Driver's License Parse Field Barcodes (continued)



**Birth Date**

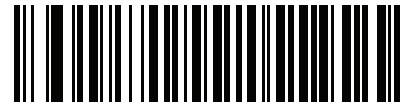

**Issue Date**



**ID Number (Formatted)**

## AAMVA Parse Field Barcodes



**AAMVA Issuer ID**



**Full Name**

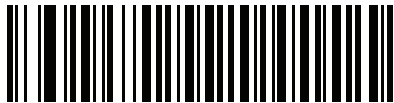

**Last Name**



**First Name**

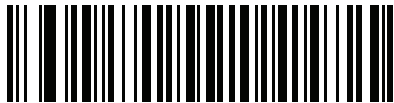

**Middle Name / Initial**

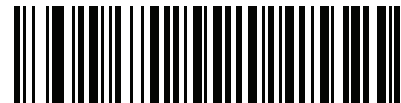

**Name Suffix**



**Name Prefix**

## AAMVA Parse Field Barcodes (continued)



**Mailing Address Line 1**

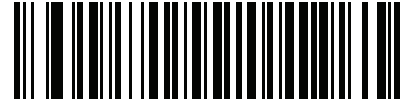

**Mailing Address Line 2**

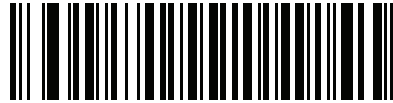

**Mailing Address City**



**Mailing Address State**



**Mailing Address Postal Code**



**Home Address Line 1**



**Home Address Line 2**

## AAMVA Parse Field Barcodes (continued)



Home Address City



Home Address State



Home Address Postal Code

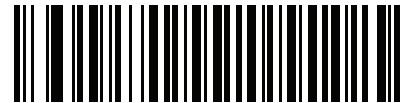

License ID Number



License Class

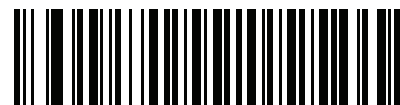

License Restrictions



License Endorsements

## AAMVA Parse Field Barcodes (continued)



Height (Feet and/or Inches)

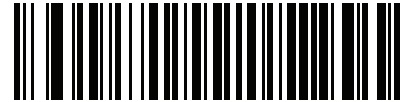

Height (Centimeters)



Weight (Pounds)



Weight (Kilograms)



Eye Color

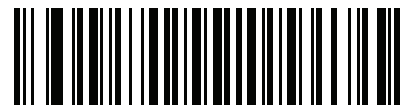

Hair Color



License Expiration Date

## AAMVA Parse Field Barcodes (continued)



Birth Date

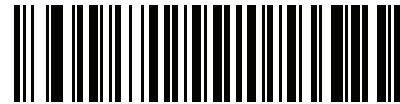

Gender



License Issue Date



License Issue State



Social Security Number



Permit Class



Permit Expiration Date

**AAMVA Parse Field Barcodes (continued)**

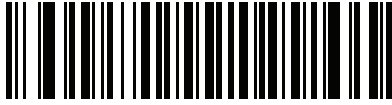

**Permit ID Number**

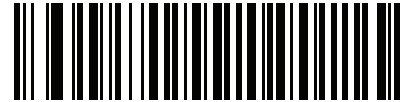

**Permit Issue Date**

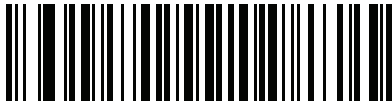

**Permit Restrictions**

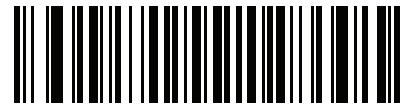

**Permit Endorsements**

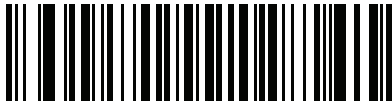

**AKA Social Security Name**

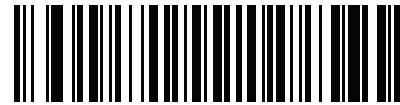

**AKA Full Name**



**AKA Last Name**



## AAMVA Parse Field Barcodes (continued)



**AKA First Name**

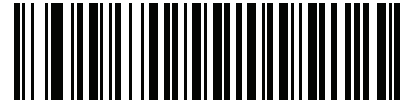

**AKA Middle Name / Initial**



**AKA Name Suffix**

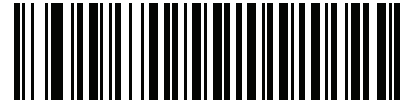

**AKA Name Prefix**



**AKA Birth Date**



**Issue Timestamp**



**Number of Duplicates**

## AAMVA Parse Field Barcodes (continued)



**Medical Codes**



**Organ Donor**



**Nonresident**



**Customer ID**



**Weight Range**

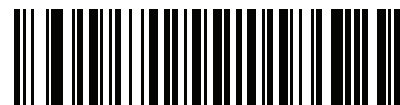

**Document Discriminator**



**Country**

## AAMVA Parse Field Barcodes (continued)



**Federal Commission Codes**



**Place of Birth**



**Audit Information**

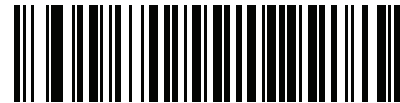

**Inventory Control**



**Race / Ethnicity**



**Std Vehicle Class**



**Std Endorsements**

## AAMVA Parse Field Barcodes (continued)



**Std Restrictions**

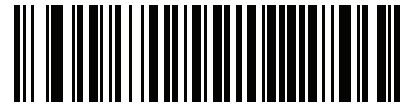

**Class Description**



**Endorsement Description**

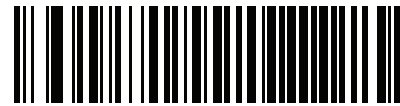

**Restrictions Description**



**Height in Inches**

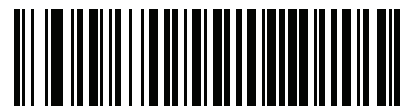

**Height in Centimeters**



**Std Endorsements**

## Parser Version ID Barcode

Include this field to emit embedded parser software version identification.



Parser Version ID

---

## User Preferences

### Set Default Parameter

Scan this barcode to return all parameters to the default values listed in [Table 37 on page 440](#).



\*Set All Defaults

### Output Gender as M or F

Scan this barcode to report the gender as **M** or **F** instead of a numeric value.



Output gender as M or F

## Date Format

Use these barcodes to select the date format to display. Date fields include the following:

- **CCYY** = 4-digit year (**CC**=2-digit century [00-99], **YY**=2-digit year in the century [00-99])
- **MM** = 2-digit month [01-12]
- **DD** = 2-digit day of the month [00-31]

The default is **CCYYMMDD**.



**NOTE:** To specify a date separator, i.e., a character separating each field of the date, scan the **Send <character>** barcode that corresponds to the alphanumeric character to use as the date separator immediately following the date format barcode. To select no date separator, scan the **No Separator DL** parsing rule immediately following the date format barcode.

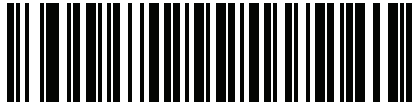

\*CCYYMMDD



CCYYDDMM



MMDDCCYY



MMCCYYDD

Date Format (continued)

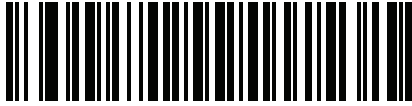

DDMMCCYY

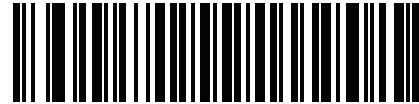

DDCCYYMM

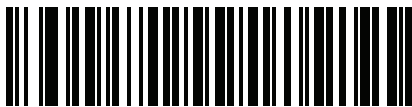

YYMMDD



YYDDMM



MMDDYY



MMYYDD

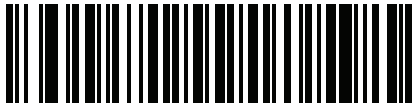

**DMMYY**



**DDYMM**

### **No Separator**

Scan this barcode immediately following a date format barcode to use no separator character between the date fields.

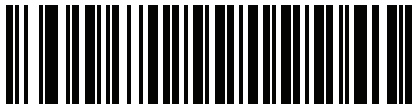

**No Separator**



## Send Keystroke (Control Characters and Keyboard Characters)

### Control Characters

Scan a **Send** barcode for the keystroke to send.



Send Control A



Send Control B



Send Control C



Send Control D



Send Control E



Send Control F



Send Control G

**Control Characters (continued)**



**Send Control H**



**Send Control I**



**Send Control J**



**Send Control K**



**Send Control L**



**Send Control M**



**Send Control N**

**Control Characters (continued)**



**Send Control O**



**Send Control P**



**Send Control Q**



**Send Control R**



**Send Control S**



**Send Control T**



**Send Control U**

**Control Characters (continued)**



**Send Control V**



**Send Control W**



**Send Control X**



**Send Control Y**



**Send Control Z**



**Send Control [**

**Control Characters (continued)**



**Send Control \**



**Send Control ]**



**Send Control 6**



**Send Control -**

## Keyboard Characters

Scan a **Send** barcode for the keyboard characters to send.



**Send Space**



**Send !**



**Send "**



**Send #**



**Send \$**



**Send %**

**Keyboard Characters (continued)**



**Send &**



**Send '**



**Send (**



**Send )**



**Send \***



**Send +**

**Keyboard Characters (continued)**



**Send ,**



**Send -**



**Send .**



**Send /**



**Send 0**



**Send 1**



**Keyboard Characters (continued)**



**Send 2**



**Send 3**



**Send 4**



**Send 5**



**Send 6**



**Send 7**

**Keyboard Characters (continued)**



**Send 8**



**Send 9**



**Send :**



**Send ;**



**Send <**



**Send =**

**Keyboard Characters (continued)**



**Send >**



**Send ?**



**Send @**



**Send A**



**Send B**



**Send C**

**Keyboard Characters (continued)**



**Send D**



**Send E**



**Send F**



**Send G**



**Send H**



**Send I**

**Keyboard Characters (continued)**



**Send J**



**Send K**



**Send L**



**Send M**



**Send N**



**Send O**

**Keyboard Characters (continued)**



**Send P**



**Send Q**



**Send R**



**Send S**



**Send T**



**Send U**

**Keyboard Characters (continued)**



**Send V**



**Send W**



**Send X**



**Send Y**



**Send Z**



**Send [**

**Keyboard Characters (continued)**



Send \



Send ]



Send ^

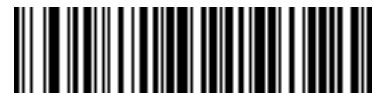

Send \_



Send `



Send a



**Keyboard Characters (continued)**



**Send b**



**Send c**



**Send d**



**Send e**



**Send f**



**Send g**

**Keyboard Characters (continued)**



**Send h**



**Send i**



**Send j**



**Send k**



**Send l**



**Send m**

**Keyboard Characters (continued)**



**Send n**



**Send o**



**Send p**



**Send q**



**Send r**



**Send s**

**Keyboard Characters (continued)**



**Send t**



**Send u**



**Send v**



**Send w**



**Send x**



**Send y**

**Keyboard Characters (continued)**



**Send z**



**Send {**



**Send |**



**Send }**



**Send ~**



**Send Tab Key**



**Send Enter Key**

## Parsing Rule Example

Scan the following barcodes in sequence to program the scanner to extract and transmit first, middle, and last names; mailing address line 1; mailing address line 2; mailing address city; mailing address state; mailing address postal code; and, date of birth. Then, scan a driver's license barcode.



**NOTE:** This example applies to RS-232. To use this example with a USB interface, enable [Function Key Mapping on page 72](#) to send the Enter key properly.



1 - Embedded Driver's License Parsing



2 - Begin New Driver's License Parse Rule



3 - First Name



4 - Send Space



5 - Middle Name / Initial



6 - Send Space

---

## Parsing Rule Example (continued)

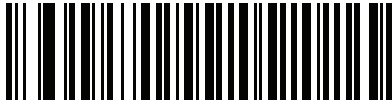

7 - Last Name



8 - Send Enter Key

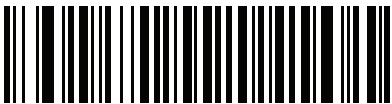

9 - Mailing Address Line 1



10 - Send Space



11 - Mailing Address Line 2



12 - Send Enter Key

---

## Parsing Rule Example (continued)



13 - Mailing Address City



14 - Send Space

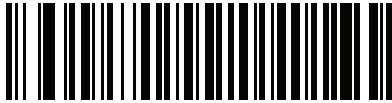

15 - Mailing Address State



16 - Send Space

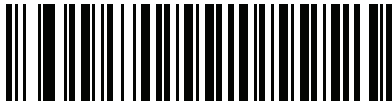

17 - Mailing Address Postal Code



18 - Send Enter Key



---

## Parsing Rule Example (continued)



19 - Birth Date



20 - Send Enter Key

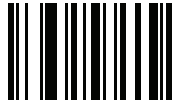

21 - Save Driver's Licence Parse Rule

## Embedded Driver's License Parsing ADF Example

This example creates a parsing rule for parsed data configured to result in the format:

**Last Name, First Name**



**1 - Begin New Driver's License Parse Rule**

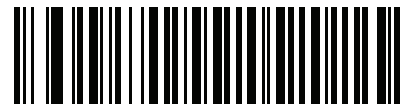

**2 - Last Name**



**3 - Send ,**



**4 - Send Space**



**5 - First Name**

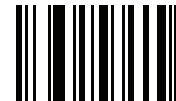

**6 - Save Driver's License Parse Rule**

Then, in order to limit the full name to 15 characters, create the following ADF rule:



**1 - Begin New Rule**

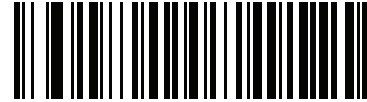

**2 - Criterion: Parsed Driver's License**



**3 - Action: Send Next 15 Characters**



**4 - Save Rule**

For a license belonging to Michael Williams, the parsed data is Williams, Michael and Williams, Micha after applying the previous ADF rule.

# Standard Parameter Defaults

## Introduction

**Table 37** Parameter Defaults

Parameter	Parameter Number <sup>1</sup>	SSI Number <sup>2</sup>	Default	Page #
<b>Send Versions</b>				
Software Version	N/A	N/A	N/A	49
Serial Number	N/A	N/A	N/A	49
Manufacturing Information	N/A	N/A	N/A	49
<b>USB Host Parameters</b>				
USB Device Type	N/A	N/A	USB HID Keyboard	62
Symbol Native API (SNAPI) Status Handshaking	N/A	N/A	Enable	64
USB Keystroke Delay	N/A	N/A	No Delay	65
USB Caps Lock Override	N/A	N/A	Do Not Override (Disable)	65
Barcodes with Unknown Characters	N/A	N/A	Send Barcodes with Unknown Characters	66
USB Convert Unknown to Code 39	N/A	N/A	Disable	66
USB Fast HID	N/A	N/A	Enable	67
USB Polling Interval	N/A	N/A	3 msec	68
Keypad Emulation	N/A	N/A	Enable	70
Quick Keypad Emulation	N/A	N/A	Enable	70
Keypad Emulation with Leading Zero	N/A	N/A	Enable	71
USB FN1 Substitution	N/A	N/A	Disable	71
Function Key Mapping	N/A	N/A	Disable	72

1. Parameter number decimal values are used for programming via RSM commands.

2. SSI number hex values are used for programming via SSI commands.

**Table 37** Parameter Defaults (Continued)

Parameter	Parameter Number <sup>1</sup>	SSI Number <sup>2</sup>	Default	Page #
Simulated Caps Lock	N/A	N/A	Disable	72
Convert Case	N/A	N/A	None	73
USB Static CDC	N/A	N/A	Enable	74
CDC Beep on <BEL>	N/A	N/A	Enable	74
TGCS (IBM) USB Direct I/O Beep	N/A	N/A	Honor	75
TGCS (IBM) USB Beep Directive	N/A	N/A	Ignore	75
TGCS (IBM) USB Barcode Configuration Directive	N/A	N/A	Ignore	76
TGCS (IBM) USB Specification Version	N/A	N/A	Version 2.2	76
<b>SSI Host Parameters</b>				
Select SSI Host	N/A	N/A	N/A	89
Baud Rate	156	9Ch	9600	89
Parity	158	9Eh	None	91
Check Parity	151	97h	Disable	91
Stop Bits	157	9Dh	1	92
Software Handshaking	159	9Fh	Enable ACK/NAK	93
Host RTS Line State	154	9Ah	Low	94
Decode Data Packet Format	238	EEh	Send Raw Decode Data	94
Host Serial Response Timeout	155	9Bh	2 Seconds	95
Host Character Timeout	239	EFh	200 msec	96
Multipacket Option	334	F0h 4Eh	Option 1	97
Interpacket Delay	335	F0h 4Fh	0 msec	98
<b>Event Reporting</b>				
Decode Event	256	F0h 00h	Disable	99
Boot Up Event	258	F0h 02h	Disable	100
Parameter Event	259	F0h 03h	Disable	100
<b>RS-232 Host Parameters</b>				
RS-232 Host Types	N/A	N/A	Standard	107
Baud Rate	N/A	N/A	9600	109

1. Parameter number decimal values are used for programming via RSM commands.

2. SSI number hex values are used for programming via SSI commands.

**Table 37** Parameter Defaults (Continued)

Parameter	Parameter Number <sup>1</sup>	SSI Number <sup>2</sup>	Default	Page #
Parity	N/A	N/A	None	111
Stop Bits	N/A	N/A	1 Stop Bit	112
Data Bits	N/A	N/A	8-bit	112
Check Receive Errors	N/A	N/A	Enable	113
Hardware Handshaking	N/A	N/A	None	113
Software Handshaking	N/A	N/A	None	115
Host Serial Response Timeout	N/A	N/A	2 Seconds	117
RTS Line State	N/A	N/A	Low RTS	118
Beep on <BEL>	N/A	N/A	Disable	118
Intercharacter Delay	N/A	N/A	0 msec	119
Nixdorf Beep/LED Options	N/A	N/A	Normal Operation	120
Barcodes with Unknown Characters	N/A	N/A	Send Barcode With Unknown Characters	120
<b>IBM 468X/469X Host Parameters</b>				
Port Address	N/A	N/A	None	125
Convert Unknown to Code 39	N/A	N/A	Disable	126
RS-485 Beep Directive	N/A	N/A	Ignore	126
RS-485 Barcode Configuration Directive	N/A	N/A	Ignore	127
IBM-485 Specification Version	N/A	N/A	Original Specification	127
<b>Keyboard Wedge Host Parameters</b>				
Keyboard Wedge Host Type	N/A	N/A	IBM AT Notebook	131
Barcodes with Unknown Characters	N/A	N/A	Send Barcodes with Unknown Characters	131
Keystroke Delay	N/A	N/A	No Delay	132
Intra-keystroke Delay	N/A	N/A	Disable	132
Alternate Numeric Keypad Emulation	N/A	N/A	Enable	133
Quick Keypad Emulation	N/A	N/A	Enable	133
Simulated Caps Lock	N/A	N/A	Disable	134
Caps Lock Override	N/A	N/A	Disable	134
Convert Case	N/A	N/A	Do Not Convert	135

1. Parameter number decimal values are used for programming via RSM commands.

2. SSI number hex values are used for programming via SSI commands.

## Standard Parameter Defaults

**Table 37** Parameter Defaults (Continued)

Parameter	Parameter Number <sup>1</sup>	SSI Number <sup>2</sup>	Default	Page #
Function Key Mapping	N/A	N/A	Disable	136
FN1 Substitution	N/A	N/A	Disable	136
Send Make and Break	N/A	N/A	Send	137
<b>User Preferences</b>				
Set Default Parameter	N/A	N/A	N/A	142
Parameter Barcode Scanning	236	ECh	Enable	143
Beep After Good Decode	56	38h	Enable	144
Beeper Volume	140	8Ch	High	145
Beeper Tone	145	91h	Medium	146
Beeper Duration	628	F1h 74h	Medium	147
Suppress Power Up Beeps	721	F1h D1h	Do Not Suppress	148
LED on Good Decode	744	F1h E8h	Enable	149
Direct Decode Indicator	859	F2h 5Bh	Disable	149
Decode Pager Motor (DS4608-HC Only)	613	F1h 65h	Enable	150
Decode Pager Motor Duration (DS4608-HC Only)	626	F1h 72h	150 msec	151
Night Mode Trigger (DS4608-HC Only)	1215	F8h 04h BFh	Enable	154
Night Mode Toggle (DS4608-HC Only)	N/A	N/A	N/A	154
Low Power Mode	128	80h	Disable	155
Time Delay to Low Power Mode	146	92h	1 Hour	156
Trigger Mode (or Hand-held Trigger Mode)	138	8Ah	Auto Aim	158
Hand-held Decode Aiming Pattern	306	F0h 32h	Enable	159
Hands-free (Presentation) Decode Aiming Pattern	590	F1h 4Eh	Disable Hands-free (Presentation) Decode Aiming Pattern	160
Hands-free Mode	630	F1h 76h	Enable	161
Picklist Mode	402	F0h 92h	Disable Picklist Mode Always	162
Continuous Barcode Read	649	F1h 89h	Disable	163
Unique Barcode Reporting	723	F1h D3h	Enable	164

1. Parameter number decimal values are used for programming via RSM commands.

2. SSI number hex values are used for programming via SSI commands.

**Table 37** Parameter Defaults (Continued)

Parameter	Parameter Number <sup>1</sup>	SSI Number <sup>2</sup>	Default	Page #
Decode Session Timeout	136	88h	9.9 Seconds	164
Hands-Free Decode Session Timeout	400	F0 90	15	165
Timeout Between Decodes, Same Symbol	137	89h	0.5 Seconds	166
Timeout Between Decodes, Different Symbols	144	90h	0.1 Seconds	166
Triggered Timeout, Same Symbol	724	F1h D4h	Disable	167
Mobile Phone/Display Mode	716	F1h CCh	Normal	168
PDF Prioritization	719	F4h F1h CFh	Disable	169
PDF Prioritization Timeout	720	F1h D0h	200 ms	170
Presentation Mode Field of View	609	F1h 61h	Full	171
Decoding Illumination	298	F0h 2Ah	Enable	172
Illumination Brightness	669	F1h 9Dh	High	173
Motion Tolerance (Hand-held Trigger Mode Only)	858	F2h 5Ah	Less	174
Product ID (PID) Type	1281	F8h 05h 01h	Host Type Unique	175
Product ID (PID) Value	1725	F8h 06h BDh	0	175
ECLevel	1710	F8h 06h AEh	0	176
<b>DPM Parameters (DS4608-DPE Only)</b>				
DPM Illumination	429	F0h ADh	Cycle Illumination	177
DPM Mode	1438	F8h 05h 9Eh	Enable	178
<b>Miscellaneous Options</b>				
Enter Key	N/A	N/A	N/A	179
Tab Key	N/A	N/A	N/A	179
Transmit Code ID Character	45	2Dh	None	180
Prefix Value	99, 105	63h, 69h	7013 <CR><LF>	181
Suffix 1 Value	98, 104	62h, 68h	7013 <CR><LF>	181
Suffix 2 Value	100, 106	64h, 6Ah		
Scan Data Transmission Format	235	EBh	Data As Is	182
FN1 Substitution Values	103, 109	67h, 6Dh	7013 <CR><LF>	184
Transmit "No Read" Message	94	5E	Disable	185

1. Parameter number decimal values are used for programming via RSM commands.

2. SSI number hex values are used for programming via SSI commands.



**Table 37** Parameter Defaults (Continued)

Parameter	Parameter Number <sup>1</sup>	SSI Number <sup>2</sup>	Default	Page #
Unsolicited Heartbeat Interval	1118	F8h 04h 5Eh	Disable	186
securPharm Decoding	1752	F8h 06h D8h	Disable	187
securPharm Output Formatting	1753	F8h 06h D9h	No Formatting	188
<b>Image Capture Preferences</b>				
Operational Modes	N/A	N/A	N/A	194
Image Capture Illumination	361	F0h 69h	Enable	195
Image Capture Autoexposure	360	F0h 68h	Enable	195
Fixed Exposure	567	F4h F1h 37h	100	196
Analog Gain	1232	F4h D0h	Analog Gain x 2	197
Digital Gain	1233	F4h D1h	32	197
Snapshot Mode Timeout	323	F0h 43h	0 (30 seconds)	198
Snapshot Aiming Pattern	300	F0h 2Ch	Enable	199
Silence Operational Mode Changes	1293	F8h 05h 0Dh	Disable (do not silence)	199
Image Cropping	301	F0h 2Dh	Disable	200
Crop to Pixel Addresses	315 316 317 318	F4h F0h 3Bh F4h F0h 3Ch F4h F0h 3Dh F4h F0h 3Eh	0 top 0 left 799 bottom 1279 right	200
Image Size (Number of Pixels)	302	F0h 2Eh	Full	202
Image Brightness (Target White)	390	F0h 86h	180	203
JPEG Image Options	299	F0h 2Bh	Quality	203
JPEG Quality Value	305	F0h 31h	65	204
JPEG Size Value	561	F1h 31h	160 kB	204
Image Enhancement	564	F1h 34h	Low (1)	205
Image File Format Selector	304	F0h 30h	JPEG	206
Image Rotation	665	F1h 99h	0	207
Bits per Pixel (BPP)	303	F0h 2Fh	8 BPP	208
Signature Capture	93	5Dh	Disable	209
Signature Capture Image File Format Selection	313	F0h 39h	JPEG	210

1. Parameter number decimal values are used for programming via RSM commands.

2. SSI number hex values are used for programming via SSI commands.

**Table 37** Parameter Defaults (Continued)

Parameter	Parameter Number <sup>1</sup>	SSI Number <sup>2</sup>	Default	Page #
Signature Capture Bits per Pixel (BPP)	314	F0h 3Ah	8 BPP	211
Signature Capture Width	366	F4h F0h 6Eh	400	212
Signature Capture Height	367	F4h F0h 6Fh	100	212
Signature Capture JPEG Quality	421	F0h A5h	65	213
Video Mode Format Selector	916	F2h 94h	JPEG	213
Video View Finder	324	F0h 44h	Disable	214
Target Video Frame Size	328	F0h 48h	2200 bytes	214
Video View Finder Image Size	329	F0h 49h	1700 bytes	215
Video Resolution	667	F1h 9Bh	1/4 resolution	215

**Symbologies**

<b>Enable/Disable All Code Types</b>				224
<b>1D Symbologies</b>				
<b>UPC/EAN/JAN</b>				
UPC-A	1	01h	Enable	225
UPC-E	2	02h	Enable	225
UPC-E1	12	0Ch	Disable	226
EAN-8/JAN 8	4	04h	Enable	226
EAN-13/JAN 13	3	03h	Enable	227
Bookland EAN	83	53h	Disable	227
Bookland ISBN Format	576	F1h 40h	ISBN-10	228
ISSN EAN	617	F1h 69h	Disable	229
Decode UPC/EAN/JAN Supplementals (2 and 5 digits)	16	10h	Ignore	230
User-Programmable Supplementals			000	233
Supplemental 1:	579	F4h F1h 43h		
Supplemental 2:	580	F4h F1h 44h		
UPC/EAN/JAN Supplemental Redundancy	80	50h	10	233
UPC/EAN/JAN Supplemental AIM ID Format	672	F1h A0h	Combined	234
Transmit UPC-A Check Digit	40	28h	Enable	235

1. Parameter number decimal values are used for programming via RSM commands.
2. SSI number hex values are used for programming via SSI commands.

## Standard Parameter Defaults

**Table 37** Parameter Defaults (Continued)

Parameter	Parameter Number <sup>1</sup>	SSI Number <sup>2</sup>	Default	Page #
Transmit UPC-E Check Digit	41	29h	Enable	235
Transmit UPC-E1 Check Digit	42	2Ah	Enable	236
UPC-A Preamble	34	22h	System Character	237
UPC-E Preamble	35	23h	System Character	238
UPC-E1 Preamble	36	24h	System Character	239
Convert UPC-E to A	37	25h	Disable	240
Convert UPC-E1 to A	38	26h	Disable	240
EAN/JAN Zero Extend	39	27h	Disable	241
UCC Coupon Extended Code	85	55h	Disable	241
Coupon Report	730	F1h DAh	New Coupon Format	242
UPC Reduced Quiet Zone	1289	F8h 05h 09h	Disable	243
<b>Code 128</b>				
Code 128	8	08h	Enable	243
Set Length(s) for Code 128	209, 210	D1h, D2h	Any Length	244
GS1-128 (formerly UCC/EAN-128)	14	0Eh	Enable	245
ISBT 128	84	54h	Enable	246
ISBT Concatenation	577	F1h 41h	Disable Enable for DS4608-HC	247
Check ISBT Table	578	F1h 42h	Enable	248
ISBT Concatenation Redundancy	223	DFh	10	248
Code 128 <FNC4>	1254	F8h 04h E6h	Honor	249
Code 128 Security Level	751	F1h EFh	Security Level 1 Security Level 2 for DS4608-HC	250
Code 128 Reduced Quiet Zone	1208	F8h 04h B8h	Disable	251
<b>Code 39</b>				
Code 39	0	00h	Enable	251
Trioptic Code 39	13	0Dh	Disable	252

1. Parameter number decimal values are used for programming via RSM commands.

2. SSI number hex values are used for programming via SSI commands.

## Standard Parameter Defaults

**Table 37** Parameter Defaults (Continued)

Parameter	Parameter Number <sup>1</sup>	SSI Number <sup>2</sup>	Default	Page #
Convert Code 39 to Code 32 (Italian Pharmacy Code)	86	56h	Disable	252
Code 32 Prefix	231	E7h	Disable	253
Set Length(s) for Code 39	18, 19	12h, 13h	1 to 55	253
Code 39 Check Digit Verification	48	30h	Disable	255
Transmit Code 39 Check Digit	43	2Bh	Disable	255
Code 39 Full ASCII Conversion	17	11h	Disable	256
Code 39 Security Level	750	F1h EEh	Security Level 1	257
Code 39 Reduced Quiet Zone	1209	F8h 04h B9h	Disable	259
<b>Code 93</b>				
Code 93	9	09h	Enable	259
Set Length(s) for Code 93	26, 27	1Ah, 1Bh	1 to 55	260
<b>Code 11</b>				
Code 11	10	0Ah	Disable	262
Set Lengths for Code 11	28, 29	1Ch, 1Dh	4 to 55	262
Code 11 Check Digit Verification	52	34h	Disable	264
Transmit Code 11 Check Digit(s)	47	2Fh	Disable	265
<b>Interleaved 2 of 5 (ITF)</b>				
Interleaved 2 of 5 (ITF)	6	06h	Enable	265
Set Lengths for I 2 of 5	22, 23	16h, 17h	6 to 55	266
I 2 of 5 Check Digit Verification	49	31h	Disable	268
Transmit I 2 of 5 Check Digit	44	2Ch	Disable	268
Convert I 2 of 5 to EAN-13	82	52h	Disable	269
Febraban	1750	F8h 06h D6h	Disable	269
I 2 of 5 Security Level	1121	F8h 04h 61h	Security Level 1	270
I 2 of 5 Reduced Quiet Zone	1210	F8h 04h BAh	Disable	271

1. Parameter number decimal values are used for programming via RSM commands.

2. SSI number hex values are used for programming via SSI commands.

## Standard Parameter Defaults

**Table 37** Parameter Defaults (Continued)

Parameter	Parameter Number <sup>1</sup>	SSI Number <sup>2</sup>	Default	Page #
<b>Discrete 2 of 5 (DTF)</b>				
Discrete 2 of 5	5	05h	Disable	271
Set Length(s) for D 2 of 5	20, 21	14h 15h	1 to 55	272
<b>Codabar (NW - 7)</b>				
Codabar	7	07h	Enable	274
Set Lengths for Codabar	24, 25	18h, 19h	4 to 55	274
CLSI Editing	54	36h	Disable	276
NOTIS Editing	55	37h	Disable	276
Codabar Security Level	1776	F8h 06h F0h	Security Level 1	277
Codabar Upper or Lower Case Start/ Stop Characters Detection	855	F2h 57h	Upper Case	278
Codabar Mod 16 Check Digit Verification	1784	F8h 06h F8h	Disable	278
Transmit Codabar Check Digit	704	F1h C0h	Disable	279
<b>MSI</b>				
MSI	11	0Bh	Disable	279
Set Length(s) for MSI	30, 31	1Eh, 1Fh	4 to 55	280
MSI Check Digits	50	32h	One	281
Transmit MSI Check Digit	46	2Eh	Disable	282
MSI Check Digit Algorithm	51	33h	Mod 10/Mod 10	282
MSI Reduced Quiet Zone	1392	F8h 05h 70h	Disable	283
<b>Chinese 2 of 5</b>				
Chinese 2 of 5	408	F0h 98h	Disable	283
<b>Matrix 2 of 5</b>				
Matrix 2 of 5	618	F1h 6Ah	Disable	284
Matrix 2 of 5 Lengths	619 620	F1h 6Bh F1h 6Ch	4 to 55	284
Matrix 2 of 5 Check Digit	622	F1h 6Eh	Disable	286
Transmit Matrix 2 of 5 Check Digit	623	F1h 6Fh	Disable	286

1. Parameter number decimal values are used for programming via RSM commands.

2. SSI number hex values are used for programming via SSI commands.

**Table 37** Parameter Defaults (Continued)

Parameter	Parameter Number <sup>1</sup>	SSI Number <sup>2</sup>	Default	Page #
<b>Korean 3 of 5</b>				
Korean 3 of 5	581	F1h 45h	Disable	287
<b>Inverse 1D</b>	586	F1h 4Ah	Regular	288
<b>GS1 DataBar</b>				
GS1 DataBar Omnidirectional	338	F0h 52h	Enable	289
GS1 DataBar Limited	339	F0h 53h	Enable	289
GS1 DataBar Expanded	340	F0h 54h	Enable	290
Convert GS1 DataBar to UPC/EAN/JAN	397	F0h 8Dh	Disable	290
GS1 DataBar Security Level	1706	F8h 06h AAh	Level 1	291
GS1 DataBar Limited Margin Check	728	F1h D8h	Level 3	292
<b>Symbology-Specific Security Features</b>				
Redundancy Level	78	4Eh	1	294
Security Level	77	4Dh	1	296
1D Quiet Zone Level	1288	F8h 05h 08h	1	297
Intercharacter Gap Size	381	F0h 7Dh	Normal	298
<b>Composite Codes</b>				
Composite CC-C	341	F0h 55h	Disable	299
Composite CC-A/B	342	F0h 56h	Disable	299
Composite TLC-39	371	F0h 73h	Disable	300
Composite Inverse	1113	F8h 04h 59h	Regular	300
UPC Composite Mode	344	F0h 58h	UPC Never Linked	301
Composite Beep Mode	398	F0h 8Eh	Beep As Each Code Type is Decoded	302
GS1-128 Emulation Mode for UCC/EAN Composite Codes	427	F0h ABh	Disable	303
<b>2D Symbologies</b>				
PDF417	15	0Fh	Enable	304
MicroPDF417	227	E3h	Disable	304
Code 128 Emulation	123	7Bh	Disable	305

1. Parameter number decimal values are used for programming via RSM commands.

2. SSI number hex values are used for programming via SSI commands.

**Table 37** Parameter Defaults (Continued)

Parameter	Parameter Number <sup>1</sup>	SSI Number <sup>2</sup>	Default	Page #
Data Matrix	292	F0h 24h	Enable	306
GS1 Data Matrix	1336	F8h 05h 38h	Disable	306
Data Matrix Inverse	588	F1h 4Ch	Inverse Autodetect	307
Decode Data Matrix Mirror Images	537	F1h 19h	Auto	308
Maxicode	294	F0h 26h	Disable	309
QR Code	293	F0h 25h	Enable	310
GS1 QR	1343	F8h 05h 3Fh	Enable	310
MicroQR	573	F1h 3Dh	Enable	311
Linked QR Mode	1847	737h	Linked QR Only	312
Aztec	574	F1h 3Eh	Enable	313
Aztec Inverse	589	F1h 4Dh	Inverse Autodetect	314
Han Xin	1167	F8h 04h 8Fh	Disable	315
Han Xin Inverse	1168	F8h 04h 90h	Regular	316
Grid Matrix	1718	F8h 06h B6h	Disable	317
Grid Matrix Inverse	1719	F8h 06h B7h	Regular	318
Grid Matrix Mirror	1736	F8h 06h C8h	Regular Only	319
DotCode	1906	F8 07 72h	Disable	320
DotCode Inverse	1907	F8 07 73h	Inverse Autodetect	321
DotCode Mirrored	1908	F8 07 74h	Autodetect	322
DotCode Prioritize	1937	F8 07 91h	Enable	323
<b>Macro PDF</b>				
Flush Macro PDF Buffer	N/A	N/A	N/A	324
Abort Macro PDF Entry	N/A	N/A	N/A	324
<b>Postal Codes</b>				
US Postnet	89	59h	Disable	325
US Planet	90	5Ah	Disable	325
Transmit US Postal Check Digit	95	5Fh	Enable	326
UK Postal	91	5Bh	Disable	326
Transmit UK Postal Check Digit	96	60h	Enable	327

1. Parameter number decimal values are used for programming via RSM commands.

2. SSI number hex values are used for programming via SSI commands.

**Table 37** Parameter Defaults (Continued)

Parameter	Parameter Number <sup>1</sup>	SSI Number <sup>2</sup>	Default	Page #
Japan Postal	290	F0h 22h	Disable	327
Australia Post	291	F0h 23h	Disable	328
Australia Post Format	718	F1h CEh	Autodiscriminate	329
Netherlands KIX Code	326	F0h 46h	Disable	330
USPS 4CB/One Code/Intelligent Mail	592	F1h 50h	Disable	330
UPU FICS Postal	611	F1h 63h	Disable	331
Mailmark	1337	F8h 05h 39h	Disable	331

**OCR Programming Parameters**

OCR-A	680	F1h A8h	Disable	334
OCR-A Variant	684	F1h ACh	Full ASCII	335
OCR-B	681	F1h A9h	Disable	337
OCR-B Variant	685	F1h ADh	Full ASCII	338
MICR E13B	682	F1h AAh	Disable	342
US Currency	683	F1h ABh	Disable	343
OCR Orientation	687	F1h AFh	0°	343
OCR Lines	691	F1h B3h	1	345
OCR Minimum Characters	689	F1h B1h	3	345
OCR Maximum Characters	690	F1h B2h	100	346
OCR Subset	686	F1h AEh	Selected font variant	346
OCR Quiet Zone	695	F1h B7h	50	347
OCR Template	547	F1h 23h	99999999	348
OCR Check Digit Modulus	688	F1h B0h	1	357
OCR Check Digit Multiplier	700	F1h BCh	121212121212	358
OCR Check Digit Validation	694	F1h B6h	None	360
Inverse OCR	856	F2h 58h	Regular	365
OCR Redundancy	1770	F8h 06h EAh	Level 1	366

**Intelligent Document Capture (IDC) Parameters**

IDC Operating Mode	594	F1h 52h	Off	372
IDC Symbology	655	F1h 8Fh	001	373

1. Parameter number decimal values are used for programming via RSM commands.

2. SSI number hex values are used for programming via SSI commands.



## Standard Parameter Defaults

**Table 37** Parameter Defaults (Continued)

Parameter	Parameter Number <sup>1</sup>	SSI Number <sup>2</sup>	Default	Page #
IDC X Coordinate	596	F4h F1h 54h	-151	374
IDC Y Coordinate	597	F4h F1h 55h	-050	374
IDC Width	598	F1h 56h	0300	375
IDC Height	599	F1h 57h	0050	375
IDC Aspect	595	F1h 53h	000	376
IDC File Format Selector	601	F1h 59h	JPEG	376
IDC Bits Per Pixel	602	F1h 5Ah	8 BPP	377
IDC JPEG Quality	603	F1h 5Bh	065	378
IDC Find Box Outline	727	F1h D7h	Disable	378
IDC Minimum Text Length	656	F1h 90h	00	379
IDC Maximum Text Length	657	F1h 91h	00	379
IDC Captured Image Brighten	654	F1h 8Eh	Enable	380
IDC Captured Image Sharpen	658	F1h 92h	Enable	381
IDC Border Type	829	F2h 3Dh	None	382
IDC Delay Time	830	F2h 3Eh	000	383
IDC Zoom Limit	651	F1h 8Bh	000	383
IDC Maximum Rotation	652	F1h 8Ch	00	384
<b>DL Parsing Parameters</b>				
Driver's License Parsing	N/A	N/A	No Driver's License Parsing	394
Parsing Driver's License Data Fields	N/A	N/A	N/A	395
Driver's License Parse Field Barcodes	N/A	N/A	N/A	396
AAMVA Parse Field Barcodes	N/A	N/A	N/A	399
Set Default Parameter	N/A	N/A	N/A	409
Output Gender as M or F	N/A	N/A	N/A	409
Date Format	N/A	N/A	CCYYMMDD	410
No Separator	N/A	N/A	N/A	412

1. Parameter number decimal values are used for programming via RSM commands.

2. SSI number hex values are used for programming via SSI commands.

**Table 37** Parameter Defaults (Continued)

Parameter	Parameter Number <sup>1</sup>	SSI Number <sup>2</sup>	Default	Page #
Send Keystroke Control Characters Keyboard Characters	N/A	N/A	N/A	413
Parsing Rule Example	N/A	N/A	N/A	434
Embedded Driver's License Parsing ADF Example	N/A	N/A	N/A	438

1. Parameter number decimal values are used for programming via RSM commands.

2. SSI number hex values are used for programming via SSI commands.

# Numeric Barcodes

---

## Numeric Barcodes

For parameters requiring specific numeric values, scan the appropriately numbered barcode(s).

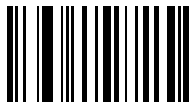

0



1



2



3

---

**Numeric Barcodes (continued)**



4



5



6

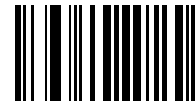

7



8



9

---

## Cancel

To correct an error or change a selection, scan the barcode below.



**Cancel**

# Alphanumeric Barcodes

---

## Cancel

To correct an error or change a selection, scan the following barcode.



Cancel

---

# Alphanumeric Barcodes



Space



#



\$



%



\*



+

Alphanumeric Barcodes (continued)



-



.



/



!



“



&



Alphanumeric Barcodes (continued)



€

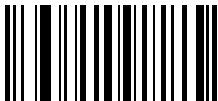

(



)



:



;



<

Alphanumeric Barcodes (continued)



=



>



?



@



[



\

---

**Alphanumeric Barcodes (continued)**



J

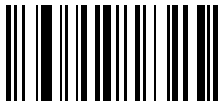

^

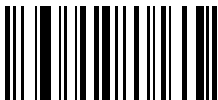

-



,

# Alphanumeric Barcodes (continued)



**NOTE:** Do not confuse the following barcodes with those on the numeric keypad.



0

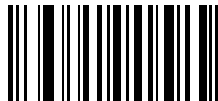

1



2



3



4



5

**Alphanumeric Barcodes (continued)**



6



7



8



9



End of Message



Cancel

Alphanumeric Barcodes (continued)



A



B



C



D



E



F

---

## Alphanumeric Barcodes (continued)



G

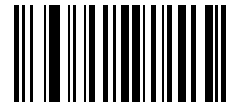

H



I

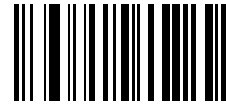

J



K

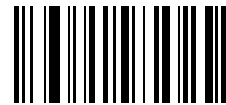

L

Alphanumeric Barcodes (continued)



M



N



O



P



Q

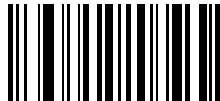

R



Alphanumeric Barcodes (continued)



S



T

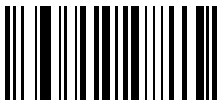

U

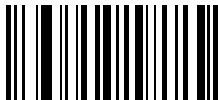

V



W



X

**Alphanumeric Barcodes (continued)**



Y



Z



a



b



c



d

**Alphanumeric Barcodes (continued)**

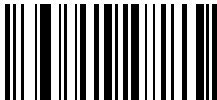

**e**



**f**



**g**



**h**



**i**



**j**

**Alphanumeric Barcodes (continued)**



k

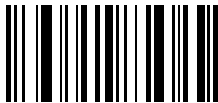

l



m



n



o

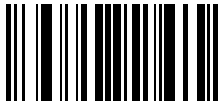

p

Alphanumeric Barcodes (continued)



q



r



s



t



u

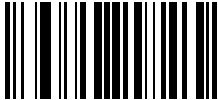

v

Alphanumeric Barcodes (continued)



w



x



y



z



{



|

---

**Alphanumeric Barcodes (continued)**



}

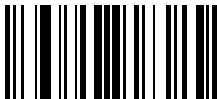

~

# ASCII Character Sets



**NOTE:** For the Keyboard Wedge Interface, Code 39 Full ASCII interprets the barcode special character (\$ + % /) preceding a Code 39 character and assigns an ASCII character value to the pair. For example, if you enable Code 39 Full ASCII and scan **+B**, it transmits as **b**, **%J** as **?**, and **%V** as **@**. Scanning **ABC%I** outputs the keystroke equivalent of **ABC >**.

**Table 38** ASCII Character Set

ASCII Value (Prefix/Suffix Value)	Full ASCII Code 39 Encode Char	Keystroke	ASCII Character (Applies to RS-232 Only)
1000	%U	CTRL 2	NUL
1001	\$A	CTRL A	SOH
1002	\$B	CTRL B	STX
1003	\$C	CTRL C	ETX
1004	\$D	CTRL D	EOT
1005	\$E	CTRL E	ENQ
1006	\$F	CTRL F	ACK
1007	\$G	CTRL G	BELL
1008	\$H	CTRL H/ <b>BACKSPACE</b> <sup>1</sup>	BCKSPC
1009	\$I	CTRL I/ <b>HORIZONTAL TAB</b> <sup>1</sup>	HORIZ TAB
1010	\$J	CTRL J	LF/NW LN
1011	\$K	CTRL K	VT
1012	\$L	CTRL L	FF
1013	\$M	CTRL M/ <b>ENTER</b> <sup>1</sup>	CR/ENTER
1014	\$N	CTRL N	SO

<sup>1</sup>The keystroke in bold transmits only if you enabled Function Key Mapping on page 72 or page 136. Otherwise, the unbold keystroke transmits.



## ASCII Character Sets

**Table 38** ASCII Character Set (Continued)

ASCII Value (Prefix/Suffix Value)	Full ASCII Code 39 Encode Char	Keystroke	ASCII Character (Applies to RS-232 Only)
1015	\$O	CTRL O	SI
1016	\$P	CTRL P	DLE
1017	\$Q	CTRL Q	DC1/XON
1018	\$R	CTRL R	DC2
1019	\$S	CTRL S	DC3/XOFF
1020	\$T	CTRL T	DC4
1021	\$U	CTRL U	NAK
1022	\$V	CTRL V	SYN
1023	\$W	CTRL W	ETB
1024	\$X	CTRL X	CAN
1025	\$Y	CTRL Y	EM
1026	\$Z	CTRL Z	SUB
1027	%A	CTRL [	ESC
1028	%B	CTRL \	FS
1029	%C	CTRL ]	GS
1030	%D	CTRL 6	RS
1031	%E	CTRL -	US
1032	Space	Space	Space
1033	/A	!	!
1034	/B	"	"
1035	/C	#	#
1036	/D	\$	\$
1037	/E	%	%
1038	/F	&	&
1039	/G	'	'
1040	/H	(	(
1041	/I	)	)
1042	/J	*	*
1043	/K	+	+

<sup>1</sup>The keystroke in bold transmits only if you enabled Function Key Mapping on page 72 or page 136. Otherwise, the unbold keystroke transmits.

## ASCII Character Sets

**Table 38** ASCII Character Set (Continued)

ASCII Value (Prefix/Suffix Value)	Full ASCII Code 39 Encode Char	Keystroke	ASCII Character (Applies to RS-232 Only)
1044	/L	,	,
1045	-	-	-
1046	.	.	.
1047	/o	/	/
1048	0	0	0
1049	1	1	1
1050	2	2	2
1051	3	3	3
1052	4	4	4
1053	5	5	5
1054	6	6	6
1055	7	7	7
1056	8	8	8
1057	9	9	9
1058	/Z	:	:
1059	%F	;	;
1060	%G	<	<
1061	%H	=	=
1062	%I	>	>
1063	%J	?	?
1064	%V	@	@
1065	A	A	A
1066	B	B	B
1067	C	C	C
1068	D	D	D
1069	E	E	E
1070	F	F	F
1071	G	G	G
1072	H	H	H

<sup>1</sup>The keystroke in bold transmits only if you enabled Function Key Mapping on page 72 or page 136. Otherwise, the unbold keystroke transmits.

## ASCII Character Sets

**Table 38** ASCII Character Set (Continued)

ASCII Value (Prefix/Suffix Value)	Full ASCII Code 39 Encode Char	Keystroke	ASCII Character (Applies to RS-232 Only)
1073	I	I	I
1074	J	J	J
1075	K	K	K
1076	L	L	L
1077	M	M	M
1078	N	N	N
1079	O	O	O
1080	P	P	P
1081	Q	Q	Q
1082	R	R	R
1083	S	S	S
1084	T	T	T
1085	U	U	U
1086	V	V	V
1087	W	W	W
1088	X	X	X
1089	Y	Y	Y
1090	Z	Z	Z
1091	%K	[	[
1092	%L	\	\
1093	%M	]	]
1094	%N	^	^
1095	%O	_	_
1096	%W	`	`
1097	+A	a	a
1098	+B	b	b
1099	+C	c	c
1100	+D	d	d
1101	+E	e	e

<sup>1</sup>The keystroke in bold transmits only if you enabled Function Key Mapping on page 72 or page 136. Otherwise, the unbold keystroke transmits.

**Table 38** ASCII Character Set (Continued)

ASCII Value (Prefix/Suffix Value)	Full ASCII Code 39 Encode Char	Keystroke	ASCII Character (Applies to RS-232 Only)
1102	+F	<b>f</b>	f
1103	+G	<b>g</b>	g
1104	+H	<b>h</b>	h
1105	+I	<b>i</b>	i
1106	+J	<b>j</b>	j
1107	+K	<b>k</b>	k
1108	+L	<b>l</b>	l
1109	+M	<b>m</b>	m
1110	+N	<b>n</b>	n
1111	+O	<b>o</b>	o
1112	+P	<b>p</b>	p
1113	+Q	<b>q</b>	q
1114	+R	<b>r</b>	r
1115	+S	<b>s</b>	s
1116	+T	<b>t</b>	t
1117	+U	<b>u</b>	u
1118	+V	<b>v</b>	v
1119	+W	<b>w</b>	w
1120	+X	<b>x</b>	x
1121	+Y	<b>y</b>	y
1122	+Z	<b>z</b>	z
1123	%P	<b>{</b>	{
1124	%Q	<b> </b>	
1125	%R	<b>}</b>	}
1126	%S	<b>~</b>	~
1127			Undefined
7013			ENTER

<sup>1</sup>The keystroke in bold transmits only if you enabled Function Key Mapping on page 72 or page 136. Otherwise, the unbold keystroke transmits.

**Table 39** ALT Key Character Set

ALT Keys	Keystroke
2045	ALT -
2050	ALT 2
2054	ALT 6
2064	ALT @
2065	ALT A
2066	ALT B
2067	ALT C
2068	ALT D
2069	ALT E
2070	ALT F
2071	ALT G
2072	ALT H
2073	ALT I
2074	ALT J
2075	ALT K
2076	ALT L
2077	ALT M
2078	ALT N
2079	ALT O
2080	ALT P
2081	ALT Q
2082	ALT R
2083	ALT S
2084	ALT T
2085	ALT U
2086	ALT V
2087	ALT W
2088	ALT X
2089	ALT Y
2090	ALT Z

**Table 39** ALT Key Character Set (Continued)

ALT Keys	Keystroke
2091	ALT [
2092	ALT \
2093	ALT ]

**Table 40** GUI Key Character Set

GUI Key	Keystroke
3000	Right Control Key
3048	GUI 0
3049	GUI 1
3050	GUI 2
3051	GUI 3
3052	GUI 4
3053	GUI 5
3054	GUI 6
3055	GUI 7
3056	GUI 8
3057	GUI 9
3065	GUI A
3066	GUI B
3067	GUI C
3068	GUI D
3069	GUI E
3070	GUI F
3071	GUI G
3072	GUI H
3073	GUI I
3074	GUI J
3075	GUI K
3076	GUI L

Note: GUI Shift Keys - The Apple™ iMac keyboard has an apple key on either side of the space bar. Windows-based systems have a GUI key to the left of the left ALT key, and to the right of the right ALT key.

**Table 40** GUI Key Character Set (Continued)

GUI Key	Keystroke
3077	GUI M
3078	GUI N
3079	GUI O
3080	GUI P
3081	GUI Q
3082	GUI R
3083	GUI S
3084	GUI T
3085	GUI U
3086	GUI V
3087	GUI W
3088	GUI X
3089	GUI Y
3090	GUI Z

Note: GUI Shift Keys - The Apple™ iMac keyboard has an apple key on either side of the space bar. Windows-based systems have a GUI key to the left of the left ALT key, and to the right of the right ALT key.

**Table 41** PF Key Character Set

PF Keys	Keystroke
4001	PF 1
4002	PF 2
4003	PF 3
4004	PF 4
4005	PF 5
4006	PF 6
4007	PF 7
4008	PF 8
4009	PF 9
4010	PF 10
4011	PF 11
4012	PF 12

**Table 41** PF Key Character Set (Continued)

PF Keys	Keystroke
4013	PF 13
4014	PF 14
4015	PF 15
4016	PF 16

**Table 42** F Key Character Set

F Keys	Keystroke
5001	F 1
5002	F 2
5003	F 3
5004	F 4
5005	F 5
5006	F 6
5007	F 7
5008	F 8
5009	F 9
5010	F 10
5011	F 11
5012	F 12
5013	F 13
5014	F 14
5015	F 15
5016	F 16
5017	F 17
5018	F 18
5019	F 19
5020	F 20
5021	F 21
5022	F 22
5023	F 23
5024	F 24



**Table 43** Numeric Key Character Set

Numeric Keypad	Keystroke
6042	*
6043	+
6044	Undefined
6045	-
6046	.
6047	/
6048	0
6049	1
6050	2
6051	3
6052	4
6053	5
6054	6
6055	7
6056	8
6057	9
6058	Enter
6059	Num Lock

**Table 44** Extended Key Character Set

Extended Keypad	Keystroke
7001	Break
7002	Delete
7003	Pg Up
7004	End
7005	Pg Dn
7006	Pause
7007	Scroll Lock
7008	Backspace
7009	Tab

**Table 44** Extended Key Character Set (Continued)

Extended Keypad	Keystroke
7010	Print Screen
7011	Insert
7012	Home
7013	Enter
7014	Escape
7015	Up Arrow
7016	Dn Arrow
7017	Left Arrow
7018	Right Arrow

# Programming Reference

---

## Symbol Code Identifiers

**Table 45** Symbol Code Characters

Code Character	Code Type
A	UPC-A, UPC-E, UPC-E1, EAN-8, EAN-13
B	Code 39, Code 32
C	Codabar
D	Code 128, ISBT 128, ISBT 128 Concatenated
E	Code 93
F	Interleaved 2 of 5
G	Discrete 2 of 5, or Discrete 2 of 5 IATA
H	Code 11
J	MSI
K	GS1-128
L	Bookland EAN
M	Trioptic Code 39
N	Coupon Code
R	GS1 DataBar Family
S	Matrix 2 of 5
T	UCC Composite, TLC 39
U	Chinese 2 of 5
V	Korean 3 of 5
X	ISSN EAN, PDF417, Macro PDF417, Micro PDF417
z	Aztec, Aztec Rune

**Table 45** Symbol Code Characters (Continued)

Code Character	Code Type
P00	Data Matrix
P01	QR Code, MicroQR
P02	Maxicode
P03	US Postnet
P04	US Planet
P05	Japan Postal
P06	UK Postal
P08	Netherlands KIX Code
P09	Australia Post
P0A	USPS 4CB/One Code/Intelligent Mail
P0B	UPU FICS Postal
P0C	Mailmark
P0D	Grid Matrix
P0G	GS1 Data Matrix
P0H	Han Xin
P0Q	GS1 QR
P0X	Signature Capture

## AIM Code Identifiers

Each AIM Code Identifier contains the three-character string **Jcm** where:

- J = Flag Character (ASCII 93)
- c = Code Character (see [Table 46](#))
- m = Modifier Character (see [Table 47](#))

**Table 46** Aim Code Characters

Code Character	Code Type
A	Code 39, Code 39 Full ASCII, Code 32
C	Code 128, ISBT 128, ISBT 128 Concatenated, GS1-128, Coupon (Code 128 portion)
d	Data Matrix, GS1 Data Matrix
E	UPC/EAN, Coupon (UPC portion)
e	GS1 DataBar Family
F	Codabar
G	Code 93
g	Grid Matrix
H	Code 11
h	Han Xin
I	Interleaved 2 of 5
L	PDF417, Macro PDF417, Micro PDF417
L2	TLC 39
M	MSI
Q	QR Code, MicroQR, GS1 QR
S	Discrete 2 of 5, IATA 2 of 5
U	Maxicode
z	Aztec, Aztec Rune
X	Bookland EAN, ISSN EAN, Trioptic Code 39, Chinese 2 of 5, Matrix 2 of 5, Korean 3 of 5, US Postnet, US Planet, UK Postal, Japan Postal, Australia Post, Netherlands KIX Code, USPS 4CB/One Code/ Intelligent Mail, UPU FICS Postal, Mailmark, Signature Capture

The modifier character is the sum of the applicable option values based on [Table 47](#).

**Table 47** Modifier Characters

Code Type	Option Value	Option
<b>Code 39</b>	0	No check character or Full ASCII processing.
	1	Reader has checked one check character.
	3	Reader has checked and stripped check character.
	4	Reader has performed Full ASCII character conversion.
	5	Reader has performed Full ASCII character conversion and checked one check character.
	7	Reader has performed Full ASCII character conversion and checked and stripped check character.
	Example: A Full ASCII barcode with check character W, <b>A+I+MI+DW</b> , is transmitted as <b>JA7AIMID</b> where 7 = (3+4).	
<b>Trioptic Code 39</b>	0	No option specified at this time. Always transmit 0.
	Example: A Trioptic barcode 412356 is transmitted as <b>JX0412356</b>	
<b>Code 128</b>	0	Standard data packet, no Function code 1 in first symbol position.
	1	Function code 1 in first symbol character position.
	2	Function code 1 in second symbol character position.
	Example: A Code (EAN) 128 barcode with Function 1 character <sup>FNC1</sup> in the first position, AIMID is transmitted as <b>JC1AIMID</b>	
<b>I 2 of 5</b>	0	No check digit processing.
	1	Reader has validated check digit.
	3	Reader has validated and stripped check digit.
	Example: An I 2 of 5 barcode without check digit, 4123, is transmitted as <b>J104123</b>	
<b>Codabar</b>	0	No check digit processing.
	1	Reader has checked check digit.
	3	Reader has stripped check digit before transmission.
	Example: A Codabar barcode without check digit, 4123, is transmitted as <b>JF04123</b>	
<b>Code 93</b>	0	No options specified at this time. Always transmit 0.
	Example: A Code 93 barcode 012345678905 is transmitted as <b>JG0012345678905</b>	
<b>MSI</b>	0	Check digits are sent.
	1	No check digit is sent.
	Example: An MSI barcode 4123, with a single check digit checked, is transmitted as <b>JM14123</b>	

**Table 47** Modifier Characters (Continued)

Code Type	Option Value	Option
<b>D 2 of 5</b>	0	No options specified at this time. Always transmit 0.
	Example: A D 2 of 5 barcode 4123, is transmitted as <b>JS0</b> 4123	
<b>UPC/EAN</b>	0	Standard data packet in full EAN format, i.e., 13 digits for UPC-A, UPC-E, and EAN-13 (not including supplemental data).
	1	Two digit supplemental data only.
	2	Five digit supplemental data only.
	3	Combined data packet comprising 13 digits from EAN-13, UPC-A or UPC-E symbol and 2 or 5 digits from supplemental symbol.
	4	EAN-8 data packet.
	Example: A UPC-A barcode 012345678905 is transmitted as <b>JE00</b> 12345678905	
<b>Bookland EAN</b>	0	No options specified at this time. Always transmit 0.
	Example: A Bookland EAN barcode 123456789X is transmitted as <b>JX0</b> 123456789X	
<b>ISSN EAN</b>	0	No options specified at this time. Always transmit 0.
	Example: An ISSN EAN barcode 123456789X is transmitted as <b>JX0</b> 123456789X	
<b>Code 11</b>	0	Single check digit
	1	Two check digits
	3	Check characters validated but not transmitted.
<b>GS1 DataBar Family</b>		No option specified at this time. Always transmit 0. GS1 DataBar Omnidirectional and GS1 DataBar Limited transmit with an Application Identifier "01". Note: In GS1-128 emulation mode, GS1 DataBar is transmitted using Code 128 rules (i.e., JC1).
	Example: A GS1 DataBar Omnidirectional barcode 0110012345678902 is transmitted as <b>Je00</b> 110012345678902.	

**Table 47** Modifier Characters (Continued)

Code Type	Option Value	Option
<b>EAN.UCC Composites (GS1 DataBar, GS1-128, 2D portion of UPC composite)</b>		Native mode transmission. Note: UPC portion of composite is transmitted using UPC rules.
	0	Standard data packet.
	1	Data packet containing the data following an encoded symbol separator character.
	2	Data packet containing the data following an escape mechanism character. The data packet does not support the ECI protocol.
	3	Data packet containing the data following an escape mechanism character. The data packet supports the ECI protocol.
		GS1-128 emulation Note: UPC portion of composite is transmitted using UPC rules.
	1	Data packet is a GS1-128 symbol (i.e., data is preceded with JJC1).
<b>PDF417, Micro PDF417</b>	0	Reader set to conform to protocol defined in 1994 PDF417 symbology specifications. <b>Note:</b> When this option is transmitted, the receiver cannot reliably determine whether ECIs have been invoked or whether data byte 92 <sub>DEC</sub> has been doubled in transmission.
	1	Reader set to follow the ECI protocol (Extended Channel Interpretation). All data characters 92 <sub>DEC</sub> are doubled.
	2	Reader set for Basic Channel operation (no escape character transmission protocol). Data characters 92 <sub>DEC</sub> are not doubled. <b>Note:</b> When decoders are set to this mode, unbuffered Macro symbols and symbols requiring the decoder to convey ECI escape sequences cannot be transmitted.
	3	The barcode contains a GS1-128 symbol, and the first codeword is 903-907, 912, 914, 915.
	4	The barcode contains a GS1-128 symbol, and the first codeword is in the range 908-909.
	5	The barcode contains a GS1-128 symbol, and the first codeword is in the range 910-911.
		Example: A PDF417 barcode ABCD, with no transmission protocol enabled, is transmitted as JL2ABCD.



**Table 47** Modifier Characters (Continued)

Code Type	Option Value	Option
<b>Data Matrix</b>	0	ECC 000-140, not supported.
	1	ECC 200.
	2	ECC 200, FNC1 in first or fifth position.
	3	ECC 200, FNC1 in second or sixth position.
	4	ECC 200, ECI protocol implemented.
	5	ECC 200, FNC1 in first or fifth position, ECI protocol implemented.
	6	ECC 200, FNC1 in second or sixth position, ECI protocol implemented.
<b>GS1 Data Matrix</b>	2	ECC 200, FNC1 in first or fifth position.
<b>MaxiCode</b>	0	Symbol in Mode 4 or 5.
	1	Symbol in Mode 2 or 3.
	2	Symbol in Mode 4 or 5, ECI protocol implemented.
	3	Symbol in Mode 2 or 3, ECI protocol implemented in secondary message.
<b>QR Code</b>	0	Model 1 symbol.
	1	Model 2 / MicroQR symbol, ECI protocol not implemented.
	2	Model 2 symbol, ECI protocol implemented.
	3	Model 2 symbol, ECI protocol not implemented, FNC1 implied in first position.
	4	Model 2 symbol, ECI protocol implemented, FNC1 implied in first position.
	5	Model 2 symbol, ECI protocol not implemented, FNC1 implied in second position.
	6	Model 2 symbol, ECI protocol implemented, FNC1 implied in second position.
<b>GS1 QR</b>	3	Model 2 symbol, ECI protocol not implemented, FNC1 implied in first position.
<b>Aztec</b>	0	Aztec symbol.
	C	Aztec Rune symbol.
<b>Han Xin</b>	0	Generic data, no special features are set. The transmitted data does not follow the AIM ECI protocol.
	1	ECI protocol enabled. There is at least one ECI mode encoded. Transmitted data must follow the AIM ECI protocol.
<b>Mailmark</b>	0	No option specified at this time. Always transmit 0.

# Communication Protocol Functionality

## Functionality Supported via Communication (Cable) Interface

Table 48 lists supported scanner functionality by communication protocol.

**Table 48** Communication Interface Functionality

Communication Interfaces	Functionality		
	Data Transmission	Remote Management	Image and Video Transmission
<b>USB</b>			
HID Keyboard Emulation	Supported	Not Available	Not Available
Simple COM Port Emulation	Supported	Not Available	Not Available
CDC COM Port Emulation	Supported	Not Available	Not Available
SSI over CDC COM Port Emulation	Supported	Supported	Supported
IBM Table-top USB	Supported	Supported	Not Available
IBM Hand-held USB	Supported	Supported	Not Available
USB OPOS Hand-held	Supported	Supported	Not Available
Symbol Native API (SNAPI) without Imaging Interface	Supported	Supported	Not Available
Symbol Native API (SNAPI) with Imaging Interface	Supported	Supported	Supported
<b>RS-232</b>			
Standard RS-232	Supported	Not Available	Not Available
ICL RS-232	Supported	Not Available	Not Available
Fujitsu RS-232	Supported	Not Available	Not Available
Wincor-Nixdorf RS-232 Mode A	Supported	Not Available	Not Available
Wincor-Nixdorf RS-232 Mode B	Supported	Not Available	Not Available
Olivetti ORS4500	Supported	Not Available	Not Available

**Table 48** Communication Interface Functionality (Continued)

Communication Interfaces	Functionality		
	Data Transmission	Remote Management	Image and Video Transmission
Omron	Supported	Not Available	Not Available
CUTE	Supported	Not Available	Not Available
OPOS/JPOS	Supported	Not Available	Not Available
SSI	Supported	Supported	Supported
<b>IBM 4690</b>			
Hand-held Scanner Emulation (Port 9B)	Supported	Not Available	Not Available
Table-top Scanner Emulation (Port 17)	Supported	Supported	Not Available
Non-IBM Scanner Emulation (Port 5B)	Supported	Supported	Not Available
<b>Keyboard Wedge</b>			
IBM PC/AT & IBM PC Compatibles	Supported	Not Available	Not Available
IBM AT Notebook	Supported	Not Available	Not Available

# Country Codes

---

## Introduction

This chapter provides instructions for programming the keyboard to interface with a USB or keyboard wedge host. The host powers the scanner. For host setup information, see [USB Interface](#) and [Keyboard Wedge Interface](#).

To select a code page for the country keyboard type, see [Country Code Pages](#).

Throughout the programming barcode menus, default values are indicated with asterisks (\*).

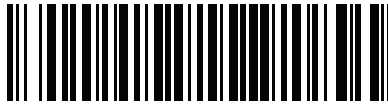

\* Indicates default      \*Enable Parameter      Feature/option

---

## USB and Keyboard Wedge Country Keyboard Types (Country Codes)

Scan the barcode corresponding to the keyboard type. For a USB host, this setting applies only to the USB Keyboard (HID) device. If the keyboard type is not listed, see [Keypad Emulation on page 70](#) for the USB HID host. For a keyboard wedge host, see [Alternate Numeric Keypad Emulation on page 133](#).



- NOTES**
- 1 When changing USB country keyboard types the scanner automatically resets and issues the standard startup beep sequences.
  2. For best results when using international keyboards, enable [Quick Keypad Emulation on page 70](#).



**IMPORTANT:** Some country keyboard barcode types are specific to certain Windows operating systems (i.e., XP and Windows 7 or higher). Barcodes requiring a specific Windows OS are noted in the barcode captions.

Use the **French International** barcode for Belgian French keyboards.

---

## Country Code Barcodes



**\*US English (North American)**

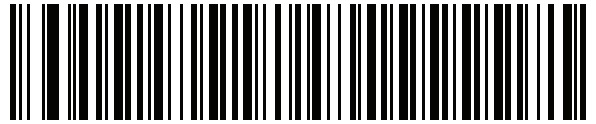

**US English (Mac)**



**Albanian**

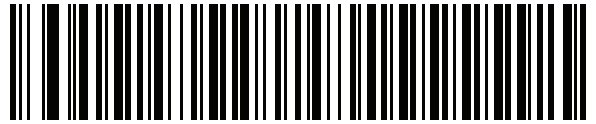

**Arabic (101)**

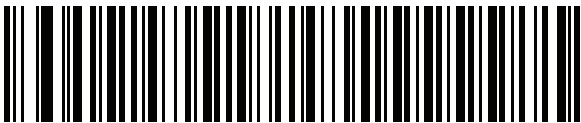

**Arabic (102)**

---

## Country Code Barcodes (continued)

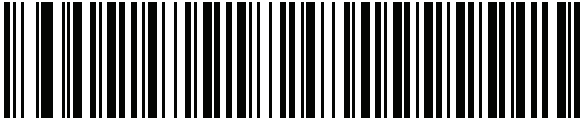

Arabic (102) AZERTY

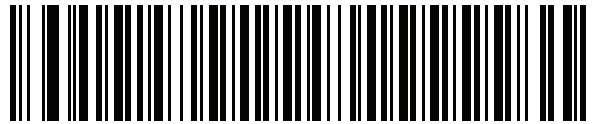

Azeri (Latin)

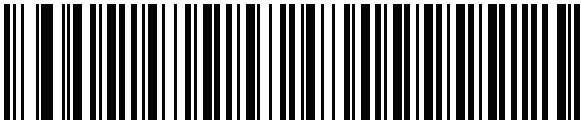

Azeri (Cyrillic)

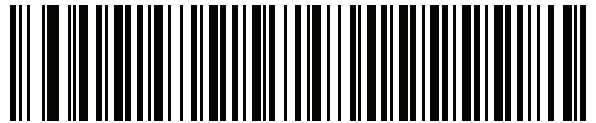

Belarusian



Bosnian (Latin)



Bosnian (Cyrillic)

---

## Country Code Barcodes (continued)

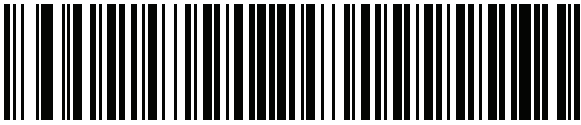

**Bulgarian (Latin)**

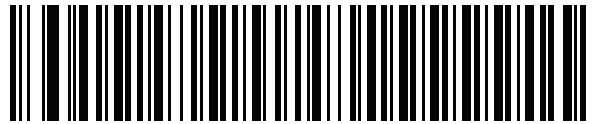

**Bulgarian Cyrillic (Typewriter)  
(Bulgarian -Windows XP  
Typewriter - Windows 7 or higher)**

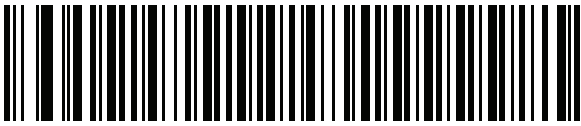

**Canadian French Win7**

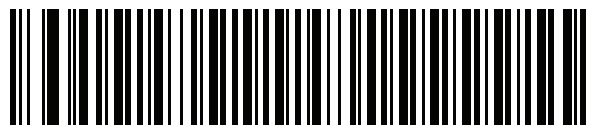

**Canadian French (Legacy)**

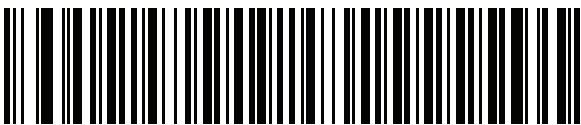

**Canadian Multilingual Standard**



**Chinese (ASCII)**

---

## Country Code Barcodes (continued)

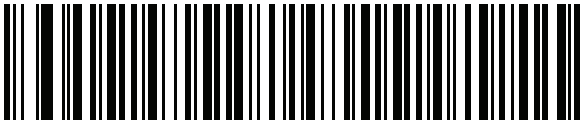

**Chinese (Simplified)\***

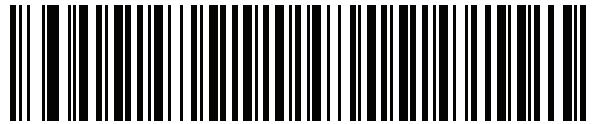

**Chinese (Traditional)\***

\*For CJK keyboard types, see [CJK Decode Control](#).

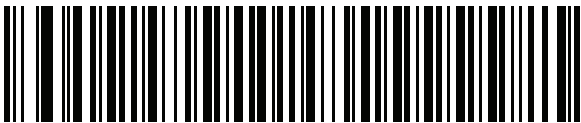

**Croatian**

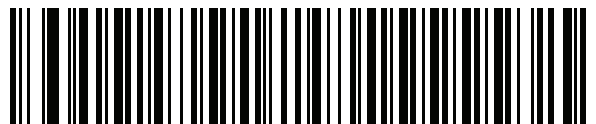

**Czech**



**Czech (Programmer)**

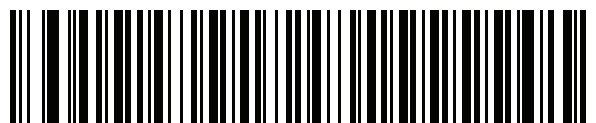

**Czech (QWERTY)**



---

**Country Code Barcodes (continued)**

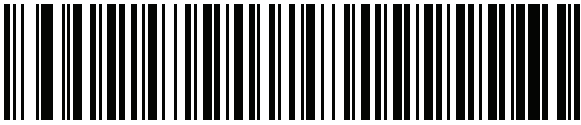

**Danish**

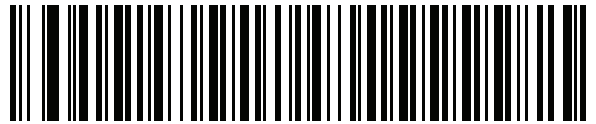

**Dutch (Netherlands)**

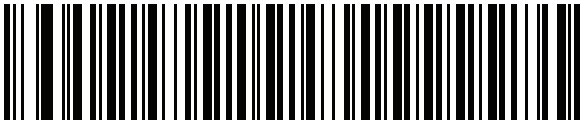

**Estonian**

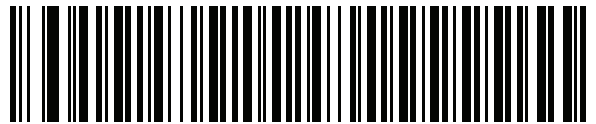

**Faeroese**



**Finnish**



**French (France)**

---

## Country Code Barcodes (continued)

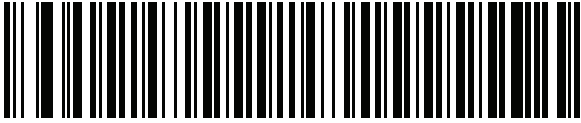

**French International  
(Belgian French)**

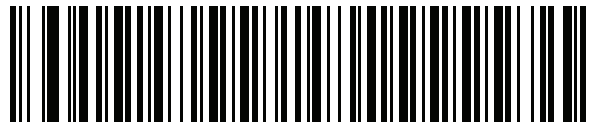

**French (Canada) 95/98**

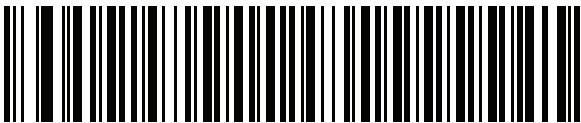

**French (Canada) 2000/XP\***

\*There is also a country code barcode for [Canadian Multilingual Standard on page 499](#). Be sure to select the appropriate barcode for your host system.

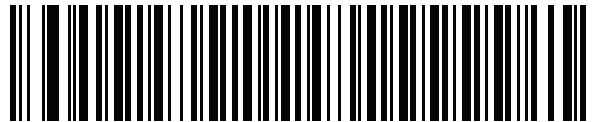

**Galician**

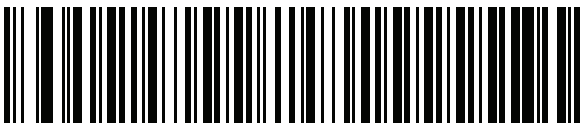

**German**



**Greek Latin**

---

## Country Code Barcodes (continued)

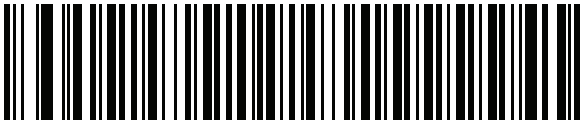

Greek (220) Latin

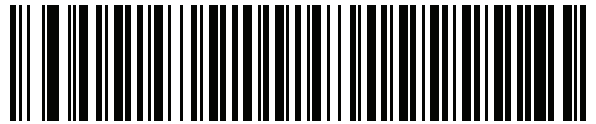

Greek (319) Latin

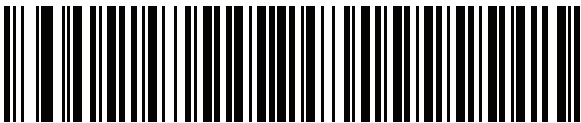

Greek



Greek (220)



Greek (319)



Greek Polytonic

---

**Country Code Barcodes (continued)**

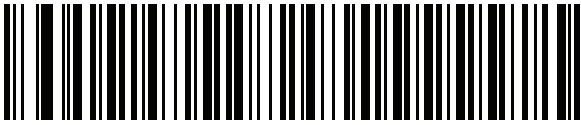

**Hebrew Israel**

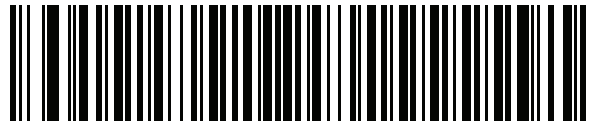

**Hungarian**

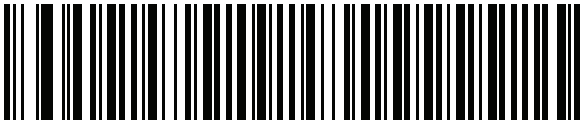

**Hungarian\_101KEY**

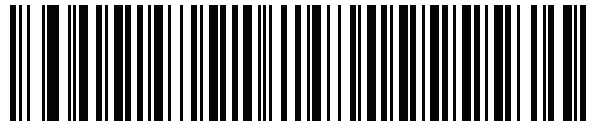

**Icelandic**



**Irish**



**Italian**

---

## Country Code Barcodes (continued)

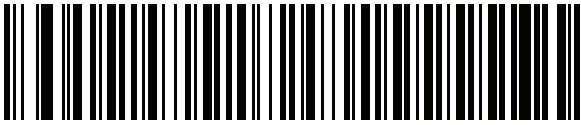

Italian (142)

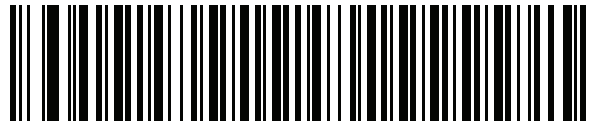

Japanese (ASCII)

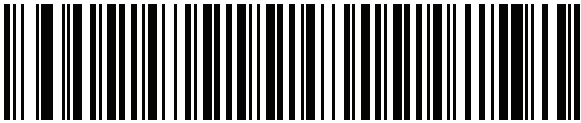

Japanese (SHIFT-JIS)\*

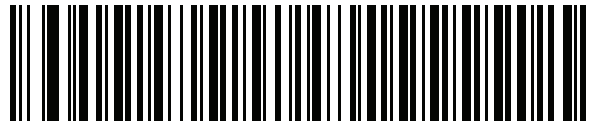

Kazakh



Korean (ASCII)



Korean (Hangul)\*

\*For CJK keyboard types, see [CJK Decode Control](#).

---

**Country Code Barcodes (continued)**

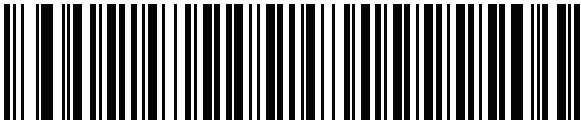

**Kyrgyz**

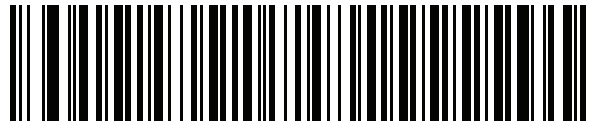

**Latin American**

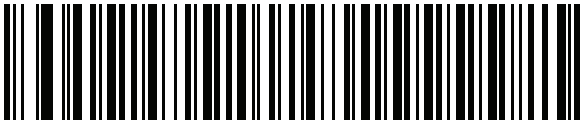

**Latvian**

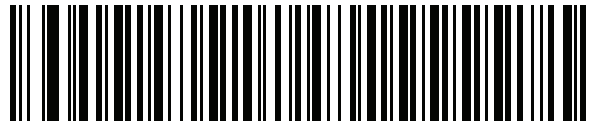

**Latvian (QWERTY)**

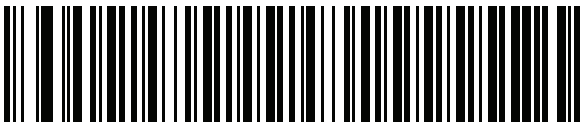

**Lithuanian**

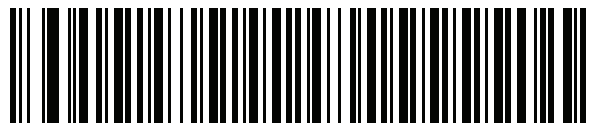

**Lithuanian (IBM)**

---

**Country Code Barcodes (continued)**

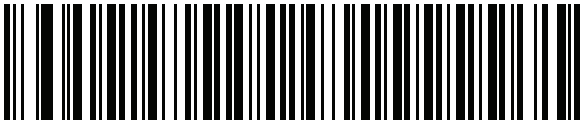

**Macedonian (FYROM)**

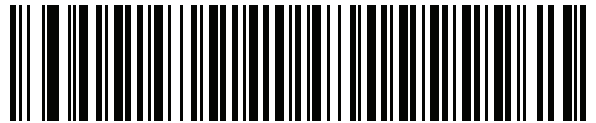

**Maltese\_47KEY**

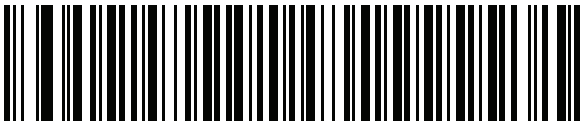

**Mongolian**

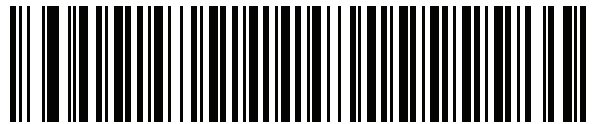

**Norwegian**



**Polish (214)**



**Polish (Programmer)**

---

## Country Code Barcodes (continued)

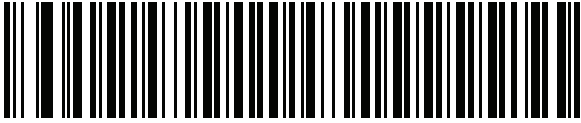

**Portuguese (Brazil)  
(Windows XP)**

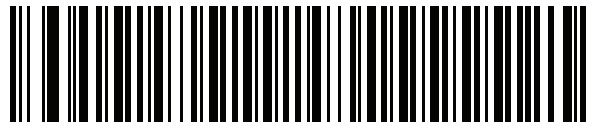

**Portuguese (Brazilian ABNT)**

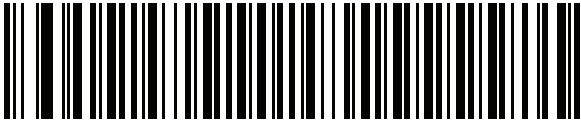

**Portuguese (Brazilian ABNT2)**

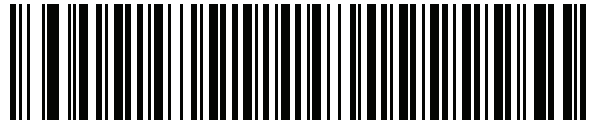

**Portuguese (Portugal)**

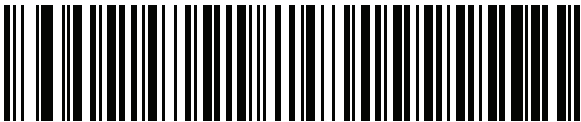

**Romanian  
(Windows XP)**

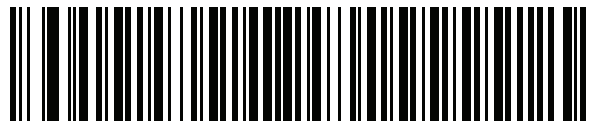

**Romanian (Legacy)  
(Windows 7 or higher)**



---

## Country Code Barcodes (continued)

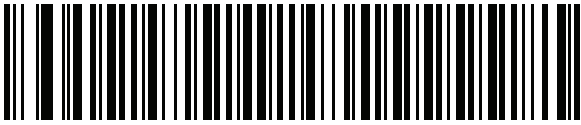

**Romanian (Standard)  
(Windows 7 or higher)**

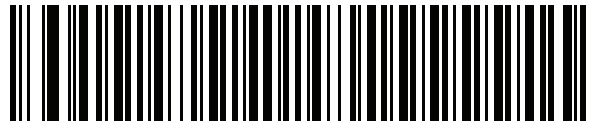

**Romanian (Programmer)  
(Windows 7 or higher)**

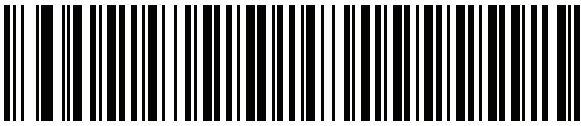

**Russian**

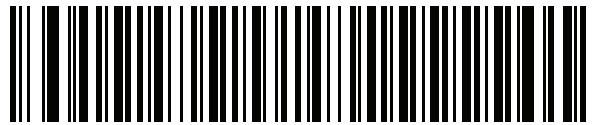

**Russian (Typewriter)**



**Serbian (Latin)**

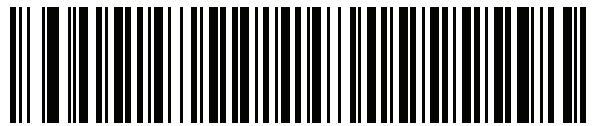

**Serbian (Cyrillic)**

---

**Country Code Barcodes (continued)**

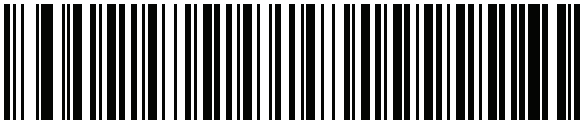

**Slovak**

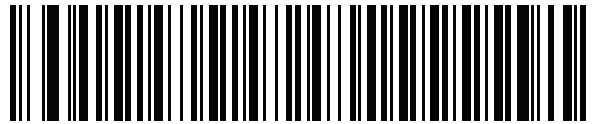

**Slovak (QWERTY)**

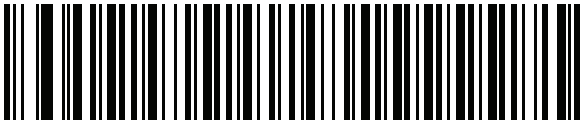

**Slovenian**

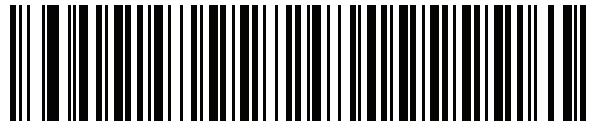

**Spanish**



**Spanish (Variation)**



**Swedish**

---

**Country Code Barcodes (continued)**

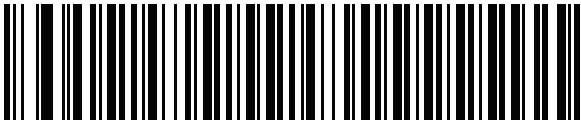

**Swiss French**

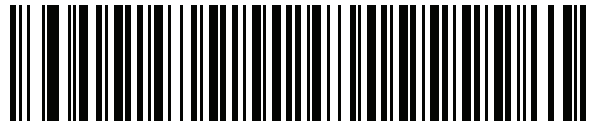

**Swiss German**

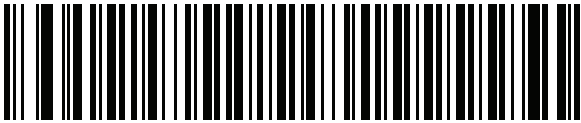

**Tatar**

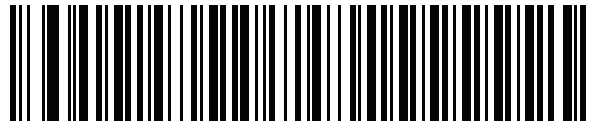

**Thai (Kedmanee)**



**Turkish F**



**Turkish Q**

---

## Country Code Barcodes (continued)

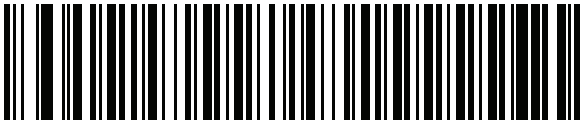

UK English

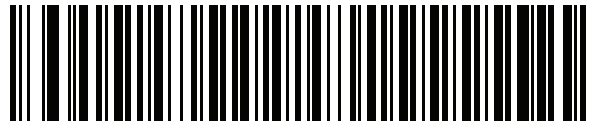

Ukrainian

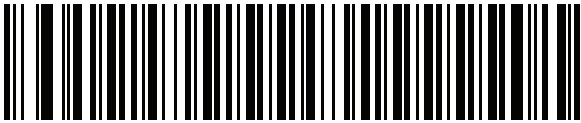

US Dvorak

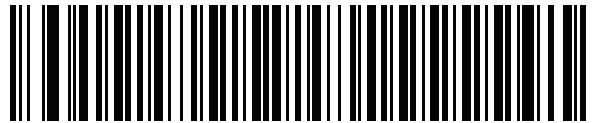

US Dvorak Left



US Dvorak Right



US International

---

**Country Code Barcodes (continued)**

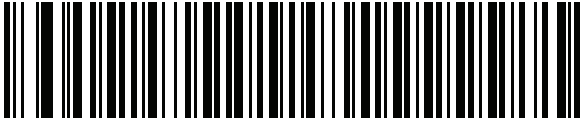

**Uzbek**

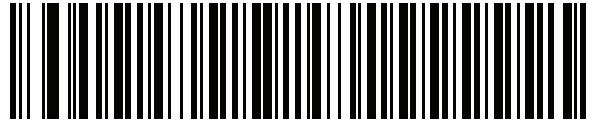

**Vietnamese**

# Country Code Pages

---

## Introduction

This chapter provides barcodes for selecting code pages for the country keyboard type selected in [Country Codes](#). If the default code page in [Table 49](#) is appropriate for your selected country keyboard type, you do not need to scan a country code page barcode.



**NOTE:** ADF rules can also specify a code page based on the symbology and other ADF criteria. Refer to the [Advanced Data Formatting Programmer Guide](#).

---

## Country Code Page Defaults

[Table 49](#) lists the code page default for each country keyboard.

**Table 49** Country Code Page Defaults

Country Keyboard	Code Page Default
US English (North American)	Windows 1252
US English (Mac)	Mac CP10000
Albanian	Windows 1250
Arabic 101	Windows 1256
Arabic 102	Windows 1256
Arabic 102 AZERTY	Windows 1256
Azeri Latin	Windows 1254
Azeri Cyrillic	Windows 1251
Belarusian	Windows 1251
Bosnian Latin	Windows 1250
Bosnian Cyrillic	Windows 1251
Bulgarian Latin	Windows 1250
Bulgarian Cyrillic	Windows 1251

**Table 49** Country Code Page Defaults (Continued)

Country Keyboard	Code Page Default
Canadian French Win7	Windows 1252
Canadian French (Legacy)	Windows 1252
Canadian Multilingual	Windows 1252
Croatian	Windows 1250
Chinese ASCII	Windows 1252
Chinese (Simplified)	Windows 936, GBK
Chinese (Traditional)	Windows 950, Big5
Czech	Windows 1250
Czech Programmers	Windows 1250
Czech QWERTY	Windows 1250
Danish	Windows 1252
Dutch Netherland	Windows 1252
Estonian	Windows 1257
Faeroese	Windows 1252
Finnish	Windows 1252
French (France)	Windows 1252
French (Canada) 95/98	Windows 1252
French (Canada) 2000/XP	Windows 1252
French International (Belgian French)	Windows 1252
Galician	Windows 1252
German	Windows 1252
Greek Latin	Windows 1252
Greek220 Latin	Windows 1253
Greek319 Latin	Windows 1252
Greek	Windows 1253
Greek220	Windows 1253
Greek319	Windows 1253
Greek Polytonic	Windows 1253
Hebrew Israel	Windows 1255
Hungarian	Windows 1250
Hungarian_101KEY	Windows 1250

**Table 49** Country Code Page Defaults (Continued)

Country Keyboard	Code Page Default
Icelandic	Windows 1252
Irish	Windows 1252
Italian	Windows 1252
Italian_142	Windows 1252
Japanese ASCII	Windows 1252
Japanese (Shift-JIS)	Windows 932, Shift-JIS
Kazakh	Windows 1251
Korean ASCII	Windows 1252
Korean (Hangul)	Windows 949, Hangul
Kyrgyz Cyrillic	Windows 1251
Latin America	Windows 1252
Latvian	Windows 1257
Latvian QWERTY	Windows 1257
Lithuanian	Windows 1257
Lithuanian_IBM	Windows 1257
Macedonian -FYROM	Windows 1251
Maltese_47KEY	Windows 1252
Mongolian-Cyrillic	Windows 1251
Norwegian	Windows 1252
Polish_214	Windows 1250
Polish Programmer	Windows 1250
Portuguese Brazil	Windows 1252
Portuguese Brazilian ABNT	Windows 1252
Portuguese Brazilian ABNT2	Windows 1252
Portuguese Portugal	Windows 1252
Romanian	Windows 1250
Romanian Legacy	Windows 1250
Romanian Standard	Windows 1250
Romanian Programmer	Windows 1250
Russian	Windows 1251
Russian Typewriter	Windows 1251







**Table 49** Country Code Page Defaults (Continued)

Country Keyboard	Code Page Default
Serbian Latin	Windows 1250
Serbian Cyrillic	Windows 1251
Slovak	Windows 1250
Slovak QWERTY	Windows 1250
Slovenian	Windows 1250
Spanish	Windows 1252
Spanish Variation	Windows 1252
Swedish	Windows 1252
Swiss French	Windows 1252
Swiss German	Windows 1252
Tatar	Windows 1251
Thai-Kedmanee	Windows 874
Turkish F	Windows 1254
Turkish Q	Windows 1254
Ukrainian	Windows 1251
United Kingdom	Windows 1252
United States	Windows 1252
US Dvorak	Windows 1252
US Dvorak Left Hand	Windows 1252
US Dvorak Right Hand	Windows 1252
US International	Windows 1252
Uzbek Cyrillic	Windows 1251
Vietnamese	Windows 1258

## Country Code Page Barcodes

Scan the barcode corresponding to the country keyboard code page.

 <p><b>Windows 1250</b> Latin 2, Central European</p>	
	 <p><b>Windows 1251</b> Cyrillic, Slavic</p>
 <p><b>Windows 1252</b> Latin 1, Western European</p>	
	 <p><b>Windows 1253</b> Greek</p>
 <p><b>Windows 1254</b> Latin 5, Turkish</p>	



**Windows 1250**  
**Latin 2, Central European**



**Windows 1251**  
**Cyrillic, Slavic**

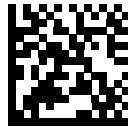

**Windows 1252**  
**Latin 1, Western European**



**Windows 1253**  
**Greek**



**Windows 1254**  
**Latin 5, Turkish**

**Country Code Page Barcodes (continued)**

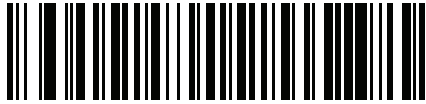

**Windows 1255  
Hebrew**

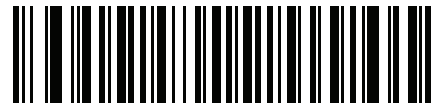

**Windows 1256  
Arabic**



**Windows 1257  
Baltic**



**Windows 1258  
Vietnamese**

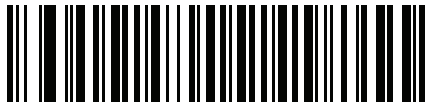

**Windows 874  
Thai**

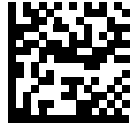

**Windows 1255**  
**Hebrew**



**Windows 1256**  
**Arabic**

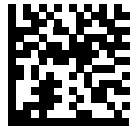

**Windows 1257**  
**Baltic**



**Windows 1258**  
**Vietnamese**



**Windows 874**  
**Thai**

**Country Code Page Barcodes (continued)**



**Windows 20866  
Cyrillic KOI8-R**

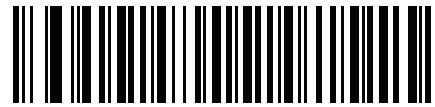

**Windows 932  
Japanese Shift-JIS**



**Windows 936  
Simplified Chinese GBK**

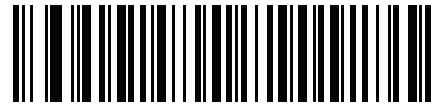

**Windows 54936  
Simplified Chinese GB18030**

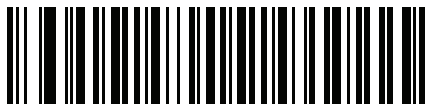

**Windows 949  
Korean Hangul**



**Windows 20866  
Cyrillic KOI8-R**



**Windows 932  
Japanese Shift-JIS**

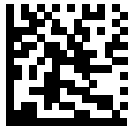

**Windows 936  
Simplified Chinese GBK**



**Windows 54936  
Simplified Chinese GB18030**



**Windows 949  
Korean Hangul**

**Country Code Page Barcodes (continued)**

 <p><b>Windows 950</b> <b>Traditional Chinese Big5</b></p>	
	 <p><b>MS-DOS 437</b> <b>Latin US</b></p>
 <p><b>MS-DOS 737</b> <b>Greek</b></p>	
	 <p><b>MS-DOS 775</b> <b>Baltic</b></p>
 <p><b>MS-DOS 850</b> <b>Latin 1</b></p>	



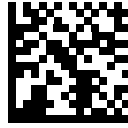

**Windows 950**  
**Traditional Chinese Big5**



**MS-DOS 437**  
**Latin US**

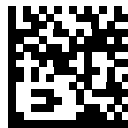

**MS-DOS 737**  
**Greek**

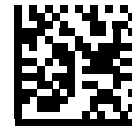

**MS-DOS 775**  
**Baltic**



**MS-DOS 850**  
**Latin 1**

**Country Code Page Barcodes (continued)**

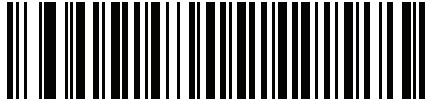

**MS-DOS 852**  
Latin 2

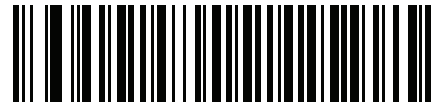

**MS-DOS 855**  
Cyrillic

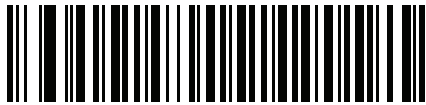

**MS-DOS 857**  
Turkish

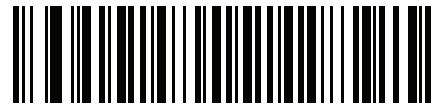

**MS-DOS 860**  
Portuguese



**MS-DOS 861**  
Icelandic

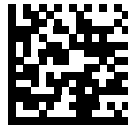

**MS-DOS 852**  
Latin 2



**MS-DOS 855**  
Cyrillic

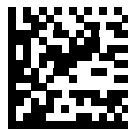

**MS-DOS 857**  
Turkish



**MS-DOS 860**  
Portuguese



**MS-DOS 861**  
Icelandic

**Country Code Page Barcodes (continued)**

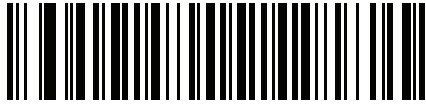

**MS-DOS 862  
Hebrew**

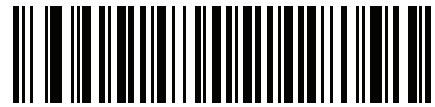

**MS-DOS 863  
French Canada**

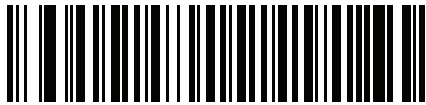

**MS-DOS 865  
Nordic**

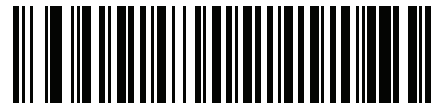

**MS-DOS 866  
Cyrillic**

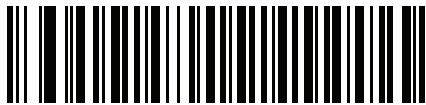

**MS-DOS 869  
Greek 2**

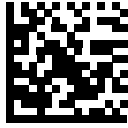

**MS-DOS 862**  
Hebrew



**MS-DOS 863**  
French Canada

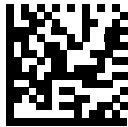

**MS-DOS 865**  
Nordic



**MS-DOS 866**  
Cyrillic

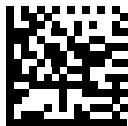

**MS-DOS 869**  
Greek 2

**Country Code Page Barcodes (continued)**



**ISO 8859-1**  
**Latin 1, Western European**

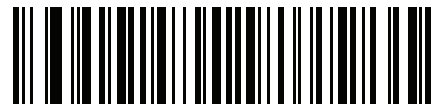

**ISO 8859-2**  
**Latin 2, Central European**



**ISO 8859-3**  
**Latin 3, South European**

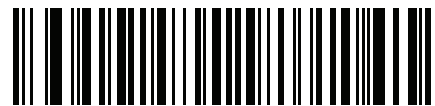

**ISO 8859-4**  
**Latin 4, North European**



**ISO 8859-5**  
**Cyrillic**



**ISO 8859-1**  
**Latin 1, Western European**



**ISO 8859-2**  
**Latin 2, Central European**



**ISO 8859-3**  
**Latin 3, South European**







**ISO 8859-4**  
**Latin 4, North European**



**ISO 8859-5**  
**Cyrillic**

**Country Code Page Barcodes (continued)**

 <p><b>ISO 8859-6</b> Arabic</p>	
	 <p><b>ISO 8859-7</b> Greek</p>
 <p><b>ISO 8859-8</b> Hebrew</p>	
	 <p><b>ISO 8859-9</b> Latin 5, Turkish</p>
 <p><b>ISO 8859-10</b> Latin 6, Nordic</p>	



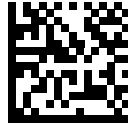

**ISO 8859-6**  
Arabic



**ISO 8859-7**  
Greek

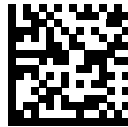

**ISO 8859-8**  
Hebrew





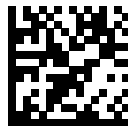

**ISO 8859-9**  
Latin 5, Turkish



**ISO 8859-10**  
Latin 6, Nordic

**Country Code Page Barcodes (continued)**

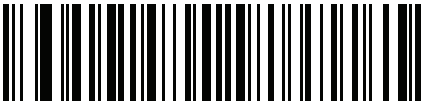
 <p><b>ISO 8859-11</b> Thai</p>	
	 <p><b>ISO 8859-13</b> Latin 7, Baltic</p>
 <p><b>ISO 8859-14</b> Latin 8, Celtic</p>	
	 <p><b>ISO 8859-15</b> Latin 9</p>
 <p><b>ISO 8859-16</b> Latin 10, South-Eastern European</p>	

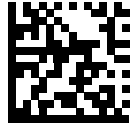

**ISO 8859-11**  
Thai



**ISO 8859-13**  
Latin 7, Baltic

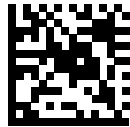

**ISO 8859-14**  
Latin 8, Celtic





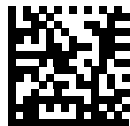

**ISO 8859-15**  
Latin 9

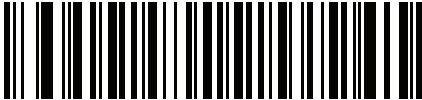
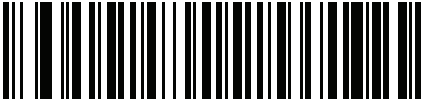
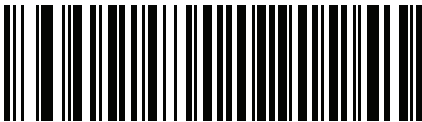

**ISO 8859-16**  
Latin 10, South-Eastern European

**Country Code Page Barcodes (continued)**

 <p>UTF-8</p>	
	 <p>UTF-16LE UTF-16 Little Endian</p>
 <p>UTF-16BE UTF-16 Big Endian</p>	
	 <p>Mac CP10000 Roman</p>
 <p>UTF-8</p>	

	 <p>UTF-16LE UTF-16 Little Endian</p>
 <p>UTF-16BE UTF-16 Big Endian</p>	
	 <p>Mac CP10000 Roman</p>

# CJK Decode Control

---

## Introduction

This appendix describes control parameters for CJK (Chinese, Japanese, Korean) barcode decode through USB HID Keyboard Emulation mode.



**NOTE:** Because ADF does not support CJK character processing, there is no format manipulation for CJK output.

## CJK Control Parameters

### Unicode Output Control

#### Parameter # 973



For a Unicode encoded CJK barcode, select one of the following options for unicode output:

- **Universal Output to Unicode and MBCS Application** - This default method applies to Unicode and MBCS expected applications, such as MS Word and Notepad on a Windows host.

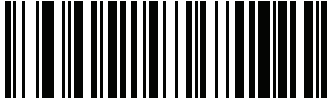

**NOTE:** To support Unicode universal output, set up the registry table for the Windows host. See [Unicode/CJK Decode Setup with Windows Host on page 548](#).

- **Output to Unicode Application Only** - This method applies only to Unicode expected applications, such as MS Word and WordPad, but not Notepad.

 <p><b>*Universal Output (0)</b></p>	
	 <p><b>Unicode Application Only (1)</b></p>
 <p><b>*Universal Output (0)</b></p>	
	 <p><b>Unicode Application Only (1)</b></p>

## CJK Output Method to Windows Host

### Parameter # 972

For a national standard encoded CJK barcode, select one of the following options for CJK output to a Windows host:

- **Universal CJK Output** - This is the default universal CJK output method for US English IME or Chinese/Japanese/Korean ASCII IME on a Windows host. This method converts CJK characters to Unicode and emulates the characters when transmitting to the host. Use the [Unicode Output Control](#) parameter to control Unicode output.





**NOTE:** To support universal CJK output, set up the registry table for the Windows host. See [Unicode/CJK Decode Setup with Windows Host on page 548](#).

- **Other options for CJK output** - With the following methods, the scanner sends the CJK character hexadecimal internal code (Nei Ma) value to the host, or converts the CJK character to Unicode and sends the hexadecimal Unicode value to the host. When using these methods, the Windows host must select the corresponding IME to accept the CJK character. See [Unicode/CJK Decode Setup with Windows Host on page 548](#).
  - **Japanese Unicode Output**
  - **Simplified Chinese GBK Code Output**
  - **Simplified Chinese Unicode Output**
  - **Korean Unicode Code Output**
  - **Traditional Chinese Big5 Code Output** (Windows XP)
  - **Traditional Chinese Big5 Code Output** (Windows 7)
  - **Traditional Chinese Unicode Code Output** (Windows XP)
  - **Traditional Chinese Unicode Code Output** (Windows 7)

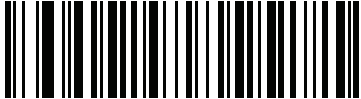

**NOTE:** The Unicode emulate output method depends on the host system (Windows XP or Windows 7).

 <p><b>*Universal CJK Output (0)</b></p>	
	 <p><b>Japanese Unicode Output (34)</b></p>
	<p>(For Japanese Unicode Output, select Simplified Chinese Unicode IME on the Windows host)</p>



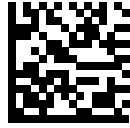







**\*Universal CJK Output  
(0)**



**Japanese Unicode Output  
(34)**

(For Japanese Unicode Output, select Simplified Chinese Unicode IME on the Windows host)

### CJK Output Method to Windows Host (continued)

 <p><b>Chinese (Simplified) GBK Output</b> (1)</p>	
	 <p><b>Chinese (Simplified) Unicode Output</b> (2)</p>
 <p><b>Korean Unicode Output</b> (50)</p>	
(for Korean Unicode Output, select Simplified Chinese Unicode IME on the Windows host)	 <p><b>Chinese (Traditional) Big5 Output (Windows XP)</b> (17)</p>
 <p><b>Chinese (Simplified) GBK Output</b> (1)</p>	
	 <p><b>Chinese (Simplified) Unicode Output</b> (2)</p>



**Korean Unicode Output  
(50)**



(for Korean Unicode Output, select Simplified Chinese Unicode IME on the Windows host)



**Chinese (Traditional) Big5 Output (Windows XP)  
(17)**

### CJK Output Method to Windows Host (continued)

 <p>Chinese (Traditional) Big5 Output (Windows 7) (19)</p>	
	 <p>Chinese (Traditional) Unicode Output (Windows XP) (18)</p>
 <p>Chinese (Traditional) Unicode Output (Windows 7) (20)</p>	
 <p>Chinese (Traditional) Big5 Output (Windows 7) (19)</p>	

	 <p>Chinese (Traditional) Unicode Output (Windows XP) (18)</p>
 <p>Chinese (Traditional) Unicode Output (Windows 7) (20)</p>	

## Non-CJK UTF Barcode Output

### Parameter # 960

Some country keyboard type layouts contain characters that do not exist in the default code page (see [Country Keyboard Type Missing Characters on page 547](#)). Although the default code page can not encode these characters in a barcode, they can be encoded in the UTF-8 barcode. Scan the following barcode to output the Unicode values by emulation mode.



**NOTE:** Use this special country keyboard type to decode the non-CJK UTF-8 barcode. After decoding, re-configure the scanner to use the original country keyboard type.

Use US English IME on Windows. See [Unicode Output Control on page 539](#).

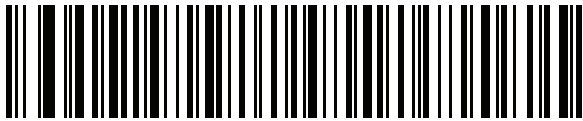

Non-CJK UTF-8 Emulation Output

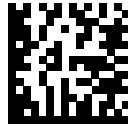

Non-CJK UTF-8 Emulation Output

## Country Keyboard Type Missing Characters

Country keyboard type: **Tatar, Uzbek, Mongolian, Kyrgyz, Kazakh and Azeri**

Default code page: CP1251

Missing characters:

ƒ	F
х	X
κ	K
h	h
ө	Ө
ә	Ә
Y	Y
Һ	Ҥ
ж	Ж
ƒ	
Һ	Ҥ
Y	Y
κ	K
ч	Ч
κ	K

Country keyboard type: **Romanian (Standard)**

Default code page: CP1250

Missing characters:

ș	Ș
ț	Ț

Country keyboard type: **Portuguese-Brazilian (ABNT), Portuguese-Brazilian (ABNT2)**

Default code page: CP1252

Missing character: **Ꞁ**

Country keyboard type: **Azeri-Latin**

Default code page: CP1254

Missing characters: ə, Ə

---

## Unicode/CJK Decode Setup with Windows Host

This section describes how to set up CJK decode with a Windows host.

### Setting Up the Windows Registry Table for Unicode Universal Output

To support the Unicode universal output method, set up the Windows host registry table as follows:

1. Select **Start > Run > regedt32** to start the registry editor.
2. Under **HKEY\_Current\_User\Control Panel\Input Method**, set **EnableHexNumpad** to **1** as follows:

```
[HKEY_CURRENT_USER\Control Panel\Input Method]
```

```
"EnableHexNumpad"="1"
```

If this key does not exist, add it as type **REG\_SZ** (string value).

3. Reboot the computer to implement the registry change.

### Adding CJK IME on Windows

To add the desired CJK input language:

1. Click **Start > Control Panel**.
2. If the Control Panel opens in category view, select **Switch to Classic View** in the top left corner.
3. Select **Regional and Language Options**.
4. Click the **Language** tab.
5. Under **Supplemental Language Support**, select the **Install Files for East Asian Languages** check box if not already selected, and click **Apply**. This may require a Windows installation CD to install the required files. This step ensures that the East Asian Languages (CJK) are available.
6. Under **Text Services and Input Language**, click **Details**.
7. Under **Installed Services**, click **Add**.
8. In the **Add Input Language** dialog box, choose the CJK input language and keyboard layout or Input Method Editor (IME) to add.
9. Click **OK** twice. The language indicator appears in the system tray (at bottom right corner of the desktop by default). To switch between input languages (keyboard languages) select the language indicator in the system tray.
10. Select the language indicator in the system tray to select the desired country keyboard type.
11. Verify that the characters displayed on each country's keyboard appear.



## Selecting the Simplified Chinese Input Method on the Host

To select the Simplified Chinese input method:

- Select Unicode/GBK input on Windows XP: **Chinese (Simplified) - NeiMa**, then click the input bar to select **Unicode** or **GBK NeiMa** input.

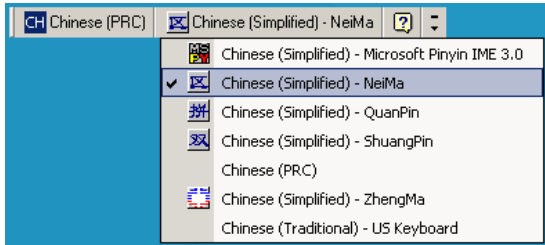

Or



- Select Unicode/GBK input on Windows 7: **Chinese (Simplified) - Microsoft Pinyin New Experience Input Style**, then select **Tool Menu > Secondary Inputs > Unicode Input** or **GB Code Input**.

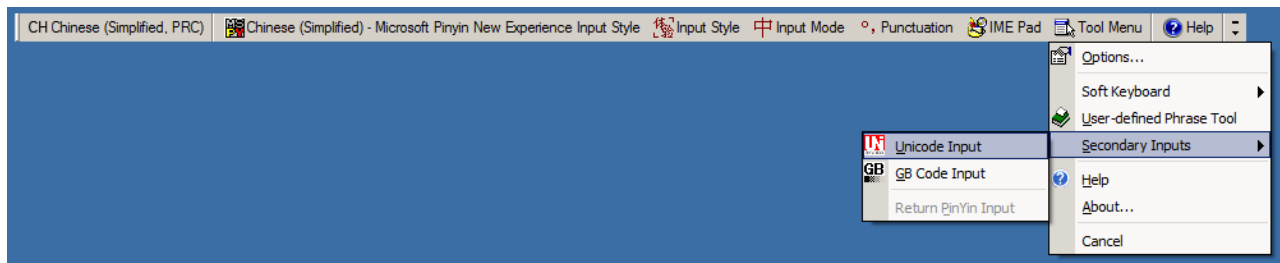

## Selecting the Traditional Chinese Input Method on the Host

To select the Traditional Chinese input method:

- Select Unicode input on Windows XP: **Chinese (Traditional) - Unicode**

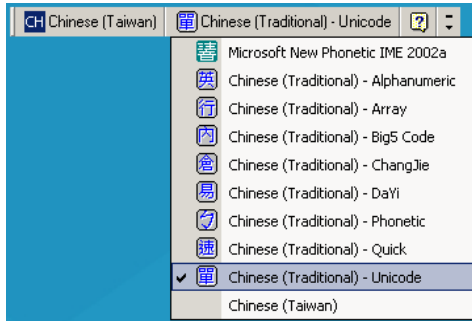

- Select Big5 input on Windows XP: **Chinese (Traditional) - Big5 Code**

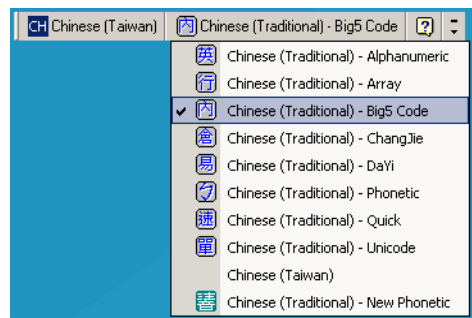

- Select Unicode/Big5 input on Windows 7: **Chinese (Traditional) - New Quick**. This option support both Unicode and Big5 input.



# Signature Capture Code

---

## Introduction

CapCode, a signature capture code, is a special pattern that encloses a signature area on a document and allows a scanner to capture a signature.

There are several accepted patterns that allow automatic identification of different signatures on the same form. For example, on the federal tax return 1040 form there are three signature areas, one each for two joint filers, and one for a professional preparer. By using different patterns, a program can correctly identify all three, so they can be captured in any sequence and still be identified correctly.

---

## Code Structure

### Signature Capture Area

A CapCode is printed as two identical patterns on either side of a signature capture box, as shown in [Figure 22](#). Each pattern extends the full height of the signature capture box.

The box is optional, so you can omit it, replace it with a single baseline, or print a baseline with an "X" on top of it towards the left, as is customarily done in the US to indicate a request for signature. However, if an "X" or other markings are added in the signature box area, these are captured with the signature.

**Figure 22** CapCode



## CapCode Pattern Structure

A CapCode pattern structure consists of a start pattern followed by a separator space, a signature capture box, a second separator space, and then a stop pattern. Assuming that  $X$  is the dimension of the thinnest element, the start and stop patterns each contains  $9X$  total width in 4 bars and 3 spaces. A  $7X$  quiet zone is required to the left and to the right of the CapCode pattern.

**Figure 23** CapCode Structure

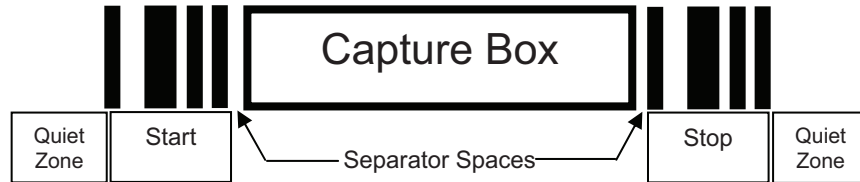

The separator spaces on either side of the signature capture box can be between  $1X$  and  $3X$  wide.

## Start / Stop Patterns

Table 50 lists the accepted start / stop patterns. The bar and space widths are expressed as multiples of  $X$ . You must use the same pattern on either side of a signature capture box. The type value is reported with the captured signature to indicate the purpose of the signature captured.

**Table 50** Start / Stop Pattern Definitions

Bar/Space Patterns							Type
B	S	B	S	B	S	B	
1	1	2	2	1	1	1	2
1	2	2	1	1	1	1	5
2	1	1	2	1	1	1	7
2	2	1	1	1	1	1	8
3	1	1	1	1	1	1	9

Table 51 lists selectable parameters used to generate the image of the captured signature.

**Table 51** User Defined CapCode Parameters

Parameter	Defined
Width	Number of pixels
Height	Number of pixels
Format	JPEG, BMP, TIFF
JPEG quality	1 (most compression) to 100 (best quality)
Bits Per Pixel (not applicable to JPEG format)	1 (2 levels)
	4 (16 levels)
	8 (256 levels)

BMP format does not use compression, JPEG and TIFF formats do.

---

## Dimensions

The size of the signature capture box is determined by the height and separation of the start and stop patterns. The line width of the signature capture box is insignificant.

The thinnest element width, referred to here as X, is nominally 10 mils (1 mil = 0.0254 mm). Select this as an exact multiple of the pixel pitch of the printer used. For example, when using a 203 DPI (dots-per-inch) printer and printing 2 dots per module, the resulting X dimension is 9.85 mils.

---

## Data Format

The decoder output is formatted according to [Table 52](#). Zebra decoders allow different user options to output or inhibit barcode type. Selecting "Symbol ID" as the barcode type for output identifies the CapCode with letter "i".

**Table 52** Data Format

File Format (1 byte)	Type (1 byte)	Image Size (4 bytes, BIG Endian)	Image Data
JPEG - 1 BMP - 3 TIFF - 4	See <a href="#">Table 50</a> , last column		(Same bytes as in a data file)

---

## Additional Capabilities

Regardless of how the signature is captured, the output signature image is de-skewed and right-side up.

A scanner that captures signatures automatically determines whether it is scanning a signature or a barcode. You can disable the signature capturing capability in a decoder.

---

## Signature Boxes

Figure 24 illustrates the five acceptable signature boxes:

**Figure 24** Acceptable Signature Boxes

Type 2:



Type 5:



Type 7:



Type 8:



Type 9:



# Non-Parameter Attributes

---

## Introduction

This appendix defines non-parameter attributes.

---

## Attributes

### Model Number

#### Attribute #533

Model number of the scanner. This electronic output matches the printout on the physical device label, for example **SA4608-SR00006ZZWW**.

Type	S
Size (Bytes)	18
User Mode Access	R
Values	Variable

### Serial Number

#### Attribute #534

Unique serial number assigned in the manufacturing facility. This electronic output matches the printout on the physical device label, for example **M1J26F45V**.

Type	S
Size (Bytes)	16
User Mode Access	R
Values	Variable

## Date of Manufacture

### Attribute #535

Date of device manufacture assigned in the manufacturing facility. This electronic output matches the printout on the physical device label, for example **30APR19** (which reads the 30th of April 2019).

<b>Type</b>	S
<b>Size (Bytes)</b>	7
<b>User Mode Access</b>	R
<b>Values</b>	Variable

## Date of First Programming

### Attribute #614

Date of first electronic programming represents the first time settings were electronically loaded to the scanner either by 123Scan or via SMS, for example **18MAY19** (which reads the 18th of May 2019).

<b>Type</b>	S
<b>Size (Bytes)</b>	7
<b>User Mode Access</b>	R
<b>Values</b>	Variable

## Configuration Filename

### Attribute #616

The name assigned to the configuration settings loaded electronically to the device either by 123Scan or via SMS.



**NOTE:** Scanning the **Set Defaults** barcode automatically changes the configuration filename to factory defaults.

To indicate the configuration settings loaded to the device were changed, the configuration filename changes to **Modified** upon scanning any parameter barcode.

<b>Type</b>	S
<b>Size (Bytes)</b>	17
<b>User Mode Access</b>	RW
<b>Values</b>	Variable



## Beeper/LED

### Attribute #6000

Activates the beeper and/or LED.

**Type** X  
**Size (Bytes)** N/A  
**User Mode Access** W

**Values:**

**Table 53** Beeper/LED Values

Beep / LED Action	Value	Beep / LED Action	Value
1 high short beep	0	1 low long beep	15
2 high short beeps	1	2 low long beeps	16
3 high short beeps	2	3 low long beeps	17
4 high short beeps	3	4 low long beeps	18
5 high short beeps	4	5 low long beeps	19
1 low short beep	5	Fast warble beep	20
2 low short beeps	6	Slow warble beep	21
3 low short beeps	7	High-low beep	22
4 low short beeps	8	Low-high beep	23
5 low short beeps	9	High-low-high beep	24
1 high long beep	10	Low-high-low beep	25
2 high long beeps	11	High-high-low-low beep	26
3 high long beeps	12	Green LED off	42
4 high long beeps	13	Green LED on	43
5 high long beeps	14	Red LED on	47
		Red LED off	48

## Parameter Defaults

### Attribute #6001

This attribute restores all parameters to their factory defaults.

<b>Type</b>	X
<b>Size (Bytes)</b>	N/A
<b>User Mode Access</b>	W
<b>Values</b>	0 = Restore Defaults 1 = Restore Factory Defaults 2 = Write Custom Defaults

## Beep on Next Bootup

### Attribute #6003

This attribute configures (enables or disables) beep on next boot up of scanner.

<b>Type</b>	X
<b>Size (Bytes)</b>	N/A
<b>User Mode Access</b>	W
<b>Values</b>	0 = Disable beep on next bootup 1 = Enable beep on next bootup

## Reboot

### Attribute #6004

This attribute initiates a device reboot.

<b>Type</b>	X
<b>Size (Bytes)</b>	N/A
<b>User Mode Access</b>	W
<b>Values</b>	N/A

## Host Trigger Session

### Attribute #6005

This attribute triggers a decode session similar to manually depressing the scanner trigger button.

<b>Type</b>	X
<b>Size (Bytes)</b>	N/A
<b>User Mode Access</b>	W
<b>Values</b>	1 = Start Host Trigger Session 0 = Stop Host Trigger Session

## Firmware Version

### Attribute #20004

The scanner's operating system version. For example, **NBRFMAAC** or **PAAAABS00-007-R03D0**.

<b>Type</b>	S
<b>Size (Bytes)</b>	Variable
<b>User Mode Access</b>	R
<b>Values</b>	Variable

## Scankit Version

### Attribute #20008

Identifies the 1D decode algorithms resident on the device, for example **SKIT4.33T02**.

<b>Type</b>	S
<b>Size (Bytes)</b>	Variable
<b>User Mode Access</b>	R
<b>Values</b>	Variable

# Sample Barcodes



**IMPORTANT:** To read a sample barcode the parameter must be enabled. To enable a parameter scan the appropriate **Enable** barcode in [Symbologies](#).

---

## UPC/EAN

### UPC-A, 100%



### UPC-A with 2-digit Add-on

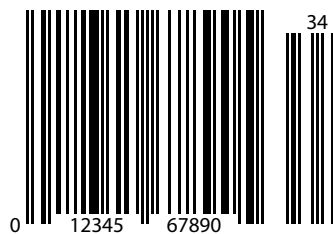

**UPC-A with 5-digit Add-on**



**UPC-E**



**UPC-E with 2-digit Add-on**



**UPC-E with 5-digit Add-on**



**EAN-8**

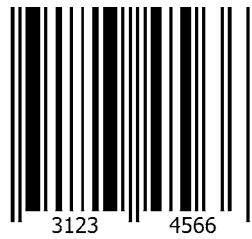

**EAN-13, 100%**



### EAN-13 with 2-digit Add-on



### EAN-13 with 5-digit Add-on



---

### Code 128

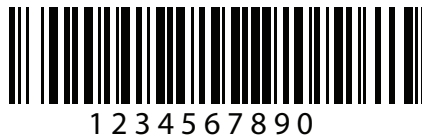

**GS1-128**



---

**Code 39**



---

**Code 93**

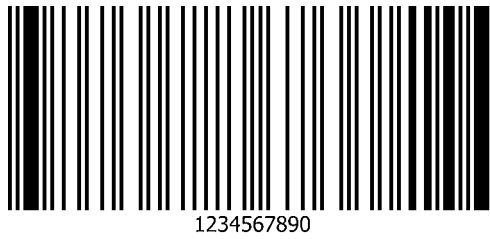



---

**Code 11 with 2 Check Digits**



---

**Interleaved 2 of 5**



---

**MSI with 2 Check Digits**



---

**Chinese 2 of 5**

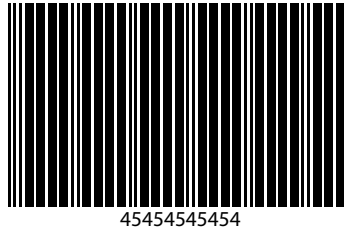

---

**Matrix 2 of 5**



---

**Korean 3 of 5**



---

## GS1 DataBar

### GS1 DataBar Omnidirectional (formerly GS1 DataBar-14)



7612341562341

### GS1 DataBar Truncated

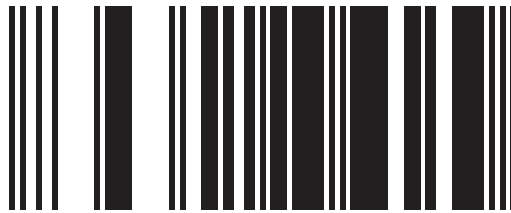

(01)00614141999996

### GS1 DataBar Stacked



**GS1 DataBar Stacked Omnidirectional**



**GS1 DataBar Limited**



**GS1 DataBar Expanded**



## GS1 DataBar Expanded Stacked



---

## 2D Symbolologies

### PDF417

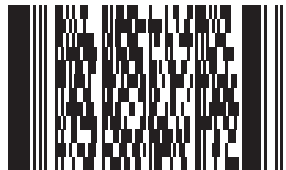

### Data Matrix



**GS1 Data Matrix**



**Maxicode**

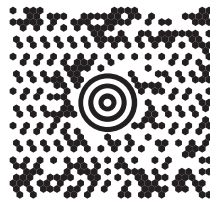

**QR Code**



**GS1 QR**



## MicroQR



## Aztec

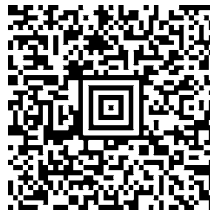

0123456789ABCDEFGHIJKLMNOPQRSTUVWXYZ0123456789ABCDEFGHIJKLMNOPQRSTUVWXYZ0123456  
7890123456789ABCDEFGHIJKLMNOPQRSTUVWXYZ0123456789ABCDEFGHIJKLMNOPQRSTUVWXYZ0123  
456789

## Grid Matrix

✓ **NOTE** Grid Matrix must be enabled to read the following barcode (see [Grid Matrix on page 317](#)).

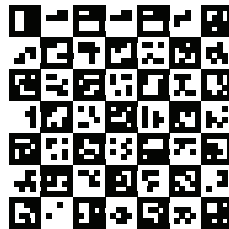

Han Xin

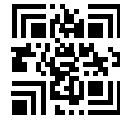

---

## Postal Codes

US Postnet



UK Postal



Japan Postal

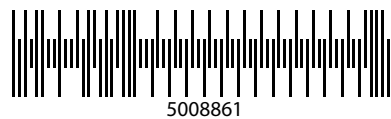



**Australian Post**



---

**OCR**

**OCR-A**

WFSGH67890

**OCR-B**

12345ABMKP

**MICR E13B**

! : 0 1 2 3 || 4 5 6 ... 7 8 9 0 , ' !

**US Currency**

A barcode consisting of the alphanumeric string "F 01840626 D" printed in green ink on a light-colored, textured background. The characters are in a bold, sans-serif font.

F 01840626 D

# Index

## Numerics

123Scan	31
requirements	32
2D barcodes	
aztec	313
aztec inverse	314
code 128 emulation	305
data matrix	306
data matrix inverse	307
data matrix mirror images	308
grid matrix	317
grid matrix inverse	318
grid matrix mirrored	319
GS1 data matrix	306
GS1 QR	310
han xin	315
han xin inverse	316
linked QR mode	312
maxicode	309
microPDF417	304
microQR	311
PDF417	304
QR code	310

## A

accessories	
cables	23
configurations	23
EAS	42
interface cable	23
partner portal	23
power supplies	24
stands and holders	23
ADF	388
invalid rule	48
transmit error	48
advanced data formatting	48, 388
aiming	
orientation	40
pattern, hand-held	159

pattern, hands-free	160
pattern, snapshot	199
snapshot mode timeout	198
video view finder	214
aiming pattern	40
orientation	41
ASCII character sets	476
assembling the stand	37
attributes, non-parameter	
beep on next bootup	558
configuration filename	556
date of first programming	556
date of manufacture	556
firmware version	559
host trigger session	558
model number	555
parameter defaults	558
reboot	558
scankit version	559
serial number	555
autoexposure	195
aztec barcodes	313
inverse	314
sample	571

## B

barcodes	
1D quiet zone level	297
alphanumeric	459
analog gain	197
autoexposure	195
aztec	313
inverse	314
beep after good decode	144
beeper duration	147
beeper tone	146
beeper volume	145
bits per pixel	208
cancel	457
Chinese 2 of 5	283
CJK	

- non-CJK UTF barcode output . . . . . 546
- output method . . . . . 540
- unicode output control . . . . . 539
- codabar . . . . . 274
  - CLSI editing . . . . . 276
  - lengths . . . . . 274
  - NOTIS editing . . . . . 276
  - security level . . . . . 277
  - start and stop characters . . . . . 278
- code 11 . . . . . 262
  - check digit verification . . . . . 264
  - lengths . . . . . 262
  - transmit check digits . . . . . 265
- code 128 . . . . . 243
  - check ISBT table . . . . . 248
  - code 128 fnc4 . . . . . 249
  - GS1-128 . . . . . 245
  - ISBT 128 . . . . . 246
  - ISBT concatenation . . . . . 247
  - ISBT concatenation redundancy . . . . . 248
  - lengths . . . . . 244
  - reduced quiet zone . . . . . 251
  - security level . . . . . 250
- code 128 emulation . . . . . 305
- code 39 . . . . . 251
  - check digit verification . . . . . 255
  - code 32 prefix . . . . . 253
  - convert code 39 to code 32 . . . . . 252
  - full ASCII conversion . . . . . 256
  - lengths . . . . . 253
  - reduced quiet zone . . . . . 259
  - security level . . . . . 257
  - transmit check digit . . . . . 255
  - trioptic code 39 . . . . . 252
- code 93 . . . . . 259
  - lengths . . . . . 260
- composite
  - beep mode . . . . . 302
  - composite CC-A/B . . . . . 299
  - composite CC-C . . . . . 299
  - composite inverse . . . . . 300
  - composite TLC-39 . . . . . 300
  - GS1-128 emulation mode . . . . . 303
  - UPC composite mode . . . . . 301
- continuous barcode read . . . . . 163
- country code page defaults . . . . . 514
- country code pages . . . . . 518,
  - 520, 522, 524, 526, 528, 530, 532, 534, 536
- country codes . . . . . 496
- country keyboard types (country codes) . . . . . 496
- crop to address . . . . . 200
- data matrix . . . . . 306
  - data matrix inverse . . . . . 307
  - GS1 data matrix . . . . . 306
  - mirror images . . . . . 308
- decode pager motor . . . . . 150
- decode pager motor duration . . . . . 151
- decode session timeout . . . . . 164, 165
- digital gain . . . . . 197
- direct decode indicator . . . . . 149
- disable all code types . . . . . 224
- discrete 2 of 5 . . . . . 271
  - lengths . . . . . 272
- DPM illumination control . . . . . 177
- DPM mode . . . . . 178
- driver's license parsing . . . . . 394
  - driver's license date format . . . . . 410
  - driver's license gender format . . . . . 409
  - no separator . . . . . 412
  - parser version ID . . . . . 409
  - parsing field . . . . . 396, 397, 398
  - send control characters . . . . . 413
  - send keyboard characters . . . . . 418
  - set defaults . . . . . 409
- elevel . . . . . 176
- enable all code types . . . . . 224
- enter . . . . . 179
- febraban . . . . . 269
- fixed exposure . . . . . 196
- FN1 substitution values . . . . . 184
- grid matrix . . . . . 317
- grid matrix inverse . . . . . 318
- grid matrix mirrored . . . . . 319
- GS1 databar . . . . . 289
  - convert to UPC/EAN/JAN . . . . . 290
  - GS1 databar expanded . . . . . 290
  - GS1 databar expanded security level . . . . . 293
  - GS1 databar limited . . . . . 289
  - GS1 databar limited margin check . . . . . 292
  - GS1 databar omnidirectional . . . . . 289
  - security level . . . . . 291
- han xin . . . . . 315
  - inverse . . . . . 316
- hand-held decode aiming pattern . . . . . 159
- hand-held trigger mode . . . . . 158
- hands-free decode aiming pattern . . . . . 160
- hands-free mode . . . . . 161
- IBM
  - barcode configuration directive . . . . . 127
  - beep directive . . . . . 126
  - convert unknown to code 39 . . . . . 126
  - default table . . . . . 124
  - port address . . . . . 125
  - specification version . . . . . 127
- IDC
  - aspect . . . . . 376
  - bits per pixel . . . . . 377
  - border type . . . . . 382
  - captured image brighten . . . . . 380
  - captured image sharpen . . . . . 381

default table	371
delay time	383
file format selector	376
find box outline	378
height	375
JPEG quality	378
maximum rotation	384
maximum text length	379
minimum text length	379
operating mode	372
symbology	373
width	375
X coordinate	374
Y coordinate	374
zoom limit	383
illumination	172, 195
illumination brightness	173
image brightness (target white)	203
image capture	
default table	192
image cropping	200
image enhancement	205
image file format	206
image rotation	207
image size	202
intercharacter gap size	298
interleaved 2 of 5	265
check digit verification	268
convert to EAN-13	269
lengths	266
reduced quiet zone	271
security level	270
transmit check digit	268
inverse 1D	288
JPEG image options	203
JPEG quality	204
JPEG size	204
keyboard wedge	
alternate numeric keypad emulation	133
caps lock override	134
convert case	135
default table	130
FN1 substitution	136
function key mapping	136
host types	131
intra-keystroke delay	132
keystroke delay	132
quick keypad emulation	133
send make and break	137
simulated caps lock	134
unknown characters	131
Korean 3 of 5	287
LED on good decode	149
linked QR mode	312
low power mode	155
macro PDF	
abort entry	324
escape characters	324
flush buffer	324
manufacturing information	49
matrix 2 of 5	284
check digit	286
lengths	284
transmit check digit	286
maxicode	309
microPDF417	304
mobile phone/display mode	168
motion tolerance	174
MSI	279
check digit algorithm	282
check digits	281
lengths	280
reduced quiet zone	283
transmit check digit	282
night mode	153
night mode toggle	154
night mode trigger	154
numeric	455, 456
numeric barcodes	457
OCR	
check digit	357
check digit multiplier	358
check digit validation	360
default table	333
inverse OCR	365
lines	345
maximum characters	346
MICR E13B	342
minimum character	345
OCR-A	334
OCR-A variant	335
OCR-B	337
OCR-B variant	338
orientation	343
parameters	334
quiet zone	347
redundancy	366
subset	346
template	348
US currency serial number	343
operational modes	194
pager motor	150
parameter scanning	143
PDF prioritization	169
PDF prioritization timeout	170
PDF417	304
picklist mode	162
pid type	175
pid value	175
postal	325

- Australia post . . . . . 328
- Australia post format . . . . . 329
- Japan postal . . . . . 327
- mailmark . . . . . 331
- Netherlands KIX code . . . . . 330
- transmit UK postal check digit . . . . . 327
- transmit US postal check digit . . . . . 326
- UK postal . . . . . 326
- UPU FICS postal . . . . . 331
- US planet . . . . . 325
- US postnet . . . . . 325
- USPS 4CB/One Code/Intelligent Mail . . . . . 330
- prefix/suffix values . . . . . 181
- presentation mode field of view . . . . . 171
- QR code . . . . . 310
  - GS1 QR . . . . . 310
  - microQR . . . . . 311
- redundancy level . . . . . 294
- RS-232
  - baud rate . . . . . 109
  - beep on bel . . . . . 118
  - check receive errors . . . . . 113
  - data bits . . . . . 112
  - default table . . . . . 103
  - hardware handshaking . . . . . 113
  - host serial response timeout . . . . . 117
  - host types . . . . . 107
  - intercharacter delay . . . . . 119
  - nixdorf beep LED options . . . . . 120
  - parity . . . . . 111
  - RTS line state . . . . . 118
  - software handshaking . . . . . 115, 116
  - stop bits . . . . . 112
  - unknown characters . . . . . 120
- samples . . . . . 560
- scan data options . . . . . 182
- security level . . . . . 296
- securPharm . . . . . 187
- securPharm output formatting . . . . . 188
- send versions . . . . . 49
- serial number . . . . . 49
- set defaults . . . . . 142
- signature capture . . . . . 209
  - signature capture bits per pixel . . . . . 211
  - signature capture file format . . . . . 210
  - signature capture height . . . . . 212
  - signature capture JPEG quality . . . . . 213
  - signature capture width . . . . . 212
- silence operational mode changes . . . . . 199
- snapshot aiming pattern . . . . . 199
- snapshot mode timeout . . . . . 198
- software version . . . . . 49
- SSI
  - baud rate . . . . . 89
  - boot up event . . . . . 100
  - check parity . . . . . 91
  - data packet format . . . . . 94
  - decode event . . . . . 99
  - host character timeout . . . . . 96
  - host RTS line state . . . . . 94
  - host serial response timeout . . . . . 95
  - interpacket delay . . . . . 98
  - multipacket option . . . . . 97
  - parameter event . . . . . 100
  - parity . . . . . 91
  - selecting . . . . . 89
  - software handshaking . . . . . 93
  - stop bits . . . . . 92
- suppress power up beeps . . . . . 148
- symbolologies
  - default table . . . . . 217
- tab key . . . . . 179
- time delay to low power mode . . . . . 156
- timeout between decodes, different symbols . . . . . 166
- timeout between decodes, same symbol . . . . . 166
- transmit code ID character . . . . . 180
- transmit no read message . . . . . 185
- triggered timeout, same symbol . . . . . 167
- unique barcode reporting . . . . . 164
- unsolicited heartbeat interval . . . . . 186
- UPC/EAN/JAN
  - bookland EAN . . . . . 227
  - bookland ISBN . . . . . 228
  - convert UPC-E to UPC-A . . . . . 240
  - convert UPC-E1 to UPC-A . . . . . 240
  - coupon report . . . . . 242
  - EAN/JAN zero extend . . . . . 241
  - EAN-13/JAN-13 . . . . . 227
  - EAN-8/JAN-8 . . . . . 226
  - ISSN EAN . . . . . 229
  - supplemental AIM ID format . . . . . 234
  - supplemental redundancy . . . . . 233
  - supplementals . . . . . 230
  - transmit UPC-A check digit . . . . . 235
  - transmit UPC-E check digit . . . . . 235
  - transmit UPC-E1 check digit . . . . . 236
  - UCC coupon extended code . . . . . 241
  - UPC reduced quiet zone . . . . . 243
  - UPC-A . . . . . 225
    - UPC-A preamble . . . . . 237
  - UPC-E . . . . . 225
    - UPC-E preamble . . . . . 238
  - UPC-E1 . . . . . 226
    - UPC-E1 preamble . . . . . 239
  - user programmable supplementals . . . . . 233
- USB
  - barcode configuration directive . . . . . 76
  - beep directive . . . . . 75
  - caps lock override . . . . . 65
  - CDC beep on bel . . . . . 74

convert case	73
convert unknown to code 39	66
default table	61
device type	62
direct I/O beep	75
fast HID	67
function key mapping	72
IBM specification version	76
keyboard FN1 substitution	71
keypad emulation	70
keypad emulation with leading zero	71
keystroke delay	65
polling interval	68
quick keypad emulation	70
simulated caps lock	72
SNAPI handshaking	64
static CDC	74
unknown characters	66
user preferences	
default table	139
video frame size	214
video image size	215
video mode format selector	213
video resolution	215
video view finder	214
beeper	
beep after good decode	144
definitions	34
duration	147
suppress on power up	148
tone adjustment	146
bullets	25
<b>C</b>	
cables	
installing	28
interface	23
removing	29
signal descriptions	57
character sets	
ALT key	481
ASCII	476
extended key	485
F key	484
GUI key	482
numeric key	485
PF key	483
Chinese 2 of 5 barcodes	283
sample	566
CJK	538
control parameters	539
country keyboard missing characters	547
decode setup	548
input method	549
cleaning the devices	
approved disinfectant cleaners for healthcare devices	45
approved for standard devices	44
how to	45
known harmful ingredients	44
codabar barcodes	274
CLSI editing	276
lengths	274
NOTIS editing	276
security level	277
start and stop characters	278
code 11 barcodes	262
check digit verification	264
lengths	262
sample	565
transmit check digits	265
code 128 barcodes	243
check ISBT table	248
fnc4	249
GS1-128	245
ISBT 128	246
ISBT concatenation	247
ISBT concatenation redundancy	248
lengths	244
reduced quiet zone	251
sample	563
security level	250
code 128 emulation barcodes	305
code 39 barcodes	251
check digit verification	255
code 32 prefix	253
code 39 security level	257
convert code 39 to code 32	252
full ASCII conversion	256
lengths	253
reduced quiet zone	259
sample	560, 564
transmit check digit	255
trioptic	252
code 93 barcodes	259
lengths	260
sample	564
code identifiers	
AIM	489
modifier characters	490
Symbol	487
transmitting	180
communication protocol	
cable interface	494
composite barcodes	
beep mode	302
composite CC-A/B	299
composite CC-C	299
composite inverse	300

- composite TLC-39 . . . . . 300
  - GS1-128 emulation mode . . . . . 303
  - UPC composite mode . . . . . 301
  - configurations
    - accessories . . . . . 23
    - cables . . . . . 23
    - stands and holders . . . . . 23
  - connecting
    - IBM interface . . . . . 123
    - interface cable . . . . . 28
    - keyboard wedge interface . . . . . 129
    - power . . . . . 30
    - RS-232 interface . . . . . 102
    - USB interface . . . . . 60
  - conventions
    - notational . . . . . 25
  - country code pages
    - . . . . . 518, 520, 522, 524, 526, 528, 530, 532, 534, 536
    - defaults . . . . . 514
  - country codes . . . . . 496
  - cropping images . . . . . 200
- D**
- data matrix barcodes . . . . . 306
    - data matrix inverse . . . . . 307
    - GS1 data matrix . . . . . 306
    - mirror images . . . . . 308
    - sample . . . . . 571, 572, 573
  - data parsing . . . . . 391
  - decode zones
    - ranges . . . . . 41, 42
  - default parameters . . . . . 139
    - all . . . . . 440
    - DL parsing . . . . . 393
    - IBM . . . . . 124
    - IDC . . . . . 371
    - image capture . . . . . 192
    - keyboard wedge . . . . . 130
    - OCR . . . . . 333
    - RS-232 . . . . . 103
    - setting . . . . . 142
    - SSI . . . . . 88
    - USB . . . . . 61
    - user preferences . . . . . 139
  - digital scanner
    - parts . . . . . 28
  - discrete 2 of 5 barcodes . . . . . 271
    - lengths . . . . . 272
  - driver's license parsing
    - ADF example . . . . . 438
    - barcodes . . . . . 394
    - control characters . . . . . 413
    - data fields . . . . . 395
    - date format . . . . . 410
    - default parameters . . . . . 393
    - field parsing barcodes . . . . . 396, 397, 398
    - gender format . . . . . 409
    - keyboard characters . . . . . 418
    - no separator . . . . . 412
    - parser version ID . . . . . 409
    - rule example . . . . . 434
- E**
- EAS . . . . . 42
  - elevel . . . . . 176
  - error indications
    - ADF . . . . . 48
    - format . . . . . 48
    - input . . . . . 47
  - exposure options
    - analog gain . . . . . 197
    - autoexposure . . . . . 195
    - digital gain . . . . . 197
    - fixed exposure . . . . . 196
    - illumination . . . . . 172, 195
    - presentation mode field of view . . . . . 171
- G**
- gain
    - analog . . . . . 197
    - digital . . . . . 197
  - gooseneck Intellistand . . . . . 37, 38
  - grid matrix barcodes
    - sample . . . . . 571
  - gs1 data matrix barcodes
    - sample . . . . . 570
  - GS1 databar barcodes . . . . . 289
    - convert GS1 databar to UPC/EAN/JAN . . . . . 290
    - GS1 databar expanded . . . . . 290
    - GS1 databar expanded security level . . . . . 293
    - GS1 databar limited . . . . . 289
    - GS1 databar limited margin check . . . . . 292
    - GS1 databar omnidirectional . . . . . 289
    - sample . . . . . 567
    - security level . . . . . 291
  - GS1 QR barcodes
    - sample . . . . . 570
- H**
- han xin barcodes . . . . . 315
    - inverse . . . . . 316
    - sample . . . . . 572
  - host types
    - IBM . . . . . 125
    - keyboard wedge . . . . . 131
    - RS-232 . . . . . 107



SSI .....	89		
USB .....	62		
<b>I</b>			
<b>IBM</b>			
barcodes .....	125		
connection .....	123		
default parameters .....	124		
IDC .....	367		
barcode acceptance test .....	368		
barcodes .....	372		
capture region .....	368		
data transmission .....	369		
default parameters .....	371		
demonstrations .....	386		
image post processing .....	369		
operating mode .....	369		
quick start .....	385		
quick start form .....	387		
sample setup .....	385		
support .....	369		
illumination .....	172, 195		
brightness .....	173		
image capture			
default parameters .....	192		
operational modes .....	194		
image options			
bits per pixel .....	208		
cropping .....	200		
file formats .....	206		
image brightness (target white) .....	203		
image enhancement .....	205		
image rotation .....	207		
image size .....	202		
JPEG image options .....	203		
JPEG quality .....	204		
JPEG size .....	204		
signature capture .....	209		
signature capture file format .....	210		
information, service .....	26		
interface			
cables .....	23, 24		
interleaved 2 of 5 barcodes .....	265		
check digit verification .....	268		
convert to EAN-13 .....	269		
febraban .....	269		
lengths .....	266		
reduced quiet zone .....	271		
sample .....	565		
security level .....	270		
transmit check digit .....	268		
<b>J</b>			
JPEG image options .....	203		
quality .....	204		
size .....	204		
<b>K</b>			
keyboard types (country codes)			
Albanian .....	497		
Arabic (101) .....	497		
Arabic (102) .....	497		
Arabic (102) Azerty .....	498		
Azeri (Cyrillic) .....	498		
Azeri (Latin) .....	498		
Belarusian .....	498		
Bosnian (Cyrillic) .....	498		
Bosnian (Latin) .....	498		
Bulgarian (Latin) .....	499		
Bulgarian Cyrillic (Typewriter) .....	499		
Canadian French (Legacy) .....	499		
Canadian French Win7 .....	499		
Canadian Multilingual Standard .....	499		
Chinese (ASCII) .....	499		
Chinese (Simplified) .....	500		
Chinese (Traditional) .....	500		
Croatian .....	500		
Czech .....	500		
Czech (Programmer) .....	500		
Czech (QWERTY) .....	500		
Danish .....	501		
Dutch (Netherlands) .....	501		
Estonian .....	501		
Faeroese .....	501		
Finnish .....	501		
French (Canada) 2000/XP .....	502		
French (Canada) 95/98 .....	502		
French (France) .....	501		
French International .....	502		
Galician .....	502		
German .....	502		
Greek .....	503		
Greek (220) Latin .....	503		
Greek (319) Latin .....	503		
Greek 220 .....	503		
Greek 319 .....	503		
Greek Latin .....	502		
Greek Polytonic .....	503		
Hebrew Israel .....	504		
Hungarian .....	504		
Hungarian_101KEY .....	504		
Irish .....	504		
Islandic .....	504		
Italian .....	504		
Italian (142) .....	505		

Japanese (ASCII) . . . . .	505
Japanese (SHIFT-JIS) . . . . .	505
Kazakh . . . . .	505
Korean (ASCII) . . . . .	505
Korean (Hangul) . . . . .	505
Kyrgyz . . . . .	506
Latin American . . . . .	506
Latvian . . . . .	506
Latvian (QWERTY) . . . . .	506
Lithuanian . . . . .	506
Lithuanian (IBM) . . . . .	506
Macedonian (FYROM) . . . . .	507
Maltese_47KEY . . . . .	507
Mongolian . . . . .	507
Norwegian . . . . .	507
Polish (214) . . . . .	507
Polish (Programmer) . . . . .	507
Portuguese (Brazil) . . . . .	508
Portuguese (Brazilian ABNT) . . . . .	508
Portuguese (Brazilian ABNT2) . . . . .	508
Portuguese (Portugal) . . . . .	508
Romanian . . . . .	508
Romanian (Legacy) . . . . .	508
Romanian (Programmer) . . . . .	509
Romanian (Standard) . . . . .	509
Russian . . . . .	509
Russian (Typewriter) . . . . .	509
Serbian (Cyrillic) . . . . .	509
Serbian (Latin) . . . . .	509
Slovak . . . . .	510
Slovak (QWERTY) . . . . .	510
Slovenian . . . . .	510
Spanish . . . . .	510
Spanish (Variation) . . . . .	510
Swedish . . . . .	510
Swiss French . . . . .	511
Swiss German . . . . .	511
Tatar . . . . .	511
Thai (Kedmanee) . . . . .	511
Turkish F . . . . .	511
Turkish Q . . . . .	511
UK English . . . . .	512
Ukranian . . . . .	512
US Dvorak . . . . .	512
US Dvorak Left . . . . .	512
US Dvorak Right . . . . .	512
US English . . . . .	497
US International . . . . .	512
Uzbek . . . . .	513
Vietnamese . . . . .	513
keyboard wedge	
barcodes . . . . .	131
connection . . . . .	129
default parameters . . . . .	130
keyboard map . . . . .	137
Korean 2 of 5 barcodes	
sample . . . . .	566
Korean 3 of 5 barcodes . . . . .	287
<b>L</b>	
LED definitions . . . . .	36
<b>M</b>	
macro PDF . . . . .	323
abort entry . . . . .	324
escape characters . . . . .	324
flush buffer . . . . .	324
maintenance . . . . .	44
approved cleaners for standard devices . . . . .	44
approved disinfectant cleaners for healthcare devices . . . . .	45
how to clean the devices . . . . .	45
known harmful ingredients . . . . .	44
matrix 2 of 5 barcodes . . . . .	284
check digit . . . . .	286
lengths . . . . .	284
sample . . . . .	566
transmit check digit . . . . .	286
maxicode barcodes . . . . .	309
MDF . . . . .	388
microPDF417 barcodes . . . . .	304
microQR code barcodes	
sample . . . . .	571
mounting	
wall . . . . .	23
mounting the stand . . . . .	38
MSI barcodes . . . . .	279
check digit algorithm . . . . .	282
check digits . . . . .	281
lengths . . . . .	280
reduced quiet zone . . . . .	283
sample . . . . .	565
transmit check digit . . . . .	282
multicode data formatting . . . . .	388
<b>N</b>	
night mode . . . . .	153
non-parameter attributes	
beep on next bootup . . . . .	558
configuration filename . . . . .	556
date of first programming . . . . .	556
date of manufacture . . . . .	556
firmware version . . . . .	559
host trigger session . . . . .	558
model number . . . . .	555
parameter defaults . . . . .	558
reboot . . . . .	558

- scankit version ..... 559
  - serial number ..... 555
- O**
- OCR
- barcodes ..... 334
  - default parameters ..... 333
- P**
- page
- motor ..... 150
- partner portal ..... 23
- parts ..... 28
- PDF417 barcodes ..... 304
- PDF prioritization ..... 169
  - sample ..... 569
- pinouts
- scanner signal descriptions ..... 57
- postal code barcodes ..... 325
- Australia post ..... 328
  - Australia post format ..... 329
  - Japan postal ..... 327
  - mailmark ..... 331
  - Netherlands KIX code ..... 330
  - sample ..... 572
  - transmit UK postal check digit ..... 327
  - transmit US postal check digit ..... 326
  - UK postal ..... 326
  - UPU FICS postal ..... 331
  - US planet ..... 325
  - US postnet ..... 325
  - USPS 4CB/One Code/Intelligent Mail ..... 330
- power supplies ..... 24
- power supply
- connecting ..... 30
- preferred symbol ..... 391
- presentation mode ..... 37, 38
- field of view ..... 171
- product id (pid) value ..... 175
- product id type ..... 175
- Q**
- QR code barcodes ..... 310
- GS1 QR ..... 310
  - microQR ..... 311
  - sample ..... 571, 572, 573
- R**
- related documents ..... 25
- related software ..... 25
- RS-232
- barcodes ..... 107
  - connection ..... 102
  - default parameters ..... 103
  - host parameters ..... 104
- RSM
- commands and responses over SSI ..... 85
- S**
- sample barcodes
- aztec ..... 571
  - Chinese 2 of 5 ..... 566
  - code 11 ..... 565
  - code 128 ..... 563
  - code 39 ..... 560, 564
  - code 93 ..... 564
  - data matrix ..... 571, 572, 573
  - grid matrix ..... 571
  - gs1 data matrix ..... 570
  - GS1 databar ..... 567
  - GS1 QR ..... 570
  - han xin ..... 572
  - interleaved 2 of 5 ..... 565
  - Korean 2 of 5 ..... 566
  - matrix 2 of 5 ..... 566
  - microQR code ..... 571
  - MSI ..... 565
  - PDF417 ..... 569
  - QR code ..... 571, 572, 573
  - UK postal ..... 572
  - UPC/EAN ..... 560
  - US postnet ..... 572
- scanning
- aiming ..... 40
  - hand-held mode ..... 37, 39
  - hands-free mode ..... 37, 38
- security
- 1D quiet zone level ..... 297
  - intercharacter gap size ..... 298
  - redundancy level ..... 294
  - security level ..... 296
- setting defaults ..... 142
- setup
- connecting a keyboard wedge host ..... 129
  - connecting a USB interface ..... 60
  - connecting an IBM most ..... 123
  - connecting an RS-232 interface ..... 102
  - connecting power ..... 30
  - installing interface cable ..... 28
  - unpacking ..... 27
- signal descriptions ..... 57
- signature capture ..... 209
- bits per pixel ..... 211
  - code structure ..... 551
  - data format ..... 553

dimensions	553
file format selector	210
height	212
JPEG quality	213
signature boxes	554
start and stop patterns	552
width	212
software tools	
123Scan	31
ADF	388
MDF	388
preferred symbol	391
specifications	
DS4608-DPE	55
DS4608-HC	52
DS4608-SR/DS4608-DL/DS4608-HD /DS4608-HL	50
SSI	
barcodes	89
commands	79
communications	78, 83
data transmission	81
default parameters	88
event reporting	99
handshaking	80, 83
low power mode	84
RSM commands and responses	85
RTS CTS	83
transactions	80
stand	
assembling	37
mounting	38
symbolologies	
barcodes	224
default parameters	217
T	
technical specifications	
DS4608-DPE	55
DS4608-HC	52
DS4608-SR/DS4608-DL/DS4608-HD /DS4608-HL	50
trigger mode, hand-held	158
troubleshooting	46
U	
unicode	
output control	539
unpacking	27
UPC/EAN/JAN barcodes	
bookland EAN	227
bookland ISBN	228
convert UPC-E to UPC-A	240
convert UPC-E1 to UPC-A	240
coupon report	242
decode supplementals	230
EAN/JAN zero extend	241
EAN-13/JAN-13	227
EAN-8/JAN-8	226
ISSN EAN	229
samples	560
supplemental AIM ID format	234
supplemental redundancy	233
transmit UPC-A check digit	235
transmit UPC-E check digit	235
transmit UPC-E1 check digit	236
UCC coupon extended code	241
UPC reduced quiet zone	243
UPC-A	225
UPC-A preamble	237
UPC-E	225
UPC-E preamble	238
UPC-E1	226
UPC-E1 preamble	239
user programmable supplementals	233
USB	
barcodes	62
connection	60
default parameters	61
V	
version	
barcodes	49
video	
formats	213
frame size	214
image size	215
resolution	215
view finder	214

