



Essential Phone with easy call blocking and answer machine Quick Set-up and User Guide

Digital Cordless Phone with Answer Machine



You'll need a Caller Display service from your network provider to use Call Blocking and other Caller Display enabled features, including accessing your Calls list. Charges may apply.

Important – please read first

- Only use the line cord, power supply and rechargeable batteries that come with your phone.
- Make sure the power supply is connected to a socket that you know works.
- Connect your phone to the power supply and let the batteries charge for 16 hours before connecting your phone to the phone socket.
- The base should always be plugged in to the mains power supply.

Your Answer Machine

Make sure the phone is set to **Answer + Rec** and that the ring delay is set to answer before any voicemail service does. The default setting is five rings. If you want to change it, take a look at page 38.

Where to put your phone

To make sure your handset gives you the best range and reception, avoid interference by placing it away from any large metal objects like fridge-freezers, microwave ovens, or electronic products such as computers and TVs.

Check the box contents

Handset



Base



Phone line (this comes already installed)



Mains power adaptor (item code 090713)

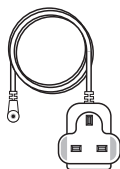

Two rechargeable batteries, AAA NiMH 550mAh (already installed in the handset)



If you bought more than one handset you'll also get:

- Extra handset
- Charger
- Mains power adaptor (item code 090713)
- Two rechargeable batteries, AAA NiMH 550mAh (already installed in the handset)



Important

Only use the mains power adaptors, cables and rechargeable batteries supplied in this box or this product might not work. Any replacement rechargeable batteries must be of the same type. BT accepts no responsibility for damage caused to your Essential Phone if you use any other type of batteries.

Quick set-up guide

1. Plug in

1. Plug the mains power adaptor into the base, with the cable clipped in the groove provided.

2. Plug the other end of the power adaptor into the wall power socket and switch on.

The phone line cord is pre-installed but don't plug the other end into the wall socket yet.



Important

- Don't connect the phone line to a phone socket until the handset is fully charged.
- The base station should be plugged into the mains power socket all the time.

Where to put your phone

- Place the base within 3 metres of a mains power socket and 1.8 metres of a phone socket so the cables will reach.
- Make sure it's at least a metre away from other electrical appliances to avoid interference.
- Don't place the phone or base in a bathroom or other humid area.
- The product works by sending radio signals between the handset and base. The strength of the signal depends on where you position the base. Putting it as high as possible can help give you the best signal.

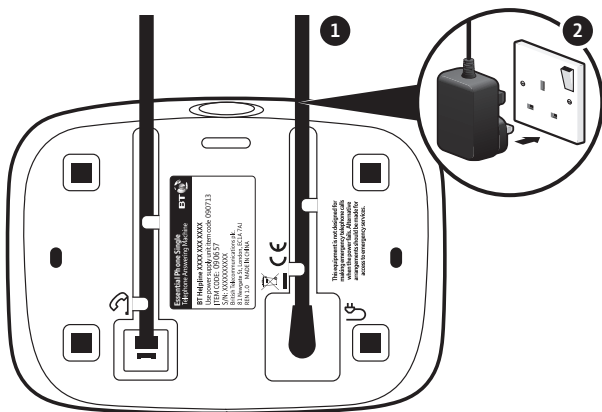

2. Charge

1. Activate the batteries by pulling the plastic tab away from the handset.

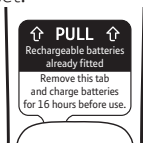

2. The handset will then check for a link with the base station. When it's found it, follow the prompt to set the date and time on the phone. Place the handset on the base and let it charge for **16 hours**.

3. After **16 hours**, plug the phone line cord into the phone wall socket.



Tip

It's a good idea to set the date and time now, see page 49.

Talk/Standby time

Under ideal conditions, the handset batteries should give up to 12 hours talk time or 120 hours standby on a single charge. (This doesn't mean you can unplug the base or leave the handset for this length of time without charge).

Please note that new Ni-MH rechargeable batteries don't reach full capacity until they've been in normal use for several days.

Battery low warning

You will hear a warning beep every 2 minutes during a call and the  icon will flash.

You must recharge the handset batteries before you can use the handset. If the charge completely runs out the handset will switch off. Place the handset on the base or charger to charge.

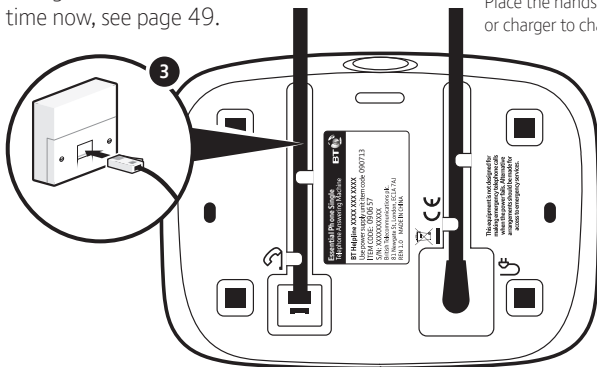

Quick set-up guide

Set up for additional handsets (multipacks only)

1. Plug the mains power adaptor into the underside of the charger and plug the other end into the mains wall socket and switch on the power.
2. Activate the batteries as explained on page 5.
3. Place the handset on the charger to charge for 16 hours.

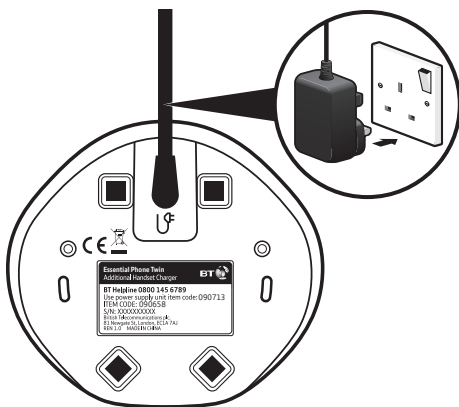

Battery performance

- To keep the batteries in the best condition, leave the handset off the base for a few hours at a time.
- Running the batteries right down at least once a week will help them last as long as possible.
- After charging your handset for the first time, subsequent charging time for the batteries is approximately 8 hours.
- The charge capacity of rechargeable batteries will go down over time, which will reduce the talk and standby time. Eventually they'll need replacing. For details on how to get replacement batteries, call Discom on 0800 9808 999*.



Tip

If you need to take the batteries out, slide the battery cover down, then gently take the batteries out.

3. Go!

Your Essential Phone is now ready for you to use

- For help setting the date and time, go to page 49.
- For instructions on making a call, go to page 17.
- For help personalising your phone's settings, go to page 44.
- For instructions on using the answer machine, go to page 35.

Or, you may find the answer in the Help section on page 56 or see our online frequently asked questions at bt.com/producthelp.

If you need to call the Helpline, please read the Help section on pages 56 - 58 first. It contains troubleshooting tips for common problems and frequently asked questions. If you still need some help, call the Helpline on 0800 145 6789*.



Tip

If you call the Helpline for advice, it's a good idea to call using another phone so you can follow any instructions using your Essential Phone.

* Calls made from within the UK mainland network and mobile networks are free. International call costs may vary.

Using your Essential Phone on a line with broadband?

To avoid problems with your broadband or noise on your phone line, you might need to plug your telephone line cord into the wall socket via a microfilter (not supplied).

If your main phone socket has a single socket, you do need to use microfilters, like this:

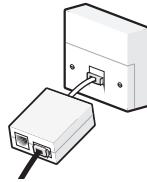

You'll need a microfilter for every phone socket where you've got equipment plugged in – up to a maximum of four per line – including alarm systems and digital TV boxes.

You can get BT ADSL micro filters from bt.com/shop

You don't need to use microfilters if your main phone socket has two separate sockets, like these:

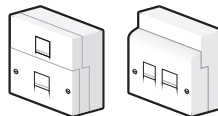

Contents

4 Quick set up guide

12 Getting to know your phone

- Handset buttons

14 Handset display

15 Finding your way around your phone

16 Base buttons

17 Using the phone

- Switching the handset on and off
- Making an external call
- Preparatory dialling
- Ending a call
- Receiving a call

18 Mute

- Incoming speech/
Handsfree volume
- Handsfree

19 Answer a call using handsfree

- Switching to handsfree during a call
- Redial
- Redialling the last number
- Viewing and dialling a number in the redial list

20 Saving a redial number to the phonebook

- Deleting a number from the redial list

- Deleting the entire redial list

21 Turning the handset ringer on or off

- Finding your handset (paging)

22 Block nuisance calls

- Block calls by type or number

23 Switch BT Call Blocking on/off

- Block all calls
- Switch BT Call Blocking off
- Allow VIP Incoming calls
- Block numbers in the Block list
- Enter a start and end time for Block all, Allow VIP and the Block List

24 Delete numbers in the Block list

- The Block button

25 Change the access PIN

26 Phonebook

- Store a phonebook entry

27 Character map

- Viewing/dialling a phonebook entry

28 Searching alphabetically for a phonebook entry

- Editing a phonebook entry

29 Adding a pause to a saved number

- Viewing a phonebook entry during a call

Contents

- Deleting a phonebook entry
- 30** Deleting the entire phonebook
 - Storing a speed dial number
- 31** Dialling a speed dial entry
- 33 Caller display and the Calls List**
 - Caller display
 - The Calls List
- 33** Viewing or dialling an entry in the Calls List
 - Saving a Calls List entry to your phonebook
- 34** Blocking a number from the Calls List
 - Deleting an entry in the Calls List
 - Deleting all of the Calls List
- 35 Answer machine**
 - Using the answer machine from the handset
 - Switching the answer machine on or off
 - Outgoing messages
- 36** Recording your own outgoing message
 - Playing the current outgoing message
- 37** Recording a memo
 - Setting the Answer Mode
- 38** Setting the Ring delay
- 39** Call screening
 - Playing messages using the handset
- 40** Message playback
- 41** Deleting all old played messages
 - Switching the answer machine on or off at the base
 - Playing messages using the base
 - Message playback on the base
- 42** Deleting all played messages
 - Remote access
 - Setting or changing the remote access PIN
- 43** Turning remote access on or off
 - Operating your answer machine remotely
- 44 Settings**
 - Setting the handset ringtone
 - Setting the handset ringer volume
- 45** Turning the key tones on or off
 - Changing the handset name
- 46** Turning the backlight on or off
 - Changing the call settings
- 47 Base settings**
 - Setting the base ringtone
 - Setting the base ringer volume
 - Change the system PIN
- 48** Reset

Contents

49 Clock/Alarm

- Setting the date and time
- Setting an alarm
- Switching the alarm off

50 Using additional handsets

- Registering an additional handset
- De-registering a handset

51 Making an internal call between handsets

- Transferring a call

52 Holding a three-way call

53 Menu map

56 Help

59 General information

Getting to know your phone

Handset buttons

Menu/Left option

Press to enter the main menu, access sub-menus and confirm options shown on the display above the button.

Up navigation button/Calls

Press to enter the Call Log and press up or down to enter the Call List or Answ Machine menu.
Move through menu options.
Increase volume.

Redial

Open redial list.

Talk

In standby mode make and receive calls.
In talk mode switch handsfree on or off.

Down navigation button/Phonebook

Access saved contacts.
Move down through menu options.
Decrease volume.

1 to 9 Speed dial buttons

In standby, press and hold to dial a saved speed dial number.

*

Long press to make internal calls to other handsets registered to the base.

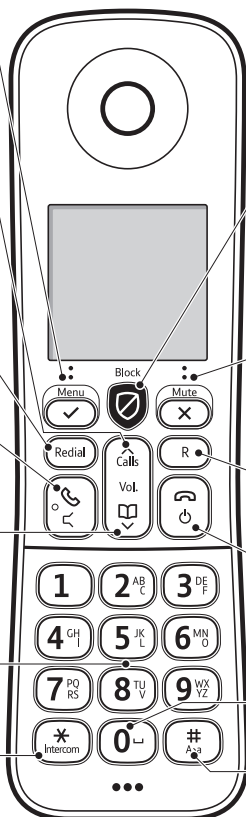

Getting to know your phone

Call Block

In idle mode, press to enter the Call Block menu.

When receiving a call, press to send the call to the answer machine, or during a call, press to end the call. If you have subscribed to a Caller Display Service and the Caller ID is displayed, the number will be blocked and added to the blocked numbers list

Mute/Right option

Delete or go back to the previous screen.

Press during a call to mute your caller.

R (Recall)

Press and hold to enter a pause (P) when dialling.

End call

End a call or press and hold to turn handset on or off.

Press to return to home screen when not on a call.

0









Add a space when typing.

#

Press and hold to toggle between uppercase and lowercase characters when typing.

Getting to know your phone

Handset display

-  Shows you how much charge is left on the handset.
-  Will appear if you're on, or starting, a call.
-  Flashes when a missed call has been received.
-  Lets you know the Phonebook is open.
-  Shows when you've set an alarm clock.
-  Shows when handsfree is switched on.
-  Lets you know the handset ringer is off.
-  Lets you know the answer machine is on. Flashes if you have new answer machine messages.
-  Lets you know the signal range from your new phone's base



Handset name

Getting to know your phone

Finding your way around your phone

Your new phone's menu is easy to navigate. Each menu has a list of options, which you can see on page 53.

When the handset is switched on and at the home screen

1. Choose menu by pressing **Menu** ✓.
2. Use the **calls** or **☰** buttons to scroll through the available menu options.
3. When the menu you want is on the screen, press the **Menu** ✓.
4. Use **calls** or **☰** to scroll through the available menu options.

To go back, press **Mute** ✕.

To return to the home screen menu, press **☰**. If you don't press anything for 30 seconds, the handset will automatically return to the home screen.

Left option button

Press to select the option displayed on the screen above the button or to confirm entry.

Right option button

Press to delete or go back to the previous screen.



Navigation buttons

Scroll up or down through the menu options.

Getting to know your phone

Base buttons

- Volume +

Decrease or increase the speaker volume during playback and the call screening volume during idle mode.

Find

Press to ring all registered handsets. This is helpful for finding missing handsets. There's more about this on page 21.

Delete

Press once to delete a message when you're playing it. When your phone is in idle mode, long press to delete all old messages.

Play

Green light on the button will flash when you have a new message.

Press to play messages.

Press to stop messages during playback.

Skip<<

During playback, press to skip back to previous message.

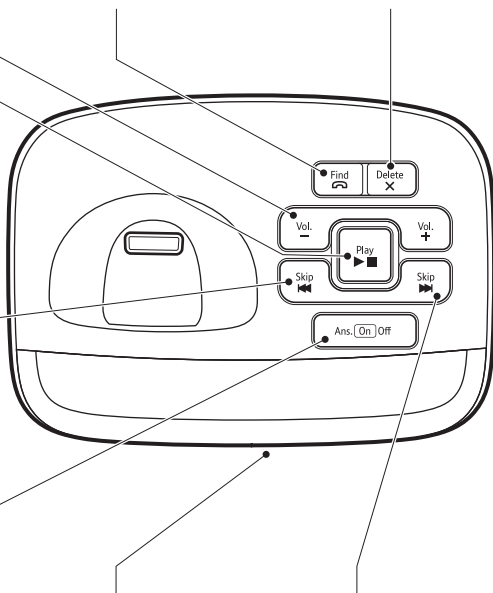

Answer on/off

Press to turn the answer machine on or off. When it's set to on, 'On' will light up.

Base light

Lights up constantly when the phone is on the base. Flashes when the handset is on a call.

Skip>>

During message playback, press to skip forward to the start of the next message.

Using the phone



Switching the handset on and off

Press and hold  until the handset turns on or off.

Making an external call

1. Press .
2. When you hear the dial tone, type the number. When the call begins, the light on the phone's base will flash.

Preparatory dialling

1. This lets you type in the number first, to avoid mistakes before the call is connected. If you make a mistake, press ^{Mute}  to delete the last digit.
2. Press  to dial.

End a call

Press .

Receiving a call

When you get a call, your phone will ring and the  icon will flash on the display.

If you've got a caller display service, the caller's number will show on the display. Press  to answer the call.

If you switch the phone off and on again, the phone will need to be charged for some time, before the true charge status can be recalculated by the phone and accurately displayed.

Call timer

Your handset will automatically time your outgoing and incoming calls. The handset shows the length of time both during and for a few seconds after your call. When you make a call, the In use light on the base LED will flash.

Auto Hang-Up

If auto hangup is set to On you can end a call by placing the handset back in the base.

If Auto Hang-Up is set to Off, you'll need to press  to end the call.

Auto Hang-Up On is the default setting. See page 46.

Using the phone

Mute



When you're on a call, you can mute the microphone, so the person at the other end can't hear you.

1. During the call, press  to mute your microphone. Your display screen will show **Mute On**, so you'll know your caller can't hear you.

2. Press  again to unmute.



The display will go back to showing **Calling**, and the call length.

Incoming speech/ Handsfree volume

To turn the volume up or down during a call, use  and . Press to hear the volume change.

Handsfree

Handsfree lets you talk to your caller without holding the handset. It also means anyone in the room can listen to the call as well.

1. Type the number you want to call and then press  twice. You'll hear your call on the loudspeaker. Press  to switch between the earpiece and loudspeaker.

2. Press  to end the call.

Auto Pick-Up

If Auto Pick-Up is set to On you can answer a call by lifting the handset off the base.

If Auto Pick-Up is set to Off, you'll need to lift the handset off the base and press  too.

Auto Pick-Up Off is the default setting. See page 46.

Out of range warning

The  icon on the handset display lets you know you're within range of the base.

If you go out of range the icon will disappear.

If you're on a call and go out of range, you'll hear a warning beep. You'll need to move back within range of the base.



If you do lose the connection, the handset will automatically re-connect to the base when you move back in range.

Using the phone

Answer a call using handsfree

When your phone rings, press  after you've answered it. Your call will be transferred to the handset loudspeaker.

Switching to handsfree during a call

During a call, press  to put it on loudspeaker. To switch handsfree off and go back to the earpiece, press  again.



Redial

You can redial any of the last ten numbers you've called on your Essential Phone.

Redialling the last number

1. Press **Redial**. Your last dialled number will show on the display screen.
2. Press  to call it.

Viewing and dialling a number in the redial list

1. Press **Redial**. The last number will show.
2. Press  or  to get to the number you want.
3. Press  to connect your call.

Using the phone

Saving a redial number to the phonebook

1. Press **Redial**, then use \hat{C} and \downarrow to get to the number you want to save.
2. Press \checkmark . You'll be asked if you want to save the number, press \checkmark .
3. Use the keypad to type in the name and press \checkmark .
4. If you need to, edit the number and press \checkmark to save.

Deleting a number from the redial list









1. Press **Redial**, then use \hat{C} and \downarrow to scroll through to the number you want to delete.
2. Press \checkmark and then \downarrow to get to **Delete**. Press \checkmark .
3. You'll be asked to confirm. Press \checkmark again.

Deleting the entire redial list

1. Press **Redial** and then \checkmark .
2. Press \downarrow until you see **Delete All**. Press \checkmark .
3. You'll be asked to confirm. Press \checkmark .

Using the phone

Turning the handset ringer on or off

1. Open the main menu by pressing  ^{Menu}, then scroll through to **Personal Set** using  and press  ^{Menu}.
2. You'll see **Handset Tone** on the display screen, press  ^{Menu}.
3. **Ring Volume** is displayed, press  ^{Menu}.
4. Use  ^{Calls} and  again to scroll through to **Ringer off** and press  ^{Menu}.

Finding your handset (paging)

If you can't find a handset, you can ring it using the base. If you get a call while using paging, the call will take priority. If you've switched your ringer off, it'll be temporarily switched back on during paging to help you find your handset.

1. Press  ^{Find} to ring all of the handsets registered to the base. The display screen on each handset will show **Paging** for up to 30 seconds.

When you've found your handset, press  ^{Find} again to stop the ringing.



Block nuisance calls







You need Caller Display

This will help you get the most out of your BT Call Blocking. You can get this from your phone service provider. Charges may apply.

The Essential Phone blocks numbers in two separate ways to help you avoid nuisance calls, firstly by type, e.g withheld or international, and also by your choice of specific numbers (you can store up to 100 numbers of your own choice).

Block calls by type or number

Press  and enter your access PIN. The default access PIN is 0000, for security we recommend you change this, see page 25. Enter the PIN number and press .

i) To block calls by type, select By Call Type, press  then scroll up or down using  and  to choose each of the call types, press  to select, then scroll to **On** to block calls from selected call type or **Off** using  and  and press .

The call types are;

Intern'l

Withheld

Unavailable

Payphone









The default setting is **Off**, for all call types.



Tip









You have three options to block all incoming calls so you won't get disturbed. You can also choose to allow VIP calls to be received and customise the time period in which incoming calls can be blocked.

Block nuisance calls

ii) To block calls by a specific number; Press  enter access PIN, press  then scroll  to **Blacklist**, press , then scroll  and select **Block number** press , then scroll  until **Add new** is shown, enter number and press . Numbers entered are saved in the Block List. You can also add numbers from the calls list to the block list.

Switch BT Call Blocking on/off









Block all calls

1. In idle mode, press .
2. Enter your access PIN and press .
3. Press  until **Blacklist** is shown, then press . **Block mode** is displayed. Press .
4. Press  or , **Block all** is shown.
5. **Always On** is displayed, press .
6. Press .











Switch BT Call Blocking off

Repeat steps above until **Off** is shown then press .

Allow VIP Incoming calls



1. In idle mode, press .
2. Enter you access PIN and press .
3. Press  until **Blacklist** is shown, then press . **Block mode** is displayed. Press .
4. Press  or , **Allow VIP** is shown.
5. **Always On** is displayed, press .
6. Press .

Block numbers in the Block list











1. In idle mode, press .
2. Enter you access PIN and press .
3. Press  until **Blacklist** is shown, then press . **Block mode** is displayed. Press .
4. Press  or  until **Block List** is shown, press .
5. **Always On** is displayed, press .
6. Press .

Enter a start and end time for Block all, Allow VIP and the Block List











You can set your phone to block calls during certain times.

1. In idle mode, press .
2. Enter your access PIN and press .

Block nuisance calls

3. Press  until **Blacklist** is shown, then press . **Block mode** is displayed. Press .
4. Press  or  to your chosen option.
5. Press .
6. Then scroll using  or  to **Start & end**, press  then using the keypad enter the start time press , then enter the end time and press .

Delete numbers from the Block List or to Unblock a number

1. In idle mode, press .
2. Enter your access PIN and press .
3. Press  until **Blacklist** is shown and press . Press  until **Block number** is shown, then press .
4. Scroll to **Delete**, press , then use  or  to select the number you want to delete.
5. Press , **Confirm?** is shown, press .



The Block button

The block call button can be used in 3 ways:

1. In idle mode

Press  as a shortcut to the Call Block menu.



2. Incoming call

When you have an incoming call, before pressing the  to answer, look at the handset display and you can see who is calling. If you don't want to take the call press the  on the handset and the call will be transferred to the answering machine for the caller to leave a message.

The number will be blocked and added to the blocked calls list if Caller ID is displayed. If the number calls again your phone will just ring silently and the caller cannot leave another message.









If you listen to the caller's original message and decide that the caller is not a nuisance caller and you want to receive future calls from them, you can remove them from the blocked numbers list.

3. During a call

If you have already answered the call and you want to block the number press  if the number is displayed in the Caller ID, press  to block the number, it will then be added to the blocked numbers list and end the call.

Block nuisance calls

Change the access PIN

1. Press  ^{Menu}, scroll  to **Call Block** and press  ^{Menu}.
 2. Enter the existing 4 digit access PIN. Press  to highlight **Change PIN** and press  ^{Menu}.
 3. Press  ^{Menu} then enter the existing 4 digit access PIN and press  ^{Menu}.
 4. Enter the new 4 digit access PIN and press  ^{Menu}, then enter it again when prompted and press  ^{Menu}.
- Saved!** will be displayed.

Phonebook

You can save up to 100 numbers to your phonebook. Names can be up to 12 characters and numbers can be 24 digits.

Use the keypad buttons to type names, using the letters above each number. For example, if you wanted to write Tom, you would press **8^{TV}** once for the 'T', **6^{MN}** three times for the 'o' and **6^{MN}** once to enter 'm'.

Store a phonebook entry

1. When your handset is on the home screen, press **✓^{Menu}** to open the menu.
2. You'll see **Phonebook**. Press **✓^{Menu}**. Use **↕^{Call}** and **↕^{Menu}** to find **New Entry**. Then press **✓^{Menu}**.
3. Type in the phonebook entry name using the keypad, then press **✓^{Menu}**.
4. Add the phone number and press **✓^{Menu}**.
5. You'll be asked if you want to add this number to the VIP list. If you do, press **✓^{Menu}**; if not, press **✗^{Mute}**. Your new entry will be saved.
6. The display will return to **New Entry**. Press **↻** to exit the menu and return to home screen.

If you make a mistake, use the **✗^{Mute}** to delete the last letter you typed. You can hold **#^{A*0}** to toggle between uppercase and lowercase letters. To add a space, press **0↵**.

When storing international numbers, replace **+** with **00**, then enter the rest of the number.



Tip

You can set some of your contacts to be VIPs, so that they can always get through when Call Blocking mode is set to Allow VIP.

Phonebook

Character map

0 Space . 0 , / : ; “ ‘ ! ; ? ¿ *
+ - % \ ^ ~ |

1 1 @ _ # = < > () & € £ \$
¥ [] { } α § ...

2 a b c 2

3 d e f 3

4 g h i 4

5 j k l 5

6 m n o 6

7 p q r s 7





8 t u v 8

9 w x y z 9



* *

Press and hold to change text entry mode sentence case, upper or lower.









Viewing/dialling a phonebook entry

1. When the handset is on the home screen, press  The first entry will show.
2. Press  and  to scroll through the entries.
3. When the phonebook entry you want shows on the screen, press  to dial it.

Searching alphabetically for a phonebook entry

1. When the handset is on the home screen, press .
2. Use the keypad buttons to search for the name. For example, to find a phonebook entry beginning with 'S', press **7** ^{PG} _{RS} once and then use the  and  to scroll through the entries until you find the one you need.

Editing a phonebook entry





1. When your handset is on the home screen, press .
2. Use  and  to scroll through to the phonebook entry you want to edit and select **OK** by pressing .
3. **Edit** is displayed, press .
4. Use the keypad to change the name if necessary, then press .
5. Use the keypad to change the number if necessary, then press .
6. You'll be asked if you want to add this number to the VIP list. If you do, press ; if not, press .
7. **Saved!** will show and you'll hear the confirmation tone. Your new entry will be saved.

Phonebook









Adding a pause to a saved number

If your new phone is connected to a switchboard, you might need to add a pause to a stored number. A pause will normally be after the switchboard access code (for example 9). When storing a number, press and hold **R** and then continue typing it.

Viewing a phonebook entry during a call

1. Press . You'll see the first entry in the phonebook.
2. Type the first letter of your phonebook entry name using the keypad. Then scroll through the entries using  and . Press  to display the number.

Deleting a phonebook entry

1. When your handset is on the home screen, press .
2. Use  and  to scroll through to the entry you want to delete and select it by pressing .
3. Press  and  again until you get to **Delete**. Press .
4. You'll be asked to confirm you want to delete the phonebook entry. Press . **Deleted** will show and you'll hear a confirmation tone.

Deleting the entire phonebook

When you Delete All of your phonebook entries, they'll be removed from each of the handsets.

1. Press ^{Menu} ✓ to open the menu. Press it again when you see **Phonebook**.
2. Use ^{calls} ^ and ^{Menu} ▢ to get to **Delete All** and press ^{Menu} ✓.
3. Press ^{Menu} ✓ to confirm.

Storing a speed dial number

You can assign numbers from your phonebook to the 1–9 buttons on your keypad, so you can call them quickly by just holding the number down. They're also called Direct Memory numbers.

1. When your handset is on the home screen, press ^{Menu} ✓ to get to the main Menu.
2. Press ^{Menu} ✓ when you see **Phonebook**.
3. Then use ^{calls} ^ and ^{Menu} ▢ to get to **Direct Mem** and press ^{Menu} ✓.
4. Press ^{calls} ^ and ^{Menu} ▢ to scroll through to the button you want to save a speed dial number to and press ^{Menu} ✓.
5. Press ^{Menu} ✓. You'll see **Add**, then press ^{Menu} ✓ again.
6. Use ^{calls} ^ and ^{Menu} ▢ to find the Phonebook entry you want to assign to the speed dial button and press ^{Menu} ✓.

Phonebook

Dialling a speed dial entry

1. On the keypad, press and hold the speed dial number you've assigned your phonebook entry to. Their phone number will be dialled automatically.

Caller display and the Calls List

Caller display

You'll need to subscribe to a caller display service to get the most out of this feature. When you do, you'll be able to see your caller's number on your handset display, as long as it's not withheld.

If the number is unavailable (which can happen if the call is coming from overseas), the number will show as **Unavailable**. If you've requested a Ringback, that'll also show on the handset display screen.

If a number is stored in your handset, the caller's name will be displayed. If you haven't subscribed to a caller display service, **Calling** will show on the phone's display.

The Calls List

The Calls List is where you can find all missed and received calls. The most recent call will show at the top of the list, followed by the rest in chronological order. Your Calls List will store up to 50 calls. When it's full, the newest call will replace the oldest.

If you miss a call,  will show on the handset display screen. To stop this from showing, just view the Calls List from any handset registered to the base.

You'll need to subscribe to your network provider's Caller Display service for this feature to work. You might have to pay a fee. For more information on BT Calling Features, call BT free on 0800 800 150.

For the caller's name to be displayed, make sure you've stored the full telephone number in your contacts list, including the dialling code.

There are some incoming calls where a number is not displayed and a network message is recorded instead:

Unavailable – number is unavailable

Withheld – number has been withheld

Intern'l – international number





Operator – call from the operator



Payphone – call from a payphone

Ringback – a ringback call









Caller display and the Calls List

Viewing or dialling an entry in the Calls List

1. Press  to get to the **Calls List**.
When you see **Calls List**, press .
2. You'll see the most recent entry.
If you haven't got any numbers stored to the Calls List, **List empty** will show.
3. Press  and  to scroll through the list.
4. If you want to call a number from the list, when it shows on the screen, press .

When the Calls List is open, press  to scroll from the newest call to the oldest, or press  to scroll from the oldest call to the newest.

Saving a Calls List entry to your phonebook

1. Press  to get to your **Calls List**.
2. Press  or **OK** to enter **Calls List**.
3. Press  and  to scroll through to the number you want to save.
4. When you get to it, select **OK** by pressing .
5. **Save Number** will show on the display screen. Press .
6. Type in the phonebook entry name, using the handset keypad.
Press .
7. The number you're saving will be displayed. Edit it if you need to, then press  to save the number.
Saved! will show and you'll hear the confirmation tone.

Caller display and the Calls List

Blocking a number from the Calls List

1. Press \hat{C} to get to your **Calls List**.
2. Press \checkmark to enter **Calls List**.
3. Use the \hat{C} and \downarrow to scroll through to the number you want to block and press \checkmark .
4. Press \downarrow until **Call Block** is displayed, press \checkmark .
5. The number you're blocking will be displayed, press \checkmark to save the number in your Block list. **Saved!** will be displayed.

Deleting an entry in the Calls List

1. Press \hat{C} to get to your **Calls List**.
2. Press \checkmark to enter **Calls List**.
3. Use \hat{C} and \downarrow to scroll to the list entry you want to delete and press \checkmark , Press \downarrow to scroll down to **Delete** and press \checkmark .
4. Press \checkmark and you will be asked to confirm, press \checkmark , **Deleted** will show and you'll hear the confirmation sound.
5. If you want to go back to the home screen, press Home .

Deleting all of the Calls List

1. Press \hat{C} to get to your **Calls List**.
 2. Press \checkmark to enter **Calls List**.
- The most recent call will show first.

3. Press \checkmark .
4. Use \hat{C} and \downarrow to scroll through the menu until you get to **Delete All** and press \checkmark . You'll be asked to confirm. Press \checkmark to delete.

Answer machine

Your new Essential Phone comes with an answer machine that can record up to 59 messages within the 30 minutes recording time when it's switched on. Each message can be up to three minutes long.

Using the answer machine from the handset

Switching the answer machine on or off

1. Press ^{Menu} ✓ to get to the menu, then use the ^{Calls} ⬆ and ^{Menu} ⬇ to find **Answ Machine**. Press ^{Menu} ✓.
2. Press ^{Menu} ⬇ until you see **Answ On/Off** and press ^{Menu} ✓.
3. Use ^{Calls} ⬆ and ^{Menu} ⬇ to choose between **On** or **Off**, then press ^{Menu} ✓ to confirm. You'll hear the confirmation tone.

Outgoing messages

Your outgoing message is what your callers hear when their call goes to the answer machine.

With the pre-recorded messages, you'll get two options. **Answer + Rec** lets callers leave a message; **Answer only** just answers your calls.

When the answer machine is switched On, the text 'On' will light up on the **Ans. On Off** button.

Answer + Rec

The pre-recorded Answer + Rec outgoing message that allows your caller to leave a message is, "Hello, your call cannot be taken at the moment, so please leave your message after the tone".

Answer Only













The pre-record Answer Only outgoing message, where callers hear an announcement but can't leave a message, is "Hello, your call cannot be taken at the moment and you cannot leave a message, so please call later".

Answer machine







Recording your own outgoing message

You can record either a **Answer + Rec** message or an **Answer only** message.

If you chose **Answer + Rec**, your caller will be able to leave a message. If you choose **Answer only**, they won't.

1. To record your own outgoing message, press  to get to the menu.
2. Press  until you get to **Answ Machine**. Press .
3. Press  and  to find **Answer Mode** and press .
4. Then choose **Answer + Rec** or **Answer only** and press .
5. Scroll through to **Personalized** and press . Then use  and  to get to **Record**.
6. Press  to start recording your message. When you're done, press  again and your message will be played back to you.

Playing the current outgoing message

1. Press  to get to the menu.
2. Press  and  to scroll to **Answ Machine**. Press .
3. Press  and  until you find **Answer Mode**. Press .

Answer machine

4. Then choose between **Answer + Rec** or **Answer only** and press left option button.
5. Then select **Personalized** or **Predefined** by pressing ^{Menu} ✓.
6. When you see Play on the display screen, press ^{Menu} ✓. Your current message will be played back to you.

Recording a memo

When you record a memo, it's saved on your answer machine and can be played back by other users like a normal answer machine message.

1. Press ^{Menu} ✓ to bring up the handset menu.
2. Press ^{Calls} and ^{Menu} to get to **Answ Machine** and press ^{Menu} ✓.
3. Press ^{Menu} until you see **Record Memo**. Press ^{Menu} ✓.
4. Follow the onscreen prompt and record your memo. Press ^{Menu} ✓ when you're finished.
5. Your memo will then be played back to you.

Setting the Answer Mode

There are two answer machine types: **Answer + Rec** and **Answer only**. **Answer + Rec** lets users record messages to your answer machine. **Answer only** doesn't. Here's how to set it.

The default outgoing message is Answer + Rec.

Answer machine

1. Press ^{Menu} ✓ to display the handset menu. Use ^{calls} ^ and ^{Menu} ⏏ to get to **Answ Machine**. Press ^{Menu} ✓.
2. Press ^{Menu} ⏏ until you get to **Answer Mode** and press ^{Menu} ✓.
3. Press ^{calls} ^ and ^{Menu} ⏏ to choose the answer type you want and press ^{Menu} ✓.
4. You'll then be asked to choose between your own outgoing message or the one that came with the phone. When you've decided, press ^{Menu} ✓.

Setting the Ring delay

Ring delay is the number of times the phone will ring before the answer machine picks the call up for you. You can choose from two to nine rings and Time Saver.

If you've got Time Saver switched on, when you call in to check your answer machine messages remotely, if you have new messages your phone answers after 3 rings. If there are no new messages it will answer after 5 rings. That way, you won't get charged for the call if you haven't got any messages to check.

1. Press ^{Menu} ✓. Press ^{Menu} ⏏ until you see **Answ Machine**, then press ^{Menu} ✓.
2. Press ^{Menu} ⏏ until you get to **Answ Setting**, then press ^{Menu} ✓.

Answer machine

- When you see **Ring delay**, press ^{Menu} ✓.
- Press ^{Calls} ⤴ and ^{Menu} ⤵ to get to the number of rings you want and press ^{Menu} ✓.

Call screening

You have two Call screening options on the Essential Phone: **Handset screening** (Hs) and **Base screening** (Bs). When Base screening is switched on, you'll hear the caller leaving a message through the base. When Handset screening is on, you'll hear them through the handset, if you press ^{Menu} ✓ when a message is being left.

- To turn it on or off, press ^{Menu} ✓ to display the menu. Use ^{Calls} ⤴ and ^{Menu} ⤵ to scroll through to **Answ Machine**. Press ^{Menu} ✓.
- Press ^{Menu} ⤵ until **Answ Setting** appears on the screen. Press ^{Menu} ✓.
- Press ^{Calls} ⤴ and ^{Menu} ⤵ again until you get to **Hs Screening** or **Bs Screening** and press ^{Menu} ✓.
- Press ^{Calls} ⤴ and ^{Menu} ⤵ to choose between **On** or **Off** and press ^{Menu} ✓ to confirm.





Playing messages using the handset

When you get a new message  will flash on the display screen.

The default setting is call screening On.

While screening, you can adjust the volume by pressing ^{Calls} ⤴ or ^{Menu} ⤵ on the handset or **- Volume +** on the base.

Answer machine

1. To play it, press  on your handset. Press  to get to **Answer Machine**, then press .
2. **Play** will show on the screen. Press  and your messages will be played in the order they were left, starting with the oldest. If you've got Caller Display, the date and time they left the message will be shown on the screen.

Message playback

When you're playing messages, you have the following options:

 and  adjust the volume.







 switches the playback from handsfree to earpiece.

- 1** plays the current message from the beginning.
- 4^{GH}** skips to the previous message.
- 6^{MN}** skips to the next message.

When your messages have finished playing, you'll be taken back to the Play messages screen and messages will be renumbered if you've deleted any.



Answer machine

Deleting all old played messages

1. Press  ^{Menu}, and then use the  and  to scroll through to **Answ Machine**. Press .
2. Press  until you get to **Delete All**. Press .
3. You'll be asked to confirm. Press .

Using the answer machine from the base

Switching the answer machine on or off at the base







To turn the answer machine on and off using the base, just press . When the answer machine is On, On will be lit on the .

Playing messages using the base

When you get a new message,  will flash on the base of your phone. Press it to play your new messages. If there are no new messages, all stored messages are played in the order they were left.



Message playback on the base

During playback, you can press:

-  ^{Play} to stop playback.
-  ^{Delete} to delete the message being played.
-  ^{Skip} to skip to the next message.
-  ^{Skip} to skip to previous message.
-  ^{Vol.}  ^{Vol.} to turn the playback volume up or down.

Answer machine













Deleting all played messages

1. When the base isn't in use, press  and hold  to delete all your old messages. You will hear a confirmation tone.

Remote access

With Remote access, you can listen to your answer machine messages from another phone. You'll need to set a PIN. The feature will need to be switched On for it to work.

Setting or changing the remote access PIN

1. Press  to open the menu. Press  until you get to **Answ Machine**. Press .
2. Press  until you see **Answ Setting**, then press  again.
3. Press  and  again until you see **Remote Acc.** and press .
4. Press  until you get to **Change PIN**. Press .
5. Type your current PIN, press .
6. Type in your new PIN and press  and then repeat this step. Your new PIN will be saved.

Memory full

The memory is full if there is less than 15 seconds of recording time left. When full, the  flashes quickly on the handset display and the machine will switch to Answer Only mode.

If the memory becomes full when a caller is leaving a message, they will hear a beep and the call will end.

You will need to delete messages before your answer machine will be able to record new ones.

Answer machine

Turning remote access on or off

1. Press ^{Menu} ✓, then scroll to **Answ Machine** and press ^{Menu} ✓.
2. Press ^{Calls} ⤴ and ^{Menu} ⤵ until you get to **Answ Setting**, then press ^{Menu} ✓.
3. Press ^{Calls} ⤴ and ^{Menu} ⤵ again to find **Remote Acc.** and press .
4. Press ^{Calls} ⤴ and ^{Menu} ⤵ to choose between **Activate** and **Deactivate**, then press ^{Menu} ✓ to confirm.

You cannot turn Remote access On until you have set a remote access PIN.

The default setting is Off.

Operating your answer machine remotely

1. Dial your number from another phone.
2. When you hear your outgoing message, press # and then your remote access PIN.
3. You can then:
 - 1 replay previous message
 - 2 play all messages
 - 3 play next message
 - 6 delete current message
 - 7 switch answer machine on
 - 8 stop playback
 - 9 turn answer machine off

Settings

Setting the handset ringtone

You can choose from ten ringtones.

1. To change it, press ^{Menu} ✓ and then press ^{Menu} to find **Personal Set** and press ^{Menu} ✓.
2. **Handset Tone** will show on your display screen. Press ^{Menu} ✓.
3. Press ^{Calls} and ^{Menu} to scroll through to **Ring Melody**. Press ^{Menu} ✓.
4. Select the tone you want and then press ^{Menu} ✓ to save it.

Choose from 10 handset ringtones. The default external ringtone is Melody 1.

Setting the handset ringer volume

1. Open the menu by pressing ^{Menu} ✓. Use ^{Calls} and ^{Menu} to scroll through until you come to **Personal Set**. Press ^{Menu} ✓.
2. **Handset Tone** will appear on the screen, then press ^{Menu} ✓.
3. **Ring Volume** will show on your display screen. Press ^{Menu} ✓, then use ^{Calls} and ^{Menu} to scroll through the volume options and then press ^{Menu} ✓.









There are 5 handset ringer volume levels, Low, Medium, High, Boost, Progressive and Ringer off.

If you turn the ringer off, the  icon will be displayed on the home screen.

Settings







Turning the key tone on or off

Each time you press a button on your keypad, a tone will sound. You can turn these on or off. The default setting is **On**.

1. To change it, press  and press  until you get to **Personal Set**. Press .
2. **Handset Tone** is displayed, press .
3. Then press  to get to **Key Tone**. Press .
4. Then use  and  to scroll between **On** and **Off** and press .









Changing the handset name

You can personalise your handset name, using up to ten characters. You can change it back at any time by following the steps below and then deleting all of the characters and pressing .

1. To change a handset name, press  and then press  to find **Personal Set**. Press .
2. Press  until you get to **Handset Name**. Press .
3. Type in the name you want to give your handset using the keypad and press  to save.









Settings

Turning the backlight on or off

1. Press  and then use  and  to scroll through to **Personal Set**. Press .
2. Press  until you see **Backlight** and press .
3. Press  and  to scroll between **On** and **Off**, then press  to save.











Changing the call settings

You can set your Essential Phone to Auto Pick-Up and Auto Hang-Up. With Auto Pick-Up, you can answer a call by taking the handset off of the base when it's ringing, without having to press any buttons. If Auto Hang-Up is switched on, you'll be able to end a call by placing the handset back on the base.

1. To change these settings, press  and then press  to scroll through to **Personal Set**. Press .
2. Press  and  again until you get to **Auto Hang-Up** or **Auto Pick-Up**, then press .
3. Press  and  again to go between **On** and **Off**. When you get to the option you want, press  and your changes will be saved.











Base settings

Setting the base ringtone

1. Press  and then scroll through to **Personal Set**, using the  and  buttons. Press .
2. Press  until you get to **Base Tone** and press .
3. **Base Melody** will show on the screen. Press .
4. The base will play your current ringtone. Press  and  to choose between five different ringtones, then press .

Choose from 5 base ringtones. The default base ringtone is Melody 1.

Setting the base ringer volume









1. Press  and then press  to scroll through to **Personal Set**. Press .
2. Press  until you get to **Base Tone**, then press .
3. Press  to scroll through to **Base Volume**. Press .
4. The base will ring at its current volume. Use  and  to choose the volume you want.
5. When you've chosen the right volume, press  to save your changes.

There are 4 base ringer volume levels, Low, Medium, High and Melody Off. The default is Medium.

Change the system PIN

To change some of the settings on your phone, you'll need to give your access PIN. This is a four-digit number and the default is set to 0000.







Base settings

1. To change it, press  and then press  or  to scroll through to **Advanced Set**. Press .
2. Press  until you see **PIN** on the display screen. Press .
3. If you haven't set one before, you'll be prompted to set a four-digit PIN. When you've done it, press . Or if you're changing a PIN you've already set, you'll be asked to type in the current PIN. Then follow the instructions on the screen to set a new one and press .
4. Enter your new PIN again and press . **Saved!** will show on the screen.

Reset

If you choose to do this, your Essential Phone will go back to the settings it had when it arrived.









Your phonebook will still be saved on your phone if you reset.

1. Press  and then press  until you see **Advanced Set**. Press .
2. Press  until you get to **Reset** and then press .
3. **Reset Confirm?** will show on the screen. Press  to confirm. When your handset has finished resetting, you'll hear a confirmation beep.

If the handset or base settings are reset, the handset will restart automatically.

Clock/Alarm











Setting the date and time

1. Press , then scroll  to **Clock/Alarm**. Press .
2. **Date & Time** is displayed press .
3. Use the keypad to type in the date and press . Enter the time in 12 hour format, then choose **AM** or **PM** by pressing  or  to select **A** for **AM** or **P** for **PM**. Press  to save.



The clock on your Essential Phone is 12 hour format.

If you have subscribed to a Caller Display service the time and month may be set when you receive your first call but you will still need to set the year.

Setting an alarm

1. Press , then scroll  to **Clock/Alarm** and press .
2. Press  until you see **Set Alarm**, press .
3. Press  and  to choose how often you want the alarm to go off: **Off, On Once, On Daily**. Press .
4. Using the keypad, type in the time you want to set the alarm for and press . When you've set your alarm, the  icon will show on the display screen.

Switching the alarm off

When the alarm goes off, the screen will light up, the alarm will ring at the progressive level and Alarm On and the  will flash on the display. To switch it off, press .

Using additional handsets

Registering an additional handset

If you bought your Essential Phone as a multipack, all the handsets that came with it will be registered at the base. If you buy new handsets separately, you'll need to register them before you can use them.

You can register up to four handsets and have to complete the registration process in two minutes.

At the base:

1. Press and hold **Find** until you hear a beep. You now have 2 minutes to register a handset.

At the handset:

1. Press **Menu**, then press **Find** until you see **Advanced Set**. Then press **Menu**.
2. Press **Find** until **Register** is displayed. Press **Menu**.
3. You'll be asked to confirm your PIN (default PIN is 0000). Type it in and then press **Menu**. When your handset is registered, it'll be given a handset number.

De-registering a handset

1. Press **Menu**, then press **Find** to **Advanced Set**. Press **Menu**.
2. Press **Find** until you come to **Unregister**. Press **Menu**.

You can register up to four GAP compliant handsets to your Essential Phone base to extend your phone system without needing to install telephone extension sockets for each new phone.



You have 2 minutes to complete the registration process.

If registration isn't successful the first time, please try again in case the base registration period ran out of time.

If there are already four handsets registered to the base, the registration will fail. You must de-register another handset before you can register the new one.

Using additional handsets

3. Type your 4 digit PIN, then press .

4. Press  or  to select the handset you want to delete, then press . You'll hear a confirmation tone.

Making an internal call between handsets



If you've got more than one handset registered to your base, you can make internal calls between them.



1. Press and hold  the handset will display all the registered handsets, use  and  to scroll through and press  to select the handset you want to call.

Transferring a call

You can transfer an external call from one handset to another registered to the base.

1. When you're on the call, press and hold . Your caller will be put on hold.

2. Press  and  to get to the handset you want to send the call to. Press .

3. When the handset answers, announce the caller and then press  to transfer the call. If the handset doesn't answer, press and hold  again to talk to your caller.

Registering another make of handset to your Essential Phone base





If you want to register another make of handset (i.e. not a Essential Phone handset) to your Essential Phone base you will need to follow the Registration instructions that came with the handset first and then continue with the base part of the registration procedure (as shown in point 1 on page 50).

The additional handset may only be able to make and receive calls, and may not be able to perform other functions available on the Essential Phone.

Using additional handsets

Holding a three-way call

You can hold three-way calls with either two external callers or, if you've got more than one handset, two internal handsets and one external caller.

1. During a call, press and hold . This will put your caller on hold.
2. Press  and  to find the handset you want to add to the call.
3. When the other handset answers, you can announce the call and press  to connect the calls.
4. If the other handset doesn't answer, press and hold  to talk to your caller again.

Menu map

Phonebook

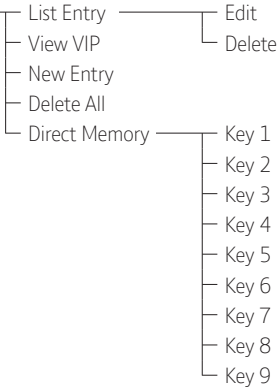

Call Block

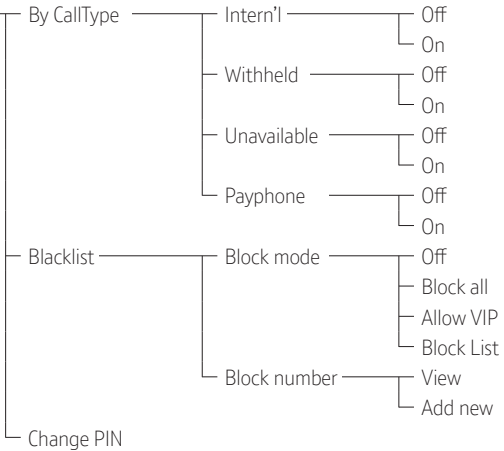

Menu map

Clock/Alarm

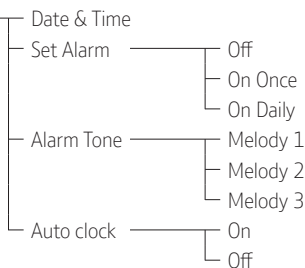

Personal Set

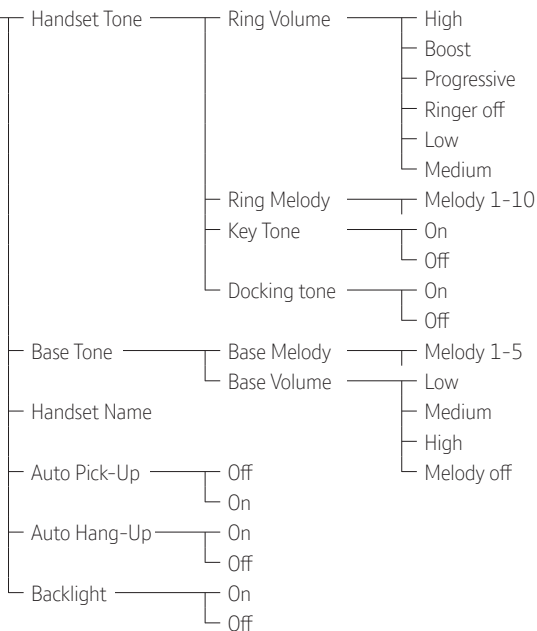

Menu map

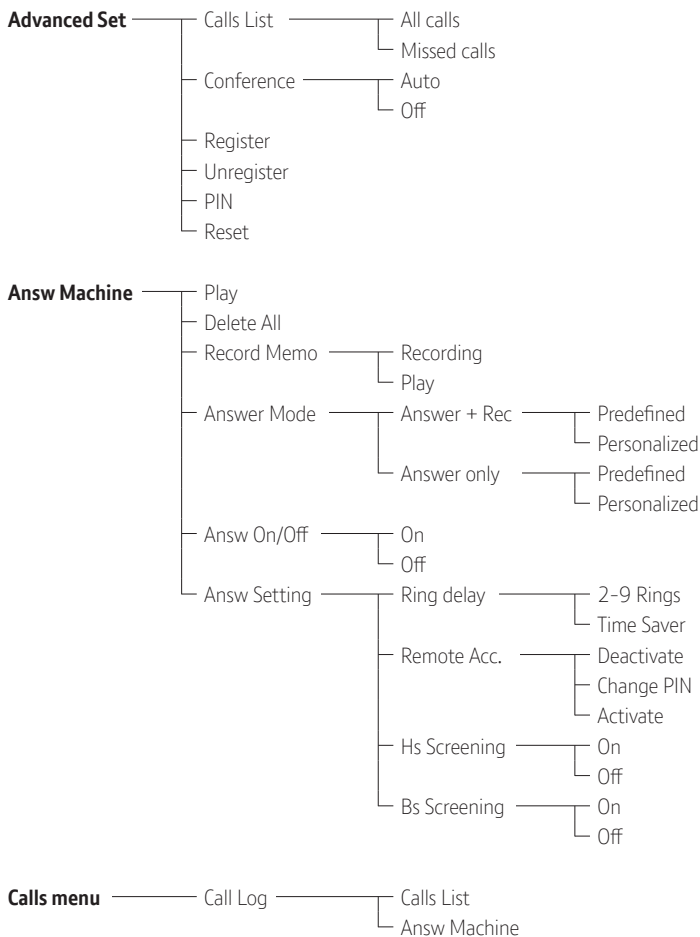

Help

Cannot make calls or receive calls or phone doesn't ring

This may be due to several factors. Please try the following tests in order.

- First, ensure that you're using the line cord that was supplied with the phone. Your existing line cord may not be suitable.
- Check that both ends of the supplied line cord are connected securely.
- Check that the power is on and that you have the power adaptor correctly plugged into a known working mains socket and also to the telephone base unit.
- Ensure that the batteries are charged.
- Confirm that the ringer isn't switched off on either the handset or the base. See pages 21 and 47.
- Check if call divert is activated on the line.
- Check your BT Call Blocking settings. See Page 23.
- Make sure that the handset is registered to the base. See page 50.
- Disconnect the batteries, line cord and mains power, wait for 10 minutes, then reconnect and try again.

If you've checked the above and still cannot make or receive calls or your phone doesn't ring, please try the following tests in order:

- If the line cord isn't connected to the telephone master socket (usually the one nearest to the front door), test it in the master socket without any adapters, filters, splitters or extension cables. If the problem clears there may be a problem with your internal wiring between the telephone sockets it may be that the adapter, filter, splitter or the extension cable the phone was connected to is faulty.
- Try connecting another known working telephone to the telephone line socket. If you cannot make or receive calls on another known working telephone either, please contact your service provider for the line to be checked.
- Try testing your telephone on a telephone line in a different property (e.g a neighbour's or a friend's line). This will also help verify whether the phone or line is at fault.

Interference, noise or poor speech quality

This may be due to several factors. Please try the following tests in order:

- Ensure that your main base is not placed close to any electrical or metal appliances.
- If you have a broadband service, on most broadband lines, an adsl filter is required. Please try the phone with adsl filters installed in all the sockets that are in use. Please go to bt.custhelp.com/app/answers for instructions on installing adsl filters, or call **0800 111 4567**.
- If your phone is already attached to the filter, it may be that the filter is faulty. Please try another filter
- If the line cord is not connected to the telephone master socket (usually the one nearest to the front door), test it in the master socket without any adapters, filters, splitters or extension cables. If the problem clears there may be a problem with your internal wiring between the telephone sockets it may be that the adapter, filter, splitter or the extension cable the phone was connected to is faulty.
- Try testing your telephone on a telephone line in a different property (e.g a neighbour's or a friend's line).

This will help verify whether the phone or line is at fault.

Phone doesn't seem to get a very good range

Conditions such as the construction of the building in which the base/handset is placed including the wall material and thickness of walls can affect the range. Please ensure that:

- your main base is not placed close to any electrical or metal appliances.
- the distance between the base and handset is obscured by as few walls as possible.
- try placing your base in another location of the property

Handset continually displays 'Searching' on the screen

If the handset displays 'Searching' on the screen, this indicates that the handset has lost its link with the base. Please try the following tests in order:

- Confirm that the power lead has not been inadvertently disconnected from the base.
- Ensure that the handset batteries are correctly installed and are fully charged.
- Ensure that the handset and base are within range of each other.
- Disconnect the batteries and

mains power, wait for 10 minutes, then reconnect and try again.

Answering machine doesn't record messages

- Check that the power is on and that you have the power adaptor correctly plugged into a known working mains socket and also to the telephone base unit.
- Check that you have the answering machine turned on to receive messages.
- If you have BT 1571 or a voicemail service from your network provider, please make sure that answer delay on your answer machine is set to answer before the voicemail service.
- Disconnect the batteries, line cord and mains power, wait for 10 minutes, then reconnect and try again.

If you've checked the above and still your answering machine doesn't record messages, please try the following tests in order:

- If the line cord isn't connected to the telephone master socket (usually the one nearest to the front door), test it in the master socket without any adapters, filters, splitters or extension cables. If the problem clears there may be a problem with your internal wiring between the telephone sockets it may be that the adapter, filter, splitter or the extension cable the phone was connected to is faulty.
- Try connecting another known working answering machine telephone to the telephone line socket. If your answer machine doesn't record messages on your other known working answering machine telephone either, please contact your service provider for the line to be checked.
- Try testing your telephone on a telephone line in a different property (e.g a neighbour's or a friend's line). This will also help verify whether the phone or line is at fault.

General information



Important

This equipment is not designed for making emergency phone calls when the power fails. Alternative arrangements should be made for access to emergency services. This product is intended for connection to analogue public switched phone networks and private switchboards in the United Kingdom.

Replacing the handset batteries

After a time, you might find that the handset batteries run out of charge more quickly. This is a standard sign of wear and the batteries will need replacing.

1. Open the battery compartment cover.
2. Lift the battery out and remove the batteries. Replace with two new AAA Ni-MH 550mAh rechargeable batteries.
3. Replace the battery compartment cover.

Caution

Don't immerse batteries in water, throw them into a fire or dispose of them with ordinary domestic refuse. BT accepts no responsibility for damage caused to your Essential Phone by using any other types of batteries.

There is a risk of explosion if incorrect batteries are fitted.

Safety

- Only use the power supply suitable for the Essential Phone. Using an unauthorised power supply will invalidate your guarantee and may damage the phone. The item code for the base mains power supply is 090713. If you've bought a multiple pack, the item code for the charger mains power supply is 090713s.
- Use only the approved rechargeable batteries supplied. Spare rechargeable batteries are available by calling Discom on 0800 9808 999*.
- Don't open the handset (except to replace the handset batteries) or the base. This could expose you to high voltages or other risks. Contact the Helpline on **0800 145 6789*** for all repairs.

General information

- Radio signal transmitted between the handset and base may cause interference to hearing aids.
- It is recommended that advice from a qualified expert be sought before using this product in the vicinity of emergency/intensive care medical equipment.
- It is recommended that if you have a pacemaker fitted you check with a medical expert before using this product.
- Your product may interfere with other electrical equipment, e.g. TV and radio sets, clock/alarms and computers if placed too close.
- It is recommended that you place your product at least one metre away from such appliances to minimise any risk of interference.
- Never dispose of batteries in a fire. There is a serious risk of explosion and/or the release of highly toxic chemicals.

Cleaning

Clean the handset and base (or charger) with a damp (not wet) cloth, or an anti-static wipe. Never use household polish as this will damage the product. Never use a dry cloth as this may cause a static shock.

Environmental

- Do not expose to direct sunlight.
- The handset may become warm when the batteries are being charged or during prolonged periods of use. This is normal. However, we recommend that to avoid damage you do not place the product on any surface susceptible to heat damage.
- Do not stand your product on carpets or other surfaces which generate fibres, or place it in locations preventing the free flow of air over its surfaces.
- Do not submerge any part of your product in water and do not use it in damp or humid conditions, such as bathrooms.
- Do not expose your product to fire, explosive or other hazardous conditions.
- There is a slight chance your phone could be damaged by an electrical storm. We recommend that you unplug the power and phone line cord during an electrical storm.

General information

How to recycle your equipment

The symbol shown here and on the product means that the product is classed as  electrical or electronic equipment, so DO NOT put it in your normal rubbish bin.

It's all part of the Waste Electrical and Electronic Equipment (WEEE) Directive to recycle products in the best way – to be kinder to the planet, get rid of dangerous things more safely and bury less rubbish in the ground.

You should contact your retailer or supplier for advice on how to dispose of this product in an environmentally friendly way.

Warning

You won't be able to call 999 from this phone if there's a power cut, so make sure you've got another way to call for help in an emergency.

Radio Equipment Directive Declaration of Conformity

Hereby, British Telecommunications plc declares that the radio equipment type Essential Phone Telephone (090657, 090658, 090659, 090660) is in compliance with Directive 2014/53/EU.

The full text of the EU declaration of conformity is available at the following internet address: bt.com/producthelp

EU Frequency band restriction

This device may be used in each member state.

Radio transmission information

Frequency range

1881.792 – 1897.344MHz

Max power

135.83mW 21.33dBm

Operating temperature

0°C to 40°C.

Guarantee

Your Essential Phone is guaranteed for 12 months from the date of purchase. Subject to the terms listed below, the guarantee will provide for the repair of, or at BT's or its agent's discretion, the option to replace the Essential Phone or any component thereof, (other than batteries), which is identified as faulty or below standard, or as a result of inferior workmanship or materials. Products over 28 days old from the date of purchase may be replaced with a refurbished or repaired product.

General information

Guarantee conditions

- The guarantee shall only apply to defects that occur within the 12 month guarantee period.
- Proof of purchase is provided.
- The equipment is returned to BT or its agent as instructed.
- This guarantee doesn't cover any faults or defects caused by accidents, misuse, fair wear and tear, neglect, tampering with the equipment, or any attempt at adjustment or repair other than through approved agents.
- This guarantee does not affect your statutory rights.

Within the 12 month guarantee period

Prior to returning your product, please read the Help section beginning on page 56 or contact the Essential Phone Helpline on 0800 145 6789. Additional answers to frequently asked questions are available from bt.com/producthelp

In the unlikely event of a defect occurring, the helpdesk will issue a Fault Reference Authorisation (FRA) number and instructions for replacement or repair. Please note

you will need the FRA number before returning the product. This does not affect your statutory rights.

Outside of the 12 month guarantee period

If your product needs repair after the guarantee period has ended, the repair must meet the approval requirements for connection to the phone network.

We recommend that you contact BT's recommended repair agent Discount Communications on 0800 980 8999 or a local qualified repairer.

Returning your phone

If the Helpline is unable to remedy your problem they will issue a Fault Reference Authorisation number and ask you to return the product to your original place of purchase. Where possible, pack the product in its original packaging. Please remember to include all parts, including the line cords, power supply units and the original batteries.

General information

Technical details

How many phones can I have?

All items of telephone equipment have a Ringer Equivalence Number (REN), which is used to calculate the number of items which may be connected to any one telephone line. Your Essential Phone has a REN of 1. A total REN of 4 is allowed. If the total REN of 4 is exceeded, the telephones may not ring. With different telephone types there is no guarantee of ringing, even when the REN is less than 4.

Any additional handsets and chargers that you register have a REN of 0.

Connecting to a switchboard

Switchboard compatibility

This telephone may be connected to most types of switchboard, however in the event of any difficulties, consult your switchboard Service Provider.

Recall (R)

Recall is used when connected to certain switchboards/PBXs and some BT Calling Features, or those services available via your network provider. The Essential Phone supports timed break recall but not earth loop recall.



Offices worldwide

The services we've described in this publication may not always be available and we may change them. Nothing we've written here is contractual. When we supply services and equipment, our terms and conditions apply.

© British Telecommunications plc 2017
We're registered in England at 81 Newgate Street,
London EC1A 7AJ (company number 1800000).

Available in other formats including braille, large print or audio CD. If you would like a copy, please call 0800 145 6789*.

* Calls made from within the UK mainland network and mobile networks are free. International call costs may vary.

Essential Phone (10/17) Issue 1

