

ArenaMatch AM20

DeltaQ array loudspeaker

Product Overview

Bose Professional ArenaMatch loudspeakers bring proven DeltaQ sound quality and flexibility to outdoor installations — sports stadiums, arenas, outdoor entertainment centers, and more. Rated for direct-exposure outdoor installations, ArenaMatch DeltaQ modules make it easy to create outdoor loudspeaker arrays that bring consistent, intelligible sound to every listener. Nine coverage patterns are available. Choose from modules with 10°, 20°, or 40° vertical coverage and easily swap between 60°, 80°, or 100° horizontal waveguides to build arrays that are lighter, require less installation time, and can lower overall system costs by delivering full coverage with fewer modules.



Shown with grille off

Key Features

Improve sound quality, consistency, and vocal clarity with DeltaQ array technology, which allows directivity, or “Q,” to vary in each module to more precisely match coverage to the audience area

Easily customize horizontal coverage with replaceable waveguides that allow you to further customize coverage and even form asymmetrical patterns for improved acoustic performance in left/right arrays

Deliver high-SPL, long-throw music reproduction and vocal intelligibility with a 14-inch neodymium woofer and six Bose EMB2S titanium-diaphragm neodymium compression drivers

Rated for direct-exposure outdoor installations, with three-layer stainless steel grille, water-resistant woofer cone coating, industrial polyurethane exterior coating, and molded input cover

Provide full coverage with fewer modules — 10°, 20°, and 40° modules allow you to create arrays that improve sight lines, reduce weight, and lower system costs by requiring fewer modules compared to conventional arrays

Reduce commissioning time by using 40° modules for point-source applications and 10°, 20° and 40° modules for line arrays — all with the same transducers for consistent tonal balance

Adapt to a variety of configurations — all models ship standard with bi-amp capability, passive crossover, and 70/100V transformer inputs

Streamline the design process by combining with complementary Bose Professional products, such as ArenaMatch Utility zone-fill loudspeakers, PowerMatch amplifiers, and ControlSpace DSPs

Save time during installation using Bose accessory mounting hardware or use the standard M12 threaded inserts to interface with custom array frames

EN 54-24 Certified: EN 54-24: 2008, Loudspeaker for Voice Alarm Systems for Fire Detection and Fire Alarm Systems for Buildings

ArenaMatch AM20

DeltaQ array loudspeaker

Technical Specifications

Single Module Performance									
Frequency Response (-3 dB) ¹	65 Hz to 16 kHz								
Frequency Range (-10 dB)	55 Hz to 18 kHz								
Nominal Coverage Pattern (H × V)	60° × 20° (AM20/60) or 80° × 20° (AM20/80) or 100° × 20° (AM20/100)								
Recommended High-pass Filter	60 Hz with minimum 12 dB / octave								
Crossover	950 Hz internal passive or external bi-amp (Bose ControlSpace presets)								
70V/100V transformer tap settings	70V: 100W, 200W, 400W; 100V: 200W, 400W								
	Bose Extended Lifecycle Test ²			AES Transducer Test ³					
	LF (bi-amp)	HF (bi-amp)	Low-Z Passive	LF (bi-amp)	HF (bi-amp)	Low-Z Passive	LF (bi-amp)	HF (bi-amp)	Low-Z Passive
Power Handling, long-term continuous	600 W	150 W	750 W	1000 W	250 W	1250 W			
Power Handling, peak	2400 W	600 W	3000 W	4000 W	1000 W	5000 W			
	AM20/60			AM20/80			AM20/100		
	LF	HF	Low-Z Passive	LF	HF	Low-Z Passive	LF	HF	Low-Z Passive
Sensitivity (SPL / 1 W @ 1 m) ⁴	94 dB	106 dB	99 dB	94 dB	105 dB	98 dB	94 dB	104 dB	97 dB
Calculated max. SPL @ 1 m (Bose power test) ⁵	122 dB	128 dB	128 dB	122 dB	127 dB	127 dB	122 dB	126 dB	126 dB
Calculated max. SPL @ 1 m (2-hour power test)	124 dB	130 dB	130 dB	124 dB	129 dB	129 dB	125 dB	128 dB	128 dB
Calculated max. SPL @ 1 m (Bose power test), peak	128 dB	134 dB	134 dB	128 dB	133 dB	133 dB	128 dB	132 dB	132 dB
Calculated max. SPL @ 1 m (2-hour power test), peak	130 dB	136 dB	136 dB	130 dB	135 dB	135 dB	130 dB	134 dB	134 dB
Certifications	EN 54-24 Certified: EN 54-24: 2008, Loudspeaker for Voice Alarm Systems for Fire Detection and Fire Alarm Systems for Buildings, refer to the ArenaMatch DeltaQ Array Loudspeaker Installation Guide AM814939 Rev. 01 for specifications								
Physical									
Low Frequency	1 × Bose LF14 neodymium 14-inch woofer (4-inch voice coil)								
High Frequency	6 × Bose EMB2S titanium-diaphragm, neodymium compression drivers (2-inch voice coil)								
Nominal Impedance	Passive: 8 Ω / Bi-amp: 8 Ω + 8 Ω								
Physical									
Enclosure Material	Exterior-grade birch plywood								
Finish	Two-part polyurea coating, black								
Grille	Powder-coated perforated stainless steel, acoustic foam, stainless steel mesh								
Environmental ⁶	Rated for direct-exposure outdoor installations (IP55 per EN60529; IP33C per EN54-24)								
Connectors	Barrier strips: passive in/through, bi-amp, and 70V/100V, with cover								
Suspension/Mounting	8 × M12 non-stainless steel threaded inserts (4 per side); 2 × M10 stainless steel threaded inserts (1 per side); 2 × M6 stainless steel threaded inserts (1 per side); 1 × M10 stainless steel threaded insert, rear safety connection								
Dimensions (H × W × D)	437 × 783 × 416 mm (17.2 × 30.8 × 16.4 in)								
Net Weight	36.2 kg (80 lb)								
Shipping Weight	43.3 kg (95 lb)								
Accessories	U-bracket, array suspension kits, waveguide kits								
Product Codes									
794042-6660	ARENAMATCH AM20/80 OUTDOOR LDSPKR 80x20								
794042-3360	ARENAMATCH AM20/60 OUTDOOR LDSPKR 60x20								
794042-8860	ARENAMATCH AM20/100 OUTDOOR LDSPKR 100x20								

Footnotes

- (1) Frequency response and range measured on-axis in anechoic environment with recommended bandpass and EQ. Frequency response graphs display SPL axis with 0 dB line referenced to sensitivity SPL value.
- (2) Bose extended-lifecycle test using pink noise filtered to meet IEC268-5, 6-dB crest factor, 500-hour duration.
- (3) AES standard 2-hour duration with IEC system noise.
- (4) Sensitivity measured in anechoic environment with recommended bandpass and EQ.
- (5) Maximum SPL calculated using sensitivity and power ratings, exclusive of power compression.
- (6) Tested to IP55 per EN60529 when used in General Purpose Audio installation

ArenaMatch AM20

DeltaQ array loudspeaker

Frequency response (60° waveguide)

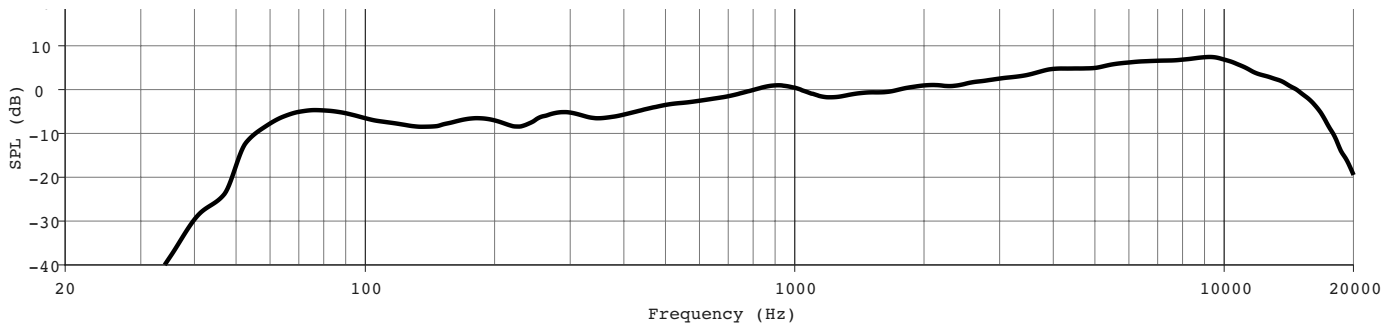

Beamwidth (60° waveguide)

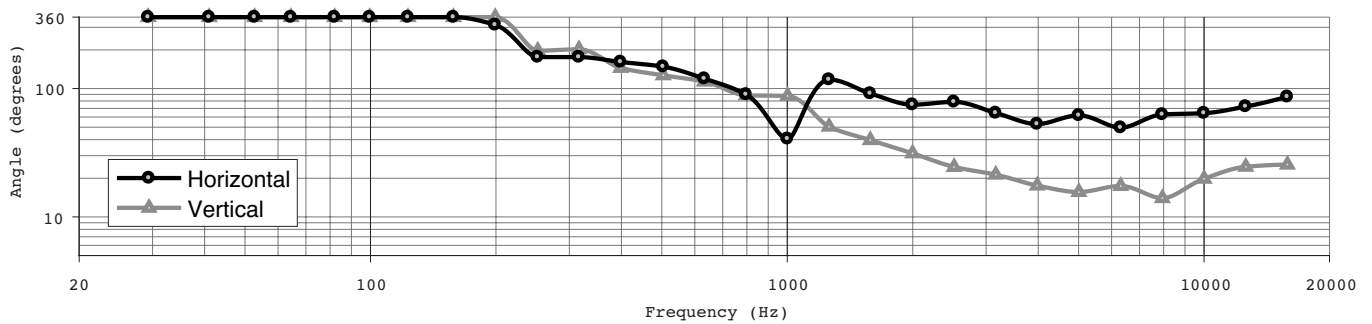

Frequency response (80° waveguide)

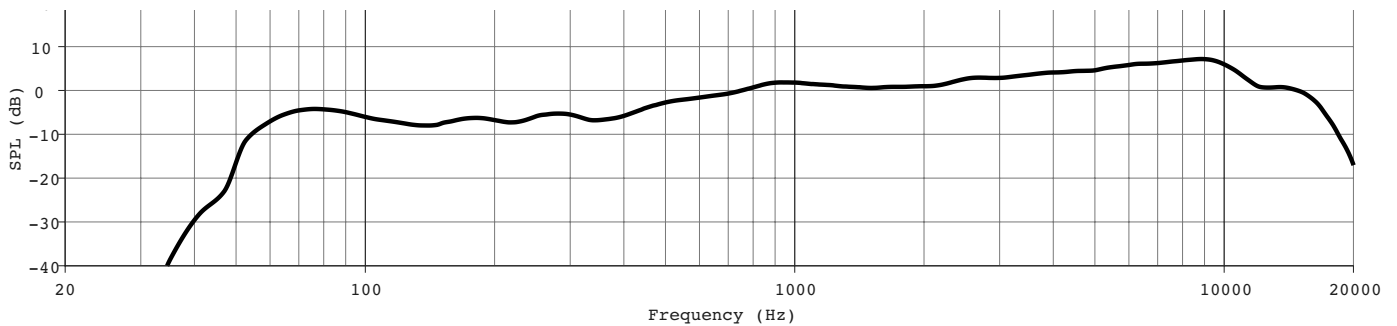

Beamwidth (80° waveguide)

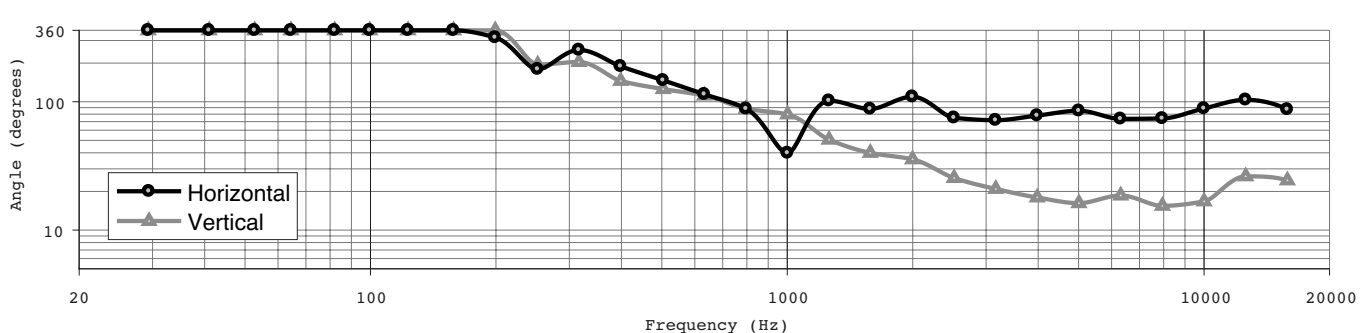

ArenaMatch AM20

DeltaQ array loudspeaker

Frequency response (100° waveguide)

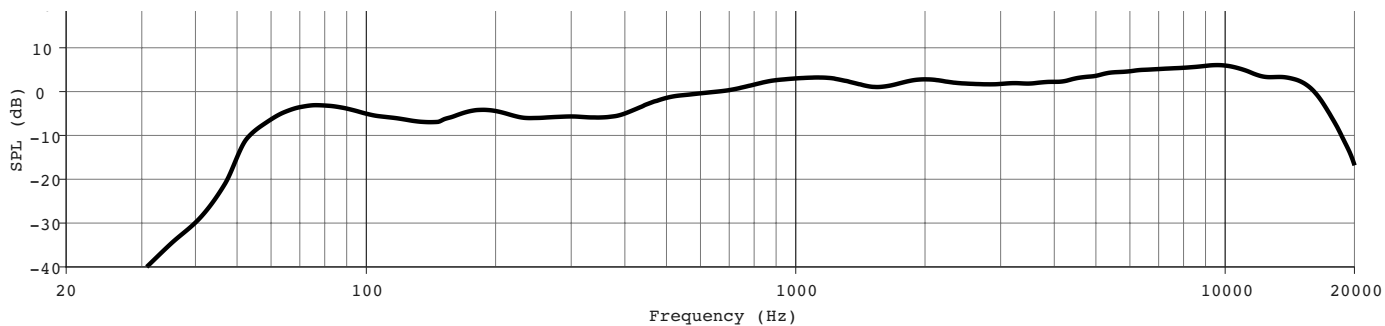

Beamwidth (100° waveguide)

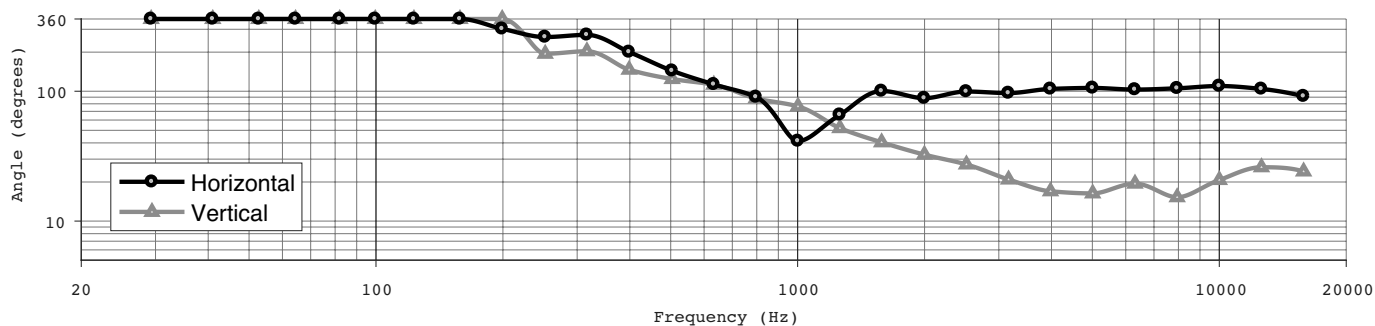

ArenaMatch AM20

DeltaQ array loudspeaker

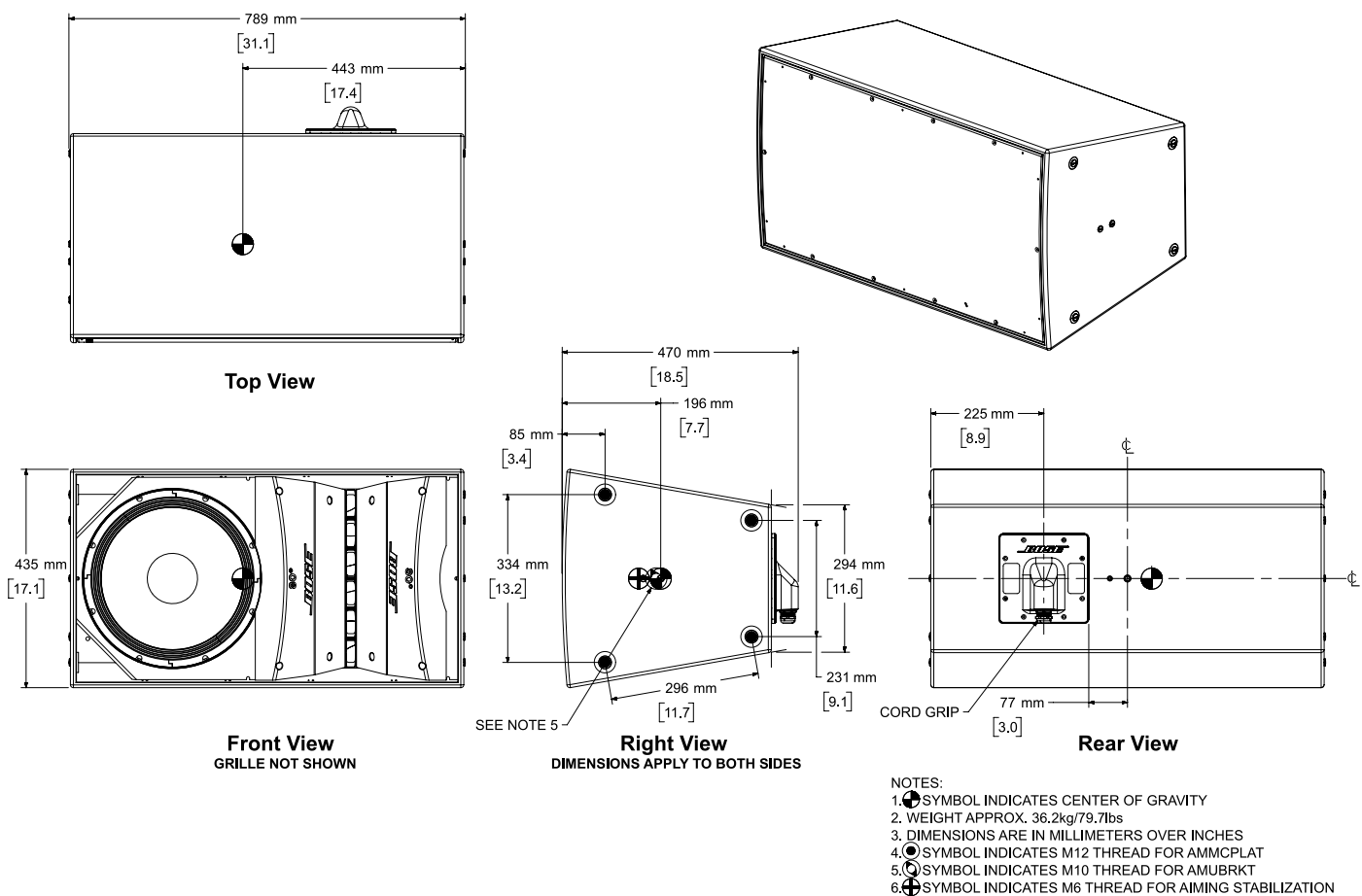

For additional specifications and application information, please visit PRO.BOSE.COM.