

# MIDDLE ATLANTIC®

A brand of  legrand®



---

## Premium+ Series PDU with RackLink™

### User Manual

I-00826 Rev E





©2026 | [Legrand AV, Inc.](#) All rights reserved.

Information in this document is subject to change without notice. The AV equipment described in this document is furnished under a license agreement or nondisclosure agreement. The equipment may be used or copied only in accordance with the terms of those agreements. No part of this publication may be reproduced, stored in a retrieval system, or transmitted in any form or any means electronic or mechanical, including photocopying and recording for any purpose other than the purchaser's personal use without the written permission of Legrand AV.

---

Middle Atlantic Products is a brand of Legrand AV.

[www.legrandav.com](http://www.legrandav.com) | Phone: (866) 977-3901 | Fax: (877) 894-6918 | Email: [av.middleatlantic.techsupport@legrand.com](mailto:av.middleatlantic.techsupport@legrand.com)

Visit us at [www.legrandav.com](http://www.legrandav.com) for firmware updates, specifications, drawings, manuals, technical support information, and more.

Middle Atlantic Products is a registered trademark of Legrand AV, Inc.

Legrand AV is an ISO 9001 and ISO 14001 Registered Company.

All patents are protected under existing designations. Other patents pending. For more information, refer to the Patents page on the website at <https://www.legrandav.com/resources/patents>.

All other brand names or marks are used for identification purposes and are trademarks of their respective owners.

Legrand AV Inc. Brands: Connectrac | C2G | Chief | Da-Lite | Luxul | Middle Atlantic | Nuvo | On-Q |

Sanus | Vaddio | Vantage | Wiremold

# Contents

<b>IMPORTANT SAFETY INSTRUCTIONS .....</b>	<b>vii</b>
Waste Electrical and Electronic Equipment (WEEE) Directive .....	viii
REGULATORY COMPLIANCE .....	viii
Federal Communications Commission (FCC) Compliance Statement .....	viii
Industry Canada (IC) ICES-003 Class B Notice. This Class B digital apparatus complies with Canadian ICES-003. ....	viii
<b>INSTRUCTIONS IMPORTANTES SUR LA SÉCURITÉ.....</b>	<b>ix</b>
Directive sur les déchets d'équipements électriques et électroniques (WEEE) .....	x
CONFORMITÉ RÉGLEMENTAIRE .....	x
Déclaration de conformité de la Federal Communications Commission (FCC).....	x
<b>Understanding General Symbols and Terms.....</b>	<b>xii</b>
<b>Supplied Components and Hardware .....</b>	<b>xiii</b>
<b>Required Tools .....</b>	<b>xiii</b>
<b>Introduction .....</b>	<b>14</b>
Before You Begin .....	14
Using RackLink Interfaces, Tools, and Applications .....	14
Where to Find Your IP Address.....	14
<b>Understanding RackLink Model Feature Sets.....</b>	<b>15</b>
Panel Components.....	15
Power Button and Inlet .....	15
Outlets .....	16
Front Panel (Rackmount PDUs Only).....	17
I/O Panel.....	18
Reset Button .....	19
Circuit Breakers.....	20
Resetting the Circuit Breaker.....	20
<b>Connecting Your PDU.....</b>	<b>21</b>
Connecting the PDU to a Power Source .....	21
Connecting the PDU to Your Network .....	21
Connecting the PDU to Your Network Using Wired Ethernet .....	21
Making a Wireless Connection Using The USB WIFI Dongle .....	22
Supported Wireless LAN Configuration.....	22
<b>Using the Web Interface .....</b>	<b>23</b>
Supported Web Browsers.....	23
Accessing the Web Interface .....	23
Remembering User Names and Passwords.....	25
Logout.....	26
Web Interface Overview .....	26
Menu .....	28
Quick Access to a Specific Page .....	29
Sorting a List .....	29

Dashboard .....	30
Alarms.....	31
Alerted Sensors .....	32
Inlet Device Status.....	33
Outlets.....	34
Peripherals.....	65
Understanding the Sensor/Dry Contact Overview on the Peripheral Devices Page .....	66
Releasing Sensors/Dry Contacts .....	67
Managing One Sensor or Dry Contact .....	67
Managing Multiple Sensors/Dry Contacts.....	69
Configuring Default Threshold Settings.....	70
Turning ON or OFF Dry Contacts .....	70
Yellow- or Red-Highlighted Sensors .....	71
Managed vs. Unmanaged Sensors/Dry Contacts .....	71
Understanding Unmanaged Sensors/Dry Contacts.....	71
Sensor/Dry Contact States .....	72
Finding the Sensor's Serial Number.....	73
Identifying the Sensor Position and Channel .....	73
Understanding Sensor/Dry Contact Position.....	74
Individual Sensor/Dry Contact Pages .....	74
Sensor/Dry Contact Location Example .....	77
User Management.....	78
Creating Users .....	78
Editing or Deleting Users .....	81
Deleting Multiple User Accounts.....	82
Creating Roles.....	82
Editing or Deleting Roles .....	83
Changing Your Password .....	84
Setting Your Preferred Measurement Units in User Preferences .....	84
Setting Default Measurement Units.....	85
Device Settings .....	86
Configuring Network Settings .....	86
Configuring Network Services .....	95
Configuring Security Settings .....	100
Setting the Date and Time.....	119
Event Rules and Actions .....	120
Setting Data Logging.....	155
Configuring Data Push Settings .....	156
Monitoring Component Reachability .....	157
Front Panel Settings (Rackmount PDUs Only) .....	161
Serial Port.....	161
Cloud Services .....	162
Maintenance.....	198
Viewing Enabled or Disabled Users .....	198
Device Information.....	199
Viewing Connected Users.....	199
Viewing or Clearing the Local Event Log.....	200
Updating the PDU Firmware .....	201
Viewing Firmware Update History .....	203
Bulk Configuration.....	204
Backup and Restore of Device Settings .....	208
Network Diagnostics.....	210
Downloading Diagnostic Information.....	211
Viewing Hardware Failures.....	212

Resetting Your PDU via Unit Reset .....	212
Retrieving Software Package Information via About PDU .....	215
PDU .....	215
Viewing PDU Details .....	215
Configuring Global Settings .....	215
Viewing PDU Sensor Power Information .....	220
Inlet .....	220
Viewing General Inlet Information .....	220
Viewing Inlet Sensor Information .....	221
Viewing and Configuring Inlet Settings .....	222
Inlet History .....	223
Inlet Thresholds .....	223
<b>Using SNMP .....</b>	<b>224</b>
<hr/>	
Enabling and Configuring SNMP .....	224
Enabling SNMP v1/v2c and/or v3 Protocols .....	224
Configuring Users for SNMP v3 Access .....	224
Enabling SNMP Notifications .....	224
Configuring SNMPv2c Notifications .....	225
Configuring SNMPv3 Notifications .....	225
Downloading SNMP MIB .....	226
Downloading the MIB from the SNMP Page .....	226
Downloading the MIB from the Device Information Page .....	227
SNMP Gets and Sets .....	227
The PDU MIB .....	227
Retrieving Energy Usage .....	229
A Note about Enabling Thresholds .....	229
<b>Specifications .....</b>	<b>230</b>
<hr/>	
Specifications for Compact MOV Models .....	230
Summary .....	230
Hardware Features .....	230
Software Features .....	231
Physical .....	232
Warranty .....	232
Specifications for Compact IEC Models .....	232
Summary .....	232
Hardware Features .....	233
Physical .....	233
Warranty .....	234
Specifications for Rackmount MOV Surge Models .....	234
Summary .....	234
Hardware Features .....	235
Software Features .....	235
Physical .....	236
Specifications for Rackmount Series Surge Protection Models .....	236
Summary .....	236
Hardware Features .....	237
Software Features .....	237
Physical .....	238
Specifications for Rackmount Series Surge Protection Models .....	239
Summary .....	239

Specifications for Rackmount IEC Models .....	239
Summary .....	239
Hardware Features .....	240
Physical .....	241
<b>Resetting to Factory Defaults .....</b>	<b>241</b>
Using the Reset Button .....	242
Using the CLI Command .....	243
Resetting Before CLI Login .....	243
<b>Downloading and Using the Mobile App .....</b>	<b>245</b>
<b>Downloading and Using the RackLink Device Discovery Tool .....</b>	<b>247</b>
Installing the RackLink Device Discovery Tool Software on a Windows PC .....	249
Installing the RackLink Device Discovery Tool Software on a Mac .....	250
Installing the RackLink Device Discovery Tool Software on Linux .....	253
<b>Understanding Port Pinout Configurations .....</b>	<b>254</b>
Serial RS-232 "RJ-45" Port Pinouts .....	254
RJ45-to-DB9 Cable Requirements for Computer Connections .....	254
Sensor RJ-45 Port Pinouts .....	255
Expansion RJ-45 Port Pinouts .....	256
Feature RJ-45 Port Pinouts .....	256
<b>Warranty .....</b>	<b>258</b>

# IMPORTANT SAFETY INSTRUCTIONS

- Read these instructions.
- Keep these instructions.
- Heed all warnings.
- Follow all instructions.
- Clean only with dry cloth.
- Only use attachments/accessories specified by the



**DANGER HAZARDOUS VOLTAGE:** The lightning flash with the arrowhead symbol, within an equilateral triangle is intended to alert the user to the presence of uninsulated dangerous voltage within the product's enclosure that may be of sufficient magnitude to constitute a risk of electric shock to persons.



**WARNING:** A warning alerts you to a situation that could result in serious personal injury or death.



**CAUTION:** A caution alerts you to a situation that may result in minor personal injury or damage to the product and/or property.



**NOTE:** A note is used to highlight procedures pertaining to the installation, operation, or maintenance of the product.

**DANGER HAZARDOUS VOLTAGE:** To reduce the risk of electrical shock: Always unplug this device from the electrical outlet before cleaning.



**WARNING:** Failure to read, understand and follow the following information can result in serious personal injury, damage to the equipment or voiding of the warranty. It is the responsibility of the Installer/User to ensure that this product is loaded according to specifications.



**WARNING:** Risk of Electric Shock: Connect the device to a properly grounded outlet only. Do not defeat the safety purpose of the polarized or grounding-type plug. A polarized plug has two blades with one wider than the other. A grounding type plug has two blades and a third grounding prong. The wide blade or the third prong is provided for your safety. If the provided plug does not fit into your outlet, consult an electrician for replacement of the obsolete outlet.



**WARNING:** The apparatus shall not be exposed to dripping or splashing and that no objects filled with liquids, such as vases, shall be placed on the apparatus.



**WARNING:** To reduce the risk of burns, fire, electric shock, or injury to persons:

- Unplug from outlet before putting on or taking off parts.
- Close supervision is necessary when this device is used by, or near children, invalids, or disabled persons.
- Use this device only for its intended use as described in these instructions. Do not use attachments not recommended by the manufacturer.
- Never operate the device if it has a damaged cord or plug, if it is not working properly, if it has been dropped or damaged, or dropped into water. Return the device to a service center for examination and repair.
- Protect the power cord from being walked on or pinched particularly at plugs, convenience receptacles, and the point where they exit from the apparatus.
- Keep the cord away from heated surfaces.
- Never drop or insert any object into any opening.
- Do not use outdoors.
- Do not operate where aerosol (spray) products are being used or where oxygen is being administered.
- To disconnect, turn all controls to the off position, then remove plug from outlet.



**CAUTION:** The socket-outlet shall be installed near the equipment and shall be easily accessible.



**CAUTION:** Use indoor in dry locations only.

## Safety Instructions: Rack Mount

**Elevated Operating Ambient:** If installed in a closed or multi-unit rack assembly, the operating ambient temperature of the rack environment may be greater than room ambient. Therefore, consideration should be given to installing the equipment in an environment compatible with the maximum ambient temperature (T<sub>ma</sub>) specified by the manufacturer.

**Reduced Air Flow:** Installation of the equipment in a rack should be such that the amount of air flow required for safe operation of the equipment is not compromised.

**Mechanical Loading:** Mounting of the equipment in the rack should be such that a hazardous condition is not achieved due to uneven mechanical loading.

**Circuit Overloading:** Consideration should be given to the connection of the equipment to the supply circuit and the effect that overloading of the circuit might have on overcurrent protection and supply wiring. Appropriate consideration of equipment nameplate ratings should be used when addressing this concern.

**Reliable Earthing:** Reliable earthing of rack-mounting equipment should be maintained. Particular attention should be given to supply connections other than direct connections to the branch circuit (e.g. use of power strips).

**Disconnect Device (Pluggable Equipment):** The socket-outlet shall be installed near the equipment and shall be easily accessible.

When using electrical products, basic precautions should always be followed, including the following:

- Read and follow all instructions before using.
- There are no user-serviceable components within this device. Removal of the cover from this device may present a shock hazard, and void the warranty.
- The mains plug is used as your disconnect device. This device shall remain readily operable.
- Unplug this apparatus during lightning storms or when unused for long periods of time.
- Do not overload the wall outlet where this device is being connected. Do not overload this device. Ensure the total load to this device does not exceed that which is listed in the specifications section of this manual.
- Ensure this device is connected to a properly grounded AC power source. Ensure the device is plugged into a source providing the required 120V. Do not use a plug adapter that defeats the ground pin of the AC plug.

## Waste Electrical and Electronic Equipment (WEEE) Directive



Correct disposal of this product: This symbol indicates that this product must not be disposed of with household waste, according to the WEEE Directive (2012/19/EU) and your national law. This product should be taken to a collection center licensed for the recycling of waste electrical and electronic equipment (EEE). The mishandling of this type of waste could have a possible negative impact on the environment and human health due to potentially hazardous substances that are generally associated with EEE. At the same time, your cooperation in the correct disposal of this product will contribute to the efficient use of natural resources. For more information about where you can take your waste equipment for recycling, please contact your local city office or your household waste collection service.

## REGULATORY COMPLIANCE

### *Federal Communications Commission (FCC) Compliance Statement*



**CAUTION:** Any changes or modifications not expressly approved by the party responsible for compliance could void the user's authority to operate the equipment.

**NOTE:** This equipment has been tested and found to comply with the limits for a Class B digital device, pursuant to part 15 of the FCC Rules. These limits are designed to provide reasonable protection against harmful interference in a residential installation. This equipment generates, uses and can radiate radio frequency energy and, if not installed and used in accordance with the instructions, may cause harmful interference to radio communications. However, there is no guarantee that interference will not occur in a particular installation. If this equipment does cause harmful interference to radio or television reception, which can be determined by turning the equipment off and on, the user is encouraged to try to correct the interference by one or more of the following measures:

- Reorient or relocate the receiving antenna.
- Increase the separation between the equipment and receiver.
- Connect the equipment into an outlet on a circuit different from that to which the receiver is connected.
- Consult the dealer or an experienced radio/TV technician for help.

### *Industry Canada (IC)*

ICES-003 Class B Notice. This Class B digital apparatus complies with Canadian ICES-003.

# INSTRUCTIONS IMPORTANTES SUR LA SÉCURITÉ

- Lire ces instructions.
- Respectez tous les avertissements.
- Nettoyer uniquement avec un chiffon sec.
- Conservez ces instructions.
- Suivez toutes les instructions.
- N'utilisez que des accessoires spécifiés par le fabricant.



**DANGER TENSION DANGEREUSE:** Le symbole de la pointe de flèche, dans un triangle équilatéral, est destiné à alerter l'utilisateur sur la présence de tension dangereuse non isolée dans l'enceinte du produit qui peut être d'une ampleur suffisante pour constituer un risque d'électrocution.



**AVERTISSEMENT:** Un avertissement vous avertit d'une situation pouvant entraîner des blessures graves ou la mort.



**ATTENTION:** Une attention vous avertit d'une situation pouvant entraîner des blessures mineures ou des dommages au produit et/ou à la propriété.

**REMARQUE:** Une remarque est utilisée pour mettre en évidence les procédures relatives à l'installation, au fonctionnement ou à l'entretien du produit.



**DANGER TENSION DANGEREUSE:** Pour réduire le risque de choc électrique: Toujours débrancher le meuble de la prise électrique avant de le nettoyer.



**AVERTISSEMENT:** Ne pas lire, comprendre et suivre les informations suivantes peut entraîner des blessures graves, des dommages à l'équipement ou de la nullité de la garantie. Il incombe à l'installateur/utilisateur de s'assurer que ce produit est chargé conformément aux spécifications.



**AVERTISSEMENT:** Risque de choc électrique: Brancher le meuble uniquement à une prise correctement mise à la terre. Ne pas détériorer le dispositif de sécurité de la fiche polarisée ou de la fiche de terre. Une fiche polarisée possède deux broches, dont l'une plus large que l'autre. Une fiche de type terre possède deux broches et une troisième de mise à la terre. La broche large ou la troisième broche sont fournies pour des raisons de sécurité. Si la fiche fournie n'entre pas dans votre prise de courant, veuillez faire appel à un électricien pour remplacer la prise obsolète.



**AVERTISSEMENT:** L'appareil ne doit pas être exposé à des éclaboussures et aucun objet rempli de liquide, comme des vases, ne doit être placé sur l'appareil.



**AVERTISSEMENT:** Pour réduire les risques de brûlures, d'incendie, de choc électrique ou de blessures:

- Débrancher de la prise électrique avant d'installer ou de retirer des pièces.
- Surveiller étroitement ce meuble s'il est utilisé par ou à proximité d'un enfant, d'une personne invalide ou handicapée.
- N'utiliser ce meuble que pour l'usage auquel il est destiné, tel que décrit dans la présente fiche d'instructions. Ne pas utiliser d'accessoires non recommandés par le fabricant.
- Ne jamais utiliser ce meuble si le cordon ou la prise est endommagé, s'il ne fonctionne pas correctement, s'il est tombé ou est endommagé, ou s'il est tombé dans l'eau. Renvoyer le meuble à un centre de service après-vente pour qu'il soit examiné et réparé.
- Le cordon d'alimentation doit être placé de manière à éviter qu'il soit piétiné ou pincé, notamment au niveau des prises, des réceptacles et à la sortie de l'appareil.
- Garder le cordon d'alimentation loin des surfaces chauffées.
- Ne jamais faire tomber ou introduire un objet dans une ouverture.
- Ne pas utiliser en extérieur.
- Ne pas utiliser dans des lieux où des produits aérosols sont utilisés ou à proximité d'une source d'oxygène.
- Pour débrancher, placer tous les boutons en position off, puis retirer la fiche de la prise électrique.



**ATTENTION:** La prise de courant doit être installée près de l'équipement et doit être facilement accessible.



**ATTENTION:** Pour être utilisé en intérieur dans un endroit sec seulement.

**Consignes de sécurité:** montage en rack

**Température de fonctionnement:** Si installé dans un rack fermé ou à unités multiples, la température ambiante de fonctionnement de l'environnement du rack peut être supérieure à ambiante de la pièce. Par conséquent, il faudrait envisager d'installer l'équipement dans un environnement compatible avec la température ambiante maximale (T<sub>ma</sub>) spécifiée par le constructeur.

**Réduction Air accréditives:** Installation de l'équipement dans un rack doit être telle que la quantité de flux d'air nécessaire au bon fonctionnement de l'équipement ne soit pas compromise.

**Chargement mécanique:** Le montage de l'équipement dans le rack doit être telle qu'une condition dangereuse ne lié à un chargement mécanique irrégulier.

**Surcharge des circuits:** Il faudrait envisager à la connexion de l'équipement au circuit d'alimentation et l'effet que la surcharge du circuit pourrait avoir sur la protection contre les surintensités et le câblage d'alimentation. Examen approprié des équipements évaluations de la plaque signalétique doit être utilisée pour traiter de cette préoccupation.

**Mise à la terre fiable:** Fiable mise à la terre de l'équipement de montage en rack doit être maintenue. Une attention particulière devrait être accordée aux connexions d'alimentation autres que les connexions directes vers le circuit de dérivation (par exemple de l'utilisation de bandes de puissance).

**Appareil Disconnect (Équipement Pluggable):** La prise de courant doit être installée à proximité du matériel et doit être facilement accessible.

Lors de l'utilisation des produits électriques, des précautions de base doivent toujours être respectées, y compris les suivantes:

- Lire et suivre toutes les instructions avant l'utilisation du matériel.
- Il n'ya pas de composants réparables par l'utilisateur au sein de cet appareil. Retrait de la couverture de cet appareil peut présenter un danger d'électrocution et annuler la garantie.
- La fiche secteur est utilisée comme sectionneur de courant. Ce dispositif doit rester en état de marche.
- Débrancher cet appareil pendant les orages ou s'il n'est pas utilisé pendant de longues périodes.
- Ne surchargez pas le réceptacle de mur ou le circuit qui fournit l'énergie à ce appareil. Ne pas surcharger cette appareil. S'assurer que la charge totale à cet appareil ne dépasse pas celle qui est répertoriée dans la section des spécifications de ce manuel.
- Assurez-vous cet appareil est connecté à une source d'alimentation C/A avec mise à la terre. Assurez-vous cet appareil est branché sur une source d'alimentation fournissant les nécessaires 120V. Ne pas utiliser un adaptateur qui contrecarre la broche de terre de la prise du cordon d'alimentation.

## Directive sur les déchets d'équipements électriques et électroniques (WEEE)



Élimination correcte de ce produit: Ce symbole indique que ce produit ne doit pas être éliminé avec les ordures ménagères, conformément à la directive WEEE (2012/19/EU) et à votre législation nationale. Ce produit doit être déposé dans un centre de collecte agréé pour le recyclage des déchets d'équipements électriques et électroniques (EEE). La mauvaise manipulation de ce type de déchets pourrait avoir un impact négatif possible sur l'environnement et la santé humaine en raison de substances potentiellement dangereuses généralement associées aux EEE. Dans le même temps, votre coopération dans l'élimination correcte de ce produit contribuera à une utilisation efficace des ressources naturelles. Pour plus d'informations sur les lieux de recyclage de vos équipements usagés, veuillez contacter votre mairie ou votre service de collecte des ordures ménagères.

## CONFORMITÉ RÉGLEMENTAIRE

### ***Déclaration de conformité de la Federal Communications Commission (FCC)***



**ATTENTION:** Les changements ou modifications non expressément approuvés par le fabricant peuvent annuler le droit de l'utilisateur à utiliser l'équipement.

**REMARQUE:** Cet équipement a été testé et jugé conforme aux limites d'un dispositif numérique de classe B, conformément à la partie 15 des règles de la FCC. Ces limites sont conçues pour fournir une protection raisonnable contre les interférences nuisibles dans une installation résidentielle. Cet équipement génère, utilise et peut émettre de l'énergie radiofréquence et, si non installé et utilisé conformément aux instructions, peut provoquer des interférences dans les communications radio.

Cependant, il n'y a aucune garantie que des interférences ne se produiront pas dans une installation particulière. Si cet équipement provoque des interférences nuisibles à la réception radio ou de télévision, ce qui peut être déterminé en allumant et éteignant l'équipement, l'utilisateur est encouragé à essayer de corriger l'interférence par une ou plusieurs des mesures suivantes:

- Réorienter ou déplacer l' antenne de réception.
- Augmenter La distance entre l'équipement et le récepteur.
- Brancher l'équipement dans une prise sur un circuit différent de celui sur lequel est branché le récepteur.
- Consulter le revendeur ou un technicien radio/TV expérimenté.

### ***Industrie Canada (IC)***

ICES-003 Avis NMB-003, Classe B. Cet appareil numérique de la classe B est conforme à la norme NMB-003 du Canada.

# Understanding General Symbols and Terms



## **NOTE**

A note highlights procedures pertaining to the installation, operation, or maintenance of the product.



## **REMINDER**

A reminder marks information which may be of importance to you for recalling in context and later use.



## **TIP**

A tip helps users apply techniques and procedures for their specific needs. The information suggests alternative methods that may not be obvious and help users understand the benefits and capabilities of the product. A tip is not essential to the basic understanding of the material.

# Supplied Components and Hardware

After carefully opening all product packaging, identify the supplied components and hardware shown. If any pieces are missing or damaged, please report it immediately to Technical Support at [av.middleatlantic.techsupport@legrand.com](mailto:av.middleatlantic.techsupport@legrand.com) or (866) 977-3901. Keep the original packaging in a safe place for future use.

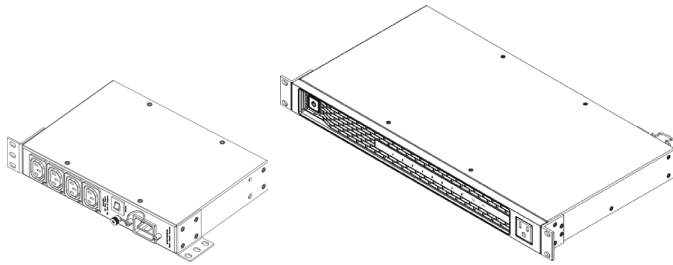

Power Distribution Unit (PDU)

**NOTE:** Form factor and outlet type vary based on model purchased. For data about your specific model, see [Specifications](#), on page 230.

**A**



(4x) 5/16"  
Phillips Screw

**B**

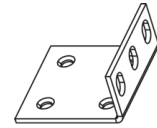

(2x)  
Mounting Bracket

**C**

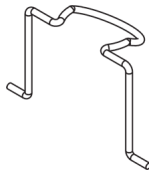

Cord Retainer

**D**

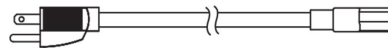

Power Cord

**NOTE:** Cord provided varies based on model purchased.

**E**



Quick Start Guide



## NOTE

- For device hardware setup, please refer to the Quick Start Guide (I-00864 for RLNK-P400 models and I-00827 for RLNK-P900 models) included with your unit.
- To order more hardware, contact support at [av.middleatlantic.techsupport@legrand.com](mailto:av.middleatlantic.techsupport@legrand.com) or (866) 977-3901.

## Required Tools

- #1 Phillips Screwdriver



### WARNING

### AVERTISSEMENT

Use tools with caution and follow all safety protocols.

Utiliser des outils avec prudence et suivre tous les protocoles de sécurité.

# Introduction

Thank you for purchasing Middle Atlantic Products Premium+ PDU with RackLink (referred to in this document as PDU, for Power Distribution Unit).

The complete set of instructions for your PDU is available from [www.legrandav.com](http://www.legrandav.com) and includes the following documents:

- The Quick Start Guide (I-00827 for Rackmount Units, I-00864 for Compact Units)
- The User Manual (I-00826)
- The Advanced User Manual (I-00852)
- The Environmental Sensors User Manual (I-00853)

## Before You Begin

Perform the following activities prior to installation:

- Unpack the product and components and compare the serial number of the equipment with the number on the packing slip located on the outside of the box and make sure they match.
- Prepare the installation site.
- Check the branch circuit rating.



### NOTE

For device hardware setup, please refer to the Quick Start Guide (I-00864 for RLNK-P400 models and I-00827 for RLNK-P900 models) included with your unit.

## Using RackLink Interfaces, Tools, and Applications

Some additional tools, interfaces, and applications for your RackLink device include the Web Interface, the RackLink Cloud Service, the RackLink Discovery Tool, and the Mobile App.

For more information, see the following topics:

- [Using the Web Interface](#) on page 23.
- [Cloud Services](#) on page 162.
- [Downloading and Using the Mobile App](#) on page 245.
- [Downloading and Using the RackLink Device Discovery Tool](#) on page 247.

## Where to Find Your IP Address



### NOTE

Your PDU uses DHCP as the default network configuration. The default static network interface address: 192.168.1.200.

- On Rackmount PDUs only, use the front panel controls to determine the device's IP address. For more information, see [Viewing PDU Information on the Front Panel Display](#), on page 17.
- Use the RackLink Discovery Tool to locate your device's IP address on the network. For more information, see [Downloading and Using the RackLink Device Discovery Tool](#), on page 247.
- Use the command line interface. For more information, refer to the Premium+ PDU With RackLink Advanced User Manual at [www.legrandav.com](http://www.legrandav.com).

For more information about configuring your IP address, see [Ethernet Interface Settings](#), on page 90.

# Understanding RackLink Model Feature Sets

## Panel Components

All PDU models come with the following components on the outer panels.

- Power Button (Rackmount PDUs Only)
- Inlet
- Outlets
- Front Panel Display (Rackmount PDUs Only)
- I/O Panel
- Reset button

### Power Button and Inlet



**NOTE** A power button is only provided on the Rackmount PDU.

Connect your PDU to an appropriately rated branch circuit. See the markings on your PDU for appropriate input ratings or range of ratings.

For more information about power connections, see [Connecting the PDU to a Power Source](#), on page 21.

### Rackmount PDU (Power Button Color Amber: OFF and White: ON)

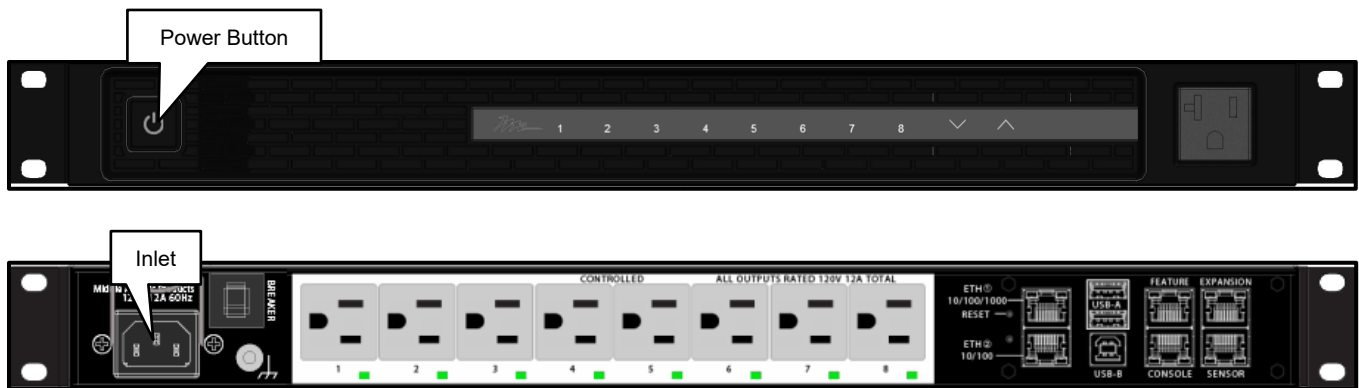

### Compact PDU

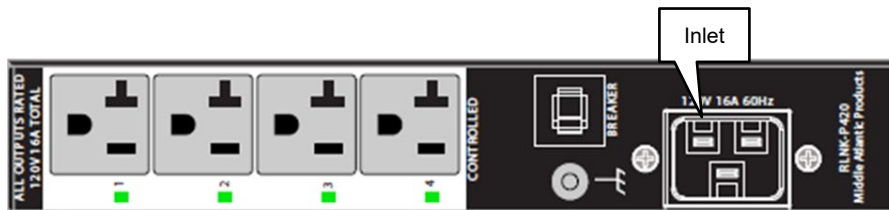



**NOTE** Images in this topic show power button and inlet locations for all rackmount and compact models. Electrical ratings and outlet types vary based on model purchased. For data about your specific model, see [Specifications](#), on page 230.

## Outlets

A small LED adjacent to each outlet indicates the outlet or PDU state. The PDU is shipped from the factory with all outlets turned ON.

### Rackmount PDU

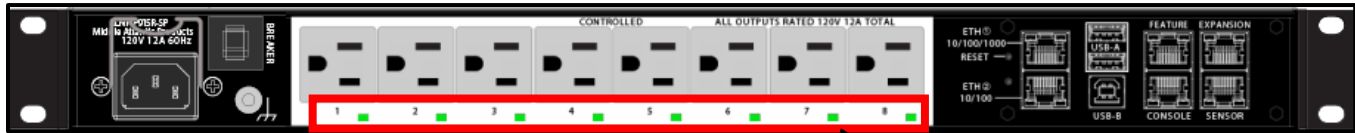

Outlet LEDs

### Compact PDU



Outlet LEDs



**NOTE** Images in this topic show outlet LED locations for all rackmount and compact models. Electrical ratings and outlet types vary based on model purchased. For data about your specific model, see [Specifications](#), on page 230.

The table below explains how to interpret different outlet LED states.

LED state	Outlet status	What it means
Not lit	Powered OFF	The outlet is not connected to power, or the control circuitry's power supply is broken.
Red	OFF	The outlet is turned off and power is available when the outlet is turned on.
Green	ON and LIVE	LIVE power. The outlet is on and power is available.
Green flashing	ON and LIVE	The current flowing through the outlet is greater than the upper warning (non-critical) threshold.
Cycling through Red, Green and Yellow	N/A	The PDU has just been plugged in and its management software is loading. LED color cycling does not interrupt power to outlets. It is an indication of firmware loading.



**NOTE** When a PDU powers up, it proceeds with the power-on self test and software loading for a few moments. At this time, the outlet LEDs cycle through different colors. When the software has completed loading, the outlet LEDs show a steady color and the front panel display illuminates.

## Front Panel (Rackmount PDUs Only)

The following diagram shows the front panel layout.

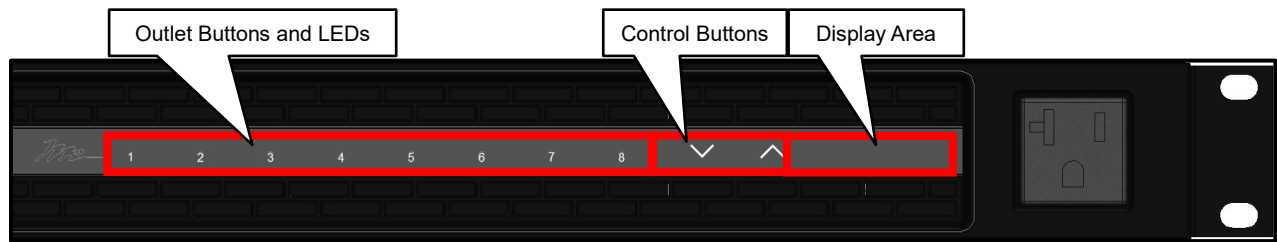

You can use the front panel to view PDU information and even switch an outlet. It consists of:

- (8x) outlet buttons
- (2x) control buttons
- A front panel display

### Viewing PDU Information on the Front Panel Display

The front panel display shows the MAIN MENU which includes the following measurements in the following order:

- INPUT VOLTAGE

Displays the input voltage measurement (example: 120.7 VOLTS)

- ALARMS

Displays the alarm amount or value (example: NO ALARMS or 2 ALARMS)

- TEMPERATURE

Displays the temperature sensor measurement (example: 78.3 F)

- ACTIVE POWER

Displays the active power measurement (example: 458.7 WATTS)

- CURRENT DRAW

Displays the current draw measurement (example: 3.8 AMPS)

### Viewing PDU Information on the Front Panel Display During Normal Operation

- During normal operation, the front panel display cycles through items 1-5 with a 2 second delay.

### Pressing Control Buttons

- Pressing a control button will step you through the titles. After no control button is pressed for 2 seconds, the display will resume the normal operation display cycle.

### Retrieving the IP Address and Other Information From the Front Panel:

- Press both control buttons and hold for 5 seconds.

- The front panel display shows the DEVICE MENU which includes the following measurements in this specific order:
  - a. IPv4 ADDR (ADDRESS)  
Displays the IPv4 address value (example: 192.168.1.200)
  - b. SURGE STATUS
    - On Series Surge Models:**
      - Displays the surges value (example: 2 SURGE)
    - On Protected Fault (MOV) Models:**
      - Displays the fault value (example: PROTECTED or FAULT)
  - c. FW (FIRMWARE) VERSION  
Displays the firmware version value (example: 3.3.0.5-0)
  - d. SERIAL NUM (NUMBER)  
Displays the serial number value (example: RLNK-P415-001048)
  - e. MAC ADDR (ADDRESS)  
Displays the MAC address value (example: 00:1E:C5:00:10:48)
    - After no control button is pressed for 2 seconds, the front panel display cycles through items a-e with a 2 second delay.
    - Press both control buttons and hold for 5 seconds and the MAIN MENU display titles appear.

## I/O Panel

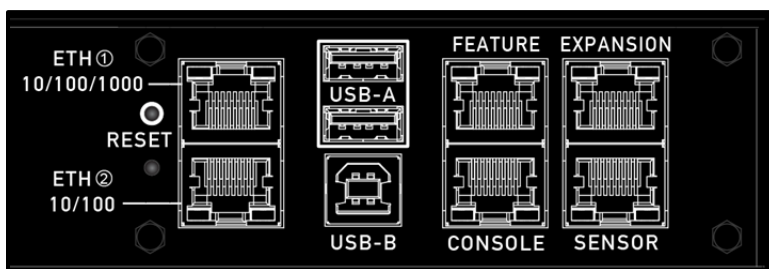

The I/O panel is the same on rackmount and compact PDUs and looks like the following image.



- Ethernet ports (1 and 2)
- Reset button
- (2x) USB-A port
- USB-B port
- Feature port
- Expansion port
- Console port
- Sensor port

### Connection Port and Reset Button Functions

The table below explains the function of each port and the reset button.

Port	Used for...
FEATURE	Reserved for Future Use
RESET	Reboots the PDU. For more information, see <a href="#">Reset Button</a> , on page 19.
ETH① 10/100/1000, ETH②10/100	<p>The PDU has two Ethernet ports.</p> <ul style="list-style-type: none"> <li>ETH①10/100/1000 supports up to 1000 Mbps. This is "ETH1".</li> <li>ETH②10/100 supports up to 100 Mbps. This is "ETH2".</li> </ul> <p>You can use either Ethernet port for your network connection.</p> <div style="border: 1px solid black; padding: 5px;"> <p> <b>NOTE</b> The yellow LED of the ETH②10/100 port has NO function so it will not be lit regardless of the communication status.</p> </div>
USB-A	<div style="border: 1px solid black; padding: 5px;"> <p> <b>NOTE</b> This is a "host" port, which is powered, per USB 2.0 specifications.</p> </div> <ul style="list-style-type: none"> <li>Connecting a USB device, such as a wireless LAN adapter.</li> </ul>
USB-B	<ul style="list-style-type: none"> <li>Establishing a USB connection between a computer and the PDU for using the command line interface or performing the disaster recovery. For disaster recovery instructions, contact Technical Support.</li> </ul>
SENSOR (RJ-45)	<ul style="list-style-type: none"> <li>Connection for environmental sensors.</li> <li>For more information, refer to the Premium+ PDU With RackLink Environmental Sensors User Manual <a href="http://www.legrandav.com">www.legrandav.com</a>.</li> </ul>
CONSOLE (RJ-45)	<p>Establishing a serial connection between the PDU and a computer.</p> <p>Use a third-party RJ-45 to DB9 adapter/cable to connect the PDU to your computer. For more information, see <a href="#">RJ45-to-DB9 Cable Requirements for Computer Connections</a> on page 254.</p>

## Reset Button

The reset button is located inside the small hole above the label on the PDU.

The PDU can be reset to its factory default values using this button when a serial connection is available. For more information, see [Resetting to Factory Defaults](#) on page 241.

Without the serial connection, pressing this reset button restarts the PDU's software without any loss of power to outlets.

The following image illustrates the location of the reset button.

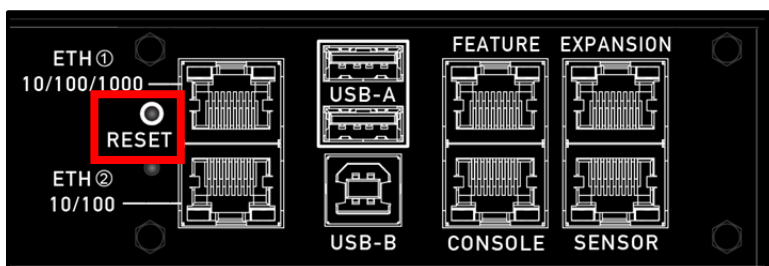

## Circuit Breakers

The circuit breakers automatically trip (disconnect power) when the current flowing through the circuit breaker exceeds its rating.

When a circuit breaker trips, power flow ceases to all outlets connected to it. You must manually reset the circuit breaker so that affected outlets can resume normal operation.

### Resetting the Circuit Breaker

- Locate the breaker on the unit as shown.

#### Rackmount PDU



#### Compact PDU

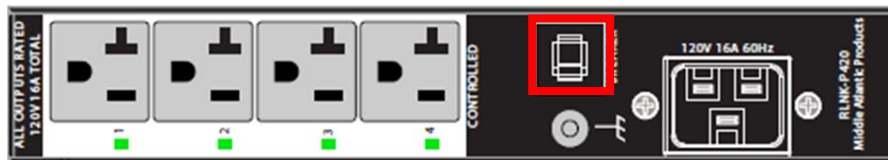

#### NOTE

Images in this topic show circuit breaker locations for all rackmount and compact models. Electrical ratings and outlet types vary based on model purchased. For data about your specific model, see [Specifications](#), on page 230.

- If the breaker is tripped, the button resembles the following image:



- Examine your PDU and the connected equipment to remove or resolve the cause that results in the overload or short circuit. **This step is required, or you cannot proceed with the next step.**
- Press the switch to reset the breaker. When the breaker is reset, the button resembles the following image:



# Connecting Your PDU

This chapter explains how to connect your PDU.

## Connecting the PDU to a Power Source

- Connect the power cable to an appropriately rated branch circuit.
- **Rackmount PDUs Only:** Press the power button on the front left (facing) of your PDU.
- When your PDU powers up, it proceeds with the power-on self-test and software loading for a few moments. At this time, the outlet LEDs cycle through different colors.



### NOTE

All devices have overcurrent protection mechanisms. Connect each device to an appropriately rated branch circuit. See the markings on your PDU for appropriate input ratings or range of ratings.

- When the software has completed loading, the outlet LEDs show a steady color and the front panel display illuminates. The factory default state powers on all of the outlets.

## Connecting the PDU to Your Network

Your PDU must be connected to your local area network (LAN) for remote administration. It may be connected via wired or wireless network.

The Ethernet port must be enabled for this connection to work properly. Per default, the Ethernet port is enabled. For more information, see [Configuring Wired Network Settings](#) on page 87.

### **Connecting the PDU to Your Network Using Wired Ethernet**

- Connect a standard Cat5e cable (or better, not provided) to the ETHERNET port on your PDU.
- Connect the other end of the cable to your network.
- The following image shows the ETHERNET port.

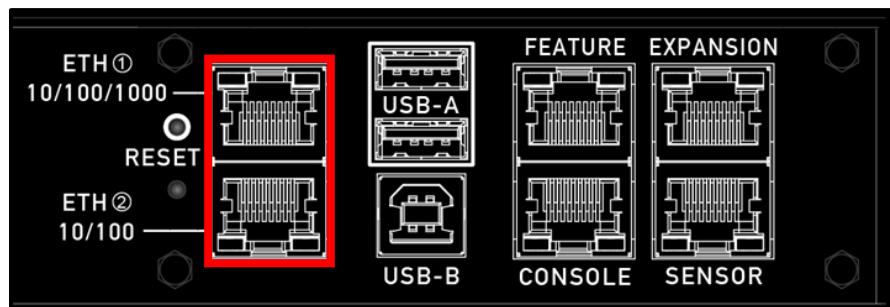

### CAUTION

Accidentally plugging an RS-232 RJ-45 connector into the ETHERNET port can cause permanent damages to the Ethernet hardware.

**ATTENTION**

Le branchement accidentel d'un connecteur RJ-45 RS-232 dans le port ETHERNET peut causer des dommages permanents au matériel Ethernet.

## ***Making a Wireless Connection Using The USB WIFI Dongle***

Do one of the following:

- Connect the USB WIFI Dongle to the PDU (the USB WIFI Dongle is available as an accessory).
- Connect a USB hub to the USB-A port on the PDU. Then, plug the USB WIFI Dongle into the appropriate USB port on the hub.



**NOTE** The PDU supports the A/B/G/N 802.11 protocols.

## ***Supported Wireless LAN Configuration***

If wireless networking is preferred, ensure that the wireless LAN configuration of your PDU matches the access point. Use the following LAN configurations:

- Network type: 802.11 A/B/G/N
- Protocol: WPA2 (RSN)
- Key management: WPA-PSK, or WPA-EAP with PEAP and MSCHAPv2 authentication
- Encryption: CCMP (AES)

**CAUTION****ATTENTION**

Supported 802.11 network protocols vary according to the wireless LAN adapter being used with the PDU. For more information, refer to USB Wireless LAN Adapters in the Advanced User Manual at [www.legrandav.com](http://www.legrandav.com).

Les protocoles réseau 802.11 pris en charge varient en fonction de l'adaptateur LAN sans fil utilisé avec la PDU. Pour plus d'informations, reportez-vous aux adaptateurs LAN sans fil USB dans le manuel d'utilisation avancé à [www.legrandav.com](http://www.legrandav.com).

# Using the Web Interface

This chapter explains how to use the web interface to administer your PDU.

## Supported Web Browsers

- Internet Explorer® 11
- Microsoft Edge®
- Firefox® 25 and later
- Safari® (Mac)
- Google® Chrome® 52 and later
- Android™ 4.2 and later
- iOS® 7.0 and later



### NOTE

Depending on the browser you use, spin controls similar to  may or may not appear in the numeric input fields.

## Accessing the Web Interface



### NOTE

Before accessing the web interface, your PDU must be properly connected to your network. For more information, see [Connecting the PDU to Your Network](#), on page 21.

- Use a network cable (Cat 5 or better, not provided) to connect the network port on the card to the network at your location. Make sure your computer is connected to the same LAN as your device.
- Open the RackLink Discovery Tool and click the **Discover** button to locate RackLink devices on your network.

Download the Discovery Tool self-extracting executable onto your computer from the Power Downloads page at <https://www.legrandav.com/resources/power-downloads>.



### NOTE

- You may need to contact your administrator to run a self-extracting executable on your computer.
- You may need to disable your Windows firewall to discover your device.
- If you have previously changed the host name or IP address of your network card, access the interface using your new settings.
- Chrome is used as the web browser for the example shown in this topic. The procedures and images are similar if you use a different browser.

The Discovery Tool opens a web browser and accesses your device IP address (192.168.1.200, unless you changed the IP, host name, or port). For more information, see [Downloading and Using the RackLink Device Discovery Tool](#), on page 247.

If the link-local addressing has been enabled, you can type *pdu.local* instead of the IP address. Refer to APIPA and Link-Local Addressing in the Premium+ PDU With RackLink Advanced User Manual at [www.legrandav.com](http://www.legrandav.com).

**TIP**

You can also enter the desired page's URL so that you can immediately go to that page after login. For more information, see [Quick Access to a Specific Page](#), on page 29.

- Click **Advanced** and then **Proceed** to bypass the security certificate warning (since locally issued certificates are used at this point).

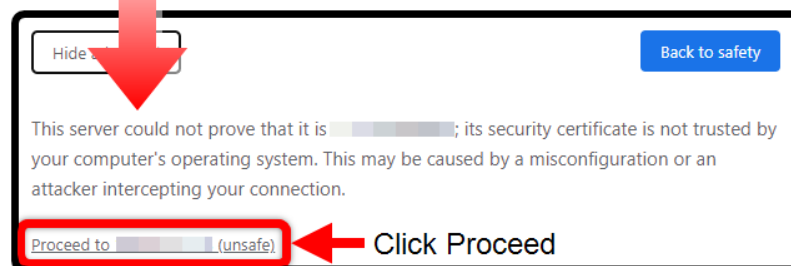
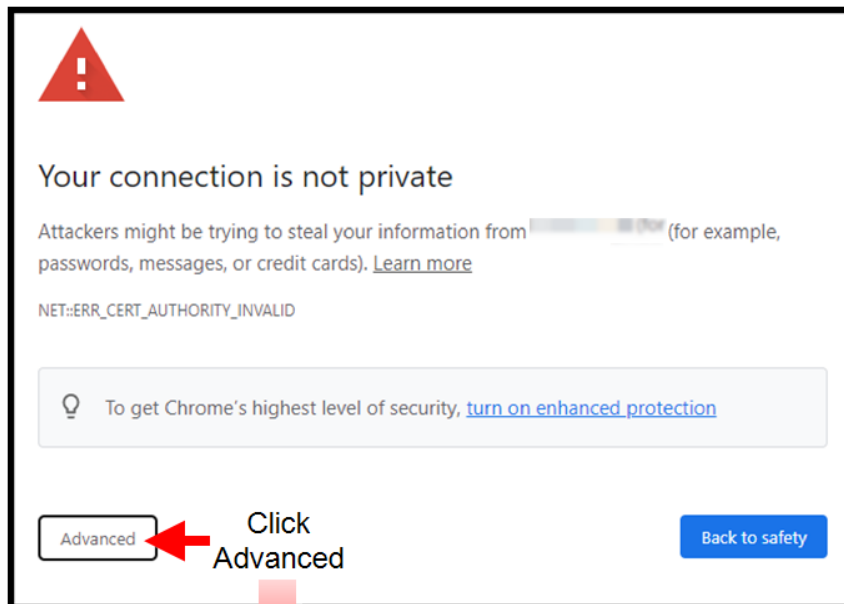

- The web interface login appears and prompts you for credentials.

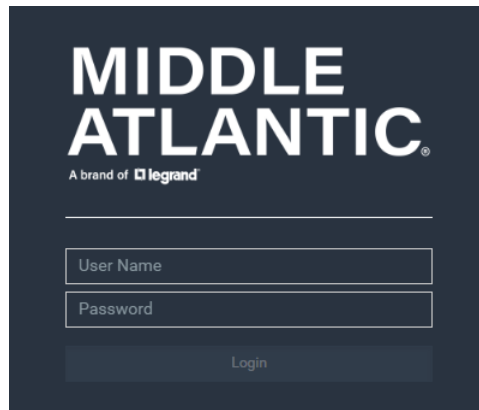

- Log into the web interface with username: **admin** and password: **admin** default credentials.
- The default names and passwords for the Administrator, User, and Control Systems accounts, respectively, on your RackLink device are as follows:

Administrator Account	User Account	Control System Account
Username: <b>admin</b> Password: <b>admin</b>	Username: <b>user</b> Password: <b>user</b>	Username: <b>user</b> Password: <b>password</b>

- After logging in for the first time, the system forces you to change the default passwords for the administrator, user, and control system accounts for security purposes.



**NOTE**

- Log in for the first time using the administrator account in order to change the passwords for all of the accounts.
- External devices access your RackLink's serial API through the Control System account. This account is not used to access the web interface.
- You may configure the security agreement, if desired. For more information, see [Enabling the Restricted Service Agreement](#), on page 119.
- The user account is not active until it is set up by the administrator.

- Enter the credentials for the account you wish to use.
- Click **Login**.

The Dashboard appears.

## Remembering User Names and Passwords

Common web browser password managers are supported, including:

- Microsoft Internet Explorer®
- Mozilla Firefox®
- Google Chrome®

You can save the login name and password when these browsers ask to remember them.

For information on how to activate a web browser's password manager, see the user documentation accompanying your browser.

The PDU does NOT support other browser password managers.

## **Logout**

After finishing your tasks, you should log out to prevent others from accessing the web interface.

### **Logging Out Without Closing the Web Browser**

- Click "Logout" on the top-right corner.  
*OR*
- Close the tab while there are other tabs available in the browser.



### **Logging Out By Closing the Web Browser**

- Click  on the top-right corner of the window.  
*OR*
- Choose File > Close, or File > Exit.

## **Web Interface Overview**

The web interface consists of four areas as shown on the following screen.

Lettered callouts on user interface images correspond with procedural steps and explanations further below.

- Click any menu or submenu item in the area of .
- That item's data/setup page is then opened in the area of .
- Now you can view or configure settings on the opened page.

- Return to the main menu and the Dashboard page by clicking  on the top-left corner.

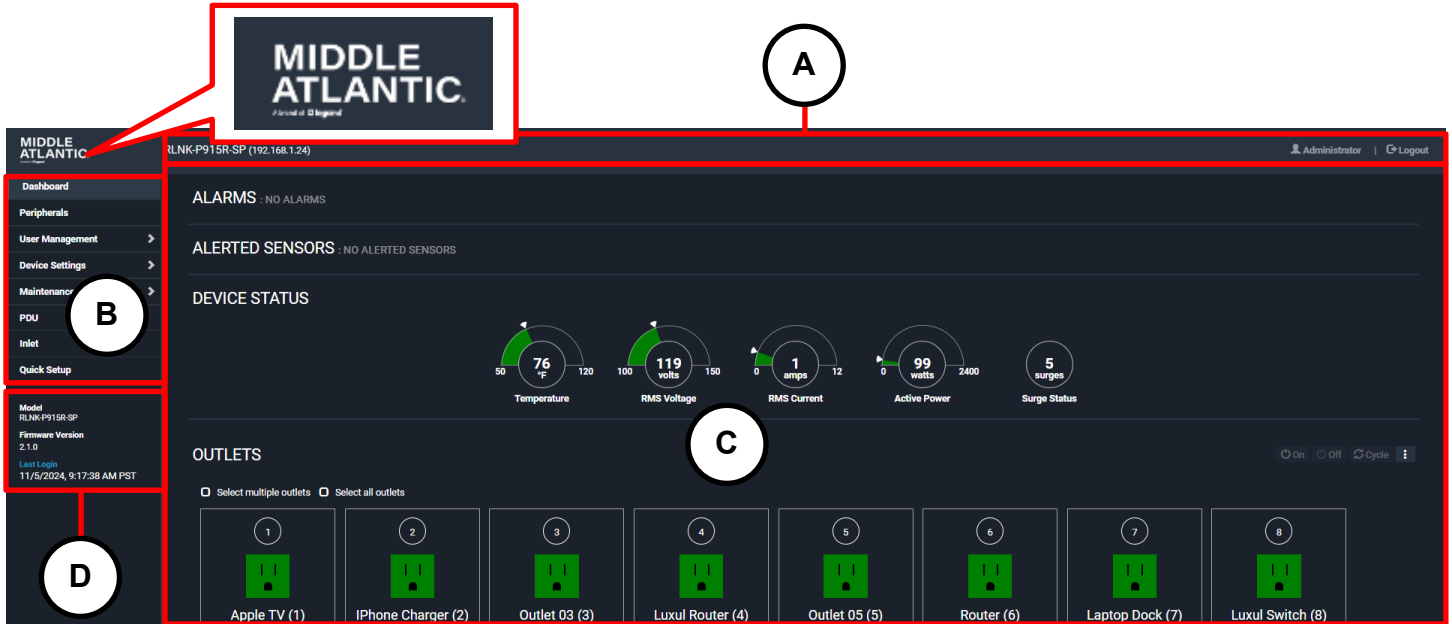

Letter	Web interface element
<b>(A)</b>	<ul style="list-style-type: none"> <li>• Left side:                             <ul style="list-style-type: none"> <li>▪ PDU name For information about customizing your device name, see <a href="#">PDU</a>, on page 215.</li> </ul> </li> <li>• Right side:                             <ul style="list-style-type: none"> <li>▪ Your login name, which you can click to view your user account settings</li> <li>▪ Logout button</li> </ul> </li> </ul>
<b>(B)</b>	The Menu. For more information, see <a href="#">Menu</a> , on page 28.
<b>(C)</b>	Content area of the screen.
<b>(D)</b>	From top to bottom: <ul style="list-style-type: none"> <li>• Your PDU model</li> <li>• Current firmware version</li> <li>• Date and time of your user account's last login                             <ul style="list-style-type: none"> <li>▪ Click <b>Last Login</b> to view your login history.</li> </ul> </li> </ul>

## Menu

Depending on your model and hardware configuration, your PDU may show all or some menu items shown below.

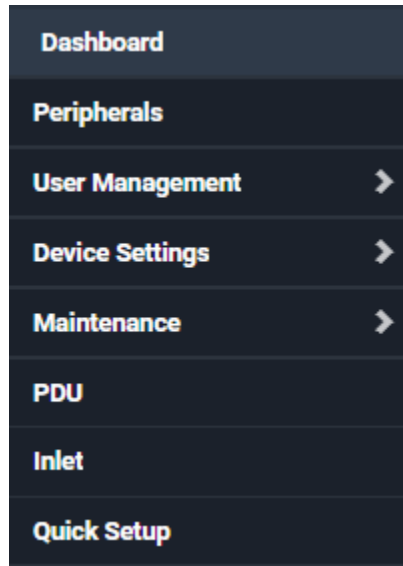

If a menu item contains the submenu, the submenu is shown after clicking that item.

### Returning to Previous Menu Listings

Any of the following ways return you to previous menu listings:

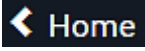
- Click the topmost link with the symbol >. For example, click .
- Press Backspace on the keyboard.

**OR**

- Click  on the top-left corner to return to the main menu.

## Quick Access to a Specific Page

If you often visit a specific page in the web interface, you can note its URL or bookmark it with your web browser. Next time, you can simply enter its URL in the address bar of the browser prior to login. After login, the PDU immediately shows the desired page rather than the Dashboard page.





If needed, you can even send the URL to other users so that they can immediately see that page after login, using their own user credentials.

In the following examples, it is assumed that the IP address of the PDU is 192.168.84.118.

Page	URL
Peripherals	<a href="https://192.168.84.118/#/peripherals">https://192.168.84.118/#/peripherals</a>
Event Log	<a href="https://192.168.84.118/#/maintenance/eventLog/0">https://192.168.84.118/#/maintenance/eventLog/0</a>

## Sorting a List

If any list displays this arrow  in one of its column headers, you are allowed to sort the list by clicking any column header. The list will be sorted in the ascending or descending order based on the selected column.

- By default, the Peripheral Devices list is sorted in the ascending order based on the # column. Therefore, the arrow  is displayed adjacent to the # header.
- Sort the list in descending order based on the same column by clicking the # header.
- The arrow turns to , indicating the list is sorted in the "descending" order. 
- Sort the list based on a different column by clicking a different column header.
- The arrow  now appears adjacent to the selected column header, indicating the list is sorted in the ascending order based on that column.

# Dashboard

Lettered callouts on user interface images correspond with explanations further below.

The Dashboard page contains four sections. However, the Alarms and Alerted Sensors sections only appear when applicable.

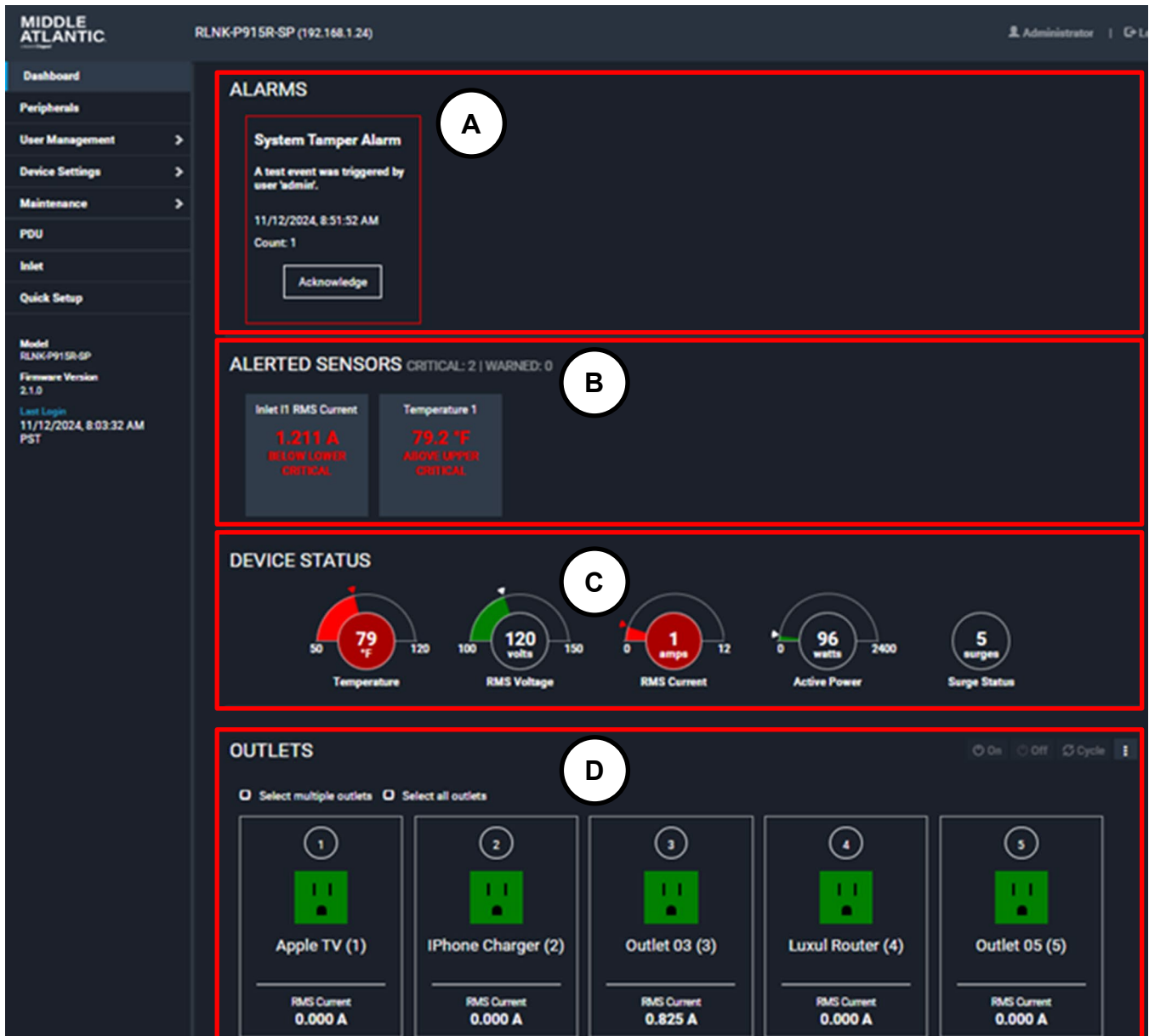

Letter	Section	Information shown
Ⓐ	<b>Alarms</b>	<ul style="list-style-type: none"> <li>This section can show data only after you have set event rules requiring users to take the acknowledgment action.</li> <li>When there are no unacknowledged events, this section shows the message "No Alarms."</li> <li>When there are unacknowledged events, this section lists all of them. See <a href="#">Alarms</a>, on page 31.</li> <li>Current hardware failures, if any, also appear on this part of the dashboard. For more information, see <a href="#">Viewing Hardware Failures</a>, on page 212.</li> </ul>
Ⓑ	<b>Alerted Sensors</b>	<ul style="list-style-type: none"> <li>When no sensors enter the alarmed state, this section shows the message "No Alerted Sensors."</li> <li>When any sensor enters the alarmed state, this section lists all of them. See <a href="#">Alerted Sensors</a>, on page 32.</li> </ul>
Ⓒ	<b>Device Status</b>	<ul style="list-style-type: none"> <li>Overview of inlet power data See <a href="#">Inlet Device Status</a>, on page 33.</li> </ul>
Ⓓ	<b>Outlets</b>	<ul style="list-style-type: none"> <li>Displays outlets of your PDU for management and control. See <a href="#">Outlets</a>, on page 34.</li> </ul>

## Alarms

If configuring any event rules which require users to take the acknowledgment action, the Alarms section will list any event which no one acknowledges yet since event occurrence.

For information on event rules, see [Event Rules and Actions](#), on page 120.

Only users with the Acknowledge Alarms permission can manually acknowledge an alarm.

### Acknowledging An Alarm

- Click Acknowledge, and that alarm then disappears from the Alarms section.

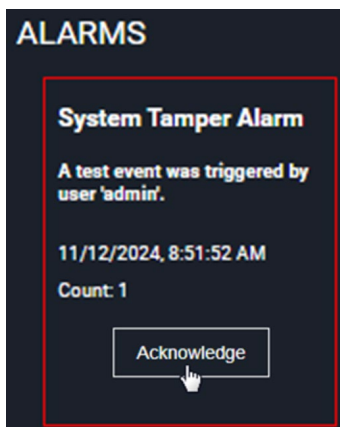

This table explains the display fields shown with an alarm.

Field	Description
Name	The customized name of the Alarm action.
Reason	The first event that triggers the alert.
First Appearance	The date and time when the event indicated in the Reason column occurred for the first time.
Last Appearance	The date and time when the event indicated in the Reason column occurred for the last time.
Count	The number of times the event indicated in the Reason column has occurred.
More Alerts	<div style="border: 1px solid black; padding: 5px;">  <b>NOTE</b> This field appears only when there are more than one type of event triggering this alert.         </div> <p>If there are other types of events (that is, other reasons) triggering the same alert, the total number of additional reasons is displayed. You can click it to view a list of all events triggering this alert.</p>

## Alerted Sensors

When any internal sensors or environmental sensor packages connected to the PDU enter an abnormal state, the Altered Sensors section in the Dashboard show them for alerting users.

You can click each sensor's tile to access individual sensor pages and view detailed information or configure each alerted sensor. For more information, see [Individual Sensor/Dry Contact Pages](#), on page 74.

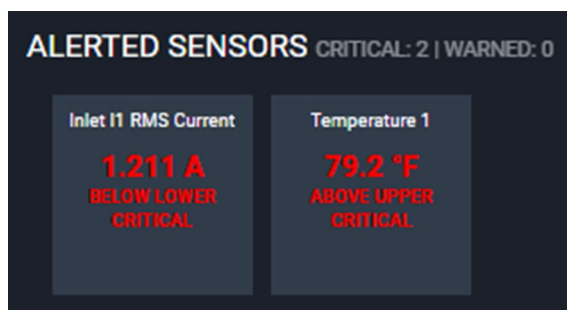

Summary in the section title:

Information in parentheses adjacent to the title is the total number of alerted sensors.

For example:

- **1 Critical:** 1 sensor enters the critical or alarmed state.

Numeric sensors enter the critical state.

State sensors enter the alarmed state.

- **1 Warned:** 1 'numeric' sensor enters the warning state.

For more information, see [Sensor/Dry Contact States](#) on page 72.

## Inlet Device Status

The Device Status section of the screen shows the following PDU readings:

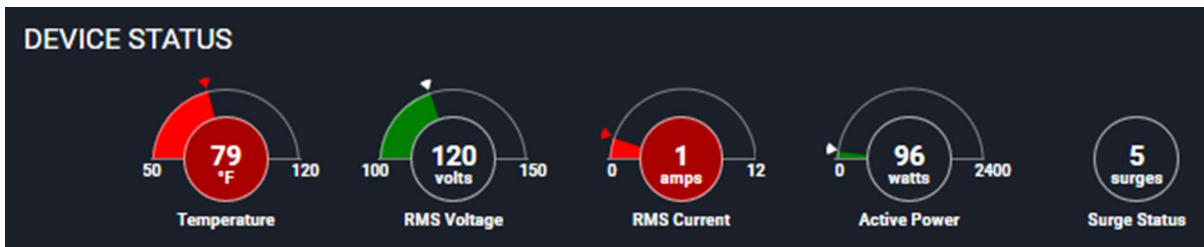

- RMS Voltage
- RMS Current
- Active Power

For more information about these readings, see [Outlet Configuration Page](#), on page 52.

### Gauge Overview

Lettered callouts on user interface images correspond with explanations further below.

The current sensor’s reading value is displayed on clockwise color indicators

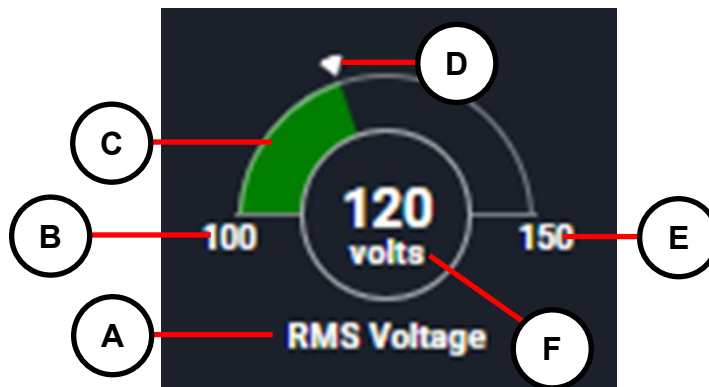

Letter	Description
(A)	Gauge title
(B)	Minimum displayable gauge value.
(C)	Gauge reading with threshold color indication. For assigning threshold values and gauge color indicators, see <a href="#">Sensor Threshold Settings</a> , on page 60.
(D)	The current reading indicator.
(E)	Maximum displayable gauge value.
(F)	The current reading value and unit of measure.

## Outlets



The Outlets page shows a list of all outlets and the overview of outlet status and readings on your PDU. Open this page by clicking Dashboard in the Menu. For more information, see [Menu](#) on page 28.

### Outlets Overview

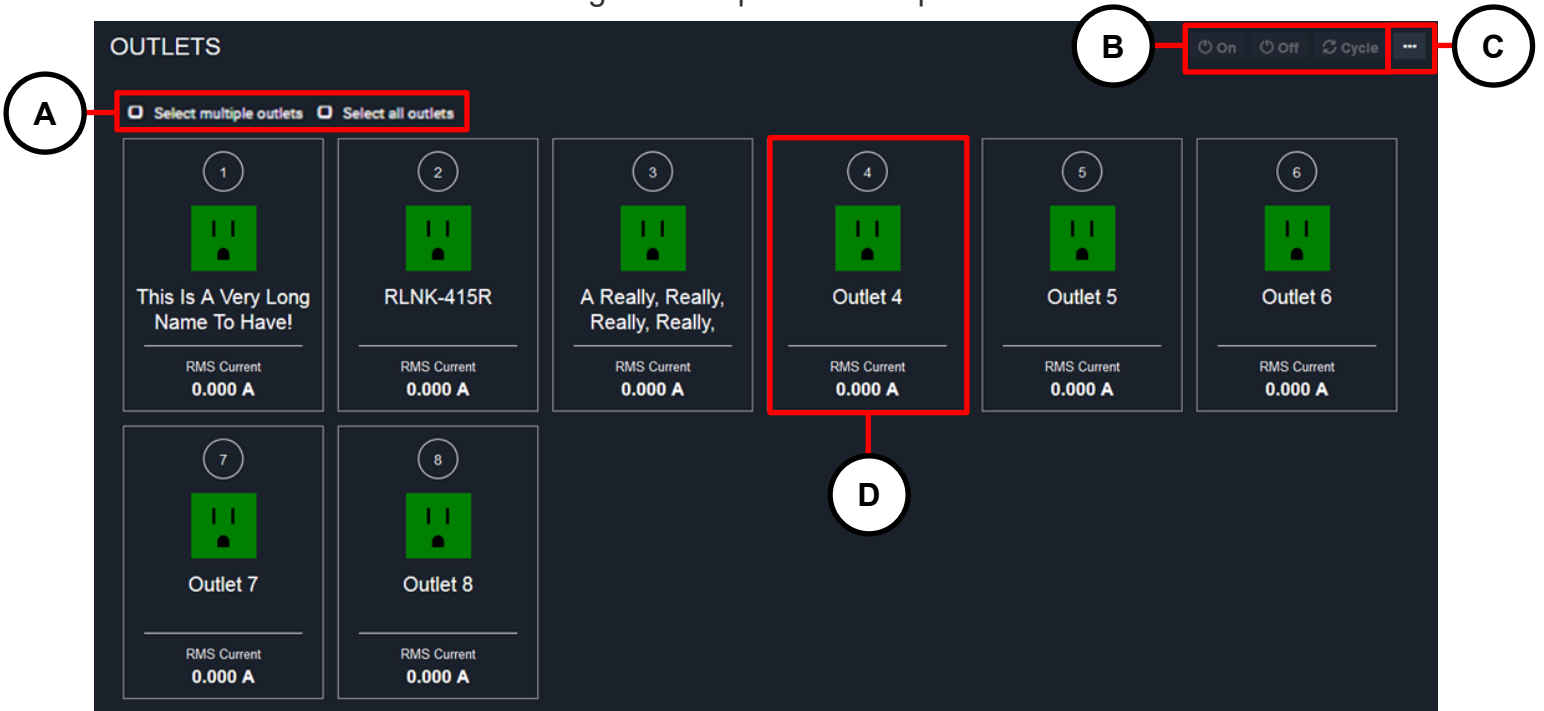
Lettered callouts on user interface images correspond with explanations further below.



Letter	Description
<b>A</b>	Select Multiple and All Outlets checkboxes. For more information, see <a href="#">Selecting Multiple Outlets</a> , on page 51 and <a href="#">Selecting All Outlets</a> , on page 51, respectively.
<b>B</b>	Outlet buttons perform the following functions: <ul style="list-style-type: none"> <li>• Power On.</li> <li>• Power Off.</li> <li>• Power Cycle. Power cycling the outlet(s) turns the outlet(s) off and then back on.</li> </ul>
	<div style="border: 1px solid black; padding: 5px;">  <b>NOTE</b> These buttons are only enabled when one or more outlets are selected                     </div>

Letter	Description
<p><b>C</b></p>	<p>Click the ellipsis  to access the following additional outlet functions:</p> <ul style="list-style-type: none"> <li>• <b>Reset Active Energy:</b> Resets active energy readings of selected outlets.</li> </ul> <div data-bbox="266 369 1511 478" style="border: 1px solid black; padding: 5px;"> <p> <b>NOTE</b> Only users with the "Admin" role assigned can reset active energy readings.</p> </div> <ul style="list-style-type: none"> <li>• <b>Threshold Bulk Setup:</b> Configures thresholds for all outlets. For more information, see <a href="#">Threshold Bulk Setup</a>, on page 35.</li> <li>• <b>Sequence Setup:</b> Configures outlet power-on sequence order and delay for all outlets. For more information, see <a href="#">Setting Up Sequences</a>, on page 36.</li> <li>• <b>Load Shedding Setup:</b> Configures load shedding capabilities for all outlets. For more information, see <a href="#">Setting Up Load Shedding</a>, on page 38.</li> <li>• <b>Activate Load Shedding:</b> Activates and deactivates your configured load shedding settings for all outlets. For more information, see <a href="#">Load Shedding Mode</a>, on page 37.</li> <li>• <b>Outlet Groups:</b> Allows you to create named collections of your outlets (outlet groups). You can then perform actions on and analyze usage of the groupings. For more information, see <a href="#">Using Outlet Groups</a>, on page 39.</li> </ul> <p>Confirm the operation when prompted.</p>
<p><b>D</b></p>	<p>An outlet. For more information, see <a href="#">Outlet Controls</a>, on page 50.</p>

## Global Outlet Settings

### Threshold Bulk Setup

Outlet thresholds, if enabled, help you identify whether any outlet enters the warning or critical level. For more information, see [Yellow- or Red-Highlighted Sensors](#), on page 71. In addition, you can have the PDU automatically generate alert notifications for any warning or critical status. For more information, see [Event Rules and Actions](#), on page 120.

You can configure the thresholds for multiple or all outlets simultaneously on the Outlets page.

#### Configuring Threshold Settings for Multiple Outlets

- Click the ellipsis  and select Threshold Bulk Setup.
- In the "Show Outlet Sensors of Type" field, select a sensor type.
- Use the checkboxes to select one or multiple outlets.
- Select the topmost checkbox in the header row to select ALL outlets.
  - Click Edit Thresholds.
  - Make changes as needed.
- Select the corresponding checkbox to enable any threshold.
- Type a new value in the accompanying text box.

For concepts of thresholds, deassertion hysteresis and assertion timeout, see [Sensor Threshold Settings](#), on page 60.

- Click **Save**.





### Setting Up Sequences

By default, outlets are sequentially powered on in the ascending order from outlet 1 to the final when turning ON or power cycling all outlets on the PDU. You can change the order in which the outlets power ON. This is useful when there is a specific order in which equipment should be powered up first.

In addition, you can make a delay occur between two outlets that are turned on consecutively. For example, if the power-on sequence is Outlet 1 through Outlet 8, and you want the PDU to wait for 5 seconds after turning on Outlet 3 before turning on Outlet 4, assign a delay of 5 seconds to Outlet 3.

#### Setting Outlet Power-On Sequence

- Click the ellipsis  and select Sequence Setup.
- Select one or multiple outlets by clicking them one by one in the 'Outlet' column.
- Click the arrow buttons to change the outlet positions.

Button	Function
	Top
	Up
	Down
	Bottom
	Restores to the default sequence

**NOTE**

- The next time the PDU power cycles, it will turn on all outlets based on the new outlet order.
- The new order also applies when performing the power-on or power-cycling operation on partial outlets.
- As indicated by the on-screen note, the order applies to “up” or power-on sequences and is mirrored (along with any set delays) for “down” or power-off sequences.

**OUTLETS SEQUENCE**

Outlet Sequence: 1-8

Outlet	Delay
EVERYTHING BUT AMPS (1)	1 s
Second Outlet (2)	2 s
Outlet 3	3 s
Outlet 4	1 s
Outlet 5	1 s
Outlet 6	1 s
Outlet 7	1 s
Outlet 8	1 s

The sequence setup applies to up sequences (switching multiple outlets on). Note, that for down sequences the order and delays will be mirrored.

✕ Cancel   ✓ Save

**Setting Power-On Delays**

- Click the ellipsis  and select Sequence Setup.
- Click the 'Delay' column of the outlet that requires a wait after it is turned on.
- Type a new value in seconds.
- Click **Save**.

The PDU inserts a power-on delay between the configured outlet and the one following it during the power-on process.

**Load Shedding Mode**

When a UPS supplying power to the PDU switches into battery backup operation, it may be desirable to switch off non-critical outlets to conserve UPS battery life. This feature is known as load shedding.

Outlets that are turned off when load shedding is activated are called non-critical. Outlets that are not affected by load shedding are called critical outlets. By default, all outlets are critical. For more information about setting non-critical outlets, see [Setting Up Load Shedding](#), on page 38.

When load shedding is activated, the PDU turns off all non-critical outlets. When load shedding is deactivated, the PDU turns back on all non-critical outlets that were ON before entering the load shedding mode.

Activation of load shedding can be accomplished using the web interface, SNMP or CLI, or triggered by the contact closure sensors.

**NOTE**

It is highly suggested to check the non-critical outlets prior to manually entering the load shedding mode. The non-critical information can be retrieved from the Outlets page. For more information, see [Setting Up Load Shedding](#), on page 38.

**Setting Up Load Shedding**

Outlets that are turned off when load shedding is activated are called non-critical. Outlets that are not affected by load shedding are called critical outlets. For more information, see [Setting Up Load Shedding](#), on page 38.

Per default, all outlets are configured as critical.

**Determining Critical and Non-Critical Outlets**

- Click the ellipsis  and select Load Shedding Setup.

The Load Shedding Setup screen appears.

- Use the checkboxes to select Non-critical outlets as desired.

Non Critical	Outlets ▲
<input checked="" type="checkbox"/>	Outlet 1
<input type="checkbox"/>	Outlet 2
<input checked="" type="checkbox"/>	Outlet 3
<input type="checkbox"/>	Outlet 4
<input type="checkbox"/>	Outlet 5
<input type="checkbox"/>	Outlet 6
<input type="checkbox"/>	Outlet 7
<input type="checkbox"/>	Outlet 8

- Click **Save**.

**TIP**

- Select the Non Critical checkbox in the header row to select ALL outlets.
- You can also set up non-critical outlet setting by configuring outlets one by one. For more information, see [Viewing Sensors](#) on page 56.

**Activating Load Shedding Mode**

- Click the ellipsis  and select Activate Load Shedding.
- Click Activate on the confirmation message.

In the load shedding mode:

- The lock icon  appears for all non-critical outlets on the Outlets page.
- On, Off, and Cycle options are disabled for non-critical outlets when load shedding mode is activated.

- The message "LOAD SHEDDING ACTIVE" appears next to the 'Outlets' title.

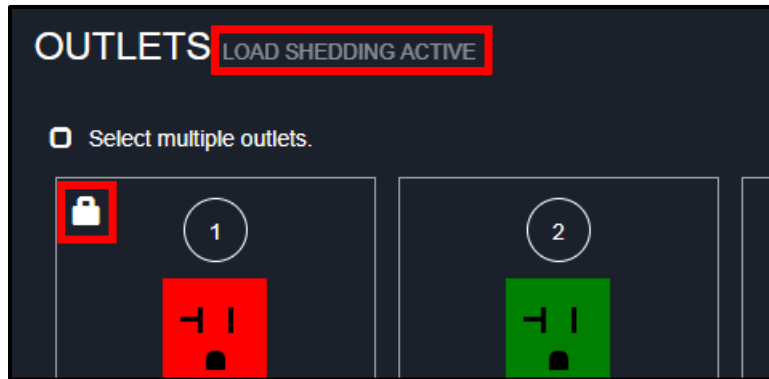

### Deactivating Load Shedding Mode

- Click the ellipsis  and select Deactivate Load Shedding.
- Click Deactivate on the confirmation message.

Now you can turn on/off any outlets.

### Using Outlet Groups

You can create named collections of outlets (outlet groups) and then perform actions and track usage on them as explained in the remainder of this section.

#### Creating an Outlet Group

- Click the ellipsis  and select Outlet Groups.

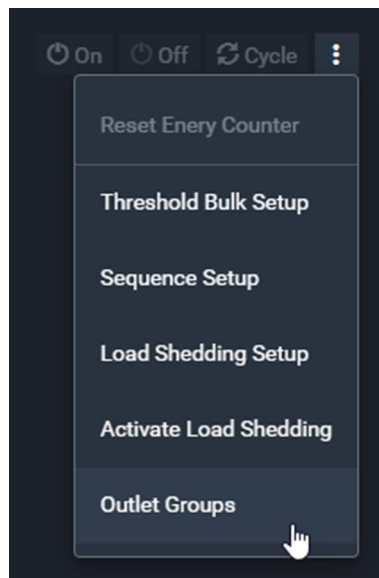

If no outlet groups have been created, the New Outlet Group page appears.

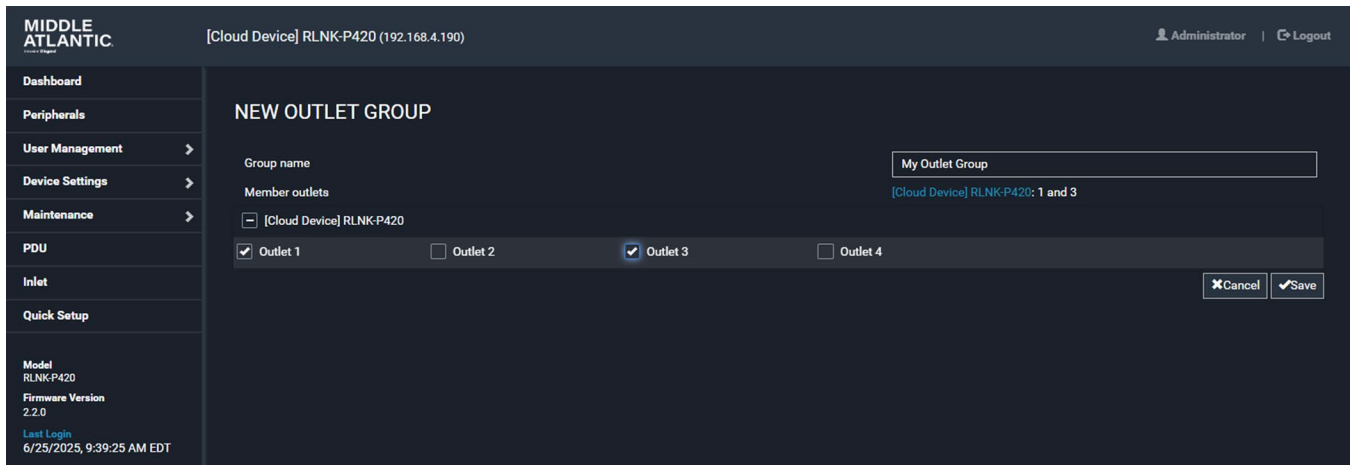

- Use the check boxes to select the outlets you want as part of your group.
- Use the Group name text box to enter a name for your outlet group.
- Click **Save**.

The Outlet Groups page appears and lists all created outlet groups in one place.

 **NOTE** With outlet groups created, this page appears instead of the New Outlet Group page when Outlet Groups is selected from the Dashboard.

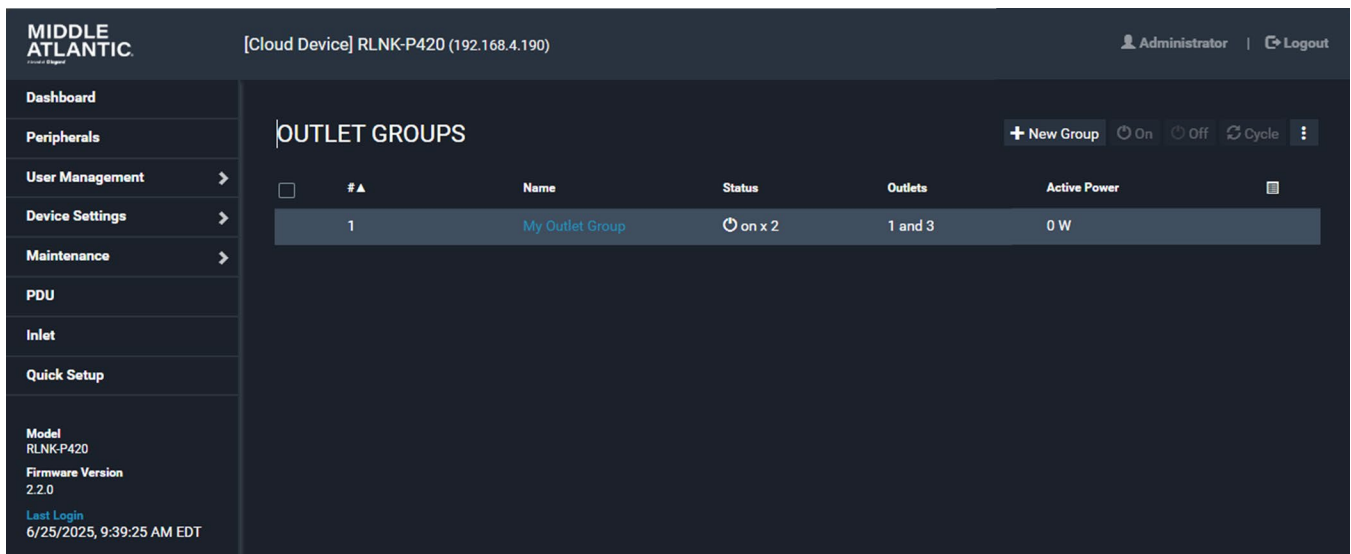

- Use the **New Group** button on this page to create any additional outlet groups.

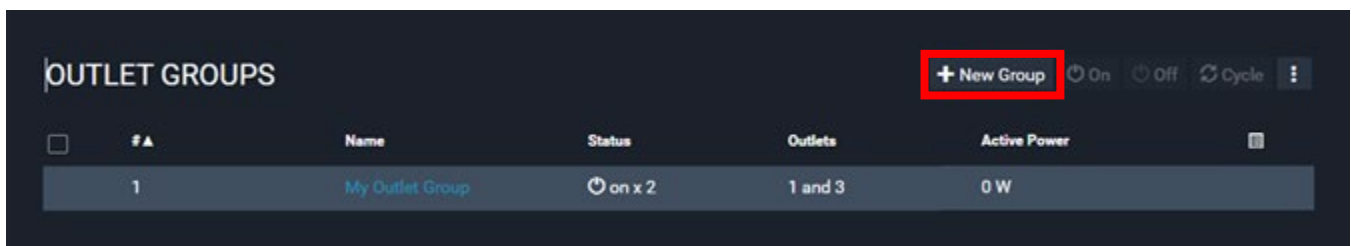

### Editing an Outlet Group

- Click the ellipsis  and select Outlet Groups.

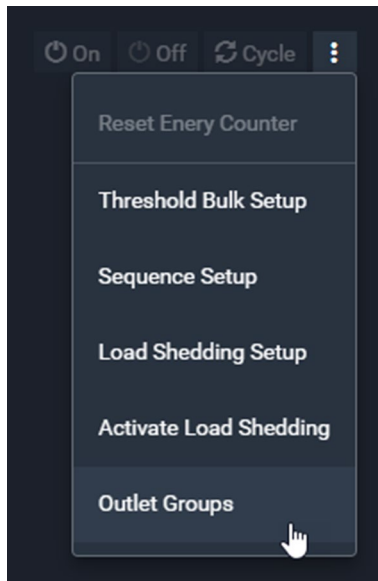

The Outlet Groups page appears.

A screenshot of the 'OUTLET GROUPS' page in the web interface. The page has a dark theme. At the top left is the 'MIDDLE ATLANTIC' logo. To its right is the device information: '[Cloud Device] RLNK-P420 (192.168.4.190)'. On the top right, it shows the user 'Administrator' and a 'Logout' button. A left sidebar contains navigation links: 'Dashboard', 'Peripherals', 'User Management', 'Device Settings', 'Maintenance', 'PDU', 'Inlet', and 'Quick Setup'. Below these is a section for device details: 'Model: RLNK-P420', 'Firmware Version: 2.2.0', and 'Last Login: 6/25/2025, 9:39:25 AM EDT'. The main content area is titled 'OUTLET GROUPS' and includes a '+ New Group' button and control buttons for 'On', 'Off', and 'Cycle'. Below this is a table with one row of data:

<input type="checkbox"/>	#▲	Name	Status	Outlets	Active Power	<input type="checkbox"/>
	1	My Outlet Group	on x 2	1 and 3	0 W	

- Click the name of the outlet group you wish to edit or delete.

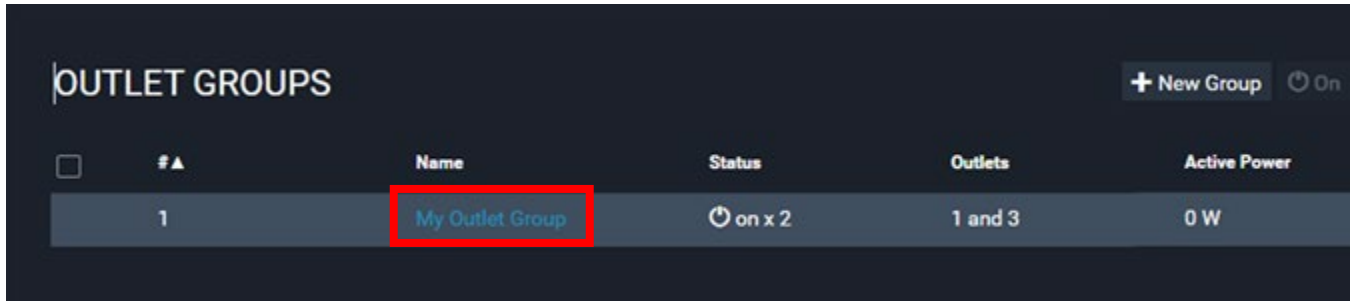

**NOTE** With outlet groups created, this page appears instead of the New Outlet Group page when Outlet Groups is selected from the Dashboard.

The Outlet Group Details page appears.

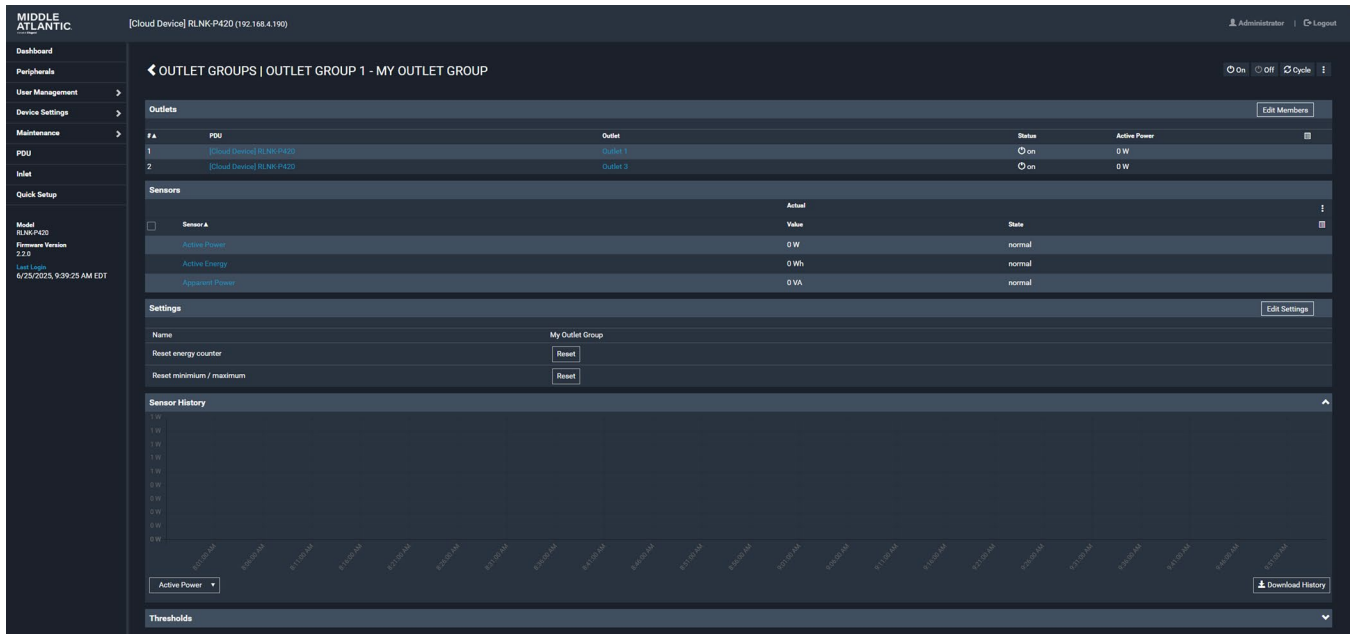

- Click the **Edit Members** button.

The Member Outlets section of the page shows the outlet check boxes.

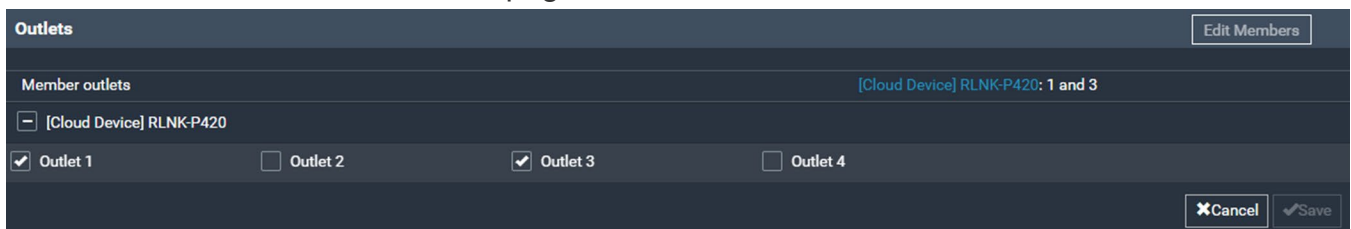

- Make changes as desired and click **Save**.

### Controlling and Deleting an Outlet Group

- Click the ellipsis  and select Outlet Groups.

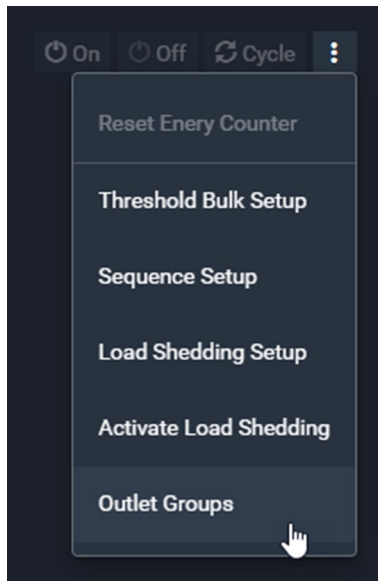

The Outlet Groups page appears.



- Click the name of the outlet group you wish to edit or delete.

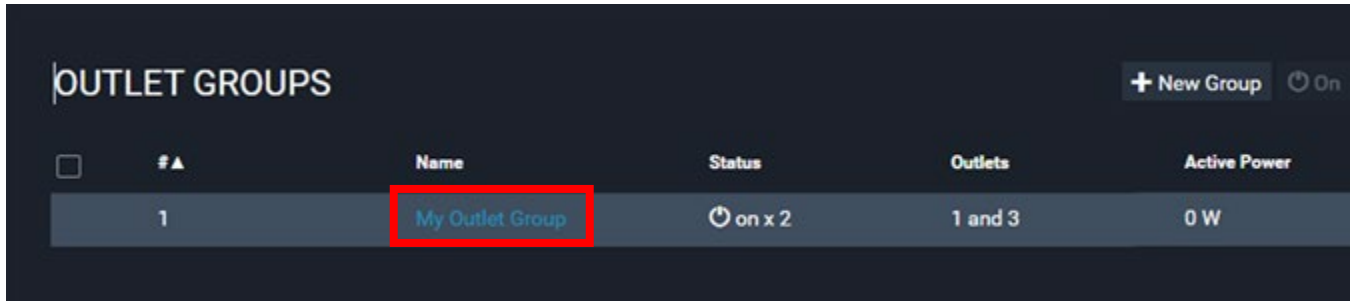

Alternatively, you can click anywhere on the outlet group row (other than the name) to select one or multiple groups from the list on the Outlet Groups page.

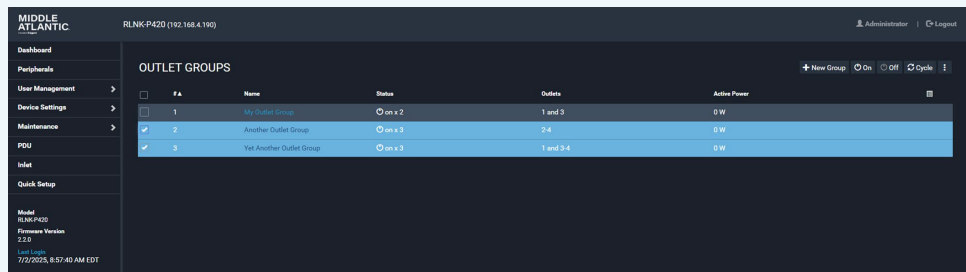

After selecting your desired one or more outlets, use the controls on the upper-right of the screen to create a New Group, turn your outlet group ON or OFF, Cycle the power (turn one or more outlets off and then back on again), Reset the Energy Counter, Reset the Minimum / Maximum, or Delete one or more groups.



**NOTE**

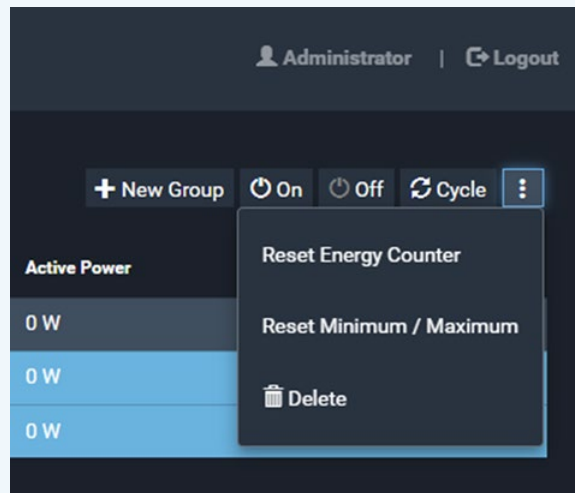

The Outlet Group Details page appears.

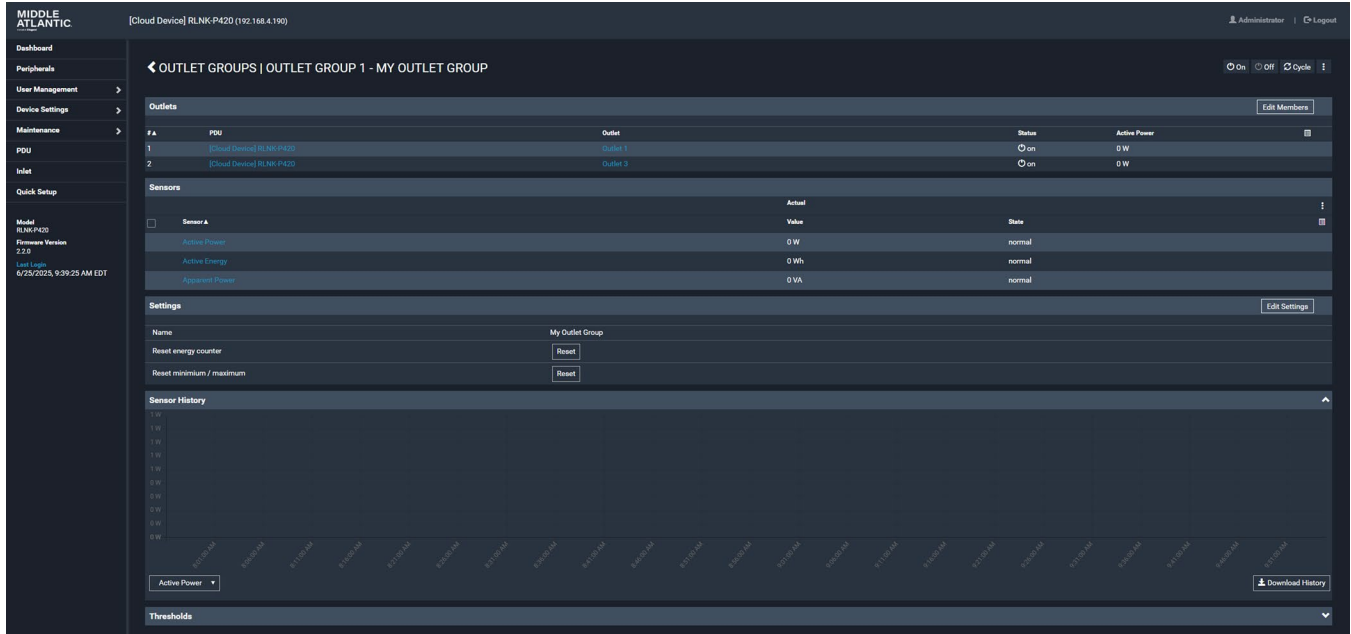

- Use the controls on the upper-right of the screen to turn your outlet group ON or OFF, Cycle the power (turn one or more outlets off and then back on again), or Delete the group.

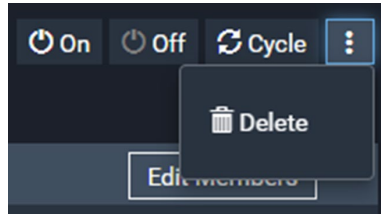

The system prompts you to confirm the deletion.

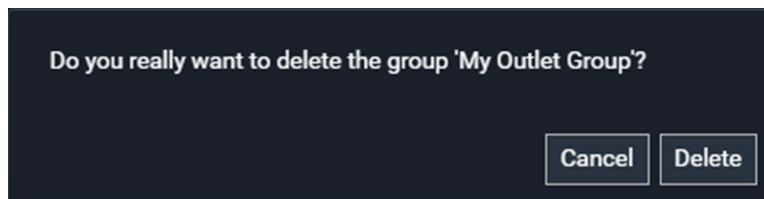

- Click **Delete**.

### Viewing an Outlet Group and Making Additional Settings

- Click the ellipsis  and select Outlet Groups.

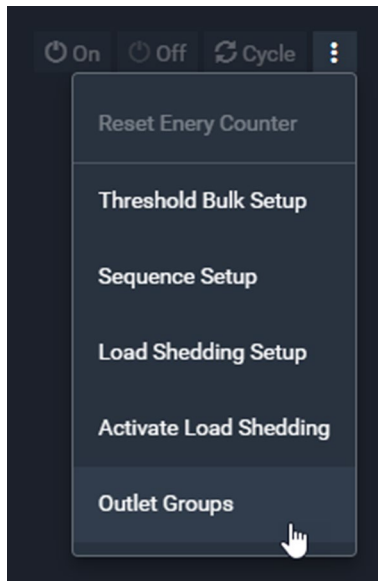

The Outlet Groups page appears.

A screenshot of the 'OUTLET GROUPS' page in the web interface. The page has a dark theme. At the top left is the 'MIDDLE ATLANTIC' logo. To its right is the device information: '[Cloud Device] RLNK-P420 (192.168.4.190)'. On the far right, it shows 'Administrator | Logout'. A left sidebar contains navigation links: 'Dashboard', 'Peripherals', 'User Management', 'Device Settings', 'Maintenance', 'PDU', 'Inlet', and 'Quick Setup'. Below these is a section for 'Model: RLNK-P420', 'Firmware Version: 2.2.0', and 'Last Login: 6/25/2025, 9:39:25 AM EDT'. The main content area is titled 'OUTLET GROUPS' and includes a '+ New Group' button and control icons for 'On', 'Off', and 'Cycle'. Below this is a table with one row of data:

<input type="checkbox"/>	#▲	Name	Status	Outlets	Active Power	<input type="checkbox"/>
	1	My Outlet Group	on x 2	1 and 3	0 W	

- Click the name of the outlet group you wish to view and configure.

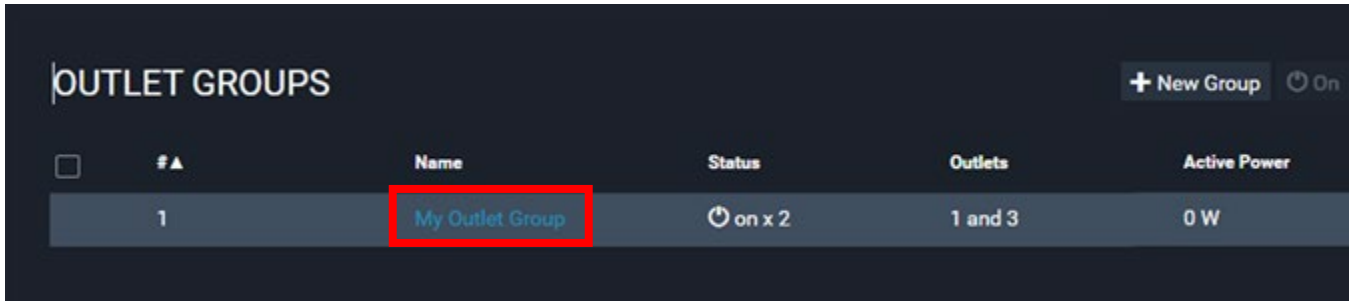

The Outlet Group Details page appears.

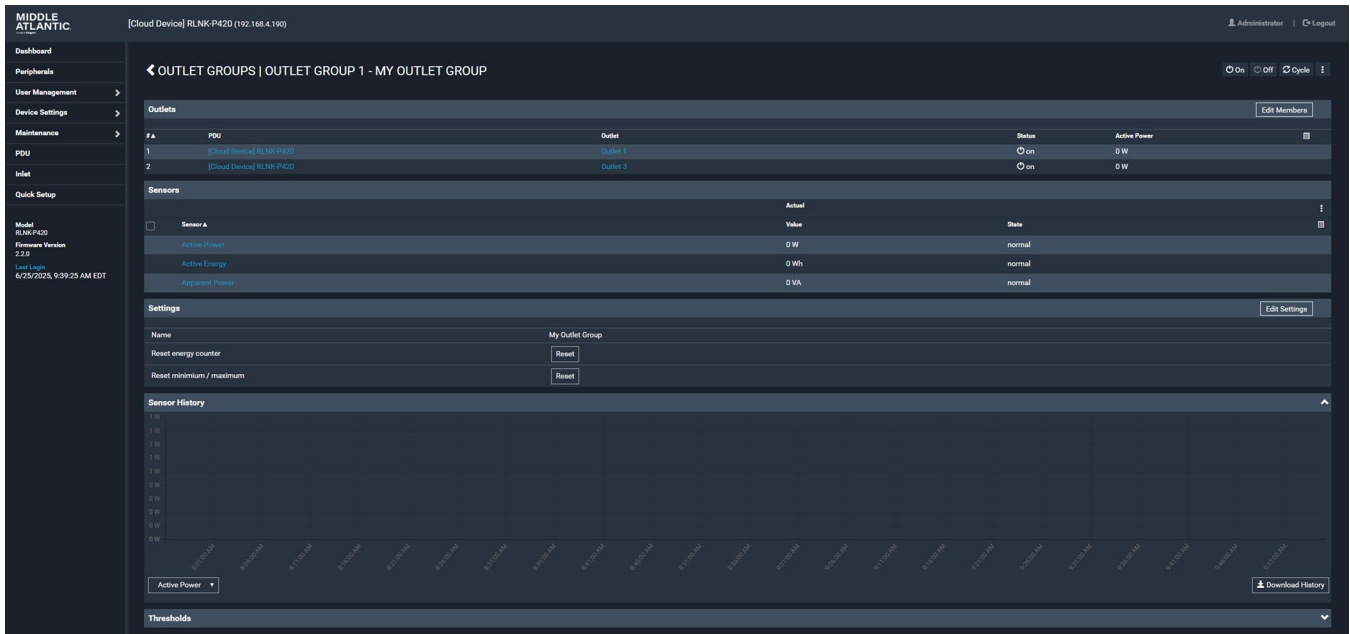

- Sections of the screen provide detailed information about your outlet group as follows:
- The **Outlets** section of the screen lists the name of the the corresponding PDU, the outlets that are part of the group, and the outlet statuses and Active Power ratings.

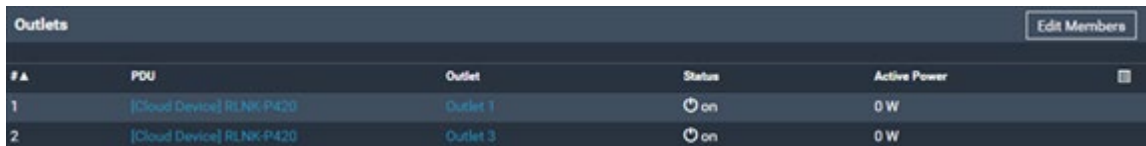

- The **Sensors** section of the screen lists any connected sensor devices and shows their Active Energy, Active Power, and Apparent Power values and states.

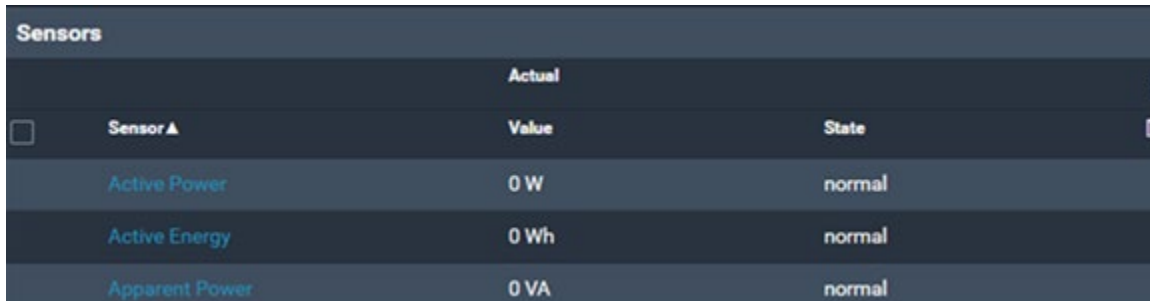

Sensors		
	Actual	
<input type="checkbox"/>	Value	State
Active Power	0 W	normal
Active Energy	0 Wh	normal
Apparent Power	0 VA	normal

- The **Settings** section of the screen allows you to rename the outlet group (after clicking Edit Settings), and click corresponding Reset buttons to reset the energy counter and the minimum / maximum settings for your outlet group.

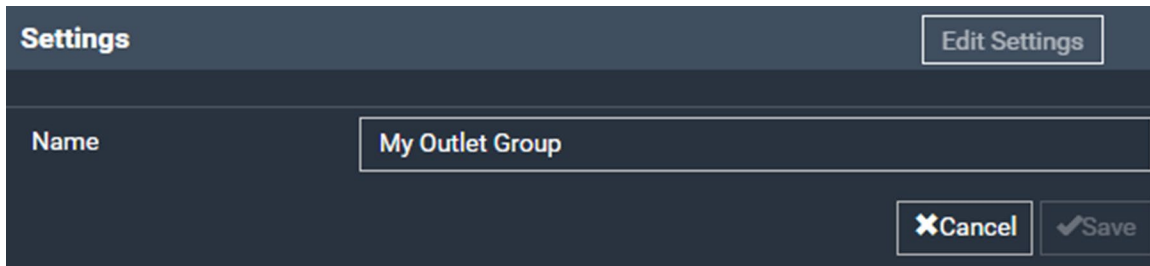

**Settings** Edit Settings

Name

✕Cancel ✓Save

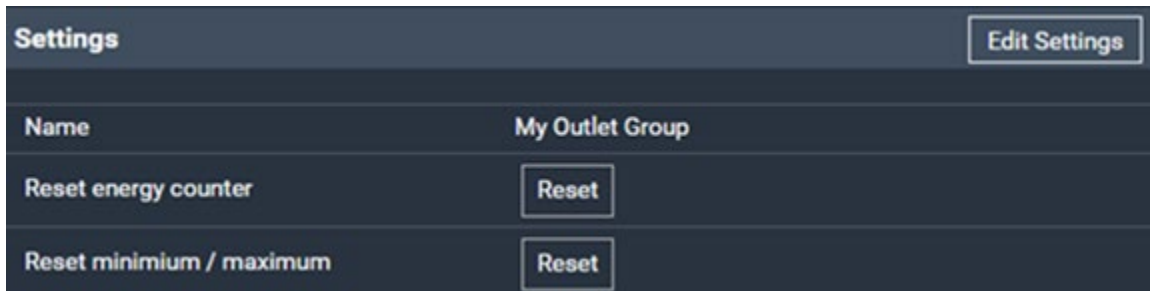

**Settings** Edit Settings

Name

Reset energy counter Reset

Reset minimum / maximum Reset

- The **Sensor History** section of the screen shows graph data for connected sensor device history ratings for Active Energy, Active Power, and Apparent Power as selected from the drop-down on the lower-left.

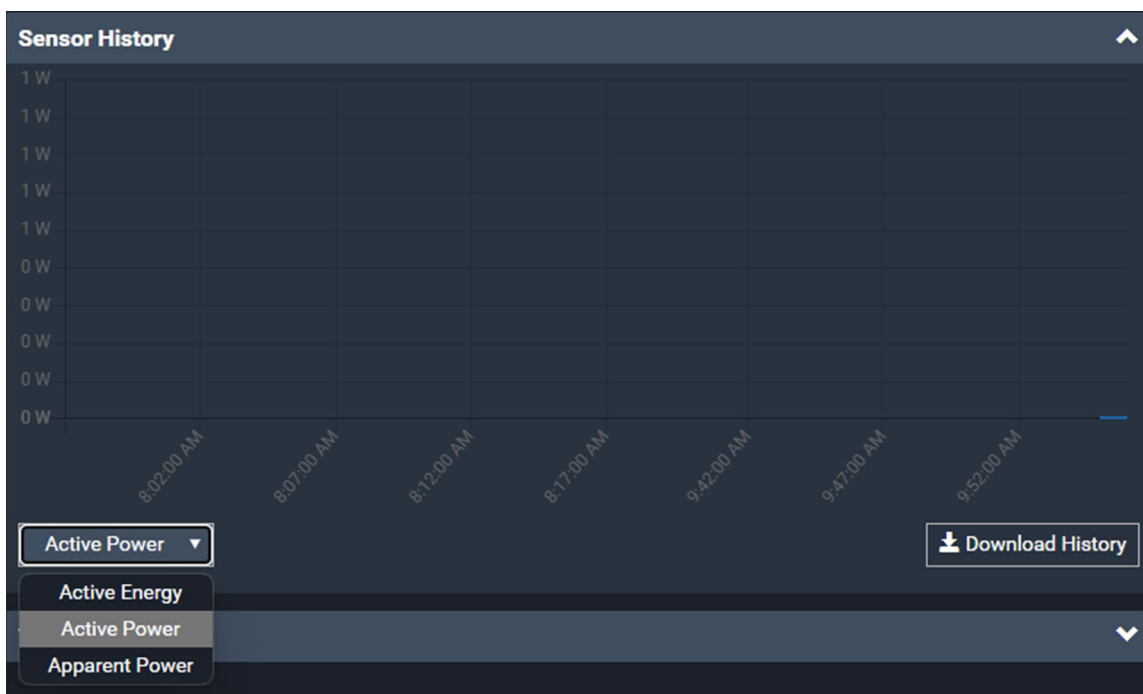

- The **Thresholds** section of the screen lists Lower Critical, Lower Warning, Upper Warning, and Upper Critical threshold data values for Active Energy, Active Power, and Apparent Power for a connected sensor.

Sensor ▲	Lower Critical	Lower Warning	Upper Warning	Upper Critical
Active Power	—	—	—	—
Active Energy	—	—	—	—
Apparent Power	—	—	—	—



- Make changes as desired and click **Save**.
- Additional settings you can perform on your outlet group from this page include the following:
  - Click the **Edit Settings** button to rename the outlet group.
  - Click the **Reset** button to reset the energy counter for your outlet group.
  - Click the **Reset** button to reset the minimum / maximum for your outlet group.
  - Use the **Sensor History** drop-down to select the sensor history view from Active Energy, Active Power, and Apparent Power options.
  - Click the **Download History** button to download your selected sensor history data (Active Energy, Active Power, or Apparent Power) as a .csv file.

## Outlet Controls

Lettered callouts on user interface images correspond with explanations further below.

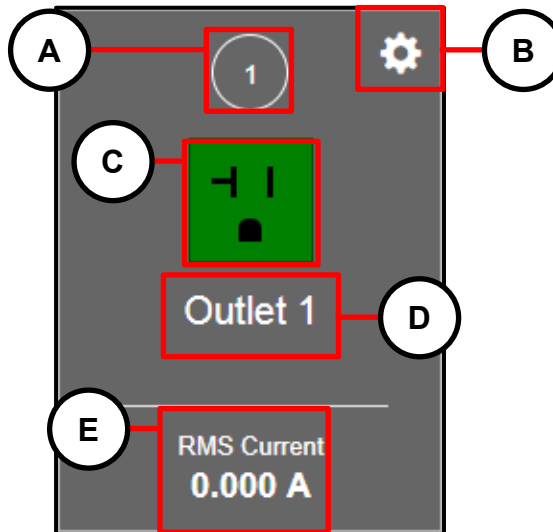







Outlets are displayed on square tiles. Each tile contains information about the outlet as follows:

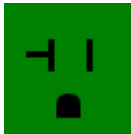

Letter	Description
<b>A</b>	Outlet Number
<b>B</b>	Click the configuration icon  and the outlet configuration page appears. For more information, see <a href="#">Outlet Configuration Page</a> , on page 52.
	<div style="border: 1px solid black; padding: 5px;">  <b>NOTE</b> The configuration icon only appears after selecting an individual outlet. It will not appear when multiple outlets are selected.         </div>
<b>C</b>	Outlet color status icon. For more information, see <a href="#">Outlet Color States</a> , on page 51.
<b>D</b>	Outlet Name. Configure the name in <a href="#">Viewing and Editing Outlet Settings</a> , on page 56.
<b>E</b>	RMS current (A) appears on the outlet.

## Outlet Color States

The Outlet status is marked using one of the following colors.

Icon			Outlet status
			Outlet turned on
			Outlet turned off
			Intermediate State – Shows the outlet is in the off state during a cycle event.

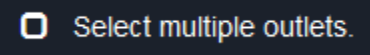

## Selecting Multiple Outlets

You can switch any outlet regardless of its current power state. That is, you can turn on any outlet that is already turned on, or turn off any outlet that is already turned off.

- Click  to select multiple outlets.

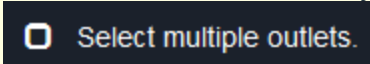

**TIP**

Perform the desired action on only one outlet by clicking the specific outlet without  selected, and then clicking the outlet's settings icon . The data/setup page then appears for the specific outlet.

- Select multiple outlets.

## Selecting All Outlets

You can quickly select all outlets, if desired.



- Click  to select all outlets on your device.

## Controlling Outlets

You can switch any outlet regardless of its current power state. That is, you can turn on any outlet that is already turned on, or turn off any outlet that is already turned off.

- Select the desired outlet(s). For more information, see [Selecting Multiple Outlets](#), on page 51.

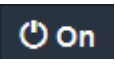
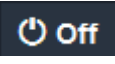
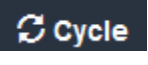
- Click or select the desired button or command.

Button or Command	Action
 On	Power ON.
 Off	Power OFF.
 Cycle	Power cycle. <ul style="list-style-type: none"> <li>• Power cycling the outlet(s) turns the outlet(s) off and then back on.</li> </ul>
 Reset Active Energy	Resets active energy readings of selected outlets. <div style="border: 1px solid black; padding: 5px; margin-top: 5px;">  <b>NOTE</b> Only users with the "Admin" role assigned can reset active energy readings.                     </div>

- Confirm the operation when prompted.



**TIP** For information about resetting ALL active energy counters on the unit, see [PDU](#), on page 215. You can also power control an outlet or reset its active energy from [Power Controlling a Selected Outlet](#), on page 53.

### Outlet Configuration Page

An outlet's data/setup page is opened after clicking the outlet, and then its configuration icon  on the Global Outlets page.

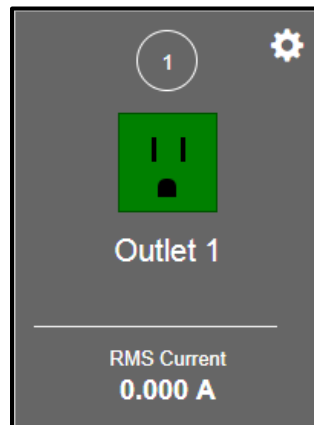

The individual outlet's page shows this outlet's detailed information. For more information, see [Viewing Detailed Information on Outlet Pages](#), on page 53.

In addition, you can perform the following operations on this outlet page.

### Power Controlling a Selected Outlet

- Click one of the power control buttons.

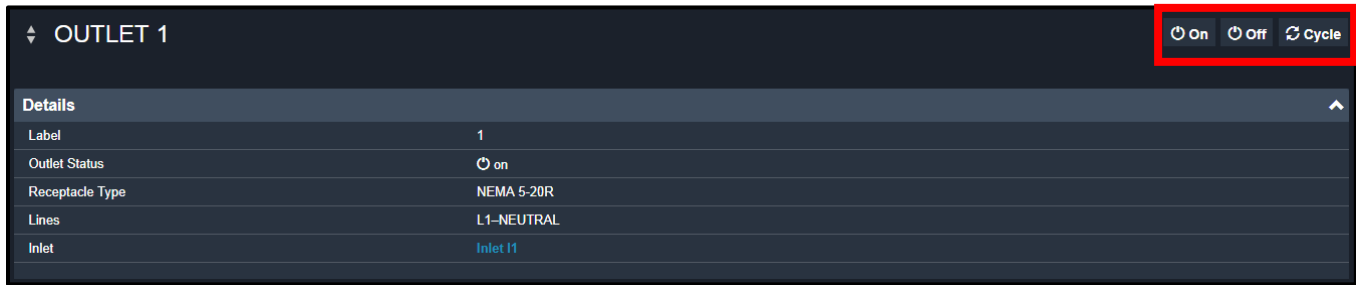

Button/command	Action
	Power ON.
	Power OFF.
	Power cycle. <ul style="list-style-type: none"> <li>• Power cycling the outlet(s) turns the outlet(s) off and then back on.</li> </ul>

- Click **Confirm** when prompted.

### Navigating Outlets and Inlet Data Page Access

- You can go to another outlet's data/setup page by clicking the button  on the top-left corner of the Outlet Configuration page.
- You can go to the associated Inlet's data page by clicking the Inlet link in the Details section.

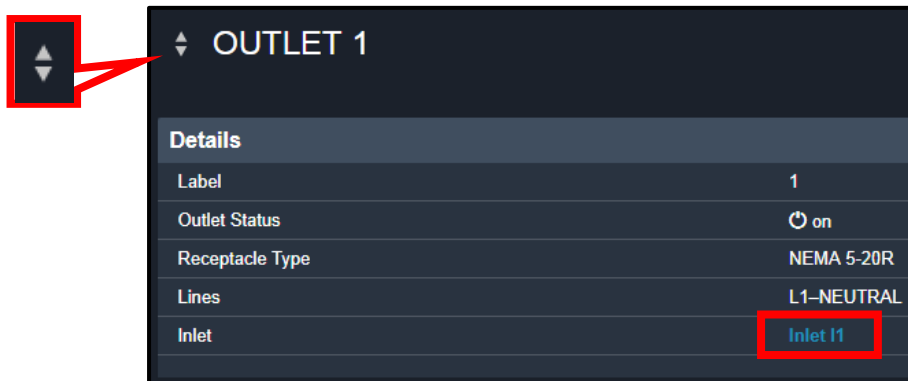

### Viewing Detailed Information on Outlet Pages

Each outlet's data page has a Details section for showing general outlet information and Sensors section for showing the outlet sensor status.

- Click the **Details** title bar as shown.



- View the following data for your selected outlet:

Field	Description
Label	The physical outlet number
Outlet Status	On, Off, or  off (when load-shedding is activated)
Receptacle Type	This outlet's receptacle type
Lines	Lines associated with this outlet
Inlet	Inlet associated with this outlet
Enable AutoPing	Enables AutoPing functionality for the selected outlet.

### Enabling and Configuring AutoPing

- Click the **AutoPing** title bar as shown.



The following page appears.



- Click the **Edit AutoPing** button.
- Select the checkbox labeled “Enable AutoPing monitoring for this component.”



**NOTE**

The AutoPing Server Status is a display field showing one of the following component status connections:

- Monitored
- Error
- Unreachable
- Unrecoverable

- Click the **AutoPing** title bar as shown.



The AutoPing page appears.

**AutoPing** ^

Enable AutoPing monitoring for this component

AutoPing Status Unknown

**Reachability Settings**

IP address/hostname

Number of successful pings to enable feature

Wait time (in seconds) after successful ping

Wait time (in seconds) after unsuccessful ping

Number of consecutive unsuccessful pings for failure

Wait time (in seconds) before resuming pinging after failure

**Actions on Failure / Recovery**

Send EMAIL status for AutoPing monitoring for this outlet

Select which action to take on AutoPing state change Disabled ↑

- View or edit the following fields in the Reachability Settings section.

**NOTE** All fields are required on this section.

Field	Description
AutoPing Status	Display field showing one of the following component status connections: <ul style="list-style-type: none"> <li>Monitored</li> <li>Error</li> <li>Unreachable</li> <li>Unrecoverable</li> </ul>
IP address/hostname	Enter the IP address or host name of the component you want to monitor.
Number of successful pings to enable feature	Enter a value for The number of successful pings required to consider the monitored component as "Reachable." Valid range is 0 to 200.
Wait time (in seconds) after successful ping	Enter the wait time before sending the next ping if the previous ping responded successfully. Valid range is 5 to 600 (seconds).
Wait time (in seconds) after unsuccessful ping	Enter the wait time before sending the next ping if the previous ping did not respond. Valid range is 3 to 600 (seconds).

Field	Description
Number of consecutive unsuccessful pings for failure	Enter the number of consecutive pings without any response before the monitored component is considered "Unreachable." Valid range is 1 to 100.
Wait time (in seconds) before resuming pinging after failure	Enter the wait time before the PDU resumes pinging after the monitored equipment is considered "Unreachable." Valid range is 1 to 1200 (seconds).

- View or edit the following fields in the Actions on Failure/Recovery section.

Field	Description
Send EMAIL status for AutoPing monitoring for this outlet	Select this checkbox to enable email status for AutoPing monitoring of the component.
Recipient Email Addresses	Enter email addresses (separated by commas) to receive AutoPing notifications.
Select which action to take on AutoPing state change	Use the drop-down to select from the following options: <ul style="list-style-type: none"> <li>• Turn Outlet ON</li> <li>• Turn Outlet ON until Recovery</li> <li>• Turn Outlet OFF</li> <li>• Turn Outlet OFF until Recovery</li> <li>• Cycle Outlet</li> <li>• Cycle Outlet until Recovery</li> </ul>
Time between Outlet Cycling (in seconds)	Enter the number of seconds desired between outlet cycling. Valid range is 1 to 3600.
<div data-bbox="103 1184 646 1419" style="border: 1px solid black; padding: 5px;">  <b>NOTE</b> This field only appears when Cycle Outlet or Cycle Outlet Until Recovery is selected in the previous field. </div>	The value entered in this field determines the following: <ul style="list-style-type: none"> <li>• Cycle Outlet: The duration that the outlet is in the OFF state during the cycling process.</li> <li>• Cycle Outlet until Recovery: The duration that the outlet waits in each transition state during the cycling process (OFF, and then ON).</li> </ul>

- Click **Save**.

 **NOTE** When creating your first AutoPing, the button is labeled Create.

### Viewing Sensors

When any internal sensors or environmental sensor packages connected to the PDU enter an abnormal state, the Alerted Sensors section shows them for alerting users. For more information, see [Alerted Sensors](#), on page 32.

If any outlet sensor enters the alarmed state, it is highlighted in yellow or red. For more information, see [Sensor Threshold Settings](#), on page 60. Sensors show both readings and states.

If desired, you can sort the list by clicking the desired column header. For more information, see [Sorting a List](#), on page 29.

- Click the **Sensors** title bar as shown.



The sensors page appears.

Sensor	Value	State
RMS Current	0.000 A	normal
<b>RMS Voltage</b>	<b>120 V</b>	<b>above upper critical</b>
Line Frequency	60.0 Hz	normal
Active Power	0 W	normal
Active Energy	0 Wh	normal
Apparent Power	0 VA	normal
Power Factor	1.00	normal

- The following values are shown:
  - RMS current (A)
  - RMS voltage (V)
  - Active power (W)
  - Active energy (Wh)
  - Apparent power (VA)
  - Power Factor



### Viewing and Editing Outlet Settings

- Click the **Settings** title bar as shown.



- View the following data on the Settings page:
  - Name
  - State on device startup
  - Power off period during power cycle
  - Non-critical
    - Click the **Reset Energy** button reset the outlet's active energy, if desired.
    - Click the **Edit Settings** button to modify the following setting values:

Field	Description
Name	Type an outlet name up to 32 characters long.

Field	Description
State on device startup	<p>Click this field to select this outlet's initial power state after the PDU powers up.</p> <ul style="list-style-type: none"> <li>Options: <i>on</i>, <i>off</i>, <i>last known</i> and <i>PDU defined</i>. For more information, see <a href="#">Options for Outlet State on Startup</a>, on page 219.</li> </ul> <div style="border: 1px solid black; padding: 5px; margin-top: 10px;">  <p><b>NOTE</b> Any option other than "PDU defined" will override the global outlet state setting on this particular outlet. PDU defined (xxx) follows the global outlet state setting. The value xxx in parentheses is the currently selected global option - on, off, or last known.</p> </div>
Power off period during power cycle	<p>Select an option to determine how long this outlet is turned off before turning back on.</p> <ul style="list-style-type: none"> <li>Options: <i>PDU defined (xxx)</i> or customized time.</li> <li>PDU defined (xxx) follows the global power-off period setting, which is set on <a href="#">PDU</a>, n page 215. The value xxx in parentheses is the current global value.</li> <li>Customized time allows you to either click  to select an existing time option or type a new value <i>with an appropriate time unit added</i>. For more information, see <a href="#">Understanding Time Units</a>, on page 220.</li> </ul> <div style="border: 1px solid black; padding: 5px; margin-top: 10px;">  <p><b>NOTE</b> Any time setting other than "PDU defined" will override the global power-off period setting on this particular outlet.</p> </div>
Non-critical	<p>Select this checkbox only when you want this outlet to turn off in the load shedding mode. For more information, see <a href="#">Load Shedding Mode</a>, on page 37.</p>

- o Click **Save**.

**Viewing Outlet History**

- o Click the **Outlet History** tab or title bar as shown.



- The Outlet's power waveform, or Outlet History is shown.

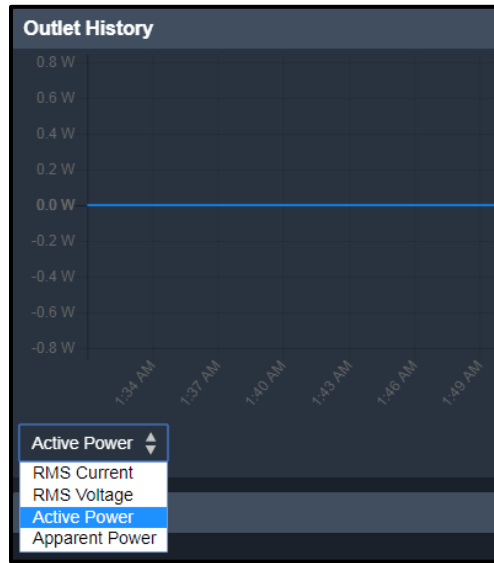

- The power waveform for the outlet helps you observe whether there were abnormal events within the past tens of minutes. The default is to show the outlet's active power data.



- Click the drop-down  beneath the diagram to choose a different data type and show the waveform of other outlet power data.
- Available data types include:

- RMS Current
- RMS Voltage
- Active Power
- Apparent Power

### Configuring Outlet Thresholds

- Click the **Thresholds** tab or title bar as shown.



- Click the desired sensor (required), and then click **Edit Thresholds**.

The screenshot shows a table titled "Thresholds" with an "Edit Thresholds" button in the top right corner. The table has five columns: Sensor, Lower Critical, Lower Warning, Upper Warning, and Upper Critical. The "RMS Current" row is highlighted in blue.

Sensor ▲	Lower Critical	Lower Warning	Upper Warning	Upper Critical
Active Energy	---	---	---	---
Active Power	---	---	---	---
Apparent Power	---	---	---	---
Line Frequency	---	---	---	---
Power Factor	---	---	---	---
RMS Current	---	---	7.8 A	9.6 A
RMS Voltage	94 V	97 V	124 V	127 V

- Make changes as desired.
- Select the corresponding checkbox to enable any threshold.
- Type a new value in the accompanying text box.
- Or, use spin controls  to dial in values.

For concepts of thresholds, deassertion The PDU and assertion timeout, see [Sensor Threshold Settings](#), on page 60.

- Click **Save**.

### Sensor Threshold Settings

This section explains the thresholds settings for a numeric sensor.

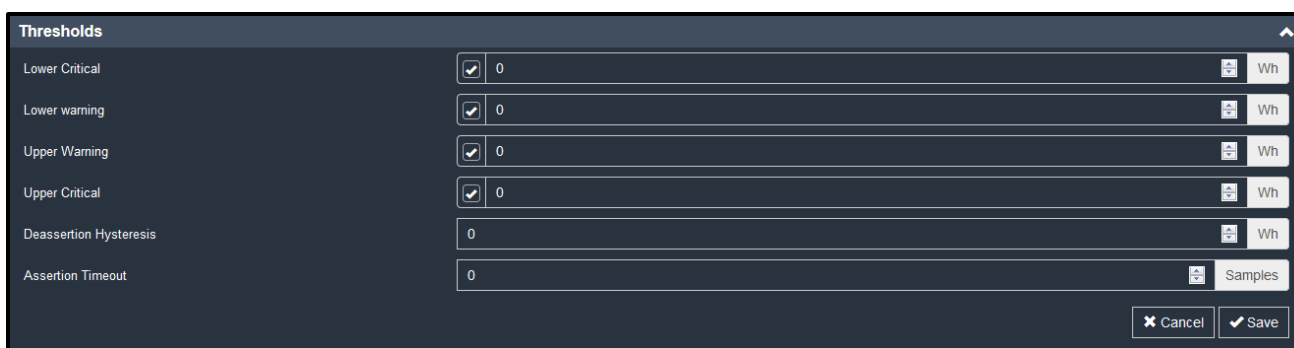

### Thresholds, Sensor States, and Colors

A numeric sensor has four thresholds: Lower Critical, Lower Warning, Upper Warning and Upper Critical.

The threshold settings determine how many sensor states are available for a certain sensor and the range of each sensor state. The diagram below shows how each threshold relates to each state.

In the following table, "R" represents any numeric sensor's reading. The symbol <= means "less than" or "equal to."

Sensor status	Color	States shown in the interface	Description
Unknown	Transparent	unavailable	Sensor state or readings cannot be detected.
		unmanaged	Sensors are not being managed. For more information, see <a href="#">Managed vs. Unmanaged Sensors/Dry Contacts</a> , on page 71.



**NOTE** Managed and unmanaged sensors applies only to Peripherals.

Sensor status	Color	States shown in the interface	Description
Normal	Transparent	normal	<ul style="list-style-type: none"> <li>Numeric or state sensors are within the normal range.</li> <li>OR</li> <li>No thresholds have been enabled for numeric sensors.</li> </ul>
Warning	Yellow	above upper warning	Upper Warning threshold < "R" <= Upper Critical threshold
		below lower warning	Lower Critical threshold <= "R" < Lower Warning threshold
Critical	Red	above upper critical	Upper Critical threshold < "R"
		below lower critical	"R" < Lower Critical threshold
Alarmed	Red	alarmed	State sensors enter the abnormal state.

### Understanding Available Sensor States

The more thresholds are enabled for a sensor, the more sensor states are available for it. The "normal" state is always available regardless of whether any threshold is enabled.

For example:

- When a sensor only has the Upper Critical threshold enabled, it has two sensor states: normal and above upper critical.
- When a sensor has both the Upper Critical and Upper Warning thresholds enabled, it has three sensor states: normal, above upper warning, and above upper critical.

States of "above upper warning" and "below lower warning" are warning states to call for your attention.

States of "above upper critical" and "below lower critical" are critical states that require you to immediately handle.

### Understanding the Range of Each Available Sensor State

The value of each enabled threshold determines the reading range of each available sensor state. For more information, see [Sensor Threshold Settings](#), on page 60.

### Asserting A State

If multiple sensor states are available for a specific sensor, the PDU asserts a state for it whenever a bad state change occurs.

Asserting a state effectively announces a new, worse state.

Below are bad state changes that cause the PDU to assert.

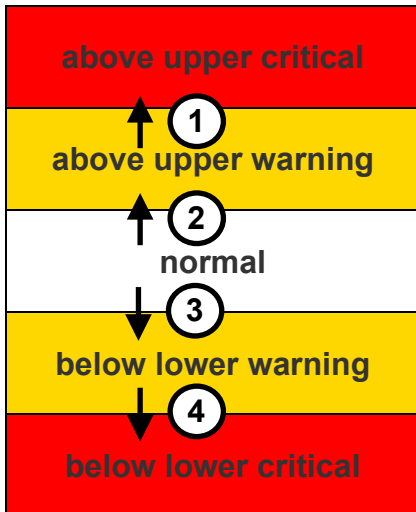

1. above upper warning --> above upper critical
2. normal --> above upper warning
3. normal --> below lower warning
4. below lower warning --> below lower critical

**Configuring An Assertion Timeout**

- Click the Thresholds tab or title bar as shown.



- Click the desired sensor (required), and then click Edit Thresholds.

Sensor ▲	Lower Critical	Lower Warning	Upper Warning	Upper Critical
Active Energy	---	---	---	---
Active Power	---	---	---	---
Apparent Power	---	---	---	---
Line Frequency	---	---	---	---
Power Factor	---	---	---	---
RMS Current	---	---	7.8 A	9.6 A
RMS Voltage	94 V	97 V	124 V	127 V

The Edit Thresholds page appears.

- Modify the Assertion Timeout field as desired.

Lower Critical	<input checked="" type="checkbox"/> 0	Wh
Lower warning	<input checked="" type="checkbox"/> 0	Wh
Upper Warning	<input checked="" type="checkbox"/> 0	Wh
Upper Critical	<input checked="" type="checkbox"/> 0	Wh
Deassertion Hysteresis	0	Wh
Assertion Timeout	0	Samples

In the threshold settings, the Assertion Timeout field postpones or even cancels the "assertion" action. It determines how long a sensor must be in the "worse" new state before the PDU triggers the "assertion" action. If that sensor changes its state again within the specified wait time, the PDU does NOT assert the worse state.

**NOTE**

- Disable the assertion timeout by setting it to 0 (zero).
- For most sensors, the measurement unit in the "Assertion Timeout" field is sample. Sensors are measured every second, so the timing of a sample is equal to a second. BCM2 is an exception to this, with a sample of 3 seconds.

- Click **Save**.

**How "Assertion Timeout" is helpful:**

If you have created an event rule that instructs the PDU to send notifications for assertion events, setting the "Assertion Timeout" is helpful for eliminating a number of notifications that you may receive in case the sensor's readings fluctuate around a certain threshold.

**Assertion Timeout Example for Temperature Sensors***Assumption:*

```
Upper Warning threshold is enabled.
Upper Warning = 25 (degrees Celsius)
Assertion Timeout = 5 samples (that is, 5 seconds)
```

When a temperature sensor's reading exceeds 25 degrees Celsius, moving from the "normal" range to the "above upper warning" range, the PDU does NOT immediately announce this warning state. Instead it waits for 5 seconds, and then does either of the following:

- If the temperature remains above 25 degrees Celsius in the "above upper warning" range for 5 seconds, the PDU performs the "assertion" action to announce the "above upper warning" state.
- If the temperature drops below 25 degrees Celsius within 5 seconds, the PDU does NOT perform the "assertion" action.

***Understanding How to "De-assert" and Deassertion Hysteresis***

After the PDU asserts a worse state for a sensor, it may de-assert that state later on if the readings improve.

De-asserting a state effectively announces the end of a previously asserted worse state.

Below are good state changes that cause the PDU to de-assert the previous state.

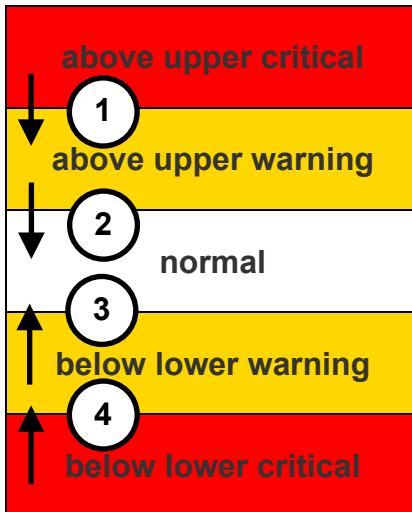

1. above upper critical --> above upper warning
2. above upper warning --> normal
3. below lower warning --> normal
4. below lower critical --> below lower warning

### Deassertion Hysteresis

Thresholds	
Lower Critical	<input checked="" type="checkbox"/> 0 Wh
Lower warning	<input checked="" type="checkbox"/> 0 Wh
Upper Warning	<input checked="" type="checkbox"/> 0 Wh
Upper Critical	<input checked="" type="checkbox"/> 0 Wh
Deassertion Hysteresis	0 Wh
Assertion Timeout	0 Samples

In the threshold settings, the Deassertion Hysteresis field determines a new level to trigger the "deassertion" action.

This function is similar to a thermostat, which instructs the air conditioner to turn on the cooling system when the temperature exceeds a pre-determined level. "Deassertion Hysteresis" instructs the PDU to de-assert the worse state for a sensor only when that sensor's reading reaches the pre-determined "deassertion" level.

For upper thresholds, this "deassertion" level is a decrease against each threshold. For lower thresholds, this level is an increase to each threshold. The absolute value of the decrease/increase is exactly the hysteresis value.

For example, if Deassertion Hysteresis = 2, then:

- Upper Critical = 33, so its "deassertion" level =  $33 - 2 = 31$ .
- Upper Warning = 25, so its "deassertion" level =  $25 - 2 = 23$ .
- Lower Critical = 10, so its "deassertion" level =  $10 + 2 = 12$ .
- Lower Warning = 18, so its "deassertion" level =  $18 + 2 = 20$ .

Set the Deassertion Hysteresis to 0 (zero) to use each threshold as the "deassertion" level instead of determining a new level.

## Understanding How Deassertion Hysteresis is Helpful

If you have created an event rule that instructs the PDU to send notifications for deassertion events, setting the "Deassertion Hysteresis" is helpful for eliminating a number of notifications that you may receive in case a sensor's readings fluctuate around a certain threshold.

### Deassertion Hysteresis Example for Temperature Sensors

#### *Assumption:*

```
Upper Warning threshold is enabled.  
Upper Warning = 20 (degrees Celsius)  
Deassertion Hysteresis = 3 (degrees Celsius)  
"Deassertion" level = 20-3 = 17 (degrees Celsius)
```

When the PDU detects that a temperature sensor's reading drops below 20 degrees Celsius, moving from the "above upper warning" range to the "normal" range, either of the following may occur:

- If the temperature falls between 20 and 17 degrees Celsius, the PDU does NOT perform the "deassertion" action.
- If the temperature drops to 17 degrees Celsius or lower, the PDU performs the "deassertion" action to announce the end of the "above upper warning" state.

## Peripherals

If there are environmental sensor packages connected to the PDU, they are listed on the Peripherals page. For more information, refer to the Premium+ PDU with RackLink Environmental Sensors User Manual at [www.legrandav.com](http://www.legrandav.com).

An environmental sensor package comprises one or some of the following sensors/dry contacts:

- Numeric sensors: Detectors that show both readings and states, such as temperature sensors.
- State sensors: Detectors that show states only, such as contact closure sensors.
- Dry contacts: A dry contact controls a system or mechanism so it shows states only.

The PDU communicates with *managed* sensors/dry contacts only and retrieves their data. It does not communicate with unmanaged ones. For more information, see [Managed vs. Unmanaged Sensors/Dry Contacts](#), on page 71.

When the number of "managed" sensors/dry contacts has not reached the maximum, the PDU automatically brings newly detected sensors/dry contacts under management by default.

One PDU can manage a maximum of 32 sensors/dry contacts.



#### NOTE

For information about disabling the automatic management function, see [How the Automatic Management Function Works](#), on page 219. You need to manually manage a sensor/dry contact only when it is not under management.

When any sensor/dry contact is no longer needed, you can unmanage/release it.

Open the Peripherals page by clicking Peripherals in the [Menu](#), on page 27. Then you can:

- Perform actions on multiple sensors/dry contacts by using the control/action icons on the top-right corner.

# ▲	Name	Reading	State	Type	Serial Number	Position	Actuator
1	Temperature 1	73.8 °F	normal	Temperature	12A7C01350	Port 1, Chain Position 1	
2	Relative Humidity 1	54 %	normal	Humidity	12A7C01350	Port 1, Chain Position 1	
3	Hall Effect 1		normal	Door Contact	QLL7800040	Port 1, Chain Position 2	
5	On/Off 2		normal	Contact Closure	QLL7800040	Port 1, Chain Position 2, Channel 2	
6	On/Off 3		normal	Contact Closure	QLL7800040	Port 1, Chain Position 2, Channel 3	
7	On/Off 4		normal	Contact Closure	QLL7800040	Port 1, Chain Position 2, Channel 4	
8	On/Off 5		normal	Contact Closure	QLL7800040	Port 1, Chain Position 2, Channel 5	
9	Dry Contact 1		off	Dry Contact	QLL7800040	Port 1, Chain Position 2, Channel 1	✓
10	Dry Contact 2		off	Dry Contact	QLL7800040	Port 1, Chain Position 2, Channel 2	✓

**NOTE** On and Off buttons only appear when dry contacts are selected.

- Go to an individual sensor's or dry contact's data/setup page by clicking its name.

# ▲	Name
1	Temperature 1
2	Relative Humidity 1
3	Hall Effect 1
4	On/Off 1
5	On/Off 2

If desired, you can sort the list by clicking the desired column header. For more information, see [Sorting a List](#), on page 29.

## Understanding the Sensor/Dry Contact Overview on the Peripheral Devices Page

If any sensor enters the alarmed state, it is highlighted in yellow or red. For more information, see [Yellow- or Red-Highlighted Sensors](#), on page 71. An dry contact is never highlighted.

Column	Description
Name	<p>By default the PDU assigns a name comprising the following two elements to a newly managed sensor/dry contact.</p> <ul style="list-style-type: none"> <li>• Sensor type, such as "Temperature".</li> <li>• Sequential number of the same sensor/dry contact type, like 1, 2, 3 and so on.</li> </ul> <p>You can customize the name. For more information, see <a href="#">Individual Sensor/Dry Contact Pages</a>, on page 74.</p>

Column	Description
Reading	Only managed 'numeric' sensors show this data, such as temperature and humidity sensors.
State	The data is available for all sensors and dry contacts. For more information, see <a href="#">Sensor/Dry Contact States</a> , on page 72.
Type	Sensor or dry contact type.
Serial Number	This is the serial number printed on the sensor package's label. It helps to identify your sensors/dry contacts. For more information, see <a href="#">Finding the Sensor's Serial Number</a> , on page 73.
Position	The data indicates where this sensor or dry contact is located in the sensor chain. See <a href="#">Identifying the Sensor Position and Channel</a> , on page 73.
Actuator	Indicates whether this sensor package is an actuator or not. If yes, the symbol  is shown.

## Releasing Sensors/Dry Contacts

When the total of managed sensors/dry contacts reaches the maximum (32), you cannot manage additional ones. The only way to manage any sensor/dry contact is to release or replace any managed ones. For information about replacing a managed sensor/dry contact, see [Managing One Sensor or Dry Contact](#), on page 67. Use the following procedure to release them.

- Click Peripherals >  to make checkboxes appear in front of sensors/actuators.



### TIP

Click a specific sensor/actuator without making the checkboxes appear to perform the desired action on only one sensor/actuator.

- Select multiple sensors/actuators.



### TIP

Select the topmost checkbox in the header row to select ALL sensors/actuators.

- Select "managed" sensors/actuators. For more information, see [Sensor/Dry Contact States](#) on page 72.
- Click  > Release.
- Now released sensors/actuators become "unmanaged."

## Managing One Sensor or Dry Contact

If you are managing only one sensor or dry contact, you can assign the desired ID number to it.

**NOTE**

You cannot assign ID numbers when you are managing multiple sensors/dry contacts at a time.

**TIP**

When the total of managed sensors/dry contacts reaches the maximum (32), you cannot manage additional ones. The only way to manage any sensor/dry contact is to release or replace any managed ones. Replace a managed sensor/dry contact by assigning an ID number using this procedure. For information about releasing sensors/dry contacts (managed or not), see [Peripherals](#) on page 65.

- Click Peripherals.
- From the list of "unmanaged" sensors/dry contacts, click the one you want to manage.

The "Manage peripheral device" dialog appears.

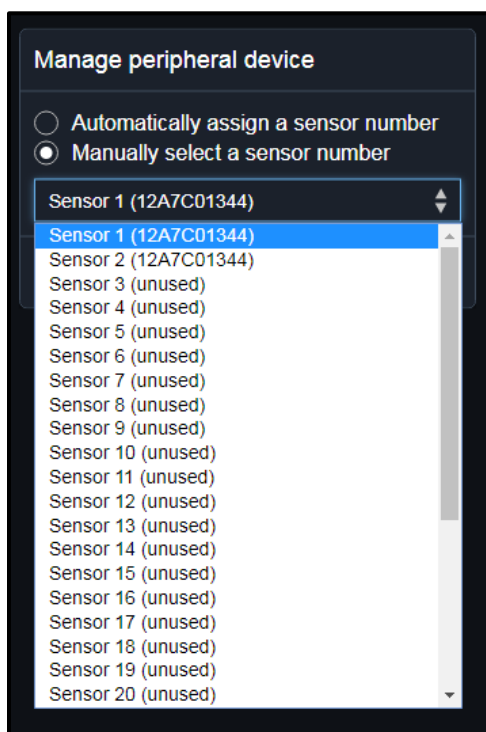

- Select "Automatically assign a sensor number" to let the PDU randomly assign an ID number to the sensor/dry contact.

This method does not release any managed sensor or dry contact.

- Select "Manually select a sensor number" to assign the desired ID number to the sensor/dry contact. Then click  to select an ID number.

This method may release a managed sensor/dry contact if the number you selected has been assigned to a specific sensor/dry contact.

**TIP**

The information in parentheses following each ID number indicates whether the number has been assigned to a sensor or dry contact. If it has been assigned to a sensor or dry contact, it shows its serial number. Otherwise, it shows the word "unused."

- Click **Manage**.

## Managing Multiple Sensors/Dry Contacts

When the total of managed sensors/dry contacts reaches the maximum (32), you cannot manage additional ones. The only way to manage any sensor/dry contact is to release or replace any managed ones. For information about replacing a managed sensor/dry contact, see [Managing One Sensor or Dry Contact](#), on page 74. Use the following procedure to manage them.

- Click Peripherals >  to make checkboxes appear in front of sensors/actuators.

**TIP**

Click a specific sensor/actuator without making the checkboxes appear to perform the desired action on only one sensor/actuator.

- Select multiple sensors/actuators.

**TIP**

Select the topmost checkbox in the header row to select ALL sensors/actuators.

- Select "unmanaged" sensors/actuators.

- Click Peripherals >  > Manage.

- The management action triggers a "Manage peripheral device" dialog. Click Manage if you are managing *multiple* sensors/actuators.

**Manage peripheral device**

Automatically assign a sensor number  
 Manually select a sensor number

- If you are managing only *one* sensor/actuator, you can choose to assign an ID number by selecting "Manually select a sensor number." For more information, see [Managing One Sensor or Dry Contact](#), on page 74.
  - Managed sensors/dry contacts show one of the managed states.

## Configuring Default Threshold Settings

Any changes made to default threshold settings not only re-determine the initial threshold values applying to newly added sensors but also the threshold values of the already-managed sensors where default thresholds are being used. For more information, see [Individual Sensor/Dry Contact Pages](#), on page 74.

- Click Peripherals >  > Default Threshold Setup.
- Click the desired sensor type (required), and then click **Edit Thresholds**.

PERIPHERALS DEFAULT THRESHOLDS				
Sensor Type	Lower Critical	Lower Warning	Upper Warning	Upper Critical
Absolute Humidity	2 g/m³	4 g/m³	20 g/m³	22 g/m³
Air Flow	1.31 ft/s	2.62 ft/s	8.53 ft/s	10.5 ft/s
Air Pressure	---	---	0.0116 psi	0.0145 psi
Relative Humidity	10 %	15 %	85 %	90 %
Temperature	50 °F	59 °F	86 °F	95 °F
Vibration	---	---	0.05 g	0.1 g

- Make changes as needed.
- Select the corresponding checkbox to enable any threshold.
- Type a new value in the accompanying text box.

For concepts of thresholds, deassertion hysteresis and assertion timeout, see [Sensor Threshold Settings](#), on page 60.

- Click **Save**.



**TIP**

For information about customizing the threshold settings on a per-sensor basis, see [Individual Sensor/Dry Contact Pages](#) on page 74.

## Turning ON or OFF Dry Contacts

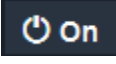
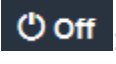
- Click Peripherals.
- Select one or multiple dry contacts which are *in the same status*; meaning, on or off.
- Click  to make checkboxes appear and then select multiple dry contacts as desired.
- Click the desired button.
-  **On**: Turn ON.
-  **Off**: Turn OFF.
  - Confirm the operation when prompted.

## Yellow- or Red-Highlighted Sensors

The PDU highlights the sensors entering the abnormal state with a yellow or red color.



**NOTE** Numeric sensors can change colors only after you have enabled their thresholds.



**TIP** When an dry contact is turned ON, it is also highlighted in red for drawing attention.

For concepts of thresholds, deassertion hysteresis, assertion timeout, and coloring, see [Sensor Threshold Settings](#), on page 60.

## Managed vs. Unmanaged Sensors/Dry Contacts

For information about manually managing or unmanaging/releasing a sensor or dry contact, see [Peripherals](#), on page 65.

- The PDU communicates with managed sensors/dry contacts and retrieves their data.
- Managed sensors/dry contacts are always listed on the Peripheral Devices page no matter they are physically connected or not.
- They have an ID number as illustrated below.

PERIPHERAL DEVICES	
# ▲	Name
10	Presence Detector 1
11	Tamper Detector 1
12	On/Off 7
13	On/Off 8
14	On/Off 9

- They show one of the managed states. For more information, see [Sensor/Dry Contact States](#), on page 72.
- For managed 'numeric' sensors, their readings are retrieved and displayed. If any numeric sensor is disconnected or its reading cannot be retrieved, it shows "unavailable" for its reading.

## Understanding Unmanaged Sensors/Dry Contacts

- The PDU neither communicates with unmanaged sensors/dry contacts nor retrieves their data.
- Unmanaged sensors/dry contacts are listed only when they are physically connected to the PDU. They disappear when they are no longer connected.
- They do *not* have an ID number.
- They show the "unmanaged" state.

## Sensor/Dry Contact States

An environmental sensor or dry contact shows its real-time state after being managed.

Available sensor states depend on the sensor type -- numeric or state sensors. For example, a contact closure sensor is a state sensor so it switches between three states only -- *unavailable*, *alarmed* and *normal*.

Sensors will be highlighted in yellow or red when they enter abnormal states. For more information, see [Yellow- or Red-Highlighted Sensors](#), on page 71.

An dry contact's state is marked in red when it is turned on.

### Understanding Managed Sensor States

In the following table, "R" represents any numeric sensor's reading. The symbol <= means "less than" or "equal to."

State	Description
normal	<ul style="list-style-type: none"> <li>For numeric sensors, it means the readings are within the normal range.</li> <li>For state sensors, it means they enter the normal state.</li> </ul>
below lower critical	"R" < Lower Critical threshold
below lower warning	Lower Critical threshold <= "R" < Lower Warning threshold
above upper warning	Upper Warning threshold < "R" <= Upper Critical threshold
above upper critical	Upper Critical threshold < "R"
alarmed	The state sensor enters the abnormal state.
unavailable	<ul style="list-style-type: none"> <li>The communication with the managed sensor is lost. OR</li> <li>Sensor packages are upgrading their sensor firmware.</li> </ul>



#### NOTE

On contact closure sensors, the normal state depends on the normal setting you have configured. For more information, refer to the Premium+ PDU With RackLink Environmental Sensors User Manual at [www.legrandav.com](http://www.legrandav.com).

### Understanding Managed Dry Contact States

State	Description
on	The dry contact is turned on.
off	The dry contact is turned off.
unavailable	<ul style="list-style-type: none"> <li>The communication with the managed dry contact is lost. OR</li> <li>Sensor packages are upgrading their sensor firmware.</li> </ul>

## Understanding Unmanaged Sensor/Dry Contact States

State	Description
unmanaged	Sensors or dry contacts are physically connected to the PDU but not managed yet.



**NOTE** Unmanaged sensors or dry contacts will disappear from the web interface after they are no longer physically connected to the PDU. For information about manually managing or unmanaging/releasing a sensor or dry contact, see [Peripherals](#) on page 65.

## Finding the Sensor's Serial Number

A RLNK-TEMP or RLNK-CONT sensor package has a serial number tag attached to its underside.



The serial number for each sensor or actuator appears listed in the web interface after each sensor or actuator is detected by the PDU. Match the serial number from the tag to those listed in the sensor table.

PERIPHERAL DEVICES							
# ▲	Name	Reading	State	Type	Serial Number	Position	Actuator
1	Temperature 1	74.0 °F	normal	Temperature	12A7C01350	Port 1, Chain Position 1	
2	Relative Humidity 1	55 %	normal	Humidity	12A7C01350	Port 1, Chain Position 1	
3	Hall Effect 1		normal	Door Contact	QLL7800040	Port 1, Chain Position 2	
5	On/Off 2		normal	Contact Closure	QLL7800040	Port 1, Chain Position 2, Channel 2	
6	On/Off 3		normal	Contact Closure	QLL7800040	Port 1, Chain Position 2, Channel 3	
7	On/Off 4		normal	Contact Closure	QLL7800040	Port 1, Chain Position 2, Channel 4	

## Identifying the Sensor Position and Channel

The PDU can indicate where each sensor or actuator is connected on the Peripheral Devices page.

PERIPHERAL DEVICES							
# ▲	Name	Reading	State	Type	Serial Number	Position	Actuator
1	Temperature 1	74.0 °F	normal	Temperature	12A7C01350	Port 1, Chain Position 1	
2	Relative Humidity 1	55 %	normal	Humidity	12A7C01350	Port 1, Chain Position 1	
3	Hall Effect 1		normal	Door Contact	QLL7800040	Port 1, Chain Position 2	
5	On/Off 2		normal	Contact Closure	QLL7800040	Port 1, Chain Position 2, Channel 2	
6	On/Off 3		normal	Contact Closure	QLL7800040	Port 1, Chain Position 2, Channel 3	
7	On/Off 4		normal	Contact Closure	QLL7800040	Port 1, Chain Position 2, Channel 4	

- Both the sensor port number and its position in a sensor chain appears. For example, *Port 1, Chain Position 2*.
- If a sensor/actuator contains channels, such as a contact closure or dry contact sensor, the channel information is included in the position information. For example, *Channel 1*.

## Understanding Sensor/Dry Contact Position

Example	Physical position
Port 1	Connected to the sensor port #1.
Port 1, Channel 2	<ul style="list-style-type: none"> <li>Connected to the sensor port #1.</li> <li>The sensor/dry contact is the 2nd channel of the sensor package.</li> </ul>
Port 1, Chain Position 4	<ul style="list-style-type: none"> <li>Connected to the sensor port #1.</li> <li>The sensor/dry contact is located in the 4th sensor package of the sensor chain.</li> </ul>
Port 1, Chain Position 3, Channel 2	<ul style="list-style-type: none"> <li>Connected to the sensor port #1.</li> <li>The sensor/dry contact is located in the 3rd sensor package of the sensor chain.</li> <li>It is the 2nd channel of the sensor package.</li> </ul>

## Individual Sensor/Dry Contact Pages

A sensor's or dry contact's data/setup page is opened after clicking any sensor or dry contact name on the Peripheral Devices page. For more information, see [Peripherals](#) on page 65.



**NOTE** Only a numeric sensor has threshold settings, while a state sensor or dry contact has no thresholds.

Threshold settings, if enabled, help you identify whether any numeric sensor enters the warning or critical level. For more information, see [Yellow- or Red-Highlighted Sensors](#), on page 71. In addition, you can have the PDU automatically generate alert notifications for any warning or critical status. For more information, see [Event Rules and Actions](#), on page 120.

### Configuring a Numeric Sensor's Threshold Settings

- Click Edit Thresholds.

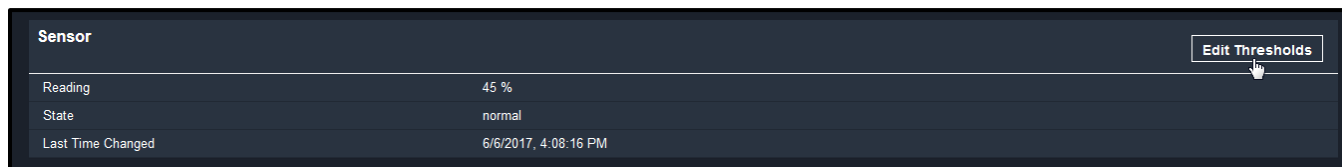

- Select or deselect Use Default Thresholds according to your needs.

The screenshot shows the 'Sensor' configuration page. At the top right is an 'Edit Thresholds' button. Below it is a table of threshold settings. The first row, 'Use Default Thresholds', has a checked checkbox and is highlighted with a red border. The other rows are:

Threshold Type	Value	Unit
Lower Critical	2	g/m³
Lower warning	4	g/m³
Upper Warning	20	g/m³
Upper Critical	22	g/m³
Deassertion Hysteresis	1	g/m³
Assertion Timeout	0	Samples

At the bottom right are 'Cancel' and 'Save' buttons.

- Select the Use Default Thresholds checkbox to have this sensor follow the default threshold settings configured for its sensor type.  
The default threshold settings are configured on the Peripherals page. For more information, see [Peripherals](#), on page 65.
- Customize the threshold settings for this specific sensor by deselecting the Use Default Thresholds checkbox, and then modify the threshold fields below it.



**NOTE** For concepts of thresholds, deassertion hysteresis and assertion timeout, see [Sensor Threshold Settings](#), on page 60.

- Click **Save**.

## Setting Up a Sensor's or Dry Contact's Physical Location and Additional Settings

- Click Edit Settings.

The screenshot shows the 'Settings' page for a sensor named 'Relative Humidity 4'. The page has an 'Edit Settings' button at the top right. Below the button are several input fields:

Field	Value
Name	Relative Humidity 4
Description	
Location (X)	
Location (Y)	
Location (Z: Rack Units)	

- Make changes to available fields, and then click **Save**.

Fields	Description
Binary Sensor Subtype	 <b>NOTE</b> This field is only available for a contact closure sensor. Determine the sensor type of your contact closure detector. <ul style="list-style-type: none"> <li>• <i>Contact Closure</i> detects the door lock or door open/closed status.</li> <li>• <i>Smoke Detection</i> detects the appearance of smoke.</li> <li>• <i>Water Detection</i> detects the appearance of water on the floor.</li> <li>• <i>Vibration</i> detects the vibration of the floor.</li> </ul>
Name	A name for the sensor or dry contact.
Description	Any descriptive text you want.
Location (X, Y and Z)	Describe the sensor's or dry contact's location in the data center by typing alphanumeric values for the X, Y and Z coordinates. For more information, see <a href="#">Sensor/Dry Contact Location Example</a> , on page 77. If the term "Rack Units" appears in parentheses in the Z location, you must type an integer number. The Z coordinate's format is determined on the PDU page. page of <a href="#">PDU</a> , on page 215.

- Click **Save**.

### Viewing a Numeric Sensor's Readings History Waveform

This sensor's data within the past tens of minutes is shown in the waveform diagram.

 **NOTE** Only a numeric sensor has this diagram. State sensors and dry contacts do not show this data.

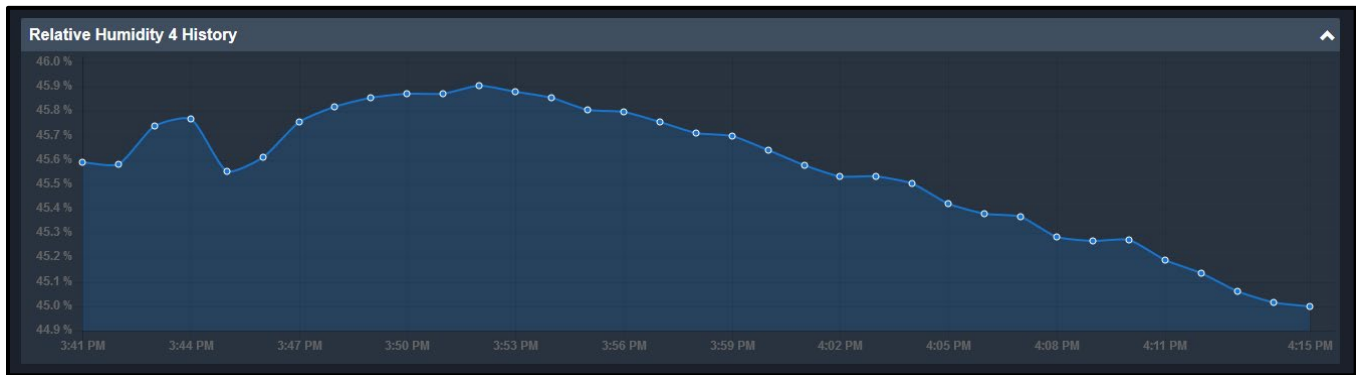

### Turning On or Off an Dry Contact From the Sensor/Dry Contact Page

- Click the desired control button.

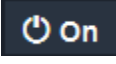
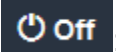
-  **On**: Turn ON.
-  **Off**: Turn OFF.

- Confirm the operation on the confirmation message. The dry contact state is marked in red when it is turned on.

## Using Other Sensor or Dry Contact Operations

You can go to another sensor or dry contact data/setup page by clicking the selector  on the top-left corner.

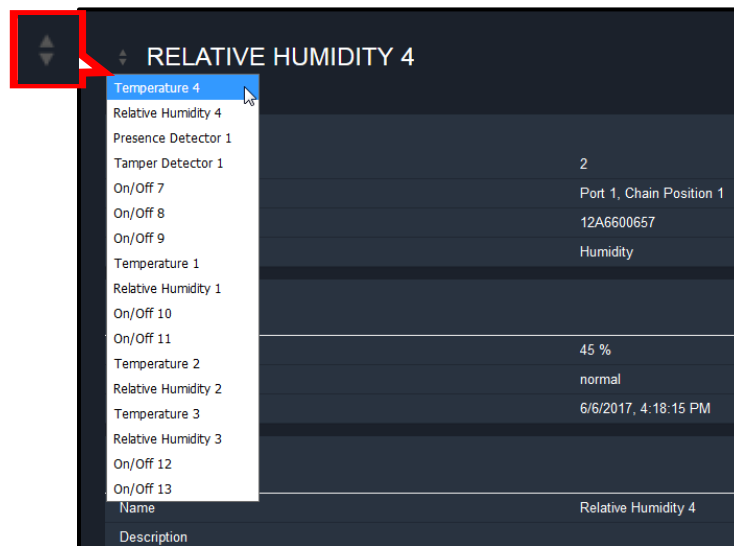
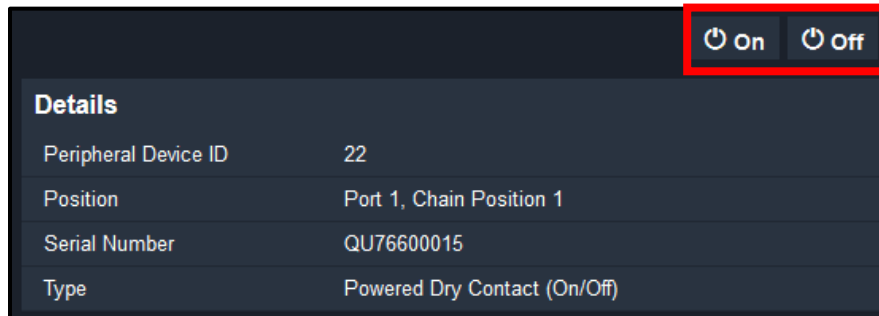

## Sensor/Dry Contact Location Example

Use the X, Y and Z coordinates to describe each sensor's or dry contact's physical location in the data center. For more information, see [Individual Sensor/Dry Contact Pages](#), on page 74.

The X, Y and Z values act as additional attributes and are not tied to any specific measurement scheme. Therefore, you can use non-measurement values.

### Example:

X = Brown Cabinet Row

Y = Third Rack

Z = Top of Cabinet

## Values of the X, Y, and Z Coordinates

- X and Y: They can be any alphanumeric values comprising 0 to 24 characters.
- Z: When the Z coordinate format is set to *Rack Units*, it can be any number ranging from 0 to 60. When its format is set to *Free-Form*, it can be any alphanumeric value comprising 0 to 24 characters. For more information, see [PDU](#), on page 215.

## User Management

User Management menu deals with user accounts, permissions, and preferred measurement units on a per-user basis.

The PDU is shipped with one built-in administrator account: **admin**, which is ideal for initial login and system administrator. You can neither delete 'admin' nor change its permissions.

For information about login defaults, see [Accessing the Web Interface](#), on page 23.

A "role" determines the tasks/actions a user is permitted to perform on the PDU, so you must assign one or multiple roles to each user.

Click 'User Management' in the [Menu](#) on page 28, and the following submenu appears.

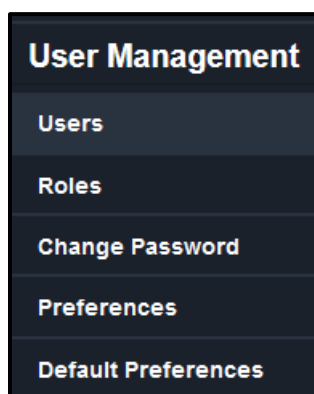

## Creating Users

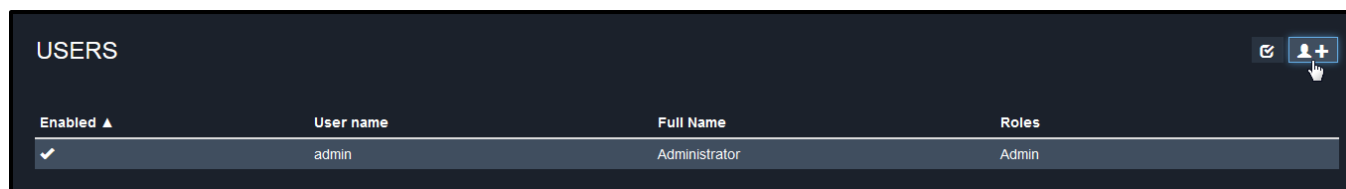

All users must have a user account, containing the login name and password. Multiple users can log in simultaneously using the same login name.

- Select User Management > Users > .



The New User page appears.

- Provide information in the following fields or settings in the User section of the New User page as follows:

	<b>NOTE</b>	You must enter information in the fields showing the message 'required.'
		

Field or Setting	Description
User Name	The name the user enters to log in to the PDU. <ul style="list-style-type: none"> <li>• 4 to 32 characters</li> <li>• Case sensitive</li> <li>• Spaces are NOT permitted.</li> </ul>
Full Name	The user's first and last names.
Password, Confirm Password	<ul style="list-style-type: none"> <li>• 4 to 64 characters</li> <li>• Case sensitive</li> <li>• Spaces are permitted.</li> </ul>
Telephone Number	The user's telephone number
Email Address	The user's email address <ul style="list-style-type: none"> <li>• Up to 64 characters</li> <li>• Case sensitive</li> </ul>
Enable	When selected, the user can log in to the PDU.

- You need to enter the SSH public key only if the public key authentication for SSH is enabled. For more information, see [Changing SSH Settings](#), on page 99.
- Open the SSH public key with a text editor.
- Copy and paste all content in the text editor into the SSH Public Key field.
- The SNMPv3 access permission is disabled by default.

Field or Setting	Description
Enable SNMPv3	Select this checkbox when intending to permit the SNMPv3 access by this user. <div style="border: 1px solid black; padding: 5px; margin-top: 10px;">  <b>NOTE</b> The SNMPv3 protocol must be enabled for SNMPv3 access. For more information, see <a href="#">Configuring SNMP Settings</a> on page 96.           </div>
Security Level	Click the field to select a preferred security level from the list: <ul style="list-style-type: none"> <li>• None: No authentication and no privacy. This is the default.</li> <li>• Authentication: Authentication and no privacy.</li> <li>• Authentication &amp; Privacy: Authentication and privacy.</li> </ul>

- The Authentication Password section is configurable only when 'Authentication' or 'Authentication & Privacy' is selected.

Field or Setting	Description
Same as User Password	Select this checkbox if the authentication password is identical to the user's password. Clear the checkbox to specify a different authentication password.
Password, Confirm Password	Type the authentication password if the 'Same as User Password' checkbox is deselected. The password must consist of 8 to 32 ASCII printable characters.

- The Privacy Password section is configurable only when SNMPv3 is enabled and 'Authentication & Privacy' is selected as the Security Level above.

Field or Setting	Description
Same as Authentication Password	Select this checkbox if the privacy password is identical to the authentication password. Clear the checkbox to specify a different privacy password.
Password, Confirm Password	Type the privacy password if the 'Same as Authentication Password' checkbox is deselected. The password must consist of 8 to 32 ASCII printable characters.

- The Protocol section and its fields or settings is only configurable when 'Authentication' or 'Authentication & Privacy' is selected.

Field or Setting	Description
Authentication	Click this field to select the desired authentication protocol. Two protocols are available: <ul style="list-style-type: none"> <li>• MD5</li> <li>• SHA-1 (default)</li> </ul>
Privacy	Click this field to select the desired privacy protocol. Two protocols are available: <ul style="list-style-type: none"> <li>• DES (default)</li> <li>• AES-128</li> </ul>

- The Preferences section determines the measurement units displayed in the web interface and command line interface for this user.

Field	Description
Temperature Unit	Preferred units for temperatures -- °C (Celsius) or °F (Fahrenheit).
Length Unit	Preferred units for length or height -- Meter or Feet.
Pressure Unit	Preferred units for pressure -- Pascal or Psi. <ul style="list-style-type: none"> <li>• Pascal = one newton per square meter</li> <li>• Psi = pounds per square inch</li> </ul>

**NOTE**

Users can change the measurement units at any time by setting their own preferences. For more information, see [Setting Your Preferred Measurement Units in User Preferences](#) on page 84.

- In the Roles section, select one or multiple roles to determine the user's permissions.

**TIP**

Select the top-most checkbox in the header row to select all roles.

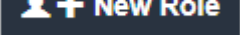
If the built-in roles do not satisfy your needs, add new roles by clicking . For more information, see [Creating Roles](#), on page 82.

The Operator role is assigned to a newly created user account by default.

Built-in role	Description
Admin	Provide full permissions.
Operator	Provide frequently used permissions, including: <ul style="list-style-type: none"> <li>• Acknowledge Alarms</li> <li>• Change Own Password</li> <li>• Change PDU, Inlet, Outlet &amp; Overcurrent Protector Configuration</li> <li>• Switch Outlets</li> <li>• View Event Settings</li> <li>• View Local Event Log</li> </ul>

**NOTE**

With multiple roles selected, a user has the union of all roles' permissions.

- Click **Save**.

## Editing or Deleting Users

- Select User Management > Users to open the Users page, which lists all user accounts.
- Click the desired user.

The Edit User page for that user appears.

- Make changes as desired.
- For information on each field, see [Creating Users](#) on page 78.
- Type a new password in the Password and Confirm Password fields to change the password. If the password field is left blank, the password remains unchanged.
- Click , and confirm the operation to delete the user.

- Click **Save**.

## Deleting Multiple User Accounts

- Select User Management > Users to open the Users page, which lists all user accounts.
- On the Users page, click  to make checkboxes appear in front of user names.



### TIP

Delete only one user by clicking the specific user without making the checkboxes appear. For more information, see the previous procedure.

- Select one or multiple users.
  - Select the top-most checkbox in the header row to select all roles (except for the admin role).
  - Click .
  - Click **Delete** on the confirmation message.

## Creating Roles

A role is a combination of permissions. Each user must have at least one role.

The PDU provides two built-in roles. The Operator role is assigned to a newly created user account per default. For more information, see [Creating Users](#) on page 78.

Built-in role	Description
Admin	Provide full permissions.
Operator	Provide frequently used permissions, including: <ul style="list-style-type: none"> <li>● Acknowledge Alarms</li> <li>● Change Own Password</li> <li>● Change PDU, Inlet, Outlet &amp; Overcurrent Protector Configuration</li> <li>● Switch Outlets</li> <li>● View Event Settings</li> <li>● View Local Event Log</li> </ul>

If the two do not satisfy your needs, add new roles.

- Select User Management > Roles > .

The Roles page appears.

Role Name ▲	Description
Admin	System defined administrator role including all privileges.
Operator	Predefined operator role.

- Assign a role name.
  - 1 to 32 characters long
  - Case sensitive
  - Spaces are permitted
    - Type a description for the role in the Description field.
    - Select the desired privilege(s).
- The 'Administrator Privileges' includes all privileges.
- The 'Unrestricted View Privileges' includes all 'View' privileges.

- Click the  button to select any privilege requiring the argument setting.

For example, on an outlet-switching capable model, you can specify the outlets that are allowed to be switched on/off for the 'Switch Outlet' privilege as shown below.

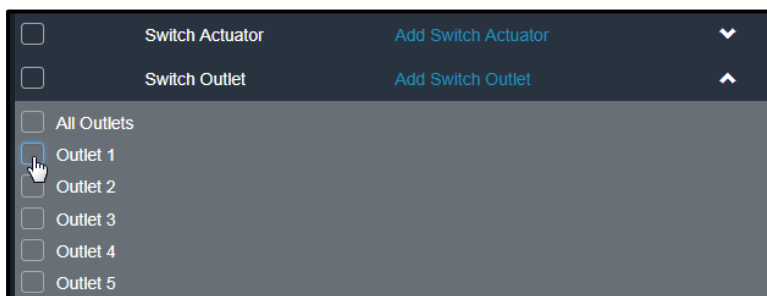

- Click **Save**.

Now you can assign the role to any user. For more information, see [Creating Users](#) on page 78 or [Editing or Deleting Users](#), on page 81.

## Editing or Deleting Roles

Select User Management > Roles to open the Roles page, which lists all defined roles.

If desired, you can sort the list by clicking the desired column header. For more information, see [Sorting a List](#), on page 29.

The Admin role is not user-configurable so the lock icon  displays, indicating that you are not allowed to configure it.

### Editing a Role

- Select User Management > Roles.

The Roles page appears and lists all the defined roles.

- Click the desired role.

The Edit Role page appears.

- Make changes as desired.



**NOTE** The role name cannot be changed.



**TIP** Click , and confirm the operation to delete a role.

- Click **Save**.

## Deleting Roles

- Select User Management > Roles.

The Roles page appears and lists all the defined roles.

- Click  to make checkboxes appear in front of roles.



**TIP** Click a specific role without making the checkboxes appear to delete only that one role. For more information, see the above procedure.

- Select one or multiple roles.
- Select the top-most checkbox in the header row to select all roles (except for the Admin role).
- Click  on the top-right corner.
- Click **Delete** on the confirmation message.

## Changing Your Password

You must have the Change Own Password permission to change your own password. For more information, see [Creating Roles](#), on page 82.

You must have Administrator Privileges to change other users' passwords. For more information, see [Editing or Deleting Users](#), on page 81.

For more information about changing your password on your first login, see [Accessing the Web Interface](#), on page 23.

- Select User Management > Change Password.

The Change Password page appears.

- First type the current password (listed as 'old password'), and then the new password twice. Passwords are case sensitive.
- A password must be within 4 to 64 characters.

## Setting Your Preferred Measurement Units in User Preferences

You can change the measurement units shown in the interface according to your own preferences regardless of the permissions you have.

**TIP**

User Preferences can also be changed by administrators for specific users on the Edit User page. For more information, see [Editing or Deleting Users](#) on page 81.

Measurement unit changes only apply to the web interface and command line interface.

Setting your own preferences does not change the default measurement units. For more information, see [Setting Default Measurement Units](#), on page 85.

- Select User Management > User Preferences.

The User Preferences page appears.

- Make changes as desired.

Field	Description
Temperature Unit	Preferred units for temperatures -- °C (Celsius) or °F (Fahrenheit).
Length Unit	Preferred units for length or height -- Meter or Feet.
Pressure Unit	Preferred units for pressure -- Pascal or Psi. <ul style="list-style-type: none"> <li>• Pascal = one newton per square meter</li> <li>• Psi = pounds per square inch</li> </ul>

- Click **Save**.

## Setting Default Measurement Units

Default measurement units are applied to all PDU user interfaces across all users, including users accessing the PDU via external authentication servers. For a list of affected user interfaces, see [User Interfaces Showing Default Units](#), on page 86. The front panel display also shows the default measurement units.

**NOTE**

The preferred measurement units set by any individual user or by the administrator on a per-user basis will override the default units in the web interface and command line interface. For more information, see [Setting Your Preferred Measurement Units in User Preferences](#), on page 84 or [Creating Users](#), on page 78.

- Select User Management > Default Preferences.

The Default Preferences page appears.

- Make changes as desired.

Field	Description
Temperature Unit	Preferred units for temperatures -- °C (Celsius) or °F (Fahrenheit).
Length Unit	Preferred units for length or height -- Meter or Feet.
Pressure Unit	Preferred units for pressure -- Pascal or Psi. <ul style="list-style-type: none"> <li>• Pascal = one newton per square meter</li> <li>• Psi = pounds per square inch</li> </ul>

- Click **Save**.

## User Interfaces Showing Default Units

Default measurement units will apply to the following user interfaces or information:

- Web interface for "newly created" local users when they have not configured their own preferred measurement units. For more information, see [Creating Users](#), on page 78.
- The sensor report sent because of the "Send Sensor Report" action. For more information, see [Send Sensor Report Example](#), on page 138.
- Front panel display.

## Device Settings

Click 'Device Settings' in the [Menu](#), on page 28, and the following submenu appears.

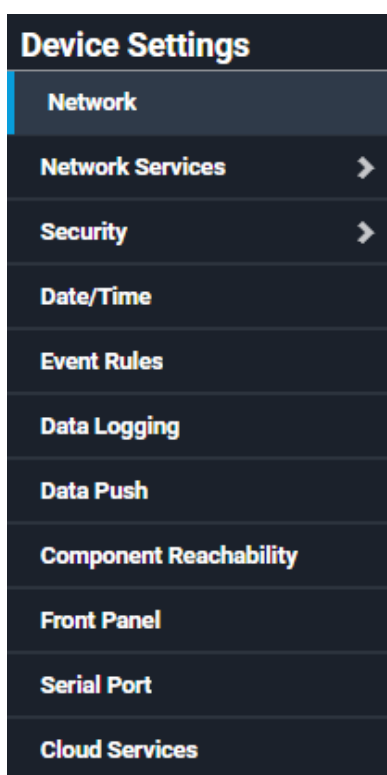

## Configuring Network Settings

Configure common, ETH1, ETH2, and wireless settings on the Network page after connecting the PDU to your network. For more information, see [Connecting the PDU to Your Network](#), on page 21.

You can enable both wired and wireless networking on the PDU so that it has multiple IP addresses -- wired and wireless IP. For example, you can obtain one IPv4 and/or IPv6 address by enabling one Ethernet interface, and obtain one more IPv4 and/or IPv6 address by enabling/configuring the wireless interface. This also applies when the PDU enters port forwarding mode so that the PDU can have more than one IPv4 or IPv6 address while in that mode.

## Configuring Initial Network Settings

- Choose Device Settings > Network.
- The Network page appears. Choose from the following network configuration options:
  - See step 3 to use DHCP-assigned DNS servers and gateway instead of static ones. Manually specify DNS servers and default gateway by configuring the Common Network Settings section. For more information, see [Common Network Settings](#), on page 88.
  - Select Wired from the Network Interface drop-down to configure IPv4/IPv6 settings for a *wired* network. For more information, see [Configuring Wired Network Settings](#), on page 87.
  - Select Wireless from the Network Interface drop-down to configure IPv4/IPv6 settings for a *wireless* network. For more information, see [Wireless Network Settings](#), on page 91.



### NOTE

You must connect a USB wireless LAN adapter to the PDU for wireless networking.

- Configure the ETHERNET interface settings. For more information, see [Configuring Network Settings](#), on page 86.



### NOTE

After enabling IPv4 and/or IPv6, all but not limited to the following protocols will be compliant with the selected Internet protocol(s):

- NTP
- SMTP
- SSH
- Telnet
- FTP
- SSL/TLS
- SNMP
- SysLog

The PDU supports TLS 1.0, 1.1 and 1.2.

## Configuring Wired Network Settings

- Select Device Settings > Network.

The Network page appears.

- Select Wired from the Network Interface drop-down to configure IPv4/IPv6 settings.
- Configure IPv4 or IPv6 settings as follows:

### IPv4 Settings

Field or Setting	Description
Enable IPv4	Enable or disable the IPv4 protocol.
IP Auto Configuration	Select the method to configure IPv4 settings. <ul style="list-style-type: none"> <li>• DHCP: Auto-configure IPv4 settings via DHCP servers.</li> </ul>

Field or Setting	Description
	<ul style="list-style-type: none"> <li>• Static: Manually configure the IPv4 settings.</li> </ul>

- **DHCP settings:** Optionally specify the preferred hostname, which must meet the following requirements:
  - Consists of alphanumeric characters and/or hyphens
  - Cannot begin or end with a hyphen
  - Cannot contain more than 63 characters
  - Cannot contain punctuation marks, spaces, and other symbols
- **Static settings:** Assign a static IPv4 address, which follows this syntax "IP address/prefix length". Example: 192.168.84.99/24

### IPv6 Settings

Field or Setting	Description
Enable IPv6	Enable or disable the IPv6 protocol.
IP Auto Configuration	Select the method to configure IPv6 settings. <ul style="list-style-type: none"> <li>• Automatic: Auto-configure IPv6 settings via DHCPv6.</li> <li>• Static: Manually configure the IPv6 settings.</li> </ul>

- **Automatic settings:** Optionally specify the preferred hostname, which must meet the above requirements.
- **Static settings:** Assign a static IPv6 address, which follows this syntax "IP address/prefix length".

Example: fd07:2fa:6cf:1111::0/128

### Common Network Settings

DNS Settings are OPTIONAL, not required. Therefore, leave them unchanged if there are no specific local networking requirements.

- Select Device Settings > Network.

The Network page appears.

- Click the Common Network Settings title bar as shown.





- Configure settings as follows:

Field	Description
IP Protocol	Specify from the following protocols: <ul style="list-style-type: none"> <li>• IPv4 Address: Use the IPv4 addresses.</li> <li>• IPv6 Address: Use the IPv6 addresses.</li> <li>• IPv4 and IPv6: Use both addresses.</li> </ul>
DNS Resolver Preference	Determine which IP address is used when the DNS resolver returns both IPv4 and IPv6 addresses. <ul style="list-style-type: none"> <li>• IPv4 Address: Use the IPv4 addresses.</li> <li>• IPv6 Address: Use the IPv6 addresses.</li> </ul>
DNS Suffixes (optional)	Specify a DNS suffix name if needed.
First, Second, and Third DNS Server	Manually specify static DNS server(s). <ul style="list-style-type: none"> <li>• If any static DNS server is specified in these fields, it will override the DHCP-assigned DNS server.</li> <li>• If DHCP (or Automatic) is selected for IPv4/IPv6 settings, and there are NO static DNS servers specified, the PDU will use DHCP-assigned DNS servers.</li> </ul>

○ Configure IPv4 Route settings as follows:



- a. In the Default Gateway text box, provide a default gateway address for your IPv4 routes.
- b. Click Add Route.
- c. In the Destination text box, enter a valid destination address.
- d. Select Gateway or Interface from the drop-down and provide the following additional information:
  - If you select Gateway, enter a gateway address in the adjacent text box.
  - If you select Interface, select from BRIDGE, ETH1, ETH2, and WIRELESS options in the adjacent drop-down field.

- e. Use the  and  buttons to arrange the order of the routes.

- f. Click  to delete a created route.

○ Configure IPv6 Route settings as follows:

- a. In the Default Gateway text box, provide a default gateway address for your IPv6 routes.
- b. Click Add Route.
- c. In the Destination text box, enter a valid destination address.
- d. Select Gateway or Interface from the drop-down and provide the following additional information:
  - If you select Gateway, enter a gateway address in the adjacent text box.
  - If you select Interface, select from BRIDGE, ETH1, ETH2, and WIRELESS options in the adjacent drop-down field.

- e. Use the  and  buttons to arrange the order of the routes.
- f. Click  to delete a created route.

### Ethernet Interface Settings

By default the ETH1/ETH2 interfaces for your PDU are enabled.

- o Select Device Settings > Network.

The Network page appears.

- o Click the ETH1 or ETH2 title bar as shown.

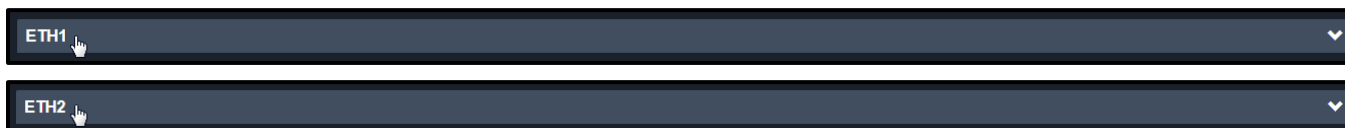



**NOTE** ETH1 and ETH2 sections of the Network page have the same configuration settings available for each port. Therefore, they are covered in this single topic for the sake of space.

- o Configure settings as follows:

Field	Description
Speed	Select a LAN speed. <ul style="list-style-type: none"> <li>• Auto: System determines the optimum LAN speed through auto-negotiation.</li> <li>• 10 MBit/s: Speed is always 10 Mbps.</li> <li>• 100 MBit/s: Speed is always 100 Mbps.</li> </ul>
Duplex	Select a duplex mode. <ul style="list-style-type: none"> <li>• Auto: The PDU selects the optimum transmission mode through auto-negotiation.</li> <li>• Full: Data is transmitted in both directions simultaneously.</li> <li>• Half: Data is transmitted in one direction (to or from the PDU) at a time.</li> </ul>
Current State	Show the LAN's current status, including the current speed and duplex mode.



**NOTE** Auto-negotiation is disabled after setting both the speed and duplex settings of the PDU to NON-Auto values, which may result in a duplex mismatch.

- o Configure IPv4 settings as follows:
  - a. Select the Enable IPv4 checkbox to enable the interface. This checkbox is selected by default.

- b. In the IP Auto Configuration drop-down select DHCP or Static and provide the following additional information:
  - If you selected DHCP, enter a Preferred Hostname in the text box provided.
  - DHCP hostnames must meet the following requirements:
    - Consists of alphanumeric characters and/or hyphens
    - Cannot begin or end with a hyphen
    - Cannot contain more than 63 characters
    - Cannot contain punctuation marks, spaces, and other symbols
  - If you selected Static, enter a valid IPv4 address in the text box provided.
  - If you selected Static, enter a corresponding subnet mask or prefix length for your IPv4 address in the text box provided.
    - Subnet Mask Example: 255.255.255.254  
OR
    - Prefix Length Example: /23
    - Configure IPv6 settings as follows:
      - a. Select the Enable IPv6 checkbox to enable the interface. This checkbox is selected by default.
      - b. In the IP Auto Configuration drop-down select DHCP or Static and provide the following additional information:
        - If you selected DHCP, enter a Preferred Hostname in the text box provided.
        - DHCP hostnames must meet the following requirements:
          - Consists of alphanumeric characters and/or hyphens
          - Cannot begin or end with a hyphen
          - Cannot contain more than 63 characters
          - Cannot contain punctuation marks, spaces, and other symbols
        - If you selected Static, enter a valid IPv6 address with a prefix length in the text box provided. The address follows an “IP address/prefix length” syntax.
          - Example: fd07:2fa:6cff:1111::0/128

## Wireless Network Settings

- Choose Device Settings > Network.
- Click the WIRELESS title bar as shown.







### NOTE

By default the wireless interface is disabled. You should enable it if wireless networking is desired.

- Configure as follows:

**Interface Settings**

Field or Setting	Description
Hardware State	Look in this display field to ensure that the PDU has detected a wireless USB LAN adapter. If not, verify whether the USB LAN adapter is firmly connected or whether it is supported.
SSID	Type the name of the wireless access point (AP)
Force AP BSSID	If the BSSID is available, select this checkbox
BSSID	Type the MAC address of an access point
Authentication	Select an authentication method. <ul style="list-style-type: none"> <li>No Authentication: No authentication data is required.</li> <li>PSK: A Pre-Shared Key is required.</li> <li>EAP - PEAP: Use Protected Extensible Authentication Protocol. Only MSCHAPv2 is supported. Enter required authentication data in the fields that appear.</li> </ul>
Pre-Shared Key	<div style="border: 1px solid black; padding: 5px; margin-bottom: 5px;">  <b>NOTE</b> This field appears only when PSK is selected. </div> Type the PSK string
Identity	<div style="border: 1px solid black; padding: 5px; margin-bottom: 5px;">  <b>NOTE</b> This field appears only when 'EAP - PEAP' is selected. </div> Type your user name.
Password	<div style="border: 1px solid black; padding: 5px; margin-bottom: 5px;">  <b>NOTE</b> This field appears only when 'EAP - PEAP' is selected. </div> Type your password.
CA Certificate	<div style="border: 1px solid black; padding: 5px; margin-bottom: 5px;">  <b>NOTE</b> This field appears only when 'EAP - PEAP' is selected. </div> A third-party CA certificate may or may not be needed. If needed, follow the steps below.

- Available settings for the CA Certificate:

Field or Setting	Description
Enable verification of TLS certificate chain	Select this checkbox for the PDU to verify the validity of the TLS certificate that will be installed.

Field or Setting	Description
	<ul style="list-style-type: none"> <li>For example, the PDU will check the certificate's validity period against the system time.</li> </ul>
	<p>Click this button to install a certificate file. Then you can:</p> <ul style="list-style-type: none"> <li>Click Show to view the certificate's content.</li> <li>Click Remove to delete the installed certificate if it is inappropriate.</li> </ul>
Allow expired and not yet valid certificates	<ul style="list-style-type: none"> <li>Select this checkbox to make the authentication succeed regardless of the certificate's validity period.</li> <li>After deselecting this checkbox, the authentication fails whenever any certificate in the selected certificate chain is outdated or not valid yet.</li> </ul>
Allow wireless connection if system clock is incorrect	<p>When this checkbox is deselected, and if the system time is incorrect, the installed TLS certificate is considered not valid yet and will cause the wireless network connection to fail.</p> <p>When this checkbox is selected, it will make the wireless network connection successful when the PDU system time is earlier than the firmware build before synchronizing with any NTP server.</p> <ul style="list-style-type: none"> <li>The incorrect system time issue may occur when the PDU has been powered off for a long time.</li> </ul>

- Configure wireless IPv4 settings as follows:

- Select the Enable IPv4 checkbox to enable the interface. This checkbox is selected by default.
- In the IP Auto Configuration drop-down select DHCP or Static and provide the following additional information:
  - If you selected DHCP, enter a Preferred Hostname in the text box provided.
  - DHCP hostnames must meet the following requirements:
    - Consists of alphanumeric characters and/or hyphens
    - Cannot begin or end with a hyphen
    - Cannot contain more than 63 characters
    - Cannot contain punctuation marks, spaces, and other symbols
  - If you selected Static, enter a valid IPv4 address with a prefix length in the text box provided. The address follows an “IP address/prefix length” syntax.
    - Example: 192.168.84.99/24

- Configure wireless IPv6 settings as follows:

- Select the Enable IPv6 checkbox to enable the interface. This checkbox is selected by default.
- In the IP Auto Configuration drop-down select DHCP or Static and provide the following additional information:
  - If you selected DHCP, enter a Preferred Hostname in the text box provided.
  - DHCP hostnames must meet the following requirements:
    - Consists of alphanumeric characters and/or hyphens
    - Cannot begin or end with a hyphen

- Cannot contain more than 63 characters
- Cannot contain punctuation marks, spaces, and other symbols
- If you selected Static, enter a valid IPv6 address with a prefix length in the text box provided. The address follows an “IP address/prefix length” syntax.
  - Example: fd07:2fa:6cff:1111::0/128
  - Click **Save**.

## Wireless LAN Diagnostic Log

The PDU provides a diagnostic log for inspecting connection errors that occurred over the wireless network interface. The information is useful for technical support.



**NOTE** The WLAN Diagnostic Log shows data only after the Network Interface is set to Wireless.

Each entry in the log consists of:

- ID number
- Date and time
- Description

### Viewing the Log



- Choose Device Settings > Network.
- Click the WIRELESS title bar as shown.

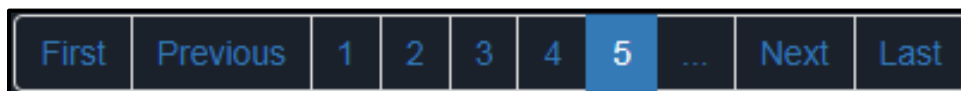

- Click Show WLAN Diagnostic Log.
- Click the pagination bar at the bottom of the page to access other pages of the log.
- If there are more than 5 pages and the page numbers displayed in the bar does not

show the desired one, click  to have it show the next or previous five page numbers, if available.

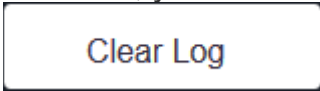

- Click  **Refresh** on the top-right corner to refresh the diagnostic.
- If desired, you can sort the list by clicking the desired column header. For more information, see [Sorting a List](#), on page 29.
- If desired, you can clear the diagnostic log by clicking  >  in the top-right corner.
- Click **Clear Log** in the confirmation message.

## Configuring Network Services

The PDU supports all of the network communication services contained in this portion of the interface.

HTTPS and HTTP enable the access to the web interface.

Telnet and SSH enable the access to the command line interface. Refer to Using the Command Line Interface in the Premium+ PDU With RackLink Advanced User Manual at [www.legrandav.com](http://www.legrandav.com).

By default, SSH is enabled, Telnet is disabled, and all TCP ports for supported services are set to standard ports. You can change default settings if necessary.



### NOTE

Telnet access is disabled by default because it communicates openly and is therefore insecure.

### Network Services

HTTP

SNMP

SMTP Server

SSH

Telnet

Modbus

Service Advertising



### CAUTION

The PDU uses TLS instead of SSL 3.0 due to published security vulnerabilities in SSL 3.0. Make sure your network infrastructure, such as mail services, uses TLS rather than SSL 3.0.

### ATTENTION

La PDU utilise TLS au lieu de SSL 3.0 en raison des vulnérabilités de sécurité publiées dans SSL 3.0. Assurez-vous que votre infrastructure réseau, comme les services de messagerie, utilise TLS plutôt que SSL 3.0.

### Changing HTTP(S) Settings

HTTPS uses Transport Layer Security (TLS) technology to encrypt all traffic to and from the PDU so it is a more secure protocol than HTTP. The PDU supports TLS 1.0, 1.1 and 1.2.

By default, any access to the PDU via HTTP is automatically redirected to HTTPS. You can disable this redirection if needed.

### Changing HTTP or HTTPS Port Settings

- Choose Device Settings > Network Services > HTTP.
- Enable either or both protocols by selecting the corresponding 'Enable' checkbox.

- Type a new port number to use a different port for HTTP or HTTPS.



**CAUTION** Different network services cannot share the same TCP port.

**ATTENTION** Différents services réseau ne peuvent pas partager le même port TCP.

- Select the "Redirect HTTP connections to HTTPS." to redirect the HTTP access to the PDU to HTTPS.
- The redirection checkbox is configurable only when both HTTP and HTTPS have been enabled.

### Regarding AES Ciphers

The PDU's SSL/TLS-based protocols, including HTTPS, support AES 128- and 256-bit ciphers. The exact cipher to use is negotiated between the PDU and the client (such as a web browser), which is impacted by the cipher priority of the PDU and the client's cipher availability/settings.



#### TIP

If intending to force the PDU to use a specific AES cipher, refer to your client's user documentation for information on configuring AES settings. For example, you can enable a cipher and disable the other in the Firefox via the "about:config" command.

### Configuring SNMP Settings

You can enable or disable SNMP communication between an SNMP manager and the PDU. Enabling SNMP communication allows the manager to retrieve and even control the power status of each outlet.

You may need to configure the SNMP destination(s) if the built-in "System SNMP Notification Rule" is enabled and the SNMP destination has not been set yet. For more information, see [Event Rules and Actions](#), on page 120.

- Choose Device Settings > Network Services > SNMP.
- Enable or disable "SNMP v1 / v2c" and/or "SNMP v3" by clicking the corresponding checkbox.
- The SNMP v1/v2c read-only access is enabled by default. The default Read Community String is 'public.'
- Type the Write Community String to enable read-write access. The string is usually 'private.'
  - Enter the MIB-II system group information, if applicable.
- sysContact - the contact person in charge of the system
- sysName - the name assigned to the system
- sysLocation - the location of the system
  - Configure SNMP notifications as follows:
    - a. Select the Enable SNMP Notifications checkbox.
    - b. Select a notification type -- SNMPv2c Trap, SNMPv2c Inform, SNMPv3 Trap, and SNMPv3 Inform.

- c. Specify the SNMP notification destinations and enter necessary information. For more information, see:
- [Configuring SNMPv2c Notifications](#), on page 225.
  - [Configuring SNMPv3 Notifications](#), on page 225.

**NOTE**

Any changes made to the 'SNMP Notifications' section on the SNMP page will update the settings of the System SNMP Notification Action, and vice versa. For more information, see [Available Actions](#), on page 131. Add more than three SNMP destinations by creating new SNMP notification actions. For more information, see [Send an SNMP Notification](#), on page 142.

- You must download the SNMP MIB for your PDU to use with your SNMP manager.

- a. Click the Download MIBs title bar to show the download links.



- b. Click the PDU2-MIB download link. For more information, see [Downloading SNMP MIB](#), on page 226.
- Click **Save**.

## Configuring SMTP Settings

The PDU can be configured to send alerts or event messages to a specific administrator by email. For more information, see [Event Rules and Actions](#), on page 120.

**NOTE**

Before sending emails, you must first configure the SMTP settings and enter an IP address for your SMTP server and a sender's email address.

If any email messages fail to be sent successfully, the failure event and reason are available in the event log. For more information, see [Viewing or Clearing the Local Event Log](#), on page 200.

- Choose Device Settings > Network Services > SMTP Server.
- Enter the information needed.

Field	Description
IP Address/Host Name	Type the name or IP address of the mail server.
Port	Type the port number. <ul style="list-style-type: none"> <li>• Default is 25</li> </ul>
Sender Email Address	Type an email address for the sender.
Number of Sending Retries	Type the number of email retries. <ul style="list-style-type: none"> <li>• Default is 2 retries</li> </ul>

Field	Description
Time Between Sending Retries	Type the interval between email retries in minutes. <ul style="list-style-type: none"> <li>• Default is 2 minutes.</li> </ul>
Server Requires Authentication	Select this checkbox if your SMTP server requires password authentication.
User Name, Password	Type a user name and password for authentication after selecting the above checkbox. <ul style="list-style-type: none"> <li>• The length of user name and password ranges between 4 and 64. Case sensitive.</li> <li>• Spaces are not allowed for the user name, but allowed for the password.</li> </ul>
Enable SMTP over TLS (StartTLS)	If your SMTP server supports the Transport Layer Security (TLS), select this checkbox.

- Settings for the CA Certificate:

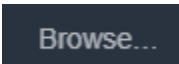
Field or Setting	Description
	Click this button to install a certificate file. Then you can: <ul style="list-style-type: none"> <li>• Click Show to view the certificate's content.</li> <li>• Click Remove to delete the installed certificate if it is inappropriate.</li> </ul>
Allow expired and not yet valid certificates	<ul style="list-style-type: none"> <li>• Select this checkbox to make the authentication succeed regardless of the certificate's validity period.</li> <li>• After deselecting this checkbox, the authentication fails whenever any certificate in the selected certificate chain is outdated or not valid yet.</li> </ul>

- Now that you have set the SMTP settings, you can test it to ensure it works properly.
  - Type the recipient's email address in the Recipient Email Addresses field. Use a comma to separate multiple email addresses.
  - Click **Send Test Email**.
  - Check if the recipient(s) receives the email successfully.
    - Click **Save**.

### Regarding AES Ciphers

The PDU's SSL/TLS-based protocols, including SMTP over StartTLS, support AES 128- and 256-bit ciphers. The exact cipher to use is negotiated between the PDU and the client (such as a web browser), which is impacted by the cipher priority of the PDU and the client's cipher availability/settings.

**TIP**

If intending to force the PDU to use a specific AES cipher, refer to your client's user documentation for information on configuring AES settings.

## Changing SSH Settings

You can enable or disable the SSH access to the command line interface, change the TCP port, or set a password or public key for login over the SSH connection.

- Choose Device Settings > Network Services > SSH.
- Select or clear the checkbox to enable or disable the SSH access.
- Type a port number to use a different port.
- Select one of the authentication methods.
- Password authentication only: Enables the password-based login only.
- Public key authentication only: Enables the public key-based login only.
- Password and public key authentication: Enables both the password- and public key-based login. This is the default.
  - Click **Save**.

If the public key authentication is selected, you must enter a valid SSH public key for each user profile to log in over the SSH connection. For more information, see [Creating Users](#), on page 78.

## Changing Telnet Settings

You can enable or disable the Telnet access to the command line interface, or change the TCP port.

- Choose Device Settings > Network Services > Telnet.
- Select the checkbox to enable Telnet access.
- Type a new port number to use a different port.
- Click **Save**.

## Changing Modbus Settings

You can enable or disable the Modbus/TCP access to your PDU, set it to the read-only mode, or change the TCP port.

- Choose Device Settings > Network Services > Modbus.
- Select the "Modbus/TCP Access" checkbox to enable the Modbus/TCP access.
- Type a new port number to use a different port.
- Select the "Read-only mode" checkbox to enable the Modbus read-only mode. Clear the checkbox to enable the read-write mode instead.
- Click **Save**.

## Changing Service Advertising

For more information about service advertising, refer to Enabling Service Advertising in the Premium+ PDU With RackLink Advanced User Manual at [www.legrandav.com](http://www.legrandav.com).

- Choose Device Settings > Network Services > Service Advertising.
- Select either or both checkboxes to enable service advertising as follows.
- Select the Multicast DNS (MDNS) checkbox to advertise via MDNS.
- Select the Link-Local Multicast Name Resolution (LLMNR) checkbox to advertise via LLMNR.
- Click **Save**.

## Configuring Security Settings

The PDU provides tools to control access. You can enable the internal firewall, create firewall rules, and set login limitations. In addition, you can create and install the certificate or set up external authentication servers for access control.

This product supports the SHA-2 certificate.



### TIP

For information about forcibly redirecting all HTTP accesses to HTTPS, see [Changing HTTP\(S\) Settings](#), on page 95.

### Security

IP Access Control

Role Based Access Control

SSL Certificate

Authentication

Login Settings

Password Policy

Service Agreement

## Creating IP Access Control Rules

IP access control rules (firewall rules) determine whether to accept or discard traffic to/from the PDU, based on the IP address of the host sending or receiving the traffic. When creating rules, keep these principles in mind:

- Rule order is important.  
When traffic reaches or is sent from the PDU, the rules are executed in numerical order. Only the first rule that matches the IP address determines whether the traffic is accepted or discarded. Any subsequent rules matching the IP address are ignored.
- Subnet mask is required.  
When typing the IP address, you must specify BOTH the address and a subnet mask. For example, to specify a single address in a Class C network, use this format:

*x.x.x.x/24*

where /24 = a subnet mask of 255.255.255.0.

Change the subnet mask accordingly to specify an entire subnet or range of addresses.



**NOTE** Valid IPv4 addresses range from 0.0.0.0 through 255.255.255.255.

### Configuring IPv4 Access Control Rules

- Choose Device Settings > Security > IP Access Control.
- Select the Enable IPv4 Access Control checkbox to enable IPv4 access control rules.
- Go to the Inbound Rules section or the Outbound Rules section according to your needs.
- Inbound rules control the data sent to the PDU.
- Outbound rules control the data sent from the PDU.
  - Determine the IPv4 default policy.
- Accept: Accepts traffic from all IPv4 addresses.
- Drop: Discards traffic from all IPv4 addresses, without sending any failure notification to the source host.
- Reject: Discards traffic from all IPv4 addresses, and an ICMP message is sent to the source host for failure notification.
  - Create rules. See the tables for different operations.

#### ADD a rule to the end of the list



- Click **Append**.
- Type an IP address and subnet mask in the IP/Mask field.
- Select an option in the Policy field.
  - Accept: Accepts traffic from/to the specified IP address(es).
  - Drop: Discards traffic from/to the specified IP address(es), without sending any failure notification to the source or destination host.
  - Reject: Discards traffic from/to the specified IP address(es), and an ICMP message is sent to the source or destination host for failure notification.

#### INSERT a rule between two rules

- Select the rule above which you want to insert a new rule. For example, to insert a rule between rules #3 and #4, select #4.
- Click Insert Above.
- Type an IP address and subnet mask in the IP/Mask field.
- Select Accept, Drop or Reject in the Policy field. See the descriptions shown in the previous table.

The system automatically numbers the rule.

- When finished, the rules are listed.

- a. Use the  and  buttons to arrange the order of the rules.
- b. Click  to delete a created rule.
  - Click **Save**.



The rules are applied.

### Configuring IPv6 Access Control Rules

- On the same page, select the Enable IPv6 Access Control checkbox to enable IPv6 access control rules.
- Follow the same procedure as the above IPv4 rule setup to create IPv6 rules.
- Make sure you click the **Save** button in the IPv6 section, or the changes made to IPv6 rules will not be saved.

### Editing or Deleting IP Access Control Rules

When an existing IP access control rule requires updates of IP address range and/or policy, modify them accordingly. Or you can delete any unnecessary rules.

- Choose Device Settings > Security > IP Access Control.
- Go to the IPv4 or IPv6 section.
- Select the desired rule in the list.
- Ensure the IPv4 or IPv6 checkbox has been selected, or you cannot edit or delete any rule.
  - Perform the desired action.
- Make changes to the selected rule, and then click **Save**. For information on each field, see [Creating IP Access Control Rules](#), on page 100.
- Use the  and  buttons to arrange the order of the rules.
- Click  to delete a created rule.
  - Click **Save**.
- IPv4 rules: Make sure you click the **Save** button in the IPv4 section, or the changes made to IPv4 rules are not saved.
- IPv6 rules: Make sure you click the **Save** button in the IPv6 section, or the changes made to IPv6 rules are not saved.

### Creating Role Based Access Control Rules

Role-based access control rules are similar to IP access control rules, except they are applied to members of a specific role. This enables you to grant system permissions to a specific role, based on their IP addresses.

Same as IP access control rules, the order of role-based access control rules is important, since the rules are executed in numerical order.

### Creating IPv4 Role-Based Access Control Rules

- Choose Device Settings > Security > Role Access Control.
- Select the "Enable Role Based Access Control for IPv4" checkbox to enable IPv4 access control rules.
- Determine the IPv4 default policy.
- Accept: Accepts traffic from all IPv4 addresses regardless of the user's role.
- Deny: Drops traffic from all IPv4 addresses regardless of the user's role.
  - Create rules. See the tables for different operations.



#### ADD a rule to the end of the list

- Click Append.
- Type a starting IP address in the Start IP field.
- Type an ending IP address in the End IP field.
- Select a role in the Role field. This rule applies to members of this role only.
- Select an option in the Policy field.
  - Accept: Accepts traffic from the specified IP address range when the user is a member of the specified role
  - Deny: Drops traffic from the specified IP address range when the user is a member of the specified role

#### INSERT a rule between two rules

- Select the rule above where you want to insert a new rule. For example, to insert a rule between rules #3 and #4, select #4.
- Click Insert Above.
- Type a starting IP address in the Start IP field.
- Type an ending IP address in the End IP field.
- Select a role in the Role field. This rule applies to members of this role only.
- Select Allow or Deny in the Policy field. See previous steps for their descriptions.

The system automatically numbers the rule.

- When finished, the rules are listed on this page.
- a. Use the  and  buttons to arrange the order of the rules.
- b. Click  to delete a created rule.
  - Click **Save**.

The rules are applied.



### Creating IPv6 Role-Based Access Control Rules

- On the same page, select the "Enable Role Based Access Control for IPv6" checkbox to enable IPv6 access control rules.
- Follow the same procedure as the above IPv4 rule setup to create IPv6 rules.

- Make sure you click the **Save** button in the IPv6 section, or the changes made to IPv6 rules are not saved.

## Editing or Deleting Role Access Control Rules

You can modify existing rules to update their roles/IP addresses, or delete them when they are no longer needed.

- Choose Device Settings > Security > Role Based Access Control.
- Go to the IPv4 or IPv6 section.
- Select the desired rule in the list.
- Ensure the IPv4 or IPv6 checkbox has been selected, or you cannot select any rule.
  - Perform the desired action.
- Make changes to the selected rule, and then click **Save**. For information on each field, see [Creating Role Based Access Control Rules](#), on page 102.
- Use the  and  buttons to arrange the order of the rules.
- Click  to delete a created rule.
  - Click **Save**.
- IPv4 rules: Make sure you click the **Save** button in the IPv4 section, or the changes made to IPv4 rules are not saved.
- IPv6 rules: Make sure you click the **Save** button in the IPv6 section, or the changes made to IPv6 rules are not saved.

## Setting Up an SSL/TLS Certificate



### CAUTION

The PDU uses TLS instead of SSL 3.0 due to published security vulnerabilities in SSL 3.0. Make sure your network infrastructure, such as mail services, uses TLS rather than SSL 3.0.

### ATTENTION

La PDU utilise TLS au lieu de SSL 3.0 en raison des failles de sécurité publiées dans SSL 3.0. Assurez-vous que votre infrastructure réseau, telle que les services de messagerie, utilise TLS plutôt que SSL 3.0.

Having an X.509 digital certificate ensures that both parties in an SSL/TLS connection are who they say they are.

### Obtaining a New CA-Signed SSL Certificate

- Create a Certificate Signing Request (CSR) on the PDU. For more information, see [Creating a New SSL Certificate Signing Request \(CSR\)](#), on page 105.
- Submit it to a certificate authority (CA). After the CA processes the information in the CSR, it provides you with a certificate.
- Install the CA-signed certificate onto the PDU. For more information, see [Creating a Self-Signed Certificate](#), on page 107.

**NOTE**

If you are using a certificate that is part of a chain of certificates, each part of the chain is signed during the validation process.

**Understanding When a CSR is Not Required**

- If you make the PDU create a *self-signed* certificate. For more information, see [Creating a Self-Signed Certificate](#), on page 107.
- If appropriate, valid certificate and key files are already available, and you just need to install them. For more information, see [Installing or Downloading Existing Certificate and Key](#), on page 109.

**Creating a New SSL Certificate Signing Request (CSR)**

Follow this procedure to create the CSR for your PDU.

**NOTE**

You must enter information in the fields showing the message 'required.'

required

- Choose Device Settings > Security > SSL Certificate.
- Provide the information requested.
- Subject:

Field	Description
Country	The country where your company is located. Use the standard ISO country code. For a list of ISO codes, visit the ISO website at <a href="http://www.iso.org/iso/country_codes/iso_3166_code_lists.htm">http://www.iso.org/iso/country_codes/iso_3166_code_lists.htm</a> .
State or Province	The full name of the state or province where your company is located.
Locality	The city where your company is located.
Organization	The registered name of your company.
Organizational Unit	The name of your department.
Common Name	The fully qualified domain name (FQDN) of your PDU.
Email Address	An email address where you or another administrative user can be reached.

**CAUTION**

If you generate a CSR without values entered in the required fields, you cannot obtain third-party certificates.

**ATTENTION**

Si vous générez une CSR sans que des valeurs aient été saisies dans les champs obligatoires, vous ne pouvez pas obtenir de certificats tiers.

- In the Subject Alternative Names section, enter the host names or IP addresses for which the certificate will be valid.
- Click Add Name to include multiple host names or IP addresses for the certificate.
- Click  to remove a specific host name or IP address for the certificate.

- Key Creation Parameters:

Field	Do this
Key Length	Select an available key length (bits). A larger key length enhances the security, but slows down the PDU's response. <ul style="list-style-type: none"> <li>• Only 2048 is available now.</li> </ul>
Self Sign	For requesting a certificate signed by the CA, ensure this checkbox is NOT selected.
Challenge, Confirm Challenge	Type a password. The password is used to protect the certificate or CSR. This information is optional. The value should be 4 to 64 characters long. Case sensitive.

- Click **Create** New SSL Key to create both the CSR and private key. This may take several minutes to complete.

- Click Download Certificate Signing Request to download the CSR to your computer.
  - You are prompted to open or save the file. Click **Save** to save it onto your computer.
  - Submit it to a CA to obtain the digital certificate.
  - If the CSR contains incorrect data, click Delete Certificate Signing Request to remove it, and then repeat the above steps to re-create it.
    - Click Download Key in the New SSL Certificate section to store the newly created private key on your computer.



#### NOTE



The Download Key button in the Active *SSL Certificate* section is for downloading the private key of the currently installed certificate rather than the newly created one.

- You are prompted to open or save the file. Click **Save** to save it onto your computer.
  - After getting the CA-signed certificate, install it. For more information, see [Uploading a CA-Signed Key and Certificate](#), on page 107.

### Uploading a CA-Signed Key and Certificate

Get a certificate from a certificate authority (CA) by first creating a CSR and sending it to the CA. For more information, see [Creating a New SSL Certificate Signing Request \(CSR\)](#), on page 105.

After receiving the CA-signed certificate, install it onto the PDU.

- Choose Device Settings > Security > SSL Certificate.
- Select the Upload Key and Certificate checkbox.
- Click  to navigate to the Key File.
- Click  to navigate to the CA-signed Certificate File.
- Click Upload to install it.
- Check the data shown in the Active SSL Certificate section to verify whether the certificate has been installed successfully.

**New SSL Certificate**

Subject		Issuer	
Country	US	Country	US
State or Province	NJ	State or Province	NJ
Locality	Fairfield	Locality	Fairfield
Organization	Middle Atlantic Products	Organization	Middle Atlantic Products
Organizational Unit	not set	Organizational Unit	not set
Common Name	not set	Common Name	not set
Email Address	not set	Email Address	not set

**Subject Alternative Names**  
192.168.1.20

**Miscellaneous**

Not Valid Before	Jan 1 19:55:27 2000 GMT
Not Valid After	Jan 11 19:55:27 2000 GMT
Serial Number	F5FC6030E622AA39
Key Length	2048 bits

### Creating a Self-Signed Certificate

When appropriate certificate and key files for the PDU are unavailable, the alternative, other than submitting a CSR to the CA, is to generate a self-signed certificate.



**NOTE** You must enter information in the fields showing the message 'required.'

required

- Choose Device Settings > Security > SSL Certificate.
- Enter information.

Field	Description
Country	The country where your company is located. Use the standard ISO country code. For a list of ISO codes, visit the ISO website at <a href="http://www.iso.org/iso/country_codes/iso_3166_code_lists.htm">http://www.iso.org/iso/country_codes/iso_3166_code_lists.htm</a> .
State or Province	The full name of the state or province where your company is located.

Field	Description
Locality	The city where your company is located.
Organization	The registered name of your company.
Organizational Unit	The name of your department.
Common Name	The fully qualified domain name (FQDN) of your PDU.
Email Address	An email address where you or another administrative user can be reached.
Key Length	Select an available key length (bits). A larger key length enhances the security, but slows down the PDU's response. <ul style="list-style-type: none"> <li>Only 2048 is available now.</li> </ul>
Self Sign	Ensure this checkbox is selected, which indicates that you are creating a self-signed certificate.
Validity in days	This field appears after the Self Sign checkbox is selected. Type the number of days for which the self-signed certificate will be valid.

A password is not required for a self-signed certificate so the Challenge and Confirm Challenge fields disappear.

- Click **Create** New SSL Key to create both the self-signed certificate and private key. This may take several minutes to complete.

**New SSL Certificate**

Subject		Issuer	
Country	US	Country	US
State or Province	NJ	State or Province	NJ
Locality	Fairfield	Locality	Fairfield
Organization	Middle Atlantic Products	Organization	Middle Atlantic Products
Organizational Unit	not set	Organizational Unit	not set
Common Name	not set	Common Name	not set
Email Address	not set	Email Address	not set

**Subject Alternative Names**  
192.168.1.20

**Miscellaneous**

Not Valid Before	Jan 1 19:55:27 2000 GMT
Not Valid After	Jan 11 19:55:27 2000 GMT
Serial Number	F5FC6030E622AA39
Key Length	2048 bits

- Once complete, do the following:
  - Double check the data shown in the New SSL Certificate section.
    - If correct, click "Install Key and Certificate" to install the self-signed certificate and private key.

**TIP**

Check the data shown in the Active SSL Certificate section to verify whether the certificate has been installed successfully.

- If incorrect, click "Delete Key and Certificate" to remove the self-signed certificate and private key, and then repeat the above steps to re-create them.
  - (Optional) Click Download Key or Download Certificate in the New SSL Certificate section to download the self-signed certificate and/or private key.
- You are prompted to open or save the file. Click **Save** to save it onto your computer.

**NOTE**

The Download Key button in the Active SSL Certificate section is for downloading the private key of the currently installed certificate rather than the newly created one.

### Installing or Downloading Existing Certificate and Key

You can download the already-installed certificate and private key from any PDU for backup or file transfer. For example, you can install the files onto a replacement PDU, add the certificate to your browser and so on.

If a valid certificate and private key files are already available, you can install them on the PDU without going through the process of creating a CSR or a self-signed certificate.

**NOTE**

If you are using a certificate that is part of a chain of certificates, each part of the chain is signed during the validation process.

### Downloading Active Key and Certificate Files From Your PDU

- Choose Device Settings > Security > SSL Certificate.
- In the *Active SSL Certificate* section, click Download Key and Download Certificate respectively.

**NOTE**

The Download Key button in the New SSL Certificate section, if present, is for downloading the newly created private key rather than the one of the currently installed certificate.

- You are prompted to open or save the file. Click **Save** to save it onto your computer.

### Installing Available Key and Certificate Files From Your PDU

- Choose Device Settings > Security > SSL Certificate.
- Select the "Upload Key and Certificate" checkbox at the bottom of the New SSL Certificate section of the page.
- The Key File and Certificate File fields appear. Click  to select the key and/or certificate file.
- Click Upload. The selected files are installed.

- Check the data shown in the Active SSL Certificate section to verify whether the certificate has been installed successfully.

New SSL Certificate			
<b>Subject</b>		<b>Issuer</b>	
Country	US	Country	US
State or Province	NJ	State or Province	NJ
Locality	Fairfield	Locality	Fairfield
Organization	Middle Atlantic Products	Organization	Middle Atlantic Products
Organizational Unit	not set	Organizational Unit	not set
Common Name	not set	Common Name	not set
Email Address	not set	Email Address	not set
<b>Subject Alternative Names</b>			
192.168.1.20			
<b>Miscellaneous</b>			
Not Valid Before	Jan 1 19:55:27 2000 GMT		
Not Valid After	Jan 11 19:55:27 2000 GMT		
Serial Number	F5FC6030E622AA39		
Key Length	2048 bits		
<input type="button" value="Install Key and Certificate"/>		<input type="button" value="Download Key"/>	
<input type="button" value="Download Certificate"/>		<input type="button" value="Delete Key and Certificate"/>	

## Configuring Authentication



### CAUTION

The PDU uses TLS instead of SSL 3.0 due to published security vulnerabilities in SSL 3.0. Make sure your network infrastructure, such as LDAP and mail services, uses TLS rather than SSL 3.0.

### ATTENTION

La PDU utilise TLS au lieu de SSL 3.0 en raison des failles de sécurité publiées dans SSL 3.0. Assurez-vous que votre infrastructure réseau, telle que LDAP et les services de messagerie, utilise TLS plutôt que SSL 3.0.

For security purposes, users attempting to log in to the PDU must be authenticated. The PDU supports the following authentication mechanisms:

- Local user database on the PDU
- Lightweight Directory Access Protocol (LDAP)
- Remote Access Dial-In User Service (Radius) protocol

By default, the PDU is configured for local authentication. If you stay with this method, you only need to create user accounts. For more information, see [Creating Users](#), on page 78.

If you prefer external authentication, you must provide the PDU with information about the external Authentication, Authorization, and Accounting (AAA) server.

If both local and external authentication is needed, create user accounts on the PDU in addition to providing the external AAA server data.

When configured for external authentication, all users must have an account on the external AAA server. Local-authentication-only users will have no access to the PDU except for the admin, who always can access the PDU.

If the external authentication fails, an "Authentication failed" message is displayed. Details regarding the authentication failure are available in the event log. For more information, see [Viewing or Clearing the Local Event Log](#), on page 200.

**NOTE**

Only users who have both the "Change Authentication Settings" and "Change Security Settings" permissions can configure or modify the authentication settings.

**Enabling External Authentication**

- Collect external AAA server information. For more information, see [Gathering LDAP/Radius Information](#), on page 111.
- Enter required data for external AAA server(s) on the PDU. For more information, see [Adding LDAP Servers](#), on page 112 or [Adding RADIUS Servers](#), on page 115.
- If both the external and local authentication is needed, or you have to return to the local authentication only, see [Managing External Authentication Settings](#), on page 116.

**About the AEC Cipher**

The PDU's SSL/TLS-based protocols, including LDAPS, support AES 128- and 256-bit ciphers. The exact cipher to use is negotiated between the PDU and the client (such as a web browser), which is impacted by the cipher priority of the PDU and the client's cipher availability/settings.

**TIP**

If intending to force the PDU to use a specific AES cipher, refer to your client's user documentation for information on configuring AES settings.

**Gathering LDAP/Radius Information**

It requires knowledge of your AAA server settings to configure the PDU for external authentication. If you are not familiar with these settings, consult your AAA server administrator for help.

**Information Needed for LDAP Authentication:**

- The IP address or hostname of the LDAP server
- Whether the Secure LDAP protocol (LDAP over TLS) is being used
  - If Secure LDAP is in use, consult your LDAP administrator for the CA certificate file.
- The network port used by the LDAP server
- The type of the LDAP server, usually one of the following options:
  - *OpenLDAP*
  - If using an OpenLDAP server, consult the LDAP administrator for the Bind Distinguished Name (DN) and password.
  - *Microsoft Active Directory® (AD)*
  - If using a Microsoft Active Directory server, consult your AD administrator for the name of the Active Directory Domain.
- Bind Distinguished Name (DN) and password (if anonymous bind is NOT used)
- The Base DN of the server (used for searching for users)

- The login name attribute (or AuthorizationString)
- The user entry object class
- The user search subfilter (or BaseSearch)

**Information Needed for Radius Authentication:**

- The IP address or host name of the Radius server
- Authentication protocol used by the Radius server
- Shared secret for a secure communication
- UDP authentication port and accounting port used by the Radius server

**Configuring Authentication Settings**

- Choose Device Settings > Security > Authentication.
- In the Authentication Type drop-down, select one of the following options:
  - Local (selecting Local disables external authentication)
  - LDAP
  - Radius
- Select the Use Local Authentication if Remote Authentication is not available checkbox if desired.

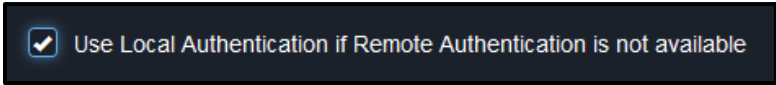

**NOTE** This enables both external and local authentication. When selected, the PDU always tries external authentication first. Whenever the external authentication fails, the PDU then switches to local authentication.

- Click **Save**.

**Adding LDAP Servers**

- Choose Device Settings > Security > Authentication.
- Click New in the LDAP Servers section.
- Enter information.

**NOTE** You must enter information in the fields showing the message 'required.'

required

Field or Setting	Description
IP Address / Hostname	The IP address or hostname of your LDAP/LDAPS server. Note: Without the encryption enabled, you can type either the domain name or IP address in this field, but you must type the fully qualified domain name if the encryption is enabled.
Copy settings from existing LDAP server	This checkbox appears only when there are existing AAA server settings on the PDU. See the duplicating procedure below to duplicate any existing AAA server settings.

Field or Setting	Description
Type of LDAP Server	Choose one of the following options: <ul style="list-style-type: none"> <li>• OpenLDAP</li> <li>• Microsoft Active Directory. Active Directory is an implementation of LDAP/LDAPS directory services by Microsoft for use in Windows environments.</li> </ul>
Security	Determine whether you would like to use Transport Layer Security (TLS) encryption, which allows the PDU to communicate securely with the LDAPS server. Three options are available: <ul style="list-style-type: none"> <li>• StartTLS</li> <li>• TLS</li> <li>• None</li> </ul>
Port (None/StartTLS)	The default Port is 389. Either use the standard LDAP TCP port or specify another port.
Port (TLS)	<b>Configurable only when "TLS" is selected in the Security field.</b> The default is 636. Either use the default port or specify another one.
Enable verification of LDAP Server Certificate	Select this checkbox if it is required to validate the LDAP server's certificate by the PDU prior to the connection. If the certificate validation fails, the connection is refused.
CA Certificate	<ul style="list-style-type: none"> <li>• Consult your AAA server administrator to get the CA certificate file for the LDAPS server.</li> <li>• Click  to select and install the certificate file.</li> <li>• Click Show to view the installed certificate's content.</li> <li>• Click Remove to delete the installed certificate if it is inappropriate.</li> </ul>
Allow expired and not yet valid certificates	<ul style="list-style-type: none"> <li>• Select this checkbox to make the authentication succeed regardless of the certificate's validity period.</li> <li>• After deselecting this checkbox, the authentication fails whenever any certificate in the selected certificate chain is outdated or not valid yet.</li> </ul>
Anonymous Bind	Use this checkbox to enable or disable anonymous bind. <ul style="list-style-type: none"> <li>• Select this checkbox to use anonymous bind.</li> <li>• When a Bind DN and password are required to bind to the external LDAP/LDAPS server, deselect this checkbox.</li> </ul>
Bind DN	<b>Required after deselecting the Anonymous Bind checkbox.</b> Distinguished Name (DN) of the user who is permitted to search the LDAP directory in the defined search base.

Field or Setting	Description
Bind Password, Confirm Bind Password	<b>Required after deselecting the Anonymous Bind checkbox.</b> Enter the Bind password.
Base DN for Search	Distinguished Name (DN) of the search base, which is the starting point of the LDAP search. <ul style="list-style-type: none"> <li>• Example: <code>ou=dev,dc=example,dc=com</code></li> </ul>
Login Name Attribute	The attribute of the LDAP user class which denotes the login name. <ul style="list-style-type: none"> <li>• Usually it is the <code>uid</code>.</li> </ul>
User Entry Object Class	The object class for user entries. <ul style="list-style-type: none"> <li>• Usually it is <code>inetOrgPerson</code>.</li> </ul>
User Search Subfilter	Search criteria for finding LDAP user objects within the directory tree.
Active Directory Domain	The name of the Active Directory Domain. <ul style="list-style-type: none"> <li>• Example: <code>testradius.com</code></li> </ul>

- Click Test Connection to verify if the authentication configuration is set correctly and check whether the PDU can connect to the new server successfully.

**TIP**

You can also test the connection on the Authentication page after finishing adding servers. For more information, see [Managing External Authentication Settings](#), on page 116.

- Click Add Server. The new LDAP server is listed on the Authentication page.
- Repeat the same steps to add more servers.
- In the Authentication Type field, select LDAP. Otherwise, the LDAP authentication does not work.
- Click **Save**. The LDAP authentication is now in place.

**Duplicating LDAP Server Settings**

If you have added any LDAP/LDAPS server to the PDU, and the server you will add shares identical settings with an existing one, the most convenient way is to duplicate that LDAP/LDAPS server's data and then revise the IP address/host name.

- Repeat Steps 1 to 2 in the above procedure.
- Select the "Copy settings from existing LDAP server" checkbox.
- Click the "Select LDAP Server" field to select the LDAP/LDAPS server whose settings you want to copy.

**NOTE**

The Copy settings from existing LDAP server and Select LDAP Server fields only appear after at least one LDAP server is already created.

- Modify the IP Address/Hostname field.
- Click Add Server.

**NOTE**

If the PDU clock and the LDAP server clock are out of sync, the installed TLS certificates, if any, may be considered expired. Administrators should configure the PDU and the LDAP server to use the same NTP server(s) in order to ensure proper synchronization.

**Adding RADIUS Servers**

- Choose Device Settings > Security > Authentication.
- Click New in the Radius section.
- Enter information.

**NOTE**

You must enter information in the fields showing the message 'required.'

required

Field or Setting	Description
IP Address / Hostname	The IP address or hostname of your Radius server.
Type of RADIUS Authentication	Select an authentication protocol. <ul style="list-style-type: none"> <li>• PAP (Password Authentication Protocol)</li> <li>• CHAP (Challenge Handshake Authentication Protocol)</li> <li>• MS-CHAPv2 (Microsoft version of the Challenge-Handshake Authentication Protocol)</li> </ul> CHAP is generally considered more secure because the user name and password are encrypted, while in PAP they are transmitted in the clear.
Authentication Port, Accounting Port	The default are standard ports -- 1812 and 1813. Type a new port number to use non-standard ports.
Timeout	This sets the maximum amount of time to establish contact with the Radius server before timing out. Type the timeout period in seconds.
Retries	Type the number of retries.
Shared Secret, Confirm Shared Secret	The shared secret is necessary to protect communication with the Radius server.

- Click Test Connection to verify if the authentication configuration is set correctly and check whether the PDU can connect to the new server successfully.

**TIP**

You can also test the connection on the Authentication page after finishing adding servers. For more information, see [Managing External Authentication Settings](#), on page 116.

- Click Add Server. The new Radius server is listed on the Authentication page.
- Repeat the same steps to add more servers.
- In the Authentication Type field, select Radius. Otherwise, the Radius authentication does not work.
- Click **Save**. Radius authentication is now in place.

**Managing External Authentication Settings**



Choose Device Settings > Security > Authentication to open the Authentication page, where you can:

- Enable both the external and local authentication
- Edit or delete a server
- Sort the access order of servers
- Test the connection to a server
- Disable external authentication without removing servers

**Testing, Editing, or Deleting a Server, or Sorting a Server List**

- Choose Device Settings > Security > Authentication.
- Select a server from either LDAP or RADIUS lists.

Access Order	IP Address / Hostname	Security	Port	LDAP Server Type
1	192.168.91.100	StartTLS	389	OpenLDAP
2	192.168.1.33	StartTLS	389	OpenLDAP
3	192.168.8.95	StartTLS	389	OpenLDAP
4	192.168.2.25	None	389	Microsoft Active Directory

- Perform the desired action.
- Click Edit to edit its settings, and click Modify Server to save changes. For information on each field, see [Adding LDAP Servers](#), on page 112 or [Adding RADIUS Servers](#), on page 115.
- Click Delete to delete the server, and then confirm the operation.
- Click Test Connection to test the connection to the selected server. User credentials may be required.
- Click  or  to change the server order, which determines the access priority, and click **Save Order** to save the new sequence.

**NOTE**

Whenever the PDU is successfully connected to one external authentication server, it STOPS trying to access the remaining servers in the authentication list regardless of the user authentication result.

**Configuring Login Settings**

Choose Device Settings > Security > Login Settings to open the Login Settings page, where you can:

- Configure the user blocking feature.

**NOTE**

The user blocking function applies only to local authentication instead of external authentication through AAA servers.

- Determine the timeout period for any inactive user.
- Prevent simultaneous logins using the same login name.

**Configuring User Blocking**

- Choose Device Settings > Security > Login Settings.
- Select the "Block user on login failure" checkbox to enable the user blocking feature.
- In the "Block timeout" field, type a value or click  to select a time option. This setting determines how long the user is blocked.
- If you type a value, the value must be followed by a time unit, such as '4 min.' For more information, see [Understanding Time Units](#), on page 220.
  - In the "Maximum number of failed logins" field, type a number. This is the maximum number of login failure the user is permitted before the user is blocked from accessing the PDU.
  - Click **Save**.

**TIP**

If any user blocking event occurs, you can unblock that user manually by using the "unblock" CLI command over a local connection. Refer to Unblocking a User in the Premium+ PDU With RackLink Advanced User Manual at [www.legrandav.com](http://www.legrandav.com).

**Setting Login Timeout and Use of Identical Login Names**

- Choose Device Settings > Security > Login Settings.
- In the "Idle timeout period" field, type a value or click  to select a time option. This setting determines how long users are permitted to stay idle before being forced to log out.
- If you type a value, the value must be followed by a time unit, such as '4 min.' See [Time Units](#), on page 220.
- Keep the idle timeout to 20 minutes or less if possible. This reduces the number of idle sessions connected, and the number of simultaneous commands sent to the PDU.
  - Select the "Prevent concurrent login with same username" checkbox if intending to prevent multiple persons from using the same login name simultaneously.
  - Click **Save**.

**Configuring Password Policy**

- Choose Device Settings > Security > Password Policy
- The Password Policy page appears.
- Configure the following:

- Force users to change passwords at a regular interval using the password aging setting.
- Force users to use strong passwords.

Use of strong passwords makes it more difficult for intruders to crack user passwords and access the PDU.

### Configuring Password Aging

- Choose Device Settings > Security > Password Policy
- The Password Policy page appears.
- Select the 'Enabled' checkbox of Password Aging.
- In the Password Aging Interval field, type a value or click  to select a time option. This setting determines how often users are requested to change their passwords.
- If you type a value, the value must be followed by a time unit, such as '10 d.' For more information, see [Understanding Time Units](#), on page 220.
  - Click **Save**.

### Configuring Strong Password Settings

- Choose Device Settings > Security > Password Policy
- The Password Policy page appears.
- Select the 'Enabled' checkbox of Strong Passwords to activate the strong password feature.
- Configure the following fields from their default settings as desired:

Field	Description
Minimum Password Length	The default is 8 characters. Change the minimum password character length as desired.
Maximum Password Length	The default is 32 characters. Change the maximum password character length as desired.
	 <b>NOTE</b> The maximum password length accepted by the PDU is 64 characters.
Enforce at least one lower case character	This field is selected by default.
Enforce at least one upper case character	This field is selected by default.
Enforce at least one numeric character	This field is selected by default.
Enforce at least one special character	This field is selected by default.

Field	Description
Password History Size	The default is 5 previous passwords allowed. Change the history size as desired.

- Click **Save**.

## Enabling the Restricted Service Agreement

The restricted service agreement feature, if enabled, forces users to read a security agreement when they log in to the PDU.

Users must accept the agreement, or they cannot log in.

An event notifying you if a user has accepted or declined the agreement can be generated. For more information, see [Default Log Messages](#), on page 125.

- Click Device Settings > Security > Service Agreement.
- Select the Enforce Restricted Service Agreement checkbox.
- Edit or paste the content as needed.
- A maximum of 10,000 characters can be entered.
- Click **Save**.

## Understanding the Login Manner After Enabling the Service Agreement

After the Restricted Service Agreement feature is enabled, the agreement's content is displayed in the login screen.

Do either of the following, or the login fails:

- In the web interface, select the checkbox labeled "I understand and accept the Restricted Service Agreement."



### TIP

Press Tab to enable the checkbox and then Enter to select the agreement checkbox using the keyboard.

- In the CLI, type `y` when the confirmation message "I understand and accept the Restricted Service Agreement" is displayed.

## Setting the Date and Time

Set the internal clock on the PDU manually, or link to a Network Time Protocol (NTP) server.

- Choose Device Settings > Date/Time.
- Click the Time Zone field to select your time zone from the list.
- If the daylight saving time applies to your time zone, verify the Automatic Daylight Saving Time Adjustment checkbox is selected.
- If the daylight saving time rules are not available for the selected time zone, the checkbox is not configurable.
  - Select the method for setting the date and time.

### Use the NTP server



- Select "Synchronize with NTP Server."
- There are two ways to assign the NTP servers:
  - DO NOT enter any NTP servers for the First and Second NTP Server to use the DHCP-assigned NTP servers.

DHCP-assigned NTP servers are available only when either IPv4 or IPv6 DHCP is enabled.

- Specify the primary NTP server in the First Time Server field to use manually specified NTP servers. A secondary NTP server is optional.

Click Check NTP Servers to verify the validity and accessibility of the manually specified NTP servers.

### Customize the date and time

- Select User Specified Time.
- Type values in the Date field using the yyyy-mm-dd format, or click  to select a date.
  - Use arrows to switch between months.
  - Click on a calendar day (0-31) to select the specific day.
  - Click the Today button to select the current date.
  - Click the Clear button to remove any existing date entry in the Date field.
  - Click Close to close the calendar and return to the Date field.
- Type values in the Time field using the hh:mm:ss format, or click   to adjust values.
  - The time is measured in 12-hour format so you must correctly specify AM or PM by clicking the AM or PM button.



- Click **Save**.

The PDU follows the NTP server sanity check per the IETF RFC. If your PDU has problems synchronizing with a Windows NTP server, refer to Windows NTP Server Synchronization Solution in the Premium+ PDU With RackLink Advanced User Manual at [www.legrandav.com](http://www.legrandav.com).

## Event Rules and Actions

A benefit of the product's intelligence is its ability to notify you of or react to a change in conditions. This event notification or reaction is an "event rule."

An event rule consists of two parts:

- **Event:** This is the situation where the PDU or a device connected to it meets a certain condition. For example, the inlet's voltage reaches the warning level.
- **Action:** This is the response to the event. For example, the PDU notifies the system administrator of the event via email.

If you want the PDU to perform one action at a regular interval instead of waiting until an event occurs, you can schedule that action. For example, you can make the PDU email the temperature report every hour.

**NOTE**

You need Administrator Privileges to configure event rules.

### Creating an Event Rule With an Action

- Choose Device Settings > Event Rules.
- If the needed action is not available yet, create it by clicking **+ New Action**.
  - a. Assign a name to this action.
  - b. Select the desired action and configure it as needed.
  - c. Click **Create**.

For more information, see [Available Actions](#), on page 131.

- Click **+ New Rule** to create a new rule.
  - a. Assign a name to this rule.
  - b. Make sure the Enabled checkbox is selected, or the new event rule does not work.
  - c. In the Event field, select the event to which you want the PDU to react.
  - d. In the Available Actions field, select the desired action(s) to respond to the selected event.
  - e. Click **Create**.

For more information, see [Built-in Rules and Rule Configuration](#), on page 122.

### Creating a Scheduled Action

- If the needed action is not available yet, create it by clicking **+ New Action**. For more information, see the previous topic.

**NOTE**

When creating scheduled actions, available actions are less than usual because it is meaningless to schedule certain actions like "Alarm," "Log event message," "Send email," "Syslog message" and the like.

- Click **+ New Scheduled Action** to schedule the desired action.
  - a. Assign a name to this scheduled action.
  - b. Make sure the Enabled checkbox is selected, or the PDU does not perform this scheduled action.
  - c. Set the interval time, which ranges from every minute to yearly.
  - d. In the Available Actions field, select the desired action(s).
  - e. Click **Create**.

For more information, see [Scheduling an Action](#), on page 147.

## Built-in Rules and Rule Configuration

The PDU is shipped with four built-in event rules, which cannot be deleted. If the built-in event rules do not satisfy your needs, you can always create new rules.

- *System Event Log Rule:*

This causes ANY event occurred to the PDU to be recorded in the internal log. It is enabled by default.

**NOTE**

For the default log messages generated for each event, see [Default Log Messages](#), on page 125.

- *System SNMP Notification Rule:*

This causes SNMP traps or informs to be sent to specified IP addresses or hosts when ANY event occurs to the PDU. It is disabled by default.

### An Event Rule Configuration Example

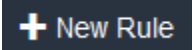
- Choose Device Settings > Event Rules >  .
- Click the Event field to select an event type.
- <Any sub-event> means all events shown on the list.
- <Any Numeric Sensor> means all numeric sensors of the PDU, including internal and environmental sensors.
- <Any Numeric Sensor> is especially useful if you want to receive the notifications when any numeric sensor's readings pass through a specific threshold.
  - In this example, the Peripheral Device Slot is selected, which is related to the environmental sensor packages. Then a sensor ID field for this event type appears. Click this additional field to specify which sensor should be the subject of this event.
  - In this example, sensor ID 2 (Slot 2) is selected, which is a temperature sensor. Then a new field for this sensor appears. Click this field to specify the type of event(s) you want.
  - In this example, Numeric Sensor is selected because we want to select numeric-sensor-related event(s). Then a field for numeric-sensor-related events appears. Click this field to select one of the numeric-sensor-related events from the list.
  - In this example, 'Above upper critical threshold' is selected because we want the PDU to react only when the selected temperature sensor's reading enters the upper critical range.

- A "Trigger condition" field appears, requiring you to define the "exact" condition related to the "upper critical" event.

- Select the desired radio button to finish the event configuration. Refer to the following table for different types of radio buttons.
- If needed, you may refer to event rule examples in the section titled [Sample Event Rules](#), on page 152.
  - Select actions one by one, if desired, from the Available Actions list.
- Click Select All to select all available actions.
  - Click the action's button to remove it from the Selected Actions field.
- Click Deselect All to remove all actions.

### Understanding Radio Button Selections for Different Events

According to the event you select, the "Trigger condition" field containing three radio buttons may or may not appear.

Event types	Radio buttons
Numeric sensor threshold-crossing events, or the occurrence of the selected event -- true or false	Available radio buttons include "Asserted," "Deasserted" and "Both." <ul style="list-style-type: none"> <li>● Asserted: The PDU takes the action only when the selected event occurs. That is, the status of the event transits from FALSE to TRUE.</li> <li>● Deasserted: The PDU takes the action only when the selected event disappears or stops. That is, the status of the selected event transits from TRUE to FALSE.</li> <li>● Both: The PDU takes the action both when the event occurs (asserts) and when the event stops/disappears (deasserts).</li> </ul>

Event types	Radio buttons
State sensor state change	<p>Available radio buttons include "Alarmed/Open/On," "No longer alarmed/Closed/Off" and "Both."</p> <ul style="list-style-type: none"> <li>• Alarmed/Open/On: The PDU takes the action only when the chosen sensor enters the alarmed, open or on state.</li> <li>• No longer alarmed/Closed/Off: The PDU takes the action only when the chosen sensor returns to the normal, closed, or off state.</li> <li>• Both: The PDU takes the action whenever the chosen sensor switches its state.</li> </ul>
Sensor availability	<p>Available radio buttons include "Unavailable," "Available" and "Both."</p> <ul style="list-style-type: none"> <li>• Unavailable: The PDU takes the action only when the chosen sensor is NOT detected and becomes unavailable.</li> <li>• Available: The PDU takes the action only when the chosen sensor is detected and becomes available.</li> <li>• Both: The PDU takes the action both when the chosen sensor becomes unavailable or available.</li> </ul>
Network interface link state	<ul style="list-style-type: none"> <li>• Link state is up: The PDU takes the action only when the network link state changes from down to up.</li> <li>• Link state is down: The PDU takes the action only when the network link state changes from up to down.</li> <li>• Both: The PDU takes the action whenever the network link state changes.</li> </ul>
Function enabled or disabled	<ul style="list-style-type: none"> <li>• Enabled: The PDU takes the action only when the chosen function is enabled.</li> <li>• Disabled: The PDU takes the action only when the chosen function is disabled.</li> <li>• Both: The PDU takes the action when the chosen function is either enabled or disabled.</li> </ul>
Restricted service agreement	<ul style="list-style-type: none"> <li>• Accepted: The PDU takes the action only when the specified user accepts the restricted service agreement.</li> <li>• Declined: The PDU takes the action only when the specified user rejects the restricted service agreement.</li> <li>• Both: The PDU takes the action both when the specified user accepts or rejects the restricted service agreement.</li> </ul>

Event types	Radio buttons
Component monitoring event	<ul style="list-style-type: none"> <li>Monitoring started: The PDU takes the action only when the monitoring of any specified component starts.</li> <li>Monitoring stopped: The PDU takes the action only when the monitoring of any specified component stops.</li> <li>Both: The PDU takes the action when the monitoring of any specified component starts or stops.</li> </ul>
Component reachability	<ul style="list-style-type: none"> <li>Unreachable: The PDU takes the action only when any specified component becomes inaccessible.</li> <li>Reachable: The PDU takes the action only when any specified component becomes accessible.</li> <li>Both: The PDU takes the action when any specified component becomes either inaccessible or accessible.</li> </ul>
+12V Supply 1 Status	<p>Available radio buttons include "Fault," "Ok" and "Both."</p> <ul style="list-style-type: none"> <li>Fault: The PDU takes the action only when the selected 12V power supply to the controller enters the fault state.</li> <li>Ok: The PDU takes the action only when the selected 12V power supply to the controller enters the OK state.</li> <li>Both: The PDU takes the action whenever the selected 12 power supply's status changes.</li> </ul>

### Default Log Messages

Following are default log messages recorded internally and emailed to specified recipients when PDU events occur (are TRUE) or, in some cases, stop or become unavailable (are FALSE). For more information, see [Creating a Send Email Action](#), on page 137 for information configuring email messages to be sent when specified events occur.

Event/context	Default message when the event = TRUE	Default message when the event = FALSE
Device > System started	System started.	
Device > System reset	System reset performed by user '[USERNAME]' from host '[USERIP]'.	
Device > Firmware validation failed	Firmware validation failed by user '[USERNAME]' from host '[USERIP]'.	
Device > Firmware update started	Firmware upgrade started from version '[OLDVERSION]' to version '[VERSION]' by user '[USERNAME]' from host '[USERIP]'.	

Event/context	Default message when the event = TRUE	Default message when the event = FALSE
Device > Firmware update completed	Firmware upgraded successfully from version '[OLDVERSION]' to version '[VERSION]' by user '[USERNAME]' from host '[USERIP]'.	
Device > Firmware update failed	Firmware upgrade failed from version '[OLDVERSION]' to version '[VERSION]' by user '[USERNAME]' from host '[USERIP]'.	
Device > Hardware failure present	Failure '[FAILURETYPESTR]' asserted for component '[COMPONENTID]'.	Failure '[FAILURETYPESTR]' deasserted for component '[COMPONENTID]'.
Device > Device identification changed	Config parameter '[PARAMETER]' changed to '[VALUE]' by user '[USERNAME]' from host '[USERIP]'.	
Device > Device settings saved	Device settings saved from host '[USERIP]'.	
Device > Device settings restored	Device settings restored from host '[USERIP]'.	
Device > Data push failed	Data push to URL [DATAPUSH_URL] failed. [ERRORDESC].	
Device > Event log cleared	Event log cleared by user '[USERNAME]' from host '[USERIP]'.	
Device > Bulk configuration saved	Bulk configuration saved from host '[USERIP]'.	
Device > Bulk configuration copied	Bulk configuration copied from host '[USERIP]'.	
Device > Network interface link state is up	The [IFNAME] network interface link is now up.	The [IFNAME] network interface link is now down.
Device > Peripheral Device Firmware Update	Firmware update for peripheral device [EXTSENSORSERIAL] from [OLDVERSION] to [VERSION] [SENSORSTATENAME].	

Event/context	Default message when the event = TRUE	Default message when the event = FALSE
Device > Sending SMTP message failed	Sending SMTP message to '[RECIPIENTS]' using server '[SERVER]' failed.	
Device > Sending SNMP inform failed or no response	Sending SNMP inform to manager [SNMPMANAGER]:[SNMPMANAGERPORT] failed or no response. [ERRORDESC].	
Device > Sending Syslog message failed	Sending Syslog message to server [SYSLOGSERVER]:[SYSLOGPORT] ([SYSLOGTRANSPORTPROTO]) failed. [ERRORDESC].	
Device > Sending SMS message failed	Sending SMS message to '[PHONENUMBER]' failed.	
Device > Unknown peripheral device attached	An unknown peripheral device with rom code '[ROMCODE]' was attached at position '[PERIPHDEVPOSITION]'.	
Device > USB slave connected	USB slave connected.	USB slave disconnected.
Device > WLAN authentication over TLS with incorrect system clock	Established connection to wireless network '[SSID]' via Access Point with BSSID '[BSSID]' using '[AUTHPROTO]' authentication with incorrect system clock.	
Peripheral Device Slot > * > Numeric Sensor > Unavailable	Peripheral device '[EXTSENSORNAME]' in slot '[EXTSENSORSLOT]' unavailable.	Peripheral device '[EXTSENSORNAME]' in slot '[EXTSENSORSLOT]' available.
Peripheral Device Slot > * > Numeric Sensor > Above upper critical threshold	Peripheral device '[EXTSENSORNAME]' in slot '[EXTSENSORSLOT]' asserted 'above upper critical' at [READING].	Peripheral device '[EXTSENSORNAME]' in slot '[EXTSENSORSLOT]' deasserted 'above upper critical' at [READING].
Peripheral Device Slot > * > Numeric Sensor > Above upper warning threshold	Peripheral device '[EXTSENSORNAME]' in slot '[EXTSENSORSLOT]' asserted 'above upper warning' at [READING].	Peripheral device '[EXTSENSORNAME]' in slot '[EXTSENSORSLOT]' deasserted 'above upper warning' at [READING].

Event/context	Default message when the event = TRUE	Default message when the event = FALSE
Peripheral Device Slot > * > Numeric Sensor > Below lower warning threshold	Peripheral device '[EXTSENSORNAME]' in slot '[EXTSENSORSLOT]' asserted 'below lower warning' at [READING].	Peripheral device '[EXTSENSORNAME]' in slot '[EXTSENSORSLOT]' deasserted 'below lower warning' at [READING].
Peripheral Device Slot > * > Numeric Sensor > Below lower critical threshold	Peripheral device '[EXTSENSORNAME]' in slot '[EXTSENSORSLOT]' asserted 'below lower critical' at [READING].	Peripheral device '[EXTSENSORNAME]' in slot '[EXTSENSORSLOT]' deasserted 'below lower critical' at [READING].
Peripheral Device Slot > * > State Sensor/Dry Contact > Unavailable	Peripheral device '[EXTSENSORNAME]' in slot '[EXTSENSORSLOT]' unavailable.	Peripheral device '[EXTSENSORNAME]' in slot '[EXTSENSORSLOT]' available.
Peripheral Device Slot > * > State Sensor/Dry Contact > Alarmed/Open/On	Peripheral device '[EXTSENSORNAME]' in slot [EXTSENSORSLOT] is [SENSORSTATENAME].	Peripheral device '[EXTSENSORNAME]' in slot [EXTSENSORSLOT] is [SENSORSTATENAME].
Inlet > * > Enabled	Inlet '[INLET]' has been enabled by user '[USERNAME]' from host '[USERIP]'.	Inlet '[INLET]' has been disabled by user '[USERNAME]' from host '[USERIP]'.
Inlet > * > Sensor > * > Unavailable	Sensor '[INLETSENSOR]' on inlet '[INLET]' unavailable.	Sensor '[INLETSENSOR]' on inlet '[INLET]' available.
Inlet > * > Sensor > * > Above upper critical threshold	Sensor '[INLETSENSOR]' on inlet '[INLET]' asserted 'above upper critical'.	Sensor '[INLETSENSOR]' on inlet '[INLET]' deasserted 'above upper critical'.
Inlet > * > Sensor > * > Above upper warning threshold	Sensor '[INLETSENSOR]' on inlet '[INLET]' asserted 'above upper warning'.	Sensor '[INLETSENSOR]' on inlet '[INLET]' deasserted 'above upper warning'.
Inlet > * > Sensor > * > Below lower warning threshold	Sensor '[INLETSENSOR]' on inlet '[INLET]' asserted 'below lower warning'.	Sensor '[INLETSENSOR]' on inlet '[INLET]' deasserted 'below lower warning'.
Inlet > * > Sensor > * > Below lower critical threshold	Sensor '[INLETSENSOR]' on inlet '[INLET]' asserted 'below lower critical'.	Sensor '[INLETSENSOR]' on inlet '[INLET]' deasserted 'below lower critical'.
Inlet > * > Sensor > Active Energy > Reset	Sensor '[INLETSENSOR]' on inlet '[INLET]' has been reset by user '[USERNAME]' from host '[USERIP]'.	

Event/context	Default message when the event = TRUE	Default message when the event = FALSE
Outlet > * > Power control > Powered on	Outlet '[OUTLET]' has been powered on by user '[USERNAME]' from host '[USERIP]'.	
Outlet > * > Power control > Powered off	Outlet '[OUTLET]' has been powered off by user '[USERNAME]' from host '[USERIP]'.	
Outlet > * > Power control > Power cycled	Outlet '[OUTLET]' power cycle initiated by user '[USERNAME]' from host '[USERIP]'.	
Outlet > * > Sensor > * > Unavailable	Sensor '[OUTLETSENSOR]' on outlet '[OUTLET]' unavailable.	Sensor '[OUTLETSENSOR]' on outlet '[OUTLET]' available.
Outlet > * > Sensor > * > Above upper critical threshold	Sensor '[OUTLETSENSOR]' on outlet '[OUTLET]' asserted 'above upper critical'.	Sensor '[OUTLETSENSOR]' on outlet '[OUTLET]' deasserted 'above upper critical'.
Outlet > * > Sensor > * > Above upper warning threshold	Sensor '[OUTLETSENSOR]' on outlet '[OUTLET]' asserted 'above upper warning'.	Sensor '[OUTLETSENSOR]' on outlet '[OUTLET]' deasserted 'above upper warning'.
Outlet > * > Sensor > * > Below lower warning threshold	Sensor '[OUTLETSENSOR]' on outlet '[OUTLET]' asserted 'below lower warning'.	Sensor '[OUTLETSENSOR]' on outlet '[OUTLET]' deasserted 'below lower warning'.
Outlet > * > Sensor > * > Below lower critical threshold	Sensor '[OUTLETSENSOR]' on outlet '[OUTLET]' asserted 'below lower critical'.	Sensor '[OUTLETSENSOR]' on outlet '[OUTLET]' deasserted 'below lower critical'.
Outlet > * > Sensor > Active Energy > Reset	Sensor '[OUTLETSENSOR]' on outlet '[OUTLET]' has been reset by user '[USERNAME]' from host '[USERIP]'.	
Outlet > * > Sensor > Outlet State > On	Outlet '[OUTLET]' state changed to on.	Outlet '[OUTLET]' state changed to off.
Outlet > * > Pole > * > Sensor > Unavailable	Sensor '[POLESENSOR]' on pole '[OUTLETPOLE]' of outlet '[OUTLET]' unavailable.	Sensor '[POLESENSOR]' on pole '[OUTLETPOLE]' of outlet '[OUTLET]' available.
Outlet > * > Pole > * > Sensor > Above upper critical threshold	Sensor '[POLESENSOR]' on pole '[OUTLETPOLE]' of outlet '[OUTLET]' asserted 'above upper critical'.	Sensor '[POLESENSOR]' on pole '[OUTLETPOLE]' of outlet '[OUTLET]' deasserted 'above upper critical'.
Outlet > * > Pole > * > Sensor > Above upper	Sensor '[POLESENSOR]' on pole '[OUTLETPOLE]' of outlet	Sensor '[POLESENSOR]' on pole '[OUTLETPOLE]' of outlet

Event/context	Default message when the event = TRUE	Default message when the event = FALSE
warning threshold	'[OUTLET]' asserted 'above upper warning'.	'[OUTLET]' deasserted 'above upper warning'.
Outlet > * > Pole > * > Sensor > Below lower warning threshold	Sensor '[POLESENSOR]' on pole '[OUTLETPOLE]' of outlet '[OUTLET]' asserted 'below lower warning'.	Sensor '[POLESENSOR]' on pole '[OUTLETPOLE]' of outlet '[OUTLET]' deasserted 'below lower warning'.
Outlet > * > Pole > * > Sensor > Below lower critical threshold	Sensor '[POLESENSOR]' on pole '[OUTLETPOLE]' of outlet '[OUTLET]' asserted 'below lower critical'.	Sensor '[POLESENSOR]' on pole '[OUTLETPOLE]' of outlet '[OUTLET]' deasserted 'below lower critical'.
PDU > Load Shedding > Started	PX placed in Load Shedding Mode by user '[USERNAME]' from host '[USERIP]'.	PX removed from Load Shedding Mode by user '[USERNAME]' from host '[USERIP]'.
PDU > Sensor > +12V Supply 1 Status > fault	Global sensor 'powerSupplyStatus1' entered fault state.	PDU > Sensor > +12V Supply 1 Status > fault
PDU > Sensor > +12V Supply 1 Status > Unavailable	Global sensor 'powerSupplyStatus1' unavailable.	Global sensor 'powerSupplyStatus1' available.
Component Monitoring > * > Error	Error monitoring component '[MONITOREDHOST]': [ERRORDESC]	
Component Monitoring > * > Monitored	Component '[COMPONENT]' is now being monitored.	Component '[COMPONENT]' is no longer being monitored.
Component Monitoring > * > Unreachable	Component '[COMPONENT]' is unreachable.	Component '[COMPONENT]' is reachable.
Component Monitoring > * > Unrecoverable	Connection to component '[MONITOREDHOST]' could not be restored.	
User Activity > * > User logon state	User '[USERNAME]' from host '[USERIP]' logged in.	User '[USERNAME]' from host '[USERIP]' logged out.
User Activity > * > Authentication failure	Authentication failed for user '[USERNAME]' from host '[USERIP]'.	
User Activity > * > User accepted the Restricted Service Agreement	User '[USERNAME]' from host '[USERIP]' accepted the Restricted Service Agreement.	User '[USERNAME]' from host '[USERIP]' declined the Restricted Service Agreement.

Event/context	Default message when the event = TRUE	Default message when the event = FALSE
User Activity > * > User blocked	User '[USERNAME]' from host '[USERIP]' was blocked.	
User Activity > * > Session timeout	Session of user '[USERNAME]' from host '[USERIP]' timed out.	
User Administration > User added	User '[TARGETUSER]' added by user '[USERNAME]' from host '[USERIP]'.	
User Administration > User modified	User '[TARGETUSER]' modified by user '[USERNAME]' from host '[USERIP]'.	
User Administration > User deleted	User '[TARGETUSER]' deleted by user '[USERNAME]' from host '[USERIP]'.	
User Administration > Password changed	Password of user '[TARGETUSER]' changed by user '[USERNAME]' from host '[USERIP]'.	
User Administration > Password settings changed	Password settings changed by user '[USERNAME]' from host '[USERIP]'.	
User Administration > Role added	Role '[TARGETROLE]' added by user '[USERNAME]' from host '[USERIP]'.	
User Administration > Role modified	Role '[TARGETROLE]' modified by user '[USERNAME]' from host '[USERIP]'.	
User Administration > Role deleted	Role '[TARGETROLE]' deleted by user '[USERNAME]' from host '[USERIP]'.	
Surge Event > Surge Occurred	Surge protection status: [SURGESTATUS]	
Timer Event > Timer Event Occurred	Timer event '[EVENTRULENAME]' occurred.	

The asterisk symbol (\*) represents anything you select for the 'trigger' events.

### Available Actions

The PDU comes with four built-in actions, which cannot be deleted. You can create additional actions for responding to different events.

## Understanding Built-In Actions

- *System Event Log Action:*

This action records the selected event in the internal log when the event occurs.

- *System SNMP Notification Action:*

This action sends SNMP notifications to one or multiple IP addresses after the selected event occurs.



### NOTE

No IP addresses are specified for this notification action by default so you must enter IP addresses before applying this action to any event rule. For more information, see [Editing or Deleting a Rule/Action](#), on page 151. Any changes made to the 'SNMP Notifications' section on the SNMP page will update the settings of the System SNMP Notification Action, and vice versa. For more information, see [Configuring SNMP Settings](#), on page 96.

## Creating Actions

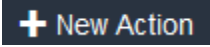
- Choose Device Settings > Event Rules > 
- Click the Action field to select an action type from the list.
- Below is the list of available actions.



### NOTE

The "Change load shedding state" and "Switch outlets" options are only available for outlet-switching capable models.

Action	Function
Alarm	Requires the user to acknowledge the alert after it is generated. If needed, you can have the alert notifications regularly generated until a person takes the acknowledgment action. For more information, see <a href="#">Alarm</a> , on page 133.
Change load shedding state	Enters or quits the load shedding mode. For more information, see <a href="#">Creating a Change Load Shedding State</a> , on page 135.
Execute an action group	Creates a group of actions comprising existing actions. For more information, see <a href="#">Executing an Action Group</a> , on page 135.
Log event message	Records the selected events in the internal log. For more information, see <a href="#">Creating an Event Log Message Action</a> , on page 136.
Push out sensor readings	Sends internal sensor log, environmental sensor log or asset management strip data to a remote server using HTTP POST requests. For more information, see <a href="#">Creating a Push Out Sensor Reading Action</a> , on page 136.
Send email	Emails a textual message. For more information, see <a href="#">Creating a Send Email Action</a> , on page 137.

Action	Function
Send sensor report	Reports the readings or status of the selected sensors, including internal or external sensors. For more information, see <a href="#">Creating a Send Sensor Report Action</a> , on page 138.
Send SMS message	Sends a message to a mobile phone. For more information, see <a href="#">Creating a Send SMS Message Action</a> , on page 140.
Send SNMP notification	Sends SNMP traps or informs to one or multiple SNMP destinations. For more information, see <a href="#">Send an SNMP Notification</a> , on page 142.
Switch outlets	Switches on, off or cycles the power to the specified outlet(s). For more information, see <a href="#">Creating a Switch Outlets Action</a> , on page 144.
Switch peripheral dry contact	Switches on or off the mechanism or system connected to the specified dry contact. For more information, see <a href="#">Creating a Switch Peripheral Dry Contact Action</a> , on page 145.
Syslog message	Makes the PDU automatically forward event messages to the specified syslog server. For more information, see <a href="#">Creating a Syslog Message Action</a> , on page 145.

- Enter the information as needed and click **Create**.
- Then you can assign the newly created action to an event rule or schedule it. For more information, see [Event Rules and Actions](#), on page 120.

## Alarm

The Alarm is an action that requires users to acknowledge an alert. This helps ensure that the user is aware of the alert.

If the Alarm action has been included in a specific event rule and no one acknowledges that alert after it occurs, the PDU resends or regenerates an alert notification regularly until the alert is acknowledged or the maximum number of alert notifications is sent.

For information on acknowledging an alert, see [Dashboard](#), on page 30.

### Creating an Alarm Action

- Choose Device Settings > Event Rules >  **+ New Action**.

- Select Alarm from the Action list.

**NEW ACTION**

Action Name:

Action:

---

Alarm Notifications: Selected Available

Enable Re-scheduling of Alarm Notifications:

Re-scheduling Period:  minutes

Re-scheduling Limit:

Acknowledgement Notifications: Selected Available

- In the Alarm Notifications list box, specify one or multiple ways to issue the alert notifications. Available methods vary, depending on how many notification-based actions have been created. Notification-based action types include:

- Syslog message
- Send email
- Send SMS message

If no appropriate actions are available, create them first.

- Select methods one by one, if desired, in the Available field.

Click Select All to add all available methods.

- Click a method's  in the Selected field to delete it.

Click Deselect All to remove all methods.

- Enable the notification-resending feature by selecting the "Enable Re-scheduling of Alarm Notifications" checkbox.
- In the "Re-scheduling Period" field, specify the time interval (in minutes) at which the alert notification is resent or regenerated regularly.
- In the "Re-scheduling Limit" field, specify the maximum number of times the alert notification is resent. Values range from 1 to infinite.
- **(Optional)** You can instruct the PDU to send the acknowledgment notification after the alarm is acknowledged in the Acknowledgment Notifications field. Available methods are identical to those for generating alarm notifications.

- In the Available field, select desired methods one by one, or click Select All. See step 3 for details.

- b. In the Selected field, click any method's  to remove unnecessary ones, or click Deselect All.

- Click **Create**.

### Creating a Change Load Shedding State

The "Change load shedding state" action is available only when your PDU is able to control outlet power. Use this action to activate or deactivate the load shedding mode for responding to a specific event. For additional information, see [Load Shedding Mode](#), on page 37.

- Choose Device Settings > Event Rules > .
- Select "Change load shedding state" from the Action list.

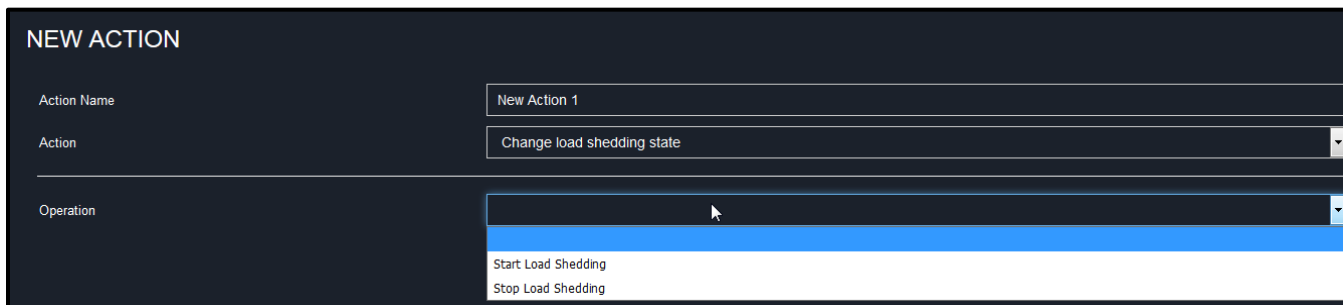

The screenshot shows the 'NEW ACTION' form. The 'Action Name' field contains 'New Action 1'. The 'Action' dropdown menu is set to 'Change load shedding state'. The 'Operation' dropdown menu is open, showing two options: 'Start Load Shedding' (highlighted in blue) and 'Stop Load Shedding'.

- In the Operation field, select either one below:
  - Start Load Shedding: Enters the load shedding mode when the specified event occurs.
  - Stop Load Shedding: Quits the load shedding mode when the specified event occurs.
- Click **Create**.

### Executing an Action Group

You can create an action group that performs up to 32 actions. After creating such an action group, you can easily assign this set of actions to any event rule rather than selecting all needed actions one by one per rule.

If the needed action is not available yet, create it first. For more information, see [Available Actions](#), on page 131.

- Choose Device Settings > Event Rules > .
- Select "Execute an action group" from the Action list.

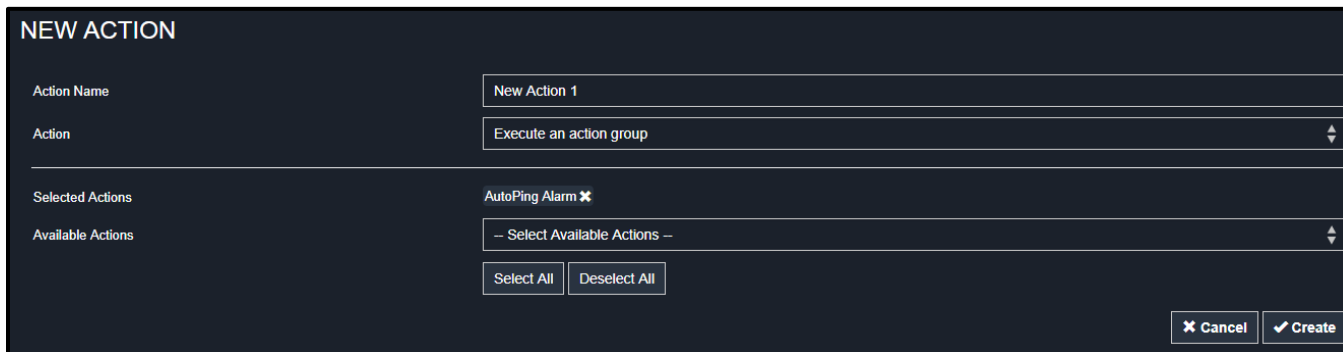

The screenshot shows the 'NEW ACTION' form. The 'Action Name' field contains 'New Action 1'. The 'Action' dropdown menu is set to 'Execute an action group'. The 'Selected Actions' field shows 'AutoPing Alarm' with a close icon. The 'Available Actions' dropdown menu is set to '-- Select Available Actions --'. Below this dropdown are 'Select All' and 'Deselect All' buttons. At the bottom right, there are 'Cancel' and 'Create' buttons.

- Select action(s) one by one, if desired, from the Available Actions list.
- Click Select All to select all available actions.
  - Click the action's  button to remove any action(s) from the Selected Actions field.
- Click Deselect All to remove all actions.
  - Click **Create**.

### Creating an Event Log Message Action

- Choose Device Settings > Event Rules > .
- Select "Log event message" from the Action list.

The option "Log event message" records the selected events in the internal log.

**NEW ACTION**

Action Name

Action

The default log message generated for each type of event is available in the section titled [Default Log Messages](#), on page 125.

- Click **Create**.

### Creating a Push Out Sensor Reading Action

You can configure the PDU to push sensor log to a remote server after a certain event occurs, including logs of internal sensors, environmental sensors and dry contacts.

Before creating this action, make sure that you have properly defined the destination servers and the data to be sent on the Data Push page. For more information, see [Configuring Data Push Settings](#), on page 156.



#### TIP

Schedule this action to send the data at a regular interval. For more information, see [Scheduling an Action](#), on page 147.

- Choose Device Settings > Event Rules > .

- Select "Push out sensor readings" from the Action list.

- Select a server or host which receives the sensor log in the Destination field.
- If the desired destination is not available yet, see the Data Push page to specify it. For more information, see [Configuring Data Push Settings](#), on page 156.
- Click **Create**.

### Creating a Send Email Action

You can configure emails to be sent when an event occurs and can customize the message.

Messages consist of a combination of free text and PDU placeholders. The placeholders represent information is pulled from the PDU and inserted into the message.

For example:

```
[USERNAME] logged into the device on  
[TIMESTAMP]
```

translates to

```
JQPublic logged into the device on 2012-  
January-30 21:00
```

For a list and definition of available variables, see [Understanding Email and SMS Message Placeholders](#), on page 149.

- Choose Device Settings > Event Rules > 

- Select "Send email" from the Action list.

**NEW ACTION**

Action Name:

Action:

---

Recipient Email Addresses:

SMTP Server:  Use default settings  
 Server Name: not configured  
 Sender Email Address: not configured  
 Settings can be changed in [SMTP Server settings](#).

Use custom settings

Use Custom Log Message:

Custom Log Message:

1024 characters remaining.

- In the "Recipient Email Addresses" field, specify the email address(es) of the recipient(s). Use a comma to separate multiple email addresses.
- Make sure the "Use custom SMTP Server" radio button is NOT selected to use the SMTP server specified on the SMTP Server page.

Select the radio button to use a different SMTP server. The fields for customized SMTP settings then appear. For information on each field, see [Configuring SMTP Settings](#), on page 97.

Default messages are sent based on the event. For a list of default log messages and events that trigger them, see [Default Log Messages](#), on page 125.

- If needed, select the Use Custom Log Message checkbox, and then create a custom message up to 1024 characters in the provided field.
- When clicking anywhere inside the text box, the Event Context Information displays, showing a list of placeholders and their definitions. Just click the desired placeholder. For more information, see [Understanding Email and SMS Message Placeholders](#), on page 149.
- Press Enter to start a new line in the text box.
- If needed, you can resize the text box by dragging the bottom-right corner.
- Click **Create**.

### Creating a Send Sensor Report Action

You may set the PDU so that it automatically reports the latest readings or states of one or multiple sensors by sending a message or email or simply recording the report in a log. These sensors can be either internal or environmental sensors as listed below.

- Inlet sensors, including RMS current, RMS voltage, active power, apparent power, power factor and active energy.
- Outlet sensors, including RMS current, RMS voltage, active power, apparent power, power factor, active energy and outlet state (for outlet-switching capable PDUs only).
- Overcurrent protector sensors, including RMS current and tripping state.

- Peripheral device sensors, which can be any environmental sensor packages connected to the PDU, such as temperature or humidity sensors.

An example of this action is available in the section titled [Send Sensor Report Example](#), on page 148.

- Choose Device Settings > Event Rules > **+ New Action**.
- Select "Send sensor report" from the Action list.

**NEW ACTION**

Action Name: New Action 1

Action: Send sensor report

Destination Actions

Selected: -- Select Available --

Available: -- Select Available --

Please select at least one action.

Select All Deselect All

Report Sensors

Please add at least one sensor to the report

Available Sensors: INLET I1 RMS VOLTAGE Add Remove

Send Report Now

Note: Reported sensor units can be changed in the [Default Preferences](#).

Cancel Create

- In the Destination Actions section, select the method(s) to report sensor readings or states. The number of available methods varies, depending on how many messaging actions have been created.

The messaging action types include:

- Log event message
  - Syslog message
  - Send email
  - Send SMS message
- If no messaging actions are available, create them now. For more information, see [Available Actions](#), on page 131.
  - Select methods one by one, if desired, in the Available field. Click Select All to add all available methods.
  - Click a method's  button in the Selected field to delete it. Click Deselect All to remove all methods.
    - In the Available Sensors field, select the desired target's sensor.

- a. Click the first  to select a target sensor from the list.

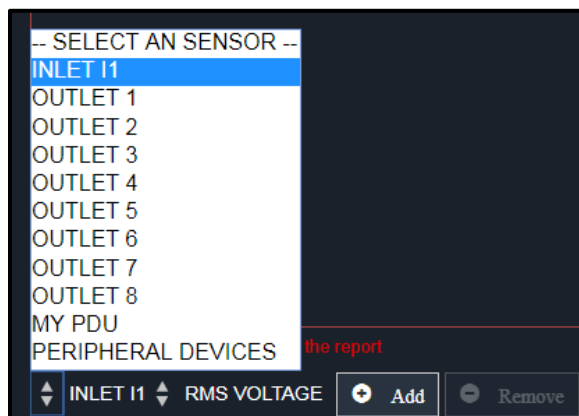

- b. Click the second  to select the specific sensor for the target from the list.

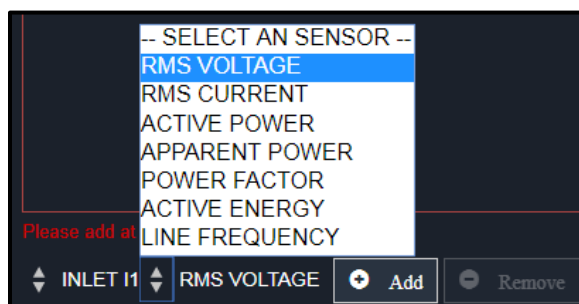

- c. Click  to add the selected sensor to the Report Sensors list box.

For example, to monitor the current reading of the Inlet 1, select Inlet 1 from the left field, and then select RMS Current from the right field.

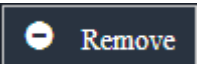
- Repeat the previous step to add more sensors and report additional sensors simultaneously.
- Select the sensor and click  to remove any sensor from the Report Sensors list box. Press Ctrl+click or Shift+click to select and highlight multiple sensors.
- Click Send Report Now to immediately send out the sensor report.



#### TIP

When intending to send a sensor report using custom messages, use the placeholder [SENSORREPORT] to report sensor readings. For more information, see [Understanding Email and SMS Message Placeholders](#), on page 149.

- Click **Create**.

#### Creating a Send SMS Message Action

You can configure SMS messages to be sent when an event occurs and can customize the message.

Messages consist of a combination of free text and PDU placeholders. The placeholders represent information which is pulled from the PDU and inserted into the message.



**NOTE** The PDU cannot receive SMS messages.

For example:

[USERNAME] logged into the device on [TIMESTAMP]

translates to

JQPublic logged into the device on 2012-January-30  
21:00

For a list and definition of available variables, see [Understanding Email and SMS Message Placeholders](#), on page 149.

- Choose Device Settings > Event Rules > + New Action
- Select "Send SMS message" from the Action list.

### NEW ACTION

Action Name	<input type="text" value="New Action 1"/>
Action	<input type="text" value="Send SMS message"/>
Recipient Phone Number	<input type="text" value="required"/>
Use Custom Log Message	<input checked="" type="checkbox"/>
Custom Log Message	<p style="font-size: small; color: #ccc;">Please note: Concatenated SMS will be sent in case the log message length exceeds 160 characters.</p> <input style="width: 100%; height: 30px;" type="text"/> <p style="font-size: x-small; color: #ccc;">1024 characters remaining.</p>

✖ Cancel
✔ Create

- In the Recipient Phone Number field, specify the phone number of the recipient.
- Select the Use Custom Log Message checkbox, and then create a custom message in the provided text box.
- When clicking anywhere inside the text box, the Event Context Information displays, showing a list of placeholders and their definitions. Just click the desired placeholder. For more information, see [Understanding Email and SMS Message Placeholders](#), on page 149.
- Press Enter to start a new line in the text box.
- If needed, you can resize the text box by dragging the bottom-right corner.



**NOTE** Only the 7-bit ASCII charset is supported for SMS messages.

- Click **Create**.

## Send an SNMP Notification

This option sends an SNMP notification to one or multiple SNMP destinations.

### Creating a Send SNMP v2c Notification Action

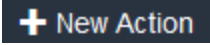
- Choose Device Settings > Event Rules > 
- Select "Send SNMP notification" from the Action list.
- In the Notification Type field, select SNMPv2c Trap or SNMPv2c Inform.

#### NEW ACTION

Action Name:

Action:

---

Notification Type:

Timeout:  seconds

Number of Retries:

#	Host	Port	Community
1	<input type="text"/>	<input type="text" value="162"/>	<input type="text"/>
2	<input type="text"/>	<input type="text" value="162"/>	<input type="text"/>
3	<input type="text"/>	<input type="text" value="162"/>	<input type="text"/>

- For SNMP INFORM communications, leave the resend settings at their default or do the following:
  - a. In the Timeout field, specify the interval of time, in seconds, after which a new inform communication is resent if the first is not received. For example, resend a new inform communication once every 3 seconds.
  - b. In the Number of Retries field, specify the number of times you want to resend the inform communication if it fails. For example, inform communications are resent up to 5 times when the initial communication fails.
    - In the Host fields, enter the IP address of the device(s) you want to access. This is the address to which notifications are sent by the SNMP system agent.
    - In the Port fields, enter the port number used to access the device(s).
    - In the Community fields, enter the SNMP community string to access the device(s). The community is the group representing the PDU and all SNMP management stations.



#### TIP

An SNMP v2c notification action permits only a maximum of three SNMP destinations. You can assign more than three SNMP destinations to a specific rule by first creating several SNMP v2c notification actions, each of which contains completely different SNMP destinations, and then adding all the SNMP v2c notification actions to the same rule.

- Click **Create**.

### Creating a Send SNMP v3 Notification Action

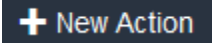
- Choose Device Settings > Event Rules > .
- Select "Send SNMP notification" from the Action list.
- In the Notification Type field, select SNMPv3 Trap or SNMPv3 Inform.

#### NEW ACTION

Action Name	<input type="text" value="New Action 1"/>
Action	<input type="text" value="Send SNMP notification"/>
Notification Type	<input type="text" value="SNMPv3 Trap"/>
Engine ID	0x800035ae809164b60f90587a769ee62a462addfdaa02f5edc947e914cbc89649
Host	<input type="text" value="required"/>
Port	<input type="text" value="162"/>
User ID	<input type="text" value="required"/>
Timeout	<input type="text" value="3"/> <span style="font-size: small;">seconds</span>
Number of Retries	<input type="text" value="5"/>
Security Level	<input type="text" value="authPriv"/>
Authentication Protocol	<input type="text" value="SHA"/>
Authentication Passphrase	<input type="text" value="required"/>
Confirm Authentication Passphrase	<input type="text"/>
Privacy Protocol	<input type="text" value="AES"/>
Privacy Passphrase	<input type="text" value="required"/>
Confirm Privacy Passphrase	<input type="text"/>

- For SNMP TRAPs, the engine ID is prepopulated.
- For SNMP INFORM communications, leave the resend settings at their default or do the following:
  - a. In the Timeout field, specify the interval of time, in seconds, after which a new inform communication is resent if the first is not received. For example, resend a new inform communication once every 3 seconds.
  - b. In the Number of Retries field, specify the number of times you want to resend the inform communication if it fails. For example, inform communications are resent up to 5 times when the initial communication fails.
    - For both SNMP TRAPS and INFORMS, enter the following as needed and then click OK to apply the settings:
      - a. Host name
      - b. Port number
      - c. User ID for accessing the host -- make sure the User ID has the SNMPv3 permission.
      - d. Select the host security level

Security level	Description
"noAuthNoPriv"	Select this if no authorization or privacy protocols are needed.
"authNoPriv"	Select this if authorization is required but no privacy protocols are required. <ul style="list-style-type: none"> <li>• Select the authentication protocol - MD5 or SHA</li> <li>• Enter the authentication passphrase and then confirm the authentication passphrase</li> </ul>
"authPriv"	Select this if authentication and privacy protocols are required. <ul style="list-style-type: none"> <li>• Select the authentication protocol - MD5 or SHA</li> <li>• Enter the authentication passphrase and confirm the authentication passphrase</li> <li>• Select the Privacy Protocol - DES or AES</li> <li>• Enter the privacy passphrase and then confirm the privacy passphrase</li> </ul>

- Click **Create**.

### Creating a Switch Outlets Action

This action turns on, off or power cycles a specific outlet.

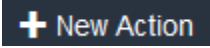
- Choose Device Settings > Event Rules >  **+ New Action**
- Select "Switch outlets" from the Action list.

#### NEW ACTION

Action Name

Action

---

Operation

Selected Outlets

Available Outlets

Use sequence order and delays

- In the Operation field, select an operation for the selected outlet(s).
- Turn Outlet On: Turns on the selected outlet(s).
- Turn Outlet Off: Turns off the selected outlet(s).
- Cycle Outlet: Cycles power to the selected outlet(s).
- Select outlets one by one from the Available Outlets list to specify the outlet(s) where the action will apply.
- Click Select All to add all outlets.

- Click the outlet's  button to remove any outlets from the Selected Outlets field.
- Click Deselect All to remove all outlets.
- If "Turn Outlet On" or "Cycle Outlet" is selected in step 3, you can choose to select the "Use sequence order and delays" checkbox so that all selected outlets will follow the power-on sequence defined on the Outlets page. For more information, see [Outlets](#), on page 34.

### Creating a Switch Peripheral Dry Contact Action

If you have any dry contact connected to the PDU, it can be configured so it automatically turns on or off the system controlled by the dry contact when a specific event occurs.



#### NOTE

For information on connecting dry contacts, refer to Contact Closure Sensor Series in the Premium+ PDU with RackLink Environmental Sensors User Manual at [www.legrandav.com](http://www.legrandav.com).

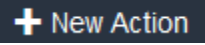
- Choose Device Settings > Event Rules > .
- Select "Switch peripheral actuator" from the Action list.

#### NEW ACTION

Action Name	<input type="text" value="New Action 1"/>
Action	<input type="text" value="Switch peripheral actuator"/>
Operation	<input type="text" value="-- Select an option --"/>
Selected Actuators	<input type="text" value="-- Select Available Actuators --"/>
Available Actuators	<input type="text" value="-- Select Available Actuators --"/>

Select All
Deselect All

✕ Cancel
✔ Create

- In the Operation field, select an operation for the selected actuator(s).
- Turn On: Turns on the selected actuator(s).
- Turn Off: Turns off the selected actuator(s).
- Select actuator(s) one by one from the Available Actuators list to select the actuator(s) where the action will apply.
- Click Select All to add all actuators.
- Click an actuator's  button to remove it from the Selected Actuators field.
- Click Deselect All to remove all actuators.
- Click **Create**.

### Creating a Syslog Message Action

Use this action to automatically forward event messages to the specified syslog server. Determine the syslog transmission mechanism you prefer when setting it up - UDP, TCP or TLS over TCP.

The PDU may or may not detect the syslog message transmission failure. If yes, it will log this syslog failure as well as the failure reason in the event log. For more information, see [Viewing or Clearing the Local Event Log](#), on page 200.

- Choose Device Settings > Event Rules > **+ New Action**.
- Select "Syslog message" from the Action list.

**NEW ACTION**

Action Name

Action

---

Syslog Server

Transport Protocol

Legacy BSD Syslog Protocol

UDP Port

- In the Syslog Server field, specify the IP address to which the syslog is forwarded.
- In the Transport Protocol field, select one of the syslog protocols: TCP, UDP or TCP+TLS. The default is UDP.

Transport protocols	Next steps
UDP	<ul style="list-style-type: none"> <li>• In the UDP Port field, type an appropriate port number. Default is 514.</li> <li>• Select the "Legacy BSD Syslog Protocol" checkbox if applicable.</li> </ul>
TCP	NO TLS certificate is required. Type an appropriate port number in the TCP Port field.
TCP+TLS	<p>A TLS certificate is required. Do the following:</p> <ol style="list-style-type: none"> <li>a. Type an appropriate port number in the "TCP Port" field. Default is 6514.</li> <li>b. In the CA Certificate field, click <b>Browse...</b> to select a TLS certificate. After installing the certificate, you may:                             <ul style="list-style-type: none"> <li>▪ Click Show to view its contents.</li> <li>▪ Click Remove to delete it if it is inappropriate.</li> </ul> </li> <li>c. Determine whether to select the "Allow expired and not yet valid certificates" checkbox.                             <ul style="list-style-type: none"> <li>▪ Select this checkbox to always send the event message to the specified syslog server as long as a TLS certificate is available.</li> <li>▪ Clear this checkbox to prevent the event message from being sent to the specified syslog server when any TLS certificate in the selected certificate chain is outdated or not valid yet.</li> </ul> </li> </ol>



- Click **Create**.



## Scheduling an Action

An action can be regularly performed at a preset time interval instead of being triggered by a specific event. For example, you can make the PDU report the reading or state of a specific sensor regularly by scheduling the "Send Sensor Report" action.

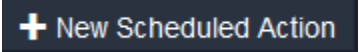
When scheduling an action, make sure you have a minimum of 1-minute buffer between this action's creation and first execution time. Otherwise, the scheduled action will NOT be performed at the specified time when the buffer time is too short. For example, if you want an action to be performed at 11:00 am, you should finish scheduling it at 10:59 am or earlier.

If the needed action is not available yet, create it first. For more information, see [Available Actions](#), on page 131.

- Choose Device Settings > Event Rules > .
- Select action(s) one by one from the Available Actions list.
- Click Select All to select all available actions.
- Click the action's  button to remove any action(s) from the Selected Actions field.
- Click Deselect All to remove all actions.
- Select the desired frequency in the Execution Time field, and then specify the time interval or a specific date and time in the field(s) that appear.

Execution time	Frequency settings
<b>Minutes</b>	<p>Click the Frequency field to select an option.</p> <p>The frequency ranges from every minute, every 5 minutes, every 10 minutes and so on until every 30 minutes.</p>
<b>Hourly</b>	<p>Type a value in the Minute field, which is set to either of the following:</p> <ul style="list-style-type: none"> <li>• The Minute field is set to 0 (zero). Then the action is performed at 1:00 am, 2:00 am, 3:00 am and so on.</li> <li>• The Minute field is set to a non-zero value. For example, if it is set to 30, then the action is performed at 1:30 am, 2:30 am, 3:30 am and so on.</li> </ul>
<b>Daily</b>	<p>Type values or click  .</p> <p>The time is measured in 12-hour format so you must correctly specify AM or PM by clicking the AM/PM button.</p>  <p>For example, if you specify 01:30PM, the action is performed at 13:30 pm every day.</p>

Execution time	Frequency settings
<b>Weekly</b>	<p>Both the day and time must be specified for the weekly option.</p> <ul style="list-style-type: none"> <li>Days range from Sunday to Saturday.</li> <li>The time is measured in 12-hour format so you must correctly specify AM or PM by clicking the AM/PM button.</li> </ul>
<b>Monthly</b>	<p>Both the date and time must be specified for the monthly option.</p> <ul style="list-style-type: none"> <li>The dates range from 1 to 31.</li> <li>The time is measured in 12-hour format so you must correctly specify AM or PM by clicking the AM/PM button.</li> </ul> <div style="border: 1px solid black; padding: 5px;">  <p><b>NOTE</b> Of course, not every month has 31 days, and February has 28 or 29 (the latter on Leap Year). Be sure to check the calendar when selecting 29, 30 or 31.</p> </div>
<b>Yearly</b>	<p>This option requires three settings:</p> <ul style="list-style-type: none"> <li>Month - January through December.</li> <li>Day of month - 1 to 31.</li> <li>Time - the value is measured in 12-hour format so you must correctly specify AM or PM by clicking the AM/PM button.</li> </ul>

An example of the scheduled action is available in the section titled [Creating a Send Sensor Report Action](#), on page 148.

### Send Sensor Report Example

Creating a scheduled action for emailing a temperature sensor report hourly requires the following:

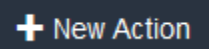
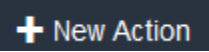
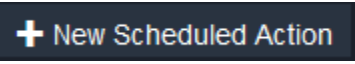
- A 'Send email' action
- A 'Send sensor report' action
- A timer - that is, the scheduled action
  - Click  to create a 'Send email' action that sends an email to the desired recipient(s). For more information, see [Creating a Send Email Action](#), on page 137.
  - In this example, this action is named *Email a Sensor Report*.
  - If intended, you can customize the email messages in this action.
  - Click  to create a 'Send sensor report' action that includes the 'Email a Sensor Report' action as its destination action. For more information, see [Creating a Send Sensor Report Action](#), on page 138.
  - In this example, this action is named *Send Temperature Sensor Readings*.
  - You can specify more than one temperature sensor as needed in this action.
  - Click  to create a timer for performing the 'Send Temperature Sensor Readings' action hourly. For more information, see [Scheduling an Action](#), on page 147.

- In this example, the timer is named *Hourly Temperature Sensor Reports*.
- Select Hourly, and set the Minute to 30 to perform the specified action at 12:30 pm, 01:30 pm, 02:30 pm, and so on.

Then the PDU will send out an email containing the specified temperature sensor readings hourly every day.

Whenever you want the PDU to stop sending the temperature report, simply deselect the Enabled checkbox in the timer.

## Understanding Email and SMS Message Placeholders

Actions of "Send email" and "Send SMS message" allow you to customize event messages. For more information, see [Creating a Send Email Action](#), on page 137 or [Creating a Send SMS Message Action](#), on page 140.

When clicking anywhere inside the text box, the Event Context Information displays, showing a list of placeholders and their definitions. Simply drag the scroll bar and then click the desired placeholder to insert it into the custom message. Or you can type a keyword in the "search" box to quickly find the desired placeholder.

If desired, you can sort the list by clicking the desired column header. For more information, see [Sorting a List](#), on page 29.

Click anywhere outside its window to make the Event Context Information disappear.

Following are placeholders that can be used in custom messages.

Placeholder	Definition
[ACTIVEINLET]	The label of the newly activated inlet
[CIRCUITCTRATING]	The circuit CT rating
[CIRCUITCURRENTRATING]	The circuit current rating
[CIRCUITNAME]	The circuit name
[CIRCUITPOLE]	The circuit power line identifier
[CIRCUITSENSOR]	The circuit sensor name
[CIRCUIT]	The circuit identifier
[CARDREADERPRODUCT]	The product name of a card reader
[CARDREADERSERIALNUMBER]	The serial number of a card reader
[COMPONENTID]	The ID of a hardware component
[CONFIGPARAM]	The name of a configuration parameter
[CONFIGVALUE]	The new value of a parameter
[DATETIME]	The human readable timestamp of the event occurrence
[DEVICEIP]	The IP address of the device, the event occurred on

Placeholder	Definition
[DEVICENAME]	The name of the device, the event occurred on
[DEVICESERIAL]	The unit serial number of the device the event occurred on
[ERRORDESC]	The error message
[EVENTRULENAME]	The name of the matching event rule
[EXTSENSORNAME]	The name of a peripheral device
[EXTSENSOR SLOT]	The ID of a peripheral device slot
[FAILURETYPE]	The numeric hardware failure type
[FAILURETYPESTR]	The textual hardware failure type
[EXTSENSOR]	The peripheral device identifier
[IFNAME]	The human readable name of a network interface
[INLETPOLE]	The inlet power line identifier
[INLETSENSOR]	The inlet sensor name
[INLET]	The power inlet label
[ISASSERTED]	Boolean flag whether an event condition was entered (1) or left (0)
[LOGMESSAGE]	The original log message
[MONITOREDHOST]	The name or IP address of a monitored host
[OLDVERSION]	The firmware version the device is being upgraded from
[OUTLETNAME]	The outlet name
	<div style="border: 1px solid black; padding: 5px;">  <p><b>NOTE</b> If any outlet does not have a name, neither an outlet name nor an outlet number will be shown in the custom message for it. Therefore, it is recommended to check the availability of all outlet names if intending to use this placeholder.</p> </div>
[OUTLETPOLE]	The outlet power line identifier
[OUTLETSENSOR]	The outlet sensor name
[OUTLET]	The outlet label
[PDUPOLESENSOR]	The sensor name for a certain power line
[PDUSENSOR]	The PDU sensor name
[PERIPHDEVPOSITION]	The position of an attached peripheral device
[PHONENUMBER]	The phone number an SMS was sent to

Placeholder	Definition
[PORTID]	The label of the external port, the event triggering device is connected to
[PORTTYPE]	The type of the external port (for example, 'feature' or 'auxiliary'), the event triggering device is connected to
[POWERMETERPOLE]	The PMC power meter line identifier
[POWERMETERSENSOR]	The PMC power meter sensor name
[POWERMETER]	The PMC power meter ID
[ROMCODE]	The rom code of an attached peripheral device
[SENSORREADINGUNIT]	The unit of a sensor reading
[SENSORREADING]	The value of a sensor reading
[SENSORREPORT]	The formatted sensor report contents
[SENSORSTATENAME]	The human readable state of a sensor
[SMTPRECIPIENTS]	The list of recipients, an SMTP message was sent to
[SMTPSERVER]	The name or IP address of an SMTP server
[SYSCONTACT]	SysContact as configured for SNMP
[SYSLOCATION]	SysLocation as configured for SNMP
[SYSNAME]	SysName as configured for SNMP
[TIMEREVENTID]	The id of a timer event
[TIMESTAMP]	The timestamp of the event occurrence
[TRANSFERSWITCHREASON]	The transfer reason
[TRANSFERSWITCHSENSOR]	The transfer switch sensor name
[TRANSFERSWITCH]	The transfer switch label
[UMTARGETROLE]	The name of a user management role, an action was applied on
[UMTARGETUSER]	The user, an action was triggered for
[USERIP]	The IP address, a user connected from
[USERNAME]	The user who triggered an action
[VERSION]	The firmware version the device is upgrading to
[SURGESTATUS]	Surge protection status

### Editing or Deleting a Rule/Action

You can change the settings of an event rule, action or scheduled action, or delete them.

**NOTE**

Some settings of the built-in event rules or actions are not user-configurable. Besides, you cannot delete built-in rules and actions. For more information, see [Built-in Rules and Rule Configuration](#), on page 122 or [Available Actions](#), on page 131.

- Choose Device Settings > Event Rules.
- Click the desired one in the list of rules, actions or scheduled actions. Its setup page opens.
- Perform the desired action.
- Modify settings by making necessary changes and then clicking **Save**.
- Click  **Delete** on the top-right corner to delete the rule/action. Then click Delete on the confirmation message.

## Sample Event Rules

### Sample PDU-Level Event Rule

In this example, we want the PDU to record the firmware upgrade failure in the internal log when it happens.

The event rule involves:

- Event: Device > Firmware update failed
- Action: System Event Log Action
  - For an event at the PDU level, select "Device" in the Event field.
  - Select "Firmware update failed" so that the PDU responds to the event related to firmware upgrade failure.
  - Make the PDU record the firmware update failure event in the internal log by selecting "System Event Log Action" in the Available Actions field.

### Sample Outlet-Level Event Rule

In this example, we want the PDU to send SNMP notifications to the SNMP manager for any sensor change event of outlet 3.

The event rule involves:

- Event: Outlet > Outlet 3 > Sensor > Any sub-event
- Action: System SNMP Notification Action
  - For an event at the outlet level, select "Outlet" in the Event field.
  - Select "Outlet 3" because that is the desired outlet.
  - Select "Sensor" to refer to sensor-related events.
  - Select "Any sub-event" to include all events related to all sensors of this outlet and all thresholds, such as current, voltage, upper critical threshold, upper warning threshold, lower critical threshold, lower warning threshold, and so on.
  - Make the PDU send SNMP notifications by selecting "System SNMP Notification Action" in the Available Actions field.

**NOTE**

The SNMP notifications may be SNMP v2c or SNMP v3 traps/informs, depending on the settings for the System SNMP Notification Action. For more information, see [Enabling and Configuring SNMP](#), on page 224.

Then the SNMP notifications are sent when:

- Any numeric sensor's reading enters the warning or critical range.
- Any sensor reading or state returns to normal.
- Any sensor becomes unavailable.
- The active energy sensor is reset.
- Any state sensor changes its state.

For example, when the outlet 3's voltage exceeds the upper warning threshold, the SNMP notifications are sent, and when the voltage drops below the upper warning threshold, the SNMP notifications are sent again.

**Sample Inlet-Level Event Rule**

In this example, we want the PDU to send SNMP notifications to the SNMP manager for any sensor change event of the Inlet I1.

The event rule involves:

- Event: Inlet > Sensor > Any sub-event
- Action: System SNMP Notification Action
  - For an event at the inlet level, select "Inlet" in the Event field.
  - Select "Sensor" to refer to sensor-related events.
  - Select "Any sub-event" to include all events related to all sensors of this inlet and all thresholds, such as current, voltage, upper critical threshold, upper warning threshold, lower critical threshold, lower warning threshold, and so on.
  - Make the PDU send SNMP notifications by selecting "System SNMP Notification Action" in the Available Actions box.

**NOTE**

The SNMP notifications may be SNMP v2c or SNMP v3 traps/informs, depending on the settings for the System SNMP Notification Action. For more information, see [Enabling and Configuring SNMP](#), on page 224.

Then the SNMP notifications are sent when:

- Any numeric sensor's reading enters the warning or critical range.
- Any sensor reading or state returns to normal.
- Any sensor becomes unavailable.
- The active energy sensor is reset.

For example, when the Inlet I1's voltage exceeds the upper warning threshold, the SNMP notifications are sent, and when the voltage drops below the upper warning threshold, the SNMP notifications are sent again.

### Sample Environmental-Sensor-Level Event Rule

In this example, we want the PDU to activate the load shedding function when a contact closure sensor enters the alarmed state. This event rule requires creating a new action before creating the rule.

#### Step 1: Create a New Action for Activating the Load Shedding

- Choose Device Settings > Event Rules > .
- In this illustration, assign the name "Activate Load Shedding" to the new action.
- In the Action field, select "Change load shedding state."
- In the Operation field, select Start Load Shedding.
- Click **Create** to finish the creation.

After the new action is created, follow the procedure below to create an event rule that triggers the load shedding mode when the contact closure sensor enters the alarmed state. This event rule involves the following:

- Event: Peripheral Device Slot > Slot 1 > State Sensor/Actuator > Alarmed/Open/On
- Trigger condition: Alarmed
- Action: Activate Load Shedding

#### Step 2: Create the Contact Closure-Triggered Load Shedding Event Rule

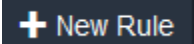
- Click  on the Event Rules page.
- In this illustration, assign the name "Contact Closure Triggered Load Shedding" to the new rule.
- In the Event field, select "Peripheral Device Slot" to indicate we are specifying an event related to the environmental sensor package.
- Select the ID number of the desired contact closure sensor. In this illustration, the ID number of the desired contact closure sensor is 1, so select Slot 1.



#### NOTE

ID numbers of all sensors/dry contacts are available on the Peripherals page. For more information, see [Peripherals](#), on page 65.

- Select "State Sensor/Actuator" because the contact closure sensor is a state sensor.
- Select "Alarmed" since we want the PDU to respond when the selected contact closure sensor changes its state related to the "alarmed" state.
- In the "Trigger condition" field, select the Alarmed/Open/On radio button so that the action is taken only when the contact closure sensor enters the alarmed state.
- Select "Activate Load Shedding" from the Available Actions list.

### Understanding an Event Rule Infinite Loop

You should avoid building an infinite loop when creating event rules.

The infinite loop refers to a condition where the PDU keeps busy because the action or one of the actions taken for a certain event triggers an identical or similar event which will result in an action triggering one more event.

**Example 1**

This example illustrates an event rule which continuously causes the PDU to send out email messages.

Event selected	Action included
Device > Sending SMTP message failed	Send email

**Example 2**

This example illustrates an event rule which continuously causes the PDU to send out SMTP messages when one of the selected events listed on the Device menu occurs.

	<b>NOTE</b>	<Any sub-event> under the Device menu includes the event "Sending SMTP message failed."
Event selected	Action included	
Device > Any sub-event	Send email	

**Example 3**

This example illustrates a situation where two event rules combined regarding the outlet state changes causes the PDU to continuously power cycle outlets 1 and 2 in turn.

Event selected	Action included
Outlet > Outlet 1 > Sensor > Outlet State > On/Off > Both (trigger condition)	Cycle Outlet 2 (Switch outlets --> Cycle Outlet --> Outlet 2)
Outlet > Outlet 2 > Sensor > Outlet State > On/Off > Both (trigger condition)	Cycle Outlet 1 (Switch outlets --> Cycle Outlet --> Outlet 1)

**Understanding Untriggered Rules**

In some cases, a measurement exceeds a threshold causing the PDU to generate an alert. The measurement then returns to a value within the threshold, but the PDU does not generate an alert message for the Deassertion event. Such scenarios can occur due to the PDU tracking the PDU uses. For more information, refer to "To De-assert" and Deassertion The PDU in the Premium+ PDU With RackLink Advanced User Manual at [www.legrandav.com](http://www.legrandav.com).

**Setting Data Logging**

The PDU can store 120 measurements for each sensor in a memory buffer. This memory buffer is known as the data log. Sensor readings in the data log can be retrieved using SNMP.

You can configure how often measurements are written into the data log using the Measurements Per Log Entry field.

Since the PDU's internal sensors are measured every second, specifying a value of 60, for example, would cause measurements to be written to the data log once every minute. Since there are 120 measurements of storage per sensor, specifying a value of 60 means the log can store the last two hours of measurements before the oldest one in the log gets overwritten.

Whenever measurements are written to the log, three values for each sensor are written: the average, minimum and maximum values. For example, if measurements are written every minute, the average of all measurements that occurred during the preceding 60 seconds along with the minimum and maximum measurement values are written to the log.

**NOTE**

The PDU's SNMP agent must be enabled for this feature to work. For more information, see [Enabling and Configuring SNMP](#) on page 224. In addition, using an NTP time server ensures accurately time-stamped measurements.

Data logging is enabled by default. You must have the "Administrator Privileges" or "Change PDU, Inlet, Outlet & Overcurrent Protector Configuration" permissions to change the setting.

- Choose Device Settings > Data Logging.
- Select the "Enable" checkbox in the General Settings section to enable the data logging feature.
- Type a number in the Measurements Per Log Entry field.

Valid range is from 1 to 600. The default is 60.

- Verify that all sensor logging is enabled. Logging is divided into sections of the page based on sensor types. You can also click Enable All at the bottom of the page to have all sensors selected.
- You can also click the topmost checkbox labeled "Logging Enabled" in the header row of each sensor type section to select all sensors of the same type.
- If any section's number of sensors exceeds 35, the remaining sensors are listed on next page(s). If so, a pagination bar similar to the following diagram displays in this section, which you can click any button to switch between pages.

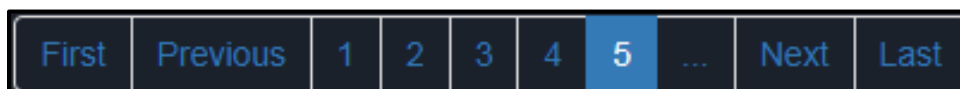

- Click **Save**. This button is located at the bottom of the page.

**CAUTION**

Although it is possible to selectively enable/disable logging for individual sensors on the PDU, it is not recommended to do so.

**ATTENTION**

Bien qu'il soit possible d'activer/désactiver sélectivement la journalisation pour des capteurs individuels sur la PDU, il n'est pas recommandé de le faire.

## Configuring Data Push Settings

You can push the sensor data to a remote server for data synchronization. The data will be sent in JSON format using HTTP POST requests. You need to set up the destination and authentication for data push on the PDU.

After configuring the destination and authentication settings, do either or both of the following:

- Perform the data push after the occurrence of a certain event by creating the data push action and assigning it to an event rule.
- Push the data at a regular interval by scheduling the data push action.

For more information, see [Event Rules and Actions](#), on page 120.

- Choose Device Settings > Data Push.
- Click the **+ New Destination** button to specify a destination.
- Do the following to set up the URL field.
  - a. Click  to select *http* or *https*.
  - b. Type the URL or host name in the accompanying text box.
    - If selecting *https*, a CA certificate is required for making the connection. Click **Browse...** to install it. Then you can:
      - Click Show to view the certificate's content.
      - Click Remove to delete the installed certificate if it is inappropriate.
      - If the destination server requires authentication, select the Use Authentication checkbox, and enter the following data.
        - User name
        - Password
          - In the Entry Type field, determine the data that will be transmitted.
      - Sensor log: Transmit the record of all logged sensors, including their sensor readings and/or status. Logged sensors refer to all internal and/or environmental sensors/dry contacts that you have selected on the Data Logging page. For more information, see [Setting Data Logging](#), on page 155.
        - Click **Create**.
        - Repeat the same steps for additional destinations.

### Modifying or Deleting Data Push Settings

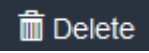
- On the Data Push page, click the one you want in the list.
- Perform either action below.
- Modify settings by making necessary changes and then clicking **Save**.
- Delete the data push setting by clicking the  **Delete** button, and then confirm on the confirmation message.

### Monitoring Component Reachability

You can monitor whether specific devices are alive by having the PDU continuously ping them. A device's successful response to the ping commands indicates that the device is still alive and can be remotely accessed.

This function is especially useful when you are not located in an area with Internet connectivity.

The PDU can monitor the accessibility of any device, such as third-party control systems, televisions, power distribution units (PDUs), or routers.

The default ping settings may not be suitable for monitoring devices that require high connection reliability so it is strongly recommended that you should adjust the ping settings for optimal results.



### TIP

Make the PDU automatically log, send notifications or perform other actions for any component monitoring events by creating event rules. For more information, see [Event Rules and Actions](#), on page 120. An example is available in [Example: Ping Monitoring and SNMP Notifications](#), on page 159.

## Adding IT Equipment for Ping Monitoring

- Choose Device Settings > Component Reachability.
- Click  **Monitor New Component**.
- By default, the "Enable ping monitoring for this component" checkbox is selected. If not, select it to enable this feature.
- Configure the following.

Field	Description
IP address/hostname	IP address or host name of the IT equipment which you want to monitor.
Enable ping monitoring for this component	Select the checkbox to enable ping monitoring.
Number of successful pings to enable feature	The number of successful pings required to declare that the monitored equipment is "Reachable." Valid range is 0 to 200.
Wait time after successful ping	The wait time before sending the next ping if the previous ping was successfully responded. Valid range is 5 to 600 (seconds).
Wait time after unsuccessful ping	The wait time before sending the next ping if the previous ping was not responded. Valid range is 3 to 600 (seconds).
Number of consecutive unsuccessful pings for failure	The number of consecutive pings without any response before the monitored equipment is declared "Unreachable." Valid range is 1 to 100.
Wait time before resuming pinging after failure	The wait time before the PDU resumes pinging after the monitored equipment is declared "Unreachable." Valid range is 1 to 1200 (seconds).
Number of consecutive failures before disabling feature (0 = unlimited)	The number of times the monitored equipment is declared "Unreachable" consecutively before the PDU disables the ping monitoring feature for it and shows "Waiting for reliable connection." Valid range is 0 to 100.

- Click **Create**.
- Repeat the same steps to add more IT devices.

Initially, the status of the added IT equipment shows "Waiting for reliable connection," which means the requested number of consecutive successful or unsuccessful pings has not been reached before the PDU can declare that the monitored device is reachable or unreachable.

### Checking Component Monitoring States and Results

- After adding IT equipment for monitoring, all IT devices are listed on the Component Reachability page.
- The column labeled "Ping Enabled" indicates whether the monitoring for the corresponding IT device is activated or not.
- The column labeled "Status" indicates the accessibility of each monitored equipment.

Status	Description
Reachable	The monitored equipment is accessible.
Unreachable	The monitored equipment is inaccessible.
Waiting for reliable connection	The connection between the PDU and the monitored equipment is not reliably established yet.

### Editing or Deleting Ping Monitoring Settings

You can edit the ping monitoring settings of any IT device or delete it if it's no longer needed.

- Choose Device Settings > Component Reachability.
- Click the desired one in the list.
- Perform the desired action.
- Modify settings by making necessary changes and then clicking **Save**. For information on each field, see [Monitoring Component Reachability](#), on page 157.
- Click the  button on the top-right corner to delete.

### Example: Ping Monitoring and SNMP Notifications

In this illustration, it is assumed that a significant PDU (IP address: 192.168.84.95) shall be monitored by your PDU to make sure that PDU is properly operating all the time, and the PDU must send out SNMP notifications (trap or inform) if that PDU is declared unreachable due to power or network failure. The prerequisite for this example is that the power sources are different between your PDU and the monitored PDU.

This requires the following two steps.

#### Step 1: Set Up the Ping Monitoring for the Target PDU

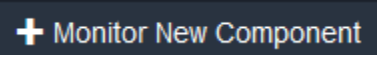
- Choose Device Settings > Component Reachability.
- Click .
- Ensure the "Enable ping monitoring for this component" checkbox is selected.
- Enter the data shown below.
- Enter the component's data.

Field	Data entered
IP address/hostname	192.168.84.95

- Enter the following data to make the PDU declare the accessibility of the monitored PDU every 15 seconds (3 pings \* 5 seconds) when the PDU is accessible.

Field	Data entered
Number of successful pings to enable feature	3
Wait time after successful ping	5

- Enter the following data to make the PDU declare the inaccessibility of the monitored PDU when it becomes inaccessible for around 12 seconds (4 seconds \* 3 pings).

Field	Data entered
Wait time after unsuccessful ping	4
Number of consecutive unsuccessful pings for failure	3

- Enter the following data to make the PDU stop pinging the target PDU for 60 seconds (1 minute) after the PDU inaccessibility is declared. After 60 seconds, the PDU will re-ping the target PDU.

Field	Data entered
Wait time before resuming pinging after failure	60

- The "Number of consecutive failures before disabling feature (0 = unlimited)" can be set to any value you want.
- Click **Create**.

## Step 2: Create an Event Rule to Send SNMP Notifications for the Target PDU

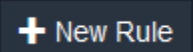
- Choose Device Settings > Event Rules.
- Click .
- Select the Enabled checkbox to enable this new rule.
- Configure the following.

Field or Setting	Data specified
Rule name	Send SNMP notifications for PDU (192.168.84.95) inaccessibility
Event	Choose Component Reachability > 192.168.84.95 > Unreachable
Trigger condition	Select the Unreachable radio button

This will make the PDU react only when the target PDU becomes inaccessible.

- Select the System SNMP Notification Action.



### NOTE

If you have not configured the System SNMP Notification Action to specify the SNMP destination(s), see [Editing or Deleting a Rule/Action](#), on page 151.

## Front Panel Settings (Rackmount PDUs Only)

You can make various settings to the outlet buttons and front panel display area on the front panel of your Rackmount PDU.

### Configuring Front Panel Settings

- Choose Device Settings > Front Panel.
- The front panel page appears.

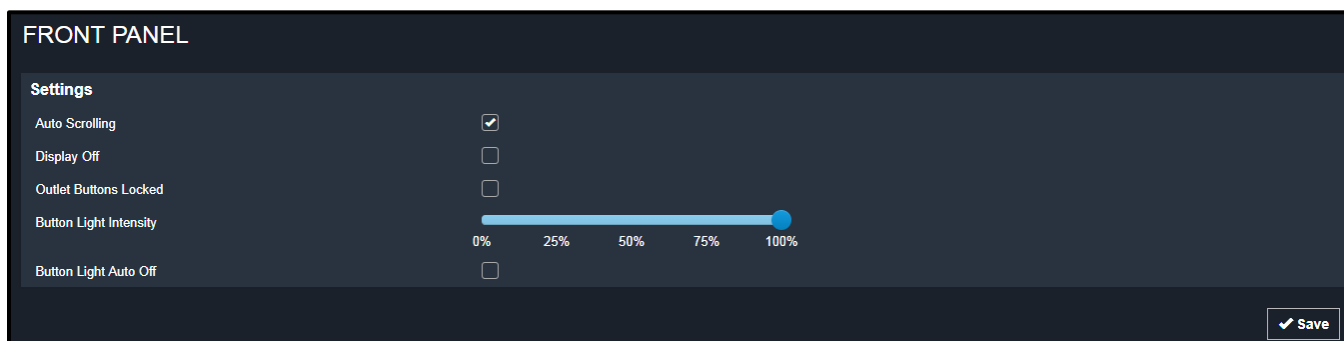

- Configure the following fields:
  - Auto Scrolling: Select this checkbox to enable the auto scrolling of information on the front panel display. For more information, see [Front Panel \(Rackmount PDUs Only\)](#), on page 17.
  - Display Off: Select this checkbox to turn off the front panel display text.



#### NOTE

Even with the Display Off checkbox selected, the outlet relays still remain active and responsive.

- Outlet Buttons Locked: Select this checkbox to lock the outlet buttons on the front panel. They will continue to indicate outlet status in the user interface, but will no longer toggle the outlet when touched from the front panel.
- Button Light Intensity: Slide along the percentage rule to select one of the five levels of light intensity for your outlet buttons on the front panel.
- Button Light Auto Off: Select this checkbox to have the outlet buttons on the front panel automatically turn off after approximately 10 seconds of inactivity.
  - Click **Save**.

## Serial Port

Your PDU detects and shows devices connected to its serial ports. You can also configure the detection type and baud rate used.

### Configuring Serial Port Settings

- Choose Device Settings > Serial Port.

The Serial Port page appears.

**SERIAL PORT**

**General**

**Port State**

Port state	Console
Connected device	None

**Settings**

Connected device	Automatic detection
Console baud rate	115200 bit/s
Modem baud rate	115200 bit/s

Save

- The Port State section of the page shows the following:

Port state:

Connected device:

- The Settings section of the page includes the following fields:

Connected device: Use the drop-down to select from Automatic detection, Force Console, Force Analog Modem, and Force GSM Modem values.

Console baud rate: Use the drop-down to select the desired console baud rate (in bit/s).

Modem baud rate: Use the drop-down to select the desired modem baud rate (in bit/s).

## Cloud Services

The Cloud Services page lets you enable the RackLink Cloud connection, monitor its status, access your cloud via URL, view MAC address and serial number values, and enable a Crestron XiO connection all from the same page.

### Understanding RackLink Cloud Services

RackLink Cloud, built on Xyte™, and hosted on Amazon Web Services (AWS), is the premier remote power management system offering device-level control. It enables significant cost savings by eliminating on-site visits for routine tasks. With no extra equipment needed, you can monitor and manage your Select PDU, Premium+™ PDU, and NEXSYS™ UPS devices from anywhere in the world. RackLink Cloud ensures robust data security and privacy, complying with international standards, including GDPR, and follows Privacy by Design principles.

For more details, refer to the following resources:

- The RackLink Cloud product page at [https://www.legrandav.com/products/power/intelligent\\_power/racklink-cloud](https://www.legrandav.com/products/power/intelligent_power/racklink-cloud).
- Xyte's Privacy Policy at <https://www.xyte.io/privacy-policy>.
- The AWS Cloud Security page at <https://aws.amazon.com/security>.

### RackLink Cloud Network Requirements

- Your RackLink device must have an outgoing connection via Ethernet port. For more information, see [I/O Panel](#) on page 18.
- Outgoing connections accessing RackLink Cloud services require SSL port 443 enabled for all \*.xyte.io domains.
- Devices without direct internet access must use a proxy server when connecting to \*.xyte.io domains.
- Any network restrictions on these domains may result in RackLink Cloud communication issues.

For more information, contact support at [success@xyte.io](mailto:success@xyte.io), [av.middleatlantic.techsupport@legrand.com](mailto:av.middleatlantic.techsupport@legrand.com) or (866) 977-3901.

### Enabling, Registering, and Claiming Your Device in the Cloud

Use the following steps to enable Cloud Services on your PDU. Then, use the device information displayed on the screen when accessing the RackLink Cloud website (link also displayed on the screen), creating a customer account, and claiming your device in the cloud system.



#### NOTE

Many cloud topic images come from a RackLink Premium Plus P915R or Select 1015V model PDU. Procedures and images are similar for other cloud-enabled products unless otherwise noted.

## CLOUD SERVICES

### RackLink Cloud Connection

Enable RackLink Cloud Connection	<input type="checkbox"/>
Connection Status	● Disconnected
RackLink Cloud URL	<a href="https://legrand.on-xyte.com" style="color: #3498db;">https://legrand.on-xyte.com</a>
MAC Address	00: [blacked out]
Serial Number	RLNKP-915_ [blacked out]
Enable SSH Tunneling	<input checked="" type="checkbox"/>

### Crestron XiO Connection

Enable Crestron XiO Connection	<input type="checkbox"/>
--------------------------------	--------------------------

1. Choose Device Settings > Cloud Services.

The Cloud Services page appears.

**CLOUD SERVICES**

**RackLink Cloud Connection**

Enable RackLink Cloud Connection	<input type="checkbox"/>
Connection Status	● Disconnected
RackLink Cloud URL	<a href="https://legrand.on-xyte.com">https://legrand.on-xyte.com</a>
MAC Address	00: [blacked out]
Serial Number	RLNKP-915_ [blacked out]
Enable SSH Tunneling	<input checked="" type="checkbox"/>

✓ Save

**Crestron XiO Connection**

Enable Crestron XiO Connection	<input type="checkbox"/>
--------------------------------	--------------------------

✓ Save

2. Select the **Enable RackLink Cloud Connection** check box to enable your cloud service.
3. The Status section of the screen initially appears with a Disabled status. Once the Enable check box is selected, this field displays different statuses for your cloud services connection as follows:
  - **Disabled:** The Cloud service is disabled on your PDU.
  - **Disconnected:** The Cloud service is enabled on your PDU. Access the RackLink Cloud using the URL: <https://legrand.on-xyte.com> to register and claim your device in the cloud system.
  - **Connected:** The Cloud service is enabled on your PDU, and your device is claimed from and connected to the cloud system.
4. Notice the displayed MAC Address and Serial Number of your PDU for easy reference when claiming your device in the RackLink Cloud system.

**NOTE**

MAC Addresses and Serial Numbers are used to claim most devices. In other cases, a Cloud ID is provided for device claiming. The rest of the device registration and claiming process is the same.

5. Click **Save**.

Notice the Status changes to Connected.

**CLOUD SERVICES**

**RackLink Cloud Connection**

Enable RackLink Cloud Connection	<input checked="" type="checkbox"/>
Connection Status	<span style="color: green;">●</span> Connected
RackLink Cloud URL	<a href="https://legrand.on-xyte.com">https://legrand.on-xyte.com</a>
MAC Address	00: [REDACTED]
Serial Number	RLNKP-915_ [REDACTED]
Enable SSH Tunneling	<input checked="" type="checkbox"/>

✓ Save

**Crestron XiO Connection**

Enable Crestron XiO Connection	<input type="checkbox"/>
--------------------------------	--------------------------

✓ Save

6. Click the RackLink Cloud URL at <https://legrand.on-xyte.com> to access the system, register, and claim your device.

The RackLink Cloud sign in screen appears.

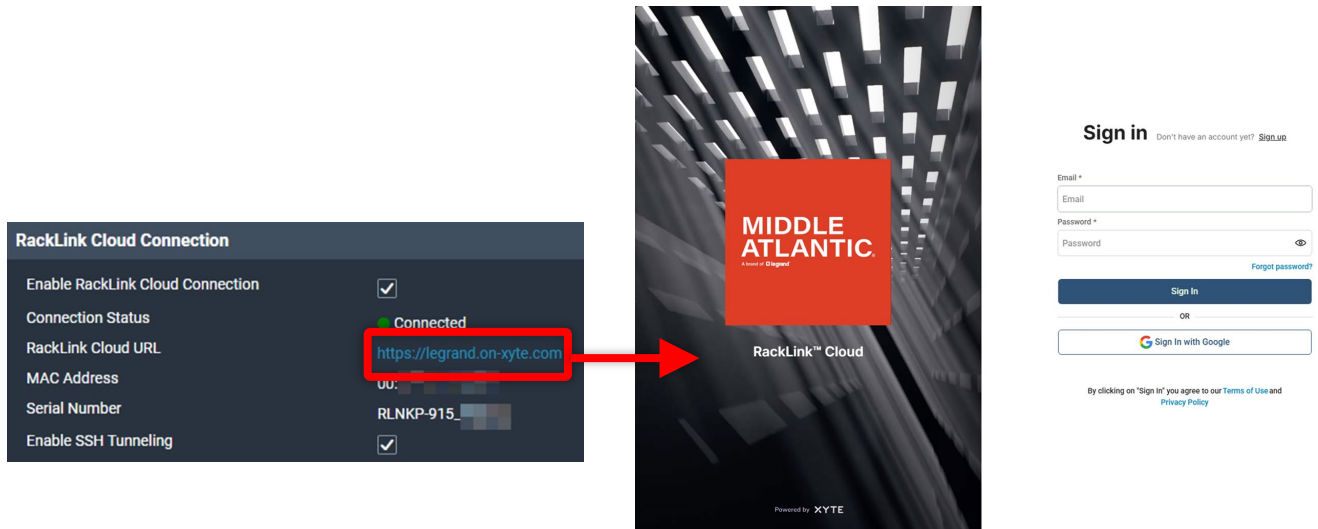

7. Click the Sign up link on the upper-right section of the screen.

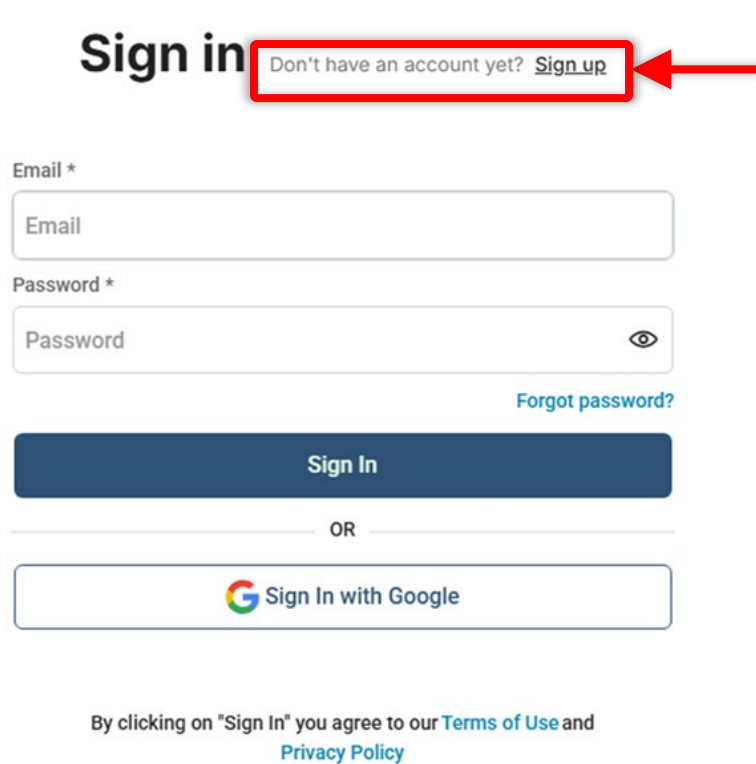

The RackLink Cloud sign up screen appears.

8. Provide an email address or use a Google account, as desired, and click **Continue with email** or **Continue with Google**, accordingly.

## Sign up

Already have an account? [Sign in](#)

Enter your work email \*

**Continue with email**

OR

 **Continue with Google**

By continuing I agree with the [Terms of Use](#) and [Privacy Policy](#).

9. The system asks you to name your organization. In the Organization name field, provide an organization name, as desired, and click **Continue**.

## Name your organization

Organization name \*

Choose this option if the tenant is for internal demo or testing purposes. Sandbox tenants behave the same as regular customer tenants.

**Continue** 

10. The system then asks you to invite teammates to your RackLink Cloud organization.

If you wish to invite teammates, provide values in the Teammate email address and Select role fields, as desired, and click **Send Invitation**.

## Time to invite your teammates

Collaborate with your team to get the most out of Xyte.io

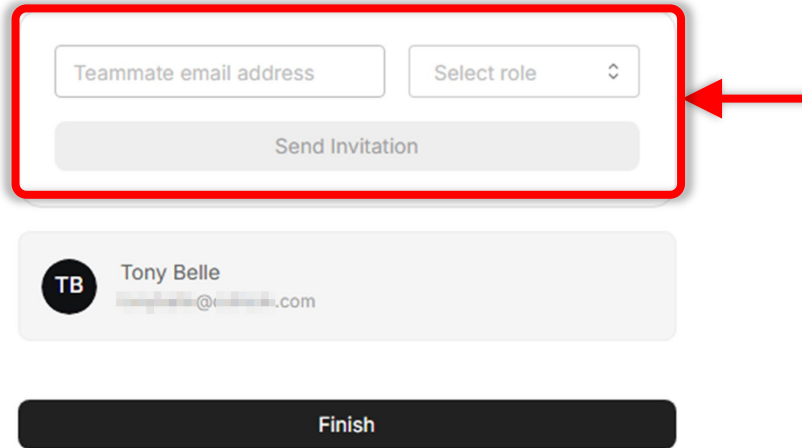

The screenshot shows a web interface for inviting teammates. At the top, the heading "Time to invite your teammates" is displayed in bold. Below it is the subtext "Collaborate with your team to get the most out of Xyte.io". The main form consists of a rounded rectangle containing two input fields: "Teammate email address" and "Select role" with a dropdown arrow. Below these fields is a grey "Send Invitation" button. A red box highlights the entire form area, and a red arrow points to the right side of the box.

- 11. Provide teammate email addresses and assign roles, if desired.
- 12. Click **Finish**.

## Time to invite your teammates

Collaborate with your team to get the most out of Xyte.io

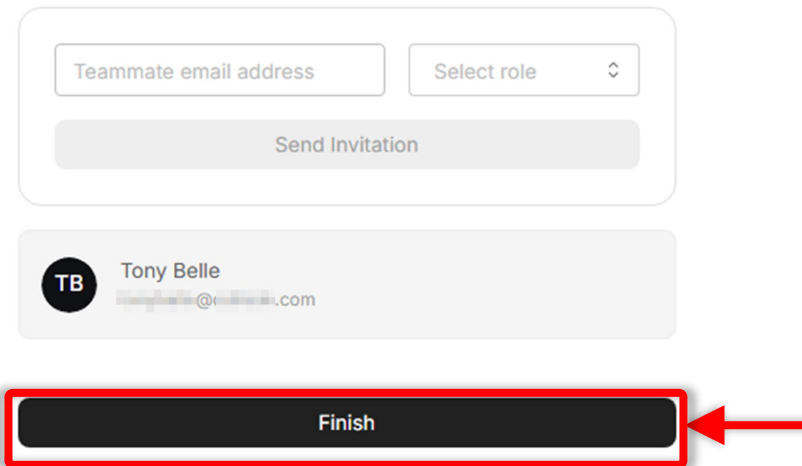

This screenshot is identical to the one above, showing the "Time to invite your teammates" form. However, in this version, the "Send Invitation" button is disabled (greyed out). A red box highlights the "Finish" button at the bottom of the page, and a red arrow points to the right side of the box.

The RackLink Cloud Overview screen for your organization appears.

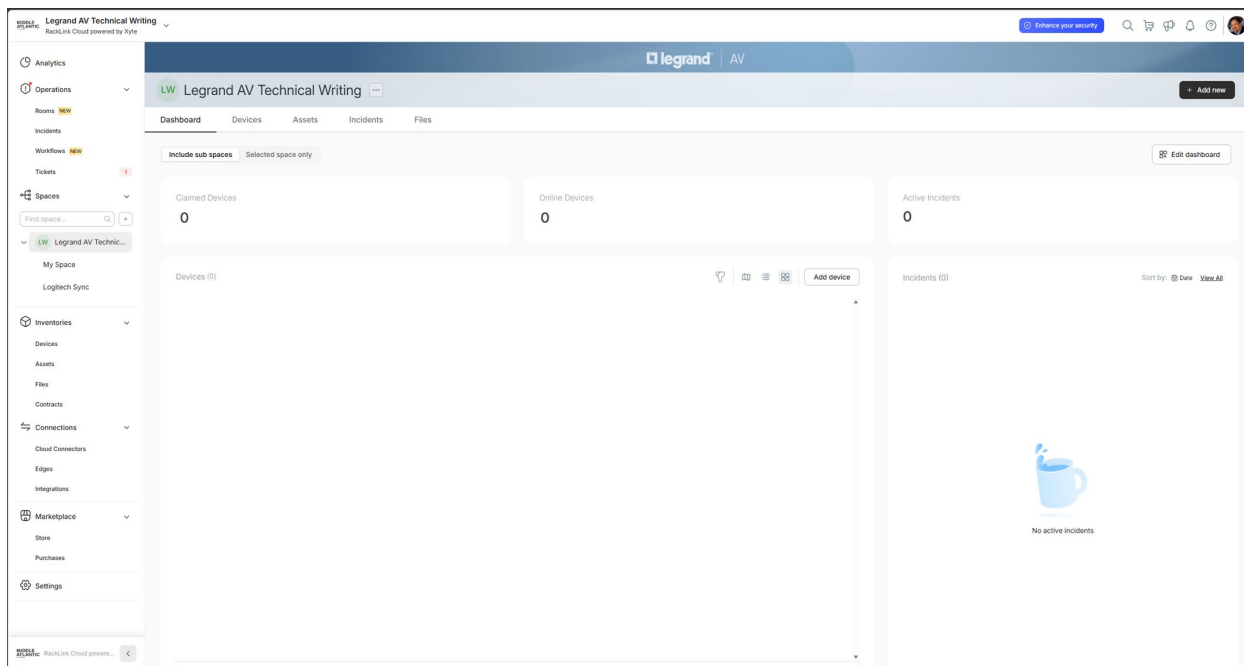

13. Click **Add device** as shown.

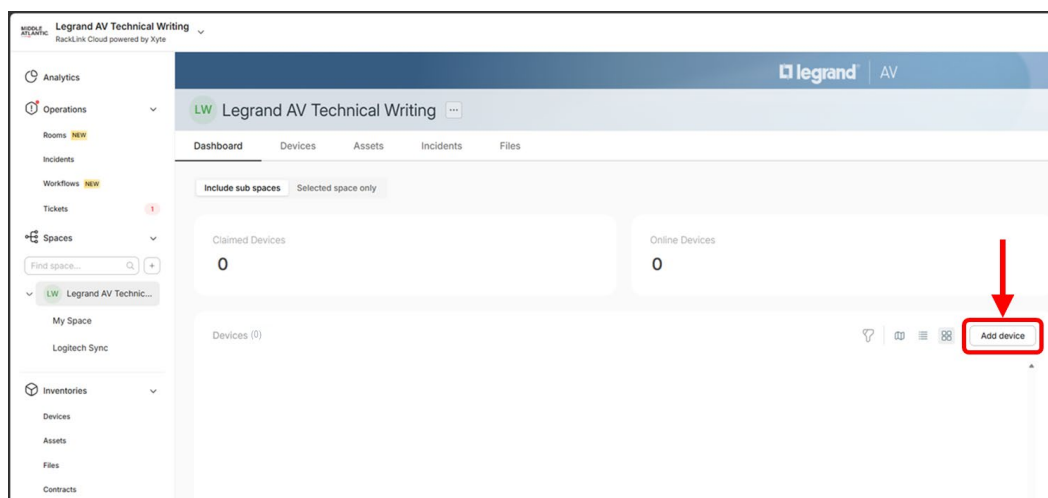

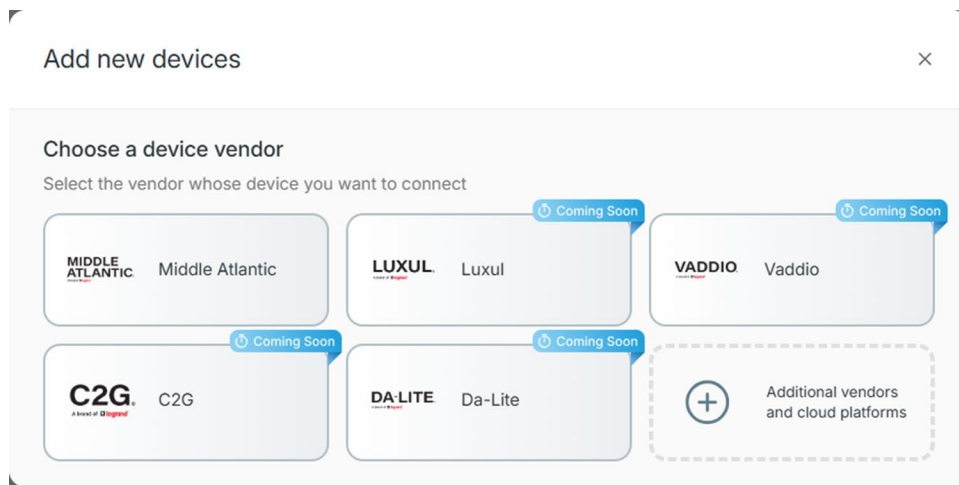

The Add new devices screen appears.

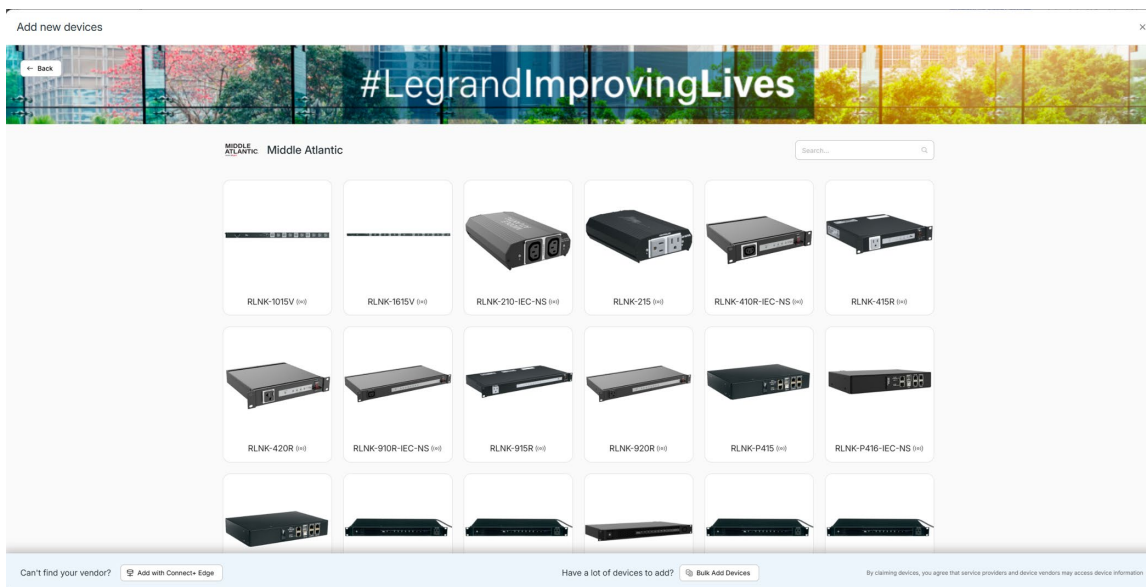

14. Click your desired vendor from the ones shown.

A screen appears showing the cloud-enabled devices available from the selected vendor.



 **NOTE** Many cloud topic images come from a RackLink Premium Plus P915R or Select 1015V model PDU. Procedures and images are similar for other cloud-enabled products unless otherwise noted.

15. Find and click your device from the ones shown.

The Add new devices details screen appears.

The screenshot shows a modal window titled "Add new devices" with a close button (X) in the top right corner. Inside the modal, there is a device icon and the text "Middle Atlantic" and "RLNK-P915R (10)". Below this, it says "Please fill the details below in order to claim this device." The form includes a "Customer" dropdown menu with "LW Legrand AV Technical Writing" selected. Below the dropdown is a box labeled "Add device to" with "Legrand AV Technical Writing" and a "Change space" link. There are also input fields for "MAC Address" (with a help icon and example "e.g 00:B0:D0:63:C2:26"), "Serial Number" (with a help icon and placeholder "Enter serial number"), and "Device Name (Optional)" (with example "e.g CEO's Room TV"). At the bottom of the form, there is a blue button that says "Have a lot of devices to add? Bulk add devices" and a link "Need help? See troubleshooting guide". At the very bottom of the modal, there are three buttons: "Contact support", "Cancel", and "Add device".

16. Click the **Change space** link to change the organization, if desired.

This screenshot is identical to the one above, but with a red box around the "Change space" link and a red arrow pointing down to it from the "Customer" dropdown menu.

17. Provide entries in the **MAC Address** and **Serial Number** fields using the values you noted on the RackLink Cloud Settings screen in the web interface, earlier in this topic.

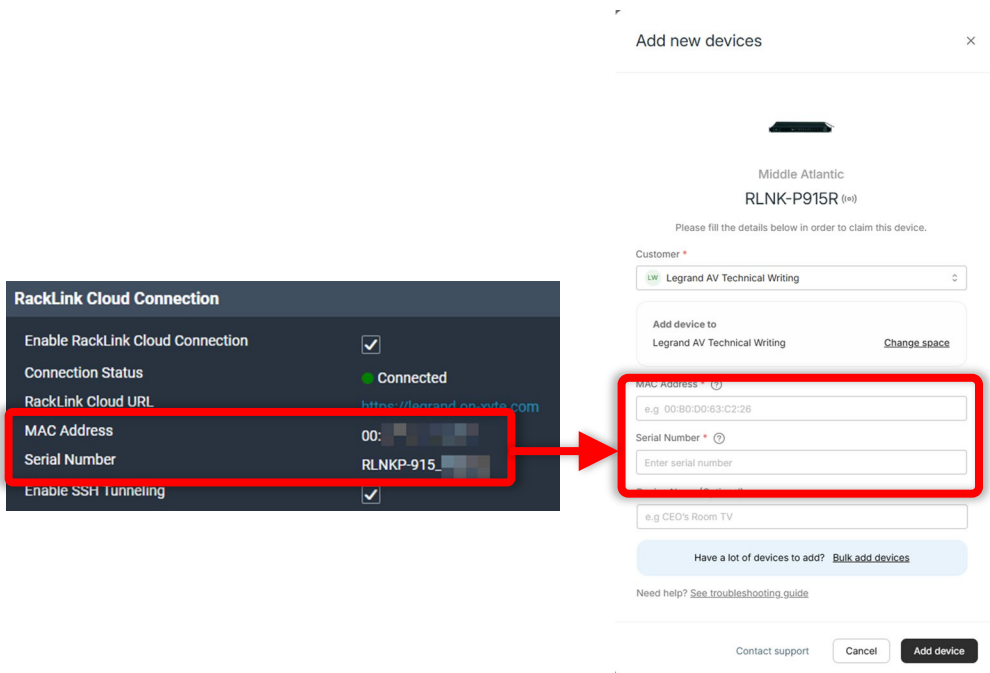

18. Enter a logical name in the **Name** field, as desired, and click **Add device**.

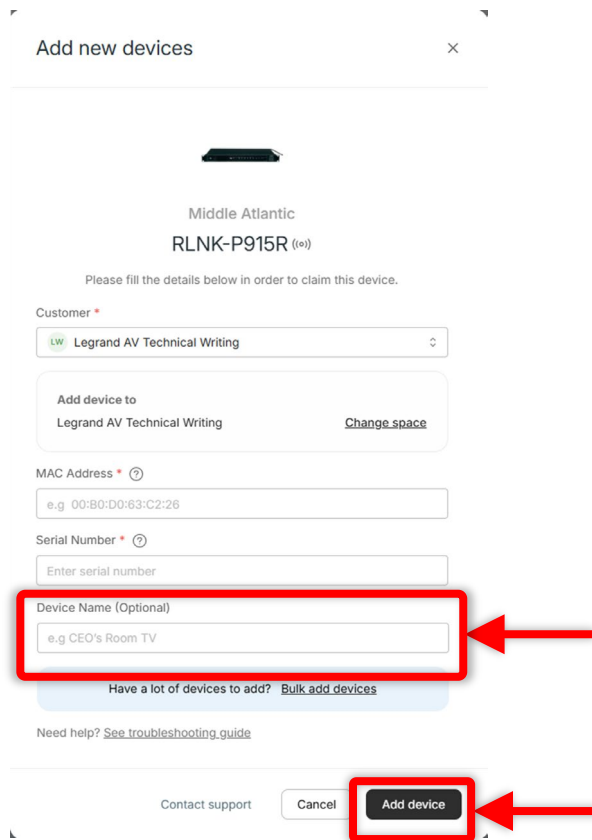

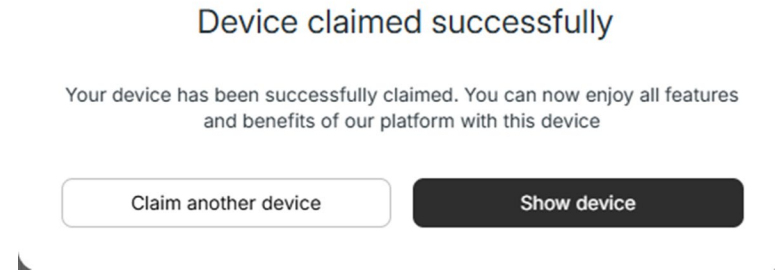

The Device claimed successfully screen appears.

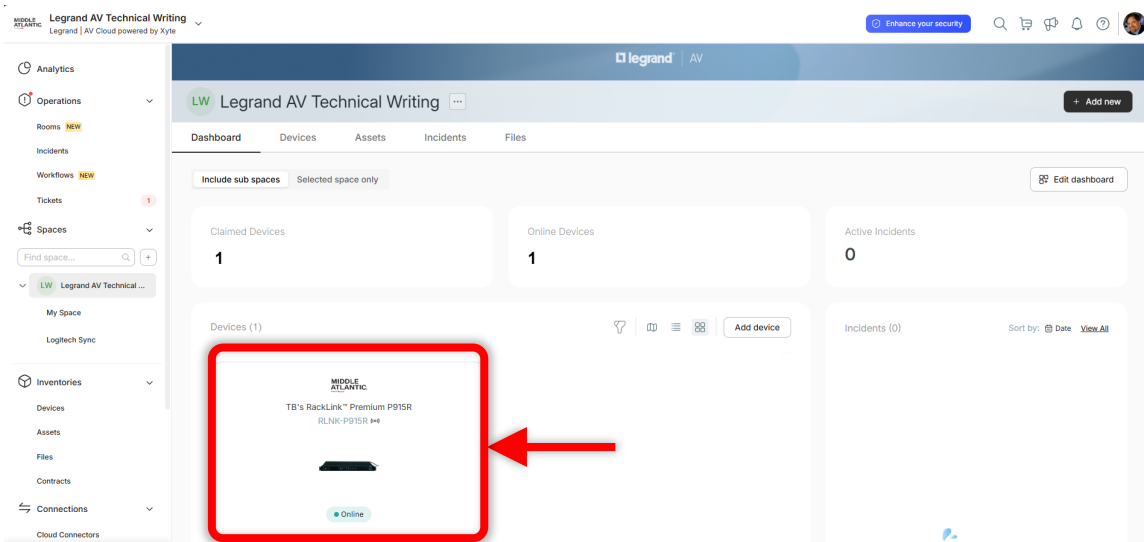

19. Click **Show device**.

Your device appears on the Cloud Dashboard.



 **NOTE** Click **Claim another device** to continue claiming additional units, if desired.

20. Click your device to access the Device Dashboard.

The Device Dashboard appears.

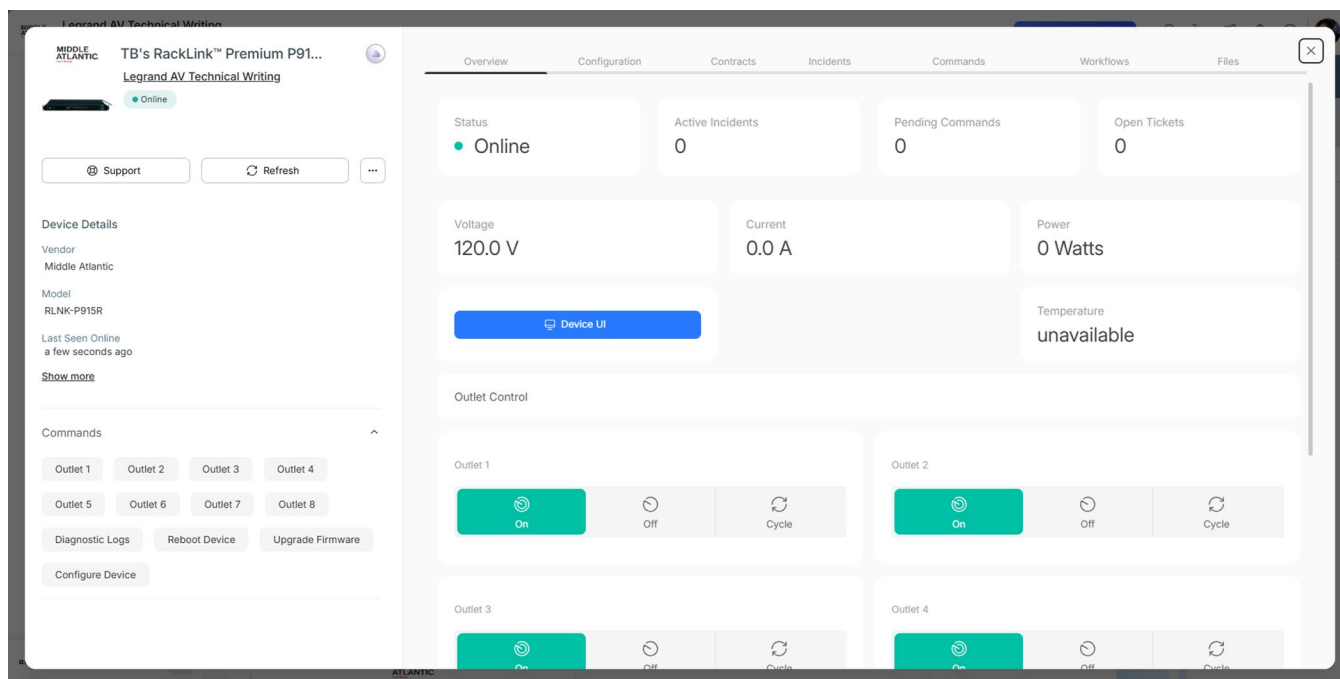

For information about RackLink Cloud services, refer to the Premium PDU with RackLink product page at [www.legrandav.com](http://www.legrandav.com), contact support at [av.middleatlantic.techsupport@legrand.com](mailto:av.middleatlantic.techsupport@legrand.com) or (866) 977-3901, and refer to additional RackLink Cloud documentation at <https://docs.xyte.io>, including the following topics:

- Sign up: <https://docs.xyte.io/docs/sign-up>
- Claim your first device: <https://docs.xyte.io/docs/first-device>
- Asset management: <https://docs.xyte.io/docs/devices>

## Configuring a Crestron XiO Connection

1. Choose Device Settings > Cloud Services.

The Cloud Services page appears.

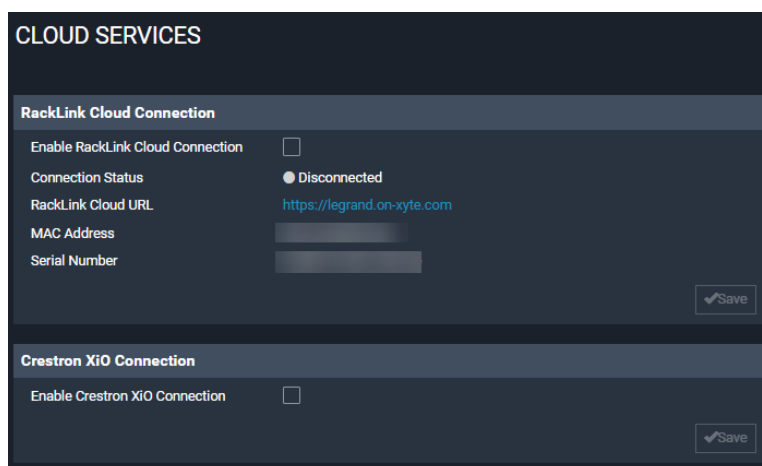

2. Select the Enable Crestron XiO Connection check box to enable the XiO service.



3. Click **Save**.

## Using Controllable Outlets on Cloud-Connected Devices

1. Access the Device Dashboard.

For more information, see [Enabling, Registering, and Claiming Your Device in the Cloud](#), on page 163.

2. Control outlets directly from the Device Dashboard by clicking On, Off, or Cycle buttons as desired.

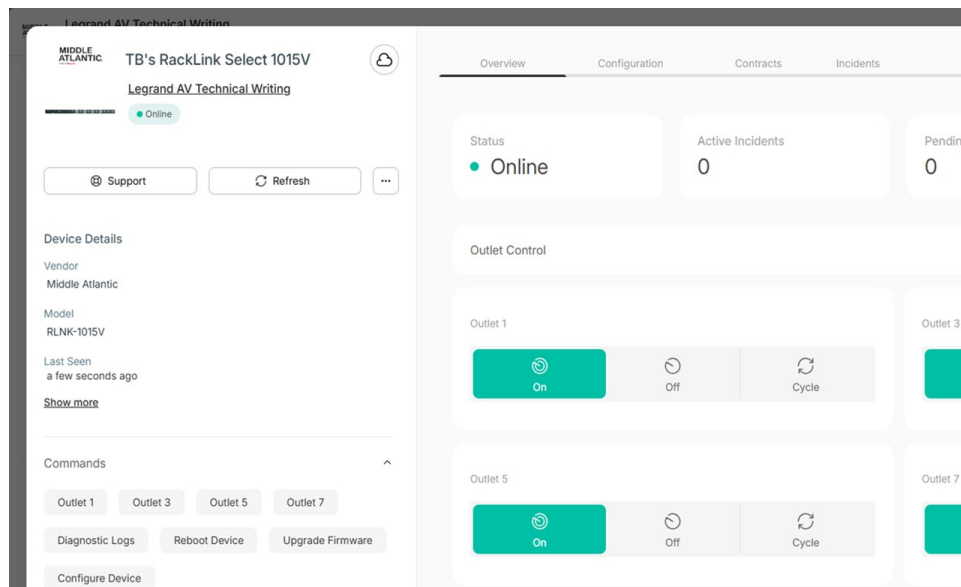

 **NOTE**

- Alternatively, you can click specific outlet buttons directly from the commands listed on the dashboard as shown.

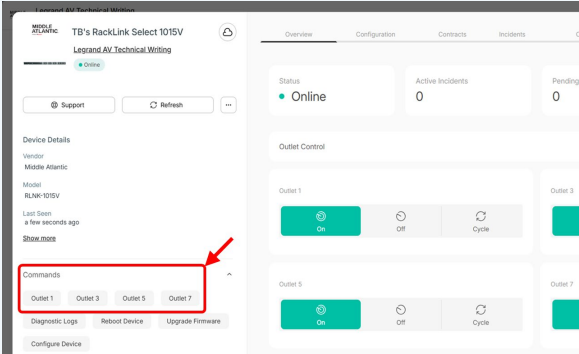

- Many cloud topic images come from a RackLink Premium Plus P915R or Select 1015V model PDU. Procedures and images are similar for other cloud-enabled products unless otherwise noted.

The Send Command pop-up appears.

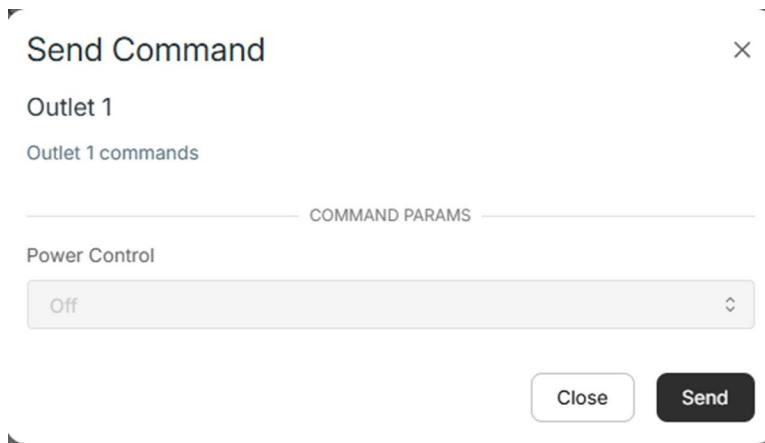

 **NOTE**

When clicking outlet controls directly from the Device Dashboard, the specific operation (On, Off, or Cycle) is pre-selected and grayed out on the Power Control drop-down.

3. Click **Send**.

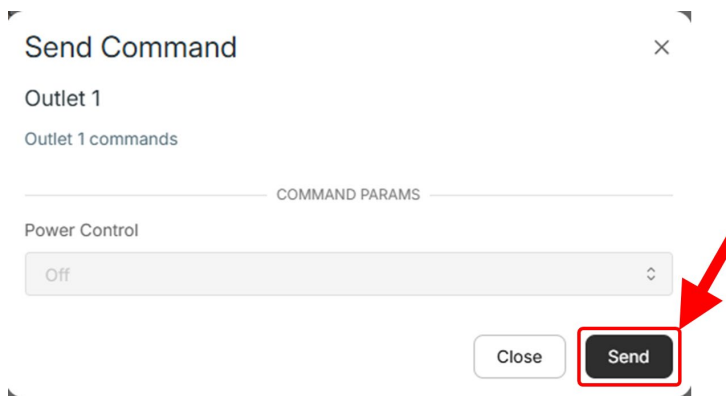

While the command is sent to your unit and executed, the command itself grays out and appears as busy, a command event is recorded on the Commands tab and a notification appears at the bottom center of the screen as shown.

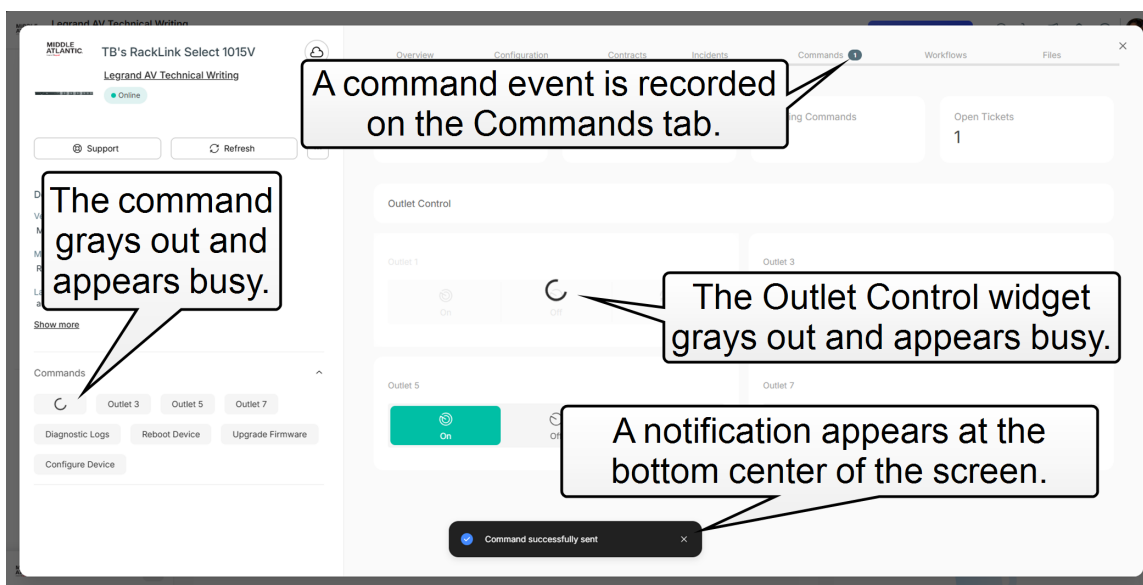

- The command appears in the Active & Pending view while the system executes the task. When completed, the record moves to the All Commands view as shown.

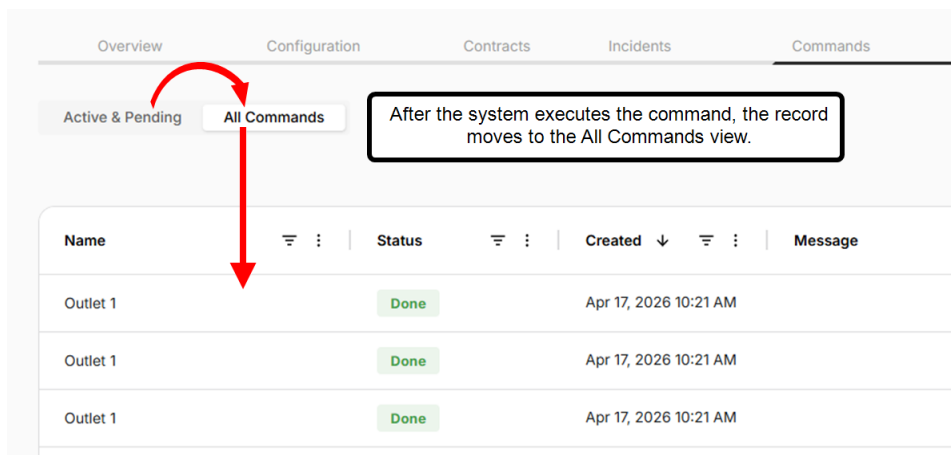

- Use the Commands tab controls as desired.  
For more information, see [Using Command Tab Controls](#), on page 194.

## Using the Reboot Device Command

- Access the Device Dashboard.  
For more information, see [Enabling, Registering, and Claiming Your Device in the Cloud](#), on page 163.
- Click the **Reboot** command.

 **NOTE** Many cloud topic images come from a RackLink Premium Plus P915R or Select 1015V model PDU. Procedures and images are similar for other cloud-enabled products unless otherwise noted.

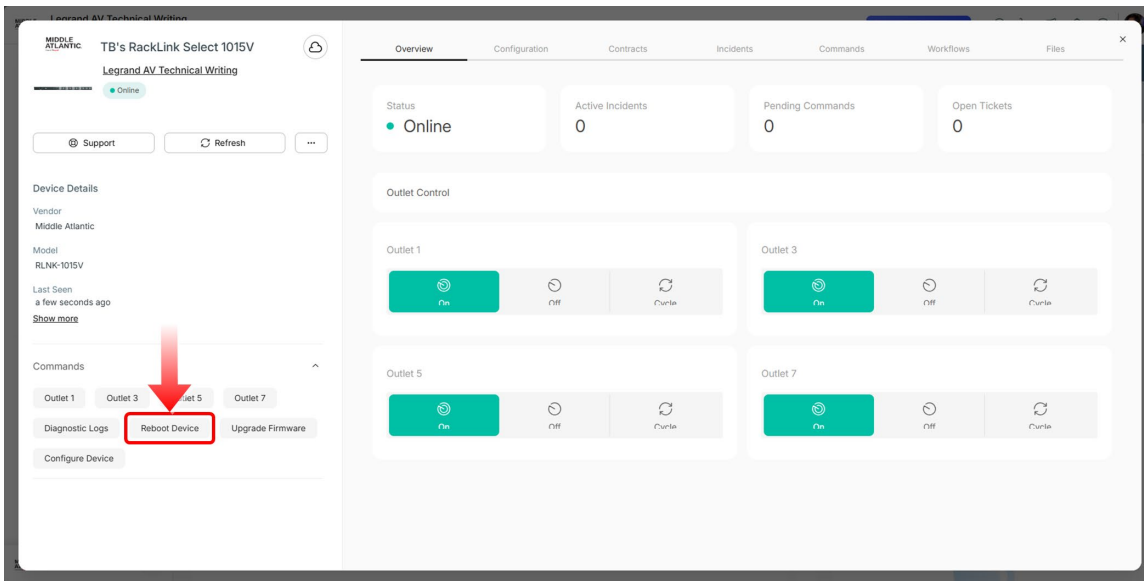

The Confirm Reboot command pop-up appears.

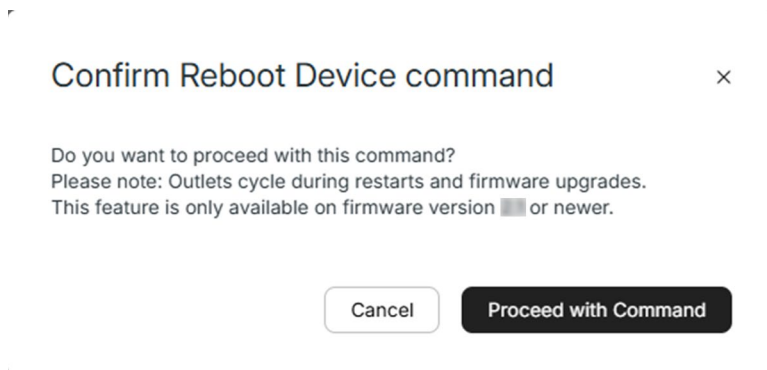

3. Click **Proceed with Command**.

While the command is sent to your unit and executed, the command itself grays out and appears as busy, a command event is recorded on the Commands tab and a notification appears at the bottom center of the screen as shown.

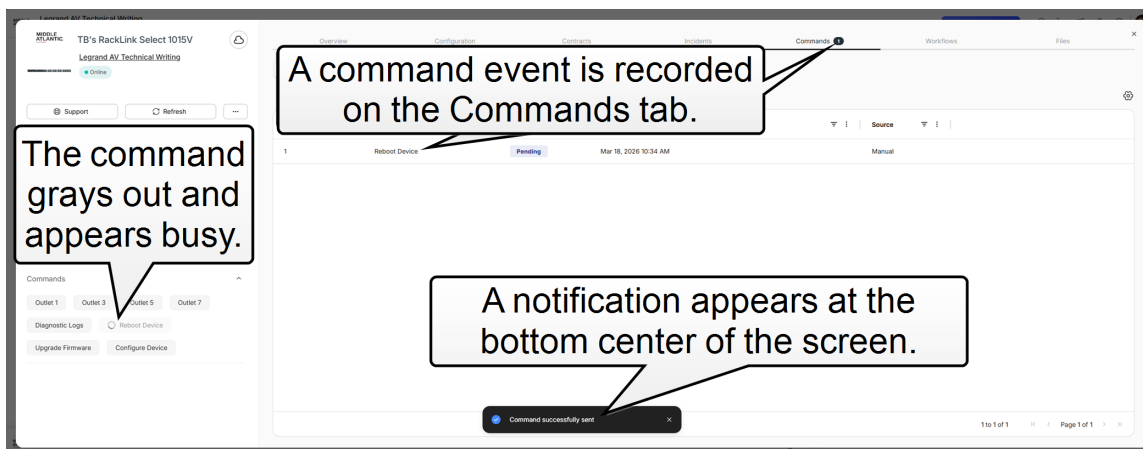

- The command appears in the Active & Pending view while the system executes the task. When completed, the record moves to the All Commands view as shown.

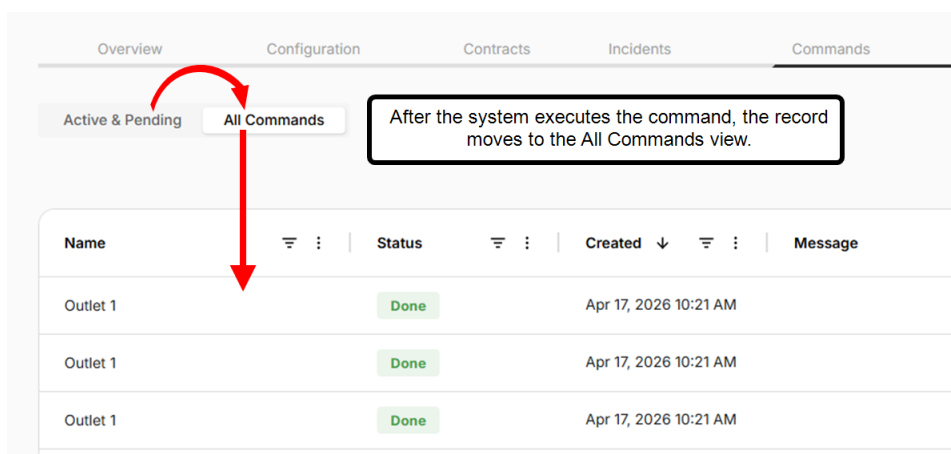

- Use the Commands tab controls as desired.  
For more information, see [Using Command Tab Controls](#), on page 194.

## Using the Diagnostic Logs Command

- Access the Device Dashboard.

For more information, see [Enabling, Registering, and Claiming Your Device in the Cloud](#), on page 163.

- Click the **Diagnostic Logs** command.

 **NOTE** Many cloud topic images come from a RackLink Premium Plus P915R or Select 1015V model PDU. Procedures and images are similar for other cloud-enabled products unless otherwise noted.

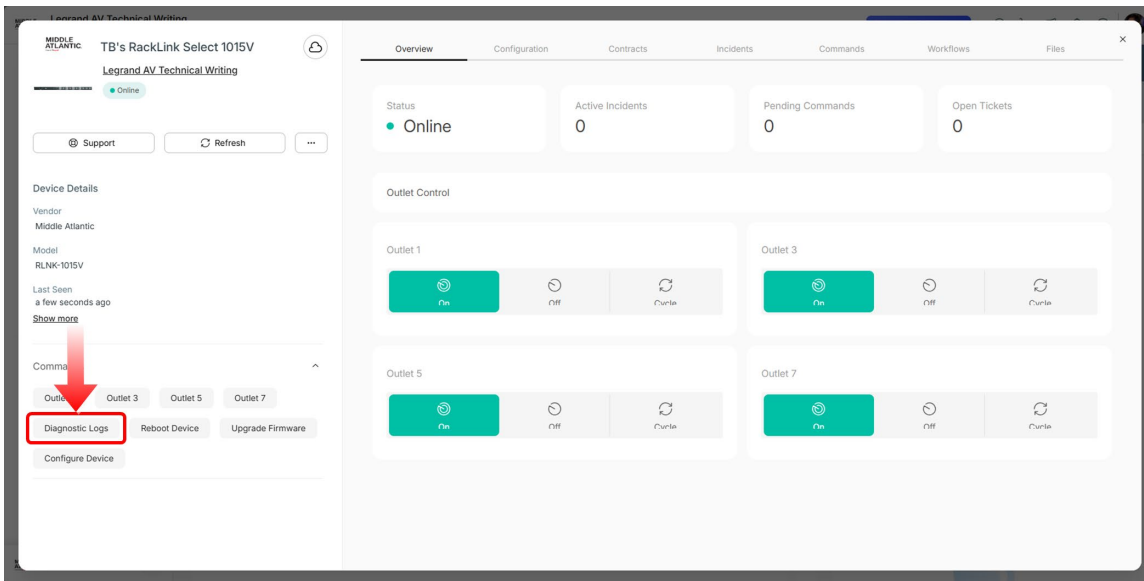

The Confirm Diagnostic Logs command pop-up appears.

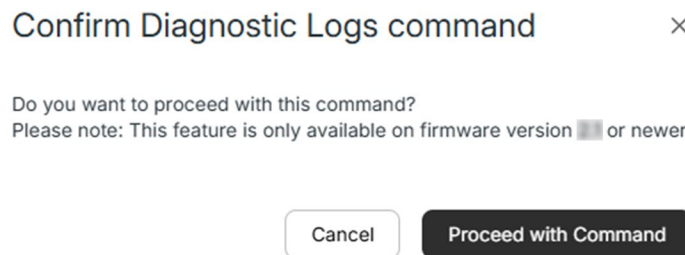

3. Click **Proceed with Command**.

While the command is sent to your unit and executed, the command itself grays out and appears as busy, a command event is recorded on the Commands tab and a notification appears at the bottom center of the screen as shown.

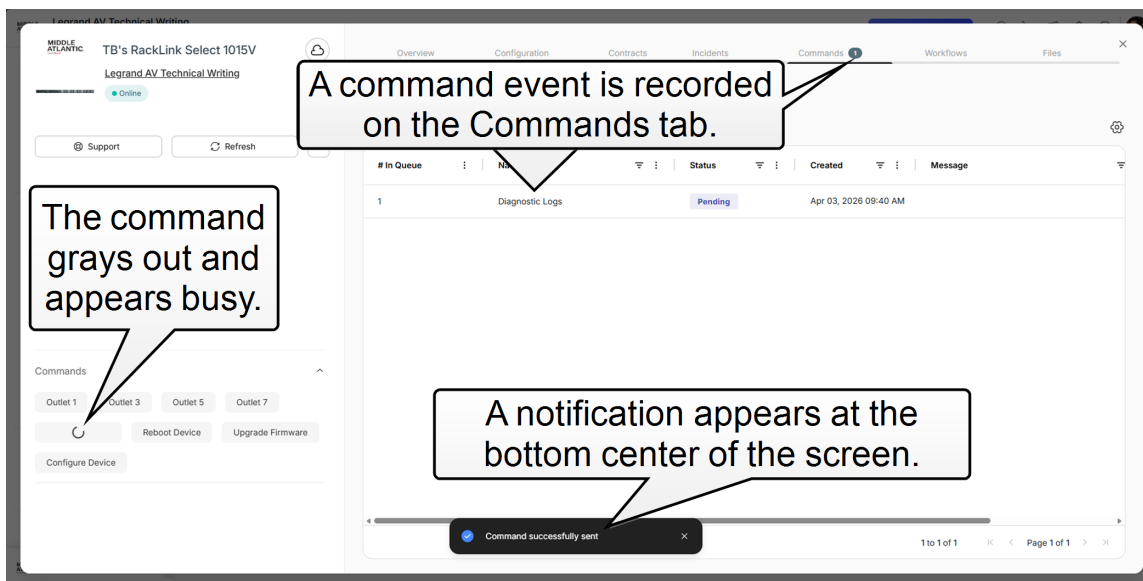

The command appears in the Active & Pending view while the system executes the task. When completed, the record moves to the All Commands view as shown.

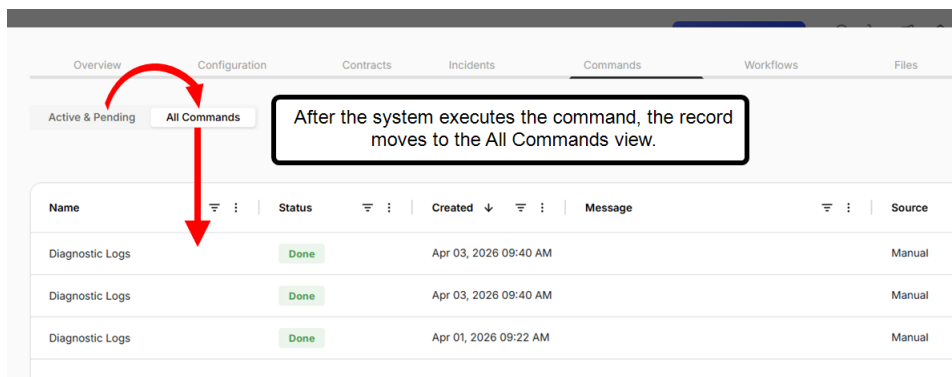

- Use the Commands tab controls as desired.

For more information, see [Using Command Tab Controls](#), on page 194.

- Click the **Files** tab.

Locate the Diagnostic Logs file you wish to download from the list of files shown.

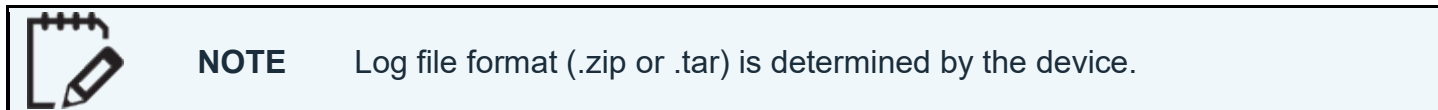

- Click **Download**.

## Using the Configure Device Command

1. Access the Device Dashboard.

For more information, see [Enabling, Registering, and Claiming Your Device in the Cloud](#), on page 163.

2. Click the **Configure Device** command.

 **NOTE** Many cloud topic images come from a RackLink Premium Plus P915R or Select 1015V model PDU. Procedures and images are similar for other cloud-enabled products unless otherwise noted.

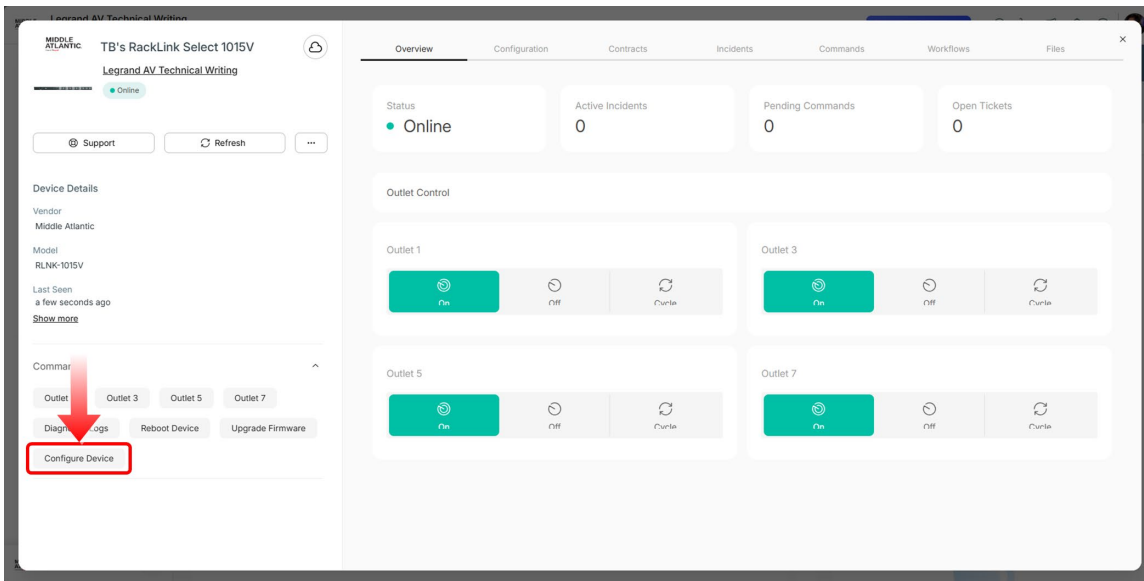

The Configure Device File Selection pop-up appears.

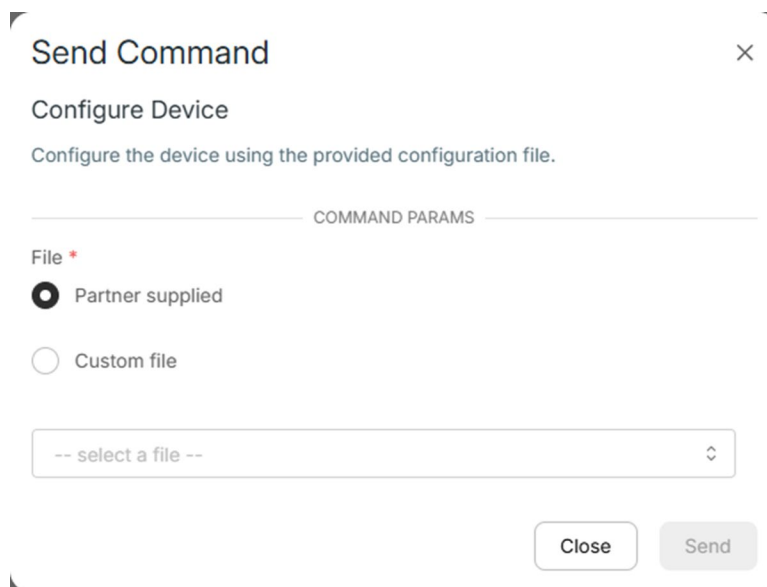

3. Select **Partner supplied** or **Custom file** from the File radio button as shown.

Use one of the following topics based on your selection.

#### Partner supplied

Refers to configuration (and other) files uploaded onto the platform by Legrand AVD or Middle Atlantic. The files are then available for your use on applicable device models when claimed in the system.

For more information, see [Using Partner-Supplied Files in the Cloud](#), on page 185.

#### Custom file

Refers to configuration (and other) files you manually upload to your specific cloud tenant and site on the cloud platform. The files are then available for your use on applicable device models when claimed in the system.

For more information, see [Using Custom Files in the Cloud](#), on page 189.

### Using the Upgrade Firmware Command



#### NOTE

Make sure you either have access to a partner-supplied firmware file or have a downloaded custom firmware file from your device provider before proceeding.

1. Access the Device Dashboard.

For more information, see [Enabling, Registering, and Claiming Your Device in the Cloud](#), on page 163.

2. Click the **Upgrade Firmware** command.

 **NOTE** Many cloud topic images come from a RackLink Premium Plus P915R or Select 1015V model PDU. Procedures and images are similar for other cloud-enabled products unless otherwise noted.

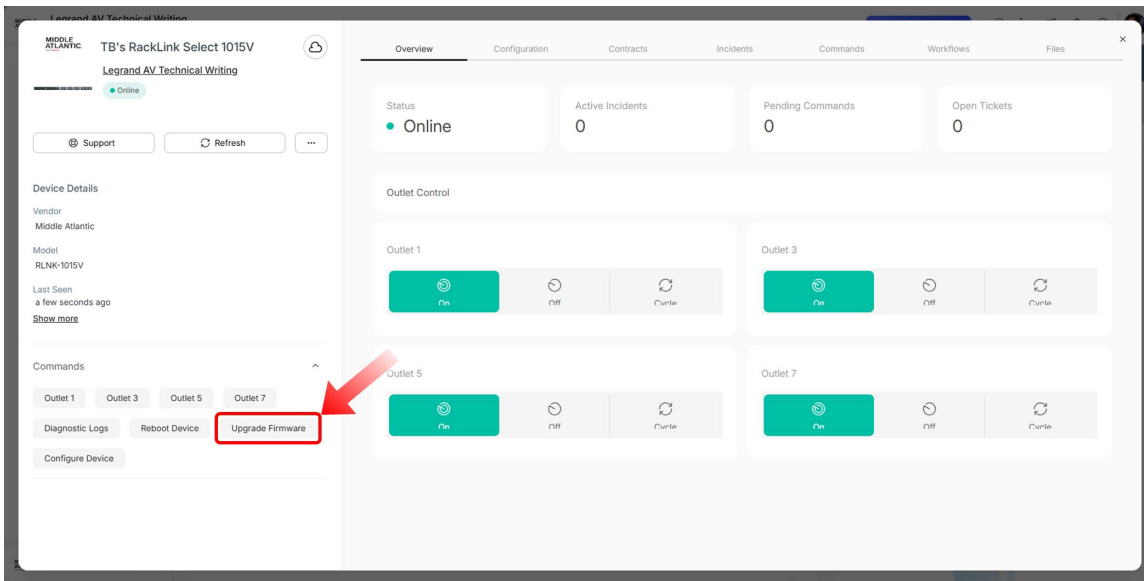

The Upgrade Firmware command pop-up appears.

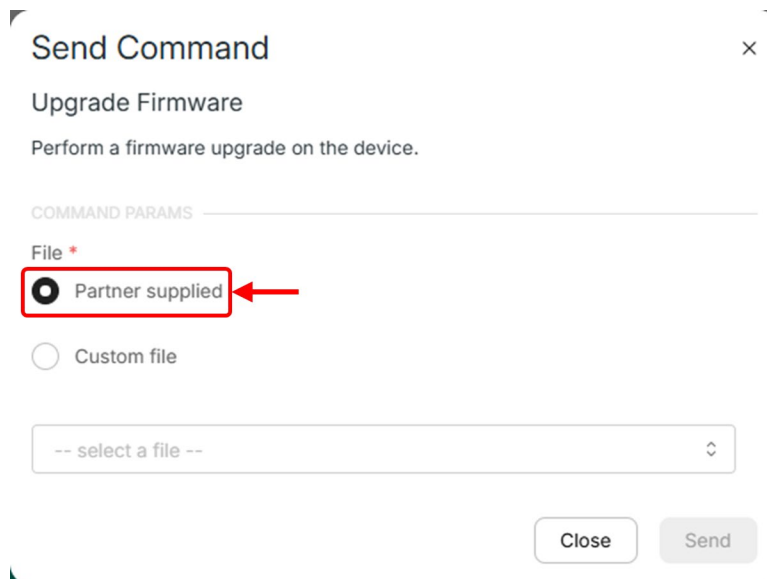

3. Select **Partner supplied** or **Custom file** from the File radio button as shown.

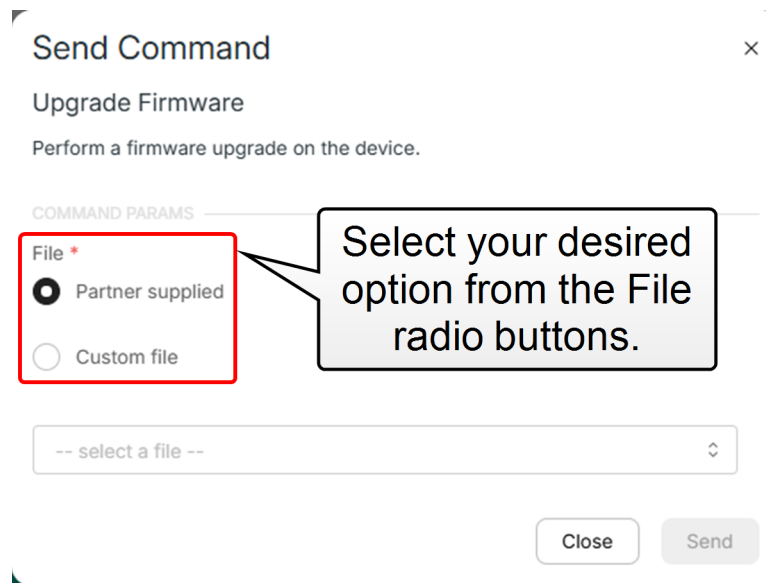

The screenshot shows a 'Send Command' dialog box with the title 'Upgrade Firmware' and the instruction 'Perform a firmware upgrade on the device.' Under the 'COMMAND PARAMS' section, there is a 'File \*' label. Below it are two radio buttons: 'Partner supplied' (which is selected) and 'Custom file'. A red rectangular box highlights these two radio buttons. A callout box with a pointer to the radio buttons contains the text: 'Select your desired option from the File radio buttons.' Below the radio buttons is a dropdown menu with the text '-- select a file --'. At the bottom of the dialog are 'Close' and 'Send' buttons.

Use one of the following topics to complete your upgrade based on your selection.

#### Partner supplied

Refers to configuration (and other) files uploaded onto the platform by Legrand AVD or Middle Atlantic. The files are then available for your use on applicable device models when claimed in the system.

For more information, see [Using Partner-Supplied Files in the Cloud](#), on page 185.

#### Custom file

Refers to configuration (and other) files you manually upload to your specific cloud tenant and site on the cloud platform. The files are then available for your use on applicable device models when claimed in the system.

For more information, see [Using Custom Files in the Cloud](#), on page 189.

### Using Partner-Supplied Files in the Cloud

This procedure picks up where you left off when selecting to use a Partner-Supplied file when executing applicable commands from the Cloud.

**NOTE**

- Partner-supplied files are uploaded onto the platform by Legrand AVD or Middle Atlantic. The files are then available for your use on applicable device models when claimed in the system. Make sure you have access to a partner-supplied file from your device provider before proceeding.
- Images in this topic shows how to use a Partner-Supplied file while executing a Firmware Upgrade command. Procedures and images are similar for other applicable commands unless otherwise noted.
- File types vary based on applicable commands and include extensions like `.hex` (often used for PDU firmware files), `.bin` (often used for UPS firmware files), and `.json` (often used for configuration files) to name a file.

1. Select **Partner supplied** from the File radio buttons as shown.

**Send Command** ×

Upgrade Firmware

Perform a firmware upgrade on the device.

COMMAND PARAMS

File \*

Partner supplied ←

Custom file

-- select a file --

Close Send

2. Use the Select a file drop-down to choose one of the available partner-supplied firmware files listed.

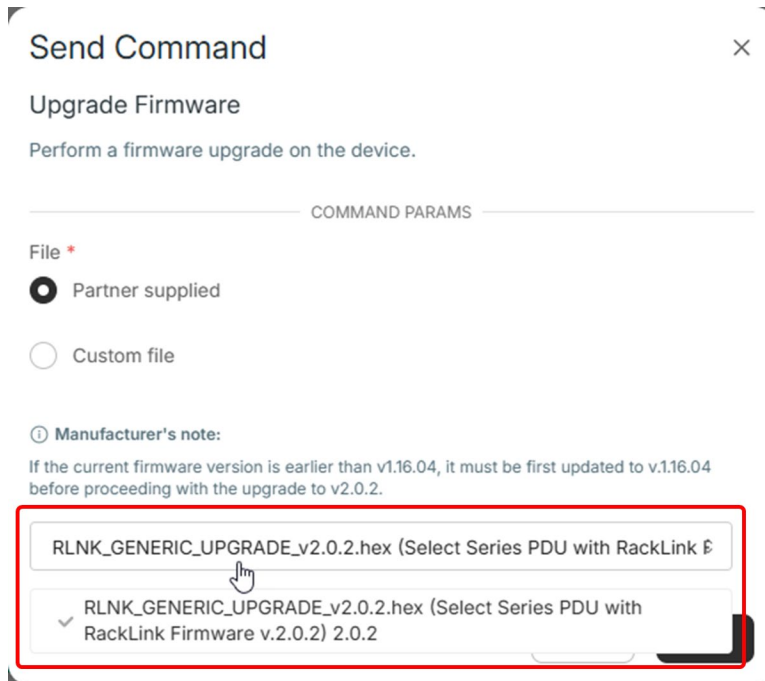

3. Click **Send** to transmit the selected partner-supplied file to your connected device from the Cloud.

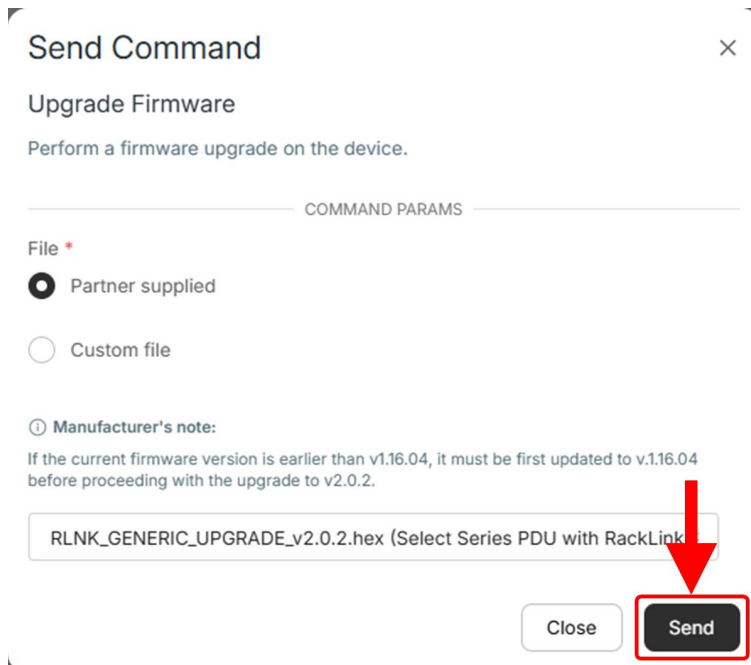

A Confirm command pop-up appears.

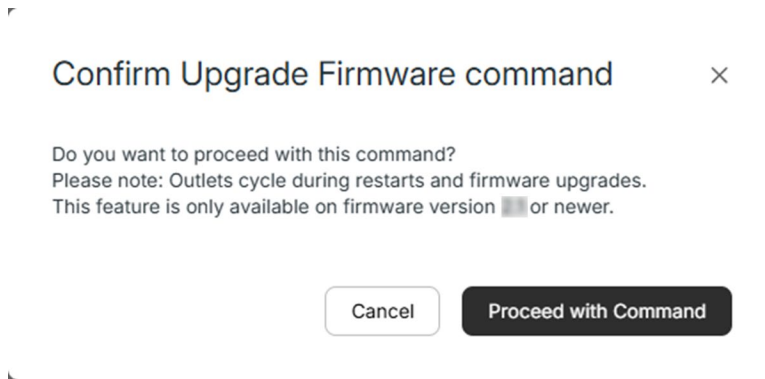

4. Click **Proceed with Command**.

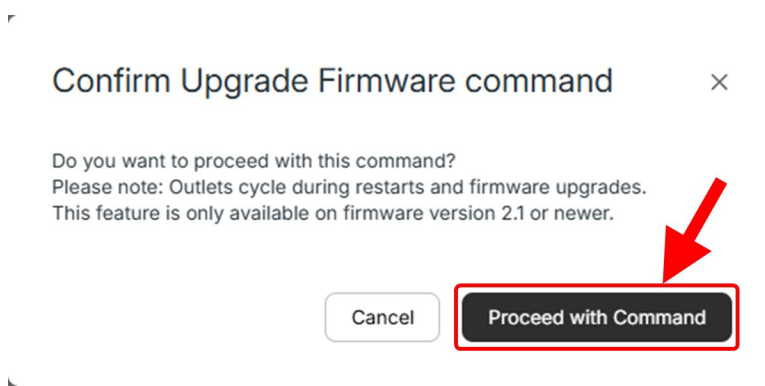

**CAUTION** Do not disconnect power or restart the device during a firmware upgrade. Doing so may cause permanent hardware damage.

**ATTENTION** Ne pas débrancher l'alimentation ou redémarrer l'appareil pendant une mise à jour du micrologiciel. Cela pourrait causer des dommages matériels permanents.

While the command is sent to your unit and executed, the command itself grays out and appears as busy, a command event is recorded on the Commands tab, and a notification appears at the bottom center of the screen as shown.

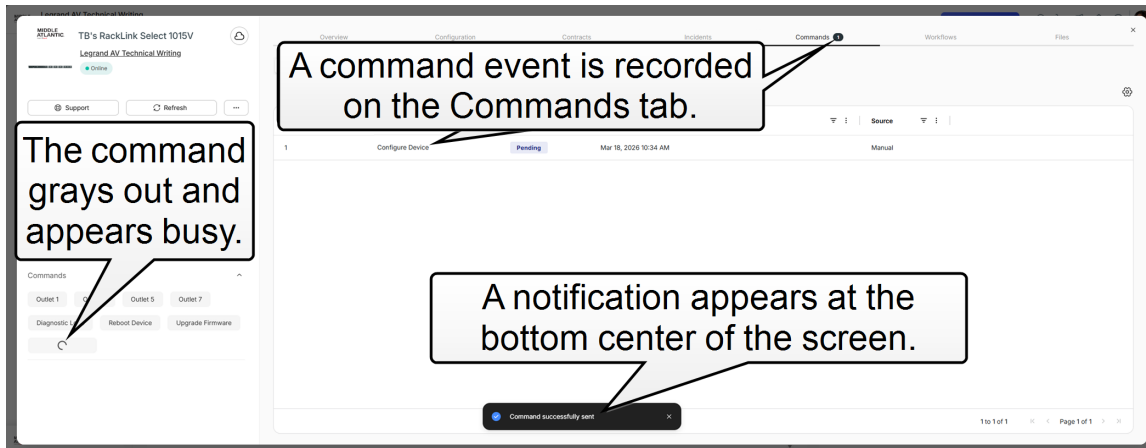

The command appears in the Active & Pending view while the system executes the task. When completed, the record moves to the All Commands view as shown.

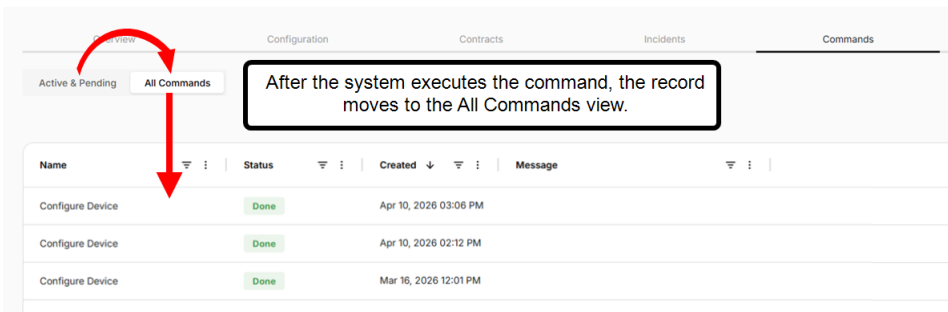

5. Use the Commands tab controls as desired.

For more information, see [Using Command Tab Controls](#), on page 194.

## Using Custom Files in the Cloud

This procedure picks up where you left off when selecting to use a Custom file when executing applicable commands from the Cloud.



### NOTE

- Custom files are manually uploaded by you onto your specific cloud tenant and site on the cloud platform. The files are then available for your use on applicable device models when claimed in the system. Make sure you have access to a custom file before proceeding.
- Images in this topic show how to use a Custom file while executing a Firmware Upgrade command. Procedures and images are similar for other applicable commands unless otherwise noted.
- File types vary based on applicable commands and include extensions like `.hex` (often used for PDU firmware files), `.bin` (often used for UPS firmware files), and `.json` (often used for configuration files) to name a few.

1. Select **Custom file** from the File radio buttons as shown.

Send Command ×

Upgrade Firmware

Perform a firmware upgrade on the device.

COMMAND PARAMS

File \*

Partner supplied

Custom file

-- select a file -- ⌵ Upload file

Close Send

2. Click **Upload file**.

The Upload file screen appears where you can Upload a file or Add a link.

**Upload file** ×

Upload a file  Add a link

File \*

Drag & drop files here  
or  
[Upload from computer](#)

File name \*

Description

Version

Checksum ⓘ

Signature ⓘ

Notes

Cancel Add

- Do the following if you are uploading a file.
  - a. Select **Upload a file** from the radio buttons at the top.
    - Drag and drop the firmware file into the box with the dashed border.
    - OR**
    - Click **Upload from computer** and locate your firmware file.



The system loads the firmware file into the Upload file screen and populates some of the fields.

 **NOTE** The only required fields on the Upload file screen are the actual firmware File and the File name.

### Upload file ×

Upload a file  Add a link

File \*

 ✓ RLNK\_SELECT\_UPGRADE\_v2.1.0.hex uploa... 

File name \*

Description

Version

Checksum

Signature

Notes

- b. Make changes to available field values as desired.
- c. Click **Add**.

- Do the following if you are adding a link.
  - Select **Add a link** from the radio buttons at the top.

Upload file
×

Upload a file  Add a link

**File link \***

**File name \***

Description

Version

Checksum

 ⓘ

Signature

 ⓘ

Notes

Cancel
Add

- Provide a link to your device provider's firmware file in the File link field.

**NOTE**

- The File link must be a URL starting with `https://` and cannot be a local file.
- The only required fields on the Add a link screen are the firmware File link and the File name.

- Make changes to available field values as desired.
- Click **Add**.

**NOTE**

Added files and links then appear on the select a file drop-down on the specific device and selected tenant.

- Click **Send** to transmit the selected custom firmware file to your connected device from the Cloud.

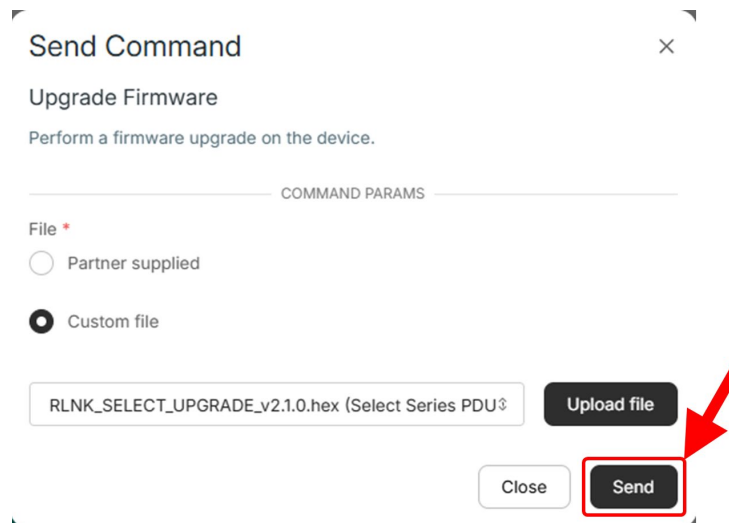

The image shows a 'Send Command' dialog box with a close button (X) in the top right corner. The title is 'Send Command'. Below the title is the section 'Upgrade Firmware' with the instruction 'Perform a firmware upgrade on the device.' Underneath is a horizontal line labeled 'COMMAND PARAMS'. Below that is the 'File' section with two radio buttons: 'Partner supplied' (unselected) and 'Custom file' (selected). Below the radio buttons is a text input field containing 'RLNK\_SELECT\_UPGRADE\_v2.1.0.hex (Select Series PDU)'. To the right of the input field is an 'Upload file' button. Below the input field and 'Upload file' button are two buttons: 'Close' and 'Send'. The 'Send' button is highlighted with a red box and a red arrow points to it from the right.

A Confirm command pop-up appears.

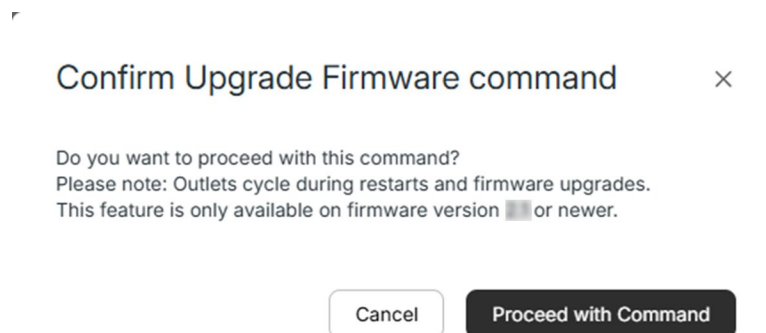

The image shows a 'Confirm Upgrade Firmware command' dialog box with a close button (X) in the top right corner. The title is 'Confirm Upgrade Firmware command'. Below the title is the text: 'Do you want to proceed with this command? Please note: Outlets cycle during restarts and firmware upgrades. This feature is only available on firmware version 2.1 or newer.' At the bottom are two buttons: 'Cancel' and 'Proceed with Command'.

- Click **Proceed with Command**.

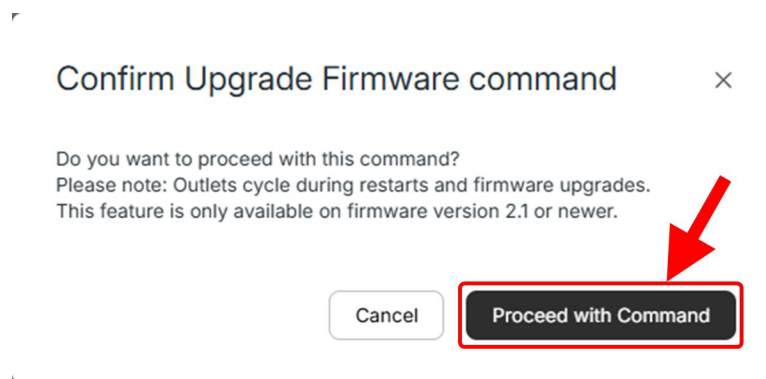

The image shows a 'Confirm Upgrade Firmware command' dialog box with a close button (X) in the top right corner. The title is 'Confirm Upgrade Firmware command'. Below the title is the text: 'Do you want to proceed with this command? Please note: Outlets cycle during restarts and firmware upgrades. This feature is only available on firmware version 2.1 or newer.' At the bottom are two buttons: 'Cancel' and 'Proceed with Command'. The 'Proceed with Command' button is highlighted with a red box and a red arrow points to it from the right.

**CAUTION**

Do not disconnect power or restart the device during a firmware upgrade. Doing so may cause permanent hardware damage.

**ATTENTION**

Ne pas débrancher l'alimentation ou redémarrer l'appareil pendant une mise à jour du micrologiciel. Cela pourrait causer des dommages matériels permanents.

While the command is sent to your unit and executed, the command itself grays out and appears as busy, a command event is recorded on the Commands tab, and a notification appears at the bottom center of the screen as shown.

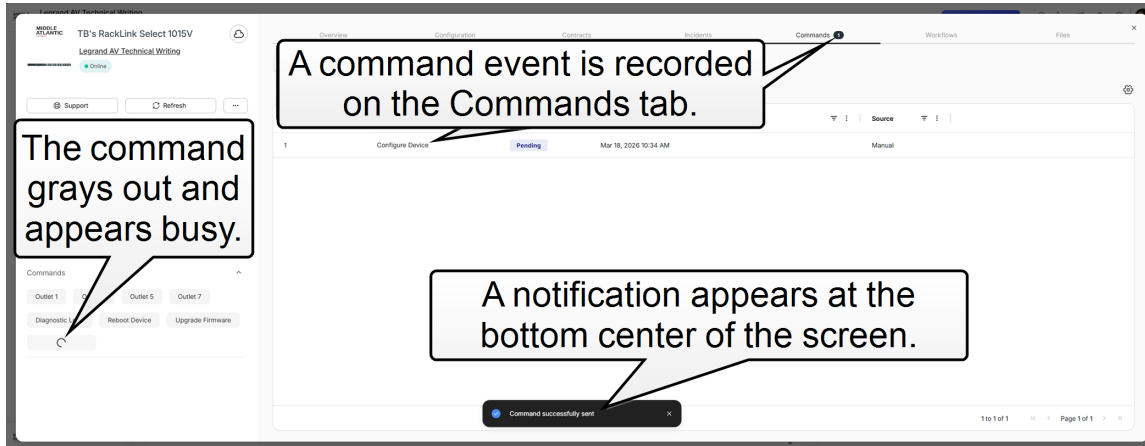

The command appears in the Active & Pending view while the system executes the task. When completed, the record moves to the All Commands view as shown.

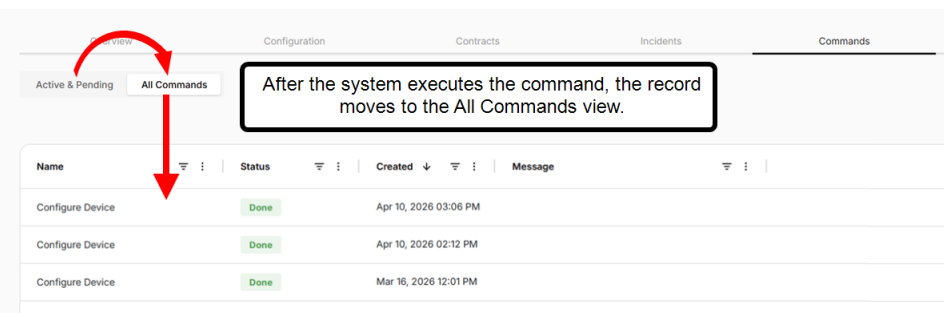

5. Use the Commands tab controls as desired.

For more information, see [Using Command Tab Controls](#), on page 194.

## Using Command Tab Controls

Use the following steps to understand Command Tab Controls after executing Cloud commands.

1. You have already performed the following steps in order to access Command Tab controls:

- Connect to your device in the Cloud.

For more information, see [Enabling, Registering, and Claiming Your Device in the Cloud](#), on page 163.

- Executed your desired command from the following:
  - [Using Controllable Outlets on Cloud-Connected Devices](#), on page 175
  - [Using the Reboot Device Command](#), on page 177
  - [Using the Diagnostic Logs Command](#), on page 179
  - [Using the Configure Device Command](#), on page 182
  - [Using the Upgrade Firmware Command](#), on page 183.
- 2. After clicking Proceed with Command on a pop-up confirmation, the Command tab appears.

After the system executes the command, the record moves to the All Commands view.

Name	Status	Created	Message	Source
Reboot Device	Done	Mar 18, 2026 10:40 AM		Manual
Reboot Device	Done	Mar 18, 2026 10:34 AM		Manual
Reboot Device	Done	Mar 18, 2026 10:31 AM		Manual



#### NOTE

- Commands tab controls are shown in this topic using the Active & Pending view after executing a Reboot command. Controls are similar from the Active & Pending or All Commands view on other commands unless otherwise noted.
- Many cloud topic images come from a RackLink Premium Plus P915R or Select 1015V model PDU. Procedures and images are similar for other cloud-enabled products unless otherwise noted.

- Double-click a specific command record from either the Active & Pending or All Commands views and a details screen appears as shown.

 **NOTE** A Cancel button is only available when accessing the details screen from the Active & Pending view. Otherwise, display fields are similar on the details screen from the Active & Pending or All Commands view.

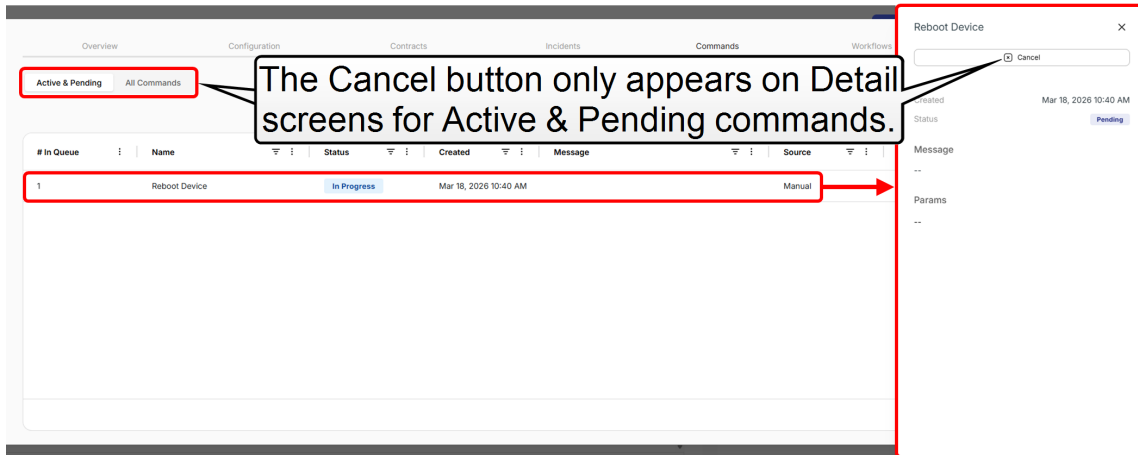

- Use column heading controls to filter, sort, and resize the columns as desired.

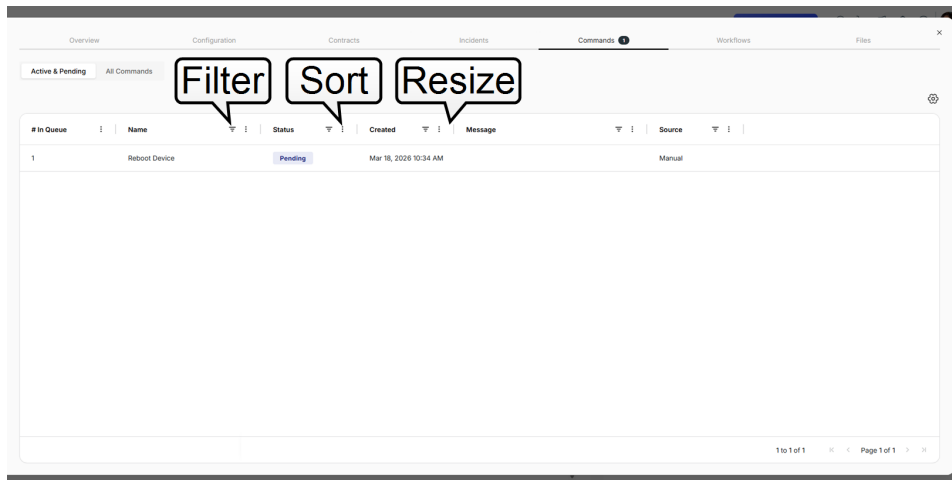

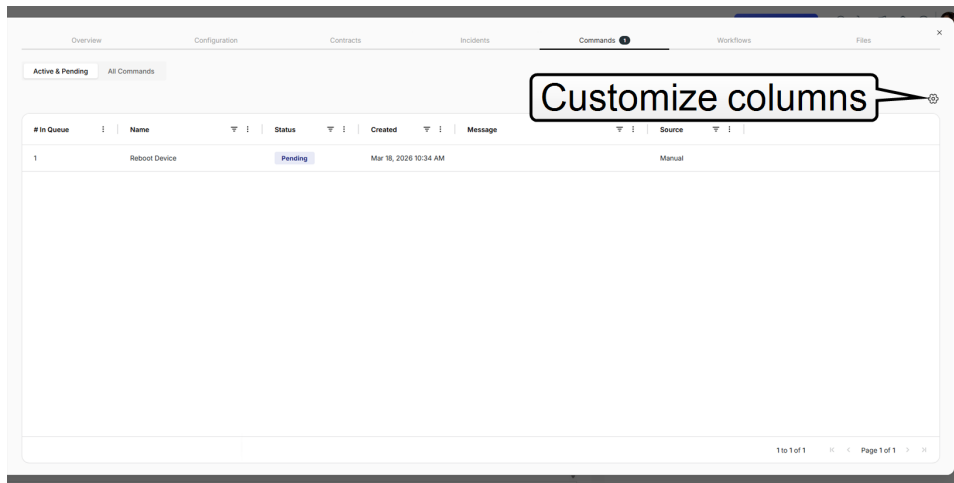

- Click Customize columns to select and sort them on the Commands tab as shown.

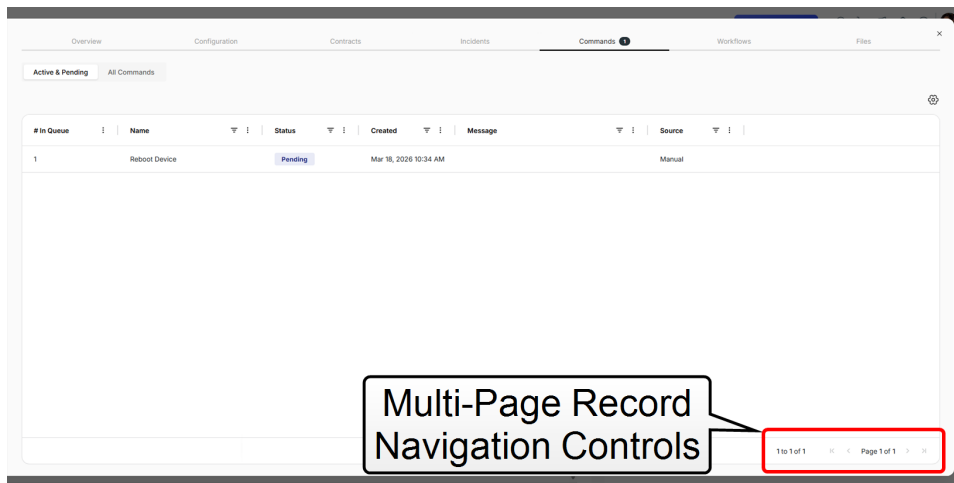

- Navigate multi-page records from either the Active & Pending or All Commands views using the controls on the lower-right of the screen.



 **TIP** Use the Files tab to find downloads that were stored as part of an executed command, such as Diagnostic Logs.

 **NOTE** Log file format (.zip or .tar) is determined by the device.

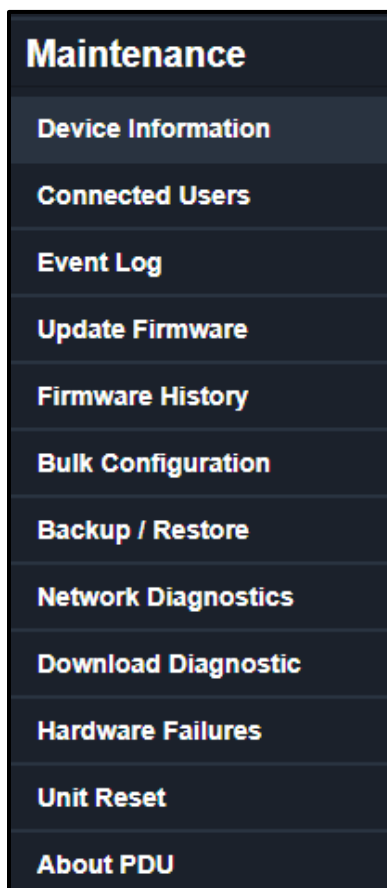

## Maintenance

Click 'Maintenance' in the [Menu](#), on page 28, and the following submenu appears.



### Viewing Enabled or Disabled Users

- Select User Management > Users to open the Users page, which lists all user accounts.
- View one of the following icons for each user listed in the Enabled column:

- : The user is enabled.
- : The user is disabled.



#### TIP

If desired, you can sort the list by clicking the desired column header. For more information, see [Sorting a List](#), on page 29.

## Device Information

Using the web interface, you can retrieve hardware and software information of components or peripheral devices connected to your PDU.



### TIP

If the information shown on this page does not match the latest status, press F5 to reload it.

- Choose Maintenance > Device Information.
- Click the desired section's title bar to show that section's information. For example, click the Network section.

Network 

The number of available sections is model dependent.

Section title	Information shown
Information	General device information, such as model name, serial number, firmware version, hardware revision, MIB download link(s) and so on.
Network	The network information, such as the current networking mode, IPv4 and/or IPv6 addresses.
Port Forwarding	Displays port forwarding settings for your network.
Outlets	Each outlet's label, receptacle type, operating voltage and rated current.
Controllers	Each inlet or outlet controller's serial number, board ID, firmware version, and hardware version.
Peripheral Devices	Serial numbers, model names, position and firmware-related information of connected environmental sensor packages.
Asset Management	Provides device information regarding type, number of components, device ID, hardware version, boot version, app version, and protocol state.

## Viewing Connected Users

You can check which users have logged in to the PDU and their status. If you have administrator privileges, you can terminate any user's connection to the PDU.

- Choose Maintenance > Connected Users.
- The Connected Users page appears.

If desired, you can sort the list by clicking the desired column header. For more information, see [Sorting a List](#), on page 29.

Column	Description
User name	The login name of each connected user.
IP Address	The IP address of each user's host. For the login via a local connection (serial RS-232 or USB), <local> is displayed instead of an IP address.
Client Type	The interface through which the user is being connected to the PDU. <ul style="list-style-type: none"> <li>• Web GUI: Refers to the web interface.</li> <li>• CLI: Refers to the command line interface (CLI). <ul style="list-style-type: none"> <li>▪ The information in parentheses following "CLI" indicates how this user is connected to the CLI.</li> <li>▪ Serial: The local connection, such as the serial RS-232 or USB connection.</li> <li>▪ SSH: The SSH connection.</li> <li>▪ Telnet: The Telnet connection.</li> </ul> </li> </ul>
Idle Time	The length of time for which a user remains idle.

- Click the corresponding **Disconnect** button to disconnect any user.
  - Click Disconnect on the confirmation message.
  - The disconnected user is forced to log out.

## Viewing or Clearing the Local Event Log

By default, the PDU captures certain system events and saves them in a local (internal) event log. You can view over 2000 historical events that occurred on the PDU in the local event log. When the log size exceeds 256KB, each new entry overwrites the oldest one.

- Choose Maintenance > Event Log.
- The Event Log page appears.

The screenshot shows the 'EVENT LOG' interface. At the top right, there are 'Pause' and 'Clear Log' buttons. Below the title, there is a 'Filter Event Class:' dropdown menu set to 'PDU'. Below the filter, there are navigation buttons: 'First', 'Previous', '1', '2', 'Next', and 'Last'. The main content is a table with the following data:

ID ▲	Timestamp	Event Class	Event
2904	12/31/1969, 7:12:22 PM UTC-0500	PDU	Controller '27500106' with board ID 0x90 is no longer OK
2905	12/31/1969, 7:12:22 PM UTC-0500	PDU	Communication with controller '27500106' (board ID 0x90) failed
2943	12/31/1969, 7:12:23 PM UTC-0500	PDU	Controller '27500106' with board ID 0x90 is no longer OK
2944	12/31/1969, 7:12:23 PM UTC-0500	PDU	Communication with controller '27500106' (board ID 0x90) failed
2979	12/31/1969, 7:12:24 PM UTC-0500	PDU	Communication with controller '27500106' (board ID 0x90) restored

- Click the Pause button to stop updating the page with log information from your PDU.

- Click the Clear Log button to delete the current log data from the Event Log page and your PDU.
- Select the desired event type in the Filter Event Class field to view only specific event types.

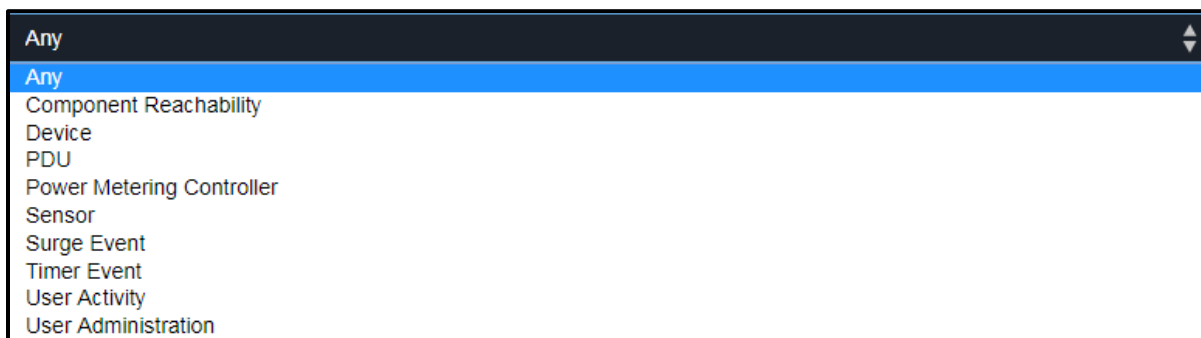

- The List of event logs include entries with the following information.
  - ID number of the event
  - Date and time of the event
  - Event Class
  - A description of the event
- Click the pagination bar at the top or bottom of the page to navigate other pages of the log.
- If there are more than 5 pages and the page numbers displayed in the bar does not show the desired one, click  to have it show the next or previous five page numbers, if available.

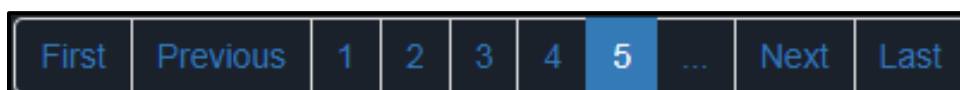

- If desired, you can sort the list by clicking the desired column header. For more information, see [Sorting a List](#), on page 29.

## Updating the PDU Firmware

Firmware files are available at <https://www.legrandav.com/resources/power-downloads>.

When performing the firmware upgrade, the PDU keeps each outlet's power status unchanged so no server operation is interrupted. During and after the firmware upgrade, outlets that have been powered on prior to the firmware upgrade remain powered on and outlets that have been powered off remain powered off.

You must be the administrator or a user with the Firmware Update permission to update the PDU firmware.

If you have any questions or concerns about the upgrade, contact Technical Support BEFORE upgrading.

**NOTE**

Performing a firmware upgrade on some mobile devices, such as an iPad, often require the installation and use of a file manager application.

**CAUTION**

Do not perform the firmware upgrade over a wireless network connection.

**ATTENTION**

N'effectuez pas la mise à jour du micrologiciel via une connexion réseau sans fil.

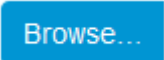
- Choose Maintenance > Update Firmware.
- Click  to select an appropriate firmware file.
- Click Upload. A progress bar appears to indicate the upload process.
- Once complete, information of both installed and uploaded firmware versions as well as compatibility and signature-checking results are displayed.
- If anything is incorrect, click Discard Upload.
- Click Update Firmware to proceed with the update.

**CAUTION**

Do not power off the PDU during the firmware update.

**ATTENTION**

Ne pas éteindre la PDU pendant la mise à jour du micrologiciel.

- During the firmware update:
  - a. A progress bar appears on the web interface, indicating the update status.
  - b. The outlet LEDs flash if the relay boards are being updated. If the firmware update does not include the update of the relay board firmware, outlet LEDs do NOT flash.
  - c. No users can successfully log in to the PDU.
  - d. Other users' operation, if any, is forced to suspend.
    - When the update is complete, the PDU resets, and the Login page re-appears.
    - Other logged-in users are logged out when the firmware update is complete.

**CAUTION**

If you are using the PDU with an SNMP manager, download its MIB again after the firmware update to ensure your SNMP manager has the correct MIB for the latest release you are using. For more information, see [Using SNMP](#), on page 224.

**ATTENTION**

Si vous utilisez la PDU avec un gestionnaire SNMP, téléchargez à nouveau son MIB après la mise à jour du micrologiciel pour vous assurer que votre gestionnaire SNMP dispose du bon MIB pour la dernière version que vous utilisez. Pour plus d'informations, voir [Using SNMP](#) page 224.

## Alternative Firmware Updating Methods

Refer to the following resources to use a different firmware update method:

- Firmware Update via SCP in the Premium+ PDU With RackLink Advanced User Manual at [www.legrandav.com](http://www.legrandav.com).
- Bulk Configuration or Firmware Upgrade via DHCP/TFTP in the Premium+ PDU With RackLink Advanced User Manual at [www.legrandav.com](http://www.legrandav.com).
- Firmware Upgrade via USB in the Premium+ PDU With RackLink Advanced User Manual at [www.legrandav.com](http://www.legrandav.com).

## Understanding Firmware Upgrade Duration

The PDU firmware upgrade time varies from unit to unit, depending on various external and internal factors.

External factors include, but are not limited to: network throughput, firmware file size, and speed at which the firmware is retrieved from the storage location. Internal factors include: the necessity of upgrading the firmware on the microcontroller and the number of microcontrollers that require upgrade (which depends on the number of outlets). The microcontroller is upgraded only when required. Therefore, the length of firmware upgrade time ranges from approximately 3 minutes (without any microcontroller updated) to almost 7 minutes (with all microcontrollers for 48 outlets updated).

Take the above factors into account when estimating the PDU's firmware upgrade time.

The time indicated in this note is for PDU web interface-based upgrades. Upgrades through other management systems may take additional time beyond the control of the PDU itself. This note does not address the upgrades using other management systems.

## Performing a Full Recovery

If the firmware upgrade fails, causing the PDU to stop working, you can recover it by using a special utility rather than returning the device.

Contact Technical Support for the recovery utility, which works in Windows XP/Vista/7/10 and Linux. In addition, an appropriate PDU firmware file is required in the recovery procedure.



**NOTE** All PDUs can be recovered via either a USB or serial RS-232 connection.

## Viewing Firmware Update History

The firmware upgrade history is permanently stored on the PDU. It remains available even though you perform a device reboot or any firmware update.

- Choose Maintenance > Firmware History.

Each firmware update event consists of:

- Update date and time
- Previous firmware version
- Update firmware version

- Update result
  - If desired, you can sort the list by clicking the desired column header. For more information, see [Sorting a List](#), on page 29.

## Bulk Configuration

The Bulk Configuration feature lets you save generic settings of a configured PDU to your computer. You can use this configuration file to copy common settings to other PDUs of the same model and firmware version. For more information, see [Bulk Configuration Restrictions](#), on page 207.



### NOTE

**NO device-specific data is saved** to the bulk configuration file, such as environmental sensors or certain network settings. For a list of device-specific settings that are *not* saved, see [Device-Specific Settings NOT Included](#), on page 207.

Because the date and time settings are saved in the configuration file, users should exercise caution when distributing the configuration file to the PDUs in a different time zone than the source device.



### TIP

Back up or restore "all" settings of a particular PDU by using the Backup/Restore feature instead. For more information, see [Backup and Restore of Device Settings](#), on page 208.

## Viewing Or Editing Existing Bulk Profiles

- Choose Maintenance > Bulk Configuration.
- The Bulk Profiles and Bulk Configuration page appears.

If desired, you can sort the list in the Bulk Profiles section by clicking the desired column header. For more information, see [Sorting a List](#), on page 29.

Column	Description
#	The assigned number to the bulk profile.
Name	The name of the bulk profile.
Description	The description of the bulk profile.
Default Profile	A check mark appears in the corresponding row of the default profile.

- Click an existing Bulk Profile on the list.
- Its corresponding Edit Bulk Profile page appears.



### NOTE

The Bulit in bulk profile may be viewed from the Bulk Profiles and Edit Bulk Profile pages, but cannot be edited.

- Make changes as desired.
- Click **Save**.

### Adding a Bulk Profile

- Choose Maintenance > Bulk Configuration.
- The Bulk Profiles and Bulk Configuration page appears.
- Click .
- The New Bulk Profile screen appears.

If desired, you can sort the list by clicking the desired column header. For more information, see [Sorting a List](#), on page 29.

- Configure the following.
- Profile Name: Add a name for your new bulk profile with no spaces.



**NOTE** The name must only contain alphanumeric, +, -, or / characters.

- Description: Add a description for your new bulk profile.
- Select the Select as default profile checkbox as desired.
- Modify the Filter settings as desired. Use the drop-down to select Inherited, Included, or Excluded for each setting.

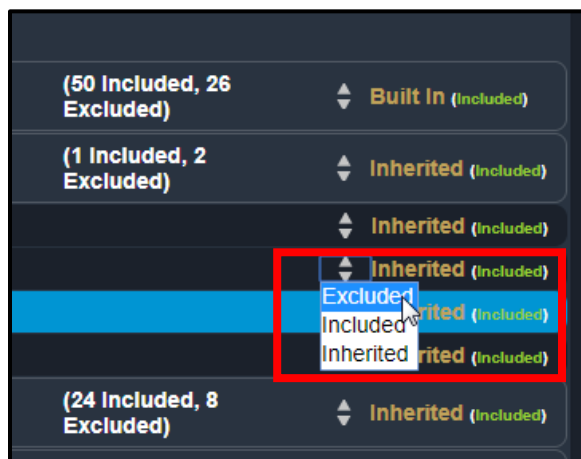

- Click **Save**.

### Saving a Bulk Configuration File



**NOTE** You must have the Administrator Privileges or "Unrestricted View Privileges" to download the configuration. For more information, see [Creating Roles](#), on page 82.

- Log in to the PDU whose settings you want to copy from.
- Choose Maintenance > Bulk Configuration.
- The Bulk Profiles and Bulk Configuration page appears.
- Use the drop-down to select whether you want your bulk configuration file encrypted or stored as clear text.
- Click Download Bulk Configuration.

- When prompted to open or save the configuration file, click **Save**.
- The file is saved in the XML format, and, if encrypted is selected as the backup format, its content is encrypted using the AES-128 encryption algorithm.

## Restoring a Bulk Configuration File



### NOTE

You must have the Administrator Privileges or "Unrestricted View Privileges" to download the configuration. For more information, see [Creating Roles](#), on page 82.

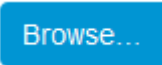
- Log in to another PDU of the same model running the same firmware.
- Choose Maintenance > Bulk Configuration.
- The Bulk Profiles and Bulk Configuration page appears.
- Click  to select the configuration file.
- Click 'Upload & Restore Bulk Configuration' to copy it.
- A message appears, prompting you to confirm the operation and enter the admin password.

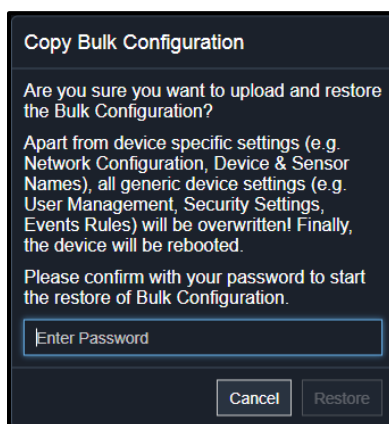

- Enter the admin password, and click Restore.
- A second message appears notifying you that your PDU will reset and you'll be take to the login page.

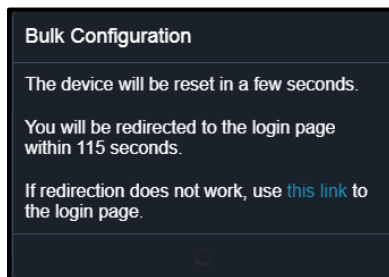

- Wait until the PDU resets and the login page re-appears.

**NOTE**

On startup, the PDU performs all of its functions, including event rules and logs, based on the new configuration you have copied instead of the previous configuration prior to the device reset. For example, the "Bulk configuration copied" event is logged only when the new configuration file contains the "Bulk configuration copied" event rule.

### Viewing the Last Configuration Copying Record

- Choose Maintenance > Bulk Configuration.
- The Bulk Profiles and Bulk Configuration page appears.
- After copying a bulk configuration or device backup file to the PDU, the last record similar to the following is displayed at the bottom of both the Bulk Configuration and Backup/Restore pages.

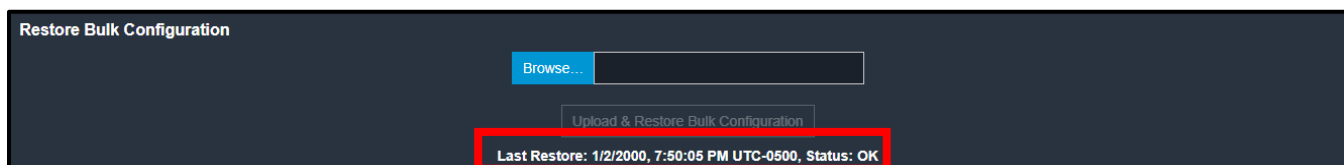

### Understanding Alternative Bulk Configuration Methods

You may use a different method to perform bulk configuration by referring to:

- Bulk Configuration via SCP in the Premium+ PDU With RackLink Advanced User Manual at [www.legrandav.com](http://www.legrandav.com).
- Bulk Configuration or Firmware Upgrade via DHCP/TFTP in the Premium+ PDU With RackLink Advanced User Manual at [www.legrandav.com](http://www.legrandav.com).
- Configuration or Firmware Upgrade with a USB Drive in the Premium+ PDU With RackLink Advanced User Manual at [www.legrandav.com](http://www.legrandav.com).

### Bulk Configuration Restrictions

A source device is the PDU where the bulk configuration file is downloaded/saved.

A target device is the PDU that loads this bulk configuration file.

- The target device must be running the same firmware version as the source device.
- The target device must be of the same model type as the source device.
- Bulk configuration is permitted between devices of the same model number type. For instance, you can copy a bulk configuration file from a RLNK-P915R to other RLNK-P915R models.

### Device-Specific Settings NOT Included

The settings saved in the bulk configuration file include user and role configurations, thresholds, event rules, security settings, date/time and so on.

**NOTE**

Because the date and time settings are saved in the configuration file, users should exercise caution when distributing the configuration file to the PDUs in a different time zone than the source device.

The bulk configuration file does NOT contain device-specific information, including:

- Device name
- SNMP system name, contact and location
- Network settings (IP address, gateway, netmask and so on)
- Device logs
- Names, states and values of environmental sensors and actuators
- TLS certificate
- Component monitoring entries
- Outlet names and states

## Backup and Restore of Device Settings

Unlike the bulk configuration file, the backup file contains ALL device settings, including device-specific data like device names and network settings. You should use the Backup/Restore feature to back up or restore a PDU's settings.

All PDU information is captured in the XML backup file except for the device logs and TLS certificate.



### NOTE

Perform bulk configuration among multiple PDUs by using the Bulk Configuration feature instead. For more information, see [Bulk Configuration](#), on page 204.

## Saving Device Settings



### NOTE

You must have the Administrator Privileges or "Unrestricted View Privileges" to download the configuration. For more information, see [Creating Roles](#), on page 82.

- Choose Maintenance > Backup/Restore.
- The Backup/Restore page appears.
- Use the drop-down to select whether you want your bulk configuration file encrypted or stored as clear text.
- Click Download Device Settings. Save the file to your computer.
- The file is saved in the XML format, and, if encrypted is selected as the backup format, its content is encrypted using the AES-128 encryption algorithm.

## Copy Device Settings



### NOTE

You must have the Administrator Privileges or "Unrestricted View Privileges" to download the configuration. For more information, see [Creating Roles](#), on page 82.

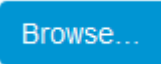
- Choose Maintenance > Backup/Restore.
- The Backup Restore page appears.
- Click  to select the backup file.
- Click 'Upload & Restore Device Settings' to upload the file.

- A message appears, prompting you to confirm the operation and enter the admin password.

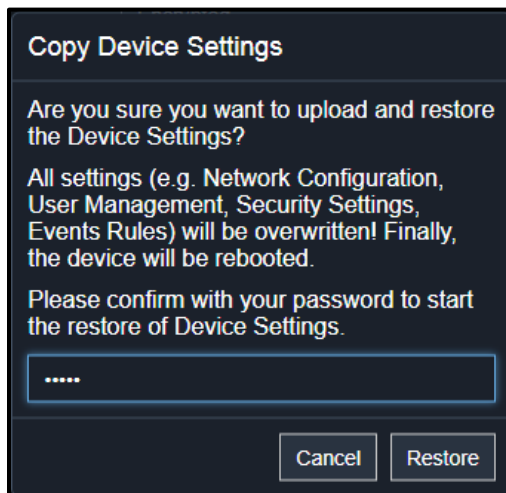

- Enter the admin password, then click Restore.
- A device settings pop-up appears.

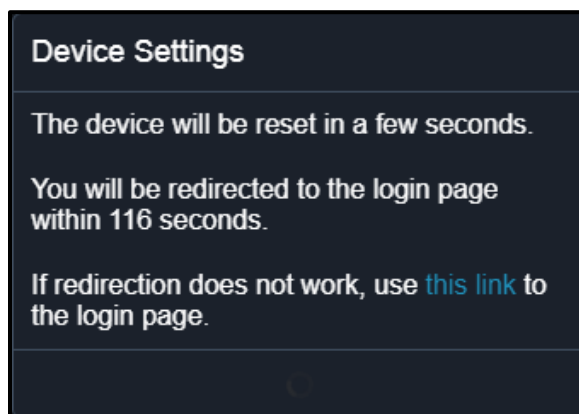

- Wait until the PDU resets and the Login page re-appears, indicating that the restore is complete.

	<b>NOTE</b>	On startup, the PDU performs all of its functions, including event rules and logs, based on the new configuration you have copied instead of the previous configuration prior to the device reset. For example, the "Bulk configuration copied" event is logged only when the new configuration file contains the "Bulk configuration copied" event rule.
---	-------------	---

### Viewing the Last Configuration Copying Record

- Choose Maintenance > Backup/Restore.
- The Backup/Restore page appears.

- After copying a bulk configuration or device backup file to the PDU, the last record similar to the following is displayed at the bottom of both the Bulk Configuration and Backup/Restore pages.

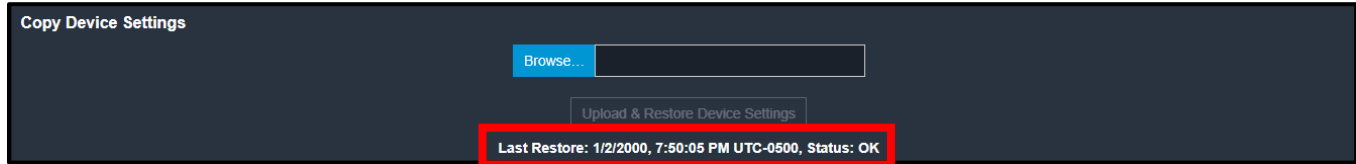

## Understanding Alternative Backup/Restore Methods

Backup/Restore method alternatives:

Use a different method to perform a backup/restore by referring to:

- Backup and Restore via SCP in the Premium+ PDU With RackLink Advanced User Manual at [www.legrandav.com](http://www.legrandav.com).

## Network Diagnostics

The PDU provides the following tools in the web interface for diagnosing potential networking issues.

- Ping: The tool is useful for checking whether a host is accessible through the network or Internet.
- Trace Route: The tool lets you find out the route over the network between two hosts or systems.
- List TCP Connections: You can use this function to display a list of TCP connections.



**TIP** These network diagnostic tools are also available through CLI. For more information, see Network Troubleshooting in the Premium+ PDU With RackLink Advanced User Manual at [www.legrandav.com](http://www.legrandav.com).

Choose Maintenance > Network Diagnostics, and then perform any function below.

### Running a Ping Request

- Choose Maintenance > Network Diagnostics.
- The Network Diagnostics page appears.
- In the Ping section of the page, type values in the following fields.

Field	Description
Network Host	The name or IP address of the host that you want to check.
Number of Requests	A number up to 20. This determines how many packets are sent for pinging the host.

- Click Run Ping to ping the host.
- The Ping results then appear in a pop-up.

### Running a Trace Route

- Choose Maintenance > Network Diagnostics.

- The Network Diagnostics page appears.
- In the Trace Route section of the page, type values in the following fields.

Field or Setting	Description
Host Name	The IP address or name of the host whose route you want to check.
Timeout(s)	A timeout value in seconds to end the trace route operation.
Use ICMP Packets	Select this checkbox to use the Internet Control Message Protocol (ICMP) packets to perform the trace route command.

- Click **Run**.
- The Trace Route results then appear in a pop-up.

### Listing TCP Connections

- Choose Maintenance > Network Diagnostics.
- The Network Diagnostics page appears.
- Click the List TCP Connections title bar to show the list.

List TCP Connections						
Active Internet connections (w/o servers)						
#	Proto	Recv-Q	Send-Q	Local Address	Foreign Address	State
1	tcp	0	0	::ffff:10.90.51.172:443	::ffff:10.90.50.172:63453	TIME_WAIT
2	tcp	0	0	::ffff:10.90.51.172:443	::ffff:10.90.50.172:63408	TIME_WAIT
3	tcp	0	0	::ffff:10.90.51.172:443	::ffff:10.90.50.172:63449	TIME_WAIT
4	tcp	0	0	::ffff:10.90.51.172:443	::ffff:10.90.50.172:63433	TIME_WAIT
5	tcp	0	0	::ffff:10.90.51.172:443	::ffff:10.90.50.172:63429	TIME_WAIT
6	tcp	0	0	::ffff:10.90.51.172:443	::ffff:10.90.50.172:63445	ESTABLISHED
7	tcp	0	0	::ffff:10.90.51.172:443	::ffff:10.90.50.172:63437	TIME_WAIT
8	tcp	0	0	::ffff:10.90.51.172:443	::ffff:10.90.50.172:63461	ESTABLISHED
9	tcp	0	0	::ffff:10.90.51.172:443	::ffff:10.90.50.172:63457	TIME_WAIT
10	tcp	0	0	::ffff:10.90.51.172:443	::ffff:10.90.50.172:63441	TIME_WAIT

## Downloading Diagnostic Information



### CAUTION

This function is used by MAP Technical Support for assistance and troubleshooting.

### ATTENTION

Cette fonction est utilisée par le support technique du MAP pour l'assistance et le dépannage.

You can download the diagnostic file from the PDU to a client machine. The file is compressed into a .tgz file and should be sent to Technical Support for interpretation.

This feature is accessible only by users with Administrative Privileges or Unrestricted View Privileges.

- Choose Maintenance > Download Diagnostic.
- The Download Diagnostic page appears.
- Click **Download Diagnostic**.
- The system prompts you to save or open the file. Click **Save**.

- Email this file as instructed by Technical Support.

## Viewing Hardware Failures

Using the web interface, you can view any hardware issues your PDU has detected, including current and past occurrences.

- Choose Maintenance > Hardware Failures.
- The Hardware Failures page appears.

HARDWARE FAILURES			
<b>Current Hardware Failures</b>			
No current hardware failures			
<b>Past Hardware Failures</b>			
Failure Message	Last Asserted ▲	Last Deasserted	Number of Occurrences
Slave controller ttyS2:0x30 reported a malfunction.	5/9/2019, 11:42:42 AM UTC-0400	5/9/2019, 11:42:43 AM UTC-0400	1

- The page is divided into Current Hardware Failures and Past Hardware Failure sections.



### NOTE

Current hardware failures, if any, also appear on the Alarms section of the dashboard. For more information, see [Alarms](#), on page 31.

Hardware issues	Description
Network device not detected	A specific networking interface of the PDU is not detected.
I2C Bus stuck	A specific I2C bus is stuck, which affects the communication with sensors.
Slave controller not reachable	Communication with a specific slave controller fails.
Slave controller malfunction	A specific slave controller does not work properly.
Outlet power state inconsistent	The physical power state of a specific outlet is different from the chosen power state set by the software.

## Resetting Your PDU via Unit Reset

You can remotely reboot the PDU via the web interface.

Resetting the PDU does not interrupt the operation of connected components because there is no loss of power to outlets. During and after the reboot, outlets that have been powered on prior to the reboot remain powered on, and outlets that have been powered off remain powered off.

### Rebooting the PDU

- Choose Maintenance > Unit Reset.

- The Unit Reset page appears.
- Click **Reboot Unit**.
- A pop-up appears asking you to confirm the reboot.

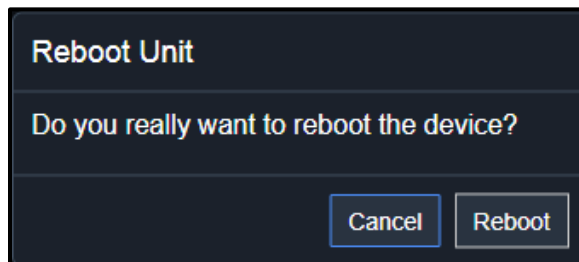

- Click Reboot.
- A pop-up appears with a message and countdown timer showing the remaining time of the operation. It takes about one minute to complete.

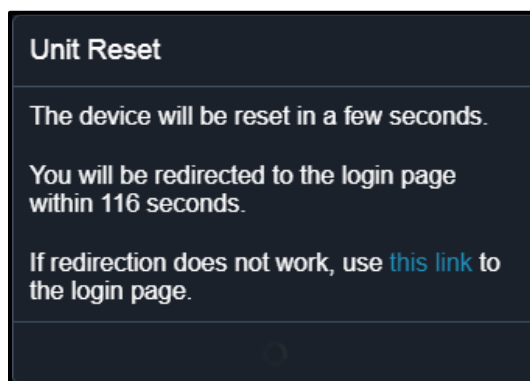

- When the restart is complete, the login page appears.

	<b>NOTE</b> If you are not redirected to the login page after the restart is complete, click the text "this link" in the countdown message.
---	---

## Resetting All Settings to Factory Defaults

	<b>NOTE</b> You must have the Administrator Privileges or "Unrestricted View Privileges" to download the configuration. For more information, see <a href="#">Creating Roles</a> , on page 82.
---	--

	<b>CAUTION</b> Be careful before resetting the PDU to factory defaults. This operation deletes existing information and customized settings, such as user profiles, threshold values and other parameters. Only active energy data and firmware update history are retained.
---	--

**ATTENTION**

Soyez prudent avant de réinitialiser l'unité PDU à ses valeurs par défaut. Cette opération efface les informations existantes et les paramètres personnalisés, tels que les profils d'utilisateur, les valeurs de seuil et d'autres paramètres. Seules les données relatives à l'énergie active et l'historique des mises à jour du micrologiciel sont conservées.

- Choose Maintenance > Unit Reset
- The Unit Reset page appears.
- Click **Reset to Factory Defaults**.
- A pop-up appears.

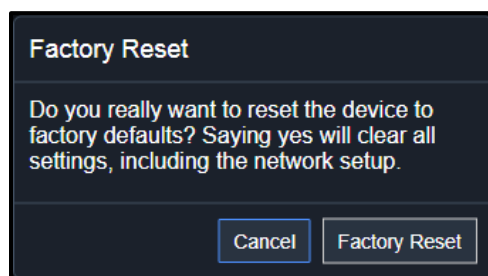

- Click Factory Reset to reset the PDU to factory defaults.
- A pop-up appears with a message and countdown timer showing the remaining time of the operation. It takes about two minutes to complete.

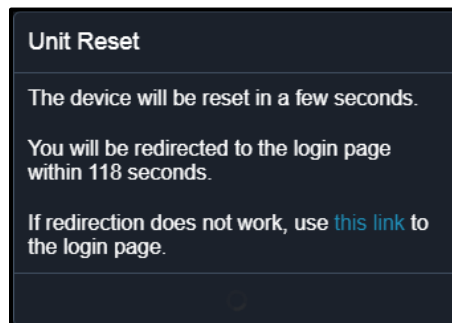

- When the reset is complete, the login page appears.

**NOTE**

If you are not redirected to the login page after the reset is complete, click the text "this link" in the countdown message.

## Understanding Alternative Reset Methods

There are two more methods to reset the device to factory defaults.

- Use the "mechanical" reset button
- Perform the CLI command

For more information, see [Resetting to Factory Defaults](#), on page 241.

## Retrieving Software Package Information via About PDU

You can check the current firmware version and the information of all open source packages embedded in the PDU through the web interface.

- Choose Maintenance > About PDU
- The About PDU page appears.
- A list of open source packages is displayed.
- You can click any link to access related information or download any software package.

## PDU

The PDU's generic information and PDU-level global settings are available on the PDU page. Click PDU in the Menu to open the PDU page. For more information, see [Menu](#), on page 28.

### Viewing PDU Details

The following device information is shown:

- Firmware version
- Serial number
- MAC address
- Rating

### Configuring Global Settings

- Choose PDU
- The About PDU page appears.
- Click Edit Settings.

Settings		<a href="#">Edit Settings</a>
Name	My PDU	
Relay behavior on power loss	Non-latching	
Outlet state on device startup	last known	
Outlet initialization delay on device startup	3 s	
Power off period during power cycle	10 s	
Inrush Guard Delay	200 ms	
<hr/>		
Peripheral Device Z Coordinate Format	Rack-Units	
Peripheral Device Auto Management	enabled	
Altitude	0 m	
Active Powered Dry Contact Limit	1	
<hr/>		
Reset All Active Energy Counters	<a href="#">Reset Active Energy</a>	

- Now you can configure the fields.
- Click  to select an option.
- Select or deselect the checkbox.

- Adjust the numeric values.
- For time-related fields, if option selection using  is not preferred, the value must include a time unit, such as '50 s'. For more information, see [Understanding Time Units](#), on page 220.

Field	Function	Note
Name	Customizes the device name.	
Relay behavior on power loss	<p>Selects an operating mode to determine the latching relay behavior when PDU power is lost.</p> <ul style="list-style-type: none"> <li>• <i>Options: Non-latching and Latching</i></li> <li>• <i>Non-latching has all relays open at the power loss while latching may have the relays closed.</i></li> </ul>	For more information, see <a href="#">PDU Latching Relay Behavior</a> , on page 218.
Outlet state on device startup	<p>Determines the initial power state of ALL outlets after the PDU powers up.</p> <ul style="list-style-type: none"> <li>• <i>Options: on, off, and last known</i></li> </ul> <p>For more information, see <a href="#">Options for Outlet State on Startup</a>, on page 219.</p>	<ul style="list-style-type: none"> <li>• After removing power from the PDU, you must wait for a minimum of 10 seconds before powering it up again. Otherwise, the default outlet state settings may not work properly.</li> <li>• You can override the global outlet state setting on a per-outlet basis so specific outlets behave differently on startup. For more information, see <a href="#">Outlet Configuration Page</a>, on page 52.</li> </ul>
Outlet initialization delay on device startup	<p>Determines how long the PDU waits before providing power to all outlets during power cycling or after recovering from a temporary power loss.</p> <ul style="list-style-type: none"> <li>• <i>Range: 1 second to 1 hour</i></li> </ul>	See Initialization Delay Use Cases, on page 219.
Power off period during power cycle	<p>Determines the power-off period after the outlet is switched OFF during a power cycle.</p> <ul style="list-style-type: none"> <li>• <i>Range: 1 second to 1 hour</i></li> </ul>	<ul style="list-style-type: none"> <li>• Power cycling the outlet(s) turns the outlet(s) off and then back on.</li> <li>• You can override this global power cycle setting on a per-outlet basis so specific outlets' power-off period is different. For more information, see <a href="#">Outlet Configuration Page</a>, on page 52.</li> </ul>

Field	Function	Note
Inrush Guard Delay	Prevents a circuit breaker trip due to inrush current when many devices connected to the PDU are turned on. <ul style="list-style-type: none"> <li>• <i>Range: 100 milliseconds to 2 seconds</i></li> </ul>	
Peripheral Device Z Coordinate Format	Determines how to describe the vertical locations (Z coordinates) of environmental sensor packages. <ul style="list-style-type: none"> <li>• <i>Options: Rack-Units and Free-Form</i></li> </ul>	<ul style="list-style-type: none"> <li>• Rack Units: The height of the Z coordinate is measured in standard rack units. When this is selected, you can type a numeric value in the rack unit to describe the Z coordinate of any environmental sensors or dry contacts.</li> <li>• Free-Form: Any alphanumeric string can be used for specifying the Z coordinate. The value can be 0 to 24 characters long.</li> </ul>
Peripheral Device Auto Management	Enables or disables the automatic management feature for environmental sensor packages. <ul style="list-style-type: none"> <li>• <i>The default is to enable it.</i></li> </ul>	For more information, see <a href="#">How the Automatic Management Function Works</a> , on page 219.
Altitude	Provide an altitude value in feet or meters (depending on your configured preferences).	
Active Powered Dry Contact Limit	This value is the maximum number of allowed powered dry contact sensors connected to your PDU.	Setting this value lower than the number of connected sensors limits how many are controllable in your system. This is available in order to limit power consumption.

- Click **Save**.

## Resetting Active Energy Counters

An active energy reading is a value of total accumulated energy, which is never reset, even if the power fails or the PDU is reset. However, you can manually reset this reading to restart the energy accumulation process.



**NOTE** Only users with the "Admin" role assigned can reset active energy readings.

- Choose PDU
- The About PDU page appears.
- Click **Reset Active Energy**.
- A pop-up appears confirming the reset.

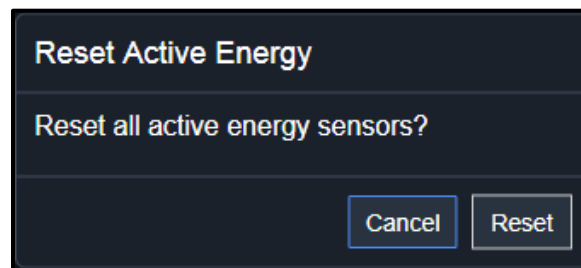

- Click **Reset**.
- All active energy readings on this PDU are reset to zero.



### TIP

You can choose to reset the active energy reading of an individual inlet or outlet. For more information, see [Inlet](#), on page 220 or [Outlet Configuration Page](#), on page 52.

## PDU Latching Relay Behavior

The PDU incorporates latching relays in models with outlet switching. Unlike non-latching relays, latching relays do NOT require power to keep their contacts closed.

PDU outlet switching can be configured to operate as a true latching relay or to simulate a non-latching relay. The operating mode determines the latching relay behavior when PDU power is lost. Regardless of which mode is selected, power is not required to keep relay contacts closed.

### Understanding Non-Latching Mode

- Relay always opens when power is lost. This insures all relays are open when power is applied to the PDU.
- Always select this mode if the combined in-rush current of the devices connected to the PDU trip circuit breakers when power is applied to the PDU.
- This is the factory default operating mode.

### Understanding Latching Mode

- Relay does not open when power is lost.

- This is the preferred operating mode ONLY if you are sure in-rush current does not trip circuit breakers when power is applied to the PDU.
- Power to the outlet is not disrupted if a PDU internal failure occurs.
- In Latching mode, the following features are disabled.
  - PDU-level outlet state on startup: For more information, see [Options for Outlet State on Startup](#), on page 219.
  - Outlet-level outlet state on startup: For more information, see [Outlet Controls](#), on page 50.
  - PDU-level outlet initialization delay on startup: For more information, see [Options for Outlet State on Startup](#), on page 219.

### Options for Outlet State on Startup

The following are available options for initial power states of outlets after powering up the PDU.

Option	Function
on	Turns on the outlet(s).
off	Turns off the outlet(s).
last known	Restores the outlet(s) to the previous power state(s) before the PDU was powered off.

### Initialization Delay Use Cases

Apply the initialization delay in either of the following scenarios.

- When power may not initially be stable after being restored
- When UPS batteries may be charging



#### TIP

When there are a large number of outlets, set the value to a lower number so that you can avoid a long wait before all outlets are available.

### How the Automatic Management Function Works

#### Understanding How the Automatic Management Function Works After Being Enabled

When the total number of managed sensors and dry contacts has not reached the upper limit yet, the PDU automatically brings newly connected environmental sensors and dry contacts under management after detecting them.

A PDU can manage up to 32 sensors/dry contacts.

#### Understanding How the Automatic Management Function Works After Being Disabled

The PDU no longer automatically manages any newly added environmental sensors and dry contacts, and therefore neither ID numbers are assigned nor sensor readings or states are available for newly added ones.

You must manually manage new sensors/dry contacts. For more information, see [Peripherals](#), on page 65.

## Understanding Time Units

If you choose to type a new value in the time-related fields, such as the Inrush Guard Delay field, you must add a time unit after the numeric value. For example, you can type '15 s' for 15 seconds.



**NOTE** The fields have a different ranges of valid entry values.

Unit	Time
ms	millisecond(s)
s	second(s)
min	minute(s)
h	hour(s)
d	day(s)

## Viewing PDU Sensor Power Information

- Choose PDU
- The About PDU page appears.
- Click the Sensors title bar to display sensor power information as follows:

Sensors		
Sensor ▼	Value	State
+12V Supply 1 Status		OK

- The PDU's internal 12V power supply status appears here.

## Inlet

You can view all inlet information, configure inlet-related settings, or reset the inlet active energy on the Inlet page. Open this page by clicking Inlet in the Menu. For more information, see [Menu](#), on page 28.

Inlet thresholds, when enabled, help you identify whether the inlet enters the warning or critical level. In addition, you can have the PDU automatically generate alert notifications for any warning or critical status. For more information, see [Event Rules and Actions](#), on page 120.

## Viewing General Inlet Information

- Choose Inlet.

The Inlet page appears.

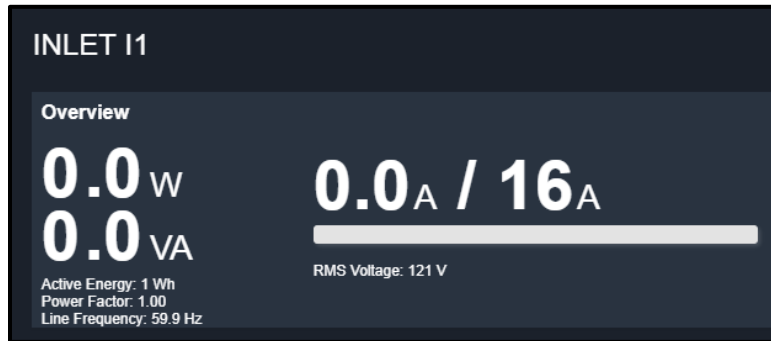

- The left side of the Overview section of the screen lists the following data:
  - Active power (kW or W)
  - Apparent power (kVA or VA)
  - Active energy (kWh or Wh)
  - Power factor
  - Line frequency (Hz)
  - The right side shows the current and voltage data per phase. For a single-phase device, it shows only one line, but for a three phase device, it shows three lines (L1, L2, and L3).
  - Inlet data from top to bottom includes:
    - RMS current (A)
    - A bar showing the RMS current level
    - RMS voltage (V)
    - The RMS current bar automatically changes color to indicate the current status (if the thresholds have been enabled).

Status	Bar colors
normal	
above upper warning	
above upper critical	

 **NOTE** The "below lower warning" and "below lower critical" states also show yellow and red colors respectively. However, it is not meaningful to enable these two thresholds for current levels.

### Viewing Inlet Sensor Information

- Choose Inlet.
- The Inlet page appears.
- View inlet sensor information as follows:

- If desired, you can sort the list by clicking the desired column header. For more information, see [Sorting a List](#), on page 29.

Sensor	Value	State
RMS Voltage	120 V	normal
RMS Current	0.000 A	normal
Power Factor	1.00	normal
Line Frequency	60.0 Hz	normal
Apparent Power	0 VA	normal
Active Power	0 W	normal
Active Energy	1 Wh	normal

- Sensor name, value, and state information is shown.

## Viewing and Configuring Inlet Settings

You can edit the Label, Name, and reset active energy settings, if desired.

### Customizing an Inlet Name

- Choose Inlet.
- The Inlet page appears.
- Click the Settings title bar as shown.



- Click Edit Settings.

- Type a name for the inlet.
- For example, you can name it to identify the power source.
  - Click **Save**.
  - The inlet's custom name is displayed on the Inlet or Dashboard page, followed by its label in parentheses.

### Resetting an Inlet Active Energy Counter



**NOTE** Only users with the "Admin" role assigned can reset active energy readings.

- Choose Inlet.
- The Inlet page appears.
- Click the Settings title bar as shown.



- Click **Reset Energy**.
- Click Reset on the confirmation message.

The inlet's active energy reading is then reset to zero.



#### TIP

Reset ALL active energy counters on the PDU, if desired. For more information see [PDU](#), on page 215.

## Understanding the Section Title Summary

Information in parentheses adjacent to the title is the total number of alerted sensors.

For example:

- **1 Critical:** 1 sensor enters the critical or alarmed state.  
Numeric sensors enter the critical state.  
State sensors enter the alarmed state.
- **1 Warned:** 1 'numeric' sensor enters the warning state.

## Understanding Alerted Sensor States

Two icons are used to indicate various sensor states.

Icons	Sensor states
	For numeric sensors: <ul style="list-style-type: none"> <li>• above upper warning</li> <li>• below lower warning</li> </ul>
	For numeric sensors: <ul style="list-style-type: none"> <li>• above upper critical</li> <li>• below lower critical</li> </ul> For state sensors: <ul style="list-style-type: none"> <li>• alarmed state</li> </ul>

For more information, see [Sensor/Dry Contact States](#), on page 72.

## Inlet History

The Inlet history section behaves in the same manner as the outlets; however, the readings pertain to the total system power usage. For more information, see [Viewing Outlet History](#), on page 58.

## Inlet Thresholds

- The Inlet thresholds section behaves in the same manner as the outlets; however, the readings pertain to the total system power usage. For more information, see [Configuring Outlet Thresholds](#), on page 59.

# Using SNMP

This SNMP section helps you set up the PDU for use with an SNMP manager. The PDU can be configured to send traps or informs to an SNMP manager, as well as receive GET and SET commands in order to retrieve status and configure some basic settings.

## Enabling and Configuring SNMP

You must enable SNMP protocols on the PDU to communicate with an SNMP manager. By default the "read-only" mode of SNMP v1/v2c is enabled.

The SNMP v3 protocol allows for encrypted communication. When using encrypted communication, you must configure the users with the SNMP v3 access permission and set Authentication and Privacy Pass Phrases, which act as shared secrets between SNMP and the PDU.



### CAUTION

You must download the SNMP MIB for your PDU to use with your SNMP manager. For more information, see [Downloading SNMP MIB](#), on page 226.

### ATTENTION

Vous devez télécharger le MIB SNMP pour votre PDU afin de l'utiliser avec votre gestionnaire SNMP. Pour plus d'informations, voir [Downloading SNMP MIB](#), à la page 226.

## Enabling SNMP v1/v2c and/or v3 Protocols

- Choose Device Settings > Network Services > SNMP.
- In the SNMP Agent section, enable SNMP v1/v2c or SNMP v3, and configure related fields, such as the community strings.
- If SNMP v3 is enabled, you must determine which users shall have the SNMP v3 access permission. For more information, see the following procedure.

For more information, see [Configuring SNMP Settings](#), on page 96.

## Configuring Users for SNMP v3 Access

- Choose User Management > Users.
- Create or modify users to enable their SNMP v3 access permission.
- If authentication and privacy is enabled, configure the SNMP password(s) in the user settings.

For more information, see [Creating Users](#), on page 78.

## Enabling SNMP Notifications

- Choose Device Settings > Network Services > SNMP.
- In the SNMP Notifications section, enable the SNMP notification feature, and configure related fields. For more information, see [Configuring SNMPv2c Notifications](#), on page 225 and [Configuring SNMPv3 Notifications](#), on page 225.

**NOTE**

Any changes made to the 'SNMP Notifications' section on the SNMP page will update the settings of the System SNMP Notification Action, and vice versa. For more information, see [Available Actions](#), on page 131.

## Configuring SNMPv2c Notifications

- Choose Device Settings > Network Services > SNMP.
- In the SNMP Agent, make sure the Enable SNMP v1/v2c checkbox is selected.
- In the SNMP Notifications section, make sure the Enable SNMP Notifications checkbox is selected.
- Select SNMPv2c Trap or SNMPv2c Inform as the notification type.
- Type values in the following fields.

Field	Description
Timeout	The interval of time, in seconds, after which a new inform communication is resent if the first is not received. <ul style="list-style-type: none"> <li>• For example, resend a new inform communication once every 3 seconds.</li> </ul>
Number of Retries	The number of times you want to resend the inform communication if it fails. <ul style="list-style-type: none"> <li>• For example, inform communications are resent up to 5 times when the initial communication fails.</li> </ul>
Host	The IP address of the device(s) you want to access. This is the address to which notifications are sent by the SNMP agent. You can specify up to 3 SNMP destinations.
Port	The port number used to access the device(s).
Community	The SNMP community string to access the device(s). The community is the group representing the PDU and all SNMP management stations.

- Click **Save**.

## Configuring SNMPv3 Notifications

- Choose Device Settings > Network Services > SNMP.
- In the SNMP Agent, make sure the Enable SNMP v1/v2c checkbox is selected.
- In the SNMP Notifications section, make sure the Enable SNMP Notifications checkbox is selected.
- Select SNMPv3 Trap or SNMPv3 Inform as the notification type.
- For SNMP TRAPs, the engine ID is prepopulated.
- Type values in the following fields.

Field	Description
Host	The IP address of the device(s) you want to access.

Field	Description
	This is the address to which notifications are sent by the SNMP agent.
Port	The port number used to access the device(s).
User ID	User name for accessing the device. <ul style="list-style-type: none"> <li>Make sure the user has the SNMP v3 access permission.</li> </ul>
Timeout	The interval of time, in seconds, after which a new inform communication is resent if the first is not received. <ul style="list-style-type: none"> <li>For example, resend a new inform communication once every 3 seconds.</li> </ul>
Number of Retries	Specify the number of times you want to resend the inform communication if it fails. <ul style="list-style-type: none"> <li>For example, inform communications are resent up to 5 times when the initial communication fails.</li> </ul>
Security Level	Three types are available. <ul style="list-style-type: none"> <li>noAuthNoPriv - neither authentication nor privacy protocols are needed.</li> <li>AuthNoPriv - only authentication is required.</li> <li>authPriv - both authentication and privacy protocols are required.</li> </ul>
Authentication Protocol, Authentication Passphrase, Confirm Authentication Passphrase	The three fields are available when the security level is set to AuthNoPriv or authPriv. <ul style="list-style-type: none"> <li>Select the authentication protocol - MD5 or SHA</li> <li>Enter the authentication passphrase and then confirm the authentication passphrase</li> </ul>
Privacy Protocol, Privacy Passphrase, Confirm Privacy Passphrase	The three fields are available when the security level is set to authPriv. <ul style="list-style-type: none"> <li>Select the Privacy Protocol - DES or AES</li> <li>Enter the privacy passphrase and then confirm the privacy passphrase</li> </ul>

- Click **Save**.

## Downloading SNMP MIB

You must download an appropriate SNMP MIB file for successful SNMP communications. Always use the latest SNMP MIB downloaded from the current firmware of your PDU.

You can download the MIBs from two different pages of the web interface.

### ***Downloading the MIB from the SNMP Page***

- Choose Device Settings > Network Services > SNMP.
- Click the Download MIBs title bar.



Download MIBs

- Select the desired MIB file to download.
- RLNK-MIB file for PDU power management.
  - Click **Save** to save the file onto your computer.

## ***Downloading the MIB from the Device Information Page***

- Choose Maintenance > Device Information.
- In the Information section, click the desired download link:
- RLNK-MIB file for PDU power management.
  - Click **Save** to save the file onto your computer.

## **SNMP Gets and Sets**

In addition to sending notifications, the PDU is able to receive SNMP get and set requests from third-party SNMP managers.

- Get requests are used to retrieve information about the PDU, such as the system location, and the current on a specific outlet.
- Set requests are used to configure a subset of the information, such as the SNMP system name.



### **NOTE**

The SNMP system name is the PDU name. When you change the SNMP system name, the device name shown in the web interface is also changed.

The PDU does NOT support configuring IPv6-related parameters using the SNMP set requests.

Valid objects for these requests are limited to those found in the SNMP MIB-II System Group and the custom PDU MIB.

## ***The PDU MIB***

The SNMP MIB file is required for using your PDU with an SNMP manager. An SNMP MIB file describes the SNMP functions.

## Layout

Opening the MIB reveals the custom objects that describe the system at the unit level as well as at the individual outlet level.

As standard, these objects are first presented at the beginning of the file, listed under their parent group. The objects then appear again individually, defined and described in detail.

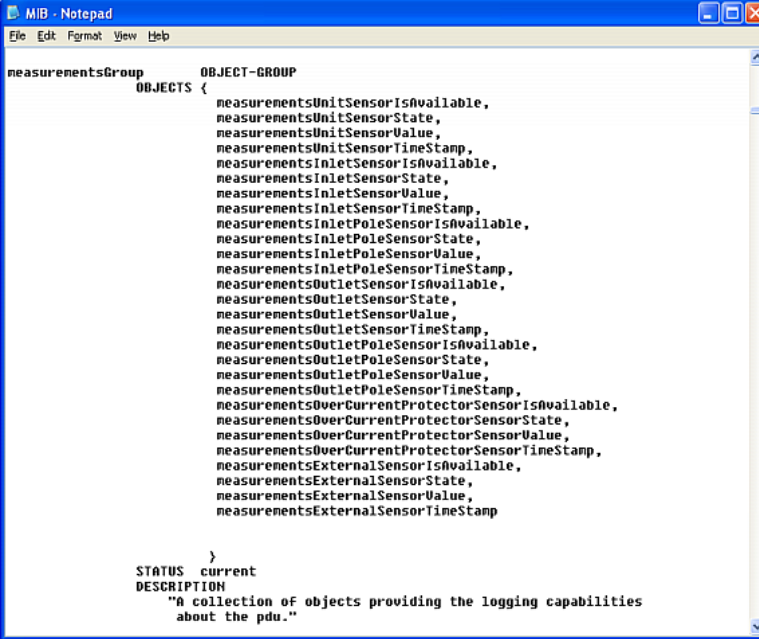

```

MIB - Notepad
File Edit Format View Help

measurementsGroup OBJECT-GROUP
OBJECTS {
    measurementsUnitSensorIsAvailable,
    measurementsUnitSensorState,
    measurementsUnitSensorValue,
    measurementsUnitSensorTimeStamp,
    measurementsInletSensorIsAvailable,
    measurementsInletSensorState,
    measurementsInletSensorValue,
    measurementsInletSensorTimeStamp,
    measurementsInletPoleSensorIsAvailable,
    measurementsInletPoleSensorState,
    measurementsInletPoleSensorValue,
    measurementsInletPoleSensorTimeStamp,
    measurementsOutletSensorIsAvailable,
    measurementsOutletSensorState,
    measurementsOutletSensorValue,
    measurementsOutletSensorTimeStamp,
    measurementsOutletPoleSensorIsAvailable,
    measurementsOutletPoleSensorState,
    measurementsOutletPoleSensorValue,
    measurementsOutletPoleSensorTimeStamp,
    measurementsOverCurrentProtectorSensorIsAvailable,
    measurementsOverCurrentProtectorSensorState,
    measurementsOverCurrentProtectorSensorValue,
    measurementsOverCurrentProtectorSensorTimeStamp,
    measurementsExternalSensorIsAvailable,
    measurementsExternalSensorState,
    measurementsExternalSensorValue,
    measurementsExternalSensorTimeStamp
}
STATUS current
DESCRIPTION
"A collection of objects providing the logging capabilities
about the pdu."

```

For example, the measurementsGroup group contains objects for sensor readings of the PDU as a whole. One object listed under this group, measurementsUnitSensorValue, is described later in the MIB as "The sensor value". pduRatedCurrent, part of the configGroup group, describes the PDU current rating.

## SNMP Sets and Thresholds

Some objects can be configured from the SNMP manager using SNMP set commands. Objects that can be configured have a MAX-ACCESS level of "read-write" in the MIB.

These objects include threshold objects, which causes the PDU to generate a warning and send an SNMP notification when certain parameters are exceeded. For more information, see [Sensor Threshold Settings](#), on page 60.



### NOTE

When configuring the thresholds via SNMP set commands, ensure the value of upper critical threshold is higher than the upper warning threshold.

## Configuring NTP Server Settings

Using SNMP, you can change the following NTP server-related settings in the unitConfigurationTable:

- Enable or disable synchronization of the device's date and time with NTP servers (synchronizeWithNTPServer)

- Enable or disable the use of DHCP-assigned NTP servers if synchronization with NTP servers is enabled (useDHCPProvidedNTPServer)
- Manually assign the primary NTP server if the use of DHCP-assigned NTP servers is disabled (primaryNTPServerAddressType and primaryNTPServerAddress)
- Manually assign the secondary NTP server (optional) (secondaryNTPServerAddressType and secondaryNTPServerAddress)

**TIP**

Specify the time zone using the CLI or web interface. For the CLI, refer to [Setting the Time Zone in the Premium+ PDU With RackLink Advanced User Manual at \[www.legrandav.com\]\(http://www.legrandav.com\)](#). For the web interface, see [Setting the Date and Time](#), on page 119.

When using the SNMP SET command to specify or change NTP servers, it is required that both the NTP server's address type and address be set in the command line simultaneously.

For example, the SNMP command to change the primary NTP server's address from IPv4 (192.168.84.84) to host name looks similar to the following:

```
snmpset -v2c -c private 192.168.84.84 firstNTPServerAddressType = dns  
firstNTPServerAddress = "angu.pep.com"
```

## ***Retrieving Energy Usage***

You can discover how much energy a device consumes by retrieving the Active Energy for the outlet the device is plugged into. The Active Energy values are included in the outletSensorMeasurementsTable, along with other outlet sensor readings.

## ***A Note about Enabling Thresholds***

When enabling previously disabled thresholds via SNMP, make sure you set a correct value for all thresholds that are supposed to be enabled prior to actually enabling them. Otherwise, you may get an error message.

# Specifications

## Specifications for Compact MOV Models

### Summary

Model	RLNK-P415	RLNK-P420
Nominal Voltage	120VAC	
Voltage Range	Minimum: 80VAC, Maximum: 140VAC	
Frequency	60 Hz	
Maximum Peak Load	15A	20A
Rated Load	12A	16A
Number of Outlets	4 Total, 4 Controlled	
Outlet Type	NEMA 5-15R	NEMA 5-20R
Overload Protection	Circuit Breaker	
No Load Power Dissipation	< 1W	
Input Power Cord	9ft. (2.7M) 15A IEC	9ft. (2.7M) 20A IEC
Operating Temperature Range	32 - 104°F (0 - 40°C)	
Humidity Range	0 - 95%, non-condensing	
Certifications	UL 60950-1 and CSA C22.2 No.60950-1, FCC Part 15, Class B	

### Hardware Features

Model	RLNK-P415, RLNK-P420
Surge Protection	Two-Stage MOV

<b>Model</b>	<b>RLNK-P415, RLNK-P420</b>
Peak Impulse Current (8/20µS Waveform)	30,000 Amps, one time - Maximum peak impulse current pulse as defined between line and neutral. 19,500 Amps, two times within 5 minutes - Maximum multiple impulse current derated per spec.
Protection Mode	Line to Neutral only; no ground contamination.
Response Time	Less than 1 nanosecond.
Surge Energy Dissipation	711 Joules (10/100µS).
EMI/RF Suppression	>20dB Calculated Line to Neutral - 100kHz to 1Mhz - based on nominal impedance.
LCD Display	No
Wi-Fi Capable	USB Wi-Fi Dongle

## Software Features

<b>Model</b>	<b>RLNK-P415, RLNK-P420</b>
Integrated Web Server	Yes
Communication	TCP/IP, HTTP / HTTPS (Integrated web server), SSH, SNMP
AutoPing No Response / Recovery	Control Outlet and/or Notification via Email, API, SNMP
Network Security	TLS/SSL (Self-Signed Certificates), SSH
Discovery	RackLink Discovery Tool
Data Monitoring	Data Logging/Metering
Supported Web Browser	Internet Explorer 11, Windows Edge, Firefox 25 and later, Safari (MAC) Google Chrome, Android, and iOS

**Physical**

Model	RLNK-P415	RLNK-P420
Dimensions (Width x Height x Depth)	11.58" (294mm) x 1.75" (44mm) x 7.82" (199mm)	
Product Weight	6.6 lbs. (3 kg)	
Shipping Weight	3.53 lb. (1.6 kg)	3.75 lb. (1.7 kg)

**Warranty**

Model	RLNK-P415 and RLNK-P420
Power Distribution	Three Years Limited For warranty information, refer to <a href="http://www.legrandav.com/policies/warranty_information">www.legrandav.com/policies/warranty_information</a> .

**Specifications for Compact IEC Models****Summary**

Model	RLNK-P416-IEC-NS
Nominal Voltage	240VAC
Voltage Range	Minimum: 100VAC, Maximum: 240VAC
Frequency	50/60 Hz
Maximum Peak Load	16A
Rated Load	16A
Number of Outlets	4 Total, 4 Controlled
Outlet Type	IEC C13
Overload Protection	Circuit Breaker

<b>Model</b>	<b>RLNK-P416-IEC-NS</b>
No Load Power Dissipation	< 1W
Input Power Cord	C20 to C19, 9' (2.7M)
Operating Temperature Range	32 - 104°F (0 - 40°C)
Humidity Range	0 - 95%, non-condensing
Certifications	CE and UKCA and UL 62368-1 and CSA C22.2 No. 62368-1 FCC Part 15, Class B

## Hardware Features

<b>Model</b>	<b>RLNK-P416-IEC-NS</b>
Surge Protection	None
LCD Display	No
Wi-Fi Capable	USB Wi-Fi Dongle

## Physical

<b>Model</b>	<b>RLNK-P416-IEC-NS</b>
Dimensions (Width x Height x Depth)	11.58" (294mm) x 1.75" (44mm) x 7.82" (199mm)
Product Weight	3.85 lb. (1.75 kg)
Shipping Weight	7.05 lb. (3.20 kg)

## Warranty

Model	RLNK-P416-IEC-NS
Power Distribution	Three Years Limited For warranty information, refer to <a href="http://www.legrandav.com/policies/warranty_information">www.legrandav.com/policies/warranty_information</a> .

## Specifications for Rackmount MOV Surge Models

### Summary

Model	RLNK-P915R	RLNK-920R
Nominal Voltage	120VAC	
Voltage Range	Minimum: 80VAC, Maximum: 140VAC	
Frequency	60 Hz	
Maximum Peak Load	15A	20A
Rated Load	12A	16A
Number of Outlets	9 Total / 8 Controlled	
Outlet Type	NEMA 5-15R	NEMA 5-20R
Overload Protection	Circuit Breaker	
No Load Power Dissipation	< 1W	
Input Power Cord	9ft. (2.7M) 15A IEC	9ft. (2.7M) 20A IEC
Operating Temperature Range	32 - 104°F (0 - 40°C)	
Humidity Range	0 - 95%, non-condensing	
Certifications	UL 60950-1 and CSA C22.2 No.60950-1, FCC Part 15, Class B	

## Hardware Features

Model	RLNK-P915R and RLNK-920R
Surge Protection	Multi-Stage MOV
Peak Impulse Current (8/20 $\mu$ S Waveform)	30,000 Amps, one time - Maximum peak impulse current pulse as defined between line and neutral. 19,500 Amps, two times within 5 minutes - Maximum multiple impulse current derated per spec.
Protection Mode	Line to Neutral only; no ground contamination.
Response Time	Less than 1 nanosecond.
Surge Energy Dissipation	711 Joules (10/100 $\mu$ S)
EMI/RF Suppression	>20dB Calculated Line to Neutral - 100kHz to 1Mhz - based on nominal impedance.
LCD Display	Yes
Wi-Fi Capable	USB Wi-Fi Dongle

## Software Features

Model	RLNK-P915R and RLNK-920R
Integrated Web Server	Yes
Communication	TCP/IP, HTTP / HTTPS (Integrated web server), SSH, SNMP
AutoPing No Response / Recovery	Control Outlet and/or Notification via Email, API, SNMP
Network Security	TLS/SSL (Self Signed Certificates), SSH
Discovery	RackLink Discovery Tool
Data Monitoring	Data Logging/Metering
Supported Web Browser	Internet Explorer 11, Windows Edge, Firefox 25 and later, Safari (MAC) Google Chrome, Android, and iOS

## Physical

Model	RLNK-P915R	RLNK-920R
Dimensions (Width x Height x Depth)	19" (483mm) x 1.75" (44.5mm) x 9.83" (250mm)	
Product Weight	6.84 lbs (3.1 kg)	
Shipping Weight	9.92 lb (4.5 kg)	10.58 lb (4.8 kg)

## Warranty

Model	RLNK-P915R and RLNK-920R
Power Distribution	Three Years Limited For warranty information, refer to <a href="http://www.legrandav.com/policies/warranty_information">www.legrandav.com/policies/warranty_information</a> .

## Specifications for Rackmount Series Surge Protection Models

### Summary

Model	RLNK-P915R-SP	RLNK-920R-SP
Nominal Voltage	120VAC	
Voltage Range	Minimum: 80VAC, Maximum: 140VAC	
Frequency	60 Hz	
Maximum Peak Load	15A	20A
Rated Load	12A	16A
Number of Outlets	9 Total, 8 Controlled	
Outlet Type	NEMA 5-15R	NEMA 5-20R
Overload Protection	Circuit Breaker	

Model	RLNK-P915R-SP	RLNK-920R-SP
No Load Power Dissipation	<1W	
Input Power Cord	SignalSAFE IEC to 5-15P, 10' (3M)	SignalSAFE IEC to 5-20P, 10' (3M)
Operating Temperature Range	32 - 104°F (0 - 40°C)	
Humidity Range	0 - 95%, non-condensing	
Certifications	UL 62368, UL 1283, UL 1449, FCC Class B, ICES 7	

## Hardware Features

Model	RLNK-P915R and RLNK-920R
Surge Protection	Multi-Stage MOV
Peak Impulse Current (8/20µS Waveform)	30,000 Amps, one time - Maximum peak impulse current pulse as defined between line and neutral. 19,500 Amps, two times within 5 minutes - Maximum multiple impulse current derated per spec.
Protection Mode	Line to Neutral only; no ground contamination.
Response Time	Less than 1 nanosecond.
Surge Energy Dissipation	711 Joules (10/100µS)
EMI/RF Suppression	>20dB Calculated Line to Neutral - 100kHz to 1Mhz - based on nominal impedance.
LCD Display	Yes
Wi-Fi Capable	USB Wi-Fi Dongle

## Software Features

Model	RLNK-P915R and RLNK-920R
Integrated Web Server	Yes

Model	RLNK-P915R and RLNK-920R
Communication	TCP/IP, HTTP / HTTPS (Integrated web server), SSH, SNMP
AutoPing No Response / Recovery	Control Outlet and/or Notification via Email, API, SNMP
Network Security	TLS/SSL (Self Signed Certificates), SSH
Discovery	RackLink Discovery Tool
Data Monitoring	Data Logging/Metering
Supported Web Browser	Internet Explorer 11, Windows Edge, Firefox 25 and later, Safari (MAC) Google Chrome, Android, and iOS

## Physical

Model	RLNK-P915R	RLNK-920R
Dimensions (Width x Height x Depth)	19" (483mm) x 1.75" (44.5mm) x 9.83" (250mm)	
Product Weight	6.84 lbs (3.1 kg)	
Shipping Weight	9.92 lb (4.5 kg)	10.58 lb (4.8 kg)

## Warranty

Model	RLNK-P915R and RLNK-920R
Power Distribution	Three Years Limited For warranty information, refer to <a href="http://www.legrandav.com/policies/warranty_information">www.legrandav.com/policies/warranty_information</a> .

## Specifications for Rackmount Series Surge Protection Models

### Summary

Model	RLNK-P915R-SP	RLNK-920R-SP
Nominal Voltage	120VAC	
Voltage Range	Minimum: 80VAC, Maximum: 140VAC	
Frequency	60 Hz	
Maximum Peak Load	15A	20A
Rated Load	12A	16A
Number of Outlets	9 Total, 8 Controlled	
Outlet Type	NEMA 5-15R	NEMA 5-20R
Overload Protection	Circuit Breaker	
No Load Power Dissipation	<1W	
Input Power Cord	SignalSAFE IEC to 5-15P, 10' (3M)	SignalSAFE IEC to 5-20P, 10' (3M)
Operating Temperature Range	32 - 104°F (0 - 40°C)	
Humidity Range	0 - 95%, non-condensing	
Certifications	UL 62368, UL 1283, UL 1449, FCC Class B, ICES 7	

## Specifications for Rackmount IEC Models

### Summary

Model	RLNK-P916R-IEC-NS
Nominal Voltage	240VAC
Voltage Range	Minimum: 100VAC, Maximum: 240VAC

<b>Model</b>	<b>RLNK-P916R-IEC-NS</b>
Frequency	50/60 Hz
Maximum Peak Load	16A
Rated Load	16A
Number of Outlets	9 Total, 8 Controlled
Outlet Type	IEC C13
Overload Protection	Circuit Breaker
No Load Power Dissipation	< 1W
Input Power Cord	C20 to C19, 9' (2.7M)
Operating Temperature Range	32 - 104°F (0 - 40°C)
Humidity Range	0 - 95%, non-condensing
Certifications	CE and UKCA and UL 62368-1 and CSA C22.2 No. 62368-1 FCC Part 15, Class B

## ***Hardware Features***

<b>Model</b>	<b>RLNK-P916R-IEC-NS</b>
Surge Protection	None
LCD Display	Yes
Wi-Fi Capable	USB Wi-Fi Dongle

## Physical

Model	RLNK-P916R-IEC-NS
Dimensions (Width x Height x Depth)	19" (483mm) x 1.75" (44.5mm) x 9.83" (250mm)
Product Weight	8.01 lb. (3.6 kg)
Shipping Weight	11.13 lb. (5.05 kg)

## Warranty

Model	RLNK-P916R-IEC-NS
Power Distribution	Three Years Limited For warranty information, refer to <a href="http://www.legrandav.com/policies/warranty_information">www.legrandav.com/policies/warranty_information</a> .

## Resetting to Factory Defaults

You can use either the reset button or the command line interface (CLI) to reset the PDU. For information about the CLI, refer to the Premium+ PDU With RackLink Advanced User Manual at [www.legrandav.com](http://www.legrandav.com).

### CAUTION



### ATTENTION

Be careful before resetting the PDU to factory defaults. This operation deletes existing information and customized settings, such as user profiles, threshold values and other parameters. Only active energy data and firmware update history are retained.

Soyez prudent avant de réinitialiser l'unité PDU à ses valeurs par défaut. Cette opération efface les informations existantes et les paramètres personnalisés, tels que les profils d'utilisateur, les valeurs de seuil et d'autres paramètres. Seules les données relatives à l'énergie active et l'historique des mises à jour du micrologiciel sont conservées.

**NOTE**

Another method to reset your device to factory defaults is to use the web interface. For more information, see [Resetting All Settings to Factory Defaults](#), on page 213.

## Using the Reset Button

An RS-232 serial connection to a computer is required for using the reset button.

- Connect a computer to the PDU. Refer to Connecting the PDU to a Computer in the Premium+ PDU With RackLink Advanced User Manual at [www.legrandav.com](http://www.legrandav.com).
- Launch a terminal emulation program such as HyperTerminal, Kermit, or PuTTY, and open a command line interface to your PDU. For information on the serial port configuration, refer to Step 2 of Initial Network Configuration via CLI in the Premium+ PDU With RackLink Advanced User Manual at [www.legrandav.com](http://www.legrandav.com).

**NOTE**

HyperTerminal is available on Windows operating systems prior to Windows Vista. For Windows Vista or later versions, you may use PuTTY, which is a free program you can download from the Internet. For configuration details, refer to PuTTY's documentation.

- Press (and release) the Reset button of the PDU while pressing the Esc key of the keyboard several times in rapid succession. A prompt (=>) should appear after about one second.

The reset button location:

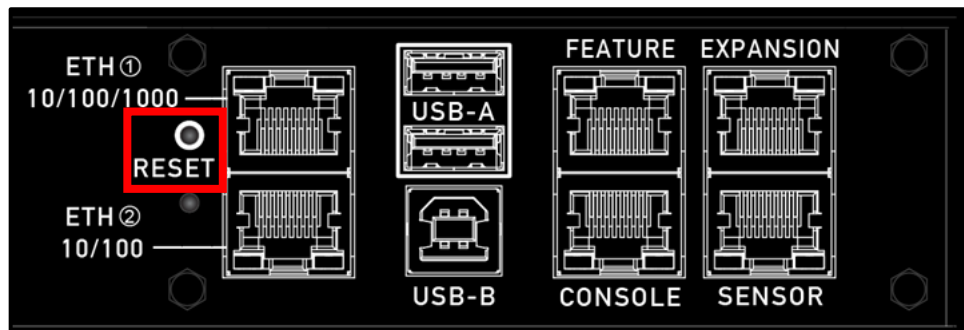

- Type `defau1ts` to reset the PDU to its factory defaults.
- Wait until the Username prompt appears, indicating the reset is complete.

## Using the CLI Command

The Command Line Interface (CLI) provides a reset command for restoring the PDU to factory defaults. For information on CLI, refer to Using the Command Line Interface in the Premium+ PDU With RackLink Advanced User Manual at [www.legrandav.com](http://www.legrandav.com).

- Connect to the PDU. Refer to Logging in to CLI or Connecting the PDU to a Computer in the Premium+ PDU With RackLink Advanced User Manual at [www.legrandav.com](http://www.legrandav.com).
- Launch a terminal emulation program such as HyperTerminal, Kermit, or PuTTY, and open a window on the PDU. For information on the serial port configuration, refer to Step 2 of Initial Network Configuration via CLI in the Premium+ PDU With RackLink Advanced User Manual at [www.legrandav.com](http://www.legrandav.com).
- Log in to the CLI by typing the user name "admin" and its password.
- After the # system prompt appears, type either of the following commands and press Enter.

```
# reset factorydefaults
```

-- OR --

```
# reset factorydefaults /y
```

- If you entered the command without "/y" in Step 4, a message appears prompting you to confirm the operation. Type y to confirm the reset.
- Wait until the Username prompt appears, indicating the reset is complete.
- After resetting to factory defaults, you must log into the system for the first time. For more information, see [Accessing the Web Interface](#), on page 23.

## Resetting Before CLI Login

The PDU provides an easier way to reset the product to factory defaults in the CLI prior to login.

- Connect to the PDU and launch a terminal emulation program as described in the above procedure.

- At the Username prompt in the CLI, type "factorydefaults" and press Enter.

```
Username factorydefaults
```

```
e:
```

- Type `y` on a confirmation message to perform the reset.

# Downloading and Using the Mobile App

The mobile application allows real-time control of any controllable outlet from your mobile phone.

1. Download the RackLink app from the Google Play™ store or the App Store® and install it on your smartphone.

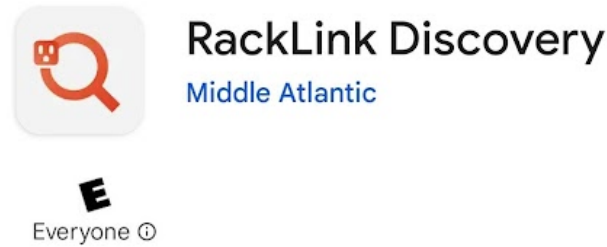

2. Make sure your smartphone is on the same network as your RackLink device, and then open the application.
3. After opening the application, it automatically searches for any available RackLink devices on your network and then lists them on the screen.

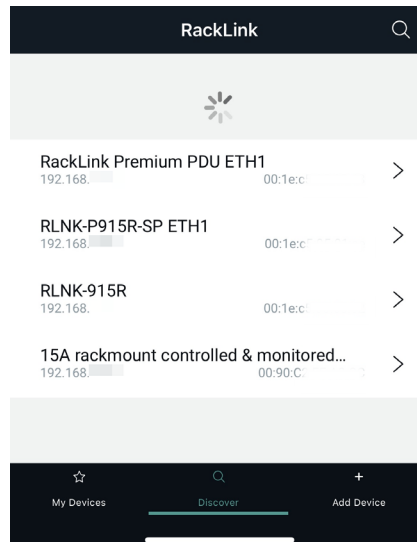

4. Touch the RackLink device you wish to access. The selected device then prompts you for your username and password.

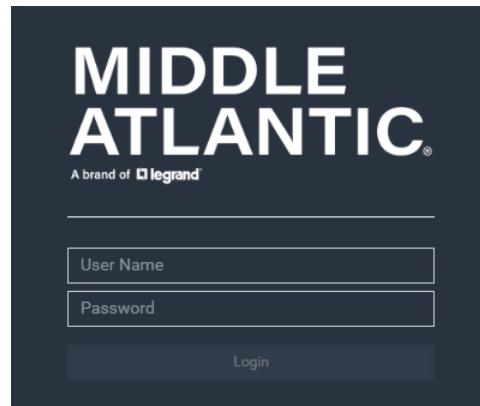

5. Log into the Administrator, User, or Control Systems account on your RackLink device. For more information, see [Accessing the Web Interface](#), on page 23.
6. The application then shows the dashboard for the corresponding RackLink device.

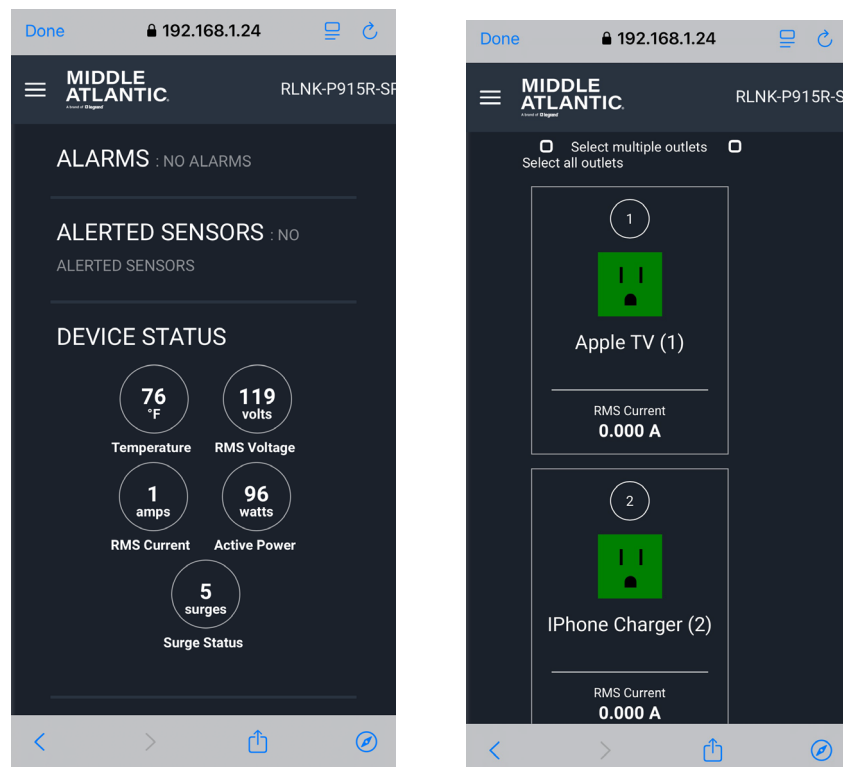
**NOTE**

On-screen user interface elements in the application are similar to the ones found in the web interface. For more information, see [Accessing the Web Interface](#), on page 23.

# Downloading and Using the RackLink Device Discovery Tool

The following steps and topics show you how to download and use the RackLink Device Discovery Tool on your Windows®, Mac®, or Linux® computer.

1. If you haven't done so already, download the Device Discovery Tool software installer onto your computer from the Power Downloads page at:  
<https://www.legrandav.com/resources/power-downloads>.
2. Use the following topics to install the software based on your specific operating system.
  - For Windows, see [Installing the RackLink Device Discovery Tool Software on a Windows PC](#), on page 139.
  - For Mac, see [Installing the RackLink Device Discovery Tool Software on a Mac](#), on page 141.
  - For Linux, see [Installing the RackLink Device Discovery Tool Software on Linux](#), on page 143.



## NOTE

You may need to contact your administrator to install software on your computer.

3. Whenever you launch the RackLink Device Discovery Tool, the program automatically discovers all RackLink devices on the subnet to which you are connected.



**NOTE**

- The examples shown in this topic are from a Windows PC. The procedures and images are similar on Mac or Linux as well.
- You may need to configure your firewall to discover your device. If you are on a managed corporate network, please ask your network administrator for guidance. For personal devices, refer to your operating system's security documentation to verify any necessary ports are open.
- By default, RackLink devices are set for DHCP. You can identify each device by the MAC address or IP address.



4. Click **Scan** to refresh any new or changed RackLink devices on your subnet.
5. Right click on a listed device's row and choose from the following options:

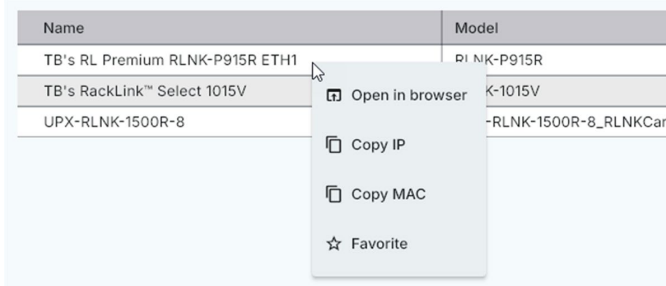

- Select **Open in browser** to access the corresponding web interface.



**TIP**

Double-click the row (except in the Favorites column) to quickly access the corresponding web interface.

- Select **Copy IP** to copy the device's IP address value to your clipboard.
- Select **Copy MAC** to copy the device's MAC address value to your clipboard.
- Select **Favorite** to "pin" the device row to the top when multiple products are listed.

**TIP**

Click the Favorite star (without right-clicking) to add the device to your favorites.

6. When accessing the web interface, the system prompts you for a username and password.

For information about changing your password on your first login, see [Accessing the Web Interface](#), on page 23.

## Installing the RackLink Device Discovery Tool Software on a Windows PC

Use the following steps to download and install the Device Discovery Tool software on a PC.

1. If you haven't done so already, download the Device Discovery Tool software installer onto your computer from the Power Downloads page at: <https://www.legrandav.com/resources/power-downloads>.
2. Run the Windows MSIX file.

The Device Discovery installer appears.

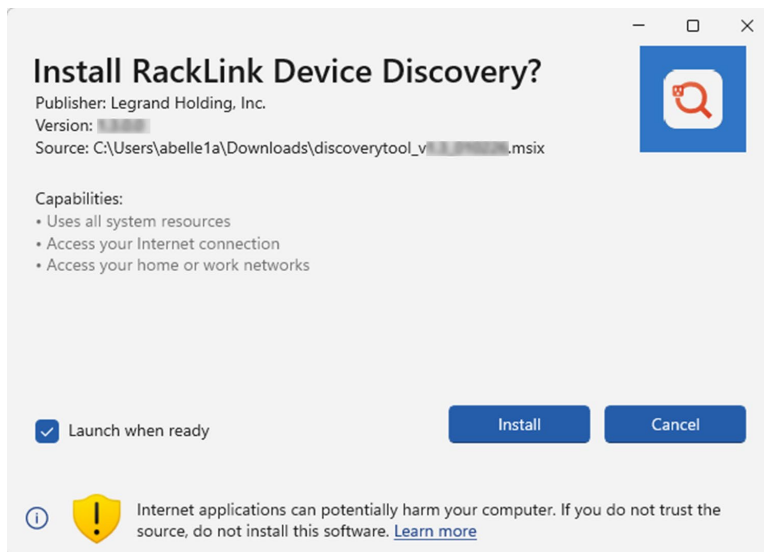

3. Select the Launch when ready check box.
4. Click **Install**.

After the application is installed on your system, the Device Discovery Tool launches and automatically discovers all RackLink devices on the subnet to which you are connected.



For more information, see [Downloading and Using the RackLink Device Discovery Tool](#), on page 247.

## Installing the RackLink Device Discovery Tool Software on a Mac

Use the following steps to download and install the Device Discovery Tool software on a Mac.

1. If you haven't done so already, download the Device Discovery Tool software installer onto your computer from the Power Downloads page at: <https://www.legrandav.com/resources/power-downloads>.

2. Run the Mac setup (.dmg) file.  
The Discovery Tool installer appears.

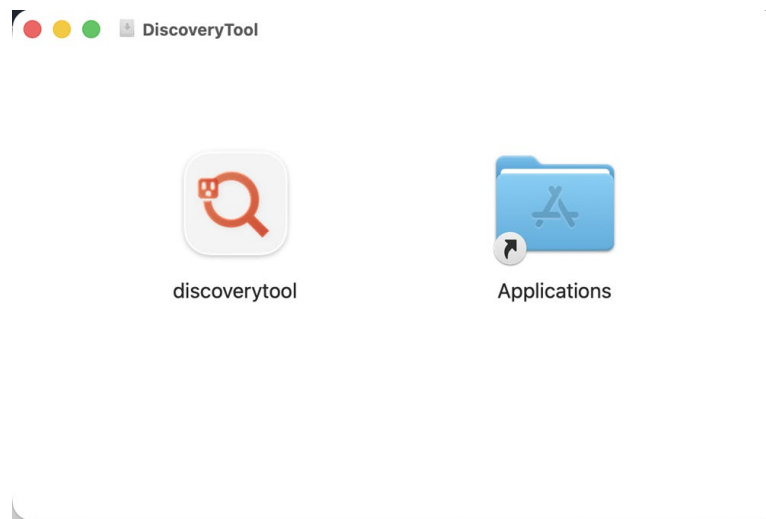

3. Drag and drop the Discovery Tool icon onto the **Applications** folder.
4. Double-click the **Applications** folder to open it.

The Applications folder content appears.

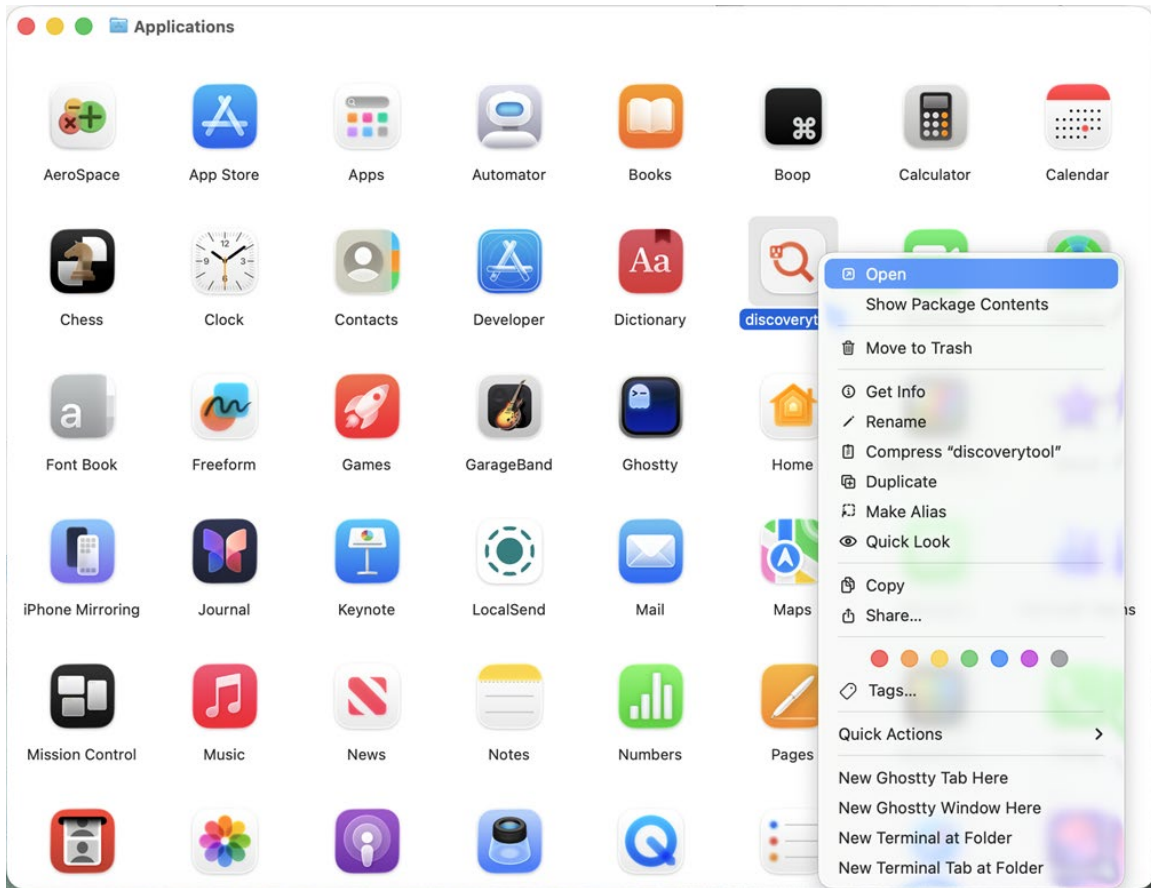

- Right-click the Discovery Tool icon and select **Open**.  
The main screen of the Device Discovery Tool appears.

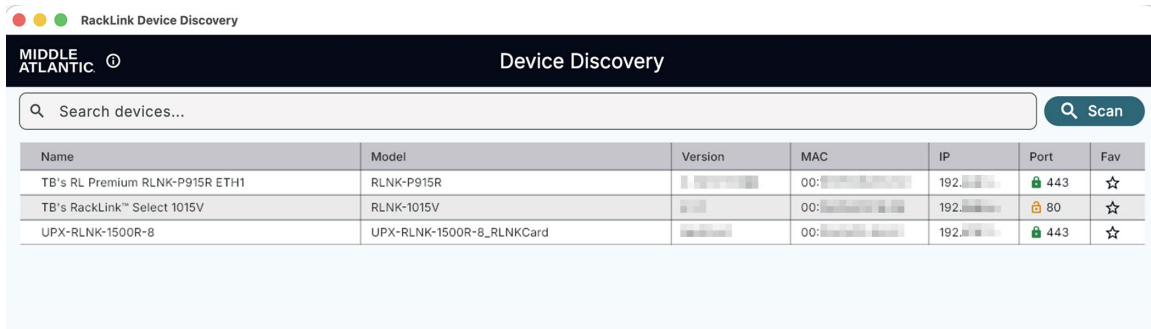

For more information, see [Downloading and Using the RackLink Device Discovery Tool](#), on page 247.

## Installing the RackLink Device Discovery Tool Software on Linux

Use the following steps to download and install the Device Discovery Tool software on Linux®.

1. If you haven't done so already, download the Device Discovery Tool software installer onto your computer from the Power Downloads page at:  
<https://www.legrandav.com/resources/power-downloads>.
2. Open a command prompt and type `cd Downloads/` (or wherever you downloaded the installer on your system) and press **enter**.

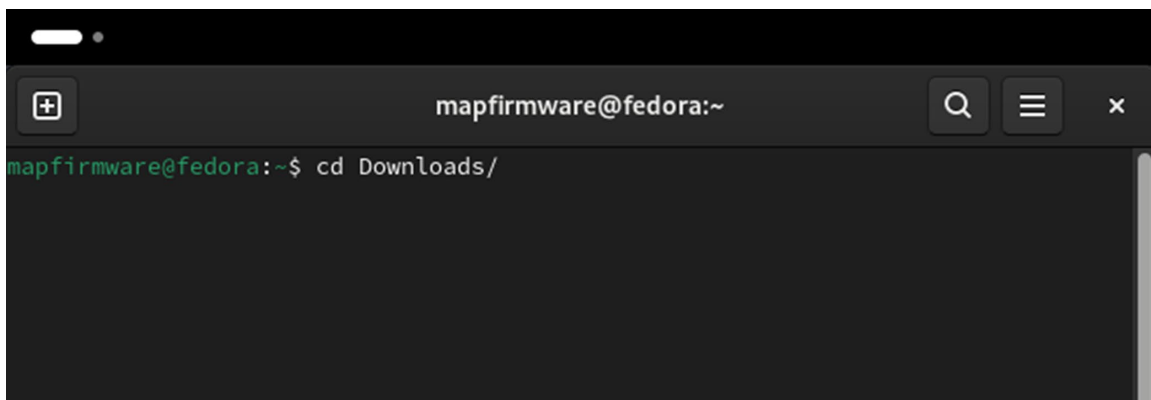

```
mapfirmware@fedora:~$ cd Downloads/
```

3. Type `./discoverytool.AppImage` and press **enter** to launch the installer.

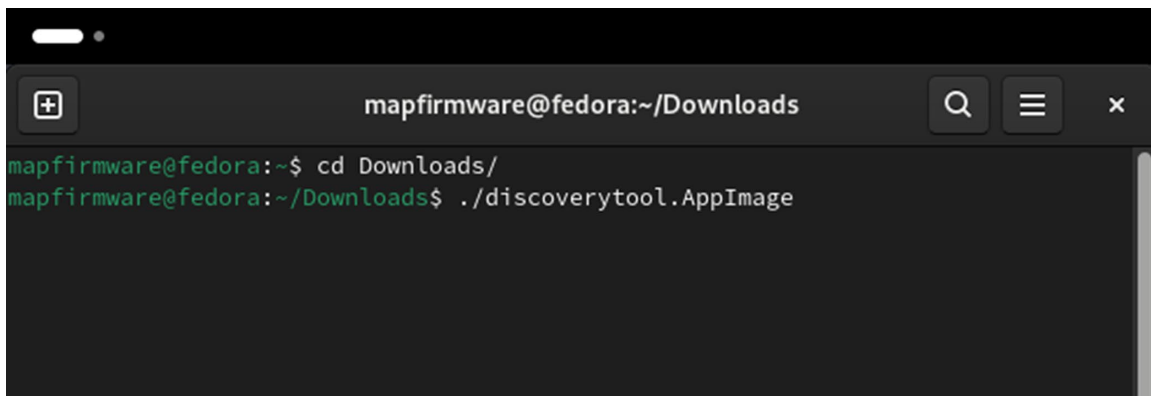

```
mapfirmware@fedora:~/Downloads$ ./discoverytool.AppImage
```

- The main screen of the Discovery Tool appears.

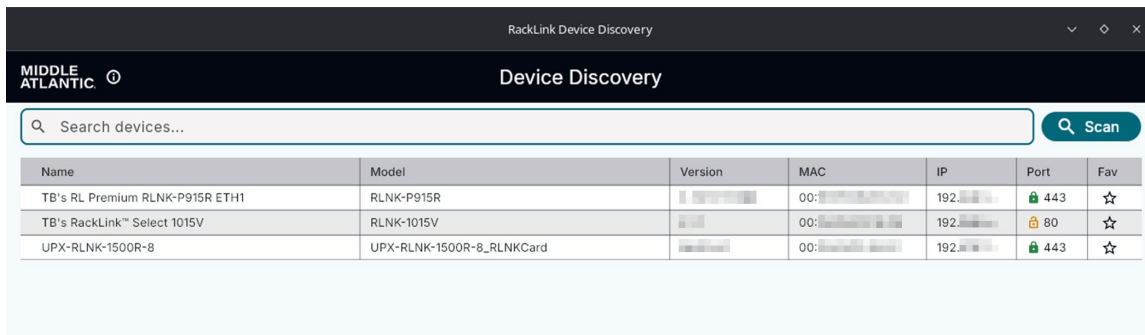

For more information, see [Downloading and Using the RackLink Device Discovery Tool](#), on page 137.

## Understanding Port Pinout Configurations

### Serial RS-232 "RJ-45" Port Pinouts

RJ-45 Pin/signal definition			
Pin No.	Signal	Direction	Description
1	RTS	Output	Request to send
2	DTR	Output	Data terminal ready
3	TxD	Output	Transmit data
4	GND	—	Signal ground
5	DCD	Input	Data
6	RxD	Input	Receive data (data in)
7	DSR	Input	Data set ready
8	CTS	Input	Clear to send

### RJ45-to-DB9 Cable Requirements for Computer Connections

An RJ45-to-DB9 adapter/cable is required for connecting the PDU to a computer, if the use of a USB cable is not intended.

A third party RJ45-to-DB9 adapter/cable needs to meet the following requirements.

- RJ-45 to "DB9 female"
- RX/TX and according control pins are CROSSED

The widespread blue Cisco RJ-45 to DB9 adapter cable is highly recommended, which has the following pin assignments:

DB9 pin signal	DB9 pin No.	RJ-45 pin No.	RJ-45 pin signal
CTS	8	1	RTS
DSR	6	2	DTR
RxD	2	3	TxD
GND	5	4	GND
GND	5	5	GND
TxD	3	6	RxD
DTR	4	7	DSR
RTS	7	8	CTS
DCD	1 (Not connected)	N/A	
RI	9 (Not connected)		

## Sensor RJ-45 Port Pinouts

RJ-45 Pin/signal definition			
Pin No.	Signal	Direction	Description
1	+12V	—	Power (fuse protected)
2	+12V	—	Power (fuse protected)
3	GND	—	Signal Ground
4	RS485_DP	bi-directional	Data Positive of the RS-485 bus
5	RS485_DN	bi-directional	Data Negative of the RS-485 bus
6	GND	—	Signal Ground
7	1-wire	—	Used for Feature Port
8	GND	—	Signal Ground

**NOTE**

A maximum of 500mA power is permitted for both pin 1 and pin 2 altogether.

## Expansion RJ-45 Port Pinouts

RJ-45 Pin/signal definition			
Pin No.	Signal	Direction	Description
1	+12V	—	Power (fuse protected)
2	+12V	—	Power (fuse protected)
3	GND	—	Signal Ground
4	RS485_DP	bi-directional	Data Positive of the RS-485 bus
5	RS485_DN	bi-directional	Data Negative of the RS-485 bus
6	GND	—	Signal Ground
7	NC	—	No Connection
8	GND	—	Signal Ground

## Feature RJ-45 Port Pinouts

RJ-45 Pin/signal definition			
Pin No.	Signal	Direction	Description
1	DTR	Output	Reserved
2	GND	—	Signal Ground
3	+5V	—	Power for CIM (200mA, fuse protected)



**WARNING** Pin 3 is only intended for use with Middle Atlantic Products devices.

<b>RJ-45 Pin/signal definition</b>			
Pin No.	Signal	Direction	Description
			<p>La broche 3 est uniquement destinée à être utilisée avec les appareils Middle Atlantic Products.</p> <p><b>AVERTISSEMENT</b></p>
4	TxD	Output	Transmit Data (Data out)
5	RxD	Input	Receive Data (Data in)
6	+12V	—	<p>Pin 6 is only intended for use with Middle Atlantic Products devices. Do not connect.</p> <p><b>WARNING</b></p> <p></p> <p><b>AVERTISSEMENT</b></p> <p>La broche 6 est uniquement destinée à être utilisée avec les appareils Middle Atlantic Products. Ne branchez pas.</p>
7	GND	—	Signal Ground
8	DCD	Input	Reserved

# Warranty

For warranty information, refer to [www.legrandav.com/policies/warranty\\_information](http://www.legrandav.com/policies/warranty_information).

## Contacting Corporate Headquarters

P: (866) 977-3901 | F: (877) 894-6918 | [www.legrandav.com](http://www.legrandav.com) | [av.support@legrand.com](mailto:av.support@legrand.com)

## Contacting Middle Atlantic Canada

P: (888) 766-9770 | F: (888) 599-5009 | [ca.middleatlantic.com](http://ca.middleatlantic.com) | [av.canada.customerservice@legrand.com](mailto:av.canada.customerservice@legrand.com)

## Contacting Middle Atlantic Europe, Middle East, and Africa (EMEA) Technical Support

P: +31 495-726-003 | [av.emea.middleatlantic.support@legrand.com](mailto:av.emea.middleatlantic.support@legrand.com)

### United States (US)

Legrand | AV Headquarters  
6436 City West Parkway  
Eden Prairie, MN, 55344, USA

### European Union (EU)

Legrand AV Netherlands  
B.V. Franklinstraat 14 6003  
DK, Weert, Netherlands

### United Kingdom (UK)

Starline Holding Technology Ltd.  
(Authorized Representative)  
Unit C, Island Rd.  
Reading RG2, 0RP- UK

At Legrand AV Inc. we are always listening. Your comments are welcome.  
Legrand AV is an ISO 9001 and ISO 14001 Registered Company.