

H544 - Support Kit for AV Credenza

Beautifully executed video conferencing.

To reduce the risk of severe injury or death to persons, review these installation safety steps before proceeding:

1. Read all installation instructions for AV Credenza and AV Credenza accessories before beginning any installation.
2. When supporting one or more displays using H544 Support Kit for AV Credenza, always install the legs. Failure to support the weight of one or more displays to the ground may result in injury.
3. Always use H570 Dual Display Kit for AV Credenza in combination with the display supports and legs of H544 Support Kit. Failure to support the weight of one or more displays to the ground may result in injury.
4. Anchor the AV Credenza to the wall for all installations.
5. Use the wood cleat provided for all installations.
6. Heavy duty SNAPTOGGLE brand wall anchors and 3/8" diameter screws are provided for your convenience. While these wall anchors and screws are suitable for many drywall and steel stud installations, a professional should determine the best anchoring hardware and method for each specific installation.
7. If you discover a defect, please contact service@hecklerdesign.com.

CAUTION: Shock Hazard

AV Credenza is an aluminum enclosure and therefore is electrically conductive. Like all metal enclosures AV Credenza should be grounded by a professional to reduce the risk of shock due to static electricity or electrical shorts. AV Credenza features two ground lug locations for this purpose. Bonding AV Credenza to a grounded PDU via these grounding lugs is recommended.

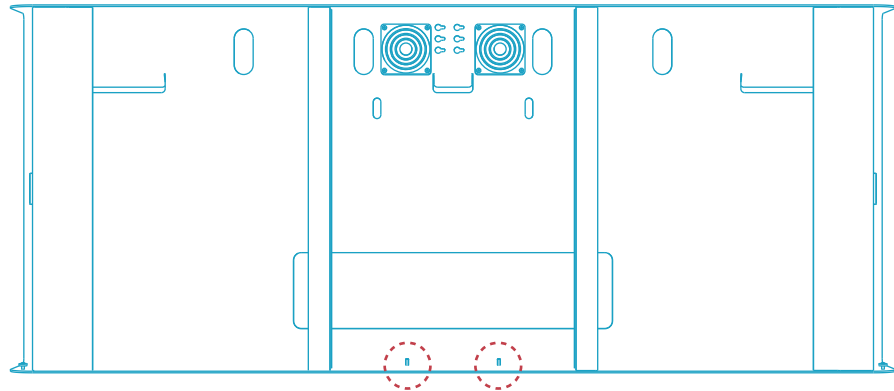

grounding lug locations

IN THE BOX

- A** 2 x Display Support
- B** 2 x Leg
- C** 2 x Display Support Anchor
- D** 4 x Screw, 10-32, 1/2" Long
- E** 1 x Hex Key, 1/8"
- F** 4 x Flanged Wingnut, 3/8"-16
- G** 4 x Screw, 3/8"-16, 2-1/2" Long
- H** 1 x Hex Key, 5/16"
- I** 8 x Cable Tie
- J** 1 x Display-Mounting Screws and Spacers

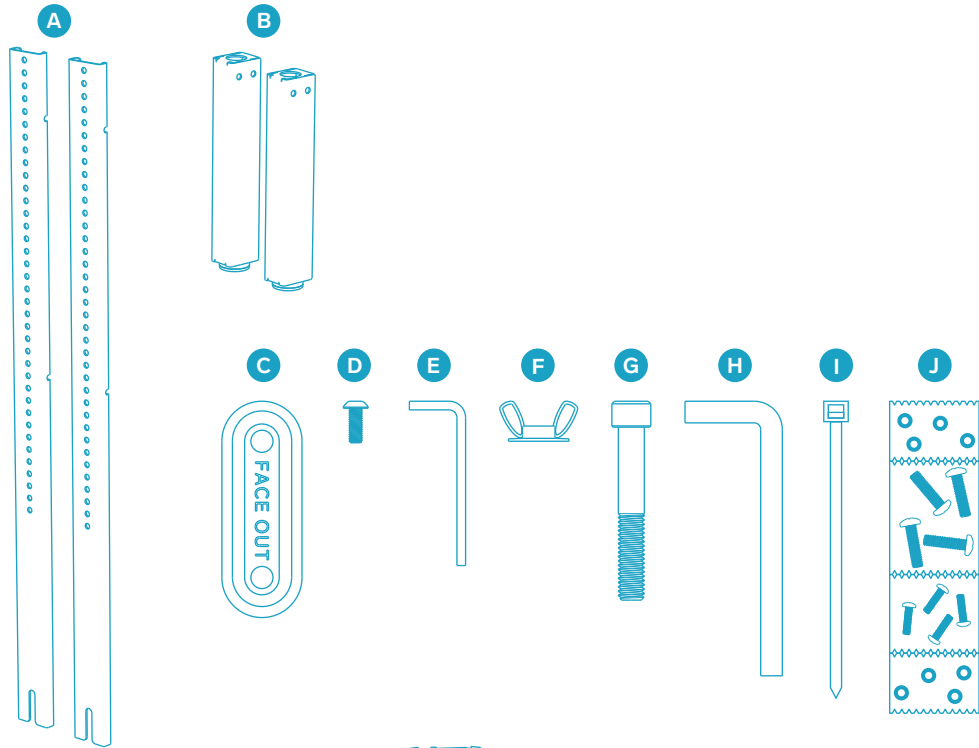

TOOLS NEEDED

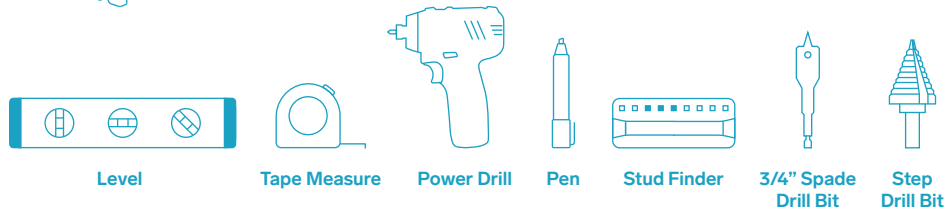

STEP 1

Install display support anchors.



1. Measure the horizontal distance between your display's VESA mounting positions.
2. Fasten the display support anchors to the corresponding locations as shown below.

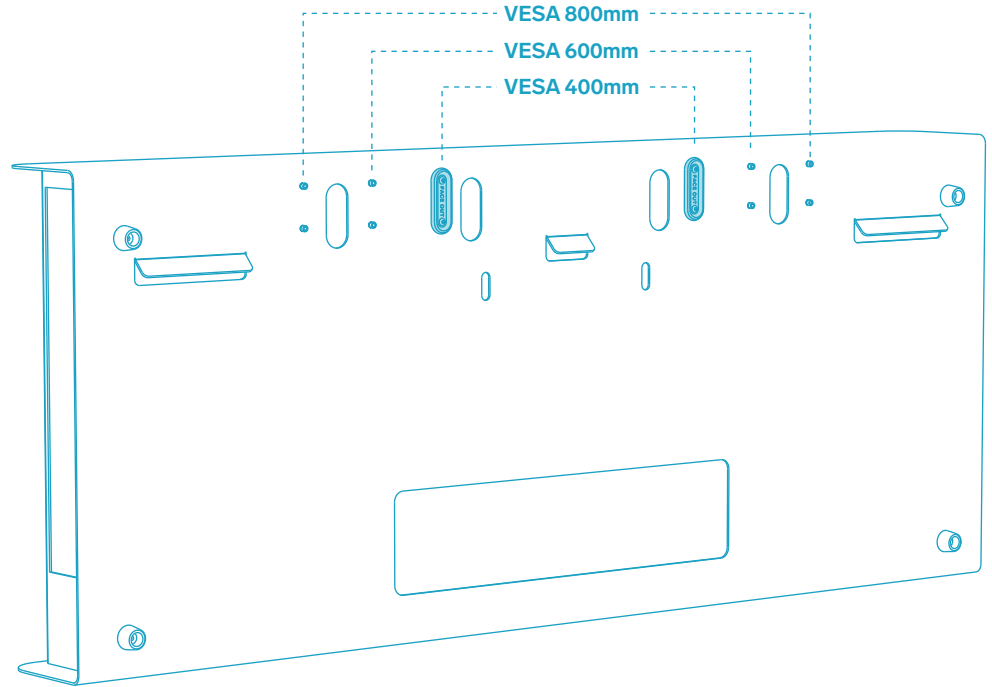
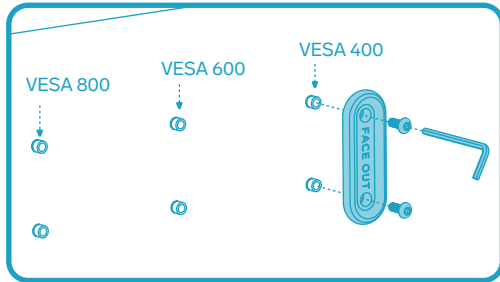

STEP 2

Determine the height of AV Credenza and install legs.



The standard height of AV Credenza with Support Kit positions the top surface of AV Credenza at 36" above finished floor. If you would like a 35" or 34" installation height, fasten the legs as shown below.

Important note:

When installing at 34" or 35", lower your French cleat installation height accordingly as shown on Page 8.

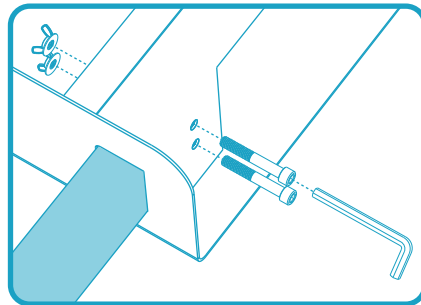
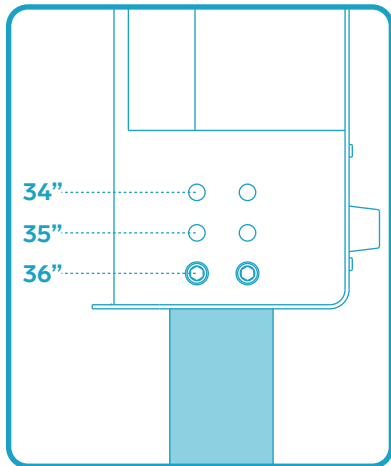
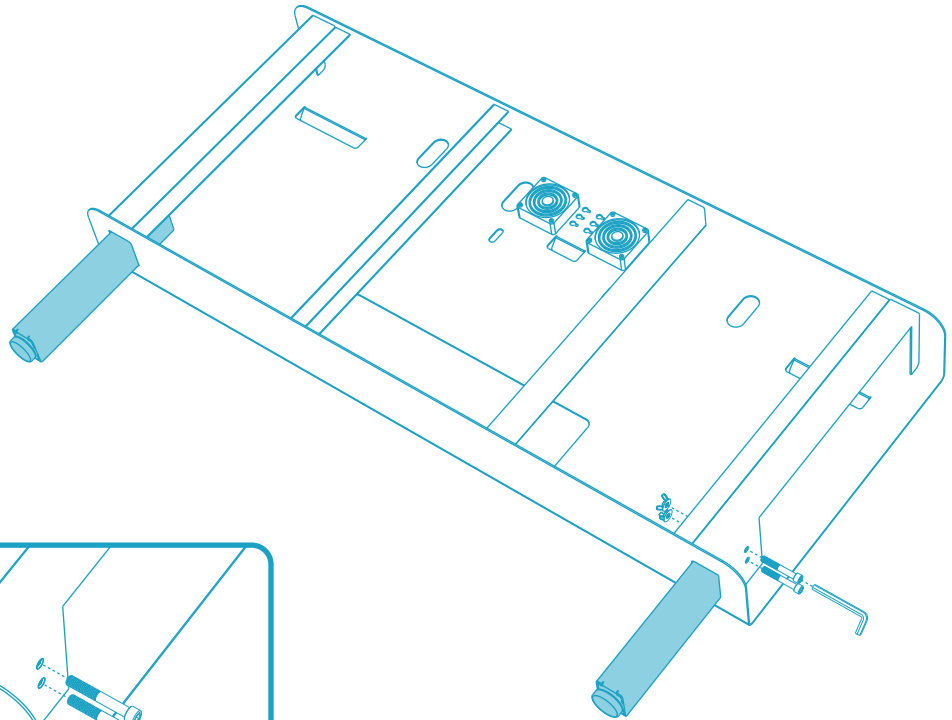

STEP 3

Install 19" rack components and organize the devices and cables.

For complete installation instructions, refer to the AV Credenza Instruction Guide Page 8-11. Go to heckler.design/H543 or scan the QR code below.

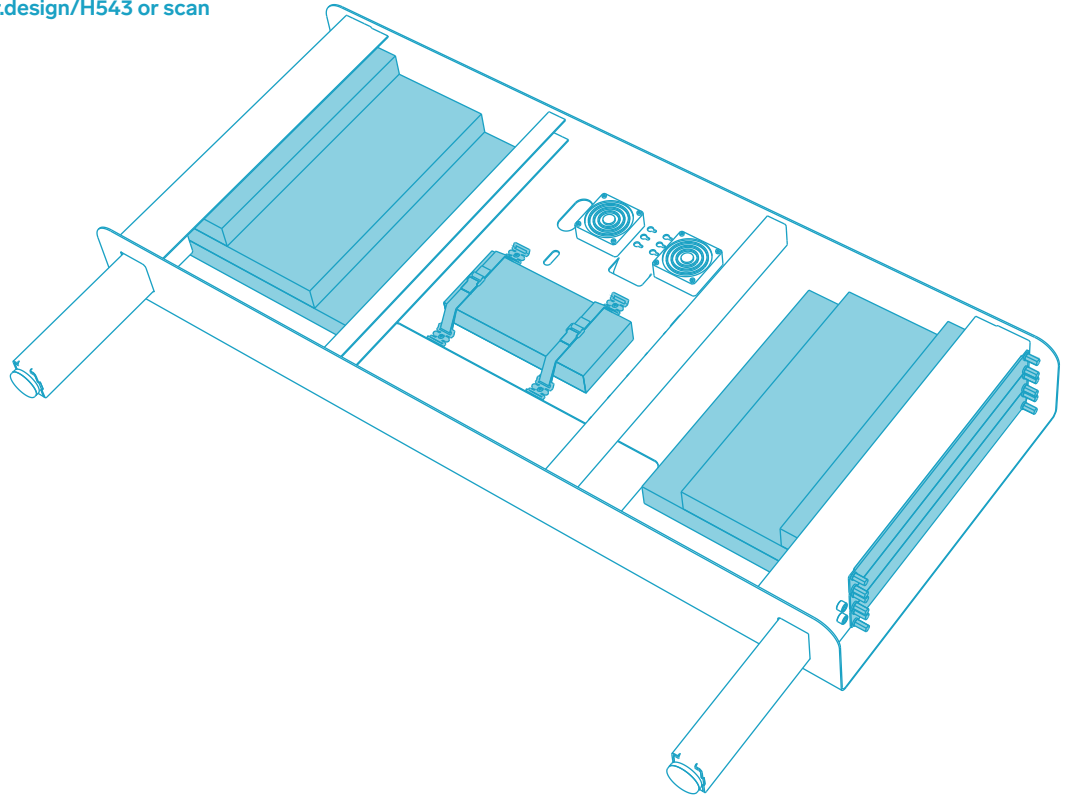

STEP 4

Install the French cleat.

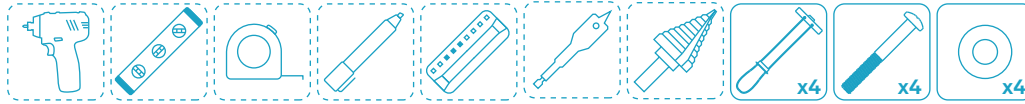

AV Credenza Top Surface	36"	35"	34"
Cleat Hole Position AFF	30"	29"	28"

For complete French cleat installation instructions, refer to the AV Credenza Instruction Guide Page 6-7. Go to heckler.design/H543 or scan the QR code below.

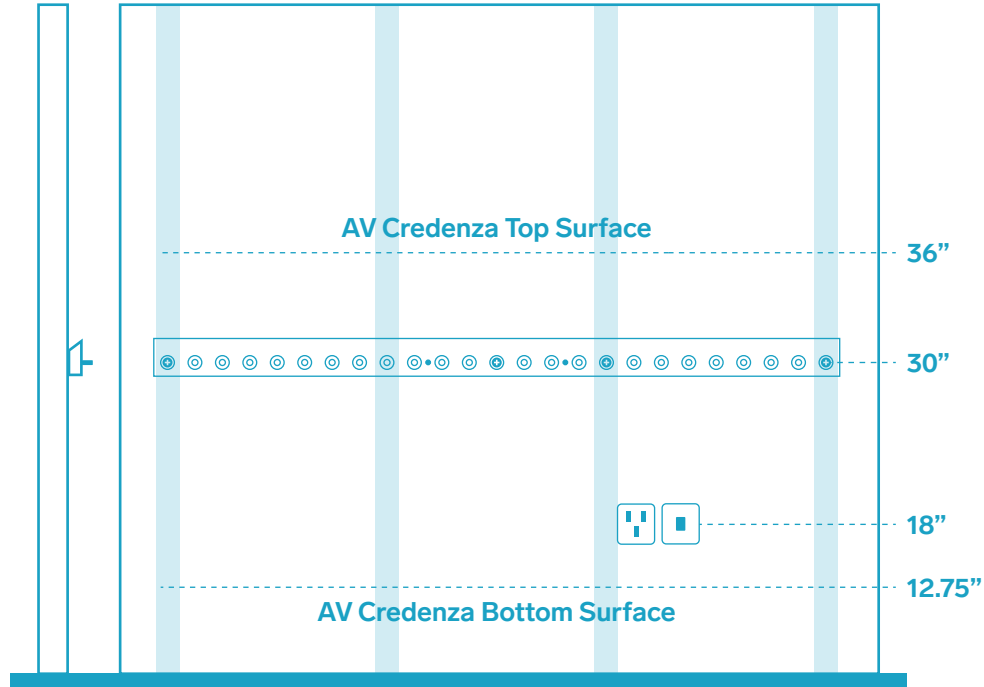

STEP 5

Hang AV Credenza body to the French Cleat.

Using two people, carefully hang AV Credenza body with legs to the French cleat. As you lower the AV Credenza to the cleat, take care to align the cleat's anchoring posts to the corresponding slots in the back wall of AV Credenza.

Check to ensure all three mounting flanges in the back of AV Credenza body are seated flush on the top face of the French cleat.

Important Safety Step:

Adjust the leveling foot on each leg so that the legs, not the French cleat, support the weight of the AV Credenza.

You may need to remove AV Credenza from the cleat to adjust the leveling feet.

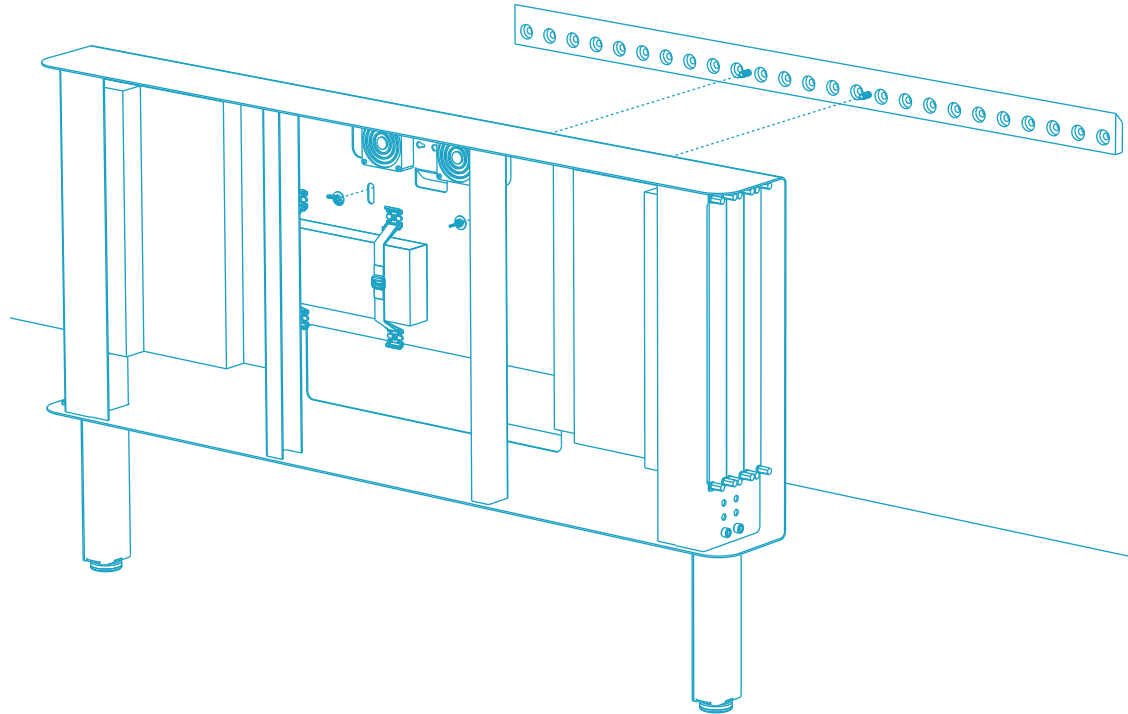

STEP 7

Take note your camera clearance.



Measure the distance between the top surface of AV Credenza and the desired location of the bottom edge of your display. Note the measurement.



Distance A = _____

Camera Mount is included with AV Credenza. For complete Camera Mount installation instructions, refer to the AV Credenza Instruction Guide Page 14. Go to heckler.design/H543 or scan the QR code below.

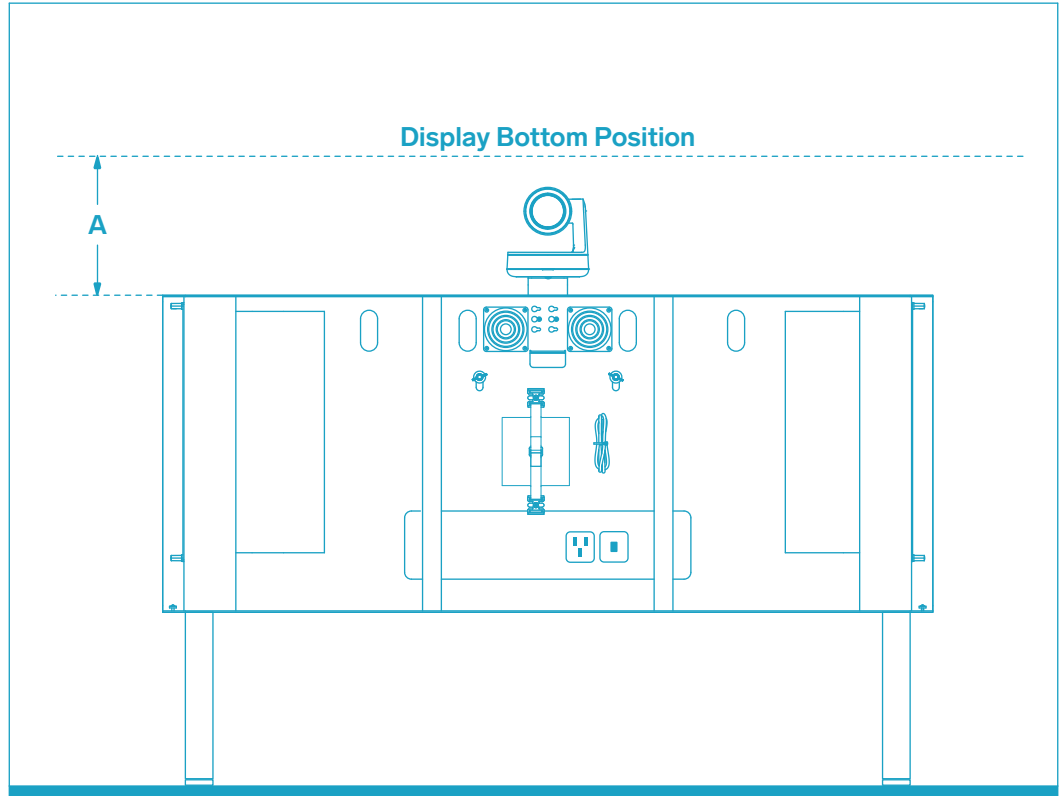

STEP 8

Fasten display supports to your display.

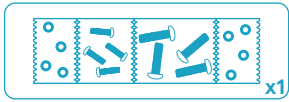

1. Use measurement A and the notch that indicates the top of AV Credenza to position each display support to your display.

2. Important Notes:

The following steps should be performed by a professional.

Select the appropriate screw to fasten each display support to your display. A set of potential screws and spacers are provided for your convenience. Refer to the display manufacturer's mounting requirements to select the correct screw size and length. This may require the purchase of alternate screws.

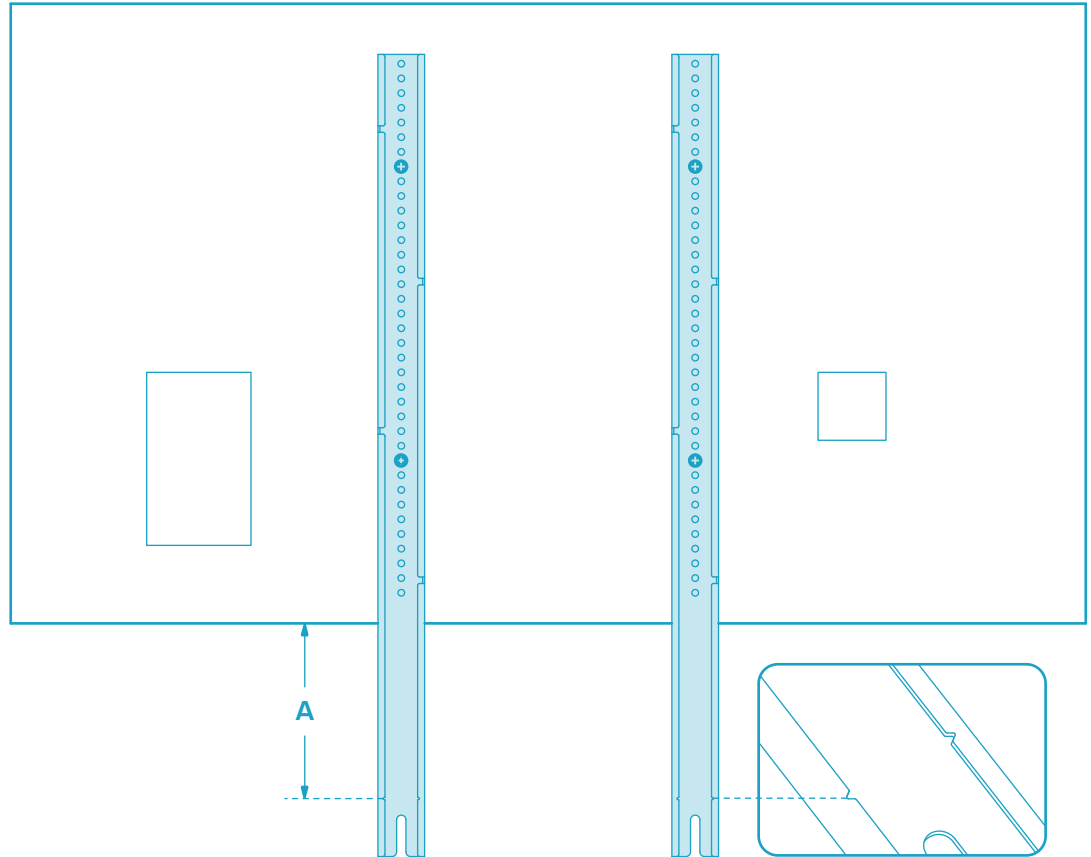

STEP 9

Route display and HDMI cables.



Route power cables and HDMI cables from the bottom of the display support through the exit points on the side of the display support.

Use the provided zip ties to secure the cables near their exit points.

Tip: You may need to source long power cables and long HDMI cables to reach from the displays to the devices within AV Credenza.

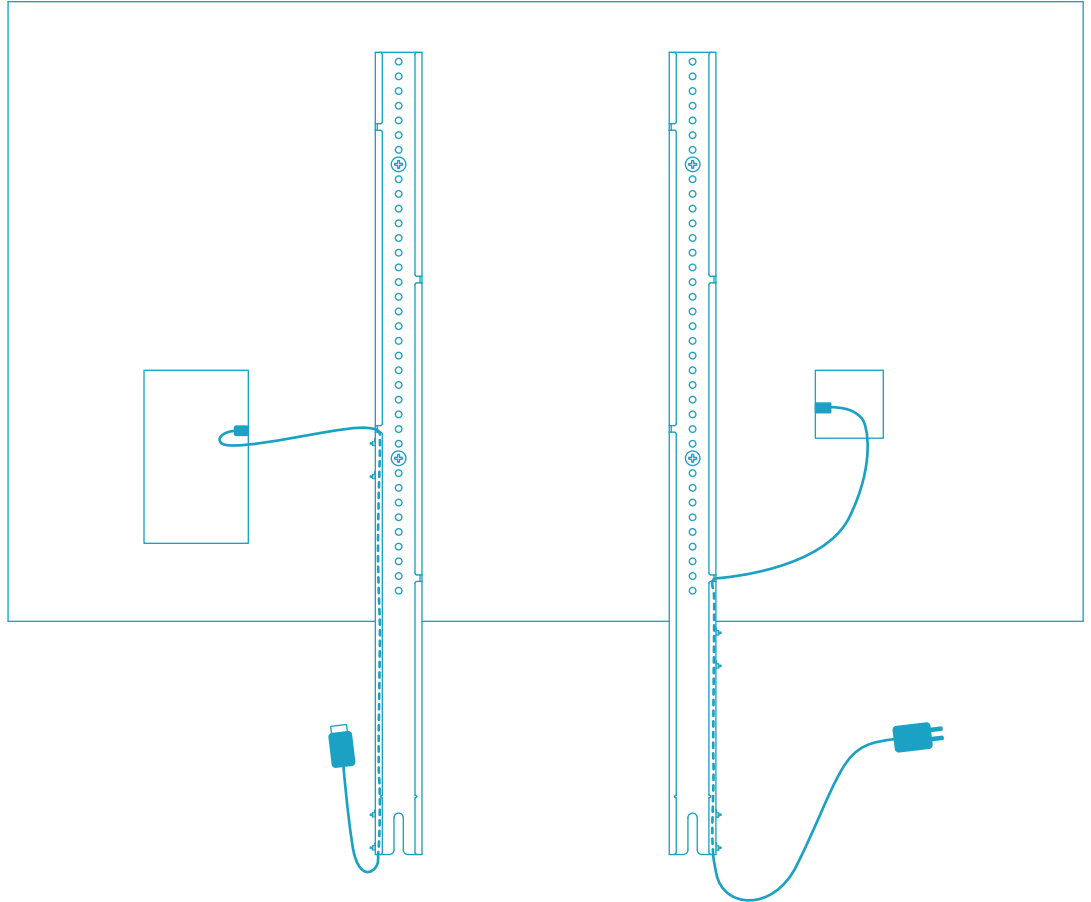
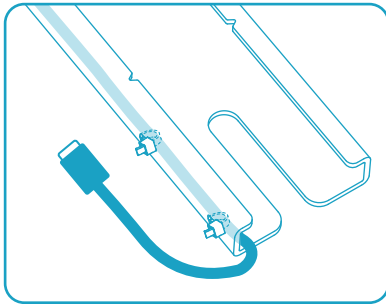

STEP 10

Install the display supports to AV Credenza.

Important safety note:

Use two people for this step.

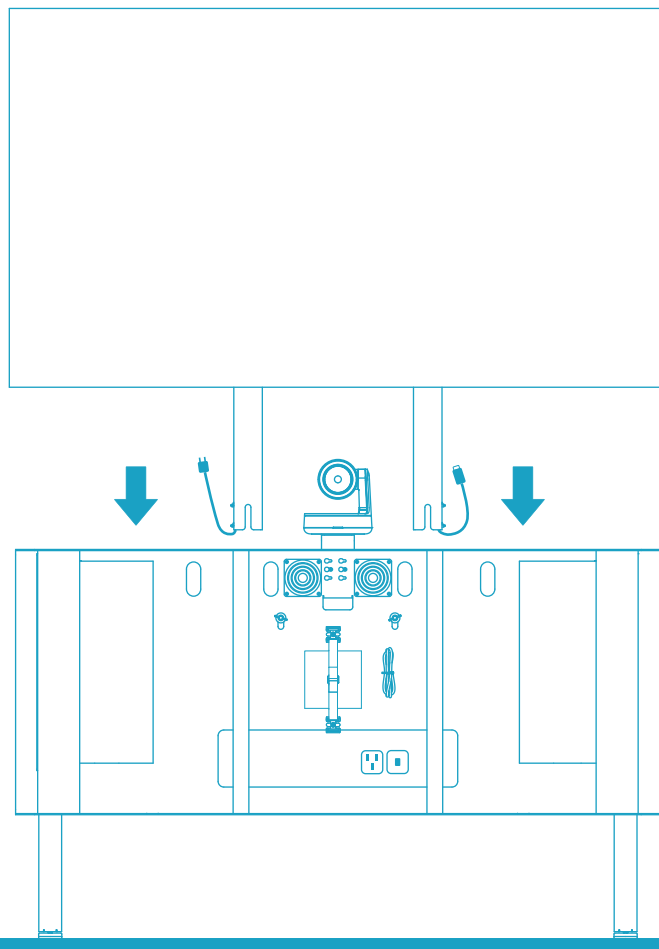
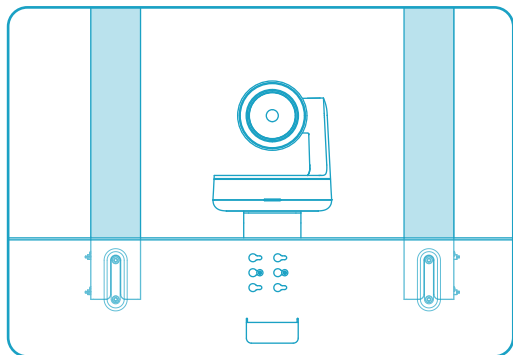
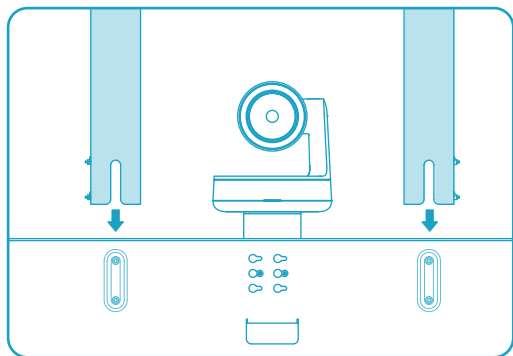

STEP 11

Connect cables.

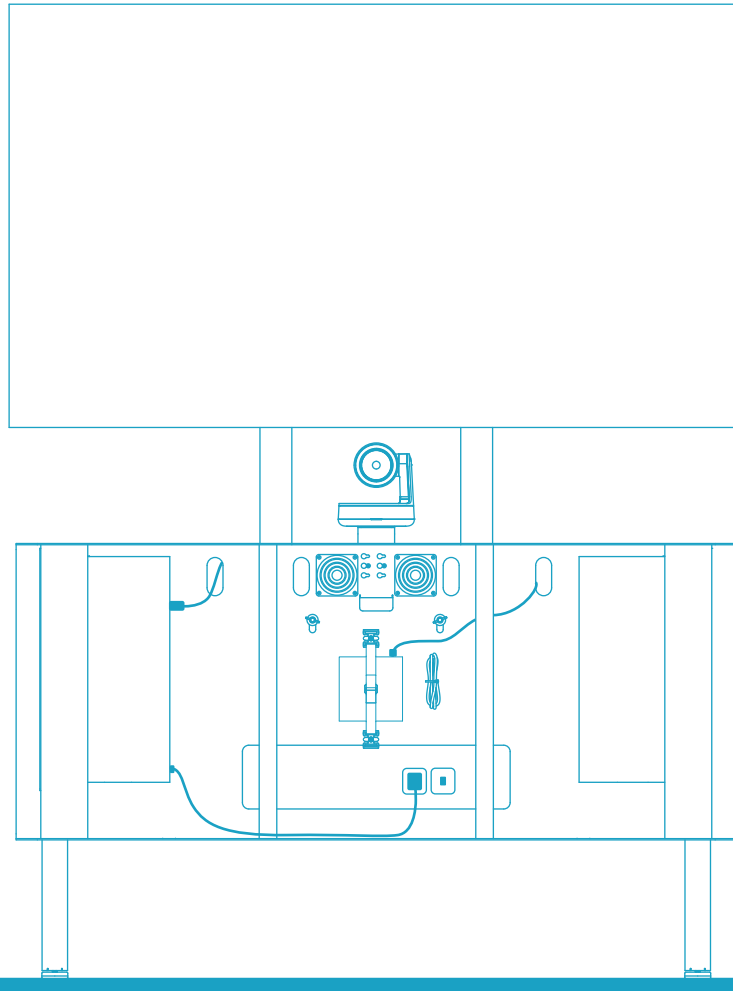

STEP 12

Attach the front cover.

