

# AIM-68 Computer



User Manual

**ADVANTECH**

**研華科技**

## Copyright

The documentation and the software included with this product are copyrighted 2017 by Advantech Co., Ltd. All rights are reserved. Advantech Co., Ltd. reserves the right to make improvements in the products described in this manual at any time without notice. No part of this manual may be reproduced, copied, translated or transmitted in any form or by any means without the prior written permission of Advantech Co., Ltd. Information provided in this manual is intended to be accurate and reliable. However, Advantech Co., Ltd. assumes no responsibility for its use, nor for any infringements of the rights of third parties, which may result from its use.

## Acknowledgements

All other product names or trademarks are properties of their respective owners.

# Declaration of Conformity

## CE Conformity Statement

Radio products with the CE alert marking comply with the R&TTE Directive (1999/5/EC) issued by the Commission of the European Community. Compliance with this directive implies conformity to the following European Norms (in brackets are the equivalent international standards).

- EN 60950-1 (IEC60950-1) - Product Safety
- EN 300 328 Technical requirement for radio equipment
- ET S301 489 General EMC requirements for radio equipment

Products that contain the radio transmitter are labeled with CE alert marking and may also carry the CE logo.

## FCC Compliance Statement

This equipment generates, uses and can radiate radio frequency energy and, if not installed and used in accordance with the instructions, may cause harmful interference to radio communications. However, there is no guarantee that interference will not occur in a particular installation. If this equipment does cause harmful interference to radio or television reception, which can be determined by turning the equipment off and on, the user is encouraged to try to correct the interference by one of the following measures:

- Reorient or relocate the receiving antenna.
- Increase the separation between the equipment and receiver.
- Connect the equipment into an outlet on a circuit different from that to which the receiver is connected.
- Consult the dealer or an experienced radio/TV technician for help.

To assure continued compliance, any changes or modifications not expressly approved by the party responsible for compliance could void the user's authority to operate this equipment. (Example: use only shielded interface cables when connecting to computer or peripheral devices).

This device complies with Part 15 of the FCC Rules. Operation is subject to the following two conditions:

- 1) This device may not cause harmful interference, and
- 2) This device must accept any interference received, including interference that may cause undesired operation.

## 15.21

Any changes or modifications not expressly approved by the party responsible for compliance could void the authority to operate equipment.

This device and its antenna must not be co-located or operating in conjunction with any other antenna or transmitter.

End-users and installers must be provided with antenna installation instructions and transmitter operating conditions for satisfying RF exposure compliance.

For product available in the USA/Canada market, only channel 1~11 can be operated. Selection of other channels is not possible.

## FCC Radiation Exposure Statement

This equipment complies with FCC RF radiation exposure limits set forth for an uncontrolled environment for body-worn configuration in direct contact to the phantom.

This device complies with FCC radiation exposure limits set forth for an uncontrolled environment.

This equipment complies with FCC radiation exposure limits set forth for an uncontrolled environment. End user must follow the specific operating instructions for satisfying RF exposure compliance. This transmitter must not be co-located or operating in conjunction with any other antenna or transmitter.

The portable device is designed to meet the requirements for exposure to radio waves established by the Federal Communications Commission (USA). These requirements set a SAR limit of 1.6 W/kg averaged over one gram of tissue. The highest SAR value reported under this standard during product certification for use when properly worn on the body

## IC warning statement

This device complies with Industry Canada's licence-exempt RSSs. Operation is subject to the following two conditions: (1) This device may not cause interference; and (2) This device must accept any interference, including interference that may cause undesired operation of the device.

Le présent appareil est conforme aux CNR d'Industrie Canada applicables aux appareils radio exempts de licence. L'exploitation est autorisée aux deux conditions suivantes : (1) l'appareil ne doit pas produire de brouillage, et (2) l'utilisateur de l'appareil doit accepter tout brouillage radioélectrique subi, même si le brouillage est susceptible d'en compromettre le fonctionnement.

This radio transmitter has been approved by Industry Canada to operate with the antenna types listed below with the maximum permissible gain and required antenna impedance are strictly prohibited for use with this device.

Le présent émetteur radio a été approuvé par Industrie Canada pour fonctionner avec les types d'antenne énumérés ci-dessous et ayant un gain admissible maximal et l'impédance requise pour chaque type d'antenne. Les types d'antenne non inclus dans cette liste, ou dont le gain est supérieur au gain maximal indiqué, sont strictement interdits pour l'exploitation de l'émetteur.

(i) the device for operation in the band 5150-5250 MHz is only for indoor use to reduce the potential for harmful interference to co-channel mobile satellite systems; (For devices installed in vehicles point i. is not required.)

Users should also be advised that high-power radars are allocated as primary users (i.e. priority users) of the bands 5250-5350 MHz and 5650-5850 MHz and that these radars could cause interference and/or damage to LE-LAN devices.

(i) l'appareil pour fonctionner dans la bande 5150-5250 MHz est réservé à une utilisation en intérieur afin de réduire les risques d'interférences nuisibles à la co-canal systèmes mobiles par satellite;

Devraient également être informés les utilisateurs que les radars à haute puissance sont désignés comme utilisateurs principaux (c.-à-d. utilisateurs prioritaires) des bandes 5250-5350 MHz et 5650-5850 MHz et que ces radars pourraient provoquer des interférences et / ou endommager les appareils LE-LAN.

## IC Radiation Exposure Statement

This EUT is compliance with SAR for general population/uncontrolled exposure limits in IC RSS-102. This equipment should be installed and operated with minimum distance 0 cm between the radiator & your body.

Cet EUT est la conformite avec SAR pour la population generale / les limites d'exposition incontrolées dans IC RSS-102. Cet équipement doit être installé et utilise a une distance minimale de 0 cm entre le radiateur et votre corps.

This equipment complies with ISED radiation exposure limits set forth for an uncontrolled environment. End user must follow the specific operating instructions for satisfying RF exposure compliance. This transmitter must not be co-located or operating in conjunction with any other antenna or transmitter.

The portable device is designed to meet the requirements for exposure to radio waves established by the ISED. These requirements set a SAR limit of 1.6 W/kg averaged over one gram of tissue. The highest SAR value reported under this standard during product certification for use when properly worn on the body. Cet équipement est conforme aux limites d'exposition aux rayonnements ISED établies pour un environnement non contrôlé. L'utilisateur final doit suivre les instructions spécifiques pour satisfaire les normes. Cet émetteur ne doit pas être co-implanté ou fonctionner en conjonction avec toute autre antenne ou transmetteur.

## NCC Warning Statement

### Article 12

Without permission, any company, firm or user shall not alter the frequency, increase the power, or change the characteristics and functions of the original design of the certified lower power frequency electric machinery.

### Article 14

The application of low power frequency electric machineries shall not affect the navigation safety nor interfere a legal communication, if an interference is found, the service will be suspended until improvement is made and the interference no longer exists.

# Safety Instructions

1. Read these safety instructions carefully.
2. Keep this user manual for later reference.
3. Disconnect this equipment from AC outlet before cleaning. Do not use liquid or spray detergents for cleaning.
4. Keep this equipment away from hazard locations.
5. Put this equipment on a reliable surface during installation. Dropping it or letting it fall could cause damage.
6. Do not leave this equipment in an environment unconditioned where the storage temperature under  $-20^{\circ}\text{C}$  or above  $60^{\circ}\text{C}$ , it may damage the equipment.
7. Make sure the voltage of the power source is correct before connecting the equipment to the power outlet.
8. Place the AC power adapter such a way that people cannot step on it. Do not place anything over the power adapter.
9. All cautions and warnings on the equipment should be noted.
10. If the equipment is not used for long time, disconnect it from the power source to avoid being damaged by transient over-voltage.
11. Never pour any liquid into slots of the AIM-68 Series. This could cause fire or electrical shock.
12. Never open or disassemble the equipment. For safety reasons, the equipment should be opened only by qualified service personnel.
13. If any of the following situations arises, get the equipment checked by service personnel:
  - a. The power adapter plug is damaged.
  - b. Liquid has penetrated into the equipment.
  - c. The equipment has been exposed to moisture.
  - d. The equipment does not work well or you cannot get it to work according to user manual.
  - e. The equipment has obvious signs of breakage.
14. This product is intended to be supplied by a UL Listed Power Adapter or DC power source, rated 19 Vdc, 3.42A min. for model AIM-68 and Tma 50 degree C, if need further assistance, please contact Advantech for further information.

# Battery Safety

Caution: Danger of explosion if battery is incorrectly replaced. Replace only with the same type recommended by the manufacturer, discard used batteries according to the manufacturer's instructions.

Attention : Danger d'explosion si la batterie est inexactement remplacée. Remplacez seulement avec la même chose ou le type recommandé par le fabricant, jettent les batteries utilisées instructions de s selon fabricant des'.

Mistreat the battery used in this device may present a risk of fire or chemical burn. Do not attempt to disassemble the computer or its accessories. Only qualified personal is allowed to replace the battery. Do not dispose batteries in a fire and check with local authorities for disposal instructions.

AIM-68 can only be equipped with standard battery pack with Getac AIM-BAT-10 2300mAH Polymer Lithium Ion Battery. Use of another battery may present a risk of fire or explosion.

## **Battery Charge Notice**

It is important to consider the environment temperature whenever you are charging the Lithium-Ion battery pack. The process is more efficient at normal room temperature or slightly cooler. It is essential that you charge batteries within the stated range of 0°C to 40°C. Charging batteries outside of the specified range could damage the batteries and shorten their charging life cycle.

## **Storage and Safety Notice**

Although charge Lithium-Ion batteries may be left unused for several months, their capacity may be depleted due to the buildup of internal resistance. If this happens they will require recharging prior to use. Lithium Ion batteries may be stored at temperatures between -10°C to 60°C, however they may be depleted more rapidly at the high end of this range. It is recommended to store AIM-68 within normal room temperature ranges.



# WEEE

EN



**Following information is only for EU-member states:**

The use of the symbol indicates that this product may not be treated as household waste. By ensuring this product is disposed of correctly, you will help prevent potential negative consequences for the environment and human health, which could otherwise be caused by inappropriate waste handling of this product. For more information about recycling of this product, please contact your local city office, your household waste disposal service or the shop where you purchased the product.

## Technical Support and Assistance

1. Visit the Advantech website at <http://support.advantech.com> where you can find the latest information about the product.
2. Contact your distributor, sales representative, or Advantech's customer service center for technical support if you need additional assistance. Please have the following information ready before you call:
  - Product name and serial number
  - Description of your peripheral attachments
  - Description of your software (operating system, version, application software, etc.)
  - A complete description of the problem
  - The exact wording of any error messages

# TABLE OF CONTENT

Chapter 1 Introduction.....	12
1.1 Symbols Used in this Manual.....	13
1.2 Product Features .....	13
1.3 Package Contents .....	13
1.4 Product Specifications .....	14
1.4.1 Technical Specifications .....	14
1.4.2 Product Outlook and Dimensions .....	16
1.5 Exploring the AIM-68.....	17
1.5.1 Front View .....	1
1.5.2 Rear View .....	18
1.5.3 Right View.....	19
1.5.4 Left View .....	20
1.5.5 Bottom View .....	21
Chapter 2 Getting Started .....	22
2.1 Charge the Computer .....	22
2.2 Turn on the Computer.....	23
2.3 Sleep Mode.....	23
2.4 Operate the computer.....	24
2.5 LED indicator status.....	24
Chapter 3 Basic Setups.....	25
3.1 Windows 10 IoT Enterprise Basic Setups .....	26
Chapter 4 Running applications.....	27
4.1 Installing applications .....	27
4.1.1 Install applications with Windows 10 IoT Enterprise .....	28
Chapter 5 Maintenance .....	29
5.1 Maintaining the LCD Display.....	29
5.2 Cleaning the AIM-68.....	29

5.3 Trouble Shooting ..... 29

5.4 ENERGY STAR ..... 30

# Chapter 1 Introduction

Congratulations on your purchase of the AIM-68 Computer.

AIM-68 is powered by Intel Atom x7-Z8750 and supports Windows 10 IoT Enterprise OS.

This product combines stylish design with reliable performance and powerful functionality to best suit all your needs, in a wide range of working conditions. This user manual outlines all you need to know to set up and use your AIM-68. If you have any further questions or queries, contact our technical support team via our website:

<http://support.advantech.com.tw/>

## 1.1 Symbols Used in this Manual

	Denotes information that must be observed. Failure to do so may result in personal harm or damage to the product.
---	--

	Denotes information that must be observed. This is informative notification to have a better experience while using this computer.
---	---

## 1.2 Product Features

- Low power Intel® ATOM™ processor designed for mobile applications.
- Support Windows 10 IoT Enterprise OS.
- 10.1“ WUXGA projected capacitive multi touch display.
- -10°C to 50°C(14°F to 122°F), IP65, MIL-STD 810G / 1.2m(4ft) drop compliant.
- Compact/slim design: 18mm(0.7in) height, 980g(2.2lb) weight.
- Seamless communications, including Wi-Fi, BT, NFC, 3G/4G.
- Optional extension modules, including 1D/2D barcode scanner, MSR, RJ45+COM, UHF RFID Reader and more.
- Optional dock stations, including VESA/Vehicle dock & multi charger design.

## 1.3 Package Contents

Ensure all the following items are present when you receive your AIM-68. If any of these items are missing, contact your dealer immediately.

- AIM-68 Computer
- AC power adaptor
- 2-pin(Plug: type A) power cord

# 1.4 Product Specifications

## 1.4.1 Technical Specifications

Model Name	AIM-68		
Computing System	CPU	Intel Atom x7-Z8750	
	Max Speed	1.6 GHz	
	Memory	4GB LPDDR3	
	OS	Windows 10 IoT Enterprise 64 bit	
Storage	On-board eMMC	32GB/64GB ( Default 64GB)	
	Micro-SD	Micro-SD Card Slot for Storage Expansion	
Display	Display Type	10" TFT IPS LCD Panel	
	Max Resolution	WUXGA, 1920X1200, 380 nits	
	Touch Type	Projected Capacitive Multi-Touch	
	Class Type	G/G Direct Bonding, Corning GG3 Glass	
Communication	WIFI	802.11b/g/n (2.4Ghz)	Dual Band : 802.11ac (5Ghz) or 802.11n(2.4Ghz)
	Bluetooth	Bluetooth v4.0 CLASS II/BLE	
	NFC (13.5MHz)	Read/ Write Device Compatible With ISO15693, ISO14443A, ISO14443B, Felica	
	AGPS	AGPS	AGPS
	GPS	GPS & GLONASS & (Optional) Beidou	GPS & GLONASS & (Optional) Beidou
	WWAN/ LTE (Optional)	M.2 Module Micro-SIM Slot	
Audio	Build-In Digital MIC, x1 80dB 1Watt SPK 0.5M, x1 Audio combo jack		
Connectivity	I/O Port	x1 USB 3.0	
	Interfaces	x1 Micro HDMI: Display	
		x1 AIM Dock 16-pin Pogo Connector: USB 3.0	
		x1 AIM Extension 14-pin Pogo Connector: USB 2.0 + TX/RX + Power	
		x1 DC Jack: 19V/3.42A 65W	
Camera	Front	2MP Fixed Focus	
	Rear	5MP Auto Focus with LED Flash	
Sensor	G-sensor + E-compass, Gyroscope, ALS		

Hard Buttons	Function	x1 Power Button x2 Volume Control Button x1 Programmable Button ( Default as BCR Trigger Key)
	System Indicators	x1 Power / Battery Status
	Power Input	DC Jack DC 19V, 3.42A
Battery	Capacity	Swappable Battery with Battery Meter 10.8Vdc · 2300mAh · 24.84Wh
	Operating Temperature	0~40 °C (Charging) -10~50 °C (Discharging)
	Environment	Temperature Operating: -10°C ~ +50°C, Storage: -20°C ~ +60°C, System Charging mode: 0~40 °C
Ingress Protection	Dust/ Water Resistance	IP-65 compliant
	Dimensions	280 x 180 x 18.3~20.95mm (W x H x D)
	Weight	950g
Ingress Protection	Color	Grey/Blue

### 1.4.2 Product Outlook and Dimensions

All AIM-68 Series share the same dimension, the following illustration uses AIM-68 as example.

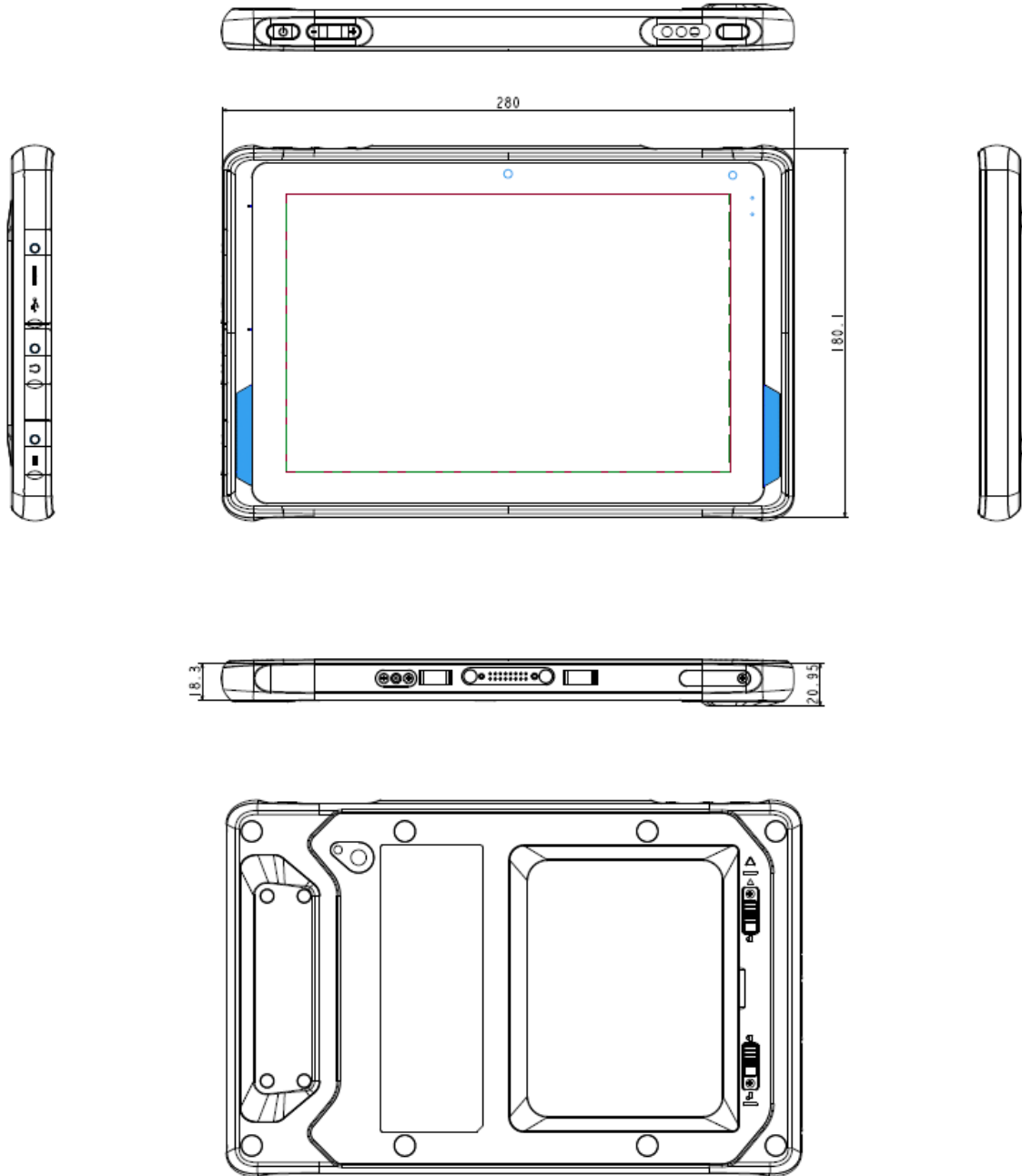



## 1.5 Exploring the AIM-68

### 1.5.1 Front View

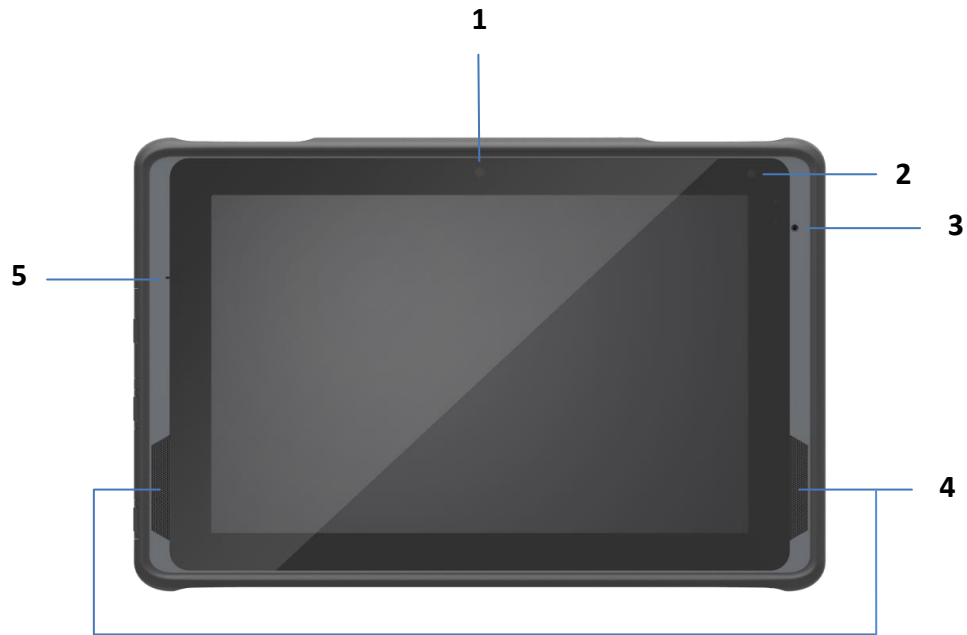

No.	Component
1	Front Camera
2	Light Sensor
3	Power Indicator
4	Right Speaker
5	Mic

### 1.5.2 Rear View

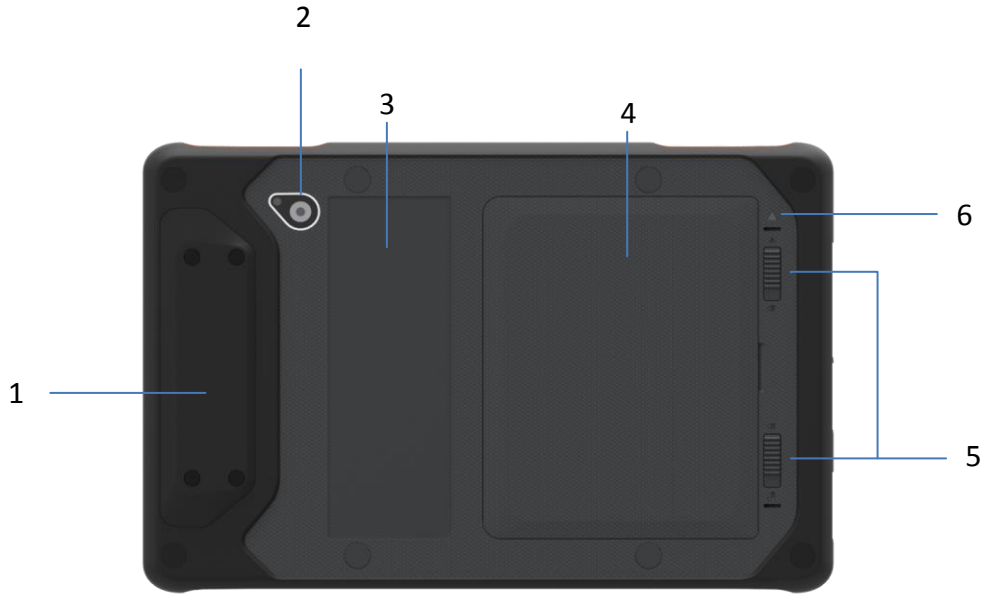

No.	Component
1	Extension Module Cover (connector under the cover) 
2	Rear Camera with LED Flash
3	NFC
4	Battery Cover
5	Battery Cover Latch
6	Hot-swap indicator

### 1.5.3 Right View



### 1.5.4 Left View

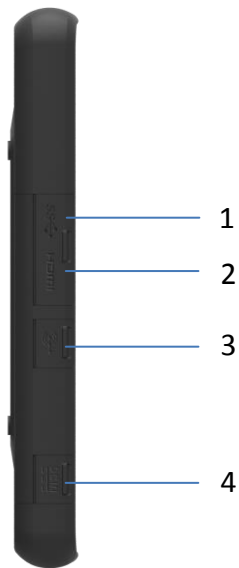

No.	Component
1	Micro HDMI Door
2	USB Port Door
3	Microphone Port Door
4	DC Jack Port Door

### 1.5.5 AIM10 Top View

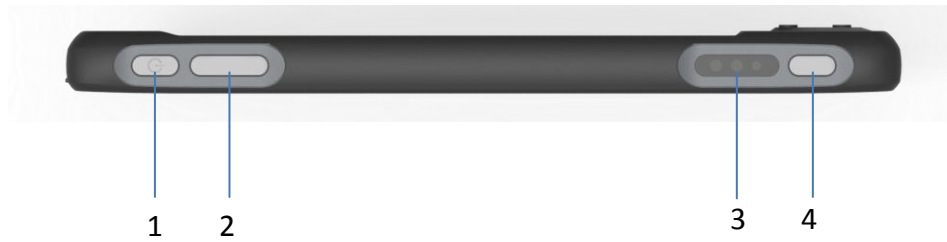

No.	Component
1	Power Button
2	Volume Button( Up, Down)
3	Barcode Scanner
4	Programmable Button

### 1.5.6 AIM10 Bottom View

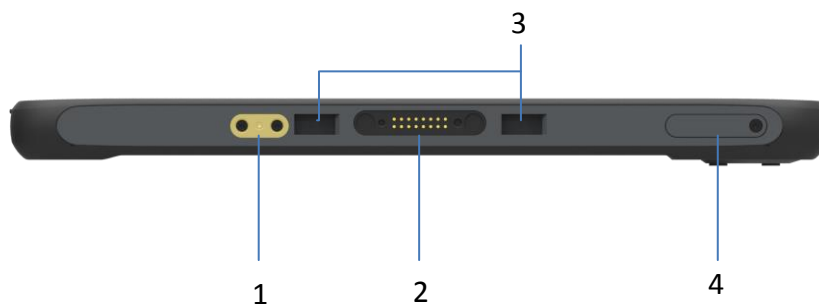

No.	Component
1	Reserved function
2	16 pin pogo connector
3	Positioning hole
4	SIM Card/ Micro-SD Card cover

# Chapter 2 Getting Started

## 2.1 Charge the Computer

To charge the embedded battery in AIM-68, connect the DC plug adaptor on the AIM-68 computer.



<p><b>Note</b></p> 	<p>Please charge for at least one hour when you use this computer for the first time.</p>
--	---

## 2.2 Turn on the Computer

Push the Power Button for 3 seconds to start the computer.



Power Button

## 2.3 Sleep Mode

While the computer is running, push the Power Button for 1 second will move the equipment into sleep mode for power saving. Push the Power Button again will enable the backlight again.

## 2.4 Operate the computer

AIM-68 is equipped with a 10" Capacitive Touch Panel. Use finger to touch the following Active Area to operate the computer.



## 2.5 LED indicator status

AIM-68 is equipped with one LED indicator for battery status. The following shows LED status for different power states.

This power LED has three colors: Red, Green, and Blue.

- a) The Red LED blinks when internal battery capacity is below 10% to warn the user to charge.
- b) The Blue LED lights up when internal battery is being charged.
- c) The Green LED lights up when internal battery has been fully charged.



## Chapter 3 Basic Setups

 <p><b>Note</b></p>	WLAN access requires a separate purchase of an access point. Contact a wireless service provider for more information.
--	--

 <p><b>Note</b></p>	Screens used in this manual are for illustrative purposes only. Actual screens may vary depending on your product version and pre-installed Operating System versions.
--	--

AIM-68 system power down when system battery level drops to 7%.

### 3.1 Windows 10 IoT Enterprise Basic Setups

Windows 10 IoT Enterprise Home Screen

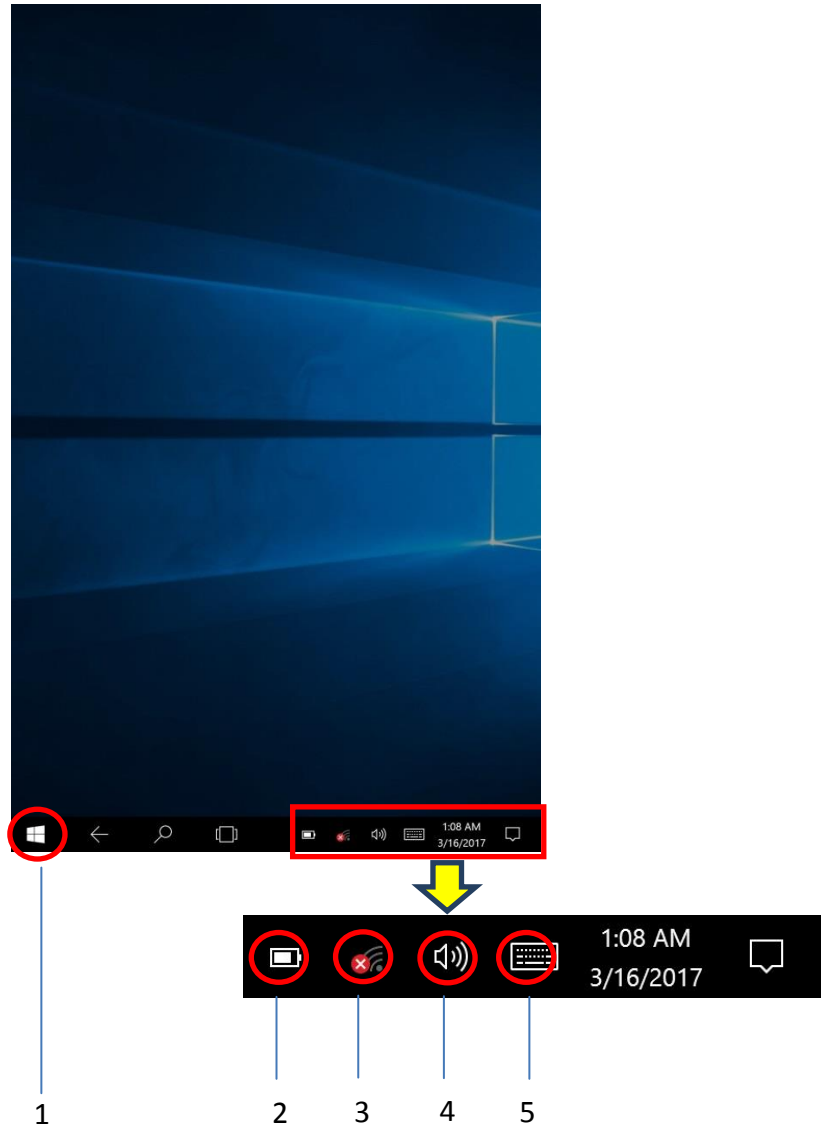

No.	Function
1	Program Launcher
2	Battery Status
3	Connect WLAN
4	Adjust Audio Volume
5	Open the On-screen keyboard

# Chapter 4 Running applications

## 4.1 Installing applications

There are multiple ways to install applications on AIM-68 and this section shows the steps to install applications via Micro SD cards.

1. Before installation, please ensure your Micro SD card has been correctly formatted with FAT32 file system.
2. Copy .exe (Windows) or .apk (Android) on the Micro SD card.
3. Open the Micro SD card slot on the top of the device and inset the card.



Micro SD slot

## 4.1.1 Install applications with Windows 10 IoT Enterprise

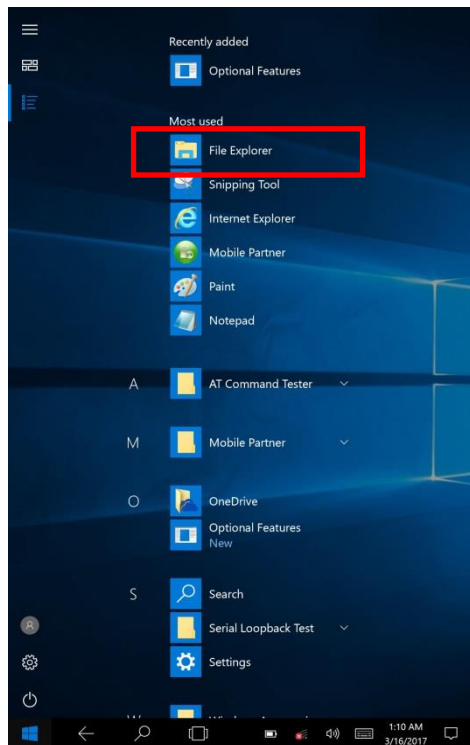

- a) Go to Program Launcher
- b) Launch File Explorer and will find Secure Digital storage device (D:)

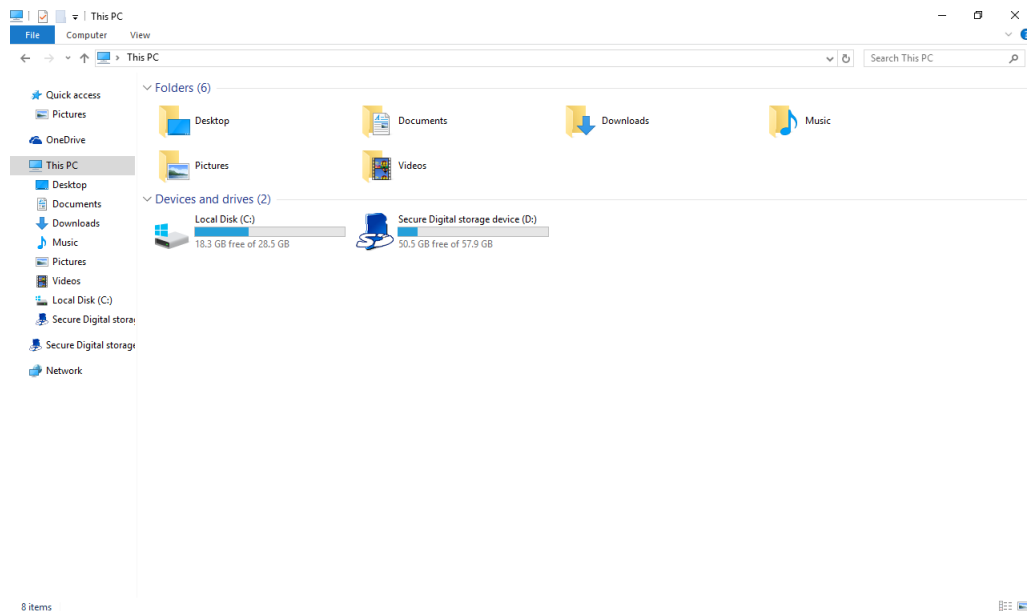

- c) Tap Secure Digital storage device (D:) to find .exe executable file.
- d) Tap .exe file to install the application.

# Chapter 5 Maintenance

## 5.1 Maintaining the LCD Display

- Do not scratch the surface of the screen with any hard objects.
- Do not spray liquid directly on the screen or allow excess liquid to drip down inside the device.
- Do not place anything, such as food and drink, on the screen at any time to prevent damage to the screen.
- Clean the LCD display only with a soft cloth dampened with denatured alcohol or a proprietary LCD screen cleaner.

## 5.2 Cleaning the AIM-68

1. Turn off the device and unplug the power cord.
2. Wipe the screen and exterior with a soft, damp cloth moistened only with water. Do not use liquid or aerosol cleaners on the screen, as these will discolor the finish and damage the screen.

## 5.3 Trouble Shooting

When System behaves abnormally, such as

1. Failure to power on.
2. Failure to power off.
3. Power LED does not light up when DC power plug in.
4. System does not respond to touch behaviors.

Contact your distributor, sales representative, or Advantech's customer service center for technical support if you need additional assistance. Please have the following information ready before you call:

- Product name and serial number.
- Descriptions of your peripheral attachments.
- Descriptions of your software (operating system, version, application software,

etc.)

- A complete description of the problem.
- The exact wording of any error messages.
- Symptoms, photo or video if available.

## 5.4 ENERGY STAR

An ENERGY STAR qualified computer delivers substantial savings over a conventional computer. Desktop, integrated desktop, and notebook (laptop) computers, workstations, small-scale servers, and thin clients are all eligible to earn the ENERGY STAR, and those that do are now more efficient than ever.

It is an honor for Advantech to provide you such products.

### What is ENERGY STAR?

ENERGY STAR is a U.S. Environmental Protection Agency (EPA) voluntary program that helps businesses and individuals save money and protect our climate through superior energy efficiency.

The ENERGY STAR program was established by EPA in 1992, under the authority of the Clean Air Act Section 103(g). Section 103(g) of the Clean Air Act directs the Administrator to "conduct a basic engineering research and technology program to develop, evaluate, and demonstrate non-regulatory strategies and technologies for reducing air pollution."

In 2005, Congress enacted the Energy Policy Act. Section 131 of the Act amends Section 324 (42 USC 6294) of the Energy Policy and Conservation Act, and "established at the Department of Energy and the Environmental Protection Agency a voluntary program to identify and promote energy-efficient products and buildings in order to reduce energy consumption, improve energy security, and reduce pollution through voluntary labeling of or other forms of communication about products and buildings that meet the highest energy efficiency standards."

For more information, please visit [www.energystar.gov](http://www.energystar.gov)

AIM-68 is to enter display sleep mode after 4 minutes and computer sleep mode after 10 minutes in default. To wake it from sleep mode, simply press the power button on the back cover, while under sleep mode it allows the device to save 80% or more energy.

Power Management System:

Lists of default power management systems

<i>Balanced (Default)</i>	<i>AIM-68: Idle 4 mins. closes screen, 10 min. enters sleep mode.</i>
<i>High performance</i>	<i>Never idle and never enters sleep mode.</i>