

**FF-680W**

# **User's Guide**

# Copyright

No part of this publication may be reproduced, stored in a retrieval system, or transmitted in any form or by any means, electronic, mechanical, photocopying, recording, or otherwise, without the prior written permission of Seiko Epson Corporation. No patent liability is assumed with respect to the use of the information contained herein. Neither is any liability assumed for damages resulting from the use of the information herein. The information contained herein is designed only for use with this Epson product. Epson is not responsible for any use of this information as applied to other products.

Neither Seiko Epson Corporation nor its affiliates shall be liable to the purchaser of this product or third parties for damages, losses, costs, or expenses incurred by the purchaser or third parties as a result of accident, misuse, or abuse of this product or unauthorized modifications, repairs, or alterations to this product, or (excluding the U.S.) failure to strictly comply with Seiko Epson Corporation's operating and maintenance instructions.

Seiko Epson Corporation and its affiliates shall not be liable for any damages or problems arising from the use of any options or any consumable products other than those designated as Original Epson Products or Epson Approved Products by Seiko Epson Corporation.

Seiko Epson Corporation shall not be held liable for any damage resulting from electromagnetic interference that occurs from the use of any interface cables other than those designated as Epson Approved Products by Seiko Epson Corporation.

© 2018 Seiko Epson Corporation

The contents of this manual and the specifications of this product are subject to change without notice.

## Trademarks

# Trademarks

- ❑ EPSON® is a registered trademark, and EPSON EXCEED YOUR VISION or EXCEED YOUR VISION is a trademark of the Seiko Epson Corporation.
- ❑ Microsoft and Windows are either registered trademarks or trademarks of Microsoft Corporation in the United States and/or other countries.
- ❑ Apple, macOS, and OS X are trademarks of Apple Inc., registered in the U.S. and other countries.
- ❑ Adobe, Adobe Reader, and Acrobat are registered trademarks of Adobe Systems Incorporated.
- ❑ Intel® is a registered trademark of Intel Corporation.
- ❑ Wi-Fi, Wi-Fi Alliance, and Wi-Fi Protected Access (WPA) are registered trademarks of the Wi-Fi Alliance. Wi-Fi Protected Setup, and WPA2 are trademarks of the Wi-Fi Alliance.
- ❑ The SuperSpeed USB Trident Logo is a registered trademark of USB Implementers Forum, Inc.
- ❑ General Notice: Other product names used herein are for identification purposes only and may be trademarks of their respective owners. Epson disclaims any and all rights in those marks.

## Contents

### Copyright

### Trademarks

### About This Manual

|   |   |
|---|---|
| Introduction to the Manuals. . . . .      | 6 |
| Marks and Symbols. . . . .                | 6 |
| Descriptions Used in this Manual. . . . . | 6 |
| Operating System References. . . . .      | 7 |

### Important Instructions

|                                  |   |
|----------------------------------|---|
| Safety Instructions. . . . .     | 8 |
| Restrictions on Copying. . . . . | 9 |

### Scanner Basics

|   |    |
|---|----|
| Part Names and Functions. . . . .                 | 10 |
| Buttons and Lights on the Control Panel. . . . .  | 12 |
| Buttons. . . . .                                  | 12 |
| Lights. . . . .                                   | 13 |
| Error Indicators. . . . .                         | 14 |
| Information on Applications. . . . .              | 15 |
| Epson FastFoto. . . . .                           | 15 |
| Epson ScanSmart. . . . .                          | 15 |
| EPSON Software Updater. . . . .                   | 15 |
| Epson DocumentScan. . . . .                       | 16 |
| EpsonNet Config. . . . .                          | 16 |
| Option Items and Consumables Information. . . . . | 16 |
| Carrier Sheet Codes. . . . .                      | 16 |
| Roller Assembly Kit Codes. . . . .                | 16 |
| Cleaning Kit Codes. . . . .                       | 17 |

### Scanning Photos

|   |    |
|---|----|
| Photo Specifications. . . . .                     | 18 |
| Types of Photos that Require Attention. . . . .   | 19 |
| Types of Photos that must not be Scanned. . . . . | 19 |
| How to Scan Photos. . . . .                       | 20 |
| Step 1: Organizing Photos. . . . .                | 20 |
| Step 2: Placing Photos into the Scanner. . . . .  | 20 |
| Step 3: Scanning and Saving Photos. . . . .       | 24 |
| Tips for Using Epson FastFoto. . . . .            | 33 |
| Scanning Instant Photos. . . . .                  | 33 |
| Scanning Panoramic Photos. . . . .                | 36 |
| Scanning Back Side Notes on Photos. . . . .       | 39 |

|  |    |
|--|----|
| Loading Photos Using a Carrier Sheet. . . . .                  | 42 |
| Enabling or Disabling Glass Surface Dirt Alert. . . . .        | 44 |
| Changing the Application to Scan from the Scan Button. . . . . | 47 |
| Epson FastFoto Settings. . . . .                               | 49 |
| Organization Tab. . . . .                                      | 51 |
| Enhancements Tab. . . . .                                      | 52 |
| Scan Settings Tab. . . . .                                     | 53 |
| Advanced Settings Tab. . . . .                                 | 54 |
| Upload Tab. . . . .  | 54 |
| Scanner Settings Tab. . . . .                                  | 55 |

### Scanning Documents or Other Originals

|  |    |
|--|----|
| Placing Documents or Other Originals. . . . .  | 57 |
| General Specifications for Originals being Scanned. . . . .  | 57 |
| Standard Size Originals. . . . .   | 59 |
| Long Paper. . . . .  | 64 |
| Plastic Cards. . . . .   | 66 |
| Laminated Cards. . . . .   | 70 |
| Large Size Originals. . . . .  | 72 |
| Irregular Shaped Originals. . . . .  | 75 |
| Envelopes. . . . .   | 78 |
| Mixture of Originals. . . . .  | 81 |
| Scanning Documents from Computer (Epson ScanSmart). . . . .  | 83 |
| Scanning Different Sizes or Types of Originals One by One Continuously (Automatic Feeding Mode). . . . . | 87 |
| Scanning Documents from Smart Device (Epson DocumentScan). . . . .                                       | 90 |

### Network Settings

|   |    |
|---|----|
| Network Connection Types. . . . .                         | 95 |
| Wi-Fi Connection. . . . .                                 | 95 |
| Wi-Fi Direct (Simple AP) Connection. . . . .              | 95 |
| Connecting to a Computer. . . . .                         | 96 |
| Connecting to a Smart Device. . . . .                     | 97 |
| Making Wi-Fi Settings from the Control Panel. . . . .     | 97 |
| Making Wi-Fi Settings by Push Button Setup (WPS). . . . . | 97 |
| Making Wi-Fi Settings by PIN Code Setup (WPS). . . . .    | 98 |
| Making AP Mode Settings. . . . .                          | 98 |

## Contents

|  |     |
|--|-----|
| Checking the Network Status Using Network Light. . . . .       | 99  |
| Replacing or Adding New Wireless Routers. . . . .              | 99  |
| Changing the Connection Method to a Computer. . . . .          | 99  |
| Disabling the Network Setting from the Control Panel. . . . .  | 100 |
| Restoring the Network Settings from the Control Panel. . . . . | 100 |

### **Maintenance**

|   |     |
|---|-----|
| Cleaning Outside the Scanner. . . . .       | 102 |
| Cleaning Inside the Scanner. . . . .        | 102 |
| Replacing the Roller Assembly Kit. . . . .  | 107 |
| Resetting the Number of Scans. . . . .      | 111 |
| Energy Saving. . . . .                      | 113 |
| Transporting the Scanner. . . . .           | 114 |
| Updating Applications and Firmware. . . . . | 115 |

### **Solving Problems**

|  |     |
|--|-----|
| Scanner Problems. . . . .  | 117 |
| Scanner Lights Indicate an Error. . . . .                          | 117 |
| The Scanner Does Not Turn On. . . . .                              | 117 |
| Paper Feeding Problems. . . . .                                    | 117 |
| Photos Are Not Fed Correctly. . . . .                              | 117 |
| Multiple Originals Are Fed. . . . .                                | 118 |
| Removing Jammed Originals from the Scanner. . . . .                | 118 |
| The Original Jams in the Scanner Frequently. . . . .               | 119 |
| The Originals Get Dirty. . . . .                                   | 120 |
| Scanning Speed Slows Down when Scanning Continuously. . . . .      | 120 |
| Scanning Takes a Long Time. . . . .                                | 120 |
| Scanning Problems when Using Epson FastFoto. . . . .               | 121 |
| Straight Lines Appear. . . . .                                     | 121 |
| The Image Quality Is Poor. . . . .                                 | 121 |
| Pressing the Scanner Button Does Not Start Epson FastFoto. . . . . | 122 |
| Cannot Share or Upload the Photos to a Web Service. . . . .        | 122 |
| Glass Dirt Alert Does Not Disappear. . . . .                       | 123 |
| Scanning Problems when Using Epson ScanSmart . . . . .             | 123 |
| Cannot Start Epson ScanSmart. . . . .                              | 123 |
| Straight Lines Appear when Scanning from ADF. . . . .              | 124 |
| Offset Appears in the Background of Images. . . . .                | 124 |
| Scanned Image or Text is Blurred. . . . .                          | 124 |
| Moiré Patterns (Web-Like Shadows) Appear. . . . .                  | 125 |

|  |     |
|--|-----|
| The Edge of the Original is Not Scanned when Automatically Detecting the Size of the Original. . . . . | 126 |
| Character is not Recognized Correctly. . . . .   | 126 |
| Expanding or Contracting the Scanned Image. . . . .  | 127 |
| Cannot Solve Problems in the Scanned Image. . . . .  | 127 |
| Network Problems. . . . .  | 128 |
| When You Cannot Make Network Settings. . . . .   | 128 |
| The Scanner Suddenly Cannot Scan over a Network Connection. . . . .                                    | 131 |
| The Scanner Suddenly Cannot Scan Using a USB Connection. . . . .                                       | 131 |
| Uninstalling and Installing Applications. . . . .  | 132 |
| Uninstalling Your Applications. . . . .  | 132 |
| Installing Your Applications. . . . .  | 133 |

### **Technical Specifications**

|   |     |
|---|-----|
| General Scanner Specifications. . . . .       | 134 |
| Wi-Fi Specifications. . . . .                 | 135 |
| Security Protocol. . . . .                    | 135 |
| Dimensional Specifications. . . . .           | 136 |
| Electrical Specifications. . . . .            | 136 |
| Scanner Electrical Specifications. . . . .    | 136 |
| AC Adapter Electrical Specifications. . . . . | 136 |
| Environmental Specifications. . . . .         | 137 |
| System Requirements. . . . .                  | 137 |

### **Standards and Approvals**

|  |     |
|--|-----|
| Standards and Approvals for European Models. . . . .   | 138 |
| Standards and Approvals for Australian Models. . . . . | 138 |

### **Where to Get Help**

|                                      |     |
|--------------------------------------|-----|
| Technical Support Web Site. . . . .  | 139 |
| Contacting Epson Support. . . . .    | 139 |
| Before Contacting Epson. . . . .     | 139 |
| Help for Users in Europe. . . . .    | 139 |
| Help for Users in Australia. . . . . | 140 |

# About This Manual

---

## Introduction to the Manuals

The latest versions of the following manuals are available from the Epson support website.

<http://www.epson.eu/Support> (Europe)

<http://support.epson.net/> (outside Europe)

Setup Guide (paper manual)

Provides you with information on setting up the product and installing the application.

User's Guide (digital manual)

Provides instructions on using the product, maintenance, and solving problems.

As well as the manuals above, see the help included in the various Epson applications.

---

## Marks and Symbols



**Caution:**

*Instructions that must be followed carefully to avoid bodily injury.*



**Important:**

*Instructions that must be observed to avoid damage to your equipment.*

**Note:**

*Provides complementary and reference information.*

### Related Information

➔ Links to related sections.

---

## Descriptions Used in this Manual

- Screenshots for the applications are from Windows 10 or macOS High Sierra. The content displayed on the screens varies depending on the model and situation.
- Illustrations used in this manual are for reference only. Although they may differ slightly from the actual product, the operating methods are the same.

---

## Operating System References

### Windows

In this manual, terms such as "Windows 10", "Windows 8.1", "Windows 8", and "Windows 7" refer to the following operating systems. Additionally, "Windows" is used to refer to all versions.

- Microsoft® Windows® 10 operating system
- Microsoft® Windows® 8.1 operating system
- Microsoft® Windows® 8 operating system
- Microsoft® Windows® 7 operating system

### Mac OS

In this manual, "Mac OS" is used to refer to macOS High Sierra, macOS Sierra, and OS X El Capitan.

# Important Instructions

---

## Safety Instructions

Read and follow these instructions to ensure safe use of this product and options. Make sure you keep this manual for future reference. Also, be sure to follow all warnings and instructions marked on the product and options.

- ❑ Some of the symbols used on your product and options are to ensure safety and proper use of the product. Visit the following Web site to learn the meaning of the symbols.  
<http://support.epson.net/symbols>
- ❑ Place the product and options on a flat, stable surface that extends beyond the base of the product and options in all directions. If you place the product and options by the wall, leave more than 10 cm between the back of the product and options and the wall.
- ❑ Place the product and options close enough to the computer for the interface cable to reach it easily. Do not place or store the product and options or the AC adapter outdoors, near excessive dirt or dust, water, heat sources, or in locations subject to shocks, vibrations, high temperature or humidity, direct sunlight, strong light sources, or rapid changes in temperature or humidity.
- ❑ Do not use with wet hands.
- ❑ Place the product and options near an electrical outlet where the adapter can be easily unplugged.
- ❑ The AC adapter cord should be placed to avoid abrasions, cuts, fraying, crimping, and kinking. Do not place objects on top of the cord and do not allow the AC adapter or the cord to be stepped on or run over. Be particularly careful to keep the cord straight at the end.
- ❑ Use only the power cord supplied with the product and do not use the cord with any other equipment. Use of other cords with this product or the use of the supplied power cord with other equipment may result in fire or electric shock.
- ❑ Use only the AC adapter that comes with your product. Using any other adapter could cause fire, electrical shock, or injury.
- ❑ The AC adapter is designed for use with the product with which it was included. Do not attempt to use it with other electronic devices unless specified.
- ❑ Use only the type of power source indicated on the AC adapter's label, and always supply power directly from a standard domestic electrical outlet with the AC adapter that meets the relevant local safety standards.
- ❑ When connecting this product and options to a computer or other device with a cable, ensure the correct orientation of the connectors. Each connector has only one correct orientation. Inserting a connector in the wrong orientation may damage both devices connected by the cable.
- ❑ Avoid using outlets on the same circuit as photocopiers or air control systems that regularly switch on and off.
- ❑ If you use an extension cord with the product, make sure the total ampere rating of the devices plugged into the extension cord does not exceed the cord's ampere rating. Also, make sure the total ampere rating of all devices plugged into the wall outlet does not exceed the wall outlet's ampere rating.
- ❑ Never disassemble, modify, or attempt to repair the AC adapter, product, or product options by yourself except as specifically explained in the product's guides.
- ❑ Do not insert objects into any opening as they may touch dangerous voltage points or short out parts. Beware of electrical shock hazards.
- ❑ If damage occurs to the plug, replace the cord set or consult a qualified electrician. If there are fuses in the plug, make sure you replace them with fuses of the correct size and rating.



## Important Instructions

- ❑ Unplug the product, options, and the AC adapter, and refer servicing to qualified service personnel under the following conditions: The AC adapter or plug is damaged; liquid has entered the product, options, or the AC adapter; the product or the AC adapter has been dropped or the case has been damaged; the product, options, or the AC adapter does not operate normally or exhibits a distinct change in performance. (Do not adjust controls that are not covered by the operating instructions.)
- ❑ Unplug the product and the AC adapter before cleaning. Clean with a damp cloth only. Do not use liquid or aerosol cleaners except as specifically explained in the product's guides.
- ❑ If you are not going to use the product for a long period, be sure to unplug the AC adapter from the electrical outlet.
- ❑ After replacing consumable parts, dispose of them correctly following the rules of your local authority. Do not disassemble them.
- ❑ Keep this product at least 22 cm away from cardiac pacemakers. Radio waves from this product may adversely affect the operation of cardiac pacemakers.
- ❑ Do not use this product inside medical facilities or near medical equipment. Radio waves from this product may adversely affect the operation of electrical medical equipment.
- ❑ Do not use this product near automatically controlled devices such as automatic doors or fire alarms. Radio waves from this product may adversely affect these devices, and could lead to accidents due to malfunction.

---

## Restrictions on Copying

Observe the following restrictions to ensure the responsible and legal use of your product.

Copying of the following items is prohibited by law:

- ❑ Bank bills, coins, government-issued marketable securities, government bond securities, and municipal securities
- ❑ Unused postage stamps, pre-stamped postcards, and other official postal items bearing valid postage
- ❑ Government-issued revenue stamps, and securities issued according to legal procedure

Exercise caution when copying the following items:

- ❑ Private marketable securities (stock certificates, negotiable notes, checks, etc.), monthly passes, concession tickets, etc.
- ❑ Passports, driver's licenses, warrants of fitness, road passes, food stamps, tickets, etc.

**Note:**

*Copying these items may also be prohibited by law.*

Responsible use of copyrighted materials:

Products can be misused by improperly copying copyrighted materials. Unless acting on the advice of a knowledgeable attorney, be responsible and respectful by obtaining the permission of the copyright holder before copying published material.

# Scanner Basics

## Part Names and Functions

Front

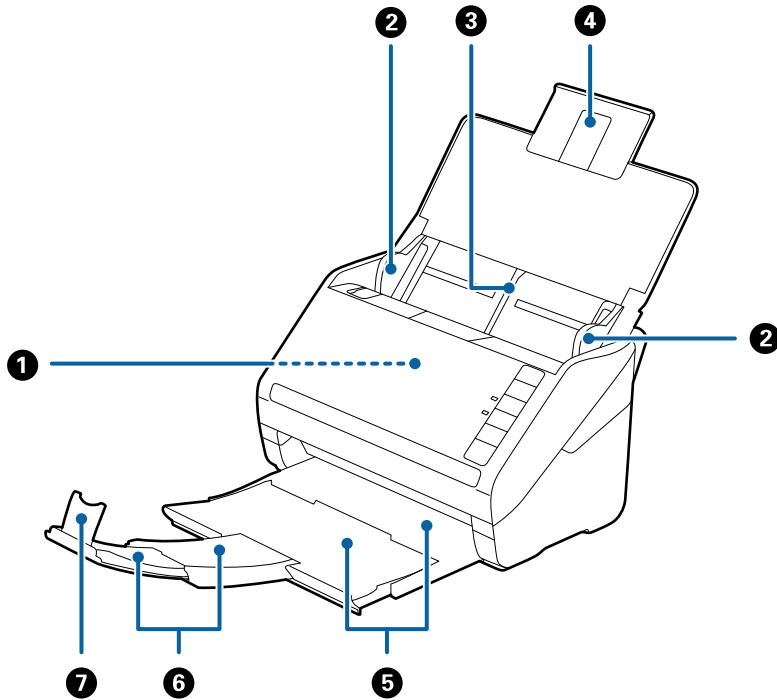

|   |                                 |  |
|---|---------------------------------|--|
| ① | ADF (Automatic Document Feeder) | Feeds loaded originals automatically.  |
| ② | Edge guides                     | Feeds originals straight into the scanner. Slide to the edges of the originals.  |
| ③ | Input tray                      | Loads originals. Pull out the tray extension if originals are too big for the input tray. This prevents paper from curling and causing paper jams. |
| ④ | Input tray extension            |  |
| ⑤ | Output tray                     | Holds originals ejected from the scanner. Pull out the extension tray to the length of the originals.  |
| ⑥ | Output tray extension           |  |
| ⑦ | Stopper                         | Prevents ejected originals from falling off the extension tray. Adjust it to the length of the originals.  |

## Scanner Basics

### Back

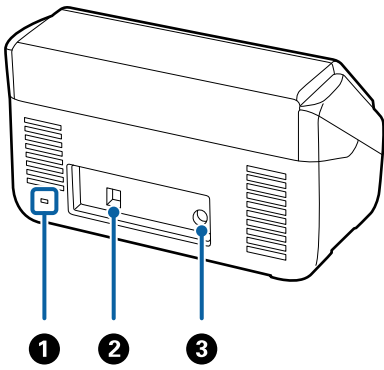

|   |               |   |
|---|---------------|---|
| ① | Security slot | Inserts a security lock for theft prevention. |
| ② | USB port      | Connects a USB cable.                         |
| ③ | DC inlet      | Connects the AC adapter.                      |

### Inside

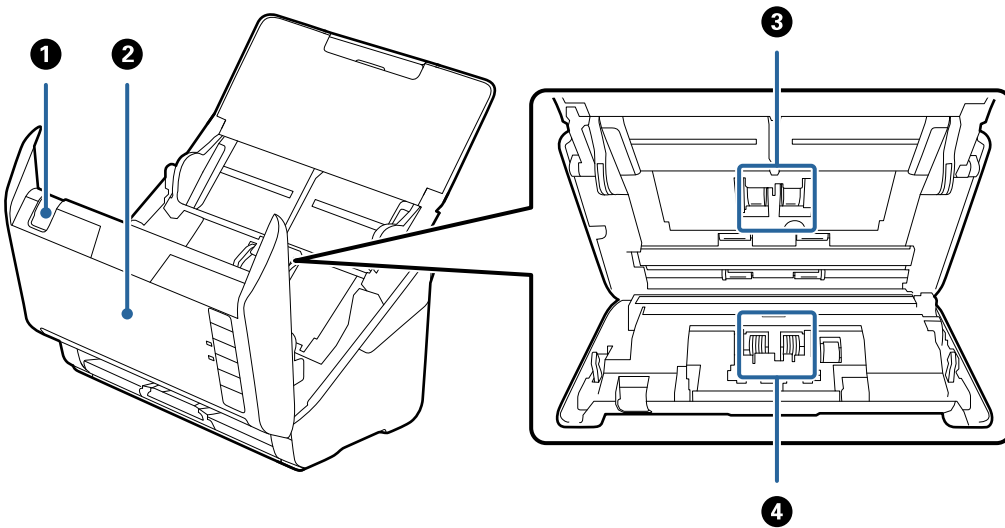

|   |                   |   |
|---|-------------------|---|
| ① | Cover open lever  | Pull the cover open lever and open the scanner cover.   |
| ② | Scanner cover     | Pull the cover open lever and open the scanner cover when cleaning inside of the scanner and removing jammed paper.             |
| ③ | Pickup roller     | Feeds originals. This needs to be replaced when the number of scans exceeds the service number of papers.                       |
| ④ | Separation roller | Feeds originals separately one by one. This needs to be replaced when the number of scans exceeds the service number of papers. |

### Related Information

- ➔ [“Cleaning Inside the Scanner” on page 102](#)
- ➔ [“Replacing the Roller Assembly Kit” on page 107](#)

# Buttons and Lights on the Control Panel

## Buttons

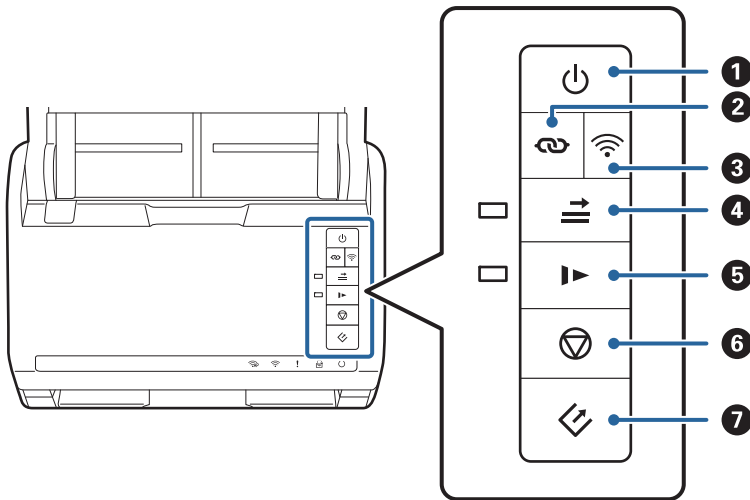

|   |  |                                   |  |
|---|--|-----------------------------------|--|
| 1 |  | Power button                      | Turns the scanner on or off.   |
| 2 |  | Wi-Fi connect button              | Press the WPS button on the access point, and then press the  button for more than three seconds to connect to a Wi-Fi network. See the chapter "Network Settings" for more details. Press the  button to cancel the settings.   |
| 3 |  | Wi-Fi on/off button               | Press this button for more than three seconds to turn off the wireless signal. Press again to turn on the signal.  |
| 4 |  | Double feed detection skip button | Normally, an error occurs when detecting double feeds when loading envelopes, plastic cards, originals with labels or stickers, and so on. Press the  button before scanning to skip this error once (one sheet). The light is on when this is enabled. Follow the steps below to restart scanning when a double feed error has occurred (the error light flashes).<br><ol style="list-style-type: none"> <li>1. Open the scanner cover, and then remove the originals.</li> <li>2. Close the scanner cover, and then press the  button.</li> <li>3. Load the originals.</li> <li>4. Restart scanning by pressing the start button or the application button.</li> </ol> |
| 5 |  | Slow mode button                  | Slow down the feeding speed when scanning. The light is on when this is enabled.<br>Press this button in the following situations:<br><input type="checkbox"/> when originals jam frequently<br><input type="checkbox"/> when loading thin originals   |

### Scanner Basics

|   |  |              |   |
|---|--|--------------|---|
| 6 |  | Stop button  | <ul style="list-style-type: none"> <li><input type="checkbox"/> Cancels scanning.</li> <li><input type="checkbox"/> Finishes Automatic Feeding Mode.</li> <li><input type="checkbox"/> Cancels Wi-Fi settings by push button setup (WPS).</li> <li><input type="checkbox"/> Press this to release the error when a network connection error occurs.</li> <li><input type="checkbox"/> Cancels a firmware update over a network connection.</li> </ul> |
| 7 |  | Start button | <ul style="list-style-type: none"> <li><input type="checkbox"/> Starts scanning. Epson FastFoto is installed as the default scanning application.</li> <li><input type="checkbox"/> Press this when cleaning the inside of the scanner.</li> </ul>  |

Additional functions are available with different combinations of buttons.

|  |   |
|--|---|
|  | Hold down the  and  buttons for more than three seconds to start PIN Code Setup (WPS). See the chapter "Network Settings" for more details. |
|  | Turn on the scanner while holding down the  button to restore the default network settings.   |

#### Related Information



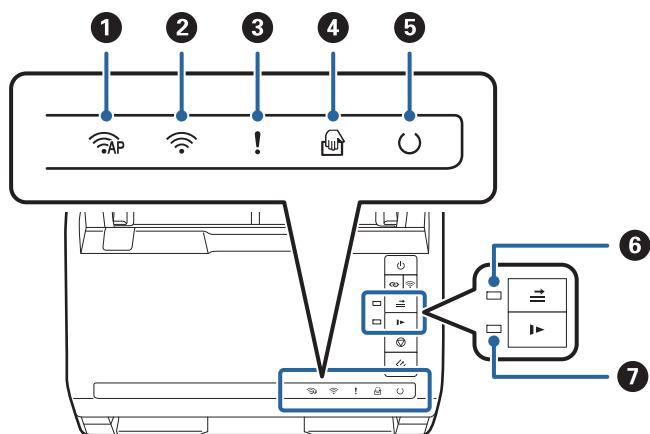

- ➔ ["Network Settings" on page 95](#)
- ➔ ["Placing Plastic Cards" on page 67](#)
- ➔ ["Placing Laminated Cards" on page 70](#)
- ➔ ["Placing Envelopes" on page 79](#)
- ➔ ["Cleaning Inside the Scanner" on page 102](#)

### Lights



|   |  |               |  |
|---|--|---------------|--|
| 1 |  | AP mode light | Indicates that the scanner is connected wirelessly in AP mode.   |
| 2 |  | Wi-Fi light   | Blue indicates that the scanner is connected to a wireless (Wi-Fi) network. White indicates it is searching for an access point. |
| 3 |  | Error light   | An error has occurred. See "Light Error Indicators" for more details.  |

## Scanner Basics













|   |   |                                  |   |   |
|---|---|----------------------------------|---|---|
| 4 |  | Automatic Feeding Mode light     | The scanner is in Automatic Feeding Mode. Scanning starts when an original is placed in the input tray. |   |
| 5 |  | Ready light                      | On:   | The scanner is ready to be used.  |
|   |   |                                  | Flashing:   | The scanner is scanning, waiting to scan, processing, or sleeping.            |
|   |   |                                  | Off:  | The scanner cannot be used because the power is off or an error has occurred. |
| 6 |  | Skip double feed detection light | This is on when skipping double feed detection is enabled.  |   |
| 7 |  | Slow mode light                  | This is on during slow mode.  |   |

### Related Information

- ➔ [“Error Indicators” on page 14](#)
- ➔ [“Placing a Mixture of Originals at Different Sizes” on page 82](#)







## Error Indicators

### Scanner errors

| Indicators  | Situation  | Solutions  |
|---|--|--|
|  Flashing slowly   | A paper jam or double feed occurred.   | Open the scanner cover, and then remove jammed originals. Close the cover to release the error. Load the originals again.  |
|  On  | The scanner cover is opened.   | Close the scanner cover.   |
|  Flashing fast<br> Flashing fast<br> Flashing fast<br> Flashing fast  | A fatal error has occurred.  | Turn the power off and on again. If the error continues to occur, contact your local dealer.   |
|  On<br> On<br> On<br> On<br> Off<br> On<br> On | The scanner has started in recovery mode because the firmware update failed. | Follow the steps below to try to update the firmware again. <ol style="list-style-type: none"> <li>1. Connect the computer and the scanner with a USB cable. (During recovery mode, you cannot update the firmware over a network connection.)</li> <li>2. Visit your local Epson website for further instructions.</li> </ol> |

## Scanner Basics

### Network connection errors

| Indicators   | Situation  | Solutions  |
|--|--|--|
|  Flashing slowly<br> On                      | An access point settings error has occurred.   | Press the  button to release the error, and then restart the devices you want to connect to the network. Re-connect to the network. |
|  Flashing slowly<br> Flashing slowly         | An access point settings error has occurred (a security error).                        |  |
|  Flashing slowly (white)<br> Flashing slowly | A network connection error has occurred (the Date and Time has not been set correctly) | Re-set the Date and Time in Web Config.  |

### Related Information

- ➔ [“Removing Jammed Originals from the Scanner” on page 118](#)
- ➔ [“Making Wi-Fi Settings from the Control Panel” on page 97](#)
- ➔ [“Network Problems” on page 128](#)

---

## Information on Applications

This section introduces the application products available for your scanner. The latest application can be installed at the Epson Web site.

### Epson FastFoto

Epson FastFoto is a high-speed photo scanning application. Using Epson FastFoto, you can easily scan your photos as digital images, and then share or upload them via the internet. You can also restore and enhance faded photos.

### Epson ScanSmart

Epson ScanSmart is a document scanning application that allows you to easily scan and save the data in simple steps.

- You can scan and send information to a cloud service in three easy steps.
- You can automatically name the documents by using the scanned information.

These features allow you to save time when organizing documents.

### EPSON Software Updater

EPSON Software Updater is an application that checks for new or updated applications on the internet and installs them.

You can also update the scanner's digital manual.

## Epson DocumentScan

Epson DocumentScan is an application that allows you to scan documents through smart devices such as smartphones and tablet devices. You can save the scanned data in smart devices or cloud services, and send by e-mail. You can download and install this app from the App Store or Google Play.

## EpsonNet Config

EpsonNet Config is an application that allows you to set network interface addresses and protocols. See the operations guide for EpsonNet Config or the application's help for more details.

**Note:**

You can run Web Config from EpsonNet Config.

---

## Option Items and Consumables Information

### Carrier Sheet Codes

Using a Carrier Sheet allows you to scan irregular shaped originals or photos that can be easily scratched. You can scan originals larger than A4 size with a carrier sheet by folding it in half.

| Part name     | Codes*     |
|---------------|------------|
| Carrier Sheet | B12B819051 |

\* You can only use the carrier sheet with the code.

### Related Information

- ➔ [“Loading Photos Using a Carrier Sheet” on page 42](#)  
You can scan damaged or valuable photos by using the Carrier Sheet.
- ➔ [“Placing Large Size Originals” on page 73](#)
- ➔ [“Placing Irregular Shaped Originals” on page 76](#)

### Roller Assembly Kit Codes

Parts (the pickup roller and a separation roller) should be replaced when the number of scans exceeds the service number. You can check the latest number of scans in Epson Scan 2 Utility.

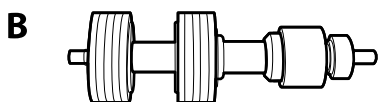
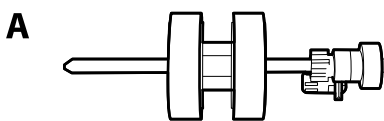



## Scanner Basics

A: pickup roller, B: separation roller

| Part name           | Codes      | Life cycle |
|---------------------|------------|------------|
| Roller Assembly Kit | B12B819031 | 200,000*   |

\* This number was reached by consecutively scanning using Epson test original papers, and is a guide to the replacement cycle. The replacement cycle may vary depending on different paper types, such as paper that generates a lot of paper dust or paper with a rough surface that may shorten the life cycle.

### Related Information

- ➔ [“Replacing the Roller Assembly Kit” on page 107](#)
- ➔ [“Resetting the Number of Scans” on page 111](#)

## Cleaning Kit Codes

Use this when cleaning inside the scanner. This kit is composed of cleaning liquid and a cleaning cloth.

| Part name    | Codes      |
|--------------|------------|
| Cleaning Kit | B12B819291 |

### Related Information

- ➔ [“Cleaning Inside the Scanner” on page 102](#)

# Scanning Photos

Using the Epson FastFoto application, you can easily scan your photos as digital images, and then share or upload them using the Internet. You can also restore and enhance faded photos.

**Note:**

- ❑ You can only scan photos using Epson FastFoto, you cannot scan documents or other originals. If you want to scan these originals, use the computer application Epson ScanSmart or the smart device application Epson DocumentScan.
- ❑ Epson FastFoto is assigned to the scanner button as the default application.

## Related Information

- ➔ [“Changing the Application to Scan from the Scan Button” on page 47](#)  
You can change the default application that starts when you press the scan button.

---

## Photo Specifications

You can load the following type of photos into the scanner.

| Size                | Measurements  | Paper Type   | Loading Capacity  |
|---------------------|---|--|---|
| 3.5×5"              | 89×127 mm<br>(3.5×5.0 in.)  | Plain photographic paper                                 | 36 photos (thickness up to 0.23 mm (0.009 in.) without curling)<br><br>30 photos (thickness more than 0.24 to 0.30 mm (0.009 to 0.012 in.) without curling) |
| 4×6"                | 102×152 mm<br>(4.0×6.0 in.)   |  |   |
| 5×7"                | 127×178 mm<br>(5.0×7.0 in.)   |  |   |
| 8×10"               | 203×254 mm<br>(8.0×10.0 in.)  | Plain photographic paper                                 | 10 sheets   |
| Instant camera size | 89×102 mm<br>(3.5×4.0 in.)  | Instant camera photographic paper (sheet film type only) | 1 sheet   |
| Panoramic size      | 89×254 mm<br>(3.5×10.0 in.)   | Plain photographic paper                                 | 10 sheets   |
|                     | 102×304.8 mm<br>(4.0×12.0 in.)  |  |   |
|                     | Other size: Length up to 304.8 mm (12.0 in.)  |  |   |
|                     | Other size: Length 304.8 mm (12.0 in.) to 914.4 mm (36.0 in.)<br>*<br>(Max size: 215.9×914.4 mm (8.5×36.0 in.)) | Plain photographic paper                                 | 1 sheet   |

## Scanning Photos

| Size                       | Measurements   | Paper Type   | Loading Capacity |
|----------------------------|--|--|------------------|
| Photo in the Carrier Sheet | 0.3 mm (0.012 in.) or less<br>(excluding the thickness of the Carrier Sheet) | Photos that cannot be loaded directly into the scanner | 1 sheet          |

### Note:

- Flatten any curled photos to a thickness of less than 2 mm (0.07 in.). It is best to scan curled photos in an environment between 15 to 25°C (59 to 77°F) with 40 to 60% humidity. Scanning photos at lower temperatures may cause photos to curl.
- Photos may stick together depending on their paper types and thickness. It is best to scan photos in an environment between 15 to 25°C (59 to 77°F) with 40 to 60% humidity to prevent photos from sticking together.
- Repeatedly scanning the same photos many times may cause them to stick together. If they stick together, feed them one by one.

## Types of Photos that Require Attention

The following types of photos may not be successfully scanned, or might be damaged when scanning.

- Photos in shapes other than square
- Uneven Photos
- Photos curled more than 2 mm (0.08 inches)
- Photos with crinkles or fold lines
- Photos with edges that are peeling off
- Photos with the inside peeling off
- Photos with sticky surfaces
- Photos with labels or stickers (stuck firmly)
- Photos with hardened paste such as glue
- Instant camera photographic paper other than sheet film

### Note:

- Try to flatten curled photos before scanning.
- Labels or stickers must be firmly stuck to the photos with no glue protruding.

## Types of Photos that must not be Scanned

The following types of photos must not be scanned.

- Torn Photos
- Degraded and deformed photos
- Photos with staples or paper clips
- Photos with labels or stickers (not stuck firmly)
- Photos with glue, liquid, oil, or gel
- Photos that are not fully dried
- Perforated photos

## Scanning Photos

- Photos smaller than 25.4×25.4 mm (2×2 in).

---

# How to Scan Photos

Follow the three steps below to scan your photos.

### Related Information

- ➔ [“Step 1: Organizing Photos” on page 20](#)  
Organize the photos before placing them into the scanner.
- ➔ [“Step 2: Placing Photos into the Scanner” on page 20](#)  
After organizing your photos, place them into the scanner.
- ➔ [“Step 3: Scanning and Saving Photos” on page 24](#)  
Epson FastFoto automatically saves your scanned images on your computer in the folder you specify.

## Step 1: Organizing Photos

Organize the photos before placing them into the scanner.

1. Prepare the photos you want to scan.
2. Use a soft, dry cloth (like the microfiber cloth that came with your scanner) to wipe the front and back of your photos to remove dust, dirt, or other particles that could potentially scratch your photos.



### Caution:

*Because of the speed at which photos are scanned, dust particles on your photos can cause straight lines to appear in scanned images, and in extreme cases can lightly scratch the protective finish on your photos. We recommend to clean the scanner rollers after every 300 scans, or even before each scanning session.*

3. Organize your photos by date or subject.  
When scanning, you can name the images using the year, month or season, and subject, such as "1970\_Summer\_Vacation".
4. Check the following if you are scanning various sizes of photos:
  - If you have both landscape and portrait photos of the same size, you can stack them together and scan them in one batch. You can rotate the images as necessary after scanning by clicking **Edit > Rotate Left** or **Rotate Right**.
  - You can scan 4×6" and 5×7" photos in the same batch when the photos are grouped by size, with the larger photos at the back.

Next, place the organized photos into the scanner.

## Step 2: Placing Photos into the Scanner

After organizing your photos, place them into the scanner.

## Scanning Photos

1. Open the input tray, slide out the output tray, and then raise the stopper.

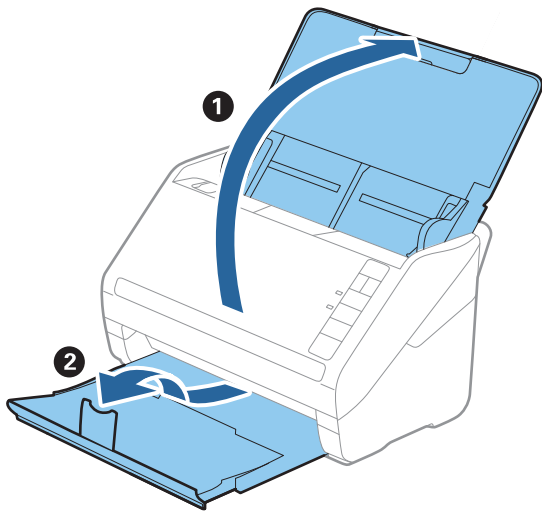

**Note:**

- ❑ If you want to scan large size photos such as 5×7" or 8×10", extend the input and output tray extensions.

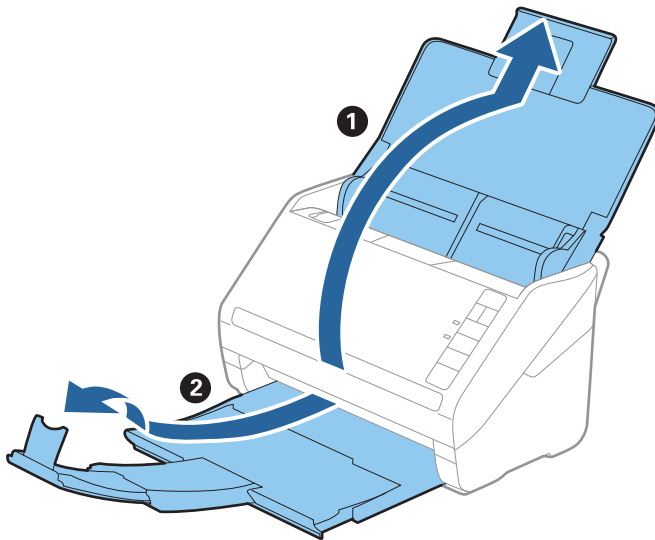

- ❑ Make sure you adjust the position of the stopper to correctly fit the size of the ejected photos. If not, photos may scatter.

2. Slide the edge guides on the input tray all the way out.

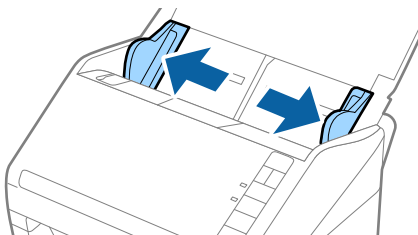

## Scanning Photos

- Fan your stack of photos and make sure they are not stuck together.  
Also, flatten the curls on the edge of the photos if possible.

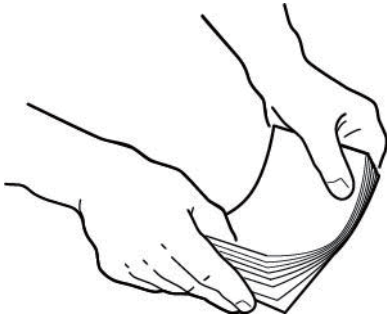

**⚠ Caution:**

*Stuck photos can feed through the scanner at the same time or jam in the scanner, potentially damaging your photos or the scanner.*

**Note:**

*It is best to scan photos in an environment between 15 to 25°C (59 to 77°F) with 40 to 60% humidity. In this condition, curls of the photos are reduced, and photos are prevented from sticking together.*

- Load the photos into the input tray face up and top edge first.  
Slide the photos into the ADF until they meet resistance.

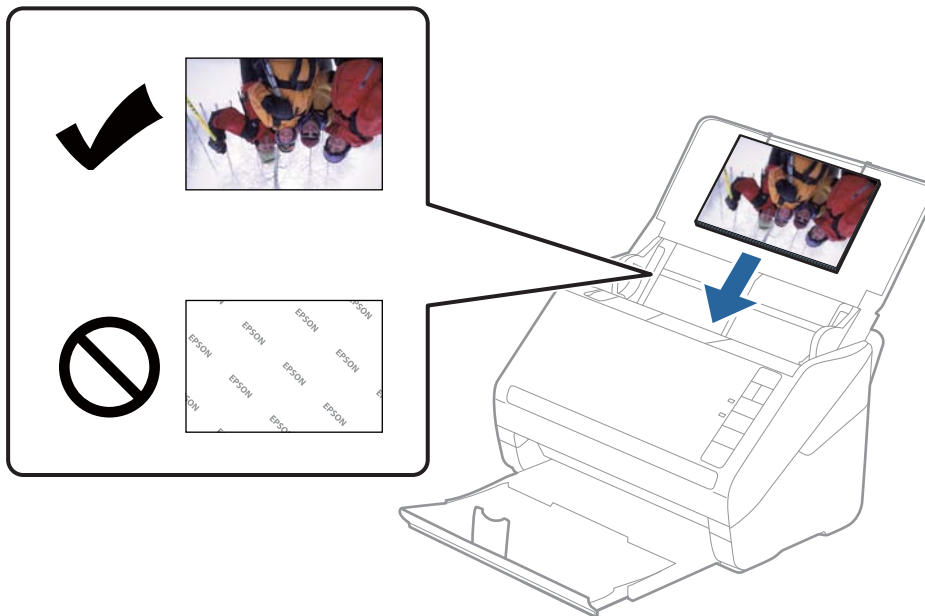

## Scanning Photos

**Note:**

- ❑ We recommend placing the photos horizontally.
- ❑ You can rotate the scanned images automatically when scanning using Epson FastFoto. Click the **Settings** > **Advanced Settings** tab, and then enable **Auto Rotation**. Depending on the photos, they may not be rotated correctly. To rotate the scanned images manually, select the image you want to rotate, and then click **Edit** > **Rotate Left**/**Rotate Right**.
- ❑ If you are loading 4×6" and 5×7" photos in the same batch, align the middle of the photos and load them at the center of the input tray with the 5×7" photos at the back and the 4×6" photos at the front.

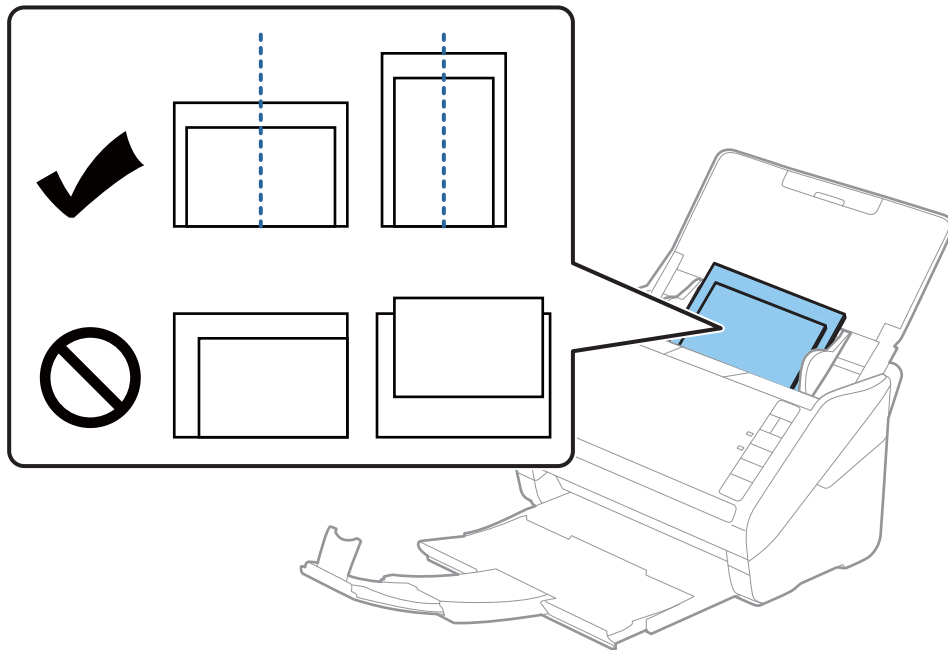

5. Slide the edge guides to fit the edge of the photos making sure there are no gaps between the photos and the edge guides. Otherwise, the photos may be fed skewed.

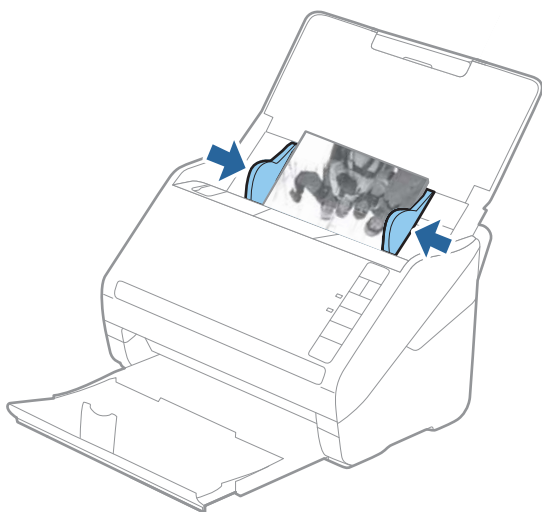

Next, start scanning using Epson FastFoto.

## Scanning Photos

### Step 3: Scanning and Saving Photos

Epson FastFoto automatically saves your scanned images on your computer in the folder you specify.

1. Click the  button on the scanner to start scanning.  
You can also click **Start Scanning** on the main screen.

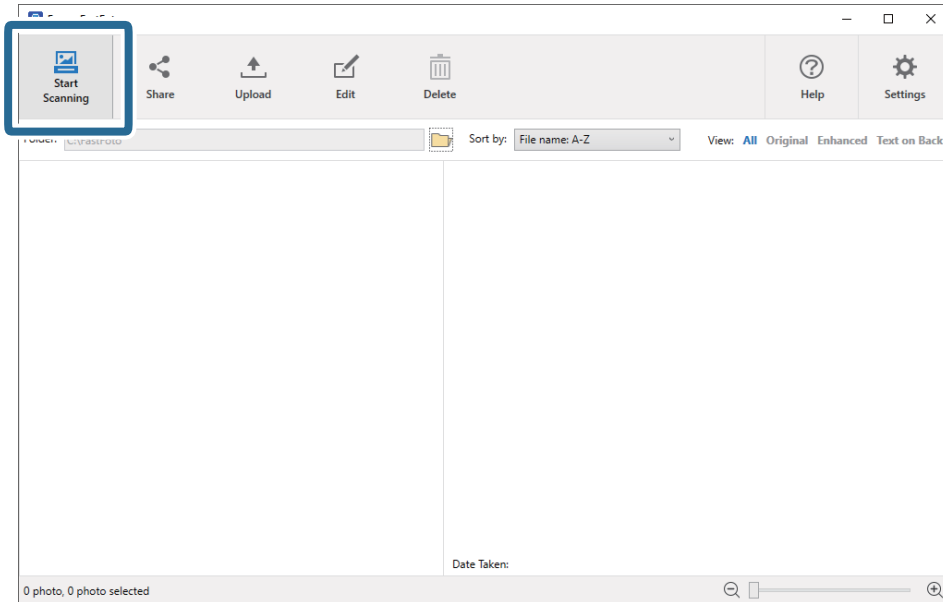

2. Set the save settings on the **Describe Your Photos** screen.

- Year/Month or Season/Subject:** Set the file name settings.
- Create a subfolder for this batch of pictures:** Create a new subfolder for the scanned images.
- Do not prompt me to describe my photos when scanning:** Skip this screen the next time you scan. You will not be prompted to describe your photos.



## Scanning Photos

3. Click **Start Scanning**.

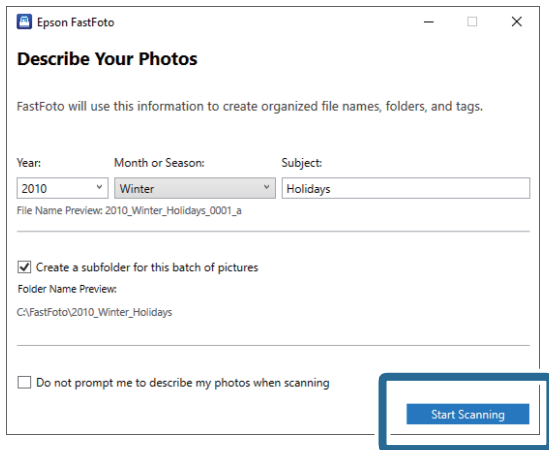

**Note:**

- ❑ If the glass surface dirt alert appeared when scanning, clean the glass surface inside the scanner after scanning.
- ❑ If multiple photos feed through at the same time, press the  (Slow Mode) button to slow down the feeding speed. Press the button again to return to normal speed.

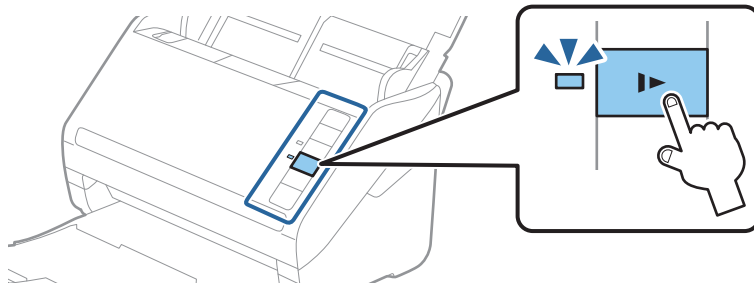

4. After scanning is completed, the following screen is displayed:

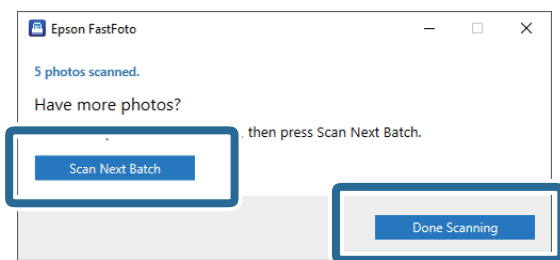

If you want to continue scanning, click **Scan Next Batch**. If you are finished scanning, click **Done Scanning**.

5. The photos are scanned and saved in the location you chose. Check the scanned images.

The following rules apply to file naming:

- ❑ No identifier is added: These are the original scanned images. No enhancements were applied.
- ❑ Added "\_a" at the end: These images include automatic color enhancements.

## Scanning Photos

- ❑ Added "\_b" at the end: These are the scanned back sides of the photo. You can enable back side scanning from **Settings > Scan Settings** tab.

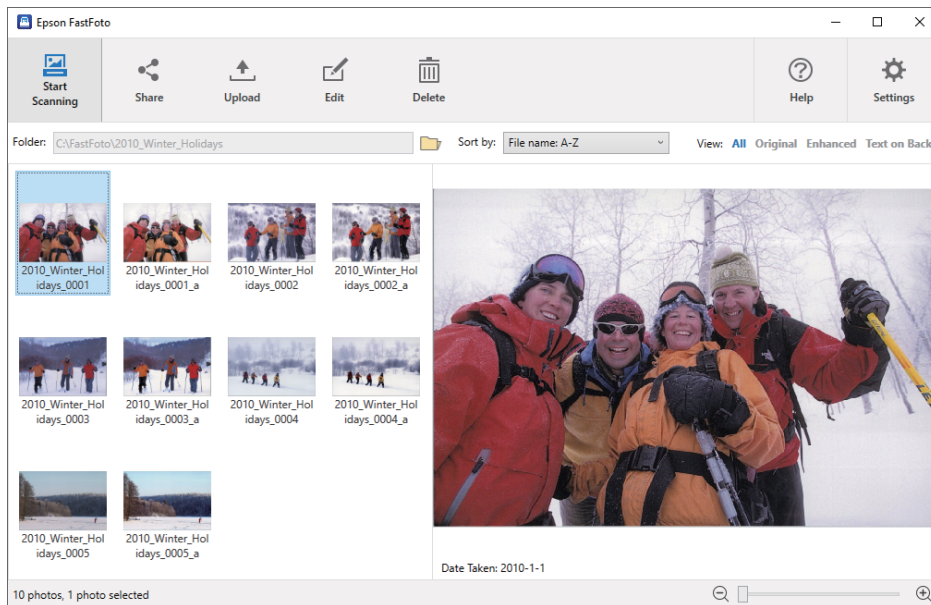

After scanning, you can share, upload, or edit the images using Epson FastFoto. You can also change the view setting of thumbnails.

### Related Information

- ➔ [“Sharing Photos” on page 26](#)  
You can share scanned photos via email.
- ➔ [“Uploading Photos” on page 28](#)  
You can upload scanned photos to Dropbox or Google Drive.
- ➔ [“Editing Photos” on page 30](#)  
You can edit the scanned photos using features such as rotation, enhancement, red eye correction, and more.
- ➔ [“Changing the Displayed Folder and Thumbnail View” on page 32](#)  
You can change the displayed folder and how thumbnails are viewed.

## Sharing Photos

You can share scanned photos via email.

### Note:

*Available destination items are subject to change without notice.*

## Scanning Photos

1. Select the images you want to share.

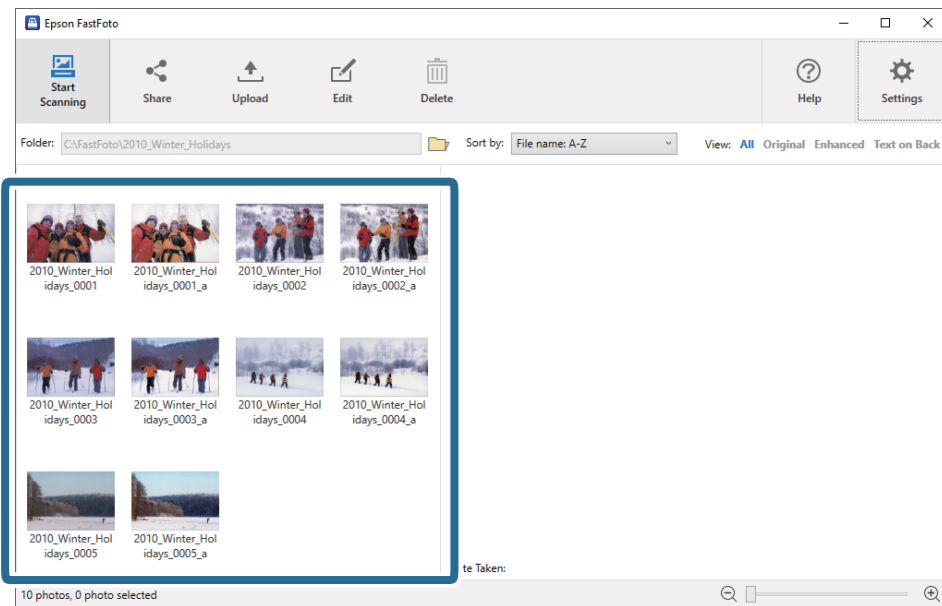

2. Click **Share**.

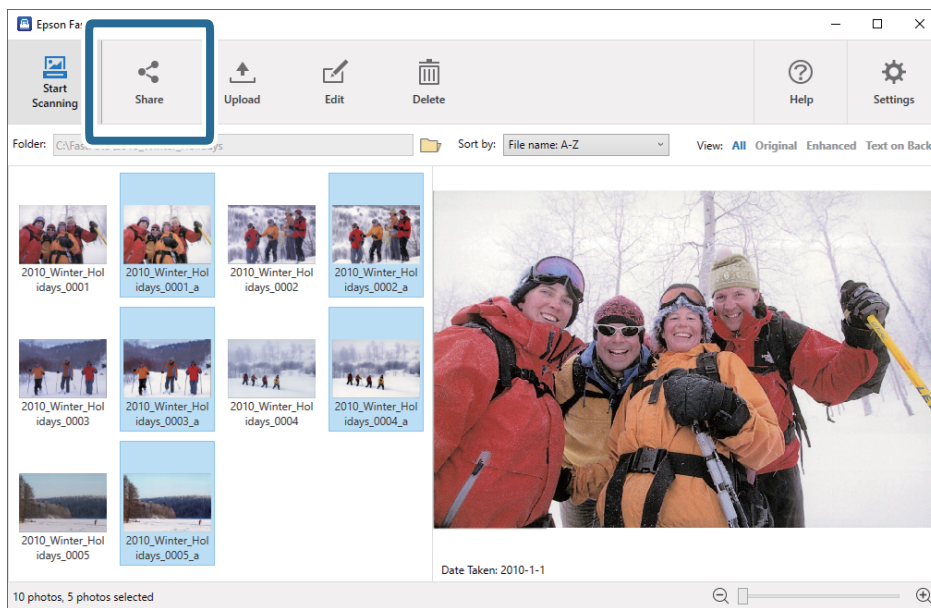

3. Click **Email**.

Selected images are automatically attached in a new email. Enter the necessary information and send the email.

## Scanning Photos

**Note:**

If you do not have a default email client application set up, you will be prompted to do so before you can send any images. Epson FastFoto does not support web-based email, such as Gmail.

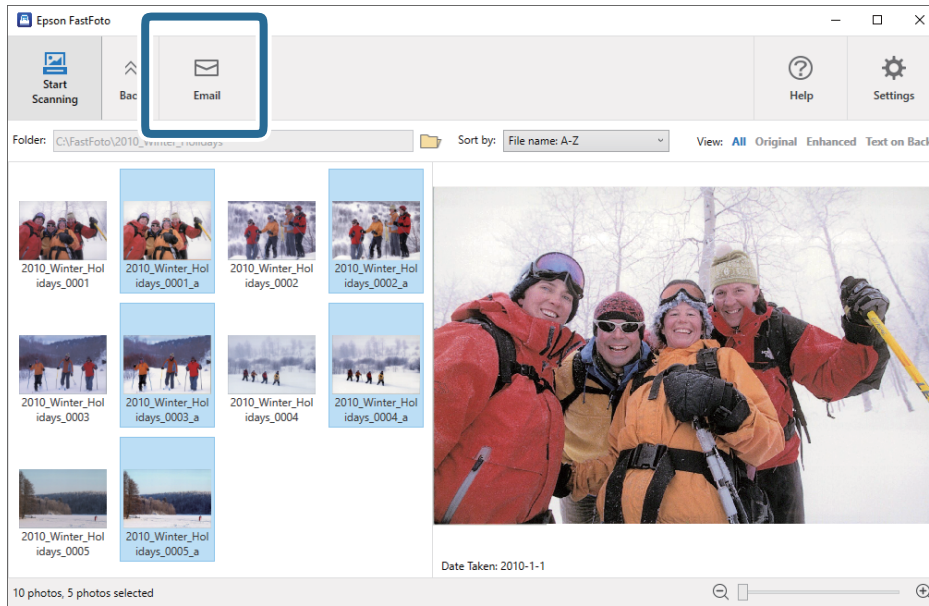

## Uploading Photos

You can upload scanned photos to Dropbox or Google Drive.

**Note:**

Make sure the Dropbox application is installed on your computer before uploading.

1. Select the images you want to upload.

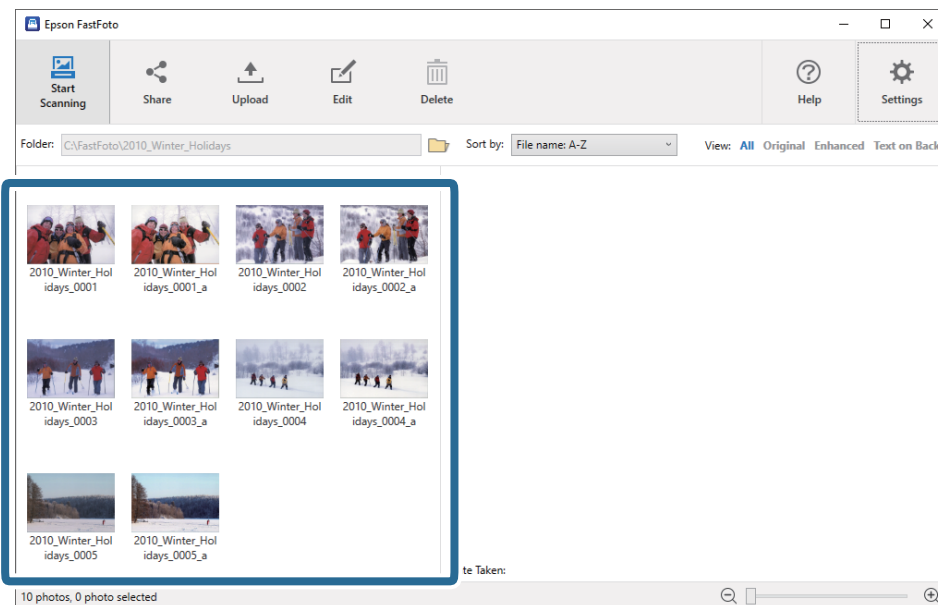

## Scanning Photos

2. Click **Upload**.

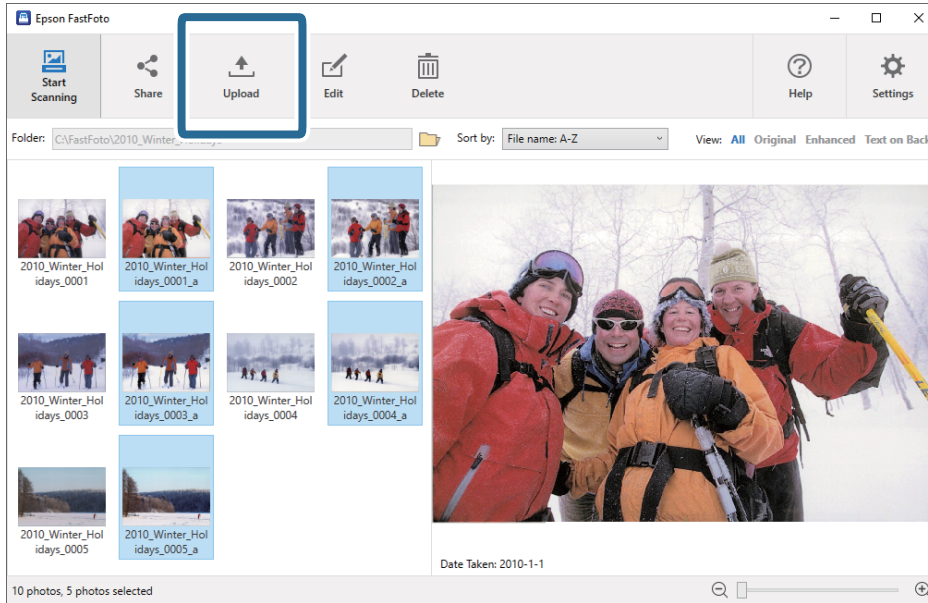

3. Click one of the following.

- Dropbox:** Uploads images to your Dropbox folder.
- Google Drive:** Uploads images to Google Drive.

**Note:**

*If you have not connected your Dropbox or Google Drive account with Epson FastFoto, you will be prompted to do so.*

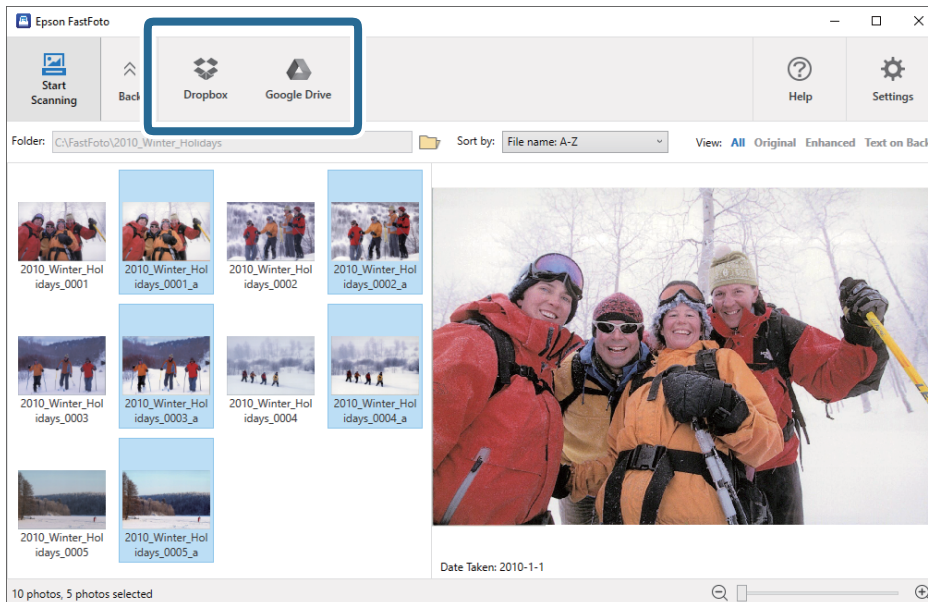

**Note:**

*You can automatically upload the images immediately after scanning. Click **Settings** on the main screen, click the **Upload** tab, and then select the icon of the service you want to upload to.*

## Scanning Photos

### Editing Photos

You can edit the scanned photos using features such as rotation, enhancement, red eye correction, and more.

**Note:**

You can automatically apply the **Auto Enhance**, **Remove Red Eye**, and **Restore Faded Colors** when scanning. Click **Settings > Enhancements** tab.

1. Select the images you want to edit.

**Note:**

You can select and edit multiple images except **Crop** (Windows only) feature.

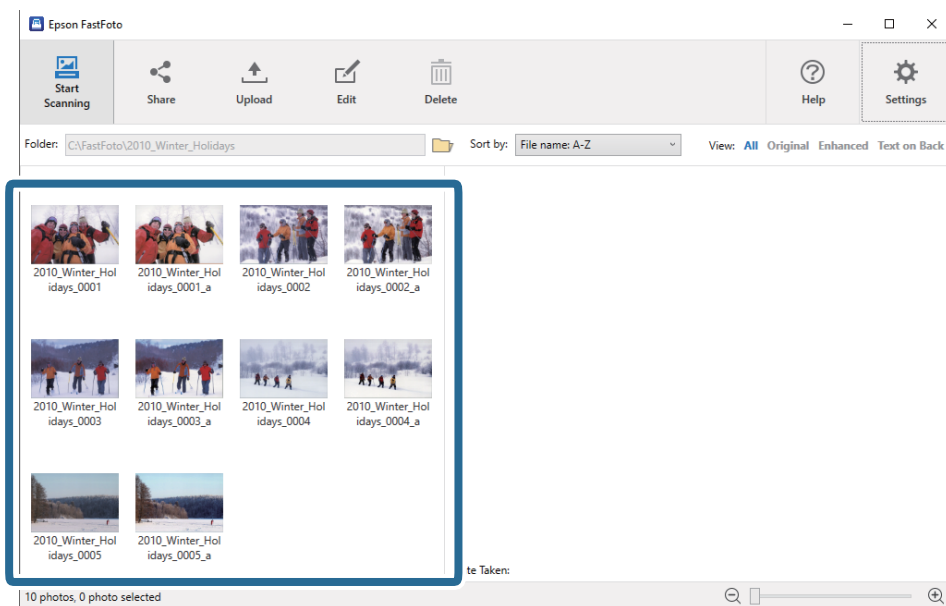

2. Click Edit.

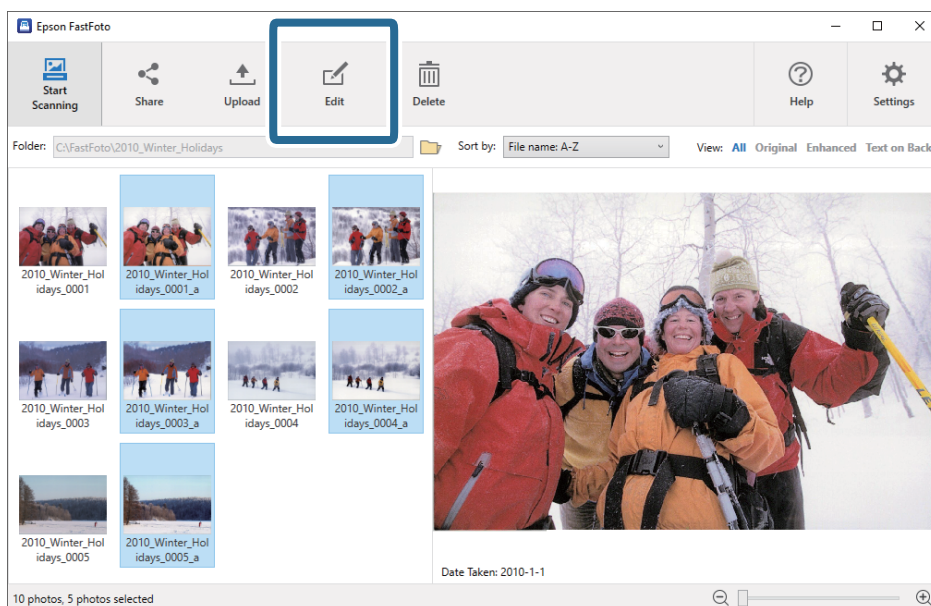

## Scanning Photos

3. Select the edit item on the top of the screen.

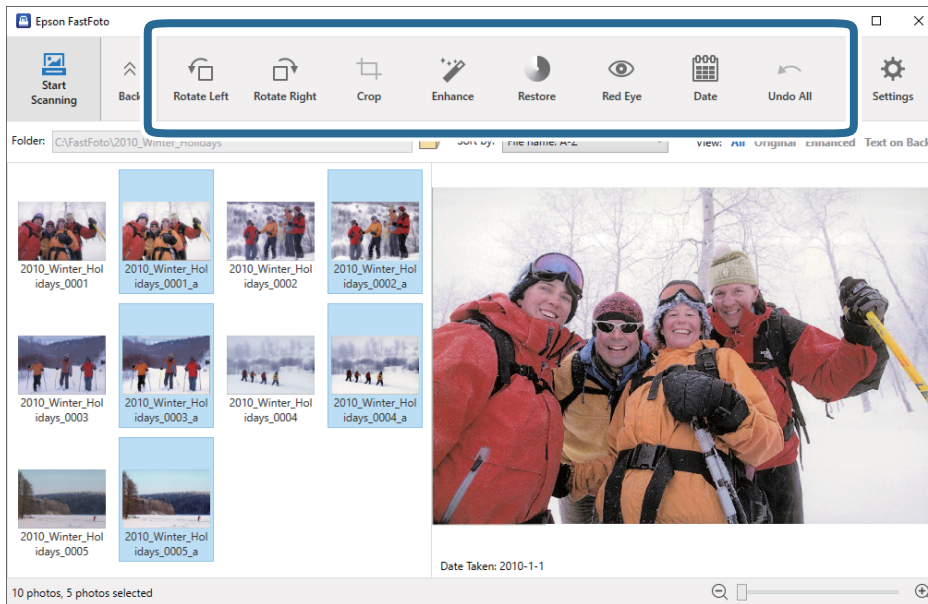

- Rotate Left/Rotate Right:** Rotate the selected images.
- Crop** (Windows only): Crop the image. An outline appears around the selected image in the preview pane. Click and drag the outline to highlight the cropped area, and then click **Apply** to crop the image. You can select one image each time when applying this item.
- Enhance:** Applies photo enhancement (brightness, contrast, and saturation) to the selected images.
- Restore:** Applies color restoration to the selected images.
- Red Eye:** Reduces the red eye effect in the selected images.
- Date** (Windows only): Allows you to add, edit, or remove a date on the selected images (shown as the **Date Taken** information).
- Undo All:** Removes all edits from the selected images made during the current session, since you started Epson FastFoto.

Once you exit Epson FastFoto, your edits are permanent.

## Scanning Photos

### Changing the Displayed Folder and Thumbnail View

You can change the displayed folder and how thumbnails are viewed.

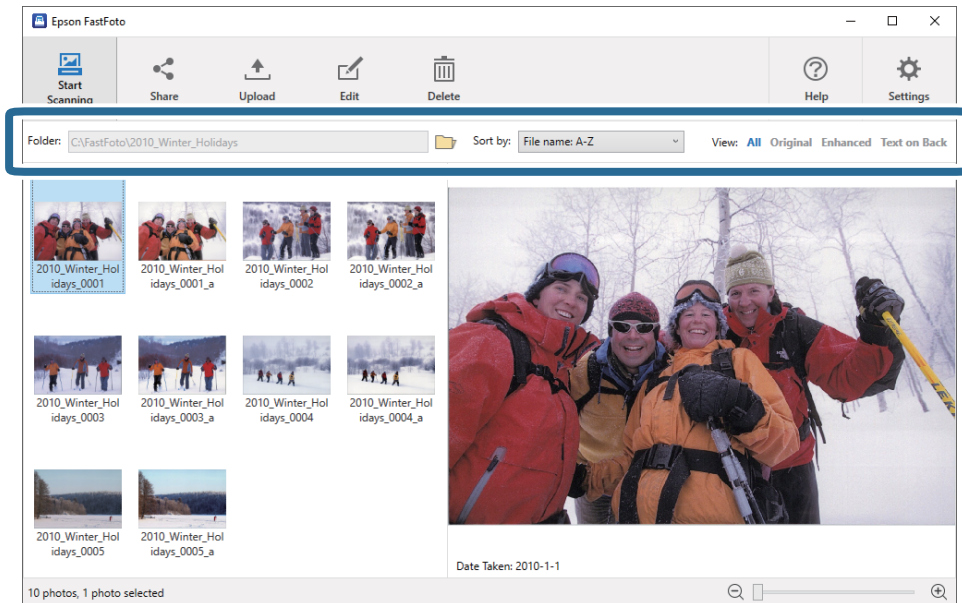

#### Folder

The current folder is displayed. You can change the folder by clicking the  icon.

#### Sort by

You can change how thumbnails are viewed or sorted.

#### View

You can filter the thumbnails.



## Tips for Using Epson FastFoto

### Scanning Instant Photos

You can scan instant photos.

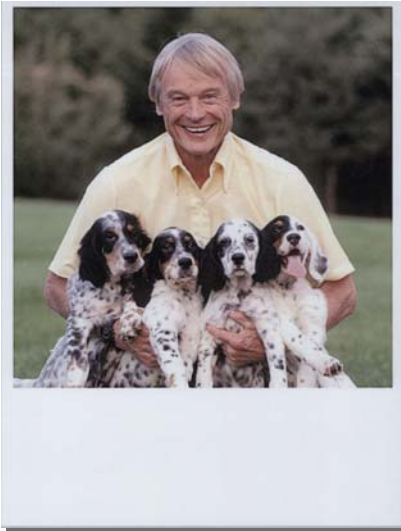

Before scanning, check the specification of instant photos you can scan.

| Size                | Measurement                | Paper Type   | Loading Capacity |
|---------------------|----------------------------|--|------------------|
| Instant camera size | 89×102 mm<br>(3.5×4.0 in.) | Instant camera<br>photographic paper (sheet<br>film type only) | 1 sheet          |

**Note:**

*When scanning instant photos, the double feed detection feature is turned off to prevent misdetection. Instant camera photographic paper is usually layered, so it is detected as double fed in normal scanning settings.*

## Scanning Photos

1. Change the scan setting before scanning. Click **Settings** on the main screen.

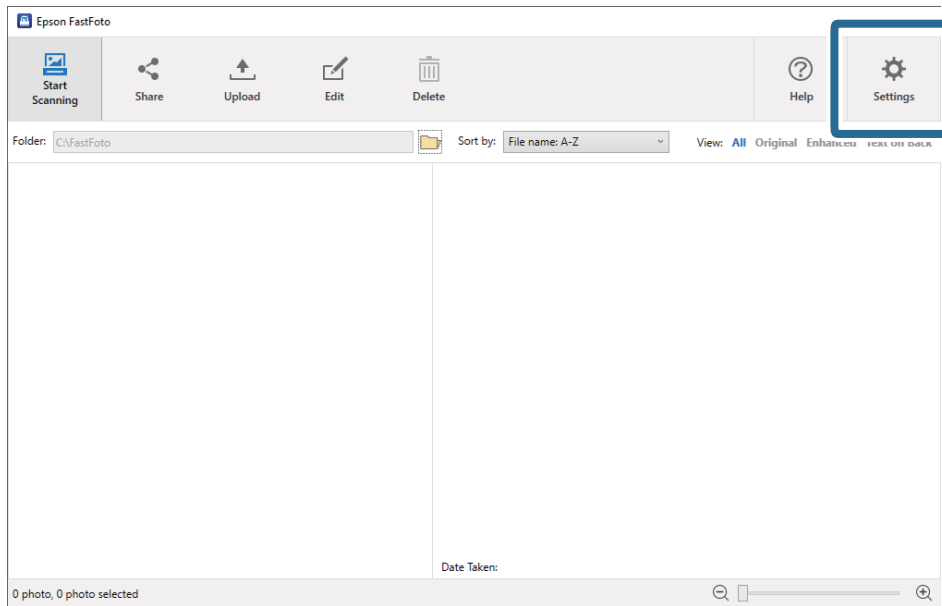

2. Click the **Scan Settings** tab.

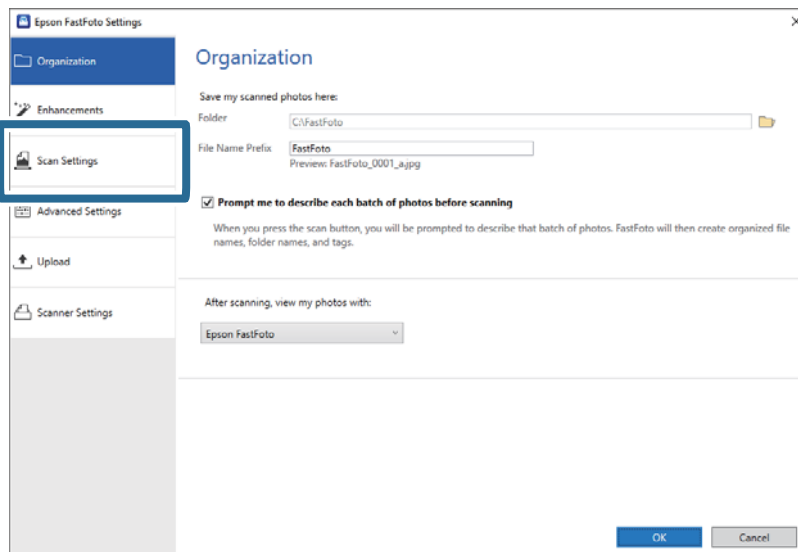

## Scanning Photos

3. Select **Instant photos**.

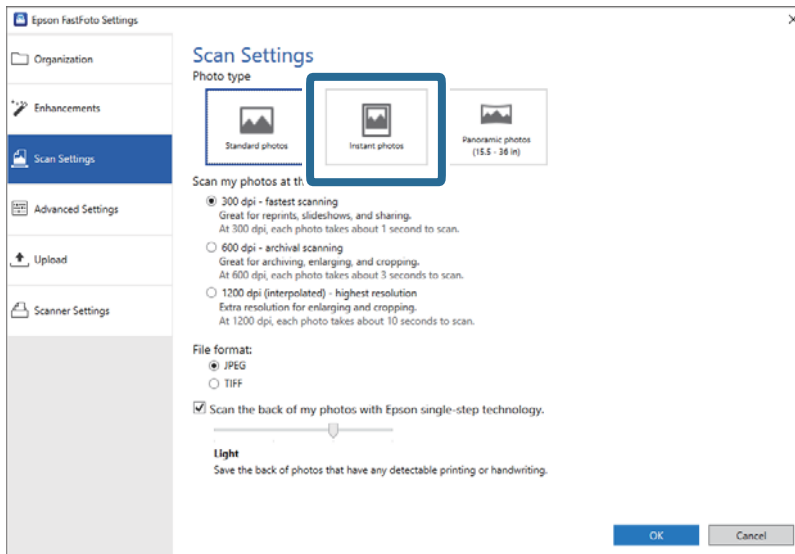

4. Click **OK** to apply the settings.

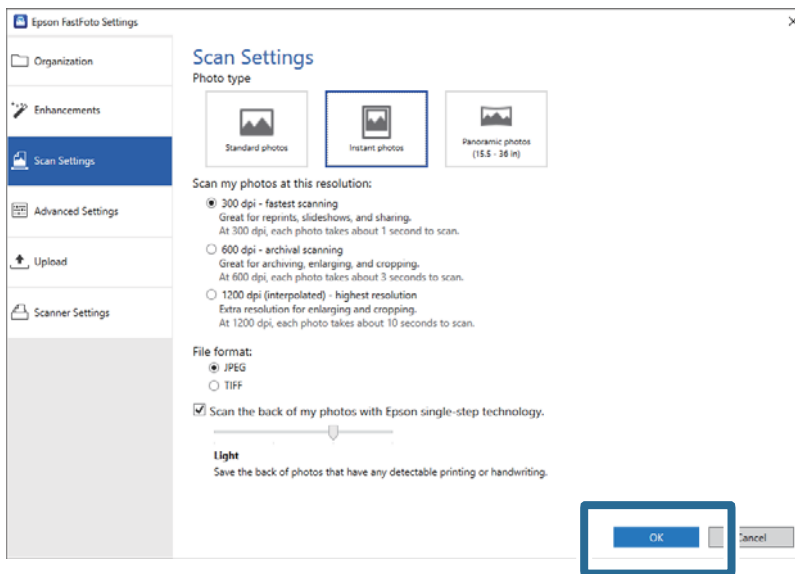

If you want to scan other types of photos after scanning, change the photo type on the **Scan Settings** tab.

### Related Information

➔ [“Step 3: Scanning and Saving Photos” on page 24](#)

Epson FastFoto automatically saves your scanned images on your computer in the folder you specify.

## Scanning Photos

### Scanning Panoramic Photos

You can scan panoramic photos.



Before scanning, check the specification of panoramic photos you can scan.

| Measurement  | Loading Capacity | Input and Output Tray of the Scanner  |
|--|------------------|---|
| 89×254 mm (3.5×10.0 in.)   | 10 sheets        | Extend the input and output tray extensions, and do not raise the stopper.<br><br>                      |
| 102×304.8 mm (4.0×12.0 in.)  |                  |   |
| Other size: Length up to 304.8 mm (12.0 in.)   |                  |   |
| Other size: Length 304.8 mm (12.0 in.) to 914.4 mm (36.0 in.) *<br>(Max size: 215.9×914.4 mm (8.5×36.0 in.)) | 1 sheet          | Do not extend the input tray extension and output tray extensions and do not raise the stopper.<br><br> |

\*When scanning photos that are 393.8 mm (15.5 in.) or more, you need to change the Epson FastFoto scan settings. See the instructions below.

## Scanning Photos

1. Click **Settings** on the main screen.

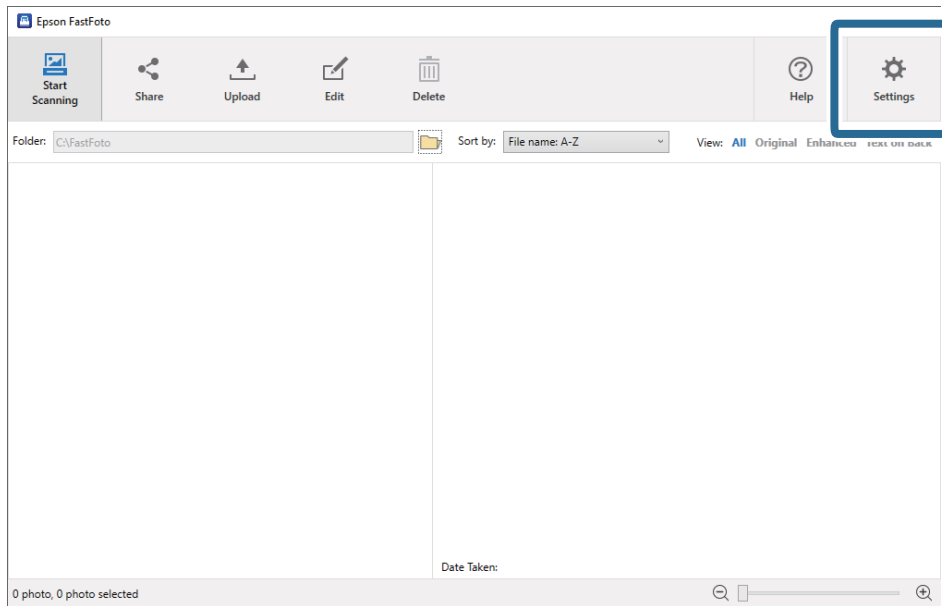

2. Click the **Scan Settings** tab.

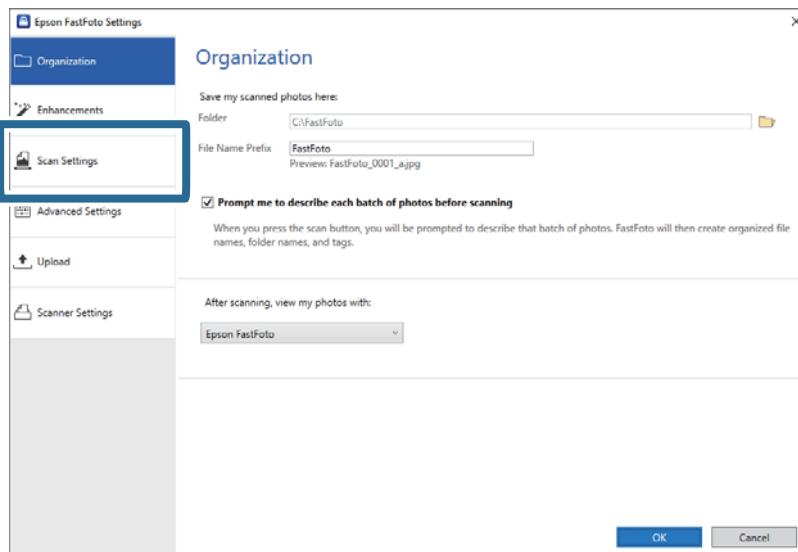

## Scanning Photos

3. Select **Panoramic photos (15.5 - 36 in)**.

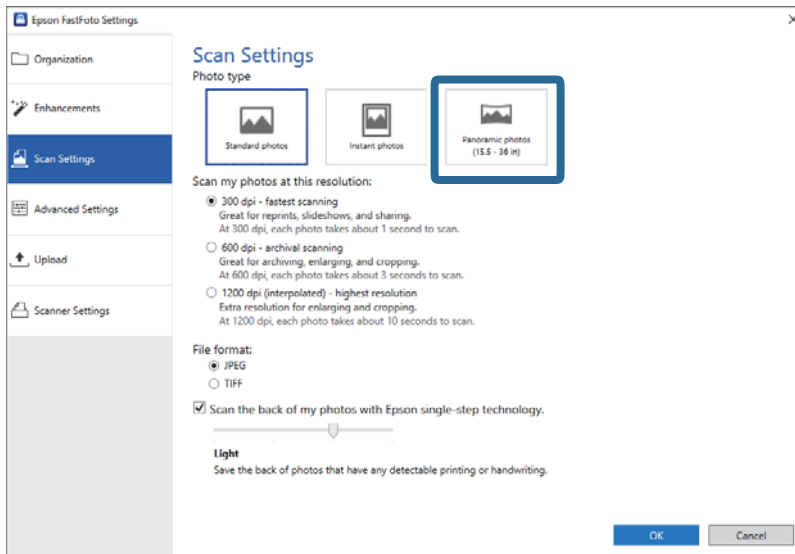

**Note:**

When selecting **Panoramic photos (15.5 - 36 in)**, you can set the resolution as 600 dpi or 300 dpi. If you select 1200 dpi, it is changed to 600 dpi automatically.

4. Click **OK** to apply the settings.

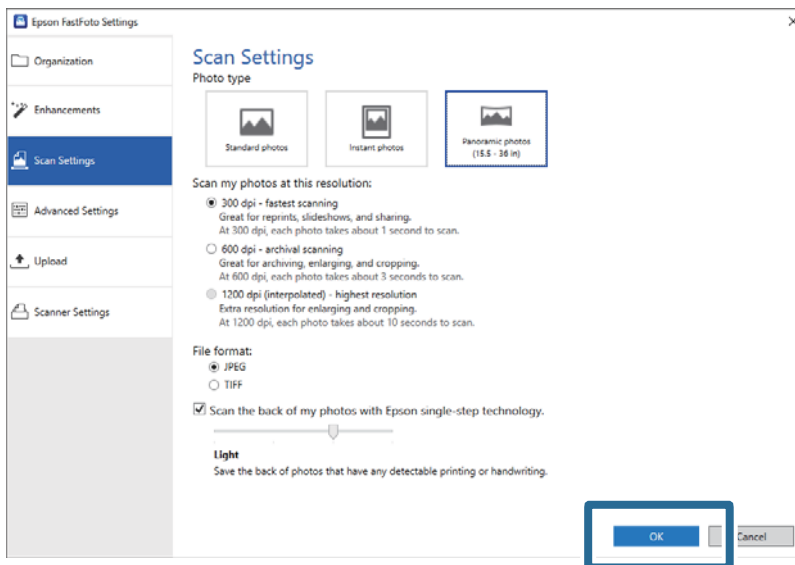

## Scanning Photos

**Note:**

- ❑ Support the photo as it enters into and ejects from the scanner.

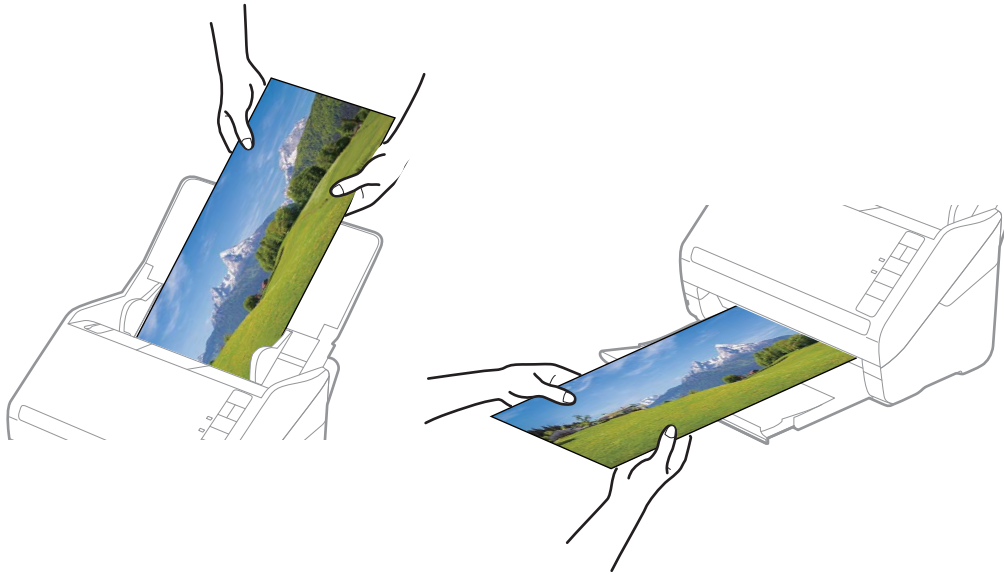

- ❑ If you want to scan other types of photos after scanning, change the photo type on the **Scan Settings** tab.
- ❑ For panoramic photos up to 393.7 mm (15.5 in.), you do not need to select **Panoramic photos (15.5 - 36 in)**. You can leave the setting as **Standard photos**.

### Related Information

- ➔ [“Step 3: Scanning and Saving Photos” on page 24](#)

Epson FastFoto automatically saves your scanned images on your computer in the folder you specify.

## Scanning Back Side Notes on Photos

When scanning photos, you can also scan the back of the photos.

If text on the back of the photos is detected, the back sides of the photos are scanned. If the back sides are blank, the back sides of the photos are not scanned.



## Scanning Photos

1. Click **Settings** on the main screen.

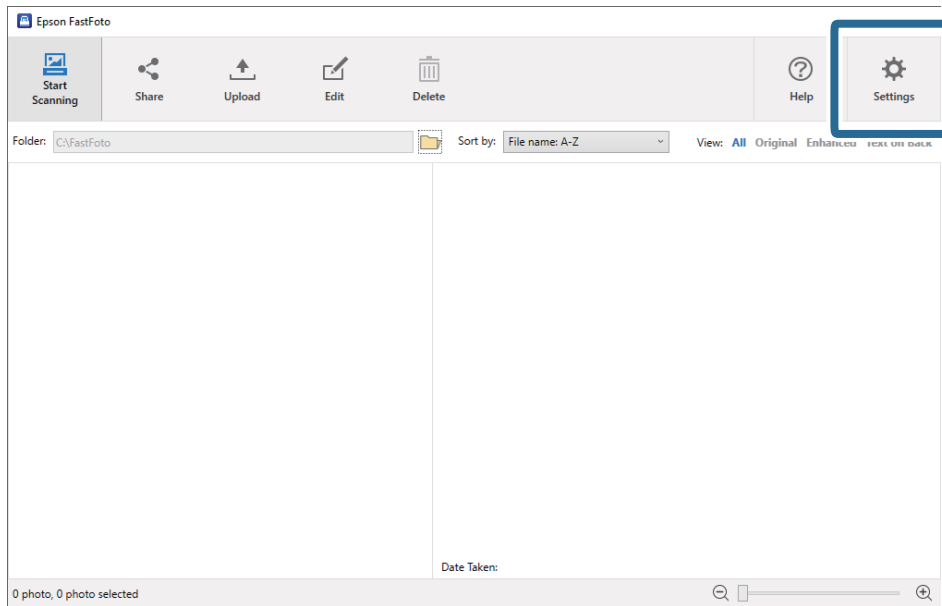

The **Epson FastFoto Settings** screen is displayed.

2. Click the **Scan Settings** tab.

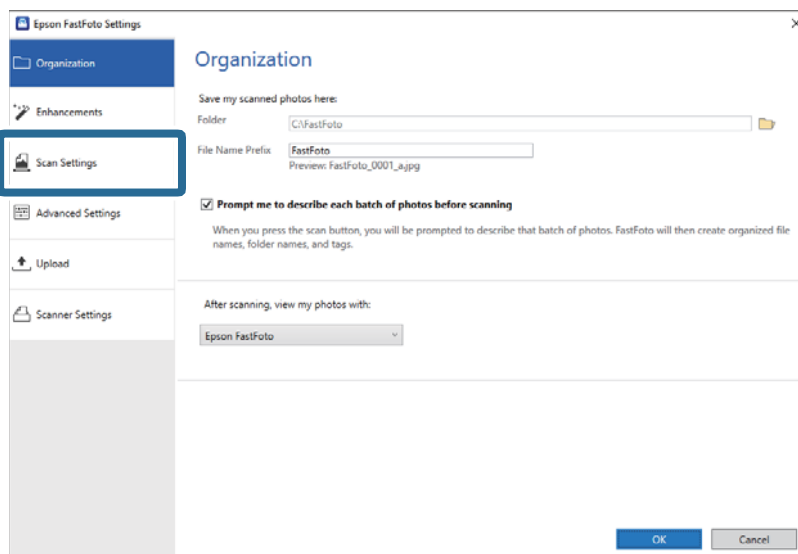



## Scanning Photos

3. Enable **Scan the back of my photos with Epson single-step technology**, and then adjust the detection level using the slider.

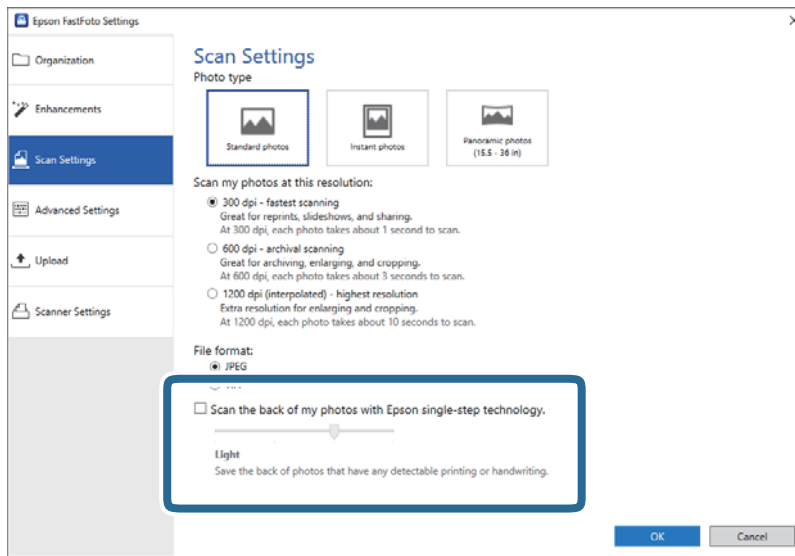

4. Click **OK** to apply the settings.

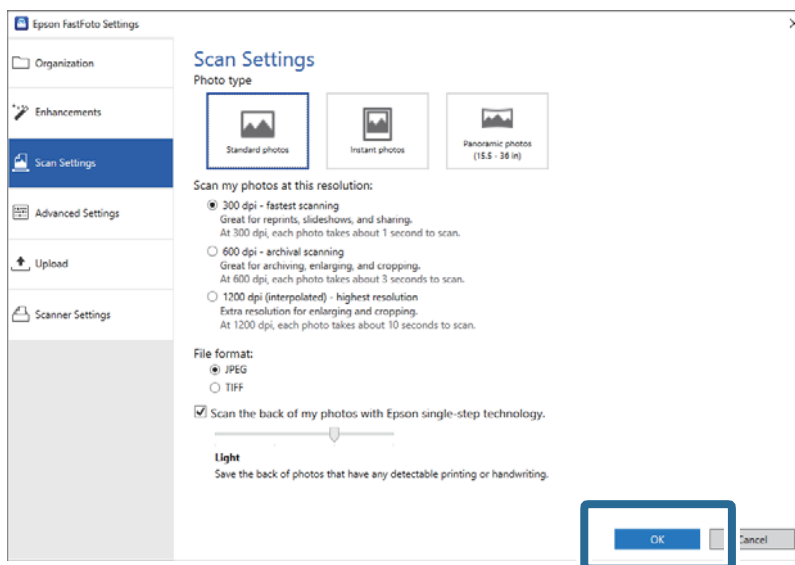

## Scanning Photos

When scanning the photos, the back side images are saved as the name ended with "\_b".

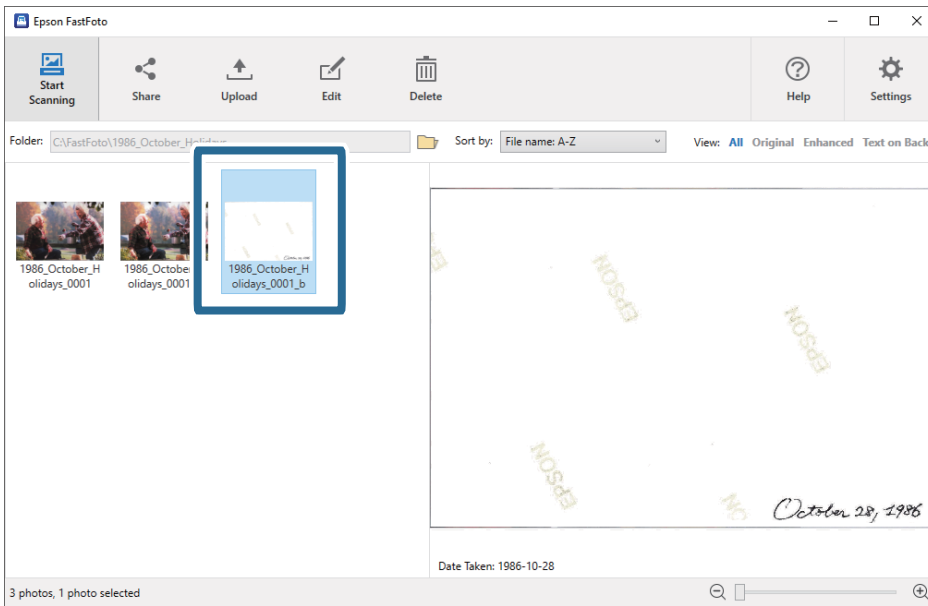

**Note:**

No color enhancement is applied to the back side image when scanning. If you want to enhance the color, select the image and click **Edit** on the main screen.

## Loading Photos Using a Carrier Sheet

You can scan damaged or valuable photos by using the Carrier Sheet.

**Note:**

When scanning photos using the Carrier Sheet, you can only load one sheet at a time.

1. Open the input tray and extend the input tray extension. Slide out the output tray, extend the output tray extension, and then raise the stopper.

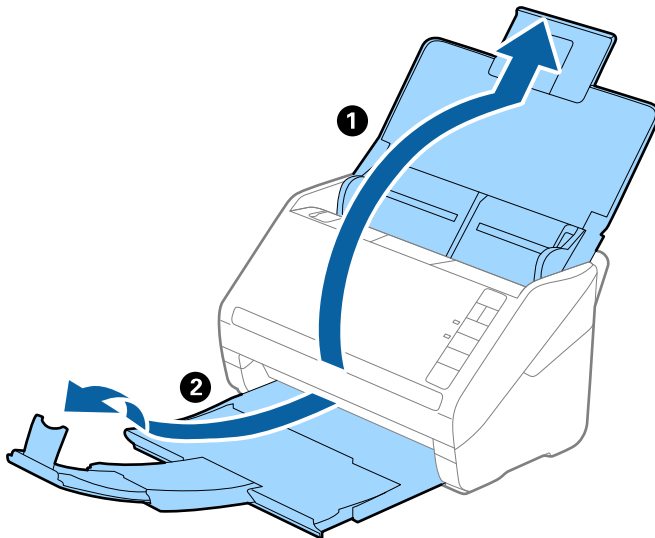

## Scanning Photos

- Slide the edge guides on the input tray all the way out.

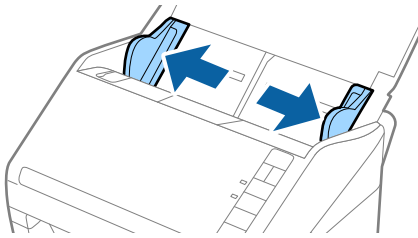

- Place the Carrier Sheet with the illustration on the front edge facing up, and place the photo in the center of the Carrier Sheet with the side to be scanned facing up.



- Load the Carrier Sheet into the input tray with the top edge facing into the ADF. Slide the Carrier Sheet into the ADF until it meets resistance.

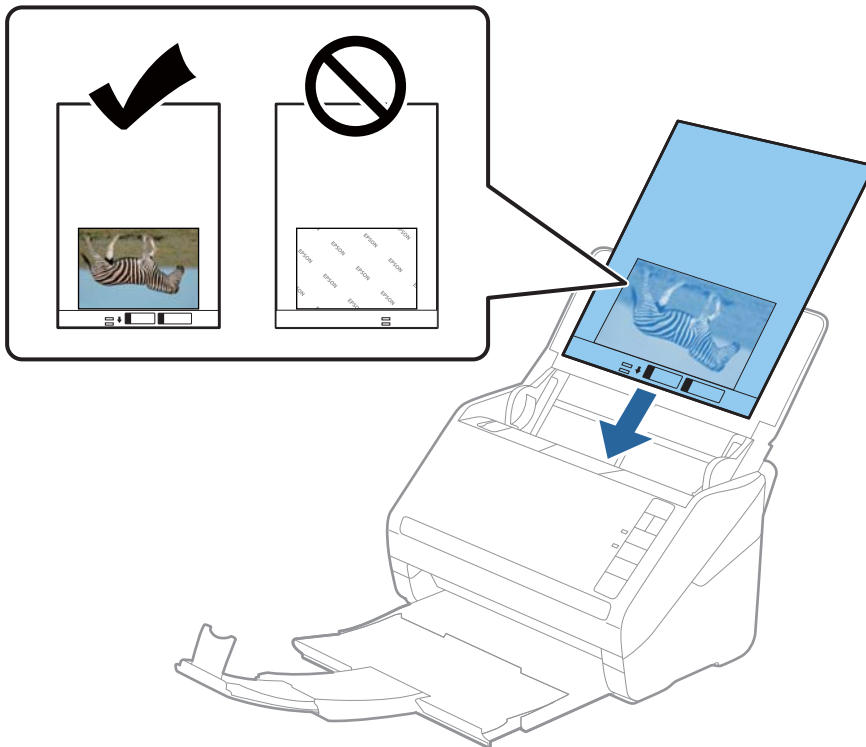

## Scanning Photos

- Slide the edge guides to fit the edge of the Carrier Sheet making sure there are no gaps between the Carrier Sheet and the edge guides. Otherwise, the carrier sheet may be fed skewed.

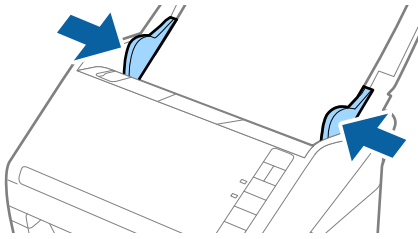

**Note:**

- You may need to stop using a Carrier Sheet that is scratched or has been scanned more than 3,000 times.
- Do not leave photos inside the Carrier Sheet for a long time.
- Only use the Carrier Sheet designed for your scanner. The Carrier Sheet is automatically recognized by the scanner by detecting two small rectangular holes on the front edge. Keep the holes clean and not covered.

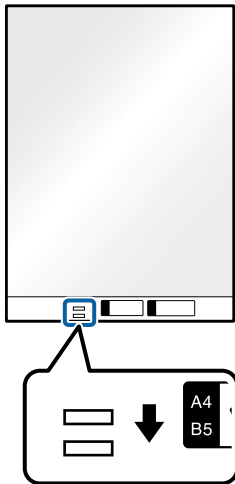

### Related Information

➔ [“Carrier Sheet Codes” on page 16](#)

## Enabling or Disabling Glass Surface Dirt Alert

You can select whether or not to detect dirt on the glass surface inside the scanner.

**Note:**

*Depending on the dirt, it may not be detected correctly.*

## Scanning Photos

1. Click **Settings** on the main screen.

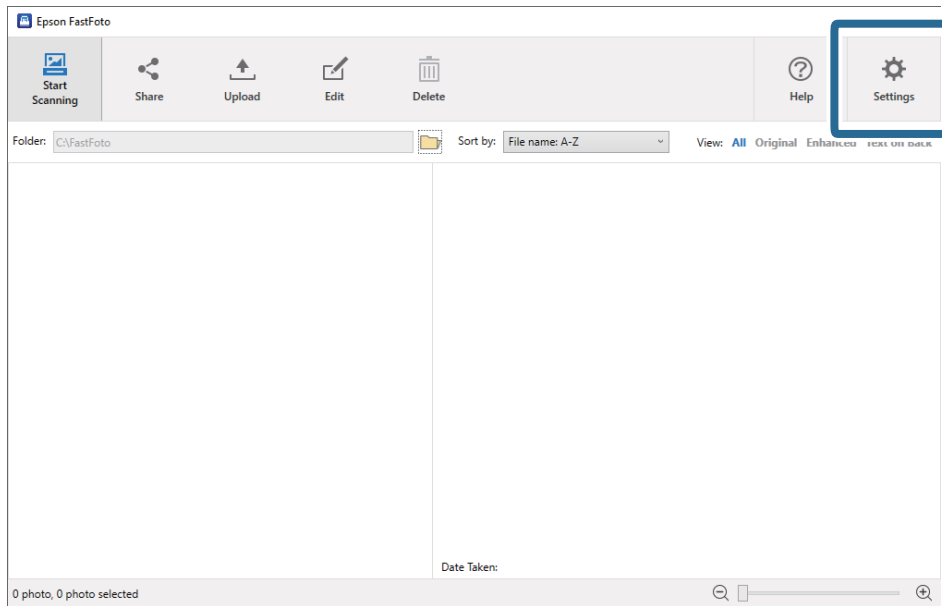

The **Epson FastFoto Settings** screen is displayed.

2. Click **Device Settings** on the **Scanner Settings** tab.

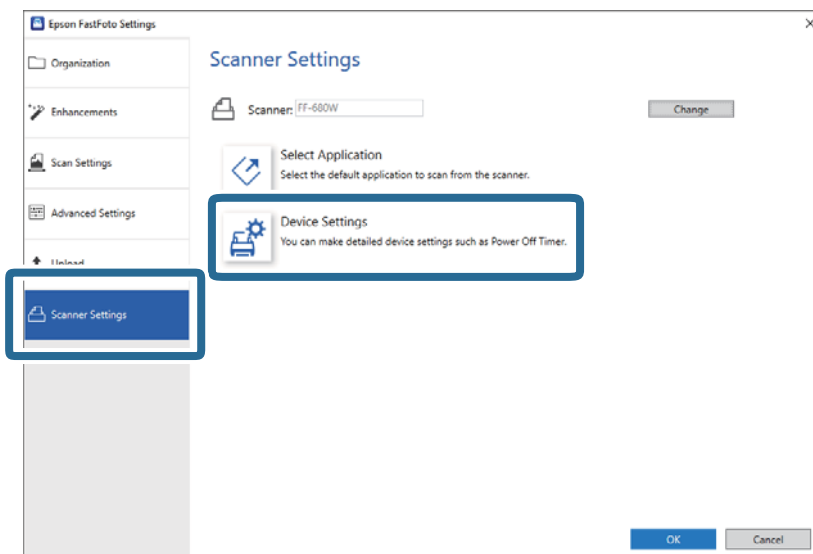

The **Epson Scan 2 Utility** screen is displayed.

## Scanning Photos

3. Select the **Scanner Setting** tab.

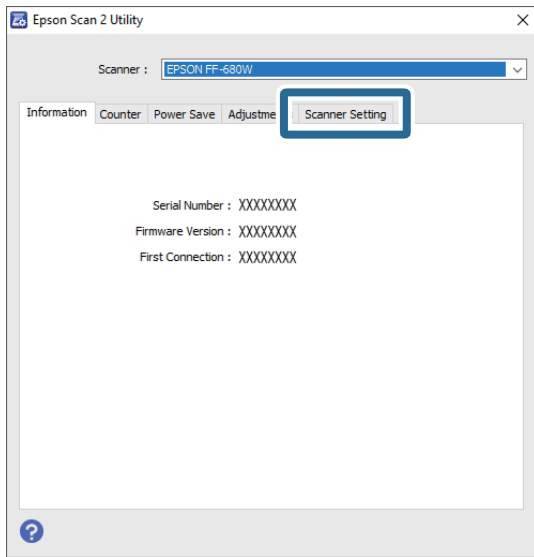

4. Under the **Detect Glass Dirt** dropdown menu, select **On-Low** or **On-High**.  
If you want to disable the detection, select **Off**.

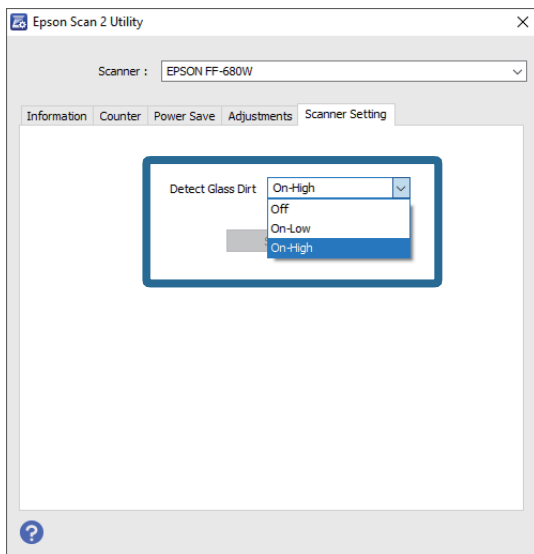

## Scanning Photos

5. Click **Set**.

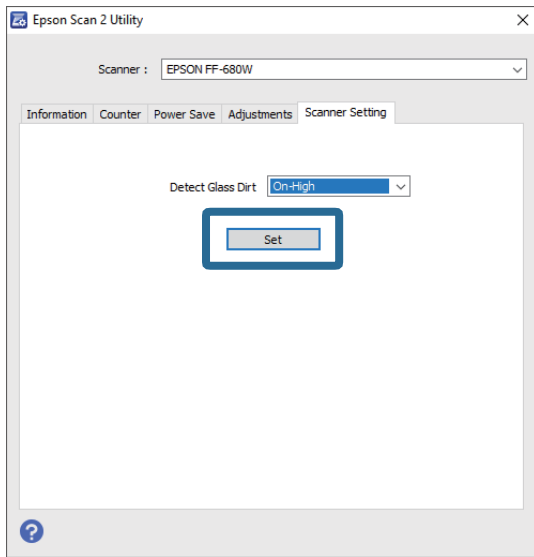

6. Close the **Epson Scan 2 Utility** screen.

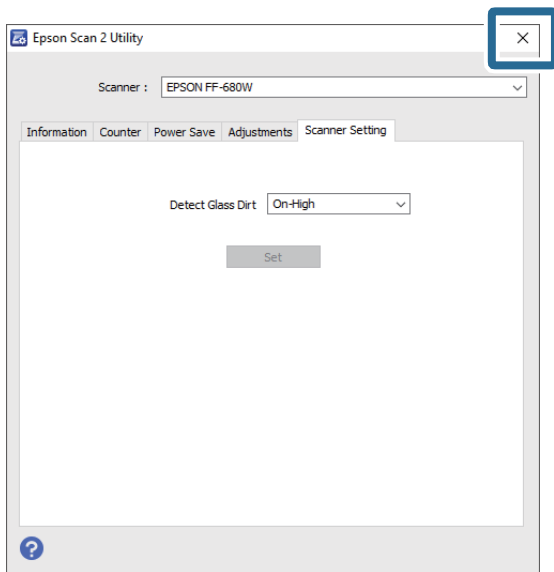

## Changing the Application to Scan from the Scan Button

You can change the default application that starts when you press the scan button.

## Scanning Photos

1. Click **Settings** on the main screen.

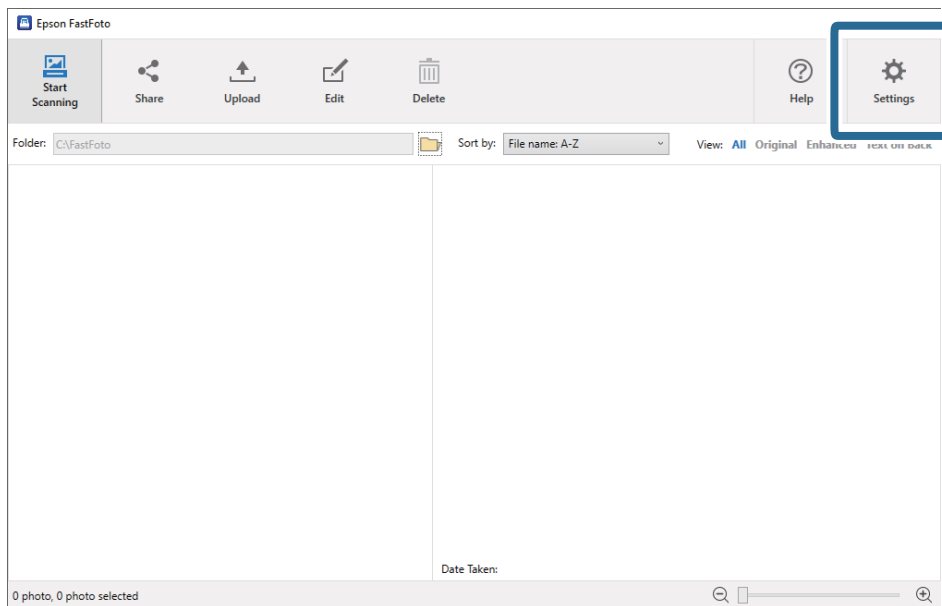

The **Epson FastFoto Settings** screen is displayed.

2. Click **Select Application** on the **Scanner Settings** tab.

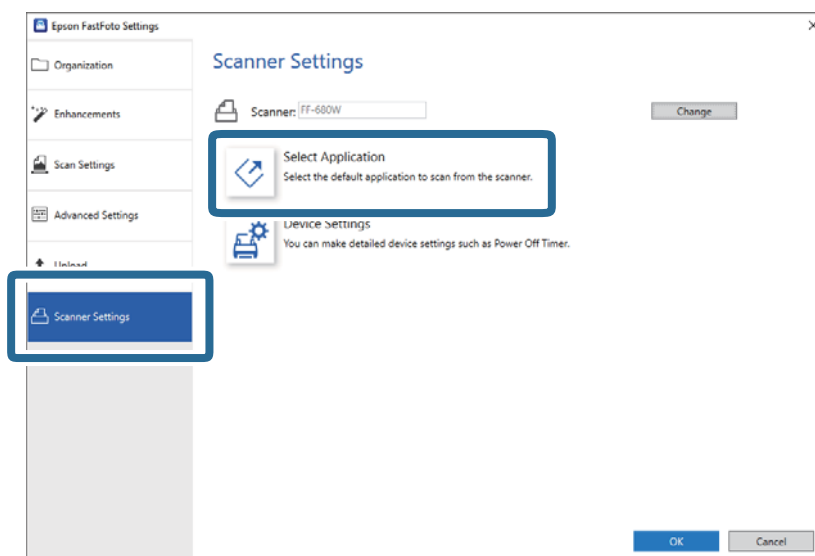

3. Select the application that starts when you press the scan button.

- Epson FastFoto:** Launches Epson FastFoto. This application is suitable for scanning and saving photos.
- Epson ScanSmart:** Launches Epson ScanSmart. This application is suitable for scanning and saving documents.



## Scanning Photos

**Note:**

*Epson FastFoto is selected as the default setting.*

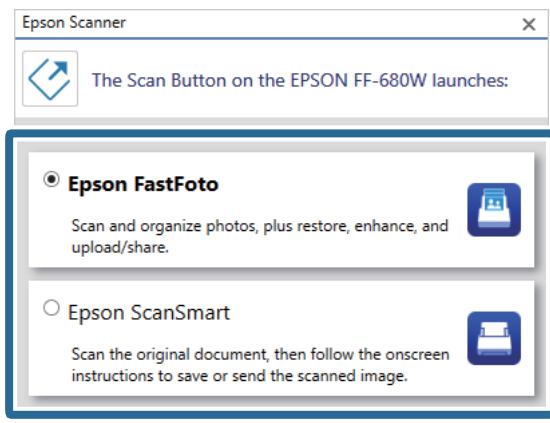

4. After selecting the application, close the screen to apply the setting.

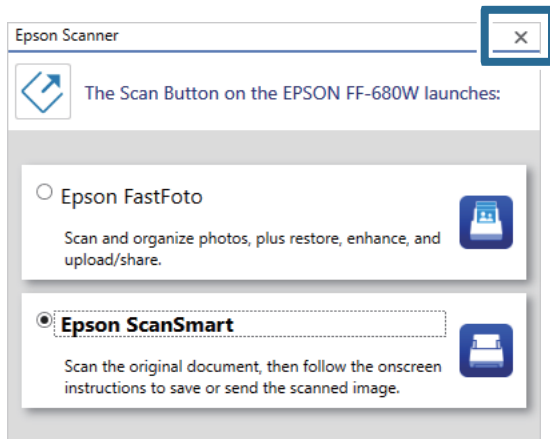

---

## Epson FastFoto Settings

You can change the application settings, such as the file format, scanning resolution, folder to save, and more.

## Scanning Photos

1. Click **Settings** on the main screen.

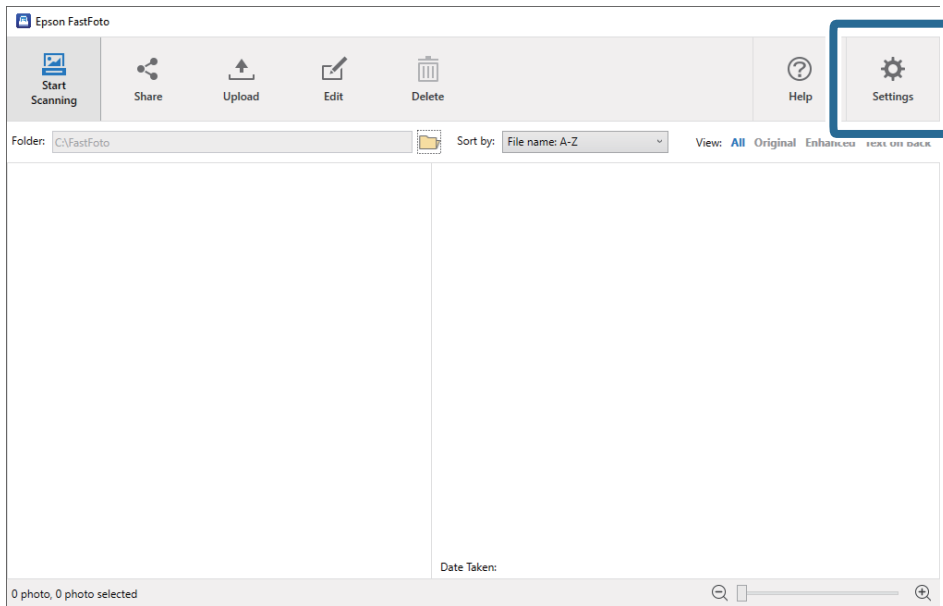

The **Epson FastFoto Settings** screen is displayed.

2. Select one of the tabs, and then change the settings.

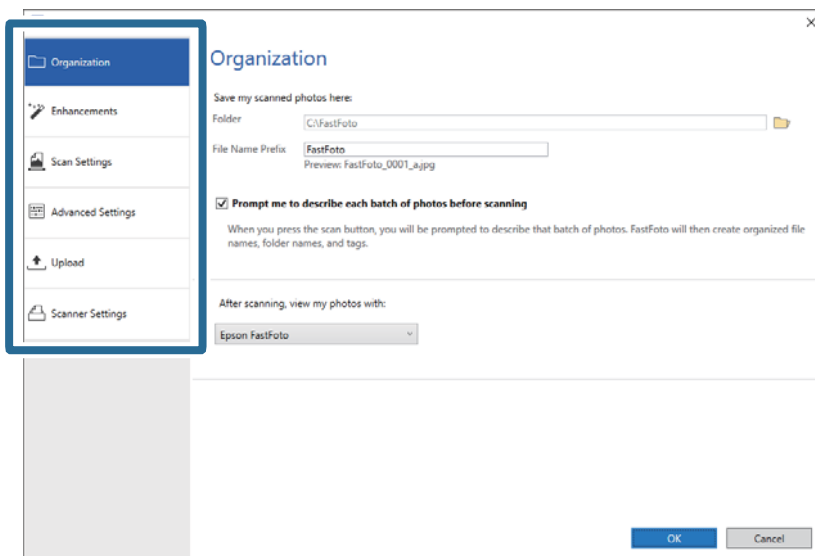

### Related Information

- ➔ [“Organization Tab” on page 51](#)  
You can change the folder save settings, file name settings, and more.
- ➔ [“Enhancements Tab” on page 52](#)  
You can change the enhancement settings which are automatically applied to the scanned image when scanning.
- ➔ [“Scan Settings Tab” on page 53](#)  
You can change the scan settings such as the photo type, resolution, or file saving format.
- ➔ [“Advanced Settings Tab” on page 54](#)  
You can change the advanced scan settings, such as photo rotation, back side scanning, and more.
- ➔ [“Upload Tab” on page 54](#)

## Scanning Photos

You can automatically upload the scanned image to a cloud service after scanning.

➔ [“Scanner Settings Tab” on page 55](#)

You can change the scanner settings, such as the scanner to use, the scanning application that starts when you press the scan button, or device settings.

## Organization Tab

You can change the folder save settings, file name settings, and more.

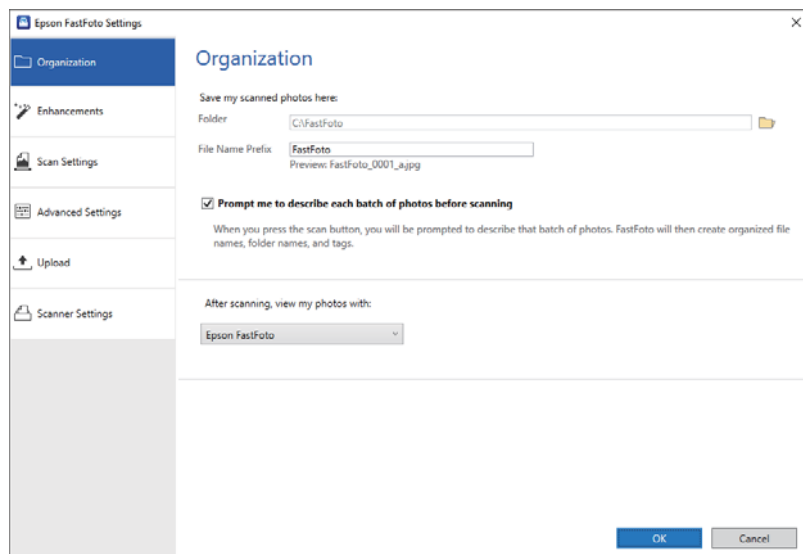

### Folder

Select the folder to save the scanned image.

### File Name Prefix

Enter the text you want to add at the beginning of the file name. This setting is useful if you do not set the file naming settings on the **Describe Your Photos** screen before scanning.

### Prompt me to describe each batch of photos before scanning

Displays the **Describe Your Photos** screen before scanning.

### After scanning, view my photos with

Selects the application to view the scanned image after scanning.

## Scanning Photos

### Enhancements Tab

You can change the enhancement settings which are automatically applied to the scanned image when scanning.

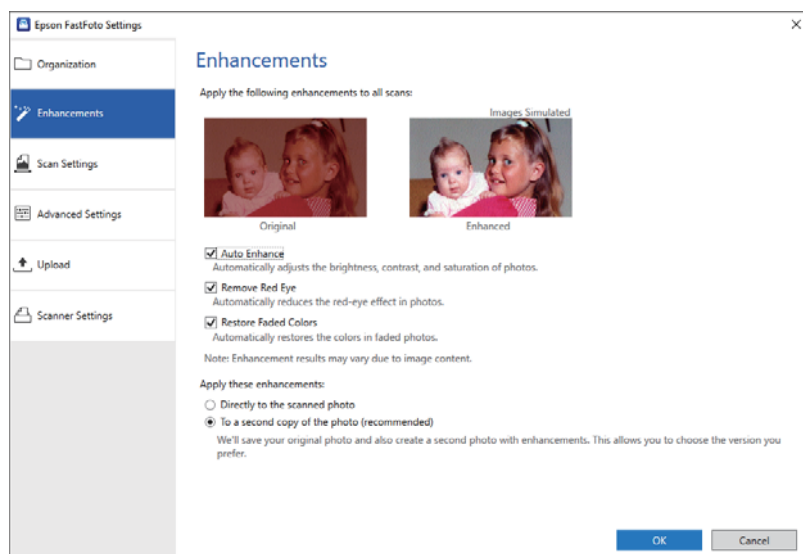

**Note:**

*Enhancement results may vary depending on the image contents of the photos.*

#### Auto Enhance

Automatically adjusts the brightness, contrast, and saturation of photos.

#### Remove Red Eye

Automatically reduces the red-eye effect in photos.

#### Restore Faded Colors

Automatically restores the colors in faded photos.

#### Apply these enhancements

- Directly to the scanned photo:** Only the enhanced scanned image is saved in your folder, and the original scanned image is not saved.
- To a second copy of the photo (recommended):** Saves two images for each photo. One is the original scanned image, and another is the enhanced image.

## Scanning Photos

### Scan Settings Tab

You can change the scan settings such as the photo type, resolution, or file saving format.

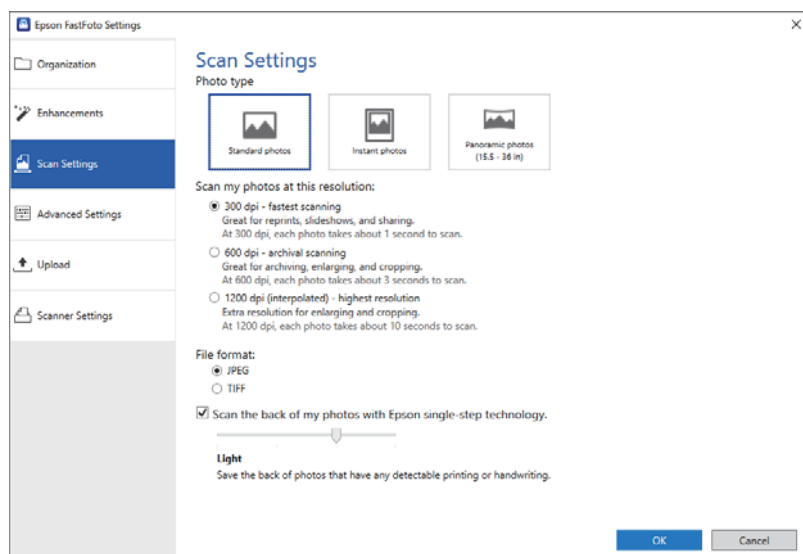

#### Photo type

Selects a photo type you want to scan. Applies special settings for instant and panoramic photos when scanning.

#### Scan my photos at this resolution

Selects a resolution to scan your photos. Increasing the resolution increases the scanning time and file size.

#### File format

Selects a file format to save the scanned image.

#### **Note:**

When you select **JPEG** and set the resolution to 1200 dpi or 600 dpi, the scanned image is saved at 100% JPEG quality (compression).

If you select 300 dpi, the JPEG quality (compression) is set to 84% automatically to reduce the file size when saving the scanned image.

#### Scan the back of my photos with Epson single-step technology

When scanning photos, you can also scan the back of the photos.

If text on the back of the photos is detected, the back sides of the photos are scanned. If the back sides are blank, the back sides of the photos are not scanned.

## Scanning Photos

### Advanced Settings Tab

You can change the advanced scan settings, such as photo rotation, back side scanning, and more.

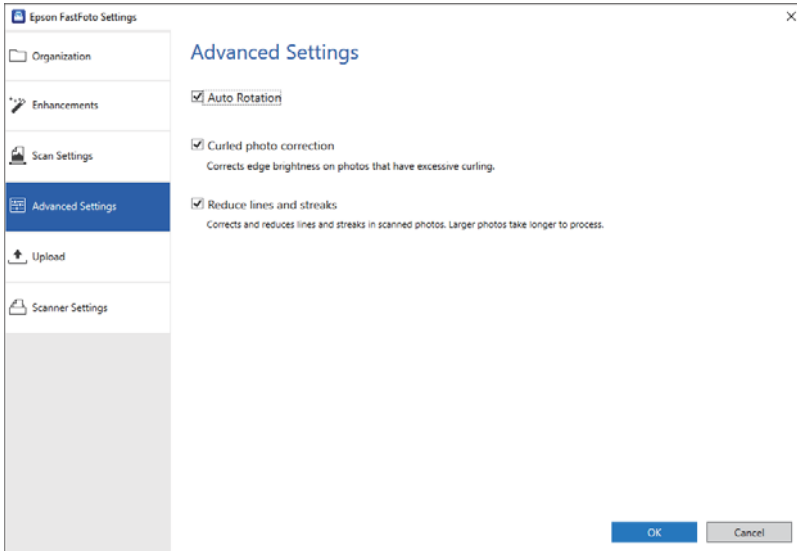



#### Auto Rotation

Automatically detects the orientation of the photos, and rotates them in the correct direction. Depending on the photos, they may not be rotated correctly.

#### Curled photo correction

Corrects edge brightness for photos with curled edges. Refer to the table below to enable or disable this adjustment.

|   |                                      |                    |
|---|--------------------------------------|--------------------|
|  | Photos curled to the backside        | Enable adjustment  |
|  | Photos curled to the printed surface | Disable adjustment |

Depending on the photos, they may not be adjusted correctly.

#### Reduce lines and streaks

Reduces the vertical lines or streaks of the scanned image caused by dirt on the glass surface inside the scanner.

If there is too much dirt on the scanner glass, lines and streaks may not be reduced correctly. Clean the scanner if a message appears prompting you to do so.

### Upload Tab

You can automatically upload the scanned image to a cloud service after scanning.

## Scanning Photos

Click the icons to enable auto uploading.

**Note:**

- ❑ *If you have not connected your account with Epson FastFoto, you will be prompted to do so.*
- ❑ *Make sure the Dropbox application is installed on your computer before uploading.*

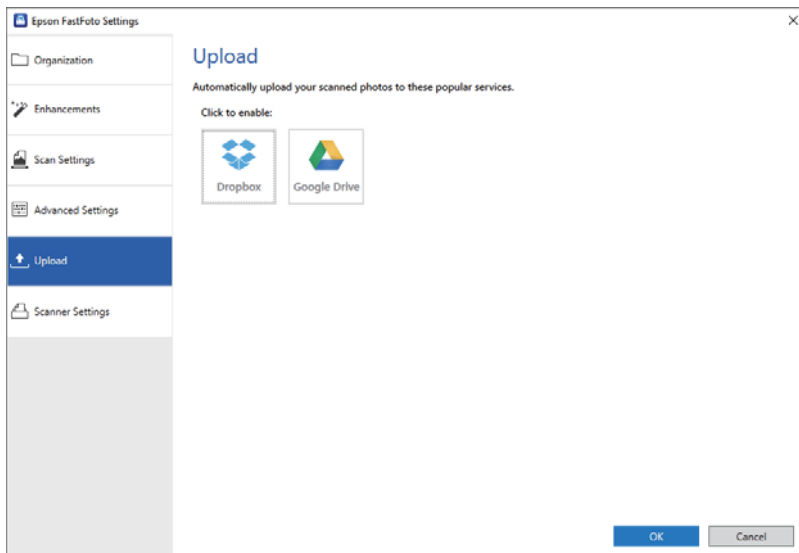

## Scanner Settings Tab

You can change the scanner settings, such as the scanner to use, the scanning application that starts when you press the scan button, or device settings.

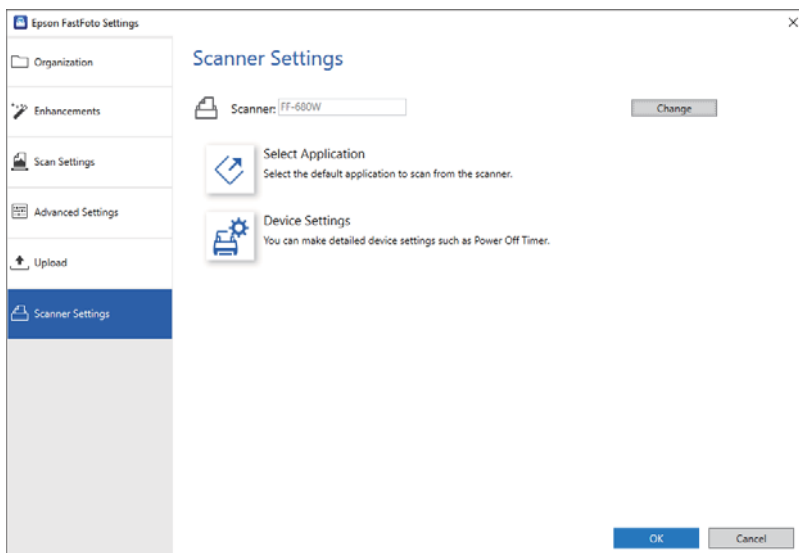

### Scanner

The scanner in use is displayed. If you want to use another scanner, click **Change**.

### Select Application

Selects the default application that starts when you press the scan button.

## Scanning Photos

### Device Settings

Sets the scanner device setting (power off timer, etc).



# Scanning Documents or Other Originals

You can scan documents or originals other than photos by using the computer application Epson ScanSmart or the smart device application Epson DocumentScan.

**Note:**

- ❑ You cannot scan photos using Epson ScanSmart or the smart device application Epson DocumentScan.
- ❑ Epson FastFoto is assigned to the scanner button as the default application. If you want to use Epson ScanSmart with the scanner button, change the settings.

## Related Information

- ➔ [“Changing the Application to Scan from the Scan Button” on page 47](#)  
You can change the default application that starts when you press the scan button.

---

## Placing Documents or Other Originals

### General Specifications for Originals being Scanned

| Type of Original   | Thickness   | Size  |
|--|---|---|
| Plain paper  | 37 to 413 g/m <sup>2</sup>                                      | Maximum: 215.9×6,096.0 mm<br>(8.5×240.0 in.)                    |
| Fine paper   | A8 size or less: 127 to 413 g/m <sup>2</sup>                    | Minimum: 50.8×50.8 mm (2.0×2.0 in.)                             |
| Recycled paper   | Plastic cards: 1.24 mm (0.05 in.) or less<br>(including emboss) | The loadable size varies depending on<br>the type of originals. |
| Post card  | Laminated Cards: 0.8 mm (0.03 in.) or<br>less                   |   |
| Business card  |   |   |
| Envelopes  |   |   |
| Plastic cards complying with ISO7810<br>ID-1 type (with or without emboss) |   |   |
| Laminated cards  |   |   |
| Thermal paper  |   |   |

## Scanning Documents or Other Originals

### Note:

- ❑ All originals must be flat at the leading edge.
- ❑ Make sure that curls on the leading edge of the originals are kept within the following range.
  - ① must be 3 mm or less.
  - ② must be 1 mm or less while ② is equal to or less than ③. When ③ is equal to or more than 10 times the size of ②, ② can be more than 1 mm.

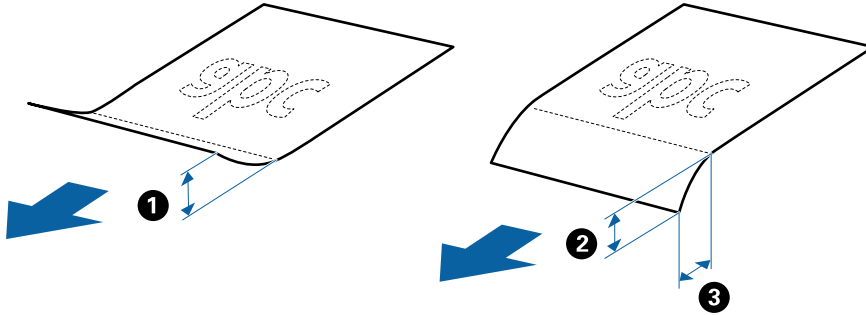

- ❑ Even when the original meets the specifications for originals that can be placed in the ADF, it may not feed from the ADF or the scan quality may decline depending on the paper properties or quality.

## Types of Originals that Require Attention

The following types of originals may not be successfully scanned.

- ❑ Originals with an uneven surface such as letter head paper.
- ❑ Originals with crinkles or fold lines
- ❑ Perforated originals
- ❑ Original with labels or stickers
- ❑ Carbon-less paper
- ❑ Curled originals
- ❑ Coated paper

### Note:

- ❑ Because carbon-less paper contains chemical substances that may harm the rollers, if paper jams occur frequently, clean the pickup roller and the separation roller.
- ❑ Crinkled originals may scan better if you slow down the feeding speed during scanning or smooth out the crinkles before loading.
- ❑ To scan delicate originals or originals that are easily crinkled, use the Carrier Sheet.
- ❑ To scan originals that are incorrectly detected as double feeds, press the  (Double Feed Detection Skip) button before scanning.

You can also disable double feed detection from Epson ScanSmart. Click  **Settings** > **Scanner Settings** tab > **Scan Settings** button > **Main Settings** tab on the Epson Scan 2 window, and then select **Off** in **Detect Double Feed**.

- ❑ Labels or stickers must be firmly stuck to the originals with no glue protruding.
- ❑ Try to flatten the curled originals before scanning.

## Scanning Documents or Other Originals

### Types of Originals that Must Not be Scanned

The following types of originals must not be scanned.

- Booklets
- Non-paper original (such as clear files, fabric, and metal foil)
- Originals with staples or paper clips
- Originals with glue attached
- Ripped originals
- Heavily wrinkled or curled originals
- Transparent originals such as OHP film
- Originals with carbon paper on the back
- Originals with wet ink
- Originals with sticky notes attached

**Note:**

- Do not feed valuable original artwork or important documents which you do not want to damage or deface into the scanner directly. Misfeeding may wrinkle or damage the original. When scanning such originals, make sure you use the Carrier Sheet.*
- Rippled, wrinkled, or curled originals can also be scanned if you use the Carrier Sheet.*

### Standard Size Originals

#### Specifications of Standard Size Originals

The list of the standard size originals you can load on the scanner.

## Scanning Documents or Other Originals

| Size          | Measurement                    | Thickness                   | Paper Type                                  | Loading Capacity *   |
|---------------|--------------------------------|-----------------------------|---|--|
| Legal         | 215.9×355.6 mm<br>(8.5×14 in.) | 37 to 413 g/m <sup>2</sup>  | Plain paper<br>Fine paper<br>Recycled paper | Thickness of the originals stack:<br>under 12 mm (0.47 in.)<br>80 g/m <sup>2</sup> : 80 sheets<br>90 g/m <sup>2</sup> : 69 sheets<br>104 g/m <sup>2</sup> : 59 sheets<br>127 g/m <sup>2</sup> : 50 sheets<br>157 g/m <sup>2</sup> : 40 sheets<br>209 g/m <sup>2</sup> : 30 sheets<br>256 g/m <sup>2</sup> : 24 sheets<br>413 g/m <sup>2</sup> : 14 sheets<br>The loading capacity varies<br>depending on the paper type. |
| Letter        | 215.9×279.4 mm<br>(8.5×11 in.) |                             |   | Thickness of the originals stack:<br>under 12 mm (0.47 in.)  |
| A4            | 210×297 mm<br>(8.3×11.7 in.)   |                             |   | 80 g/m <sup>2</sup> : 100 sheets   |
| B5            | 182×257 mm<br>(7.2×10.1 in.)   |                             |   | 90 g/m <sup>2</sup> : 86 sheets  |
| A5            | 148×210 mm<br>(5.8×8.3 in.)    |                             |   | 104 g/m <sup>2</sup> : 74 sheets   |
| B6            | 128×182 mm<br>(5.0×7.2 in.)    |                             |   | 127 g/m <sup>2</sup> : 62 sheets   |
| A6            | 105×148 mm<br>(4.1×5.8 in.)    |                             |   | 157 g/m <sup>2</sup> : 50 sheets   |
| A8            | 52×74 mm<br>(2.1×2.9 in.)      | 127 to 413 g/m <sup>2</sup> |   | 209 g/m <sup>2</sup> : 38 sheets   |
| Business Card | 55×89 mm<br>(2.1×3.4 in.)      | 210 g/m <sup>2</sup>        |   | 256 g/m <sup>2</sup> : 30 sheets   |
|               |                                |                             |   | 413 g/m <sup>2</sup> : 18 sheets   |
|               |                                |                             |   | The loading capacity varies<br>depending on the paper type.  |
|               |                                |                             |   | Thickness of the originals stack:<br>under 12 mm (0.47 in.)<br>30 sheets   |

\* You can refill the originals up to the maximum capacity during scanning.

## Scanning Documents or Other Originals

### Placing Standard Size Originals

1. Open the input tray and extend the input tray extension. Slide out the output tray, extend the output tray extension, and then raise the stopper.

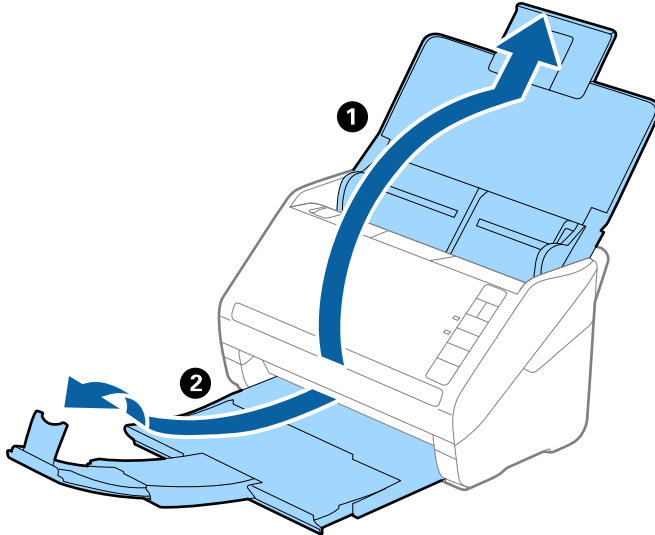

**Note:**

- ❑ For A4 size or larger originals, make sure you pull out and extend the input tray extension.
- ❑ Make sure you pull out and extend the output tray extensions so that they are a little bit longer than the length of the original, and raise the stopper so that the ejected originals can be stacked comfortably on the output tray.
- ❑ The stopper can move forward and backward on the output tray extension so that you can easily adjust the stopper position to the best position for the originals being scanned.
- ❑ If thick originals bump into the output tray and fall from it, store the output tray and do not use it to stack the ejected originals.
- ❑ If scanned images are still affected by ejected originals hitting the surface below the scanner, we recommend placing the scanner on the edge of a table where the ejected originals can drop freely and you can catch them.

2. Slide the edge guides on the input tray all the way out.

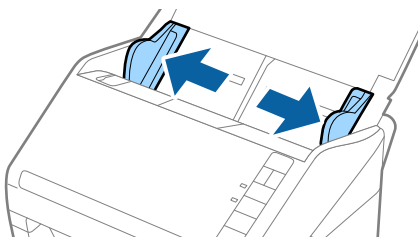

### Scanning Documents or Other Originals

3. Fan the originals.

Hold both ends of the originals and fan them a few times.

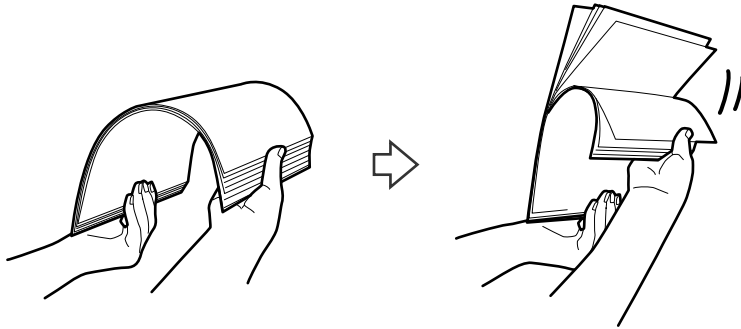

4. Align the edges of the originals with the printed side facing down and slide the leading edge into a wedge shape.

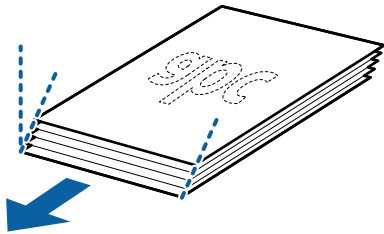

5. Load the originals into the input tray facing down with the top edge facing into the ADF. Slide the originals into the ADF until they meet resistance.

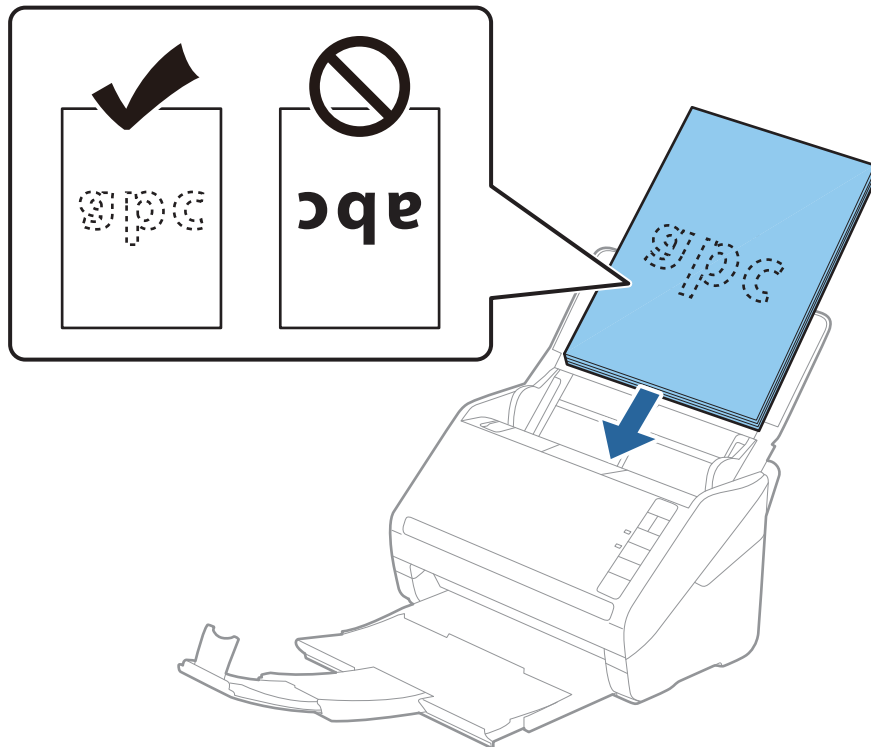

### Scanning Documents or Other Originals

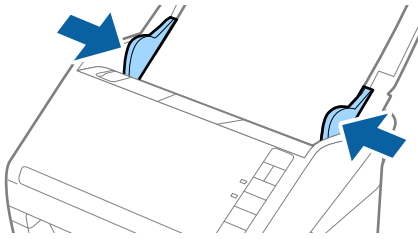

- Slide the edge guides to fit the edge of the originals making sure there are no gaps between the originals and the edge guides. Otherwise, the originals may be fed skewed.

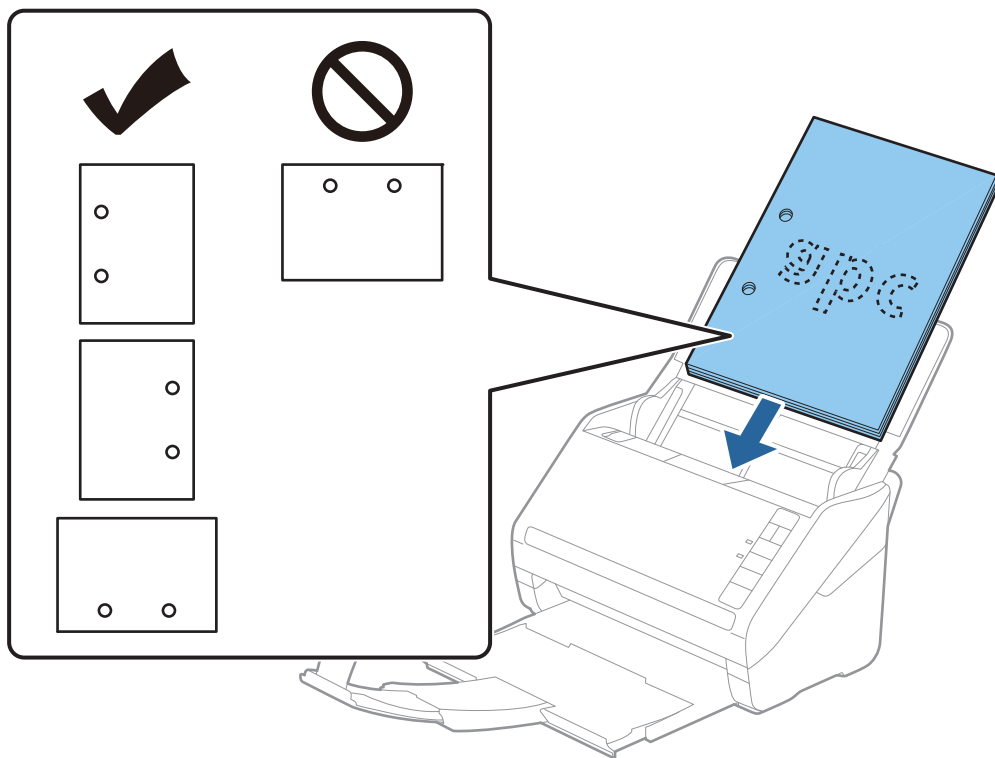

**Note:**

- When scanning originals with punch holes such as loose leaf paper, load the originals with the holes facing the side or facing down. There must not be any holes within a 30 mm (1.2 inches) strip at the center of the originals. However, there can be holes within 30 mm (1.2 inches) from the leading edge of the originals. Make sure that the edges of the punch holes do not have burrs or curls.



- When scanning thin paper with crinkles that are causing paper jams or double feeds, you may be able to improve the situation by pressing the  (Slow Mode) button to slow down the feeding speed. Pressing the  (Slow Mode) button once slows down the paper feeding speed; press it again to return to normal speed.

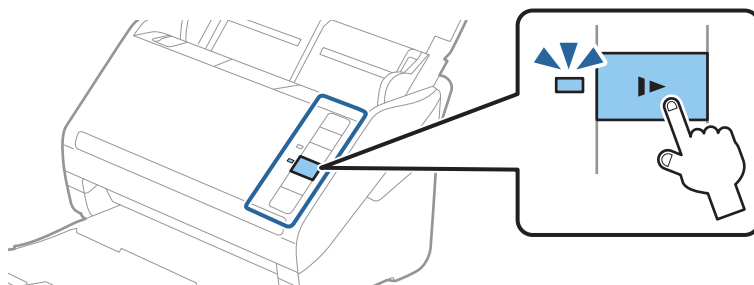

## Scanning Documents or Other Originals

### Related Information

- ➔ [“Scanning Documents from Computer \(Epson ScanSmart\)” on page 83](#)  
Using Epson ScanSmart, you can easily scan and save your documents.

## Long Paper

### Specifications of Long Paper

The specification of long paper you can load into the scanner.

| Size  | Thickness                  | Paper Type                                  | Loading Capacity |
|---|----------------------------|---|------------------|
| Width: 50.8 to 215.9 mm<br>(2.0 to 8.5 in.)<br>Length: 393.8 to 6,096.0 mm<br>(15.5 to 240.0 in.) | 50 to 130 g/m <sup>2</sup> | Plain paper<br>Fine paper<br>Recycled paper | 1 sheet          |

### Placing Long Paper

1. Open the input tray, and then slide out the output tray.

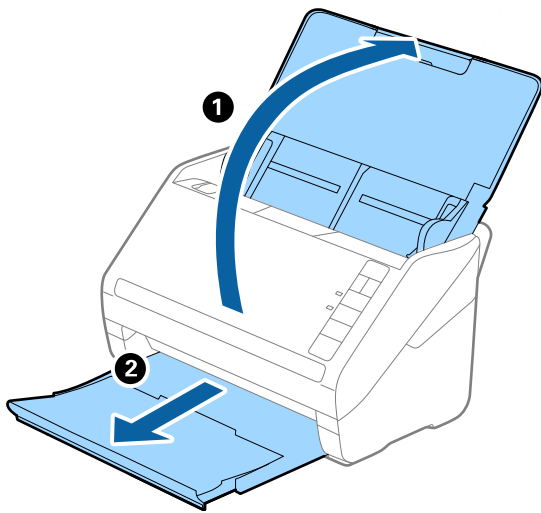

**Note:**

*Do not extend the input tray extension and output tray extensions and do not raise the stopper.*



## Scanning Documents or Other Originals

- Slide the edge guides on the input tray all the way out.

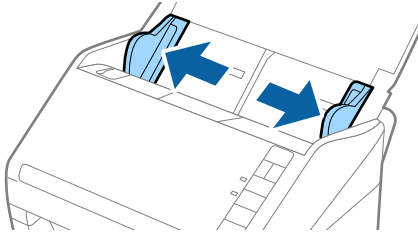

- Load the original straight into the input tray, facing down with the top edge facing into the ADF. Slide the original into the ADF until it meets resistance.

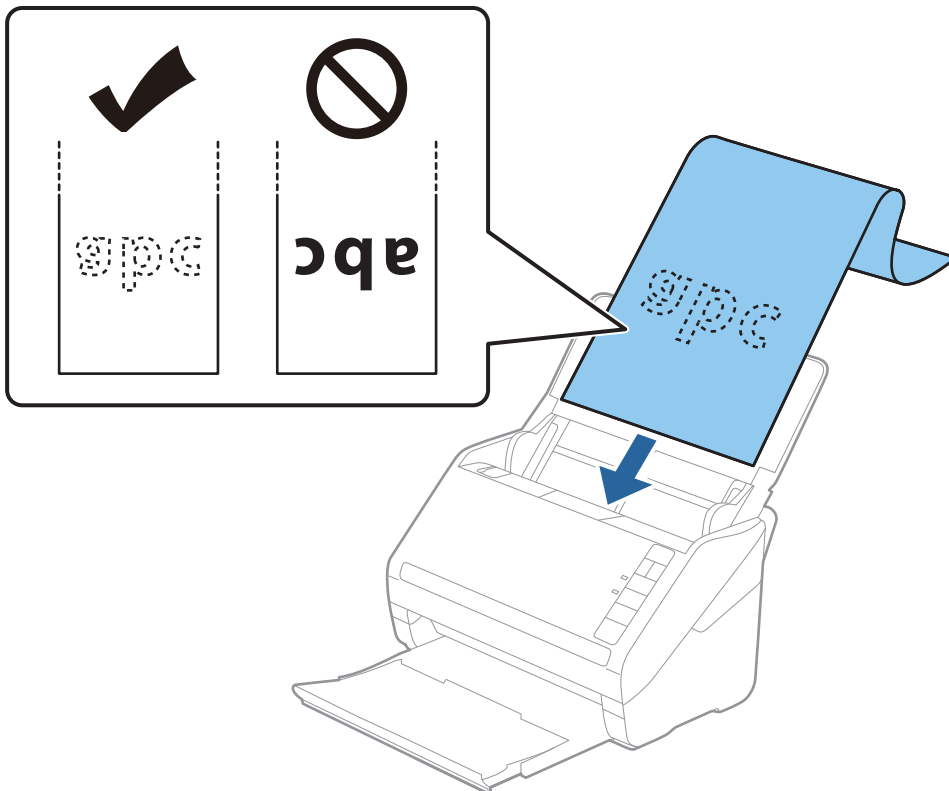

- Adjust the edge guides to fit the edge of the long paper making sure there are no gaps between the edge of the paper and the edge guides. Otherwise, the originals may be fed skewed.

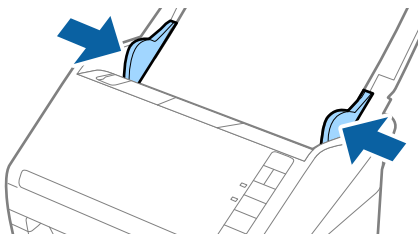

## Scanning Documents or Other Originals

### Note:

- ❑ You can scan long paper up to 5,461 mm (215 inches) in length with a resolution of 300 dpi or less, and over 5,461 mm (215 inches) to 6,096 mm (240 inches) with a resolution of 200 dpi or less.

- ❑ You need to specify the paper size using Epson ScanSmart. Click  **Settings** > **Scanner Settings** tab > **Scan Settings** button > **Main Settings** tab on the Epson Scan 2 window, and then set the **Document Size**.

If the paper length is 3,048 mm (120 inches) or less, you can select **Auto Detect (Long Paper)** to detect the size automatically.

If the paper length is more than 3,048 mm (120 inches), you need to select **Customize** and enter the size of the paper.

If the paper length is 5,461 mm (215 inches) or less, you can use **Detect paper length** instead of entering the paper height. If the paper is longer than 5,461 mm (215 inches), you need to enter both width and height size of the paper.

- ❑ Support the long paper at the input side so that it does not drop out of the ADF, and the output side so that the ejected paper does not fall from the output tray.

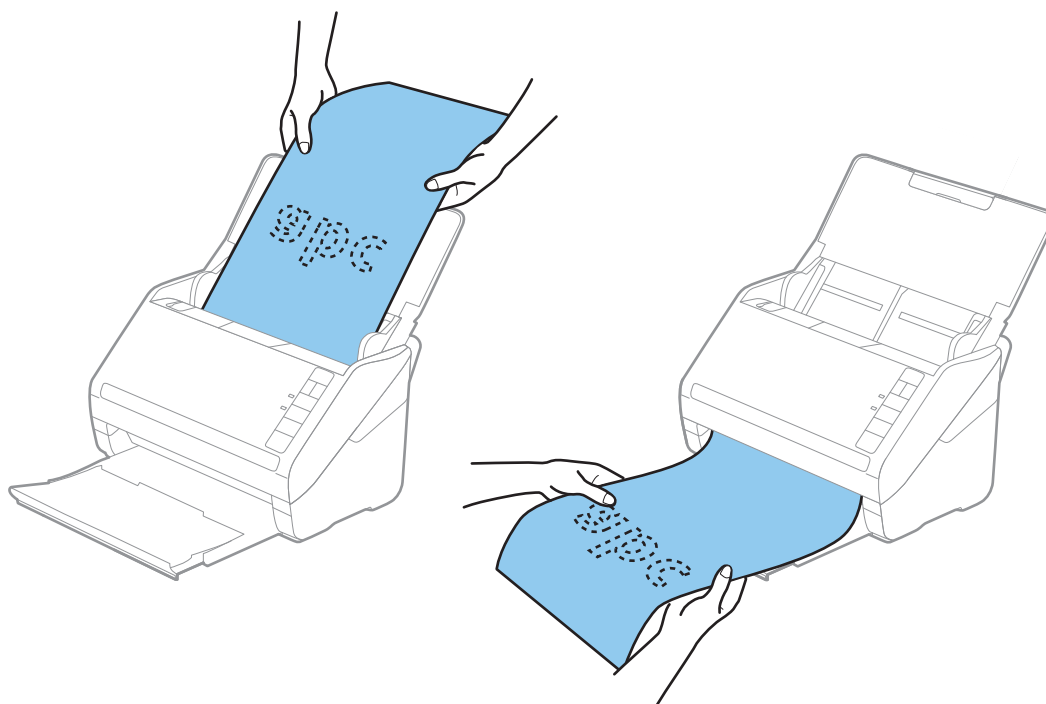

### Related Information

- ➔ [“Scanning Documents from Computer \(Epson ScanSmart\)” on page 83](#)  
Using Epson ScanSmart, you can easily scan and save your documents.
- ➔ [“Carrier Sheet Codes” on page 16](#)

## Plastic Cards

### Specifications of Plastic Cards

The specification of plastic card you can load into the scanner.

**Scanning Documents or Other Originals**

| Size   | Card Type         | Thickness                  | Loading Capacity | Loading Direction      |
|--|-------------------|----------------------------|------------------|------------------------|
| ISO7810 ID-1 Type<br>54.0×85.6 mm<br>(2.1×3.3 in.) | With embossing    | 1.24 mm (0.05 in.) or less | 1 card           | Horizontal (Landscape) |
|  | Without embossing | 0.76 mm (0.03 in.) or less | 5 cards          |                        |

**Placing Plastic Cards**

1. Open the input tray, and then slide out the output tray and raise the stopper.

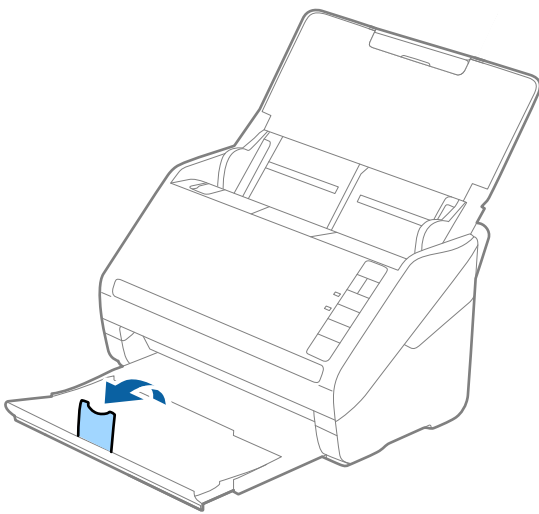

2. Slide the edge guides on the input tray all the way out.

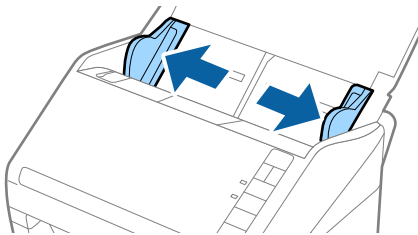

### Scanning Documents or Other Originals

3. Load the plastic cards into the input tray facing down with the top edge facing into the ADF.  
Slide the plastic cards into the ADF until they meet resistance.

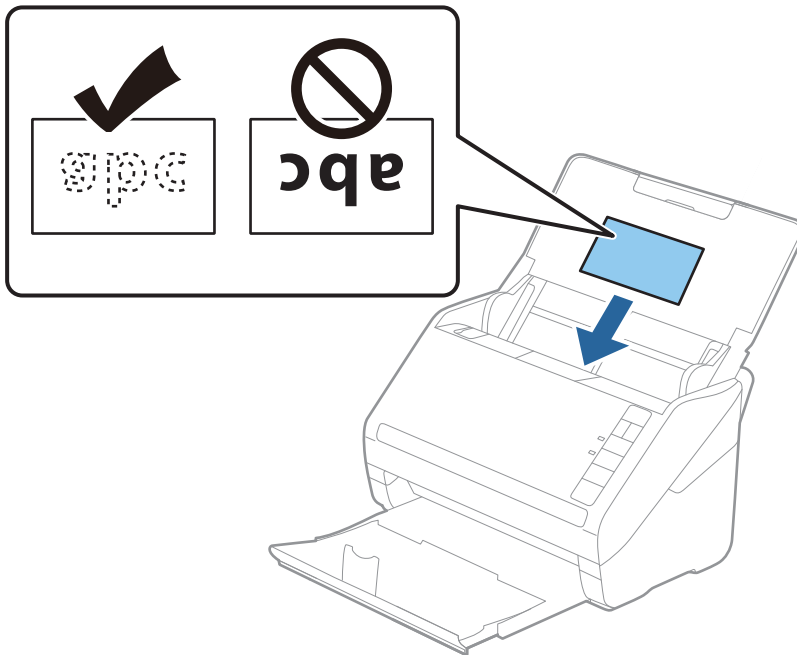

**!** *Important:*

*Do not load plastic cards vertically.*

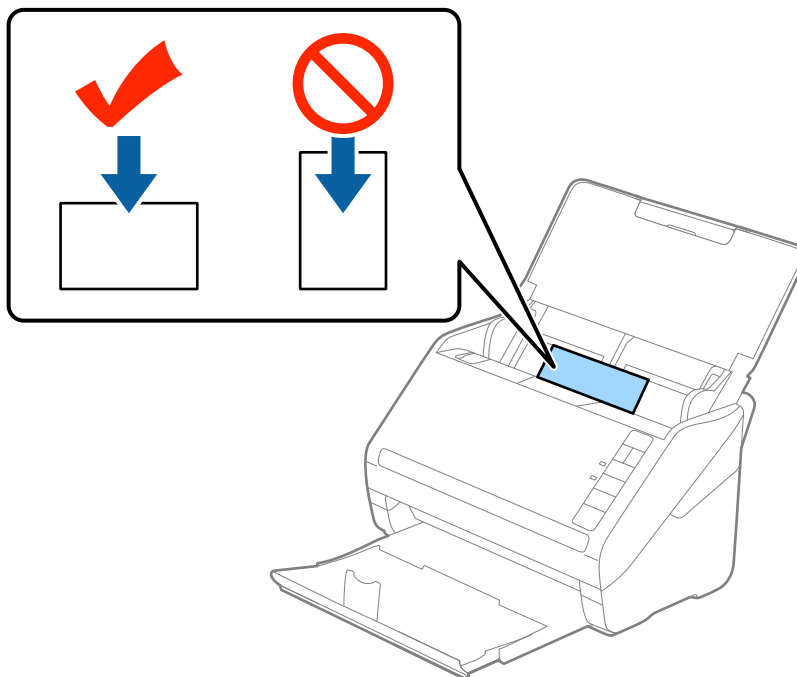

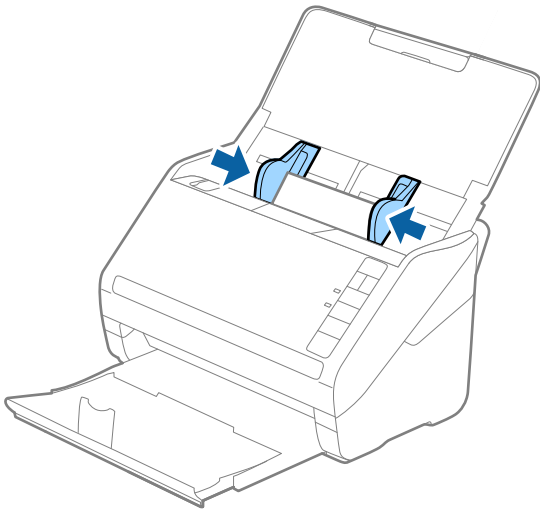

## Scanning Documents or Other Originals

- Slide the edge guides to fit the edge of the plastic cards.



**Note:**

To scan plastic cards, set the appropriate setting on Epson ScanSmart. Click  **Settings** > **Scanner Settings** tab > **Scan Settings** button > **Main Settings** tab on the Epson Scan 2 window, and then select **Plastic Card** in **Document Size** or set **Detect Double Feed** to **Off**.

If you forget to disable **Detect Double Feed** and a double feed error occurs, remove the card from the ADF and then reload it, press the  (Double Feed Detection Skip) button on the scanner as shown below to disable **Detect Double Feed** for the next scan, and then scan again. The  (Double Feed Detection Skip) button only disables **Detect Double Feed** for one sheet.

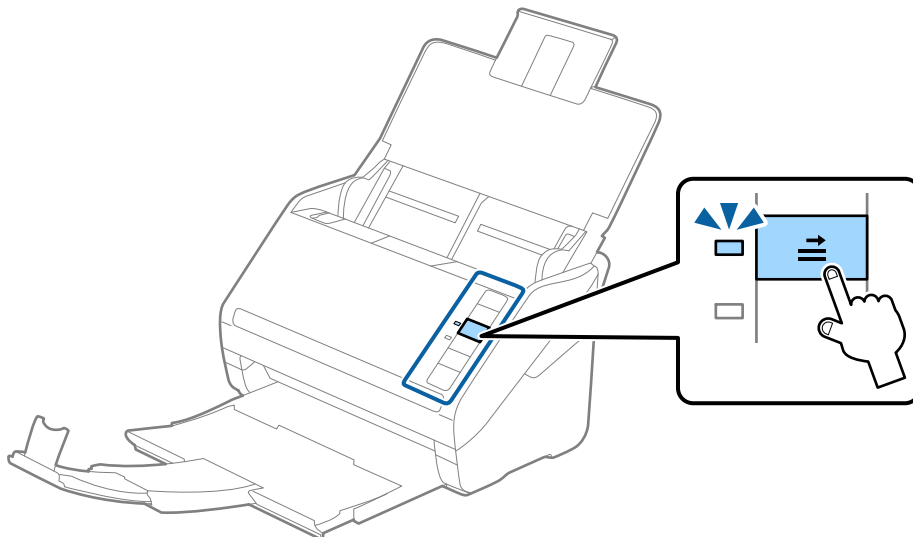

**Related Information**

- ➔ [“Scanning Documents from Computer \(Epson ScanSmart\)” on page 83](#)  
Using Epson ScanSmart, you can easily scan and save your documents.

## Laminated Cards

### Specifications of Laminated Cards

The specification of laminated cards you can load into the scanner.

| Size                                 | Thickness                 | Loading Capacity |
|--------------------------------------|---------------------------|------------------|
| 120.0×150.0 mm (4.7×5.9 in.) or less | 0.8 mm (0.03 in.) or less | 1 card           |

### Placing Laminated Cards

1. Open the input tray, and then slide out the output tray and raise the stopper.

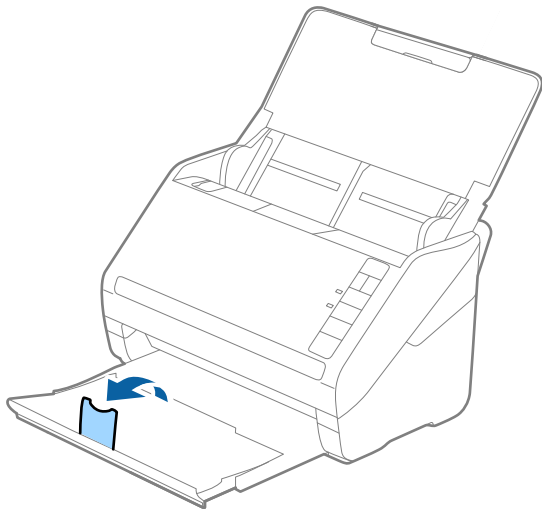

2. Slide the edge guides on the input tray all the way out.

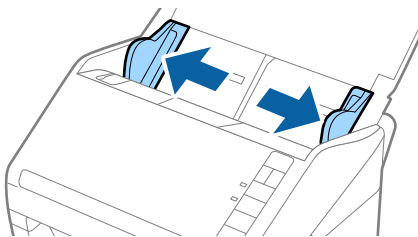

### Scanning Documents or Other Originals

3. Load the laminated cards into the input tray facing down with the top edge facing into the ADF. Slide the laminated cards into the ADF until they meet resistance.

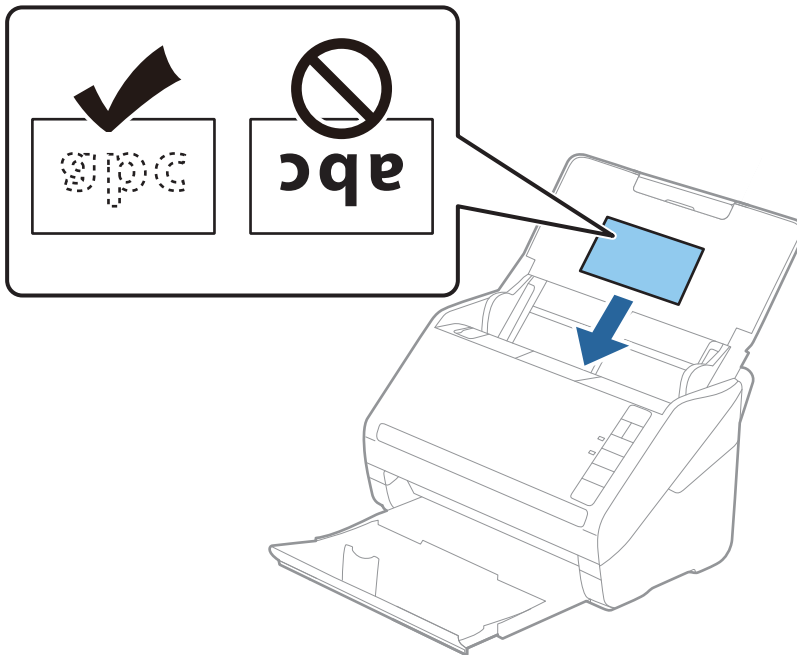

4. Slide the edge guides to fit the edge of the laminated cards.

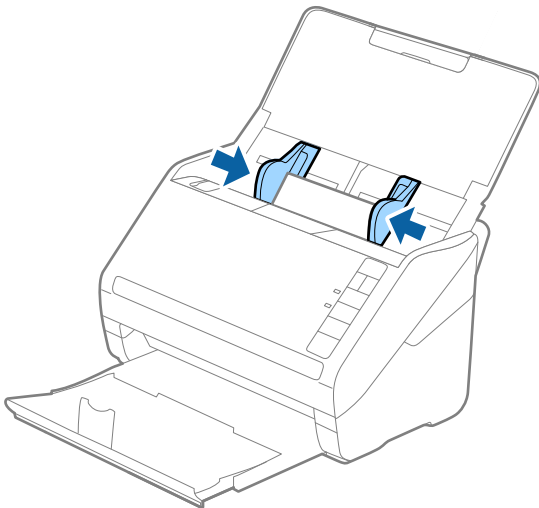



## Scanning Documents or Other Originals

### Note:

To scan laminated cards, set the appropriate setting on Epson ScanSmart to increase the accuracy of auto size detection.

Click  **Settings** > **Scanner Settings** tab > **Scan Settings** button > **Main Settings** tab on the Epson Scan 2 window > **Document Size** > **Settings**, and then select **Scan laminated card**.

Also, set **Detect Double Feed** to **Off**.

If you forget to disable **Detect Double Feed** and a double feed error occurs, remove the card from the ADF and then reload it, press the  (Double Feed Detection Skip) button on the scanner as shown below to disable **Detect Double Feed** for the next scan, and then scan again. The  (Double Feed Detection Skip) button only disables **Detect Double Feed** for one sheet.

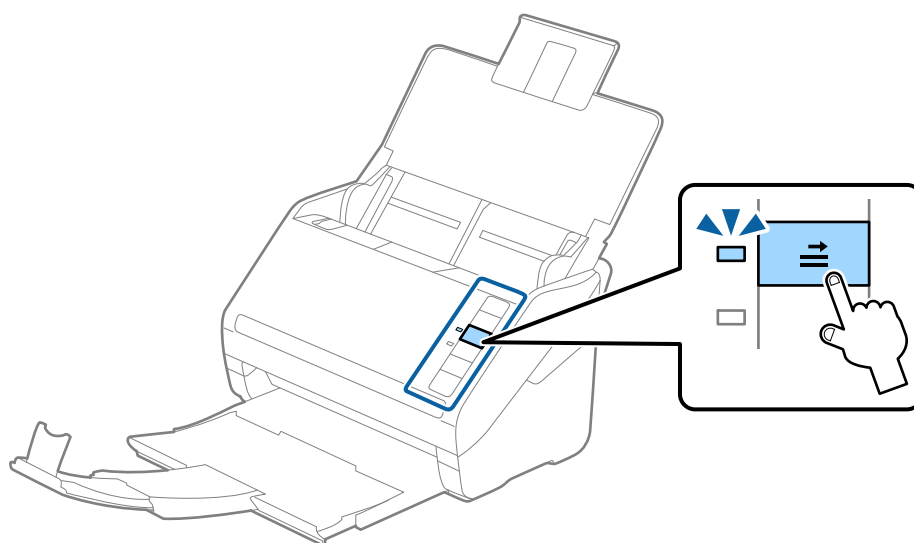

### Related Information

➔ [“Scanning Documents from Computer \(Epson ScanSmart\)” on page 83](#)

Using Epson ScanSmart, you can easily scan and save your documents.

## Large Size Originals

### Specifications of Large Size Originals

By using the Carrier Sheet and folding the originals in half, you can scan originals larger than A4 size, such as A3 or B4 sizes.

| Size     | Thickness  | Paper Type                                  | Loading Capacity of the Carrier Sheet |
|----------|--|---|---------------------------------------|
| Up to A3 | 0.3 mm (0.012 in.) or less<br>(excluding the thickness of the Carrier Sheet) | Plain paper<br>Fine paper<br>Recycled paper | 10 carrier sheets                     |



## Scanning Documents or Other Originals

### Placing Large Size Originals

1. Open the input tray and extend the input tray extension. Slide out the output tray, extend the output tray extension, and then raise the stopper.

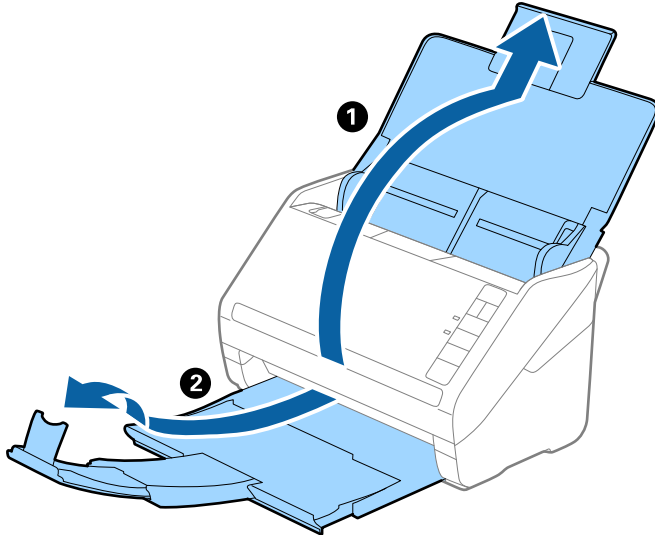

2. Slide the edge guides on the input tray all the way out.

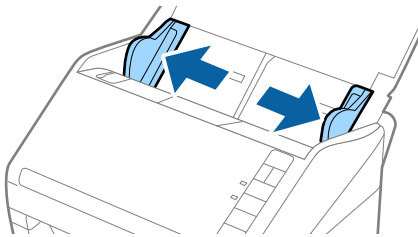

3. Place the Carrier Sheet with the illustration on the front edge facing up and place the original in the carrier sheet by folding it in half so that the side to be scanned is facing out, with the right side at the front.

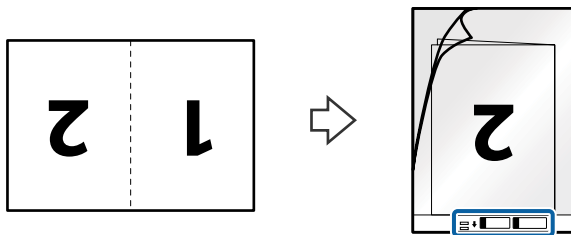

### Scanning Documents or Other Originals

4. Load the Carrier Sheet into the input tray with the top edge facing into the ADF.  
Slide the Carrier Sheet into the ADF until it meets resistance.

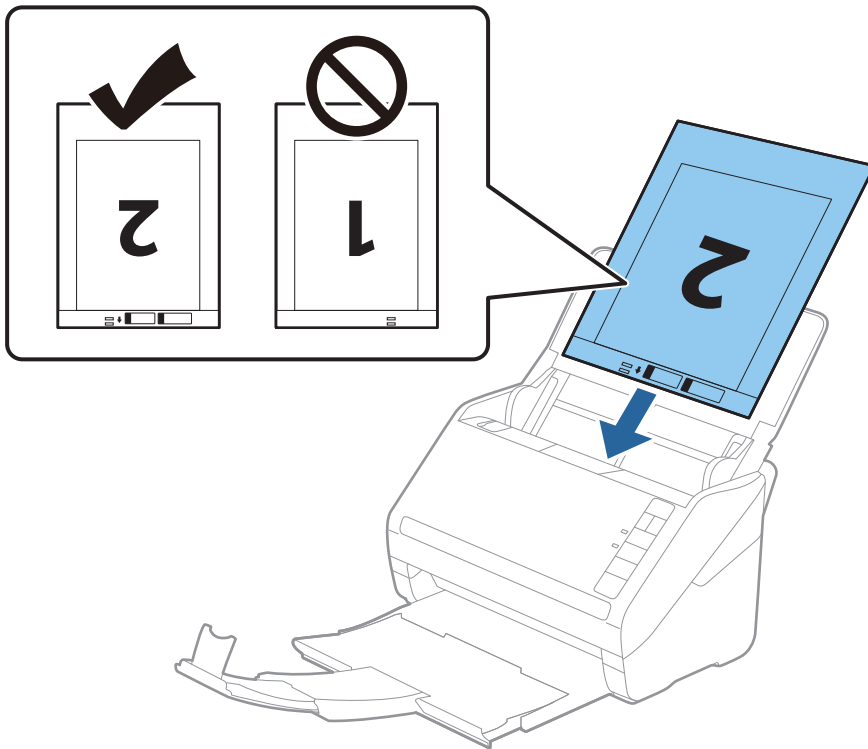

5. Slide the edge guides to fit the edge of the Carrier Sheet making sure there are no gaps between the Carrier Sheet and the edge guides. Otherwise, the carrier sheet may be fed skewed.

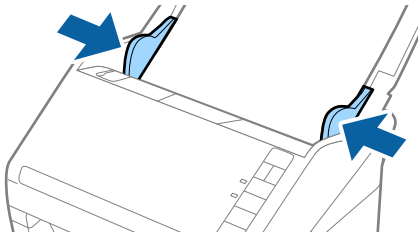

## Scanning Documents or Other Originals

### Note:

- ❑ You may need to stop using a Carrier Sheet that is scratched or has been scanned more than 3,000 times.
- ❑ To scan both sizes and stitch them together, set the appropriate setting in Epson ScanSmart. Click  **Settings** > **Scanner Settings** tab > **Scan Settings** button > **Main Settings** tab on the Epson Scan 2 window. Select **Double-Sided** as the **Scanning Side**, and then select **Left & Right** from **Stitch Images**.
- ❑ When scanning a Carrier Sheet by selecting **Auto Detect** as the **Document Size** setting on Epson ScanSmart, the image is automatically scanned by applying **Paper Skew** in the **Correct Document Skew** setting.

You can check the setting by clicking  **Settings** > **Scanner Settings** tab > **Scan Settings** button > **Main Settings** tab on the Epson Scan 2 window.

- ❑ The leading edge of the original must be placed at the binding part of the Carrier Sheet when scanning an original approximately 297 mm long. Otherwise, the length of the scanned image may be longer than intended as the scanner scans to the end of the Carrier Sheet when you select **Auto Detect** as the **Document Size** setting in Epson ScanSmart.
- ❑ Only use the Carrier Sheet designed for your scanner. The Carrier Sheet is automatically recognized by the scanner by detecting two small rectangular holes on the front edge. Keep the holes clean and not covered.

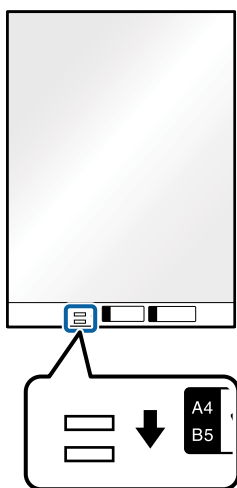

### Related Information

- ➔ [“Scanning Documents from Computer \(Epson ScanSmart\)” on page 83](#)  
Using Epson ScanSmart, you can easily scan and save your documents.

## Irregular Shaped Originals

### Specifications of Irregular Shaped Originals

By using the Carrier Sheet, you can scan originals that are wrinkled, curled, very thin, or irregularly shaped.

| Size     | Thickness  | Loading Capacity of the Carrier Sheet |
|----------|--|---------------------------------------|
| Up to A4 | 0.3 mm (0.012 in.) or less<br>(excluding the thickness of the Carrier Sheet) | 10 sheets                             |

## Scanning Documents or Other Originals

### Placing Irregular Shaped Originals

1. Open the input tray and extend the input tray extension. Slide out the output tray, extend the output tray extension, and then raise the stopper.

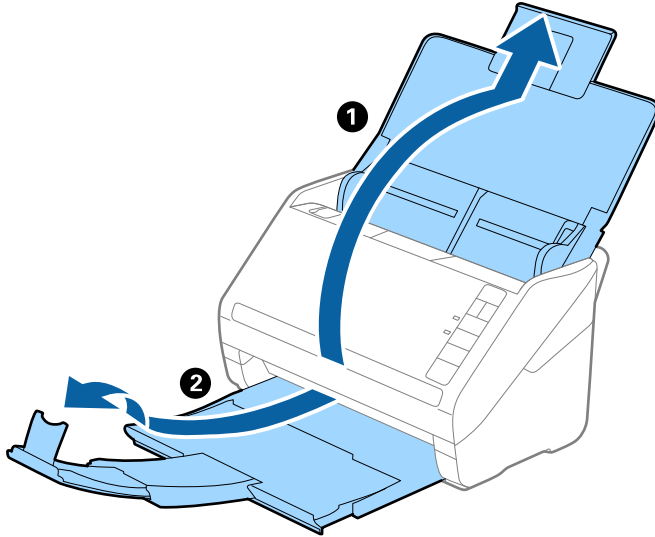

2. Slide the edge guides on the input tray all the way out.

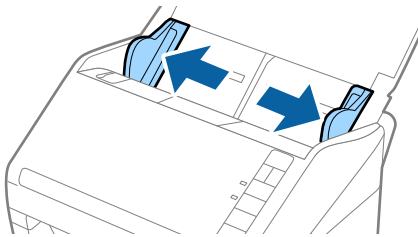

3. Place the Carrier Sheet with the illustration on the front edge facing up and place the original in the center of the Carrier Sheet with the side to be scanned facing down.

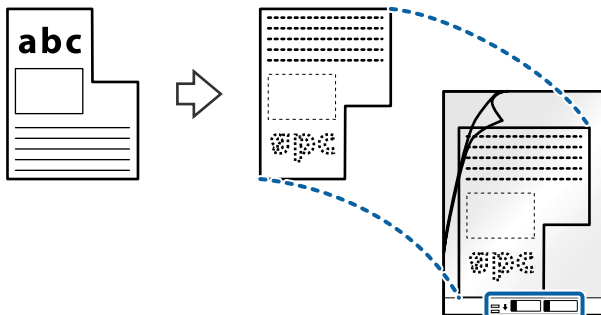

### Scanning Documents or Other Originals

4. Load the Carrier Sheet into the input tray with the top edge facing into the ADF.  
Slide the Carrier Sheet into the ADF until it meets resistance.

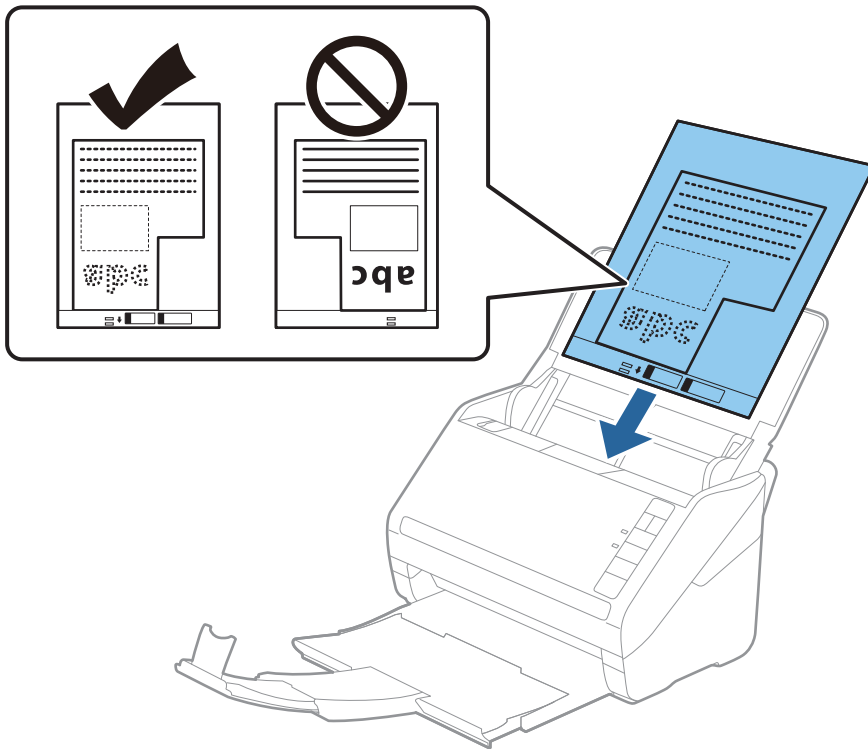

5. Slide the edge guides to fit the edge of the Carrier Sheet making sure there are no gaps between the Carrier Sheet and the edge guides. Otherwise, the carrier sheet may be fed skewed.

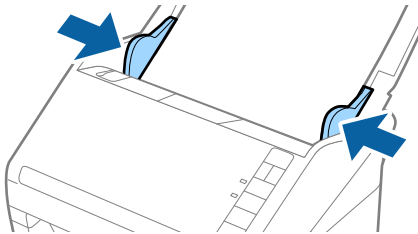

## Scanning Documents or Other Originals

### Note:

- ❑ You may need to stop using a Carrier Sheet that is scratched or has been scanned more than 3,000 times.
- ❑ You can set the size for the original using Epson ScanSmart. Click  **Settings** > **Scanner Settings** tab > **Scan Settings** button > **Main Settings** tab on the Epson Scan 2 window, and then set the **Document Size**.

If you cannot find an appropriate size for the original you want to scan in the **Document Size** list, select **Auto Detect** or select **Customize** to create a custom document size.

When scanning a Carrier Sheet by selecting **Auto Detect** as the **Document Size** setting, the image is automatically scanned by applying **Paper Skew** in the **Correct Document Skew** setting.

- ❑ Only use the Carrier Sheet designed for your scanner. The Carrier Sheet is automatically recognized by the scanner by detecting two small rectangular holes on the front edge. Keep the holes clean and not covered.

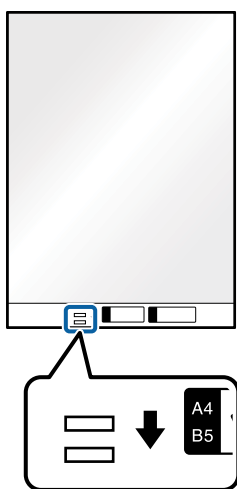

### Related Information

- ➔ [“Scanning Documents from Computer \(Epson ScanSmart\)” on page 83](#)  
Using Epson ScanSmart, you can easily scan and save your documents.
- ➔ [“Carrier Sheet Codes” on page 16](#)

## Envelopes

### Specifications of Envelopes

The specification of envelopes you can load into the scanner.

| Size | Measurement                                   | Thickness                   | Loading Capacity |
|------|---|-----------------------------|------------------|
| C6   | 114×162 mm (4.49×6.38 in.)<br>(standard size) | 0.38 mm (0.015 in.) or less | 10 envelopes     |
| DL   | 110×220 mm (4.33×8.66 in.)<br>(standard size) |                             |                  |

## Scanning Documents or Other Originals

### Placing Envelopes

1. Open the input tray and extend the input tray extension. Slide out the output tray, extend the output tray extension, and then raise the stopper.

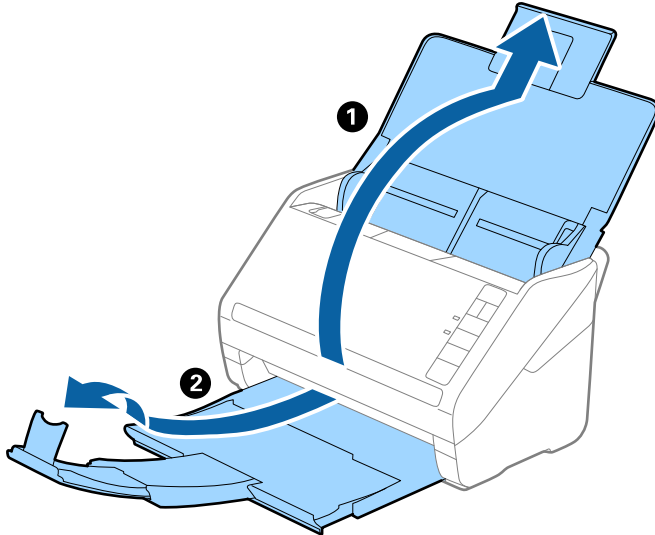

2. Slide the edge guides on the input tray all the way out.

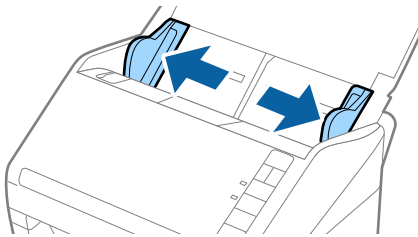

### Scanning Documents or Other Originals

3. Load the envelopes into the input tray facing down making sure that the opened edge (flap side) of the envelope is facing to the side. For envelopes with the opened edge (flap side) on the shorter side, you can load the envelope with the opened edge (flap side) facing up.

Slide the envelopes into the ADF until they meet resistance.

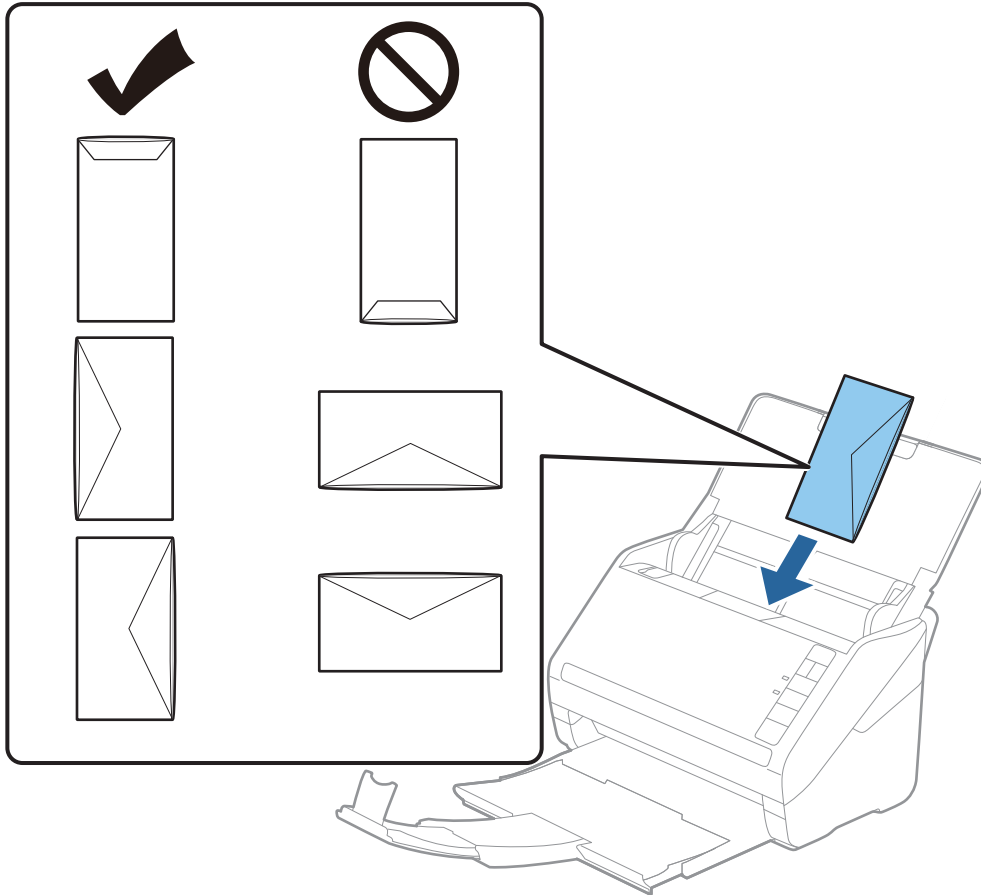

**!** **Important:**

*Do not load envelopes with adhesives on them.*

**Note:**

- Envelopes that are not opened by cutting sharply at the flap edge may not be scanned correctly.
- Envelopes that have not yet been sealed can be loaded with the flap open and facing up.



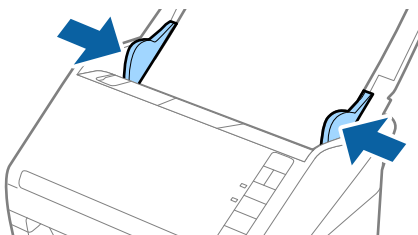

4. Slide the edge guides to fit the edge of the envelopes making sure there are no gaps between the envelopes and the edge guides. Otherwise, the envelopes may be fed skewed.





## Scanning Documents or Other Originals

### Note:

- ❑ To scan envelopes, we recommend selecting the appropriate rotation angle or **Auto** in **Rotate** in Epson ScanSmart before scanning. Click  **Settings** > **Scanner Settings** tab > **Scan Settings** button > **Main Settings** tab on the Epson Scan 2 window, and then set the **Rotate** setting.
- ❑ To scan envelopes, set **Detect Double Feed** to **Off** in Epson ScanSmart. Click  **Settings** > **Scanner Settings** tab > **Scan Settings** button > **Main Settings** tab on the Epson Scan 2 window, and then set **Detect Double Feed** to **Off**. If you forget to disable **Detect Double Feed** and a double feed error occurs, remove the envelope from the ADF and then reload it, press the  (Double Feed Detection Skip) button on the scanner as shown below to disable **Detect Double Feed** for the next scan, and then scan again. The  (Double Feed Detection Skip) button only disables **Detect Double Feed** for one sheet.

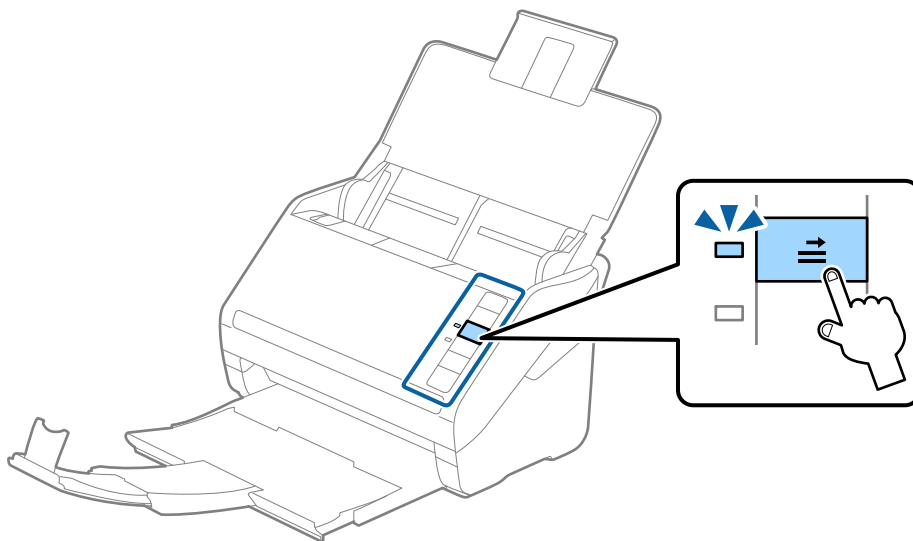

### Related Information

- ➔ [“Scanning Documents from Computer \(Epson ScanSmart\)” on page 83](#)  
Using Epson ScanSmart, you can easily scan and save your documents.

## Mixture of Originals

### Specifications of Originals that are a Mixture of Different Sizes

You can load a mixture of originals from 50.8×50.8 mm (2.0×2.0 in.) to A4 (or Letter) size. You can also load a mixture of paper types or thickness.

### Note:

- ❑ Depending on the combination of paper types or sizes, the originals may not be fed correctly and may be skewed or jammed. We recommend that you check the scanned image if the original was skewed.
- ❑ Alternatively, you can scan originals of different paper sizes and types by loading them one by one using **Automatic Feeding Mode**.

## Scanning Documents or Other Originals

### Placing a Mixture of Originals at Different Sizes

1. Open the input tray and extend the input tray extension. Slide out the output tray, extend the output tray extension, and then raise the stopper.

**Note:**

*If there are any thick originals amongst the originals, to stop the thick originals from bumping into the output tray and falling out, store the output tray and do not use it to stack the ejected originals.*

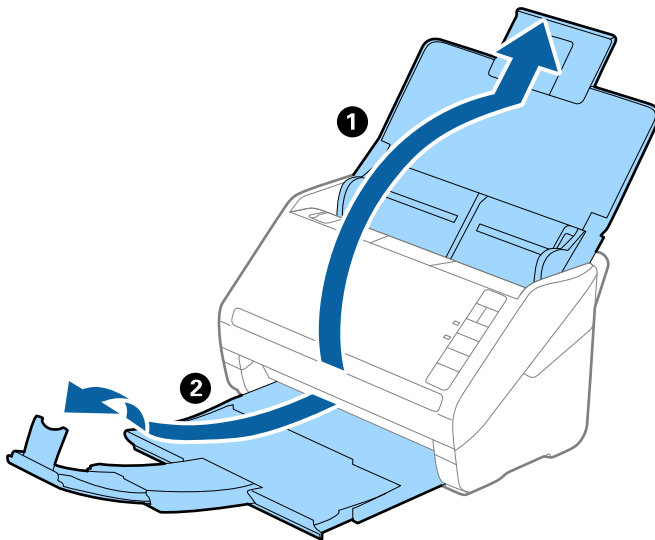

2. Slide the edge guides on the input tray all the way out.

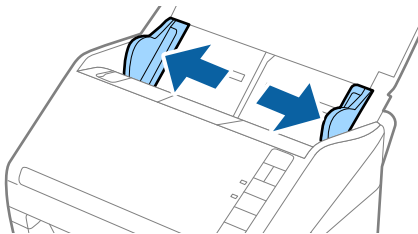

## Scanning Documents or Other Originals

- Load the originals at the center of the input tray in descending order of paper size with the widest at the back and the narrowest at the front.

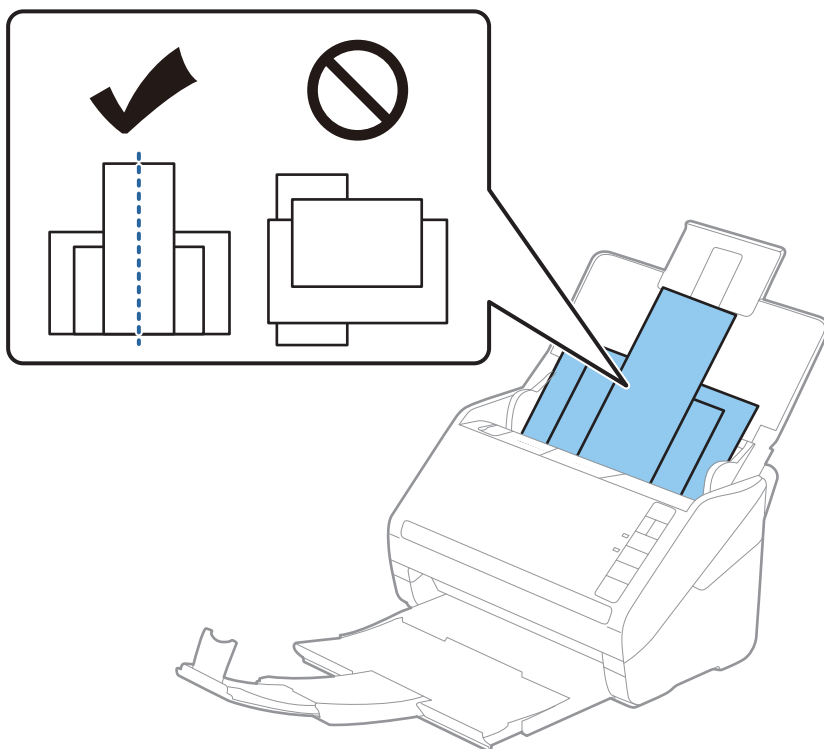

**Note:**

- Load the originals into the input tray facing down and slightly displace the top edges at an angle facing into the ADF.
  - Slide the originals into the ADF until they meet resistance.
  - You can stack the originals up to 8 mm (0.31 in.).
- Slide the edge guides to fit the edges of the widest original.

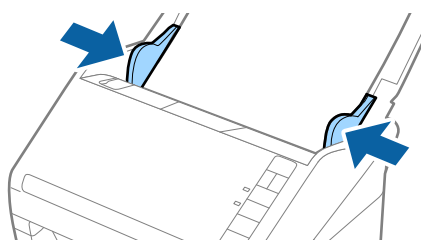

### Related Information

- ➔ [“Scanning Documents from Computer \(Epson ScanSmart\)” on page 83](#)  
Using Epson ScanSmart, you can easily scan and save your documents.

---

## Scanning Documents from Computer (Epson ScanSmart)

Using Epson ScanSmart, you can easily scan and save your documents.

## Scanning Documents or Other Originals

See the Epson ScanSmart help for details on how to use the application. This section explains how to scan and save to a PDF file.

1. Place the originals on your scanner.
2. Start Epson ScanSmart.
  - Windows 10  
Click the start button, and then select **Epson Software > Epson ScanSmart**.
  - Windows 8.1/Windows 8  
Enter the application name in the search charm, and then select the displayed icon.
  - Windows 7  
Click the start button, and then select **All Programs > Epson Software > Epson ScanSmart**.
  - Mac OS  
Open the **Applications** folder and select **Epson ScanSmart**.
3. Click **Scan double-sided** or **Scan single-sided**.

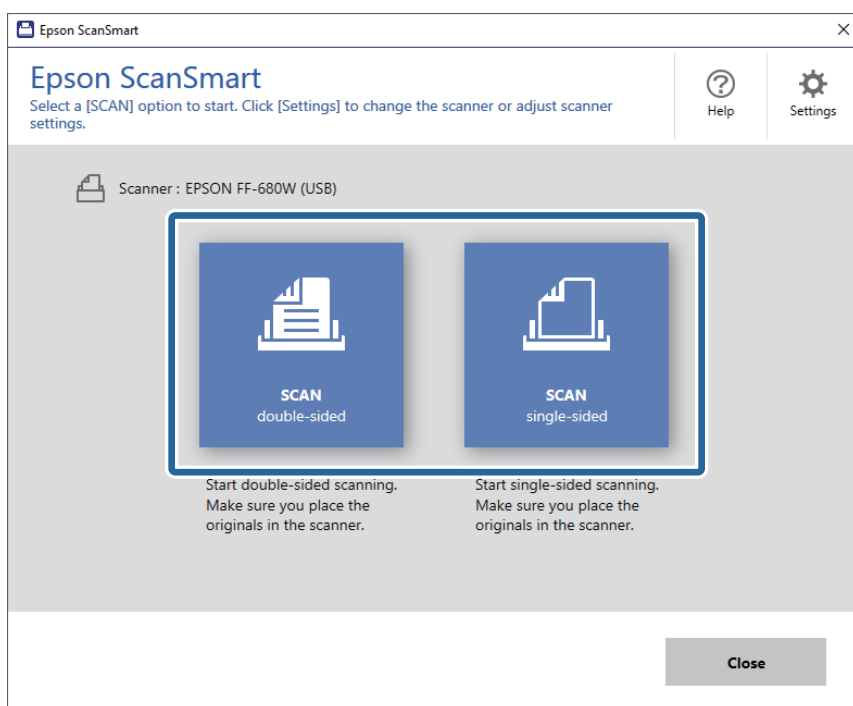

Scanning starts automatically.

4. Check the scanned images, and organize them if necessary.
  - You can also scan and add originals from **Scan more**.
  - You can use the buttons at the top of the screen to rotate scanned images.
  - You can choose to keep or discard the back sides of double-sided scanned images from **Include back sides**.

### Scanning Documents or Other Originals

- If you do not want to organize scanned images each time, select **Skip this screen next time..**

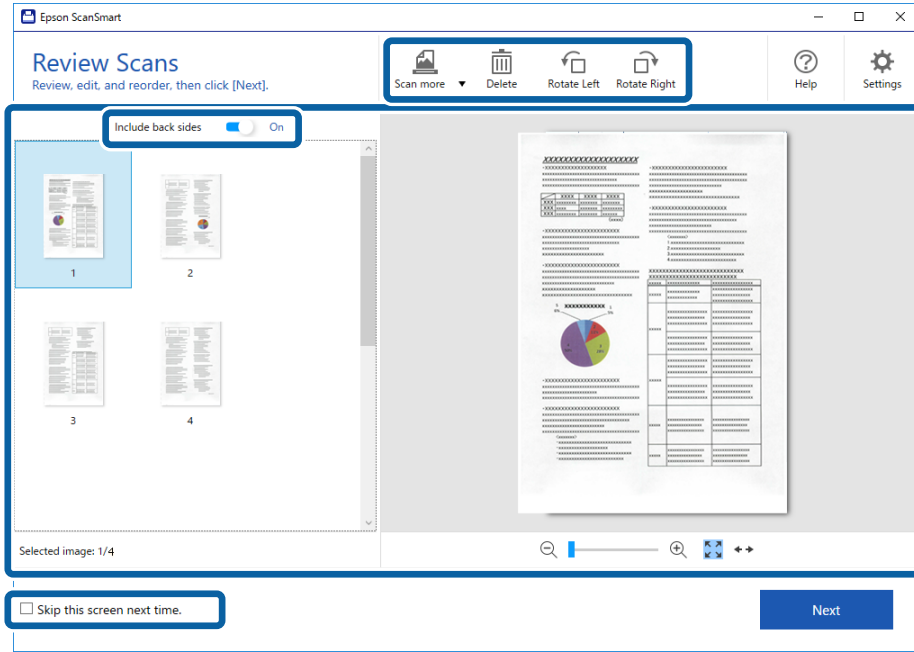

5. Click **Next**.

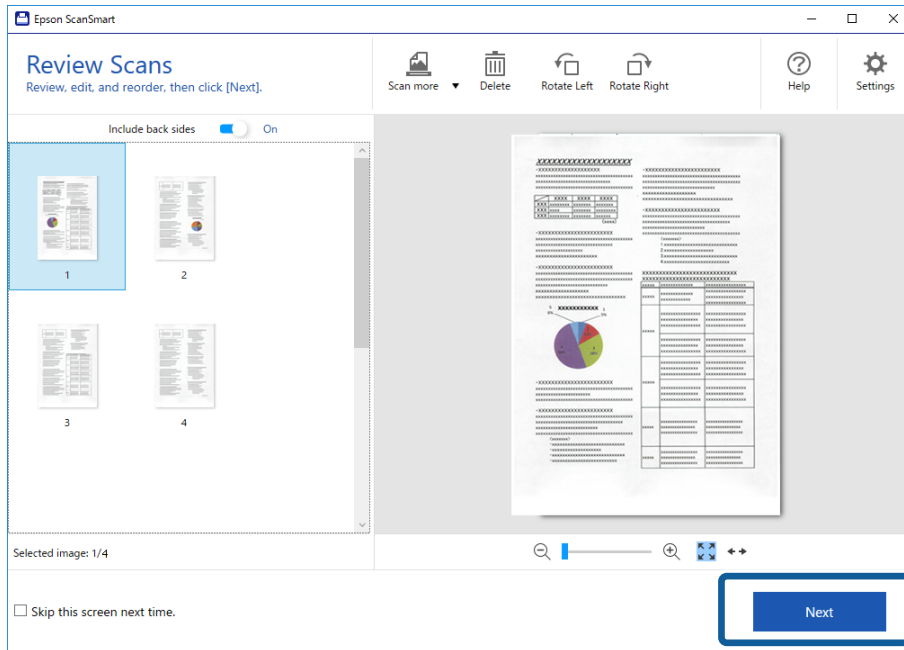

## Scanning Documents or Other Originals

- Click **Save** on the **Select Action** window.

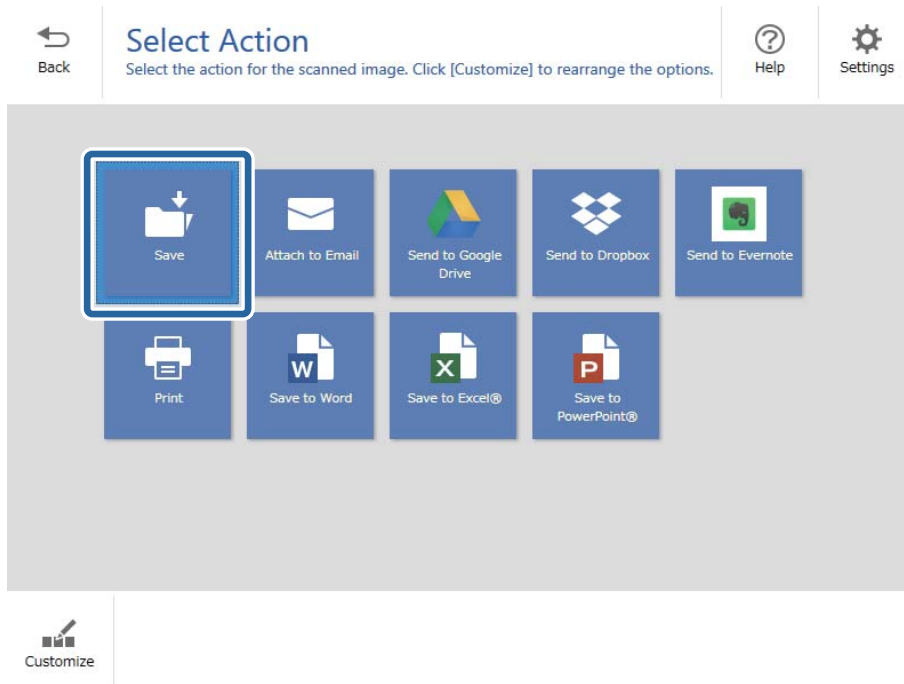

- Check or change the save settings as necessary.

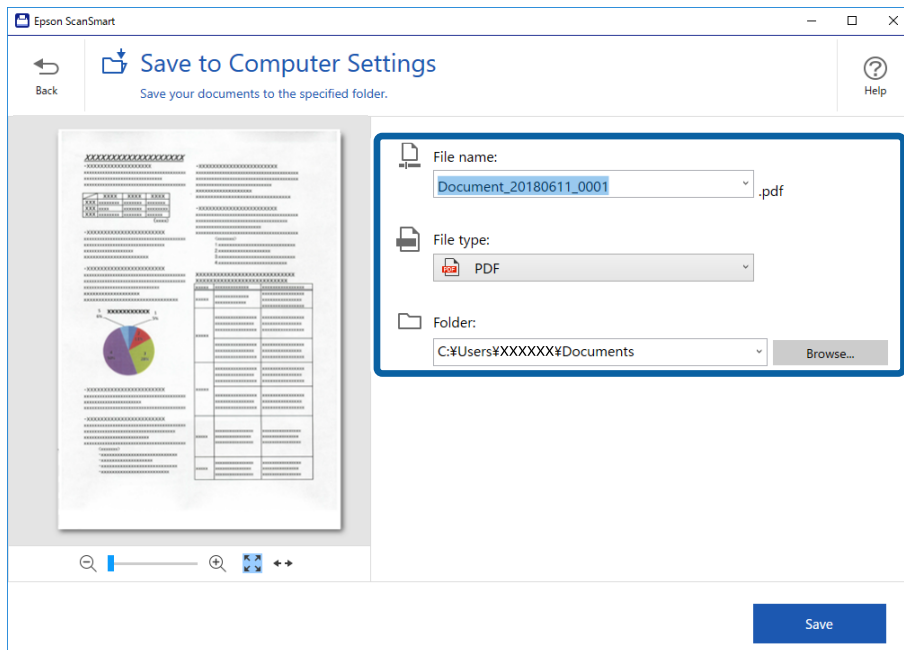

## Scanning Documents or Other Originals

8. Click **Save**.

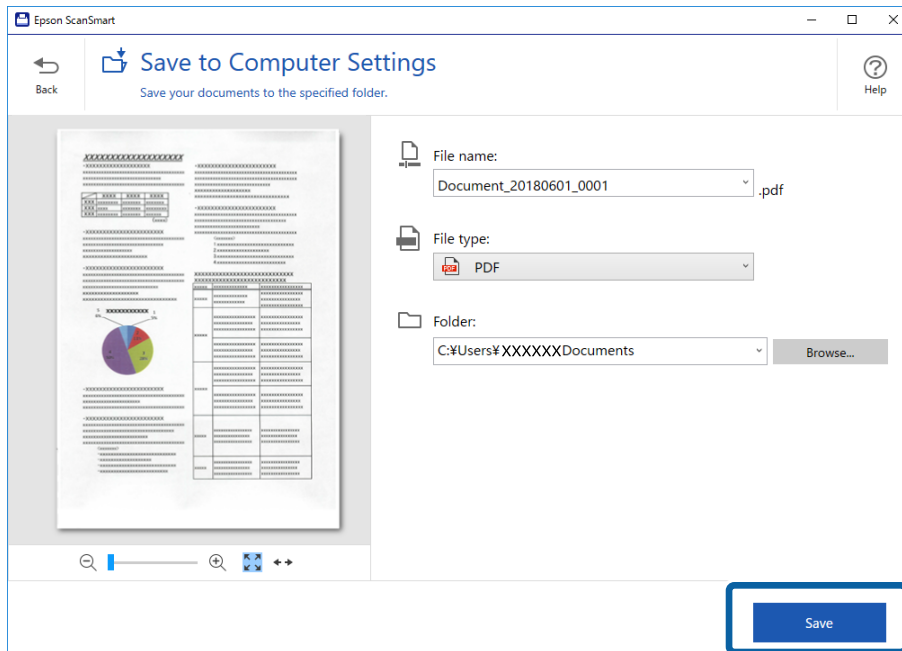

The scanned image is saved to the specified folder.

## Scanning Different Sizes or Types of Originals One by One Continuously (Automatic Feeding Mode)

You can scan different sizes or types of originals one by one using Automatic Feeding Mode. In this mode, the scanner starts scanning automatically when originals are loaded into the scanner.

1. Start Epson ScanSmart.
2. Click  **Settings**.

## Scanning Documents or Other Originals

3. Click **Scan Settings** on the **Scanner Settings** tab.

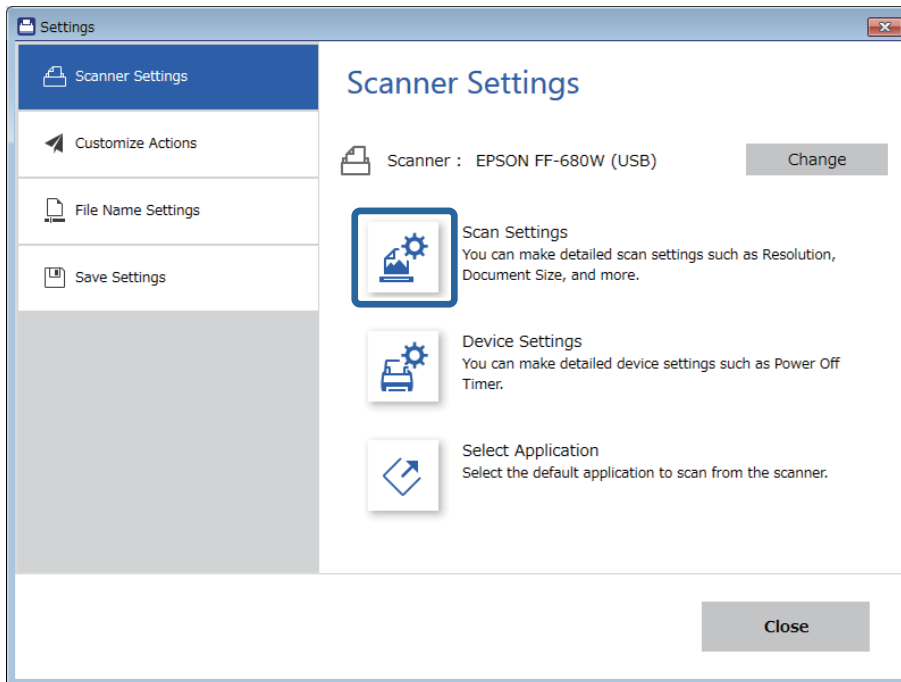

The **Epson Scan 2** window is displayed.



## Scanning Documents or Other Originals

4. Select **Automatic Feeding Mode** on the **Main Settings** tab.

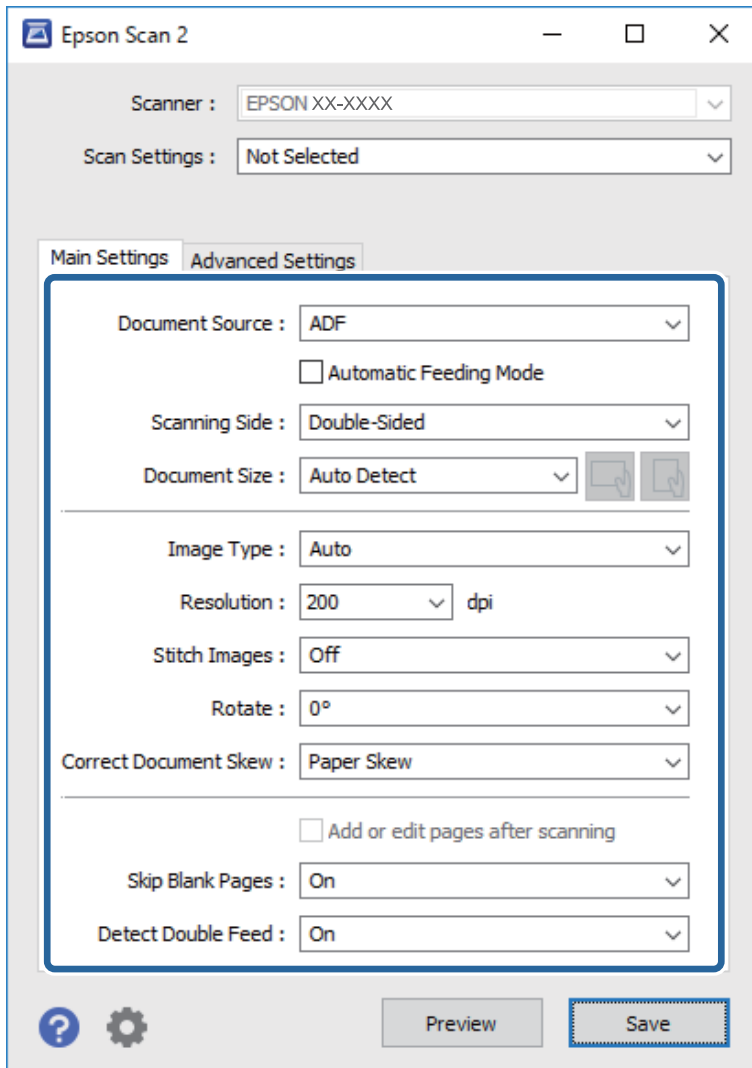

5. Make other settings for scanning on the Epson Scan 2 window.

**Note:**

You can make timeout settings to finish **Automatic Feeding Mode**.

Select **Settings** on the **Document Source** list to open the **Document Source Settings** window. Set **Automatic Feeding Mode Timeout (minutes)** on the window.

6. Click **Save** to close the Epson Scan 2 window.
7. Click **Close** to close the **Settings** window.
8. Click **Scan double-sided** or **Scan single-sided**.  
Automatic Feeding Mode starts.

## Scanning Documents or Other Originals

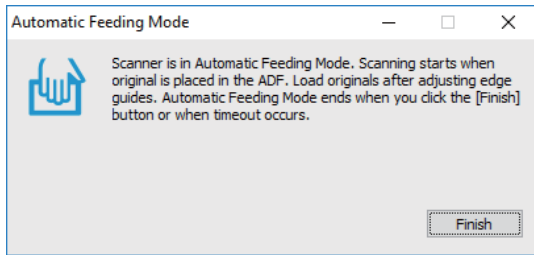

The  light on the scanner turns on, and the **Automatic Feeding Mode** window is displayed on your computer.



- Adjust the edge guides, and then place the original in the ADF.  
Scanning starts automatically.

- After scanning stops, place the next original in the ADF.  
Repeat this procedure until you have scanned all originals.

**Note:**

- If you want to scan originals that are detected as double feeds, for example plastic cards or envelopes, press the  button before placing the original to skip double feed detection.
- If you want to scan originals that are likely to jam, for example thin paper, press the  button before placing the original to slow down the scanning speed.

- After you have scanned all originals, press the  button on the scanner to close Automatic Feeding Mode.

**Note:**

You can also close Automatic Feeding Mode by pressing **Finish** on the **Automatic Feeding Mode** window displayed on your computer.

Follow the instructions of the Epson ScanSmart to save the scanned image.

---

## Scanning Documents from Smart Device (Epson DocumentScan)

**Note:**

- Epson DocumentScan only supports document scanning, not photo scanning.
- Connect the scanner to the smart device before scanning.

- Place the original.
- Start Epson DocumentScan.

## Scanning Documents or Other Originals

3. Tap **Scan**.

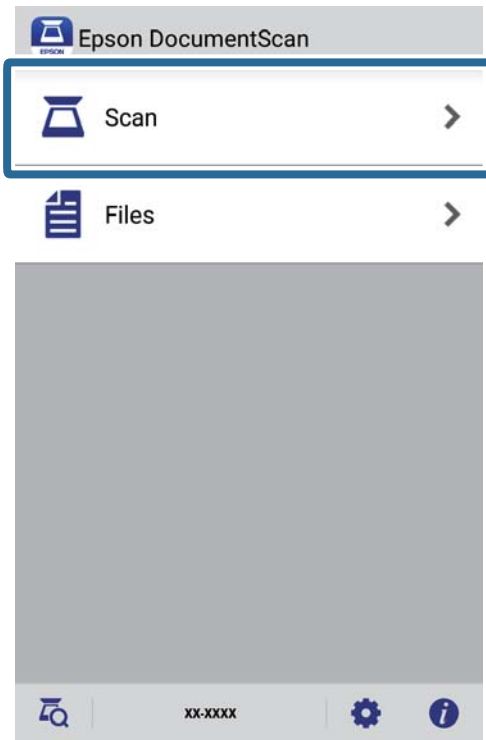

4. Make the scan settings.

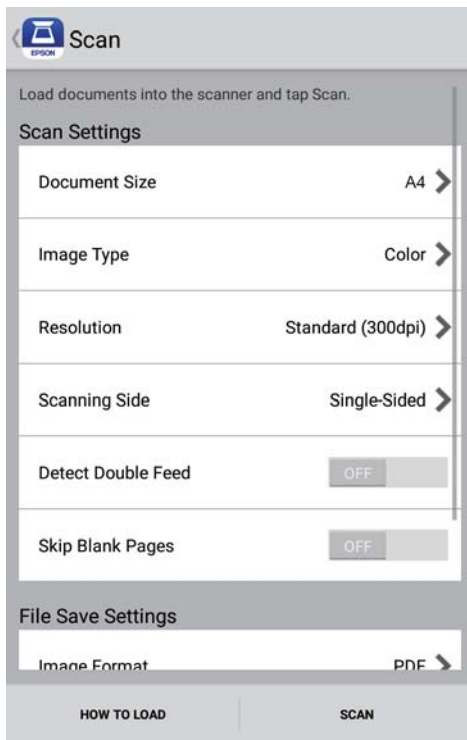

- ❑ **Document Size:** Select the size of the original you placed.
- ❑ **Image Type:** Select the color for saving the scanned image.
- ❑ **Resolution:** Select the resolution.

## Scanning Documents or Other Originals

- Scanning Side:** Select the side of the original you want to scan.
- Detect Double Feed:** Select to detect double feed when multiple originals are fed at the same time.
- Skip Blank Pages:** Select to skip blank pages if there are any in the originals.
- Image Format:** Select the save format from the list.
- Location:** Select the location to save the scanned image.
- File Name:** Check the settings for the file name.

5. Tap **Scan**.

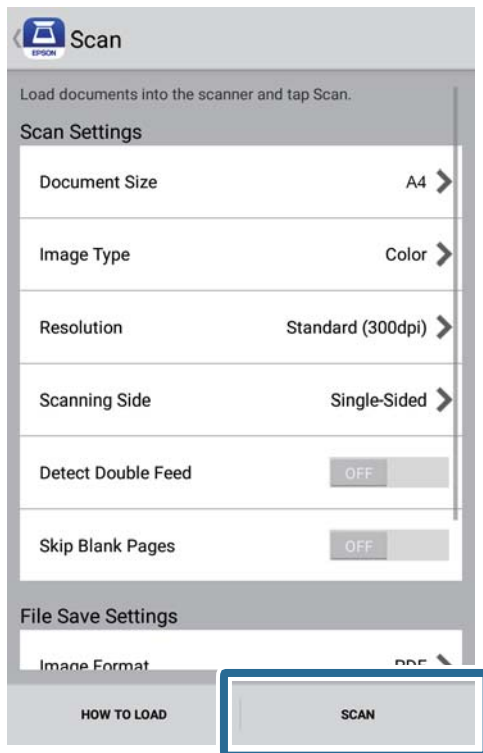

Scanning starts.

### Scanning Documents or Other Originals

6. Check the scanned image, and then tap **Done**.

**Note:**

To continue scanning, tap **Scan More**.

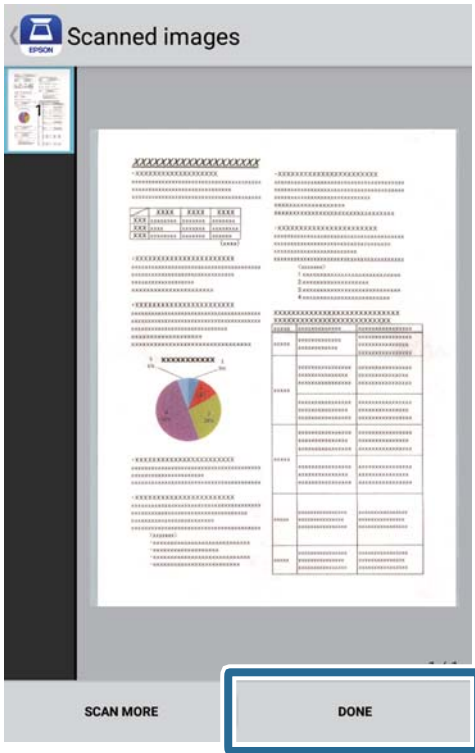

7. Tap **Save**.

**Note:**

You can rotate and sort the images by tapping the icons on the bottom of the screen.

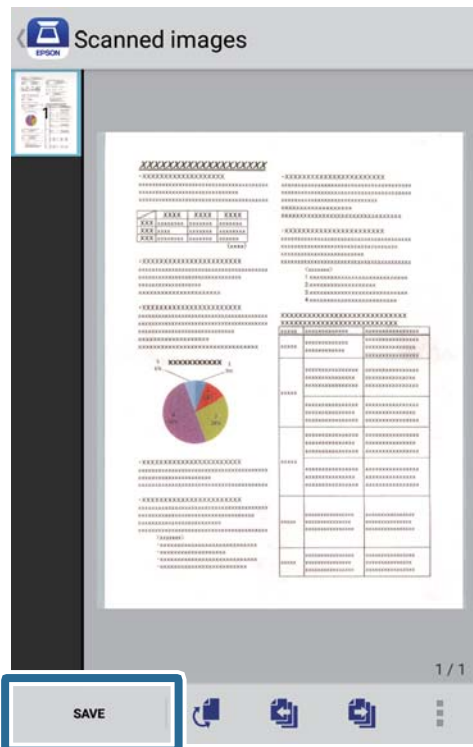

## Scanning Documents or Other Originals

The scanned image is saved to your storage device.

# Network Settings

---

## Network Connection Types

You can use the following connection methods.

### Wi-Fi Connection

Connect the scanner and the computer or smart device to the wireless router. This is the typical connection method for home or office networks where computers are connected by Wi-Fi through the wireless router.

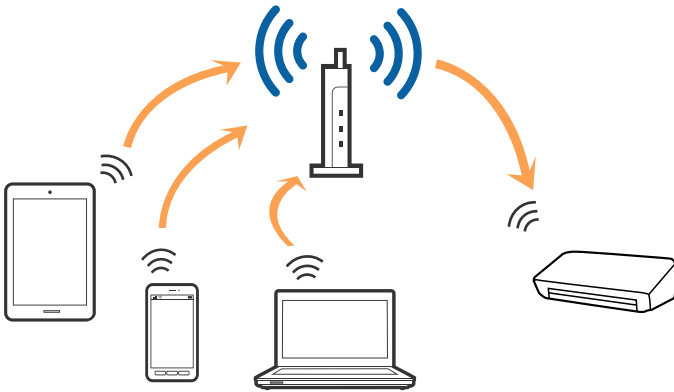

#### Related Information

- ➔ [“Connecting to a Computer” on page 96](#)
- ➔ [“Connecting to a Smart Device” on page 97](#)
- ➔ [“Making Wi-Fi Settings from the Control Panel” on page 97](#)

### Wi-Fi Direct (Simple AP) Connection

Use this connection method when you are not using Wi-Fi at home or at the office, or when you want to connect the scanner and the computer or smart device directly. In this mode, the scanner acts as a wireless router and you can connect the devices to the scanner without having to use a standard wireless router.

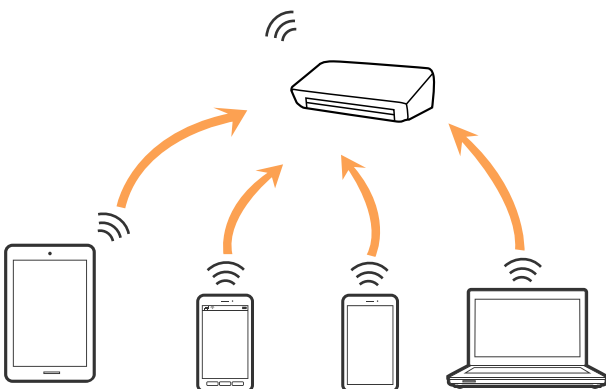

## Network Settings

The scanner can be connected by Wi-Fi and Wi-Fi Direct (Simple AP) connection simultaneously. However, if you start a network connection in Wi-Fi Direct (Simple AP) connection when the scanner is connected by Wi-Fi, the Wi-Fi is temporarily disconnected.

### Related Information

➔ [“Making AP Mode Settings” on page 98](#)

---

## Connecting to a Computer

We recommend using the installer to connect the scanner to a computer. You can run the installer using one of the following methods.

Setting up from the website

Access the following website, and then enter the product name.

<http://epson.sn>

Go to **Setup**, and then click **Download** in the download and connect part. Click or double-click the downloaded file to run the installer. Follow the on-screen instructions.

Setting up using the software disc (only for the models that come with a software disc and users with computers with disc drives.)

Insert the software disc into the computer, and then follow the on-screen instructions.

### Selecting the Connection Methods

Follow the on-screen instructions until the following screen is displayed, and then select the method for connecting the scanner to the computer.

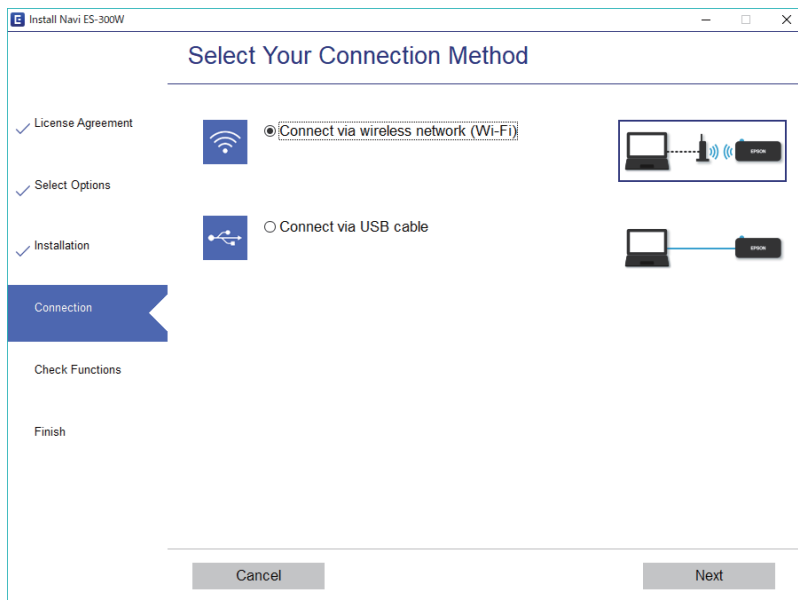

Select the connection type and then click **Next**. Follow the on-screen instructions.



---

## Connecting to a Smart Device

You can use the scanner from a smart device. To use the scanner from a smart device, set up from Epson DocumentScan.

**Note:**

*If you want to connect a computer and a smart device to the scanner at the same time, we recommend connecting the computer first.*

1. Search for Epson DocumentScan in the App Store or Google Play.
2. Download and install Epson DocumentScan.
3. Start Epson DocumentScan.
4. Follow the on-screen instructions to connect the scanner to your smart device.

---

## Making Wi-Fi Settings from the Control Panel

You can make network settings from the scanner's control panel. After connecting the scanner to the network, connect to the scanner from the device that you want to use (computer, smart phone, tablet, and so on.)

**Related Information**

- ➔ [“Making Wi-Fi Settings by Push Button Setup \(WPS\)” on page 97](#)
- ➔ [“Making Wi-Fi Settings by PIN Code Setup \(WPS\)” on page 98](#)
- ➔ [“Making AP Mode Settings” on page 98](#)

### Making Wi-Fi Settings by Push Button Setup (WPS)

You can automatically set up a Wi-Fi network by pressing a button on the access point. If the following conditions are met, you can set up by using this method.

- The access point is compatible with WPS (Wi-Fi Protected Setup).
- The current Wi-Fi connection was established by pressing a button on the access point.

**Note:**



*If you cannot find the button or you are setting up using the software, see the documentation provided with the access point.*

## Network Settings

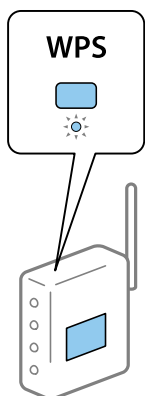
1. Hold down the [WPS] button on the access point until the security light flashes.





If you do not know where the [WPS] button is, or there are no buttons on the access point, see the documentation provided with your access point for details.

2. Press the  button on the scanner's control panel until the  light flashes blue (approximately 3 seconds).

The connection setting starts. The  light and  light flash alternately.



The  light is lit blue when connection is complete.

**Note:**

Connection fails when the  light turns on. After releasing the error by pressing the  button, restart the access point, move it closer to the scanner, and then try again.

## Making Wi-Fi Settings by PIN Code Setup (WPS)

You can automatically connect to an access point by using a PIN code. You can use this method to set up if an access point is capable of WPS (Wi-Fi Protected Setup). Use a computer to enter a PIN code into the access point.



1. Press the  button and the  button on the scanner's control panel simultaneously until  light flashes in blue (approximately 3 seconds).
2. Use your computer to enter the PIN code (an eight-digit number) on the label stuck to the scanner into the access point within two minutes.

The connection setting starts. The  light and  light flash alternately.

The  is lit blue when connection is complete.

**Note:**

See the manual provided with your access point for details on entering a PIN code.

Connection fails when the  light turns on. After releasing the error by pressing the  button, restart the access point, move it closer to the scanner, and then try again.



## Making AP Mode Settings

This method allows you to connect the scanner directly to devices without an access point. The scanner acts as an access point.

## Network Settings

**!** **Important:**

When you connect from a smart device to the scanner using the AP mode connection, the scanner is connected to the same Wi-Fi network (SSID) as the smart device and communication is established between them. Since the smart device is automatically connected to other connectable Wi-Fi networks if the scanner is turned off, it is not connected to the previous Wi-Fi network again if the scanner is turned on. Connect to the scanner's SSID in AP mode from the smart device again. If you do not want to connect every time you turn the scanner on or off, we recommend using a Wi-Fi network by connecting the scanner to an access point.

1. Press the  button on the scanner's control panel.  
The  light is lit blue when AP mode connection is enabled.
2. Connect from the smart device or computer to the scanner using the scanner's SSID and password.

**Note:**

- You can check the SSID and password on the label stuck to the scanner.
- See the documentation provided with your smart device or computer for the operating instructions.

---

## Checking the Network Status Using Network Light

You can check the network connection status using the network light on the scanner's control panel.

**Related Information**

- ➔ [“Lights” on page 13](#)
- ➔ [“Error Indicators” on page 14](#)

---

## Replacing or Adding New Wireless Routers

If the SSID changes due to the replacement of a wireless router, or a wireless router is added and a new network environment is established, re-set the Wi-Fi settings.

**Related Information**

- ➔ [“Changing the Connection Method to a Computer” on page 99](#)

---

## Changing the Connection Method to a Computer

Using the installer and re-set up in a different connection method.

- Setting up from the website

Access the following website, and then enter the product name.

<http://epson.sn>

Go to **Setup**, and then click **Download** in the download and connect part. Click or double-click the downloaded file to run the installer. Follow the on-screen instructions.

## Network Settings

- ❑ Setting up using the software disc (only for the models that come with a software disc and users with computers with disc drives.)

Insert the software disc into the computer, and then follow the on-screen instructions.

### Selecting Change the Connection Methods

Follow the on-screen instructions until the following screen is displayed.

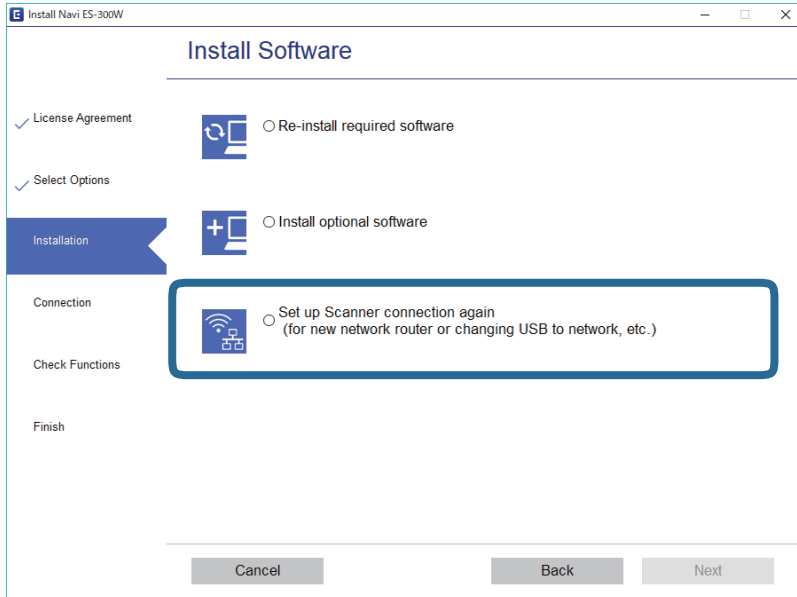



Select **Set up Scanner connection again (for new network router or changing USB to network, etc.)** on the Install Software screen, and then click **Next**. Follow the on-screen instructions.

---

## Disabling the Network Setting from the Control Panel

You can disable the network settings.

1. Press the  button for more than 3 seconds to disable a Wi-Fi and AP mode connection.

The  light and  light turn off when these are disabled.

**Note:**

Press the  button to re-connect Wi-Fi and AP mode.







---

## Restoring the Network Settings from the Control Panel

You can restore all network settings to their defaults.

1. Turn the scanner off.

## Network Settings

2. While holding down the  button, press the  button until  light and  light turn on simultaneously. The  light and  light flash alternately and then turn off when restoration is complete.

# Maintenance

---

## Cleaning Outside the Scanner

Wipe off any stains on the outer case with a dry cloth (like the microfiber cloth that came with your scanner) or a cloth dampened with mild detergent and water.

 **Important:**

- Never use alcohol, thinner, or any corrosive solvent to clean the scanner. Deformation or discoloration may occur.
- Do not let water get inside the product. This could cause a malfunction to occur.
- Never open the scanner case.

1. Press the  button to turn off the scanner.
2. Unplug the AC adapter from the scanner.
3. Clean the outer case with a cloth dampened with mild detergent and water.

---

## Cleaning Inside the Scanner

After using the scanner for a while, paper and room dust on the roller or the glass part inside the scanner may cause paper feed or scanned image quality problems. Clean the inside of the scanner if a message appears prompting you to do so. You can check the latest number of scans in Epson Scan 2 Utility.

**Note:**

- When you scan photos using Epson FastFoto, the message appears every 300 scans. When you scan documents using Epson ScanSmart, the message appears every 5,000 scans.
- You can also start Epson Scan 2 Utility from Epson FastFoto or Epson ScanSmart.  
Click **Settings** > **Scanner Settings** tab > **Device Settings**.

If a surface is stained with a hard-to-remove material, use a genuine Epson cleaning kit to remove stains. Use a small amount of cleaner on the cleaning cloth to remove the stains.

 **Important:**

- Never use alcohol, thinner, or any corrosive solvent to clean the scanner. Deformation or discoloration may occur.
- Never spray any liquid or lubricant on the scanner. Damage to equipment or circuits may cause abnormal operations.
- Never open the scanner case.

1. Press the  button to turn off the scanner.
2. Unplug the AC adapter from the scanner.

## Maintenance

3. Pull the cover open lever and open the scanner cover.

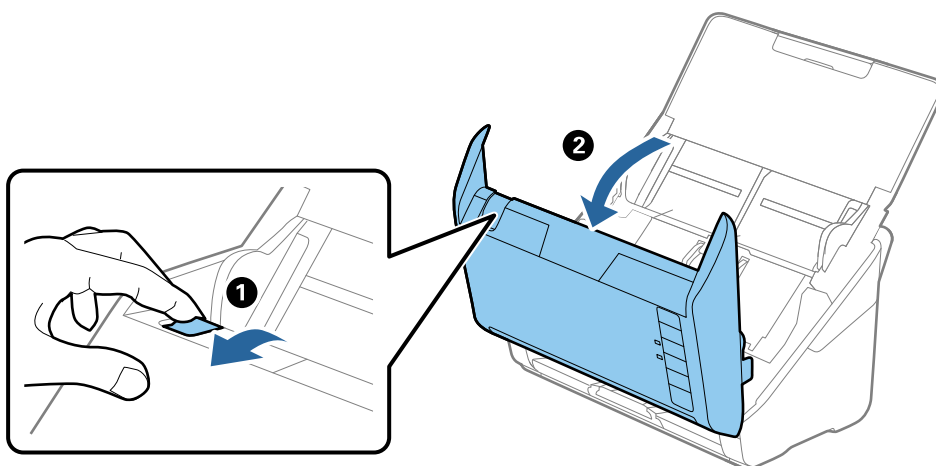

4. Wipe off any stains on the plastic roller and glass surface at the bottom inside of the scanner cover using a soft cloth (like the microfiber cloth that came with your scanner) or a genuine Epson cleaning kit.

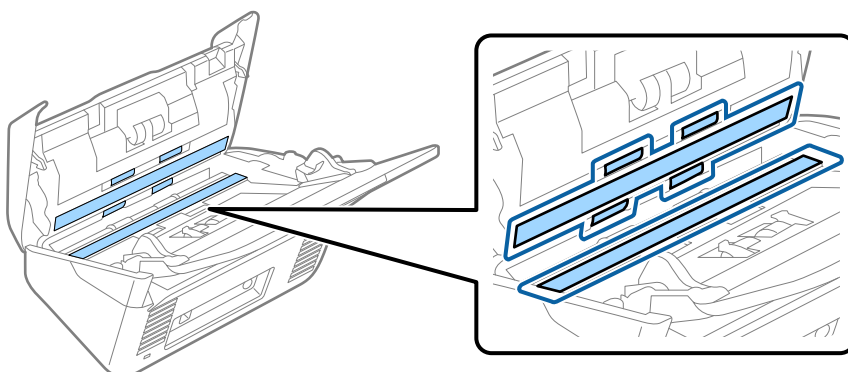

**!** **Important:**

- ❑ Do not place too much force on the glass surface.
- ❑ Do not use a brush or a hard tool. Any scratches on the glass may affect the scan quality.
- ❑ Do not spray cleaner directly onto the glass surface.

5. Wipe off any stains on the sensors with a cotton swab.

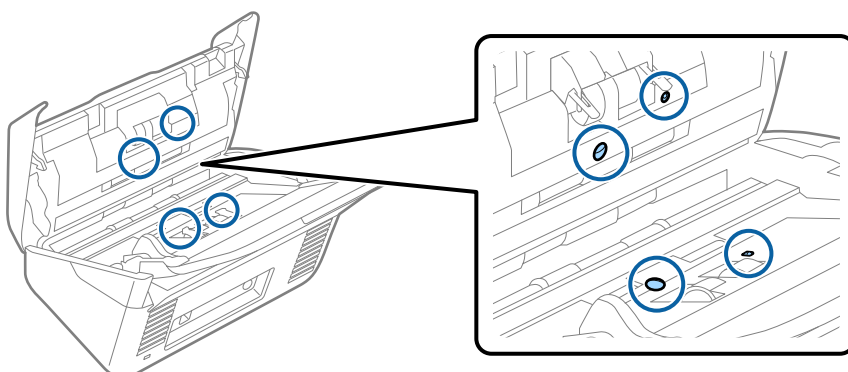

## Maintenance

**!** *Important:*

*Do not use liquid such as a cleaner on a cotton swab.*

6. Open the cover, and then remove the separation roller.  
See “Replacing the Roller Assembly Kit” for more details.

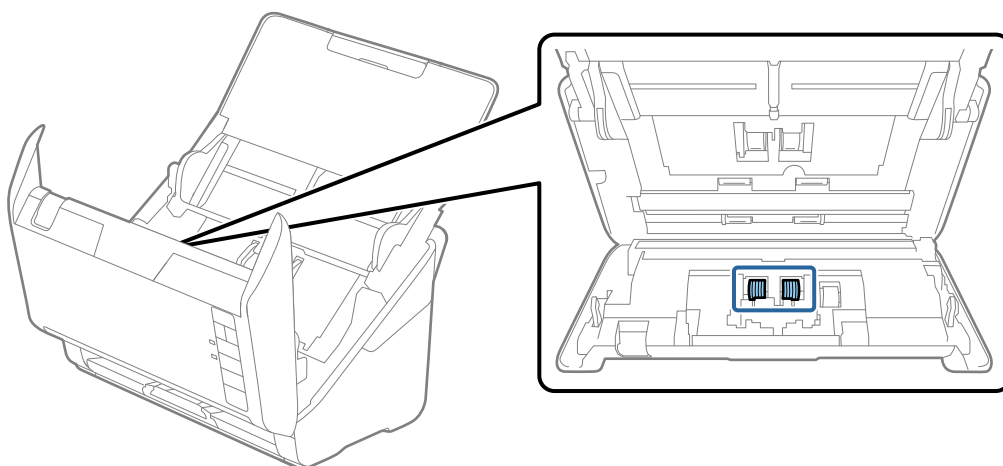

7. Wipe off any dust or dirt on the separation roller using a genuine Epson cleaning kit or a soft, moist cloth.

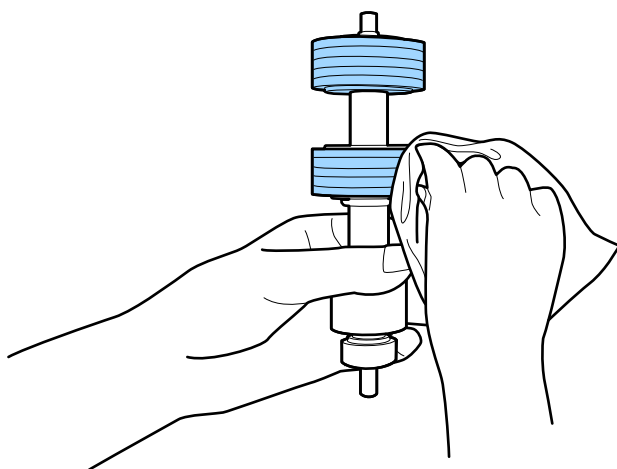

**!** *Important:*

*Use only a genuine Epson cleaning kit or a soft, moist cloth to clean the roller. Using a dry cloth may damage the surface of the roller.*



## Maintenance

8. Open the cover, and then remove the pickup roller.  
See “Replacing the Roller Assembly Kit” for more details.

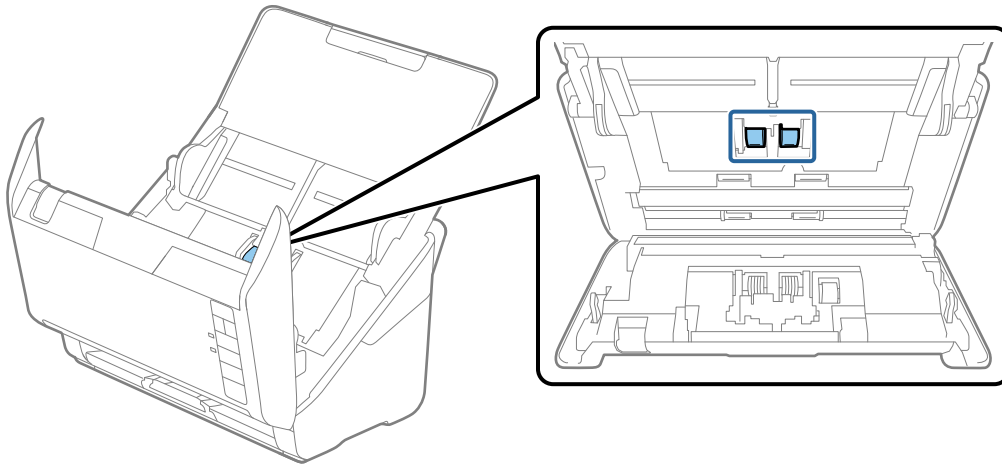

9. Wipe off any dust or dirt on the pickup roller using a genuine Epson cleaning kit or a soft, moist cloth.

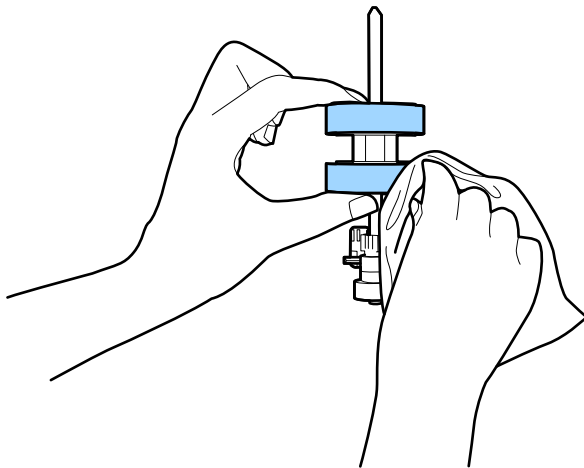



**Important:**

*Use only a genuine Epson cleaning kit or a soft, moist cloth to clean the roller. Using a dry cloth may damage the surface of the roller.*

10. Plug in the AC adapter, and then turn on the scanner.

## Maintenance

11. Hold down the  button for at least two seconds while opening the scanner cover. The rollers on the bottom move momentarily, and then the scanner enters cleaning mode. The rollers rotate a bit each time you press the  button. Press the  button several times to rotate the rollers. Use a genuine Epson cleaning kit or a soft, moist cloth to clean the rollers as they rotate. Repeat this step until the rollers are clean.

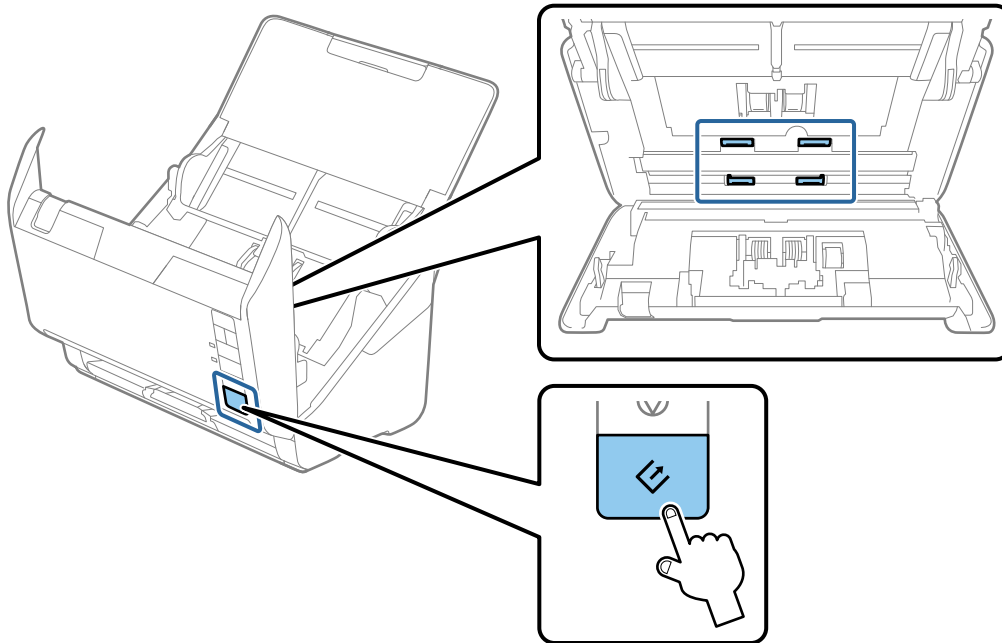
**Caution:**

*Be careful not to get your hands or hair caught in the mechanism when operating the roller. This could cause an injury.*

12. Close the scanner cover.  
The scanner exits cleaning mode.

**Related Information**

- ➔ [“Cleaning Kit Codes” on page 17](#)
- ➔ [“Replacing the Roller Assembly Kit” on page 107](#)

## Replacing the Roller Assembly Kit

The roller assembly kit (the pickup roller and the separation roller) needs to be replaced when the number of scans exceeds the Life Cycle of the rollers. When a replacement message is displayed on your computer, follow the steps below to replace it.

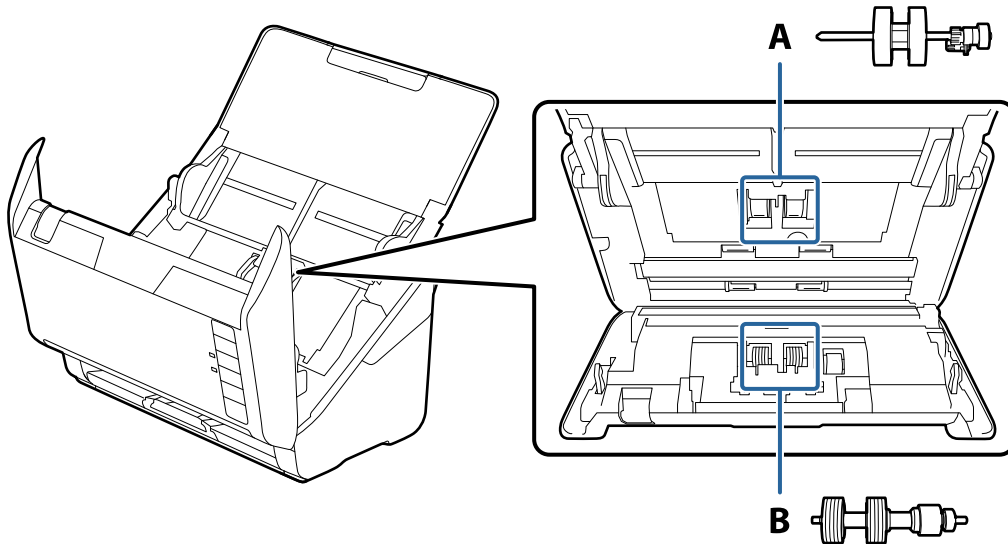

A: pickup roller, B: separation roller

1. Press the  button to turn off the scanner.
2. Unplug the AC adapter from the scanner.
3. Pull the cover open lever and open the scanner cover.

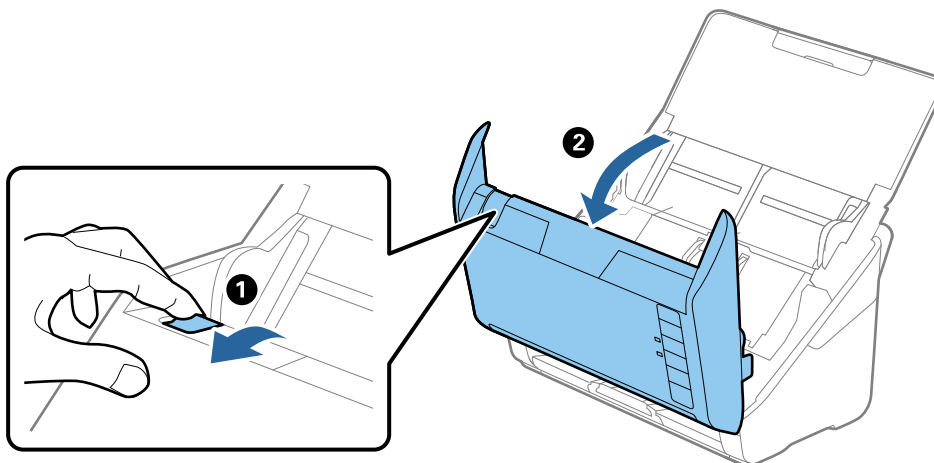

## Maintenance

4. Open the cover of the pickup roller, and then slide and remove it.

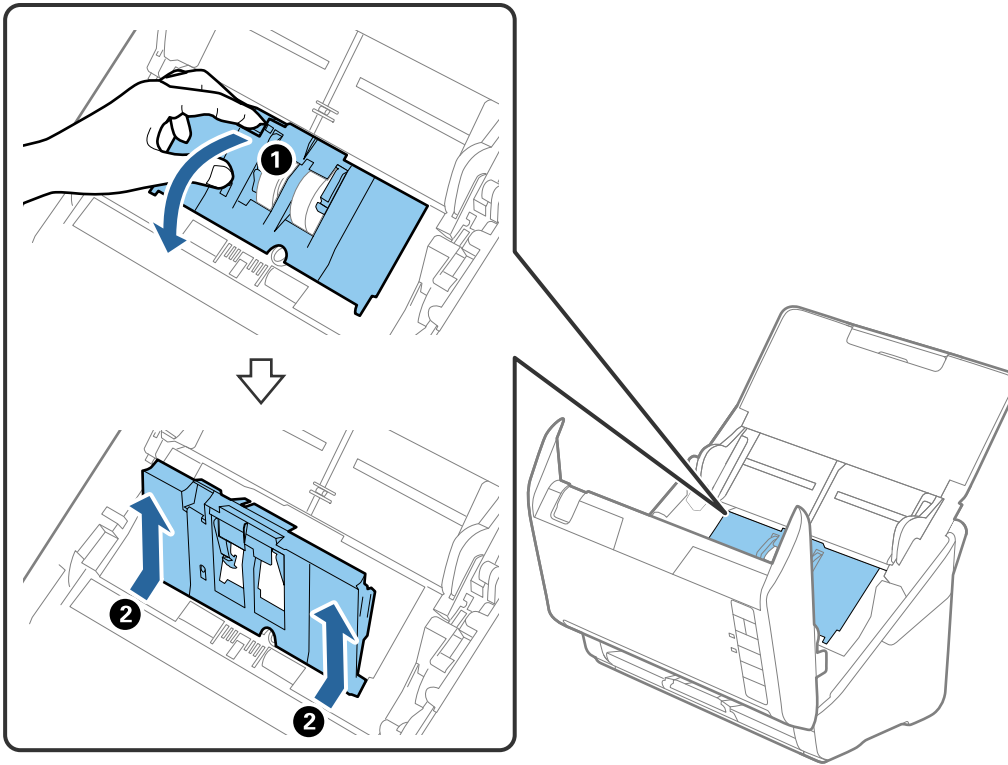

5. Pull down the fixture of the roller axis, and then slide and remove the installed pickup rollers.

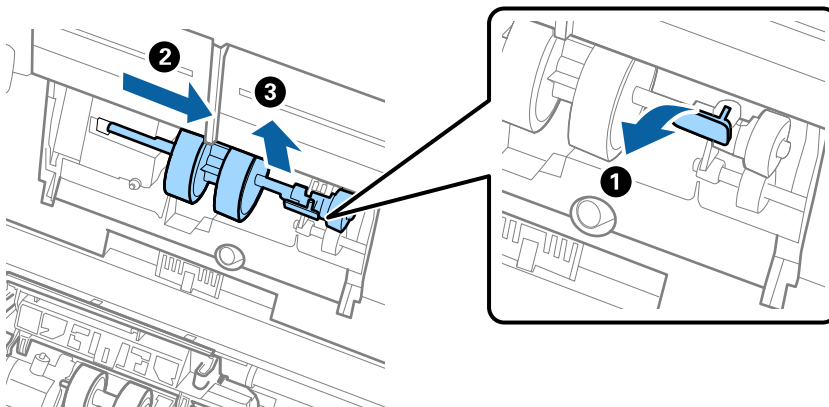

**Important:**

*Do not pull out the pickup roller forcibly. This could damage the inside of the scanner.*

### Maintenance

6. While holding down the fixture, slide the new pickup roller to the left and insert it into the hole in the body. Press the fixture to secure it.

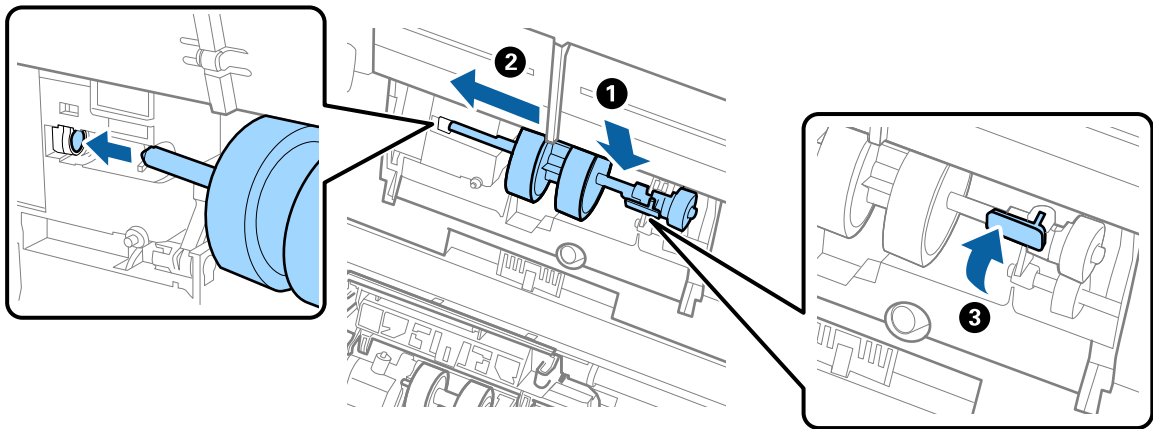

7. Put the edge of the cover of the pickup roller into the groove and slide it. Close the cover firmly.

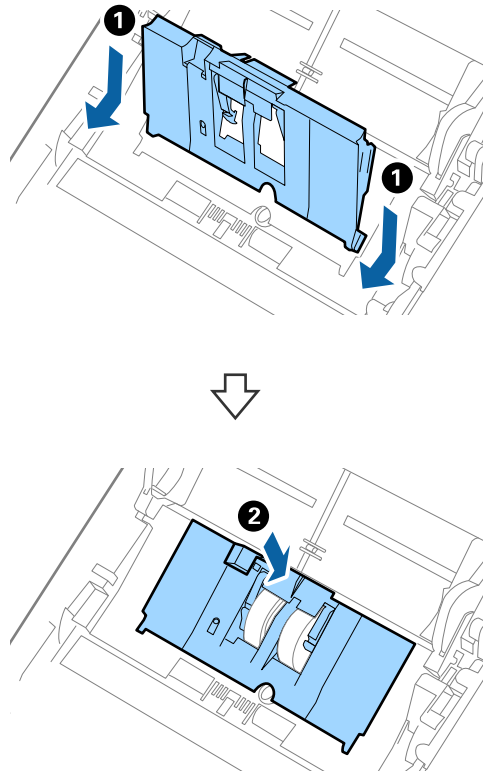

## Maintenance

**!** *Important:*

- Make sure the pick up cover is closed correctly.*
- Make sure the pickup rollers are installed correctly if the cover is hard to close.*
- Do not install the cover while it is raised.*

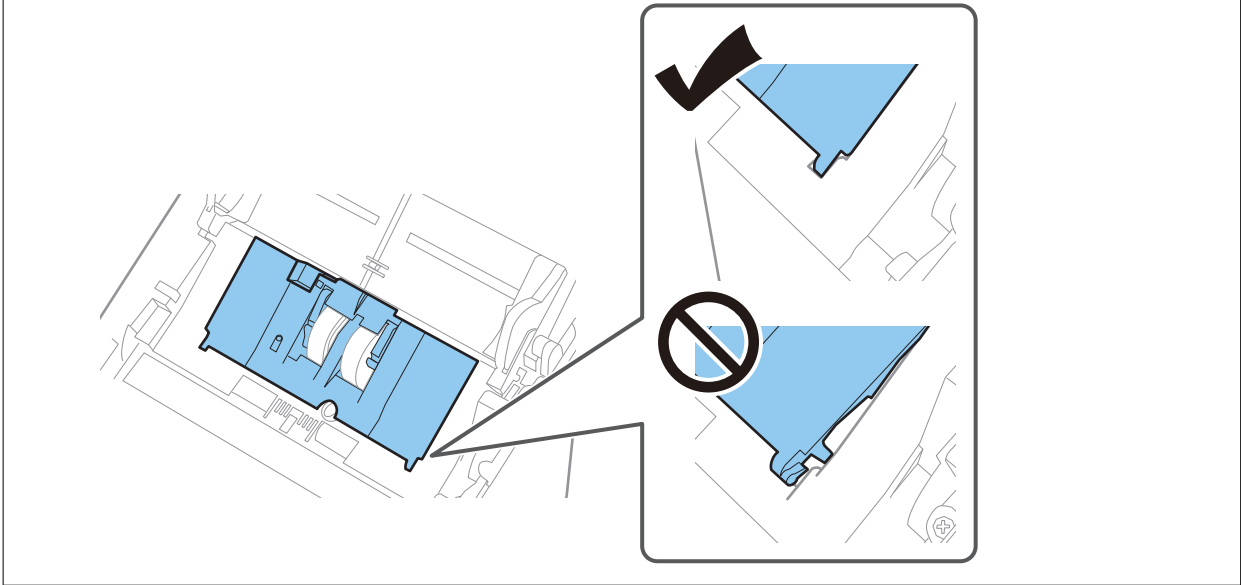

8. Push the hooks on both ends of the separation roller cover to open the cover.

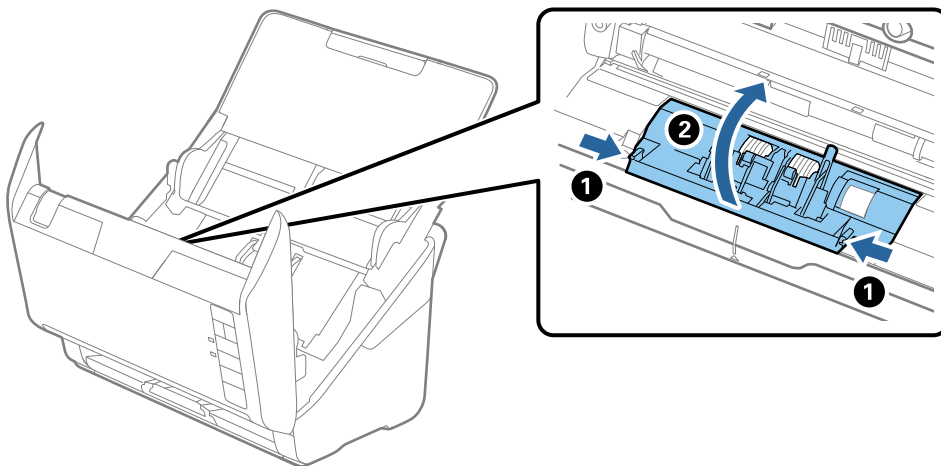

## Maintenance

- Lift the left side of the separation roller, and then slide and remove the installed separation rollers.

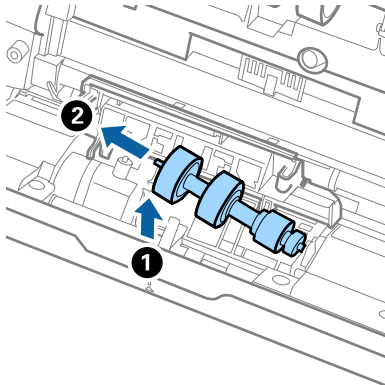

- Insert the new separation roller axis into the hole on the right side, and then lower the roller.

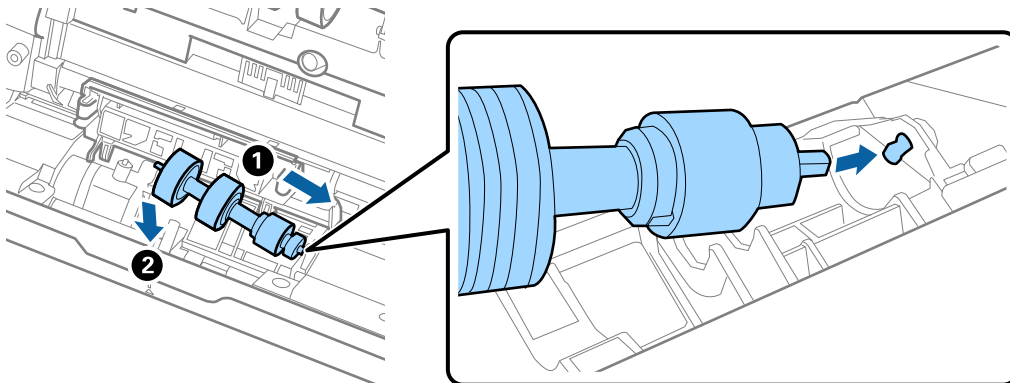

- Close the separation roller cover.



**Important:**

*Make sure the separation rollers are installed correctly if the cover is hard to close.*

- Close the scanner cover.
- Plug in the AC adapter, and then turn on the scanner.
- Reset the scan number using Epson Scan 2 Utility.

**Note:**

*Dispose of the pickup roller and the separation roller following the rules and regulations of your local authority. Do not disassemble them.*

### Related Information

➔ [“Roller Assembly Kit Codes” on page 16](#)

## Resetting the Number of Scans

Reset the number of scans using Epson Scan 2 Utility after replacing the Roller Assembly Kit.

## Maintenance

1. Turn on the scanner.
2. Start Epson Scan 2 Utility.
  - ❑ Windows 10  
Click the start button, and then select **EPSON > Epson Scan 2 > Epson Scan 2 Utility**.
  - ❑ Windows 8.1/Windows 8  
**Start screen > Apps > Epson > Epson Scan 2 Utility**.
  - ❑ Windows 7  
Click the start button, and then select **All Programs (or Programs) > EPSON > Epson Scan 2 > Epson Scan 2 Utility**.
  - ❑ Mac OS  
Select **Go > Applications > EPSON Software > Epson Scan 2 Utility**.

**Note:**

You can also start Epson Scan 2 Utility from Epson FastFoto or Epson ScanSmart.

Click **Settings > Scanner Settings tab > Device Settings**.

3. Click the **Counter** tab.

**Note:**

When scanning photos with Epson FastFoto, every scan is counted as **Double-Sided**, even if the backs of the photos are blank. However, this does not affect the life of the Roller Assembly Kit.

4. Click **Reset** for the roller assembly kit.

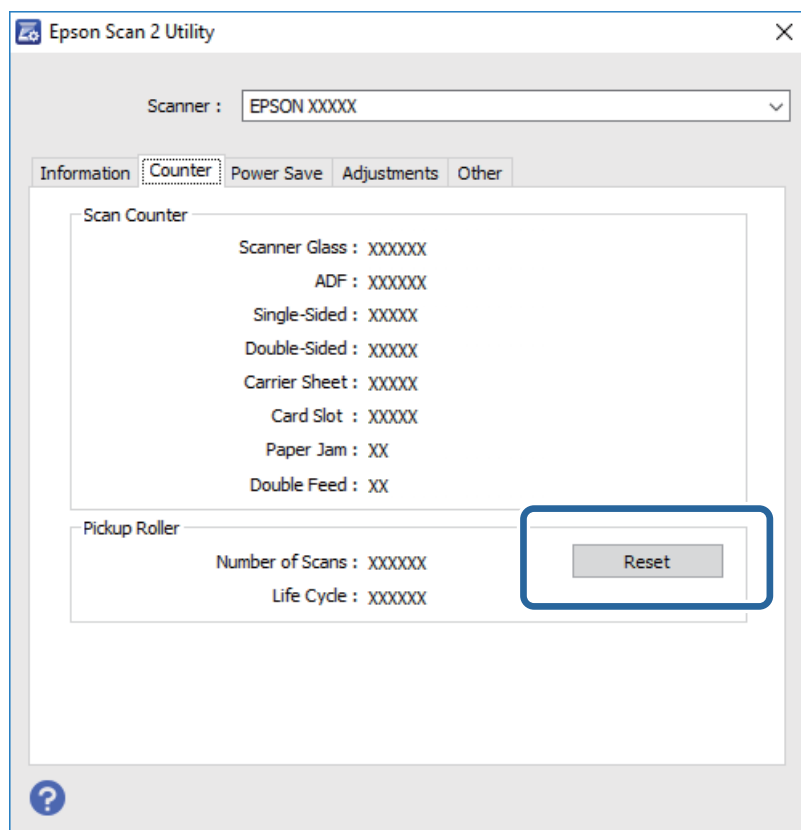



**Related Information**

➔ [“Replacing the Roller Assembly Kit” on page 107](#)

---

## Energy Saving

You can save energy by using the sleep mode or auto power off mode when no operations are performed by the scanner. You can set the time period before the scanner enters sleep mode and turns off automatically. Any increase will affect the product's energy efficiency. Consider the environment before making any changes.

1. Start Epson Scan 2 Utility.

Windows 10

Click the start button, and then select **EPSON > Epson Scan 2 > Epson Scan 2 Utility**.

Windows 8.1/Windows 8

**Start** screen > **Apps** > **Epson** > **Epson Scan 2 Utility**.

Windows 7

Click the start button, and then select **All Programs** (or **Programs**) > **EPSON** > **Epson Scan 2** > **Epson Scan 2 Utility**.

Mac OS

Select **Go** > **Applications** > **EPSON Software** > **Epson Scan 2 Utility**.

**Note:**

*You can also start Epson Scan 2 Utility from Epson FastFoto or Epson ScanSmart.*

*Click **Settings** > **Scanner Settings** tab > **Device Settings**.*

2. Click the **Power Save** tab.

## Maintenance

3. Set the **Sleep Timer (minutes)** or **Power Off Timer (minutes)**, and then click **Set**.

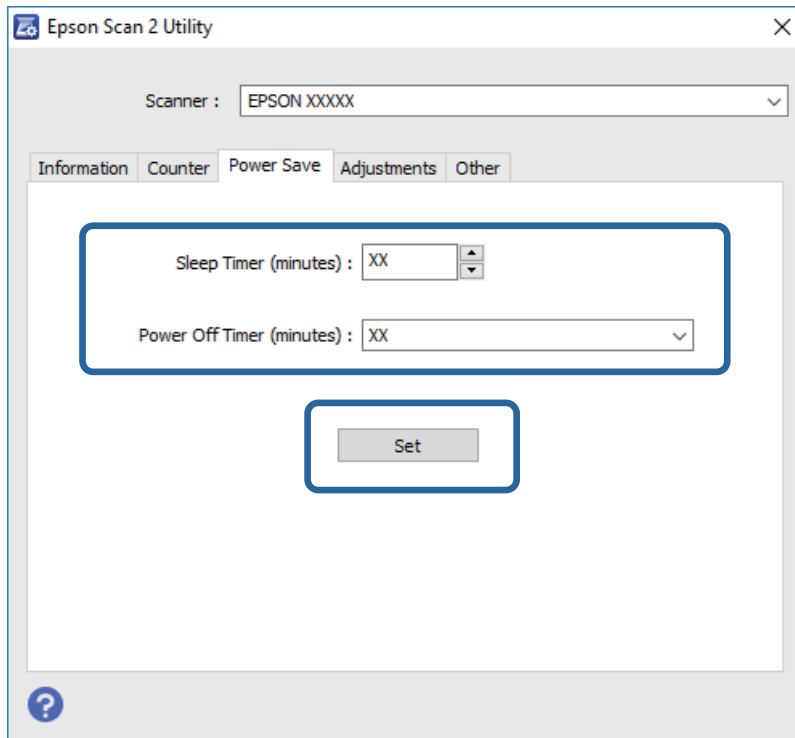

---

## Transporting the Scanner

When you need to transport the scanner to move or for repairs, follow the steps below to pack the scanner.

1. Press the  button to turn off the scanner.
2. Unplug the AC adapter from the scanner.
3. Remove the USB cable.

## Maintenance

4. Close the input tray and output tray.

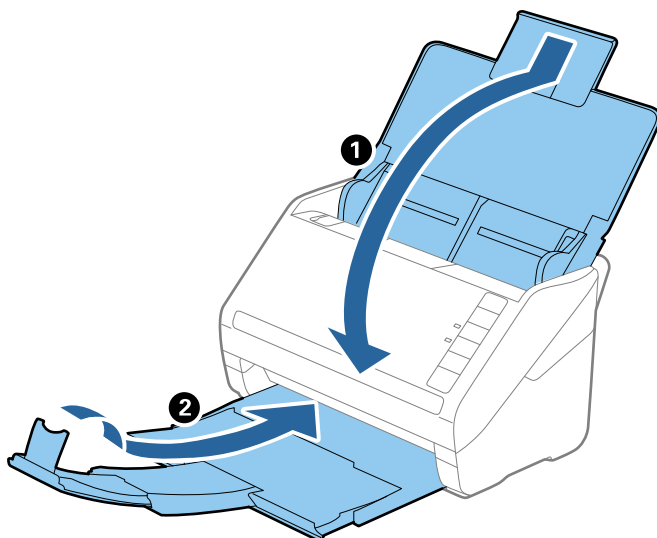
**Important:**

Make sure you close the output tray securely; otherwise it may be damaged during transport.

5. Attach the packing materials that came with the scanner, and then repack the scanner in its original box or a sturdy box.

---

## Updating Applications and Firmware

You may be able to clear certain problems and improve or add functions by updating the applications and the firmware. Make sure you use the latest version of the applications and firmware.

**Important:**

- Do not turn off the computer or the scanner while updating.

1. Make sure that the scanner and the computer are connected, and the computer is connected to the internet.
2. Start EPSON Software Updater, and update the applications or the firmware.
  - Windows 10  
Click the start button, and then select **Epson Software > EPSON Software Updater**.
  - Windows 8.1/Windows 8  
Enter the application name in the search charm, and then select the displayed icon.
  - Windows 7  
Click the start button, and then select **All Programs or Programs > Epson Software > EPSON Software Updater**.
  - Mac OS  
Select **Finder > Go > Applications > Epson Software > EPSON Software Updater**.

## Maintenance

**Note:**

*If you cannot find the application you want to update in the list, you cannot update using the EPSON Software Updater. Check for the latest versions of the applications on your local Epson website.*

<http://www.epson.com>

# Solving Problems

---

## Scanner Problems

### Scanner Lights Indicate an Error

Check the following if the scanner lights indicate an error.

- Make sure there are no originals jammed in the scanner.
- When feeding multiple originals, open the ADF cover and remove the originals. Next, close the ADF cover.
- Make sure the scanner cover is closed.
- Make sure the scanner is connected to your computer properly.
  - If a Wi-Fi connection error has occurred, check the Wi-Fi connection settings.
- Make sure the applications are installed correctly.
- If the firmware update fails and the scanner enters recovery mode, update the firmware again using a USB connection.
- Turn off the scanner and turn it on again. If this does not solve the problem, the scanner may be malfunctioning, or the light source in the scanner unit may need to be replaced. Contact your dealer.

#### Related Information

- ➔ [“Error Indicators” on page 14](#)
- ➔ [“The Original Jams in the Scanner Frequently” on page 119](#)

### The Scanner Does Not Turn On

- Make sure the AC adapter is securely connected to the scanner and an electrical outlet.
- Check that the electrical outlet is working. Plug another device into the electrical outlet and check that you can turn the power on.

---

## Paper Feeding Problems

### Photos Are Not Fed Correctly

If photos are not fed correctly, make sure the following.

- Flatten any curled photos to a thickness of less than 2 mm (0.07 in.). It is best to scan curled photos in an environment between 15 to 25°C (59 to 77°F) with 40 to 60% humidity. Scanning photos at lower temperatures may cause photos to curl.
- Photos may stick together depending on their paper types and thickness. It is best to scan photos in an environment between 15 to 25°C (59 to 77°F) with 40 to 60% humidity to prevent photos from sticking together.

## Solving Problems

- ❑ If you repeat scanning the same photos in many times, they may stick together. If they stuck together, feed them one by one.
- ❑ Reduce the number of photos being placed at a time.

### Multiple Originals Are Fed

If multiple originals are fed, open the scanner cover and remove the originals. Next, close the scanner cover.

If multiple originals are fed frequently, try the following.

- ❑ If you load unsupported originals, the scanner may feed multiple originals at a time.
- ❑ Clean the rollers inside the scanner.
- ❑ Reduce the number of originals being placed at a time.
- ❑ Press the **▶▶** button to slow down the scanning speed.
- ❑ Use **Automatic Feeding Mode** in Epson ScanSmart, and scan originals one by one.

Click  **Settings** > **Scanner Settings** tab > **Scan Settings** button > **Main Settings** tab on the Epson Scan 2 window, and then set the **Automatic Feeding Mode**.

#### Related Information

➔ [“Cleaning Inside the Scanner” on page 102](#)

### Removing Jammed Originals from the Scanner

If an original has jammed inside the scanner, follow these steps to remove it.

1. Remove all originals remaining in the input tray.
2. Pull the cover open lever and open the scanner cover.

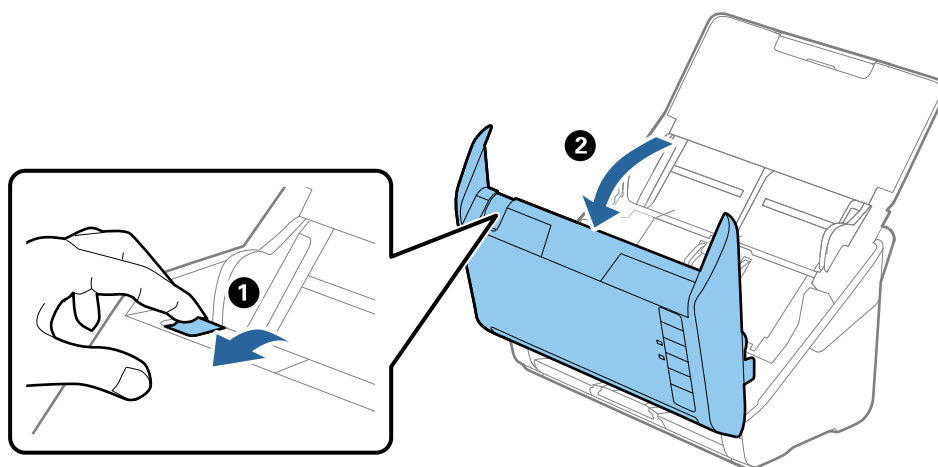

## Solving Problems

- Carefully remove any originals remaining inside the scanner.

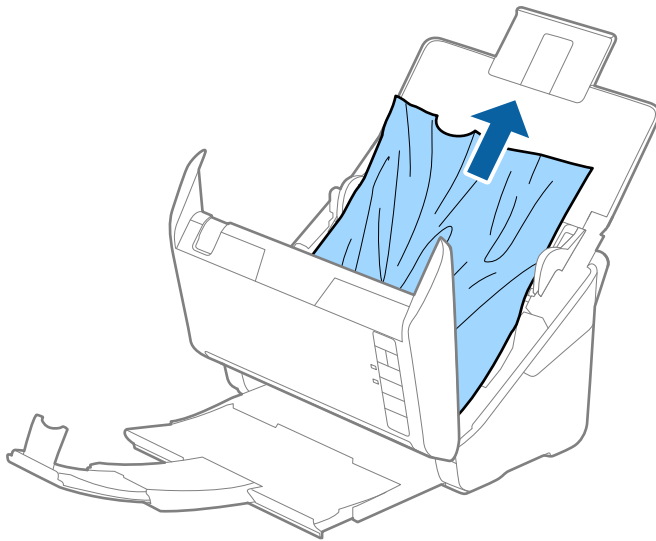

- Carefully pull out any jammed originals from the output tray in the direction of the arrow if you cannot pull originals straight up.

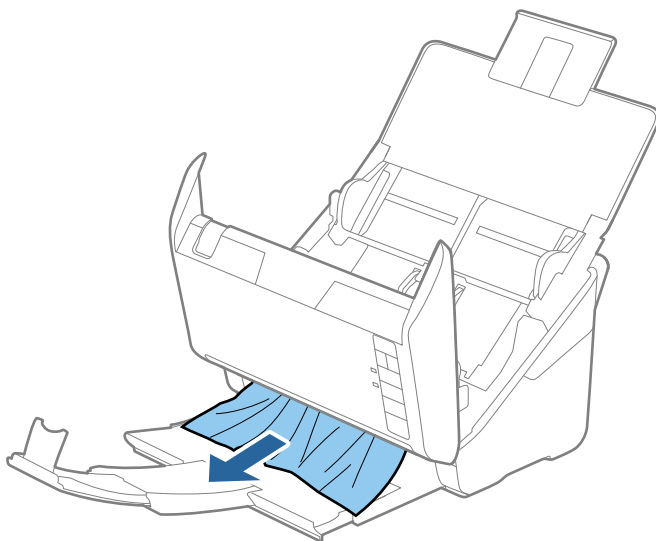

**Important:**

*Make sure there is no paper inside the scanner.*

- Close the scanner cover.

## The Original Jams in the Scanner Frequently

If the original jams in the scanner frequently, try the following.

- Press the  button to slow down the scanning speed.
- Clean the rollers inside the scanner.

## Solving Problems

- ❑ If the ejected originals get stuck in the output tray, store the output tray and do not use it.

### Related Information

- ➔ [“Cleaning Inside the Scanner” on page 102](#)

## The Originals Get Dirty

Clean the inside of the scanner.

### Related Information

- ➔ [“Cleaning Inside the Scanner” on page 102](#)

## Scanning Speed Slows Down when Scanning Continuously

When scanning continuously using the ADF, scanning slows down to prevent the scanner mechanism from overheating and being damaged. However, you can continue scanning.

To regain normal scanning speed, leave the scanner idle for at least 30 minutes. Scanning speed does not recover even if the power is off.

## Scanning Takes a Long Time

- ❑ When the resolution is high, scanning may take some time.
- ❑ Computers with USB 3.0 (SuperSpeed) or USB 2.0 (Hi-Speed) ports can scan faster than those with USB 1.1 ports. If you are using a USB 3.0 or USB 2.0 port with the scanner, make sure it meets the system requirements.
- ❑ When using security software, exclude the TWAIN.log file from monitoring, or set the TWAIN.log as a read-only file. For more information on your security software's functions, see the help and so on supplied with the software. The TWAIN.log file is saved in the following locations.  
C:\Users\*(user name)*\AppData\Local\Temp



---

## Scanning Problems when Using Epson FastFoto

### Straight Lines Appear

Straight lines may appear in the image when dust or dirt gets inside of the scanner.



- Clean the glass surfaces inside your scanner using a genuine Epson cleaning kit or the microfiber cloth that came with your scanner.
- Remove dust, dirt, or other particles on the front and back of your photos.
- Using **Reduce lines and streaks** feature, you can reduce the vertical lines or streaks of the scanned image caused by dirt on the glass surface inside the scanner.  
Click **Settings** > **Advanced Settings** tab, and then enable **Reduce lines and streaks**.

**Note:**

*Depending on the dirt, lines and streaks may not be reduced correctly.*

- Using **Detect Glass Dirt** feature, alert message appears when dirt is detected on the scanner glass.  
Click **Settings** > **Scanner Settings** tab > **Device Settings**, and then click the **Scanner Setting** tab on the **Epson Scan 2 Utility** screen. Select a setting for **Detect Glass Dirt**, and then click **Set**.  
When an alert is displayed, clean the glass surfaces inside your scanner using a genuine Epson cleaning kit or the microfiber cloth that came with your scanner.

**Note:**

- Depending on the dirt, it may not be detected correctly.*
- If the detection does not work correctly, select a level from **On-Low**, **On-High**, or **Off**.*

#### Related Information

➔ [“Cleaning Inside the Scanner” on page 102](#)

### The Image Quality Is Poor

- Use a soft, dry cloth (like the microfiber cloth that came with your scanner) to remove dust, dirt, or other particles on the front and back of your photos.

## Solving Problems

- ❑ If the resolution (DPI) is low, increase the resolution and then scan again.  
Click **Settings** > **Scan Settings** tab, and then select the resolution (DPI) to scan.

### Pressing the Scanner Button Does Not Start Epson FastFoto

- ❑ Make sure the following applications are installed:
  - ❑ Epson FastFoto
  - ❑ Epson Scan 2
  - ❑ Epson Event Manager

If the applications are not installed, install them again.

**Note:**

See the following to check your applications.

*Windows 10: Right-click the start button or press and hold it, and then select **Control Panel** > **Programs** > **Programs and Features**.*

*Windows 8.1/Windows 8: Select **Desktop** > **Settings** > **Control Panel** > **Programs** > **Programs and Features**.*

*Windows 7: Click the start button and select **Control Panel** > **Programs** > **Programs and Features**.*

*Mac OS: Select **Go** > **Applications** > **EPSON Software**.*

- ❑ Click **Settings** > **Scanner Settings** tab, and then check the following:
  - ❑ Make sure that **Scanner** is selected correctly. If not, click **Change** and select your scanner.
  - ❑ When you are using the scanner via Wi-Fi, click **Change** and make sure that the scanner is paired with the computer correctly. If your scanner is not listed, check that the Wi-Fi connection is working correctly.
  - ❑ Click **Select Application**, and then make sure that **Epson FastFoto** is selected.
- ❑ Make sure another computer is not connecting by USB. A USB connection takes priority over a Wi-Fi connection. If another computer is connected by USB, disconnect it.
- ❑ Make sure the Epson FastFoto and other applications are installed correctly.
- ❑ Try turning the wireless router's power off and then on again.
- ❑ For Mac OS X users: Make sure you select the network that has priority on your Mac OS X.

#### Related Information

➔ [“Installing Your Applications” on page 133](#)

### Cannot Share or Upload the Photos to a Web Service

- ❑ Make sure you enter the correct information when you login.
- ❑ Make sure the service is running. The service may be down due to system maintenance. Check the accounting service website for more detailed information.

## Glass Dirt Alert Does Not Disappear

If the glass dirt alert screen appears after cleaning the inside of the scanner, check the glass surface again. If there are scratches on the glass, they will be detected as a glass dirt.

Glass part will be required to replace. Contact your local dealer to repair.

---

# Scanning Problems when Using Epson ScanSmart

## Cannot Start Epson ScanSmart

Make sure the scanner is connected to your computer properly.

Make sure the following applications are installed:

- Epson ScanSmart
- Epson Scan 2
- Epson Event Manager

If the applications are not installed, install them again.

**Note:**

See the following to check your applications.

*Windows 10: Right-click the start button or press and hold it, and then select **Control Panel** > **Programs** > **Programs and Features**.*

*Windows 8.1/Windows 8: Select **Desktop** > **Settings** > **Control Panel** > **Programs** > **Programs and Features**.*

*Windows 7: Click the start button and select **Control Panel** > **Programs** > **Programs and Features**.*

*Mac OS: Select **Go** > **Applications** > **EPSON Software**.*

Check the following when using the scanner over a network.

- Check that the Wi-Fi connection is working correctly.  
Try turning the wireless router's power off and then on again.
- Make sure that you select the correct scanner.

Click  **Settings** in **Epson ScanSmart**, **Review Scans** or on the **Select Action** window, and then click the **Scanner Settings** tab > **Change** to confirm or re-pair the scanner using your computer.

- Make sure another computer is not connected by USB. A USB connection takes priority over a Wi-Fi connection. If another computer is connected by USB, disconnect it.
- For Mac OS users:  
Make sure you select the network that has priority on your Mac OS.

Check the following when using the scanner with a USB cable.

- Make sure the USB cable is securely connected to the scanner and the computer.
- Use the USB cable that came with the scanner.
- Connect the scanner directly to the computer's USB port. The scanner may not work properly when connected to the computer through one or more USB hubs.

Make sure the scanner is turned on.

## Solving Problems

- Wait until the status light stops flashing indicating that the scanner is ready to scan.
- If you are using any TWAIN-compliant applications, make sure that the correct scanner is selected as the scanner or source setting.

### Related Information

➔ [“Installing Your Applications” on page 133](#)

## Straight Lines Appear when Scanning from ADF



- Clean the ADF.  
Straight lines may appear in the image when trash or dirt gets into the ADF.
- Remove any trash or dirt that adheres to the original.

### Related Information

➔ [“Cleaning Inside the Scanner” on page 102](#)

## Offset Appears in the Background of Images

Images on the back of the original may appear in the scanned image.

- When **Auto**, **Color**, or **Grayscale** is selected as the **Image Type**.
  - Check that **Remove Background** is selected.  
Click  **Settings** in **Epson ScanSmart**, **Review Scans** or on the **Select Action** window, and then click the **Scanner Settings** tab > **Scan Settings** button > **Advanced Settings** tab on the Epson Scan 2 window > **Remove Background**.
  - Check that **Text Enhancement** is selected.  
Click  **Settings** in **Epson ScanSmart**, **Review Scans** or on the **Select Action** window > **Scanner Settings** tab > **Scan Settings** button > **Advanced Settings** tab in Epson Scan 2 window > **Text Enhancement**.
- When **Black & White** is selected as the **Image Type**.
  - Check that **Text Enhancement** is selected.  
Click  **Settings** in **Epson ScanSmart**, **Review Scans** or on the **Select Action** window, and then click the **Scanner Settings** tab > **Scan Settings** button > **Advanced Settings** tab on the Epson Scan 2 window > **Text Enhancement**.  
Depending on the condition of your scanned image, click **Settings** and try setting a lower level for **Edge Enhancement** or a higher level for **Noise Reduction Level**.

## Scanned Image or Text is Blurred

You can adjust the appearance of the scanned image or text by increasing the resolution or adjusting the image quality.

## Solving Problems

- ❑ Try increasing the resolution and then scanning.

Set the appropriate resolution for the purpose of your scanned image.

Click  **Settings** in **Epson ScanSmart, Review Scans** or on the **Select Action** window, and then click the **Scanner Settings** tab > **Scan Settings** button > **Main Settings** tab on the Epson Scan 2 window > **Resolution**.

- ❑ Check that **Text Enhancement** is selected.

Click  **Settings** in **Epson ScanSmart, Review Scans** or on the **Select Action** window, and then click the **Scanner Settings** tab > **Scan Settings** button > **Advanced Settings** tab on the Epson Scan 2 window > **Text Enhancement**.

- ❑ When **Black & White** is selected as the **Image Type**.

Depending on the condition of your scanned image, click **Settings** and try setting a lower level for **Edge Enhancement** or a higher level for **Noise Reduction Level**.

- ❑ If you are scanning in JPEG format, try to change the compression level.

Click  **Settings** in **Epson ScanSmart, Review Scans** or on the **Select Action** window, and then click the **Save Settings** tab > **Options** button

## List of Recommended Resolutions to Suit Your Purpose

See the table and set the appropriate resolution for the purpose of your scanned image.

| Purpose   | Resolution (Reference) |
|---|------------------------|
| Displaying on a screen<br>Sending by email                                  | Up to 200 dpi          |
| Using Optical Character Recognition (OCR)<br>Creating a text searchable PDF | 200 to 300 dpi         |
| Printing using a printer<br>Sending by fax                                  | 200 to 300 dpi         |

## Moiré Patterns (Web-Like Shadows) Appear

If the original is a printed document, moiré patterns (web-like shadows) may appear in the scanned image.

- ❑ Check that **Descreening** is selected.

Click  **Settings** in **Epson ScanSmart, Review Scans** or on the **Select Action** window, and then click the **Scanner Settings** tab > **Scan Settings** button > **Advanced Settings** tab on the Epson Scan 2 window > **Descreening**.



## Solving Problems

- Change the resolution, and then scan again.

Click  **Settings** in **Epson ScanSmart, Review Scans** or on the **Select Action** window, and then click the **Scanner Settings** tab > **Scan Settings** button > **Main Settings** tab on the Epson Scan 2 window > **Resolution**.

## The Edge of the Original is Not Scanned when Automatically Detecting the Size of the Original

Depending on the original, the edge of the original may not be scanned when automatically detecting the size of the original.

- Click  **Settings** in **Epson ScanSmart, Review Scans** or on the **Select Action** window, and then click the **Scanner Settings** tab > **Scan Settings** button.

In Epson Scan 2, select the **Main Settings** tab, and then select **Document Size** > **Settings**. On the **Document Size Settings** window, adjust **Crop Margins for Size "Auto"**.

- Depending on the original, the area of the original may not be detected correctly when using the **Auto Detect** feature. Select the appropriate size of the original from the **Document Size** list.

Click  **Settings** in **Epson ScanSmart, Review Scans** or on the **Select Action** window, and then click the **Scanner Settings** tab > **Scan Settings** button.

In Epson Scan 2, click the **Main Settings** tab, and then click **Document Size**.

### Note:

*If the size of the original you want to scan is not on the list, select **Customize**, and then create the size manually.*

Click  **Settings** in **Epson ScanSmart, Review Scans** or on the **Select Action** window, and then click the **Scanner Settings** tab > **Scan Settings** button.

*In Epson Scan 2, click the **Main Settings** tab, and then click **Customize** in **Document Size**.*

## Character is not Recognized Correctly

Check the following to increase the recognition rate of OCR (Optical Character Recognition).

- Check that the original is placed straight.
- Use an original with clear text. Text recognition may decline for the following types of originals.
  - Originals that have been copied several times
  - Originals received by fax (at low resolutions)
  - Originals where the letter spacing or line spacing is too small
  - Originals with ruled lines or underlining over the text
  - Originals with hand written text
  - Originals with creases or wrinkles
- Paper type made of thermal paper such as receipts may deteriorate due to age or friction. Scan them as soon as possible.
- When saving to Microsoft® Office or **Searchable PDF** files, check that the correct languages are selected. Check the **Language** in each save setting window.

## Solving Problems

### Expanding or Contracting the Scanned Image

When expanding or contracting the scanned image, you can adjust the expansion ratio by using the **Adjustments** feature in Epson Scan 2 Utility. This feature is only available for Windows.

**Note:**

*Epson Scan 2 Utility is one of the applications supplied with the scanner software.*

1. Start Epson Scan 2 Utility.
  - Windows 10  
Click the start button, and then select **EPSON > Epson Scan 2 > Epson Scan 2 Utility**.
  - Windows 8.1/Windows 8  
Enter the application name in the search charm, and then select the displayed icon.
  - Windows 7  
Click the start button, and then select **All Programs** or **Programs > EPSON > Epson Scan 2 > Epson Scan 2 Utility**.
2. Select the **Adjustments** tab.
3. Use **Expansion/Contraction** to adjust the expansion ratio for scanned images.
4. Click **Set** to apply the settings to the scanner.

### Cannot Solve Problems in the Scanned Image

If you have tried all of the solutions and have not solved the problem, initialize the application settings by using Epson Scan 2 Utility.

**Note:**

*Epson Scan 2 Utility is one of the applications supplied with the scanner software.*

1. Start Epson Scan 2 Utility.
  - Windows 10  
Click the start button, and then select **EPSON > Epson Scan 2 Utility**.
  - Windows 8.1/Windows 8  
Enter the application name in the search charm, and then select the displayed icon.
  - Windows 7  
Click the start button, and then select **All Programs** or **Programs > EPSON > Epson Scan 2 > Epson Scan 2 Utility**.
  - Mac OS  
Select **Go > Applications > Epson Software > Epson Scan 2 Utility**.
2. Select the **Other** tab.
3. Click **Reset**.

**Note:**

*If initialization does not solve the problem, uninstall and re-install Epson Scan 2.*

---

## Network Problems

### When You Cannot Make Network Settings

Turn off the devices you want to connect to the network. Wait for about 10 seconds, and then turn on the devices in the following order; access point, computer or smart device, and then scanner. Move the scanner and computer or smart device closer to the access point to help with radio wave communication, and then try to make network settings again.

### Cannot Connect from Devices Even Though Network Settings are No Problems

If you cannot connect from the computer or smart device to the scanner even though network settings of the scanner are no problem, see the following.

- ❑ When you are using multiple wireless routers at the same time, you may not be able to use the scanner from the computer or smart device depending on the settings of the wireless routers. Connect the computer or smart device to the same wireless router as the scanner.

Disable the tethering function on the smart device if it is enabled.

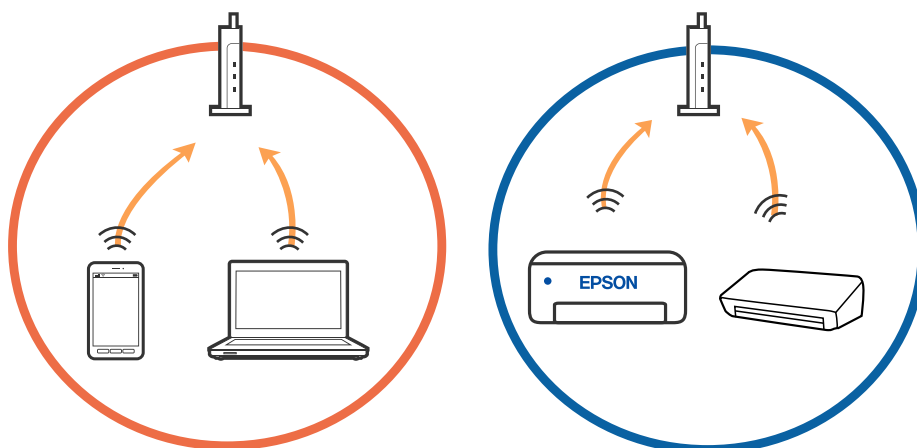



### Solving Problems

- ❑ You may not be able to connect to the wireless router when the wireless router has multiple SSIDs and devices are connected to different SSIDs on the same wireless router. Connect the computer or smart device to the same SSID as the scanner.

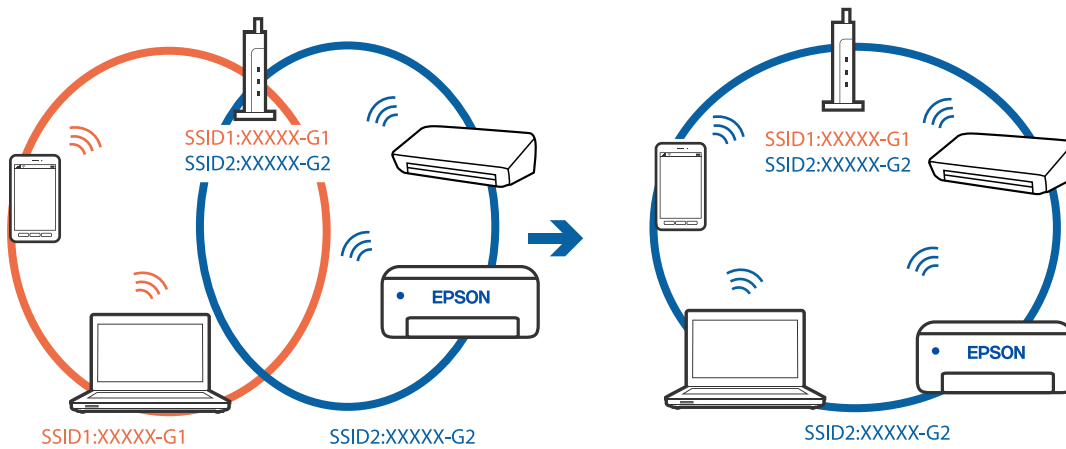

- ❑ A wireless router that is compliant with both IEEE802.11a and IEEE802.11g has SSIDs of 2.4 GHz and 5 GHz. If you connect the computer or smart device to a 5 GHz SSID, you cannot connect to the scanner because the scanner only supports communication over 2.4 GHz. Connect the computer or smart device to the same SSID as the scanner.

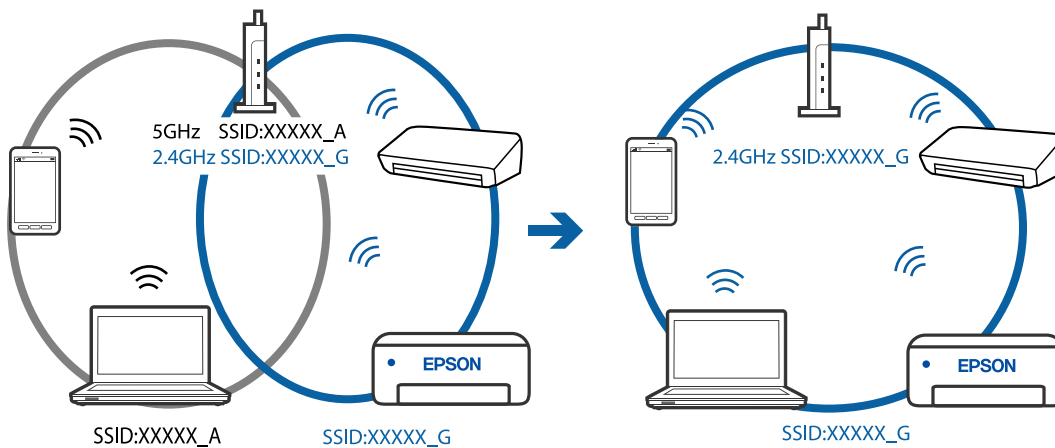

- ❑ Most wireless routers have a privacy separator feature that blocks communication between connected devices. If you cannot communicate between the scanner and the computer or smart device even if they are connected to the same network, disable the privacy separator on the wireless router. See the manual provided with the wireless router for details.

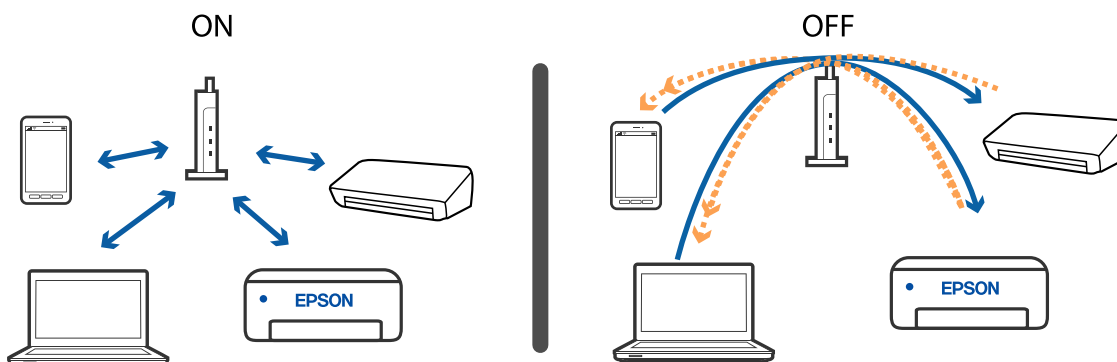

**Related Information**

- ➔ [“Checking the SSID Connected to the Scanner” on page 130](#)
- ➔ [“Checking the SSID for the Computer” on page 130](#)

**Checking the SSID Connected to the Scanner**

You can check the connected SSID on EpsonNet Config.

And you can check the SSID and password of scanner itself on the label stuck to the bottom face of the scanner. These are used when you connect the scanner in AP mode connection.

**Checking the SSID for the Computer****Windows**

Select **Control Panel > Network and Internet > Network and Sharing Center**.



## Mac OS

Click the Wi-Fi icon at the top of the computer screen. A list of SSIDs is displayed and the connected SSID is indicated with a check mark.



---

## The Scanner Suddenly Cannot Scan over a Network Connection

- When you have changed your access point or provider, try making network settings for the scanner again. Connect the computer or smart device to the same SSID as the scanner.
- Turn off the devices you want to connect to the network. Wait for about 10 seconds, and then turn on the devices in the following order; access point, computer or smart device, and then scanner. Move the scanner and computer or smart device closer to the access point to help with radio wave communication, and then try to make network settings again.
- Try accessing any website from your computer to make sure that your computer's network settings are correct. If you cannot access any websites, there is a problem on the computer. See the manual provided with your computer for more details.
- Check if the network setting is correct on Epson Scan 2 Utility.

### Related Information

- ➔ [“Checking the SSID Connected to the Scanner” on page 130](#)
- ➔ [“Checking the SSID for the Computer” on page 130](#)
- ➔ [“Cannot Connect from Devices Even Though Network Settings are No Problems” on page 128](#)

---

## The Scanner Suddenly Cannot Scan Using a USB Connection

- Disconnect the USB cable from the computer. Right-click on the scanner icon displayed on the computer, and then select **Remove Device**. Connect the USB cable to the computer and try a test scan. If scanning is possible, the setup is complete.

## Solving Problems

- Re-set the USB connection following the steps in [Changing the Connection Method to a Computer] in this manual.
- If a computer is connected to the scanner by USB while another computer is also connected to the scanner over a wireless connection and Epson Scan 2 is running on this computer, scanned images are saved to the wirelessly connected scanner when you press the scanner button. Scan from the computer instead of using the scanner button or close Epson Scan 2 on the wirelessly connected computer.

### Related Information

➔ [“Changing the Connection Method to a Computer” on page 99](#)

---

# Uninstalling and Installing Applications

## Uninstalling Your Applications

You may need to uninstall and then reinstall your applications to solve certain problems or if you upgrade your operating system. Log on to your computer as an administrator. Enter the administrator password if the computer prompts you.

### Uninstalling Your Applications for Windows

1. Quit all running applications.
  2. Disconnect the scanner from your computer.
  3. Open the Control Panel:
    - Windows 10  
Right-click the start button or press and hold it, and then select **Control Panel**.
    - Windows 8.1/Windows 8  
Select **Desktop > Settings > Control Panel**.
    - Windows 7  
Click the start button and select **Control Panel**.
  4. Select **Uninstall a program** in **Programs**.
  5. Select the application you want to uninstall.
  6. Click **Uninstall/Change** or **Uninstall**.
- Note:**  
*If the User Account Control window is displayed, click Continue.*
7. Follow the on-screen instructions.

**Note:**

*A message may be displayed prompting you to restart your computer. If it is displayed, make sure **I want to restart my computer now** is selected, and then click **Finish**.*

## Solving Problems

### Uninstalling Your Applications for Mac OS

**Note:**

Make sure you installed EPSON Software Updater.

1. Download the Uninstaller using EPSON Software Updater.  
Once you have downloaded the Uninstaller, you do not need to download it again each time you uninstall the application.
2. Disconnect the scanner from your computer.
3. To uninstall the scanner driver, select **System Preferences** from the  menu > **Printers & Scanners** (or **Print & Scan, Print & Fax**), and then remove the scanner from the enabled scanner list.
4. Quit all running applications.
5. Select **Go > Applications > Epson Software > Uninstaller**.
6. Select the application you want to uninstall, and then click Uninstall.

**! Important:**

*The Uninstaller removes all drivers for Epson scanners on the computer. If you use multiple Epson scanners and you only want to delete some of the drivers, delete all of them first, and then install the necessary scanner drivers again.*

**Note:**

*If you cannot find the application you want to uninstall in the application list, you cannot uninstall using the Uninstaller. In this situation, select **Go > Applications > Epson Software**, select the application you want to uninstall, and then drag it to the trash icon.*

### Installing Your Applications

Follow the steps below to install the necessary applications.

**Note:**

- Log on to your computer as an administrator. Enter the administrator password if the computer prompts you.
- When reinstalling applications, you need to uninstall them first.

1. Quit all running applications.
2. When installing Epson FastFoto or Epson ScanSmart, disconnect the scanner and the computer temporarily.

**Note:**

*Do not connect the scanner and the computer until you are instructed to do so.*

3. Install the application by following the instructions on the Website below.

<http://epson.sn>

**Note:**

*For Windows, you can also use the software disc that came with the scanner.*

# Technical Specifications

## General Scanner Specifications

**Note:**

Specifications are subject to change without notice.

|                             |   |  |
|-----------------------------|---|--|
| Scanner type                | Sheet Feed, one pass duplex color scanner |  |
| Photoelectric device        | CIS                                       |  |
| Effective pixels            | Epson FastFoto                            | 10,200×18,600 at 1,200 dpi<br>5,100×21,600 at 600 dpi<br>2,550×10,800 at 300 dpi |
|                             | Epson ScanSmart                           | 5,100×21,600 at 600 dpi<br>2,550×64,500 at 300 dpi<br>1,700×48,000 at 200 dpi    |
| Light source                | RGB LED                                   |  |
| Optical scanning resolution | 600 dpi (main scan)<br>600 dpi (sub scan) |  |
| Output resolution           | Epson FastFoto                            | 300 dpi, 600 dpi, or 1200 dpi *1   |
|                             | Epson ScanSmart                           | 50 to 1200 dpi (in 1 dpi increments) *2  |
| Size of originals           | Epson FastFoto                            | Max: 215.9×914.4 mm (8.5×36 in.)<br>Min: 50.8×50.8 mm (2×2 in.)                  |
|                             | Epson ScanSmart                           | Max: 215.9×6,096 mm (8.5×240 in.)<br>Min: 50.8×50.8 mm (2×2 in.)                 |
| Paper input                 | Epson FastFoto                            | Face-up loading  |
|                             | Epson ScanSmart                           | Face-down loading  |
| Paper output                | Epson FastFoto                            | Face-up ejection   |
|                             | Epson ScanSmart                           | Face-down ejection   |
| Paper capacity              | Epson FastFoto                            | 36 sheets of paper at 3.5×5", 4×6" or 5×7" size                                  |
|                             | Epson ScanSmart                           | 100 sheets of paper at 80 g/m <sup>2</sup>                                       |

## Technical Specifications

|             |   |
|-------------|---|
| Color Depth | <p>Color</p> <ul style="list-style-type: none"> <li><input type="checkbox"/> 30 bits per pixel internal (10 bits per pixel per color internal)</li> <li><input type="checkbox"/> 24 bits per pixel external (8 bits per pixel per color external)</li> </ul> <p>Grayscale</p> <ul style="list-style-type: none"> <li><input type="checkbox"/> 10 bits per pixel internal</li> <li><input type="checkbox"/> 8 bits per pixel external</li> </ul> <p>Black and white</p> <ul style="list-style-type: none"> <li><input type="checkbox"/> 10 bits per pixel internal</li> <li><input type="checkbox"/> 1 bit per pixel external</li> </ul> |
| Interface*3 | <p>SuperSpeed USB</p> <p>IEEE802.11b/g/n</p>  |

\*1 When scanning a panoramic photo, you can set the resolution to 600 dpi or 300 dpi.

\*2 50 to 300 dpi (393.8 to 5,461.0 mm (15.5 to 215 in.) in length), 50 to 200 dpi (5,461.1 to 6,096.0 mm (215 to 240 in.) in length)

\*3 You cannot use a USB and network connection at the same time.

## Wi-Fi Specifications

|   |   |
|---|---|
| Standards                                 | IEEE802.11b/g/n                                       |
| Frequency Range                           | 2.4 GHz   |
| Maximum radio-frequency power transmitted | 19.8 dBm (EIRP)                                       |
| Coordination Modes                        | Infrastructure mode, Ad hoc mode *1, AP mode *2 *3    |
| Wireless Security                         | WEP (64/128bit), WPA2-PSK (AES)*4, WPA2-Enterprise *5 |

\*1 Not supported for IEEE 802.11n.

\*2 Not supported for IEEE 802.11b.

\*3 AP mode connection and Wi-Fi connection can be used at the same time.

\*4 Complies with WPA2 standards with support for WPA/WPA2 Personal.

\*5 Complies with WPA2 standards with support for WPA/WPA2 Enterprise.

## Security Protocol

|                                  |   |
|----------------------------------|---|
| SSL/TLS                          | <p>HTTPS (Server/Client), SMTPS (Client), STARTTLS, Root certificate (Client), Root certificate updating (Client), CA-signed certificate (Server), CA certificate (Server), CSR generation (Server), Self-signed certificate (Server), EC key CSR/self-signed certificate generation (Server), Certificates/Secret key imports (Server)</p> |
| Authentication for Email sending | <p>POP before SMTP, APOP, SMTP Authentication</p>   |

## Technical Specifications

|   |        |
|---|--------|
| MIB accessing Authentication/Encryption | SNMPv3 |
|---|--------|

## Dimensional Specifications

|              |  |
|--------------|--|
| Dimensions * | Width: 296 mm (11.7 inches)<br>Depth: 169 mm (6.7 inches)<br>Height: 176 mm (6.9 inches) |
| Weight       | Approx. 3.7 kg (8.2 lb)  |

\* Without protruding parts.

## Electrical Specifications

### Scanner Electrical Specifications

|                                     |  |
|-------------------------------------|--|
| Rated DC Input Power Supply Voltage | DC 24 V  |
| Rated DC Input Current              | 2 A  |
| Power Consumption                   | USB Connection<br><input type="checkbox"/> Operating: Approx. 17 W<br><input type="checkbox"/> Ready mode: Approx. 9.2 W<br><input type="checkbox"/> Sleep mode : Approx. 1.2 W<br><input type="checkbox"/> Power off: Approx. 0.1 W<br><br>Wi-Fi Connection<br><input type="checkbox"/> Operating: Approx. 18 W<br><input type="checkbox"/> Ready mode: Approx. 9.2 W<br><input type="checkbox"/> Sleep mode : Approx. 1.4 W<br><input type="checkbox"/> Power off: Approx. 0.1 W |

### AC Adapter Electrical Specifications

|                                   |  |
|-----------------------------------|--|
| Model                             | A471H (AC 100 to 240 V)<br>A472E (AC 220 to 240 V) |
| Rated Input Current               | 1.2 A  |
| Rated Frequency Range             | 50 to 60 Hz  |
| Rated Output Power Supply Voltage | DC 24 V  |
| Rated Output Current              | 2 A  |



## Technical Specifications

### Environmental Specifications

|                      |                |   |
|----------------------|----------------|---|
| Temperature          | When operating | 5 to 35 °C (41 to 95 °F)  |
|                      | When stored    | -25 to 60 °C (-13 to 140 °F)  |
| Humidity             | When operating | 15 to 80% (without condensation)  |
|                      | When stored    | 15 to 85% (without condensation)  |
| Operating conditions |                | Ordinary office or home conditions. Avoid operating the scanner in direct sunlight, near a strong light source, or in extremely dusty conditions. |

### System Requirements

|             |   |
|-------------|---|
| Windows     | Windows 10 (32-bit, 64-bit)<br>Windows 8.1 (32-bit, 64-bit)<br>Windows 8 (32-bit, 64-bit)<br>Windows 7 (32-bit, 64-bit) |
| Mac OS*1 *2 | macOS High Sierra<br>macOS Sierra<br>OS X El Capitan  |

\*1 Fast User Switching on Mac OS or later is not supported.

\*2 The UNIX File System (UFS) for Mac OS is not supported.

# Standards and Approvals

---

## Standards and Approvals for European Models

### Product and AC adapter

For European users

Hereby, Seiko Epson Corporation declares that the following radio equipment models are in compliance with Directive 2014/53/EU. The full text of the EU declaration of conformity is available at the following website.

<http://www.epson.eu/conformity>

J381B

A471H, A472E

For use only in Ireland, UK, Austria, Germany, Liechtenstein, Switzerland, France, Belgium, Luxembourg, Netherlands, Italy, Portugal, Spain, Denmark, Finland, Norway, Sweden, Iceland, Croatia, Cyprus, Greece, Slovenia, Malta, Bulgaria, Czech, Estonia, Hungary, Latvia, Lithuania, Poland, Romania, and Slovakia.

Epson cannot accept responsibility for any failure to satisfy the protection requirements resulting from a non-recommended modification of the product.



---

## Standards and Approvals for Australian Models

### Product

|     |                        |
|-----|------------------------|
| EMC | AS/NZS CISPR32 Class B |
|-----|------------------------|

Epson hereby declares that the following equipment Models are in compliance with the essential requirements and other relevant provisions of AS/NZS4268:

J381B

Epson cannot accept responsibility for any failure to satisfy the protection requirements resulting from a non-recommended modification of the product.

### AC adapter (A471H)

|     |                        |
|-----|------------------------|
| EMC | AS/NZS CISPR32 Class B |
|-----|------------------------|

# Where to Get Help

---

## Technical Support Web Site

If you need further help, visit the Epson support website shown below. Select your country or region and go to the support section of your local Epson website. The latest drivers, FAQs, manuals, or other downloadables are also available from the site.

<http://support.epson.net/>

<http://www.epson.eu/Support> (Europe)

If your Epson product is not operating properly and you cannot solve the problem, contact Epson support services for assistance.

---

## Contacting Epson Support

### Before Contacting Epson

If your Epson product is not operating properly and you cannot solve the problem using the troubleshooting information in your product manuals, contact Epson support services for assistance. If Epson support for your area is not listed below, contact the dealer where you purchased your product.

Epson support will be able to help you much more quickly if you give them the following information:

- Product serial number  
(The serial number label is usually on the back of the product.)
- Product model
- Product software version  
(Click **About**, **Version Info**, or a similar button in the product software.)
- Brand and model of your computer
- Your computer operating system name and version
- Names and versions of the software applications you normally use with your product

**Note:**

*Depending on the product, the dial list data for fax and/or network settings may be stored in the product's memory. Due to breakdown or repair of a product, data and/or settings may be lost. Epson shall not be responsible for the loss of any data, for backing up or recovering data and/or settings even during a warranty period. We recommend that you make your own backup data or take notes.*

### Help for Users in Europe

Check your Pan-European Warranty Document for information on how to contact Epson support.

## Where to Get Help

### Help for Users in Australia

Epson Australia wishes to provide you with a high level of customer service. In addition to your product manuals, we provide the following sources for obtaining information:

#### Internet URL

<http://www.epson.com.au>

Access the Epson Australia World Wide Web pages. Worth taking your modem here for the occasional surf! The site provides a download area for drivers, Epson contact points, new product information and technical support (e-mail).

#### Epson Helpdesk

Phone: 1300-361-054

Epson Helpdesk is provided as a final backup to make sure our clients have access to advice. Operators on the Helpdesk can aid you in installing, configuring and operating your Epson product. Our Pre-sales Helpdesk staff can provide literature on new Epson products and advise where the nearest dealer or service agent is located. Many types of queries are answered here.

We encourage you to have all the relevant information on hand when you ring. The more information you prepare, the faster we can help solve the problem. This information includes your Epson product manuals, type of computer, operating system, application programs, and any information you feel is required.

#### Transportation of Product

Epson recommends retaining product packaging for future transportation.