



# DeskMini 300 series

Version 1.0

Published April 2018



This device complies with Part 15 of the FCC Rules. Operation is subject to the following two conditions:

- (1) this device may not cause harmful interference, and
- (2) this device must accept any interference received, including interference that may cause undesired operation.

### **CALIFORNIA, USA ONLY**

The Lithium battery adopted on this motherboard contains Perchlorate, a toxic substance controlled in Perchlorate Best Management Practices (BMP) regulations passed by the California Legislature. When you discard the Lithium battery in California, USA, please follow the related regulations in advance.

“Perchlorate Material-special handling may apply, see [www.dtsc.ca.gov/hazardouswaste/perchlorate](http://www.dtsc.ca.gov/hazardouswaste/perchlorate)”

## AUSTRALIA ONLY

Our goods come with guarantees that cannot be excluded under the Australian Consumer Law. You are entitled to a replacement or refund for a major failure and compensation for any other reasonably foreseeable loss or damage caused by our goods. You are also entitled to have the goods repaired or replaced if the goods fail to be of acceptable quality and the failure does not amount to a major failure.

The terms HDMI™ and HDMI High-Definition Multimedia Interface, and the HDMI logo are trademarks or registered trademarks of HDMI Licensing LLC in the United States and other countries.



# Contents

<b>Chapter 1 Introduction</b>	<b>1</b>
1.1 Package Contents	1
1.2 Specifications	2
<b>Chapter 2 Product Overview</b>	<b>4</b>
2.1 Front View	4
2.2 Rear View	5
2.3 Motherboard Layout	6
<b>Chapter 3 Hardware Installation</b>	<b>12</b>
3.1 Begin Installation	12
3.2 Installing the CPU	13
3.3 Installing the CPU Fan and Heatsink	15
3.4 Installing Memory Modules (SO-DIMM)	16
3.5 Installing the WiFi Module	17
3.6 Installing the M.2 SSD (Type 2280)	18
3.7 Installing the 2.5-inch HDD/SSD	19
3.8 Complete	21
3.9 Installing the VESA Bracket (Optional)	22
3.10 Installing the WiFi Antennas (Optional)	24
<b>Chapter 4 Software and Utilities Operation</b>	<b>26</b>
4.1 Installing Drivers	26
<b>Chapter 5 UEFI SETUP UTILITY</b>	<b>27</b>
5.1 Introduction	27

5.2	EZ Mode	28
5.3	Advanced Mode	29
5.3.1	UEFI Menu Bar	29
5.3.2	Navigation Keys	30
5.4	Main Screen	31
5.5	OC Tweaker Screen	32
5.6	Advanced Screen	41
5.6.1	CPU Configuration	42
5.6.2	Chipset Configuration	44
5.6.3	Storage Configuration	46
5.6.4	Super IO Configuration	47
5.6.5	ACPI Configuration	48
5.6.6	USB Configuration	49
5.6.7	Trusted Computing	50
5.7	Tools	51
5.8	Hardware Health Event Monitoring Screen	53
5.9	Security Screen	54
5.10	Boot Screen	55
5.11	Exit Screen	58

# Chapter 1 Introduction

Thank you for purchasing DeskMini 300 series barebone system. In this documentation, Chapter 1 and 2 contains the introduction of the barebone system and step-by-step installation guides. Chapter 3 contains the guide of hardware installation. Chapter 4 contains the operation guide of the software and utilities. Chapter 5 contains the configuration guide of the BIOS setup.



*Because the barebone system specifications and the BIOS software might be updated, the content of this documentation will be subject to change without notice.*

## 1.1 Package Contents

- DeskMini 300 series Barebone System with:
  - DeskMini 300 series Chassis
  - Motherboard (pre-installed)
- \*The barebone system does not include memory, hard drive, WiFi module and M.2 SSD.
- 120W/19V Power Adapter & Power Cord (Optional)
- SATA Cable (Optional)
- Screws Package (HDD Screw x 6, M.2 Screw x 2pcs, Rubber Foot x 4pcs)
- Support CD (Optional)
- Quick Installation Guide (Optional)

\*Package contents may vary based on local distribution.



*If any items are missing or appear damaged, contact your authorized dealer.*

## 1.2 Specifications

- System Model**
- DeskMini 310
  - DeskMini 310/COM
  - DeskMini 360
  - DeskMini 370

- Chassis**
- 1.92L (155 x 155 x 80mm)

- CPU**
- Supports 8<sup>th</sup> Generation Intel® Core™ Processors (Socket 1151, up to TDP 65W)

- CPU cooling**
- Supports Standard Intel Box Fan Coolers

- Motherboard**
- H310M-STX (Mini-STX) (for DeskMini 310)
  - H310M-STX/COM (Mini-STX) (for DeskMini 310/COM)
  - B360M-STX (Mini-STX) (for DeskMini 360)
  - Q370M-STX (Mini-STX) (for DeskMini 370)

- Chipset**
- Intel® H310 Chipset (for DeskMini 310, 310/COM series)
  - Intel® B360 Chipset (for DeskMini 360 series)
  - Intel® Q370 Chipset (for DeskMini 370 series)

- Graphics**
- Intel® UHD Graphics

- Memory**
- Supports DDR4 2666MHz, 2 x SO-DIMM Slots, Max. 32GB

- Audio**
- Realtek ALC233 Audio Codec

- LAN**
- Intel Gigabit I219V LAN (for DeskMini 310, 310/COM & 360 series)
  - Intel Gigabit I219LM LAN (for DeskMini 370)\*
- \*Supports Intel® vPro™ Technology

**Expansion Slots**

- 1 x M.2 (E key/2230) Slot for WiFi + BT Module, 1 x M.2 SSD Slot (Supports type 2230 WiFi/BT module and Intel® CNVi (Integrated WiFi/BT))
- 1 x SD Card Socket (Supports SDXC Card (3.3V))

**Front I/O**

- Power Button (with power LED & HDD LED)
- 1 x USB 3.1 Gen1 (Type-A), 1 x USB 3.1 Gen1 (Type-C), 1 x Headphone/Headset Jack , 1 x MIC-In

**Rear I/O**

- 1 x VGA , 1 x HDMI, 1 x DP, 1 x USB 3.1 Gen1, 1 x USB 2.0, 1 x LAN, 1 x DC-In Jack (for DeskMini 310 series)
- 1 x VGA , 1 x HDMI, 1 x DP, 2 x USB 3.1 Gen1, 1 x LAN, 1 x DC-In Jack (for DeskMini 370 & 360 series)

**Onboard Connectors**

- 1 x USB 2.0 Header
- 1 x COM Port Header (only for DeskMini 310/COM)
- 1 x Front Panel Header
- 2 x CPU\_Fan Connectors
- 1 x DC-In Jack (Supports 19V Power Adapters)
- 1 x Internal Speaker Header (4-Pin)
- 1 x Audio Header (4-Pin)

**Drive Bays**

- 2 x 2.5" HDD or SSD

**Power Adapter**

- 120W/19V Power Adapter

**Operation Temp.**

- 0~35°C



Please realize that there is a certain risk involved with overclocking, including adjusting the setting in the BIOS, applying Untied Overclocking Technology, or using third-party overclocking tools. Overclocking may affect your system's stability, or even cause damage to the components and devices of your system. It should be done at your own risk and expense. We are not responsible for possible damage caused by overclocking.



# Chapter 2 Product Overview

This chapter provides diagrams showing the location of important components of the DeskMini 300 Barebone system series.

## 2.1 Front View

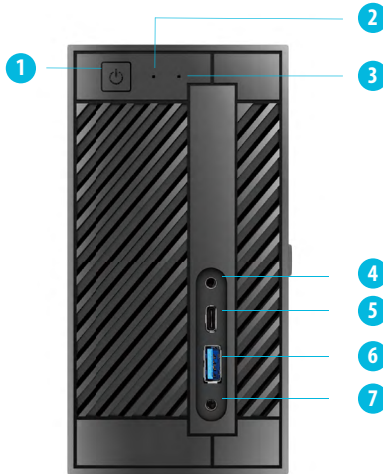

No.	Description
1	Power Button
2	Power LED
3	HDD LED
4	MIC-In
5	USB 3.1 Gen1 Type-C Port
6	USB 3.1 Gen1 Type-A Port
7	Headphone/Headset

## 2.2 Rear View

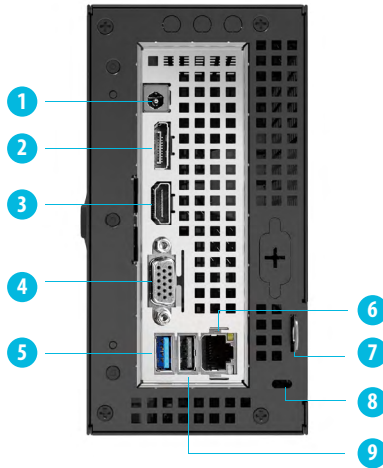

No.	Description
1	DC Jack (Supports 19V DC Power Adapters)
2	Display Port
3	HDMI Port
4	D-Sub Port
5	USB 3.1 Gen1 Port
6	LAN RJ-45 Port*
7	Key Lock
8	Kensington Lock
9	USB 2.0 Port (for DeskMini 310 series) USB 3.1 Gen1 Port ( for DeskMini 370 & 360 series)

\* There are two LEDs on the LAN port. Please refer to the table below for the LAN port LED indications.

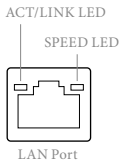

Activity / Link LED		Speed LED	
Status	Description	Status	Description
Off	No Link	Off	10Mbps connection
Blinking	Data Activity	Orange	100Mbps connection
On	Link	Green	1Gbps connection

## 2.3 Motherboard Layout

### Top View

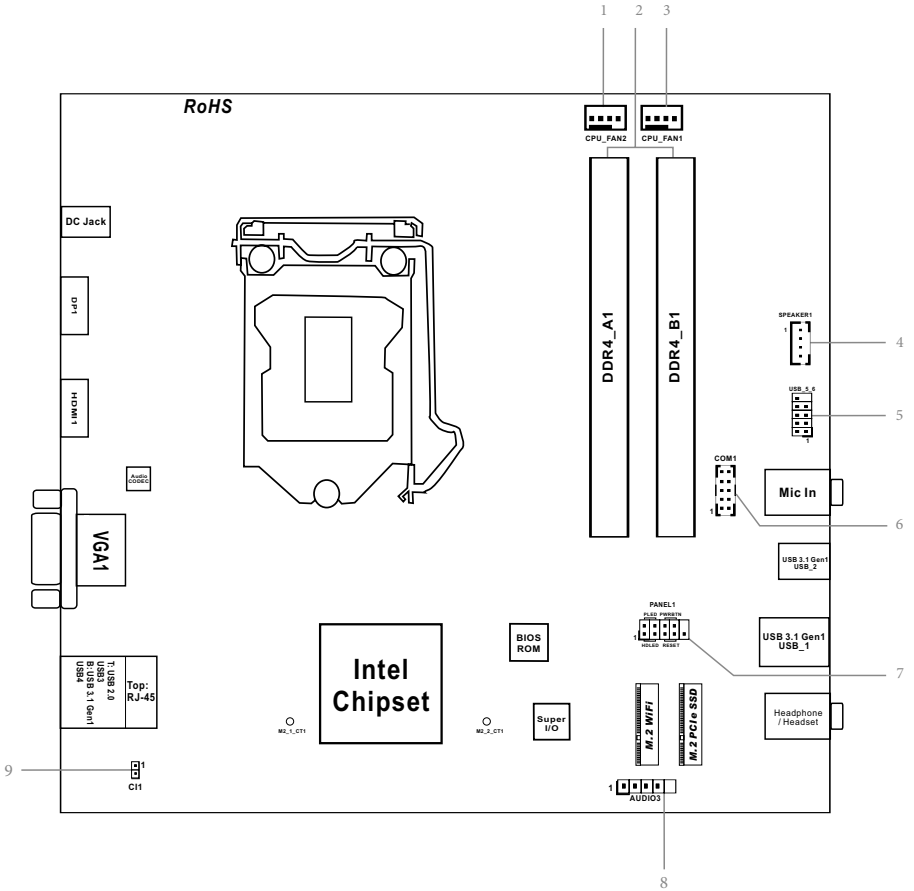

## Bottom View

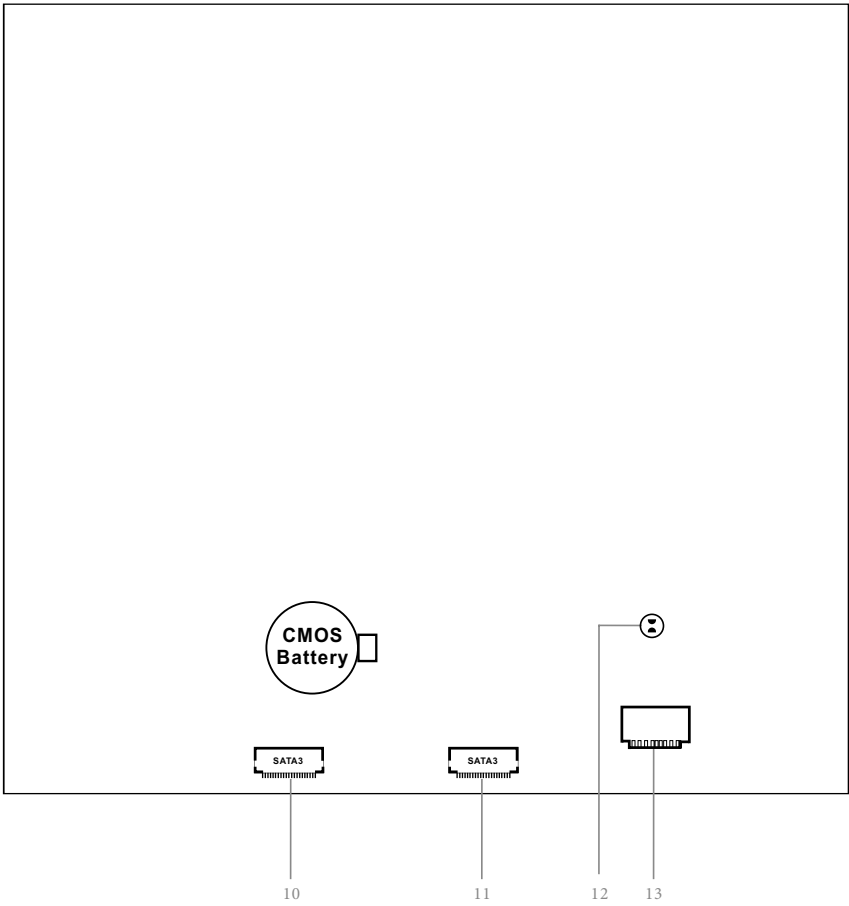

No.	Description
1	CPU Fan Connector (CPU_FAN2)
2	2 x 260-pin DDR4 SO-DIMM Slots (DDR4_A1, DDR4_B1)
3	CPU Fan Connector (CPU_FAN1)
4	Internal Speaker Header (SPEAKER1)
5	USB 2.0 Header (USB_5_6)
6	COM Port Header (COM1) (for H310M-STX/COM only)
7	System Panel Header (PANEL1)
8	Audio Header (AUDIO3)
9	Chassis Intrusion Header (CI1)
10	SATA3 Connector (SATA1)
11	SATA3 Connector (SATA2)
12	Clear CMOS Pad
13	SD Card Slot

## Onboard Headers and Connectors



Onboard headers and connectors are NOT jumpers. Do NOT place jumper caps over these headers and connectors. Placing jumper caps over the headers and connectors will cause permanent damage to the motherboard.

System Panel Header  
(9-pin PANEL1)  
(see p.6, No. 7)

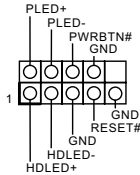

Connect the power button, reset button and system status indicator on the chassis to this header according to the pin assignments below. Note the positive and negative pins before connecting the cables.



**PWRBTN (Power Button):**

Connect to the power button on the chassis front panel. You may configure the way to turn off your system using the power button.

**RESET (Reset Button):**

Connect to the reset button on the chassis front panel. Press the reset button to restart the computer if the computer freezes and fails to perform a normal restart.

**PLED (System Power LED):**

Connect to the power status indicator on the chassis front panel. The LED is on when the system is operating. The LED keeps blinking when the system is in S1/S3 sleep state. The LED is off when the system is in S4 sleep state or powered off (S5).

**HDLED (Hard Drive Activity LED):**

Connect to the hard drive activity LED on the chassis front panel. The LED is on when the hard drive is reading or writing data.

The front panel design may differ by chassis. A front panel module mainly consists of power button, reset button, power LED, hard drive activity LED, speaker and etc. When connecting your chassis front panel module to this header, make sure the wire assignments and the pin assignments are matched correctly.

Internal Speaker Header  
(4-pin SPEAKER1)  
(see p.6, No. 4)

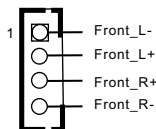

Please connect the chassis speaker to this header.

Serial ATA3 Connectors  
(see p.7, No. 10 and 11)

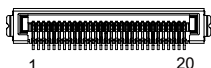

These two SATA3 connectors support SATA data cables for internal storage devices with up to 6.0 Gb/s data transfer rate.  
\*The SATA3 connectors support 2.5-inch hard drive (+5V) and do not support 3.5-inch hard drive (+12V)

PIN	Signal Name	PIN	Signal Name
1	GND	11	N/A
2	LVDS_TX+	12	5V
3	LVDS_TX-	13	5V
4	GND	14	5V
5	GND	15	5V
6	LVDS_RX-	16	5V
7	LVDS_RX+	17	N/A
8	GND	18	GND
9	GND	19	GND
10	GND	20	GND

USB 2.0 Header  
(9-pin USB\_5\_6)  
(see p.6, No. 5)

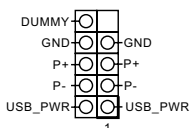

There is one header on this motherboard. This USB 2.0 header can support two ports.

CPU Fan Connectors  
(4-pin CPU\_FAN1)  
(see p.6, No. 3)  
(4-pin CPU\_FAN2)  
(see p.6, No. 1)

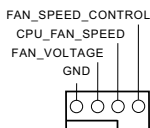

This motherboard provides two 4-Pin CPU fan (Quiet Fan) connectors. If you plan to connect a 3-Pin CPU fan, please connect it to Pin 1-3.

Serial Port Header  
(for DeskMini 310/COM  
only)  
(9-pin COM1)  
(see p.6, No. 6)

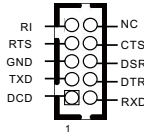

This COM1 header supports a serial port module.

Chassis Intrusion Header  
(2-pin C11)  
(see p.6, No. 9)

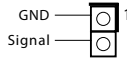

This motherboard supports CASE OPEN detection feature that detects if the chassis cover has been removed. This feature requires a chassis with chassis intrusion detection design.

Clear CMOS Pad  
(see p.7, No. 12)



Clear CMOS Pad allows you to clear the data in CMOS. To clear CMOS, disconnect the power supply and short the Clear CMOS Pad.

Audio Header  
(5-pin AUDIO3)  
(see p.6, No. 8)

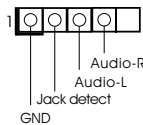

This Audio header allows you to connect the audio cable for headphone.



# Chapter 3 Hardware Installation

## 3.1 Begin Installation

1. Unscrew the four screws of the back panel.

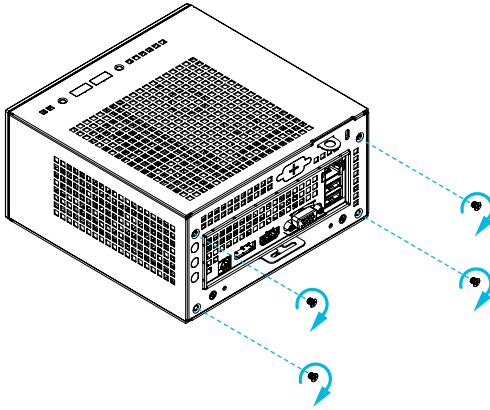

2. Pull out the motherboard tray while holding the handle .

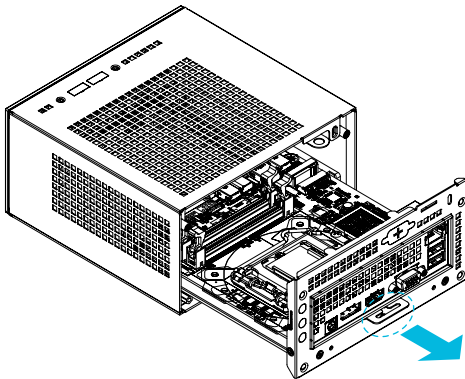

## 3.2 Installing the CPU

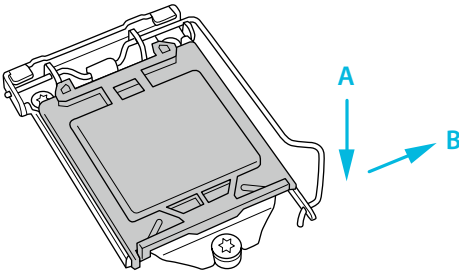
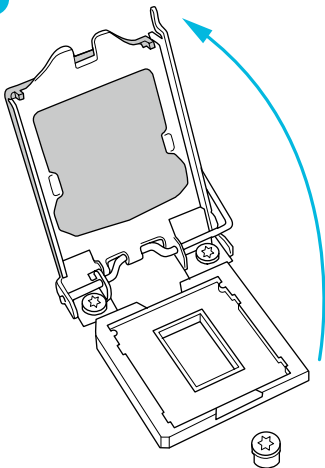

1. Before you insert the 1151-Pin CPU into the socket, please check if the **PnP cap** is on the socket, if the CPU surface is unclean, or if there are any **bent pins** in the socket. Do not force to insert the CPU into the socket if above situation is found. Otherwise, the CPU will be seriously damaged.
2. Unplug all power cables before installing the CPU.

**1****2**

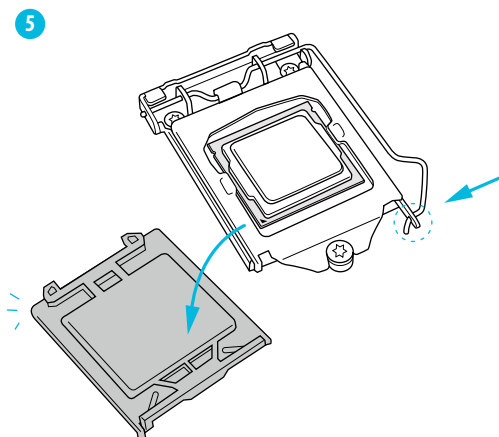
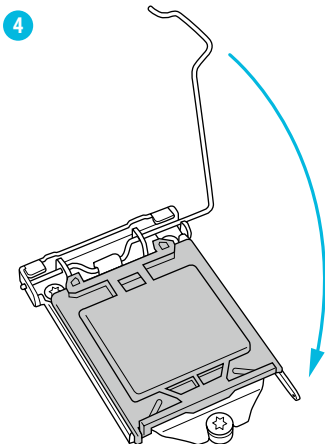
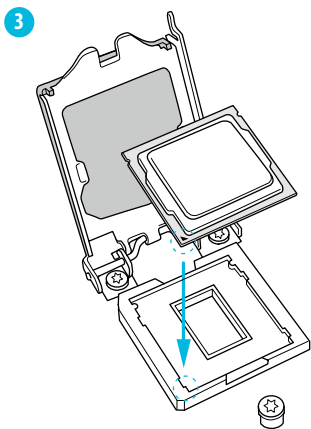

Please save and replace the cover if the processor is removed. The cover must be placed if you wish to return the motherboard for after service.

### 3.3 Installing the CPU Fan and Heatsink

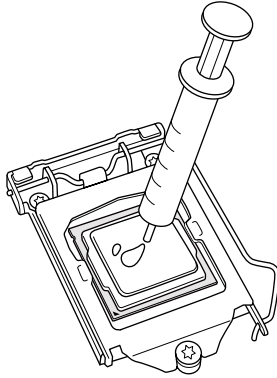
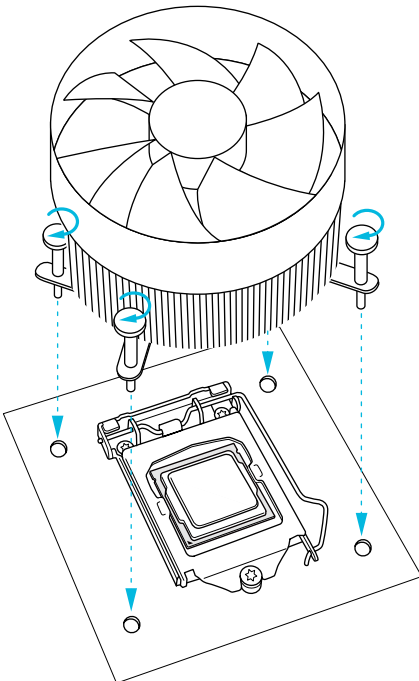
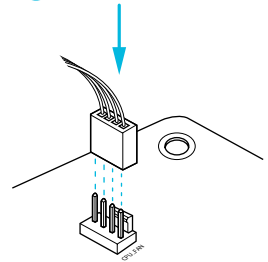

*DeskMini 300 series supports both Intel CPU Box Fan (65W) and third-party CPU fan cooler. Please note that the DeskMini 300 series chassis has 52mm height limitation for the CPU fan cooler.*

**1****2****3**

### 3.4 Installing Memory Modules (SO-DIMM)

This motherboard provides two 260-pin DDR4 (Double Data Rate 4) SO-DIMM slots.



1. DeskMini 300 series requires DDR4 SO-DIMM.
2. For dual channel configuration, you always need to install identical (the same brand, speed, size and chip-type) DDR4 SO-DIMM pairs.



1. It is not allowed to install a DDR, DDR2 or DDR3 memory module into a DDR4 slot; otherwise, this motherboard and SO-DIMM may be damaged.
2. The SO-DIMM only fits in one correct orientation. It will cause permanent damage to the motherboard and the SO-DIMM if you force the SO-DIMM into the slot at incorrect orientation.

1

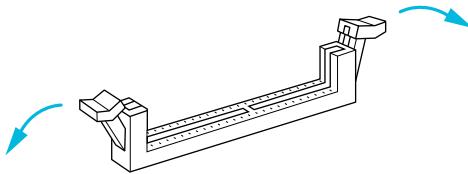

2

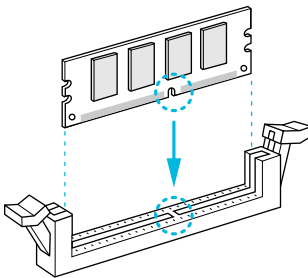

3

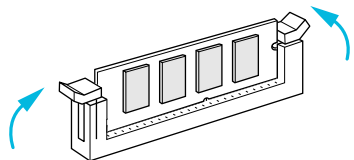

## 3.5 Installing the WiFi Module

1. Insert the WiFi Module Card into the M.2 Slot for WiFi + BT Module.

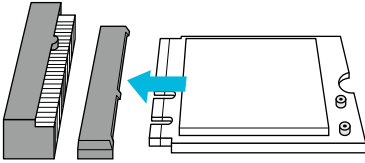

2. Tighten the screw to secure the WiFi Module Card to the motherboard.

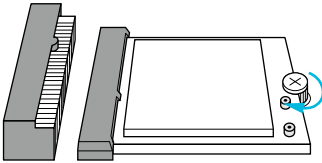

3. Attach the SMA Wi-Fi Antenna Cables to the WiFi Module.

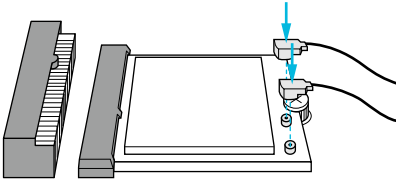

### 3.6 Installing the M.2 SSD (Type 2280)

1. Locate the M.2 slot on the motherboard.

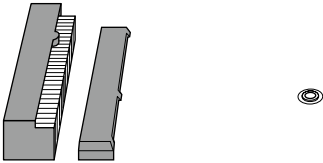

2. Carefully insert the M.2 SSD into the slot.

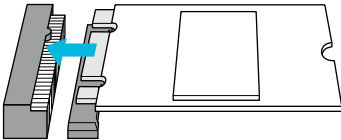

3. Tighten the screw to secure the M.2 SSD to the motherboard.

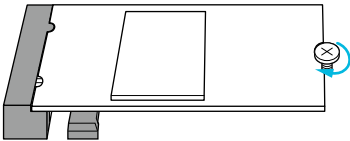

### 3.7 Installing the 2.5-inch HDD/SSD

1. Place another HDD/SSD on the tray B shown in Step 1. Then turn the motherboard tray upside down and secure the HDD/SSD with the four screws.

\*Removing the motherboard before installing the second HDD/SSD.

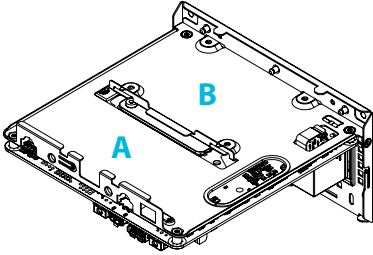

2. Connect the SATA Data and Power Cable to the HDD/SSD.

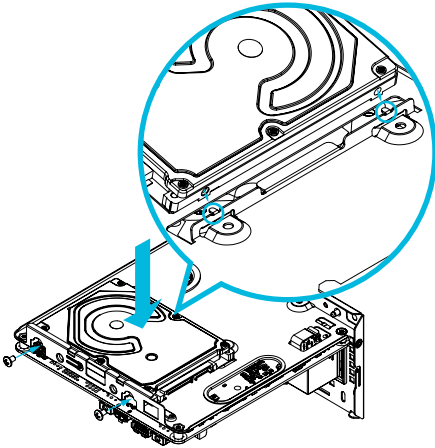

3. Connect the other end of the SATA Cables to the SATA Connectors on the motherboard.

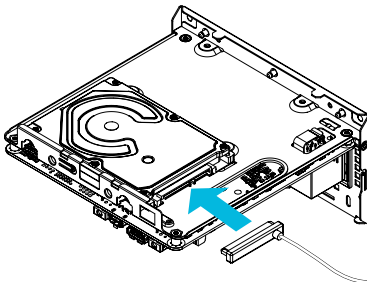



4. Place another HDD/SSD on the tray B shown in Step 1.  
Then turn the motherboard tray upside down and secure the HDD/SSD with the four screws.  
\*Removing the motherboard before installing the second HDD/SSD.

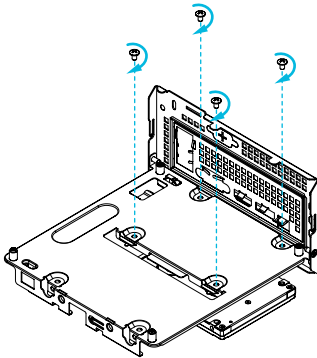

5. Connect the SATA Data and Power Cable to the HDD/SSD.

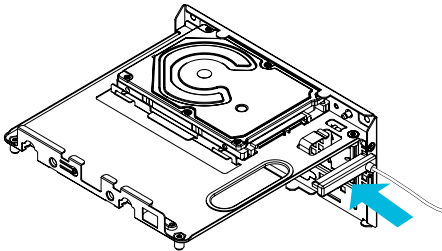

6. Connect the other end of the SATA Cables to the SATA Connectors on the motherboard.

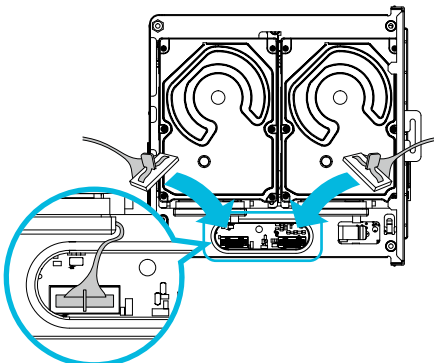

## 3.8 Complete

1. Connect the power button cable to the System Panel Header on the motherboard.

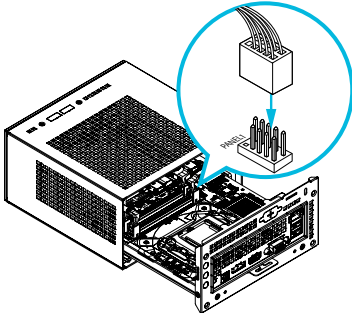

2. Align the motherboard tray with the two sliding tracks on the chassis while sliding it back to the chassis.

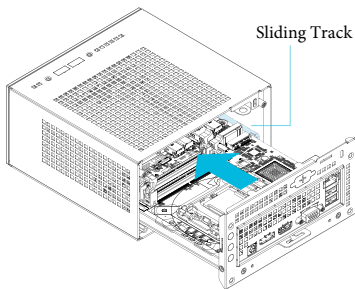

3. Then refasten the four screws that you removed earlier.

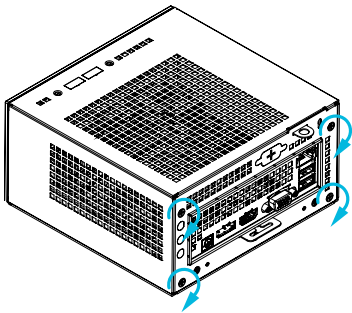

### 3.9 Installing the VESA Bracket (Optional)

1. Secure the VESA Bracket to the right side panel of the DeskMini 300 series by using the four screws.

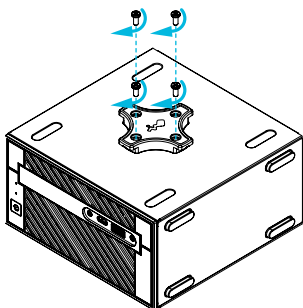

2. Attach the other VESA Bracket to the rear of a compatible display using the four screws.  
\*Choose mounting holes depending on the mounting hole pattern of your LCD screen (75 mm × 75 mm or 100 mm × 100 mm).

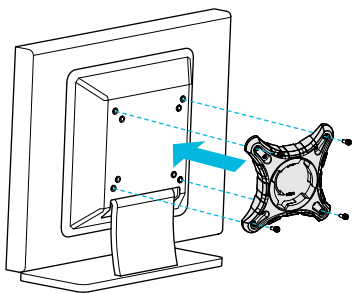

3. Mount the DeskMini 300 series by turning it counterclockwise.

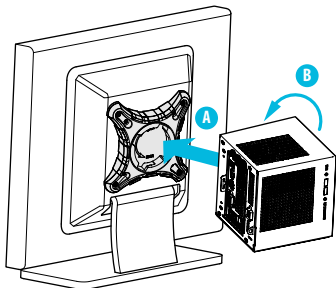

4. Complete.

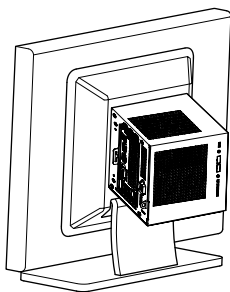

### 3.10 Installing the WiFi Antennas (Optional)

1. Insert the Wi-Fi Antenna Connectors to the antenna ports on the rear panel of the DeskMini 300 series

\*Please make sure to align the flat surface of Wi-Fi Antenna Connectors with the flat side of holes when inserting the connectors.

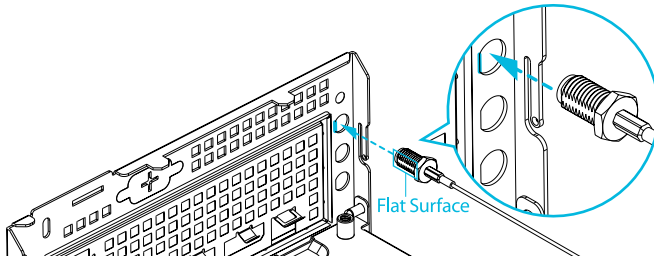

2. Fasten the screw nuts to secure the antenna connectors.

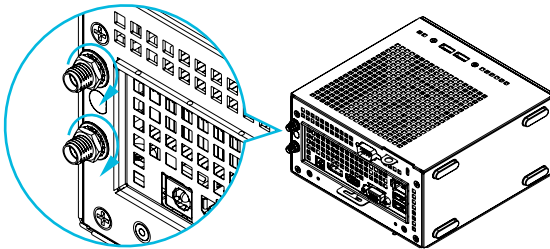

3. Connect the two WiFi 2.4/5 GHz Antennas to the antenna connectors. Turn the antenna clockwise until it is securely connected.

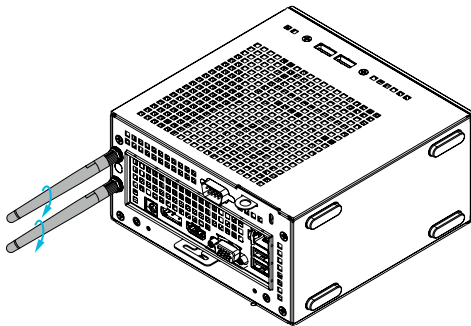

4. Set the WiFi 2.4/5 GHz Antenna at 90-degree angle.  
\*You may need to adjust the direction of the antenna for a stronger signal.

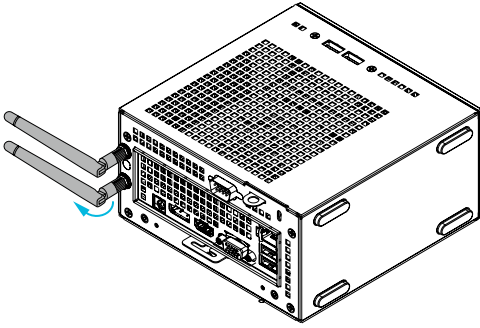

# Chapter 4 Software and Utilities Operation

## 4.1 Installing Drivers

The Support CD that comes with the motherboard contains necessary drivers and useful utilities that enhance the motherboard's features.

### Running The Support CD

To begin using the support CD, insert the CD into your CD-ROM drive. The CD automatically displays the Main Menu if "AUTORUN" is enabled in your computer. If the Main Menu does not appear automatically, locate and double click on the file "ASRSETUP.EXE" in the Support CD to display the menu.

### Drivers Menu

The drivers compatible to your system will be auto-detected and listed on the support CD driver page. Please click **Install All** or follow the order from top to bottom to install those required drivers. Therefore, the drivers you install can work properly.

### Utilities Menu

The Utilities Menu shows the application software that the motherboard supports. Click on a specific item then follow the installation wizard to install it.

# Chapter 5 UEFI SETUP UTILITY

## 5.1 Introduction

This section explains how to use the UEFI SETUP UTILITY to configure your system. You may run the UEFI SETUP UTILITY by pressing <F2> or <Del> right after you power on the computer, otherwise, the Power-On-Self-Test (POST) will continue with its test routines. If you wish to enter the UEFI SETUP UTILITY after POST, restart the system by pressing <Ctl> + <Alt> + <Delete>, or by pressing the reset button on the system chassis. You may also restart by turning the system off and then back on.



*Because the UEFI software is constantly being updated, the following UEFI setup screens and descriptions are for reference purpose only, and they may not exactly match what you see on your screen.*



## 5.2 EZ Mode

The EZ Mode screen appears when you enter the BIOS setup program by default. EZ mode is a dashboard which contains multiple readings of the system's current status. You can check the most crucial information of your system, such as CPU speed, DRAM frequency, SATA information, fan speed, etc.

Press <F6> or click the "Advanced Mode" button at the upper right corner of the screen to switch to "Advanced Mode" for more options.

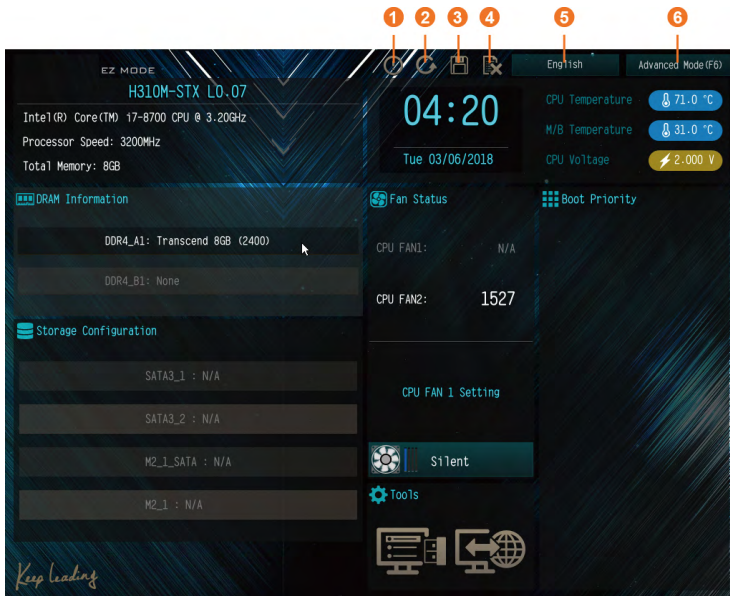

No.	Function
1	Help
2	Load UEFI Defaults
3	Save Changes and Exit
4	Discard Changes
5	Change Language
6	Switch to Advanced Mode

## 5.3 Advanced Mode

The Advanced Mode provides more options to configure the BIOS settings. Refer to the following sections for the detailed configurations.

To access the EZ Mode, press <F6> or click the "EZ Mode" button at the upper right corner of the screen.

### 5.3.1 UEFI Menu Bar

The top of the screen has a menu bar with the following selections:

<b>Main</b>	For setting system time/date information
<b>OC Tweaker</b>	For overclocking configurations
<b>Advanced</b>	For advanced system configurations
<b>Tool</b>	Useful tools
<b>H/W Monitor</b>	Displays current hardware status
<b>Security</b>	For security settings
<b>Boot</b>	For configuring boot settings and boot priority
<b>Exit</b>	Exit the current screen or the UEFI Setup Utility

## 5.3.2 Navigation Keys

Use <←> key or <→> key to choose among the selections on the menu bar, and use <↑> key or <↓> key to move the cursor up or down to select items, then press <Enter> to get into the sub screen. You can also use the mouse to click your required item.

Please check the following table for the descriptions of each navigation key.

Navigation Key(s)	Description
+ / -	To change option for the selected items
<Tab>	Switch to next function
<PGUP>	Go to the previous page
<PGDN>	Go to the next page
<HOME>	Go to the top of the screen
<END>	Go to the bottom of the screen
<F1>	To display the General Help Screen
<F5>	Add / Remove Favorite
<F7>	Discard changes and exit the SETUP UTILITY
<F9>	Load optimal default values for all the settings
<F10>	Save changes and exit the SETUP UTILITY
<F12>	Print screen
<ESC>	Jump to the Exit Screen or exit the current screen

## 5.4 Main Screen

When you enter the UEFI SETUP UTILITY, the Main screen will appear and display the system overview.

### DeskMini 310:

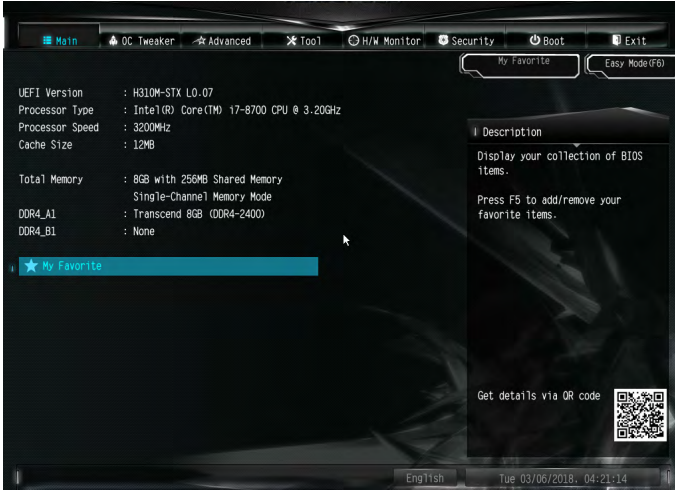

### DeskMini 310/COM:

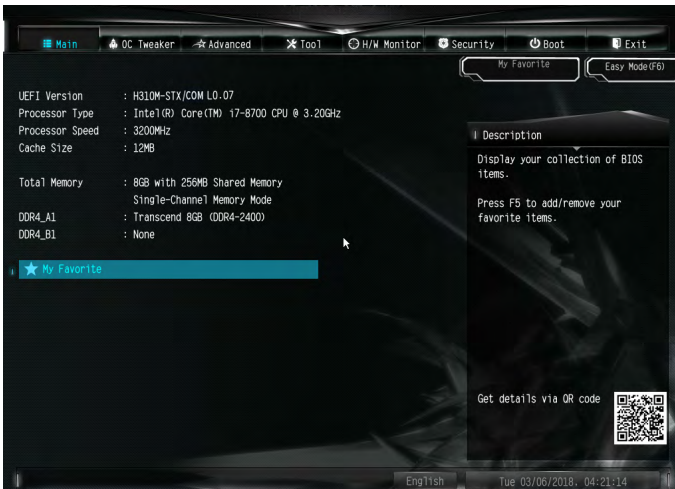

### My Favorite

Display your collection of BIOS items. Press F5 to add/remove your favorite items.

## 5.5 OC Tweaker Screen

In the OC Tweaker screen, you can set up overclocking features.

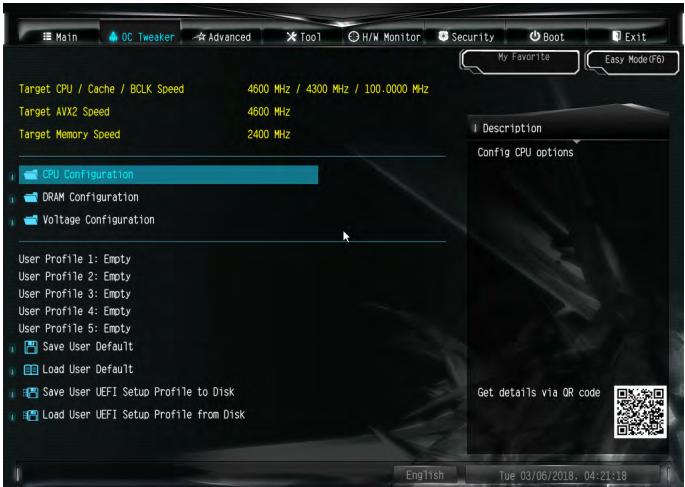

*Because the UEFI software is constantly being updated, the following UEFI setup screens and descriptions are for reference purpose only, and they may not exactly match what you see on your screen.*

### CPU Configuration

#### Boot Performance Mode

Default is Max Non-Turbo performance mode. It will keep cpu Flex-ratio till OS handoff. Max Battery mode will set CPU ratio as x8 till OS handoff. This option is suggested for BCLK overclocking.

#### FCLK Frequency

Configure the FCLK Frequency.

#### Intel SpeedStep Technology

Intel SpeedStep technology allows processors to switch between multiple frequencies and voltage points for better power saving and heat dissipation.

## Intel Turbo Boost Technology

Intel Turbo Boost Technology enables the processor to run above its base operating frequency when the operating system requests the highest performance state.

## Intel Speed Shift Technology

Enable/Disable Intel Speed Shift Technology support. Enabling will expose the CPPC v2 interface to allow for hardware controlled P-states.

## Long Duration Power Limit

Configure Package Power Limit 1 in watts. When the limit is exceeded, the CPU ratio will be lowered after a period of time. A lower limit can protect the CPU and save power, while a higher limit may improve performance.

## Long Duration Maintained

Configure the period of time until the CPU ratio is lowered when the Long Duration Power Limit is exceeded.

## Short Duration Power Limit

Configure Package Power Limit 2 in watts. When the limit is exceeded, the CPU ratio will be lowered immediately. A lower limit can protect the CPU and save power, while a higher limit may improve performance.

## CPU Core Current Limit

Configure the current limit of the CPU core. A lower limit can protect the CPU and save power, while a higher limit may improve performance.

## GT Current Limit

Configure the current limit of the GT slice. A lower limit can protect the CPU and save power, while a higher limit may improve performance.

## DRAM Configuration

### DRAM Tweaker

Fine tune the DRAM settings by leaving marks in checkboxes. Click OK to confirm and apply your new settings.

### DRAM Timing Configuration

#### DRAM Frequency

If [Auto] is selected, the motherboard will detect the memory module(s) inserted and assign the appropriate frequency automatically.

## Primary Timing

### CAS# Latency (tCL)

The time between sending a column address to the memory and the beginning of the data in response.

### RAS# to CAS# Delay and Row Precharge (tRCDtRP)

RAS# to CAS# Delay: The number of clock cycles required between the opening of a row of memory and accessing columns within it.

Row Precharge: The number of clock cycles required between the issuing of the precharge command and opening the next row.

### RAS# Active Time (tRAS)

The number of clock cycles required between a bank active command and issuing the precharge command.

### Command Rate (CR)

The delay between when a memory chip is selected and when the first active command can be issued.

## Secondary Timing

### Write Recovery Time (tWR)

The amount of delay that must elapse after the completion of a valid write operation, before an active bank can be precharged.

### Refresh Cycle Time (tRFC)

The number of clocks from a Refresh command until the first Activate command to the same rank.

### RAS to RAS Delay (tRRD\_L)

The number of clocks between two rows activated in different banks of the same rank.

### RAS to RAS Delay (tRRD\_S)

The number of clocks between two rows activated in different banks of the same rank.

### Write to Read Delay (tWTR\_L)

The number of clocks between the last valid write operation and the next read command to the same internal bank.

### Write to Read Delay (tWTR\_S)

The number of clocks between the last valid write operation and the next read command to the same internal bank.

### Read to Precharge (tRTP)

The number of clocks that are inserted between a read command to a row pre-charge command to the same rank.

### Four Activate Window (tFAW)

The time window in which four activates are allowed the same rank.

### CAS Write Latency (tCWL)

Configure CAS Write Latency.

### Third Timing

#### tREFI

Configure refresh cycles at an average periodic interval.

#### tCKE

Configure the period of time the DDR4 initiates a minimum of one refresh command internally once it enters Self-Refresh mode.

### Turn Around Timing

#### tRDRD\_sg

Configure between module read to read delay.

#### tRDRD\_dg

Configure between module read to read delay.

#### tRDRD\_dr

Configure between module read to read delay.

#### tRDRD\_dd

Configure between module read to read delay.

#### tRDWR\_sg

Configure between module read to write delay.



### **tRDWR\_dg**

Configure between module read to write delay.

### **tRDWR\_dr**

Configure between module read to write delay.

### **tRDWR\_dd**

Configure between module read to write delay.

### **tWRRD\_sg**

Configure between module write to read delay.

### **tWRRD\_dg**

Configure between module write to read delay.

### **tWRRD\_dr**

Configure between module write to read delay.

### **tWRRD\_dd**

Configure between module write to read delay.

### **tWRWR\_sg**

Configure between module write to write delay.

### **tWRWR\_dg**

Configure between module write to write delay.

### **tWRWR\_dr**

Configure between module write to write delay.

### **tWRWR\_dd**

Configure between module write to write delay.

## **Round Trip Timing**

### **RTL Init Value**

Configure round trip latency init value for round trip latency training.

### **IO-L Init Value**

Configure IO latency init value for IO latency training.

**RTL (CH A)**

Configure round trip latency for channel A.

**RTL (CH B)**

Configure round trip latency for channel B.

**IO-L (CH A)**

Configure IO latency for channel A.

**IO-L (CH B)**

Configure IO latency for channel B.

**IO-L Offset (CH A)**

Configure IO latency offset for channel A.

**IO-L Offset (CH B)**

Configure IO latency offset for channel B.

**RFR Delay (CH A)**

Configure RFR Delay for Channel A.

**RFR Delay (CH B)**

Configure RFR Delay for Channel B.

**ODT Setting****ODT WR (A1)**

Configure the memory on die termination resistors' WR for channel A.

**ODT WR (B1)**

Configure the memory on die termination resistors' WR for channel B.

**ODT NOM (A1)**

Use this to change ODT (CH A) Auto/Manual settings. The default is [Auto].

**ODT NOM (B1)**

Use this to change ODT (CH B) Auto/Manual settings. The default is [Auto].

**ODT PARK (A1)**

Configure the memory on die termination resistors' PARK for channel A.

## ODT PARK (B1)

Configure the memory on die termination resistors' PARK for channel B.

## COMP Setting

### RCOMP0: DQ ODT (Read)

Default is 121.

### RCOMP1: DQ /CLK Ron (Drive Strength)

Default is 75.

### RCOMP2: CMD/CTL Ron (Drive Strength)

Default is 100.

## DQ ODT Driving

Adjust ODT Driving for better signal. Default is 60.

## DQ Driving

Adjust DQ Driving for better signal. Default is 26.

## Command Driving

Adjust Command Driving for better signal. Default is 20.

## Control Driving

Adjust Control Driving for better signal. Default is 20.

## Clock Driving

Adjust Clock Driving for better signal. Default is 26.

## DQ Slew Rate

Adjust DQ Slew Rate for better signal. Default is 59.

## Command Slew Rate

Adjust Command Slew Rate for better signal. Default is 53 for 1N, 89 for 2N.

## Control Slew Rate

Adjust Control Slew Rate for better signal. Default is 53.

## Clock Slew Rate

Adjust Clock Slew Rate for better signal. Default is 53.

## MRS Setting

### MRS tCL

Configure the tCL for Memory MRS MR0.

### MRS tWRtRTP

Configure the tWRtRTP for Memory MRS MRC.

### MRS tCWL

Configure the tCWL for Memory MRS MR2.

### MRS tCCD\_L

Configure the tCL for Memory MRS MR6.

## Advanced Setting

### Timing Optimization

Configure the fast path through the MRC.

### Realtime Memory Timing

Configure the realtime memory timings.

[Enabled] The system will allow performing realtime memory timing changes after MRC\_DONE.

### Command Tristate

Configure the Command Tristate Support.

### Exit On Failure

Configure the Exit On Failure for MRC training steps.

### Reset On Training Fail

Reset system if the MRC training fails.

### MRC Fast Boot

Enable Memory Fast Boot to skip DRAM memory training for booting faster.

## Voltage Configuration

### DRAM Voltage

Use this to configure DRAM Voltage. The default value is [Auto].

---

## Save User Default

Type a profile name and press enter to save your settings as user default.

## Load User Default

Load previously saved user defaults.

## Save User UEFI Setup Profile to Disk

Save current UEFI settings as an user default profile to disk.

## Load User UEFI Setup Profile to Disk

Load previously saved user defaults from the disk.

## 5.6 Advanced Screen

In this section, you may set the configurations for the following items: CPU Configuration, Chipset Configuration, Storage Configuration, Super IO Configuration, ACPI Configuration, USB Configuration and Trusted Computing.

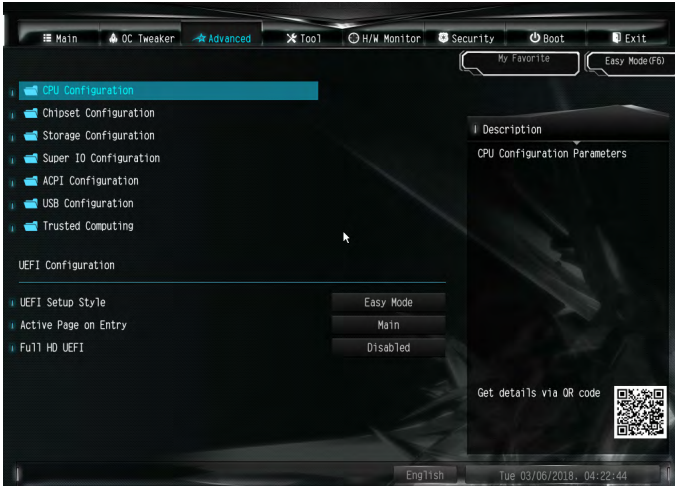

*Setting wrong values in this section may cause the system to malfunction.*

### UEFI Configuration

#### UEFI Setup Style

Select the default mode when entering the UEFI setup utility.

#### Active Page on Entry

Select the default page when entering the UEFI setup utility.

#### Full HD UEFI

When [Auto] is selected, the resolution will be set to 1920 x 1080 if the monitor supports Full HD resolution. If the monitor does not support Full HD resolution, then the resolution will be set to 1024 x 768. When [Disable] is selected, the resolution will be set to 1024 x 768 directly.

## 5.6.1 CPU Configuration

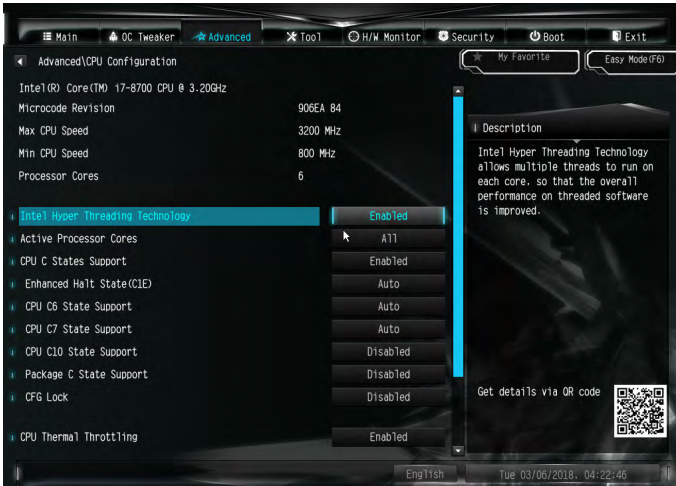

### Intel Hyper Threading Technology

Intel Hyper Threading Technology allows multiple threads to run on each core, so that the overall performance on threaded software is improved.

### Active Processor Cores

Select the number of cores to enable in each processor package.

### CPU C States Support

Enable CPU C States Support for power saving. It is recommended to keep C3, C6 and C7 all enabled for better power saving.

### Enhanced Halt State (C1E)

Enable Enhanced Halt State (C1E) for lower power consumption.

### CPU C6 State Support

Enable C6 sleep state for lower power consumption.

### CPU C7 State Support

Enable C7 sleep state for lower power consumption.

### CPU C10 State Support

Enable C10 sleep state for lower power consumption.

## Package C State Support

Enable CPU, PCIe, Memory, Graphics C State Support for power saving.

## CFG Lock

This item allows you to disable or enable the CFG Lock.

## CPU Thermal Throttling

Enable CPU internal thermal control mechanisms to keep the CPU from overheating.

## Intel Virtualization Technology

Intel Virtualization Technology allows a platform to run multiple operating systems and applications in independent partitions, so that one computer system can function as multiple virtual systems.

## Hardware Prefetcher

Automatically prefetch data and code for the processor. Enable for better performance.

## Adjacent Cache Line Prefetch

Automatically prefetch the subsequent cache line while retrieving the currently requested cache line. Enable for better performance.

## Software Guard Extensions (SGX)

Use this item to enable or disable Software Controlled Software Guard Extensions (SGX).



## 5.6.2 Chipset Configuration

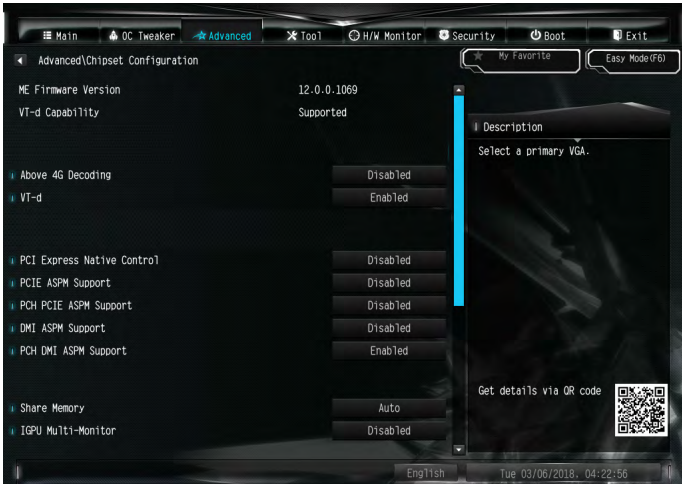

### Above 4G Decoding

Enable or disable 64bit capable Devices to be decoded in Above 4G Address Space (only if the system supports 64 bit PCI decoding).

### VT-d

Intel® Virtualization Technology for Directed I/O helps your virtual machine monitor better utilize hardware by improving application compatibility and reliability, and providing additional levels of manageability, security, isolation, and I/O performance.

### PCI Express Native Control

Select Enable for enhanced PCI Express power saving in OS.

### PCIe ASPM Support

This option enables/disables the ASPM support for all CPU downstream devices.

### PCH PCIe ASPM Support

This option enables/disables the ASPM support for all PCH PCIe devices.

### DMI ASPM Support

This option enables/disables the control of ASPM on CPU side of the DMI Link.

## PCH DMI ASPM Support

This option enables/disables the ASPM support for all PCH DMI devices.

## Share Memory

Configure the size of memory that is allocated to the integrated graphics processor when the system boots up.

## IGPU Multi-Monitor

Select disable to disable the integrated graphics when an external graphics card is installed. Select enable to keep the integrated graphics enabled at all times.

## Onboard HD Audio

Enable/disable onboard HD audio. Set to Auto to enable onboard HD audio and automatically disable it when a sound card is installed.

## Onboard HDMI HD Audio

Enable audio for the onboard digital outputs.

## WAN Radio

Enable/disable the WiFi module's connectivity.

## BT Control

Enable/disable the bluetooth's connectivity.

## Deep Sleep

Configure deep sleep mode for power saving when the computer is shut down.

## Restore on AC/Power Loss

Select the power state after a power failure. If [Power Off] is selected, the power will remain off when the power recovers. If [Power On] is selected, the system will start to boot up when the power recovers.

## 5.6.3 Storage Configuration

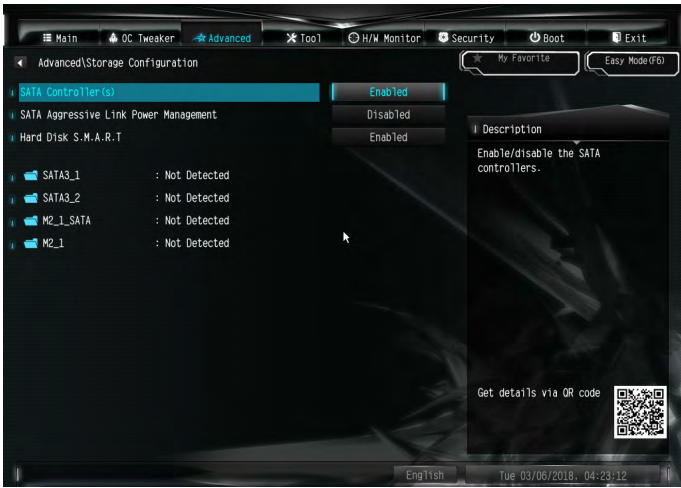

### SATA Controller(s)

Enable/disable the SATA controllers.

### SATA Aggressive Link Power Management

SATA Aggressive Link Power Management allows SATA devices to enter a low power state during periods of inactivity to save power. It is only supported by AHCI mode.

### Hard Disk S.M.A.R.T.

S.M.A.R.T stands for Self-Monitoring, Analysis, and Reporting Technology. It is a monitoring system for computer hard disk drives to detect and report on various indicators of reliability.

## 5.6.4 Super IO Configuration

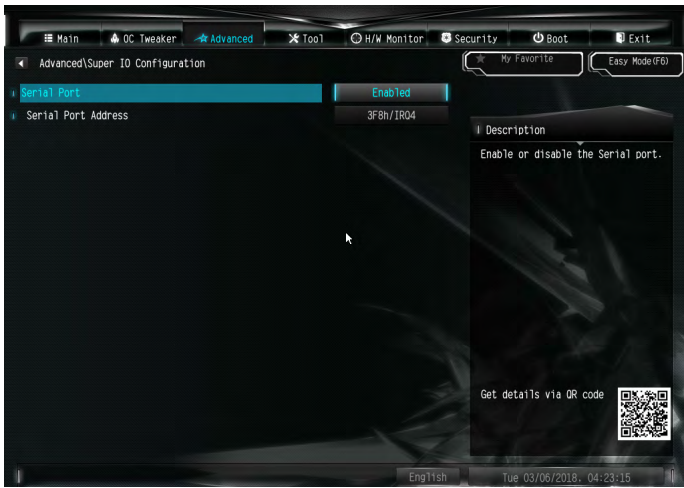

### Serial Port (for DeskMini 310/COM only)

Enable or disable the Serial port.

### Serial Port Address (for DeskMini 310/COM only)

Select the address of the Serial port.

## 5.6.5 ACPI Configuration



### Suspend to RAM

Select disable for ACPI suspend type S1. It is recommended to select auto for ACPI S3 power saving.

### I219 LAN Power On

Allow the system to be waked up by I219 LAN.

### Ring-In Power On

Allow the system to be waked up by onboard COM port modem Ring-In signals.

### RTC Alarm Power On

Allow the system to be waked up by the real time clock alarm. Set it to By OS to let it be handled by your operating system.

### USB Keyboard/Remote Power On

Allow the system to be waked up by an USB keyboard or remote controller.

### USB Mouse Power On

Allow the system to be waked up by an USB mouse.

## 5.6.6 USB Configuration

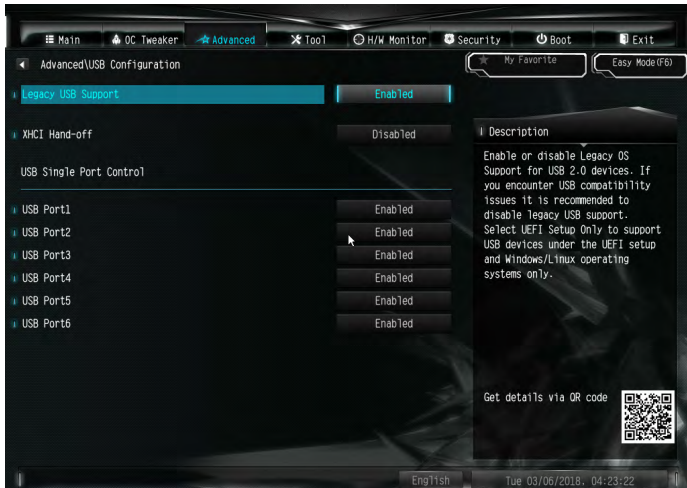

### Legacy USB Support

Enable or disable Legacy OS Support for USB 2.0 devices. If you encounter USB compatibility issues it is recommended to disable legacy USB support. Select UEFI Setup Only to support USB devices under the UEFI setup and Windows/Linux operating systems only.

### XHCI Hand-off

This is a workaround for OSEs without XHCI hand-off support. The XHCI ownership change should be claimed by XHCI driver.

## 5.6.7 Trusted Computing

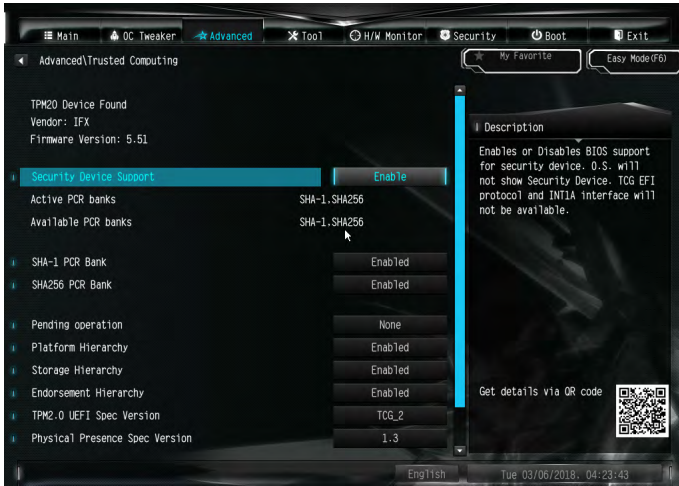

### Security Device Support

Enable or disable BIOS support for security device.

## 5.7 Tools

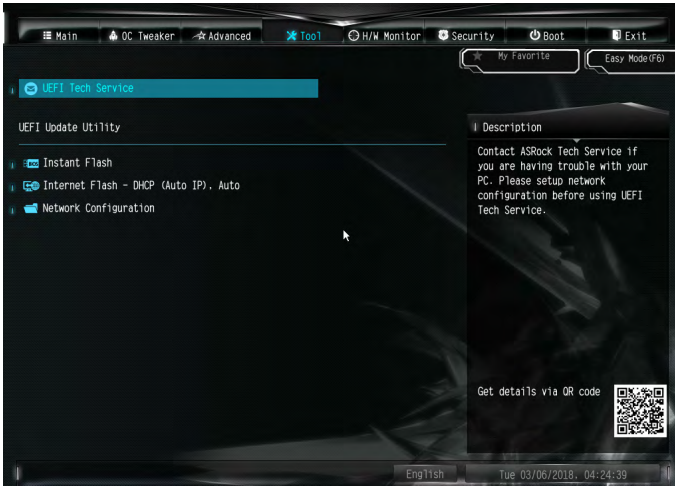

### UEFI Tech Service

Contact Tech Service if you are having trouble with your PC. Please setup network configuration before using UEFI Tech Service.

### Instant Flash

Save UEFI files in your USB storage device and run Instant Flash to update your UEFI.

### Internet Flash - DHCP (Auto IP), Auto

Internet Flash downloads and updates the latest UEFI firmware version from our servers for you. Please setup network configuration before using Internet Flash.

\*For BIOS backup and recovery purpose, it is recommended to plug in your USB pen drive before using this function.



## Network Configuration

Use this to configure internet connection settings for Internet Flash.

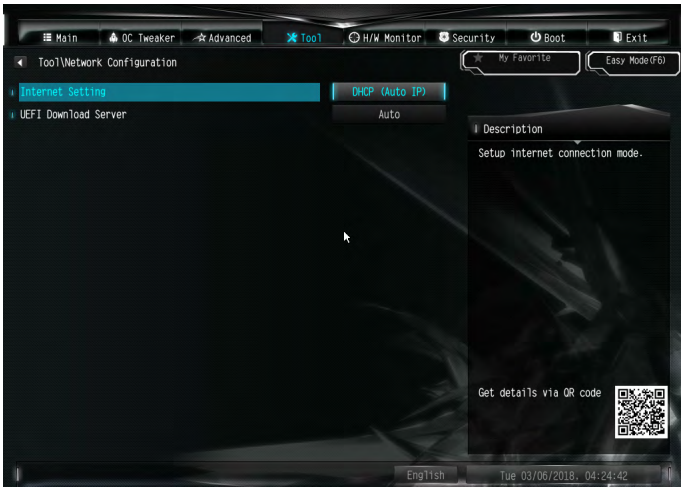

### Internet Setting

Enable or disable sound effects in the setup utility.

### UEFI Download Server

Select a server to download the UEFI firmware.

## 5.8 Hardware Health Event Monitoring Screen

This section allows you to monitor the status of the hardware on your system, including the parameters of the CPU temperature, motherboard temperature, fan speed and voltage.

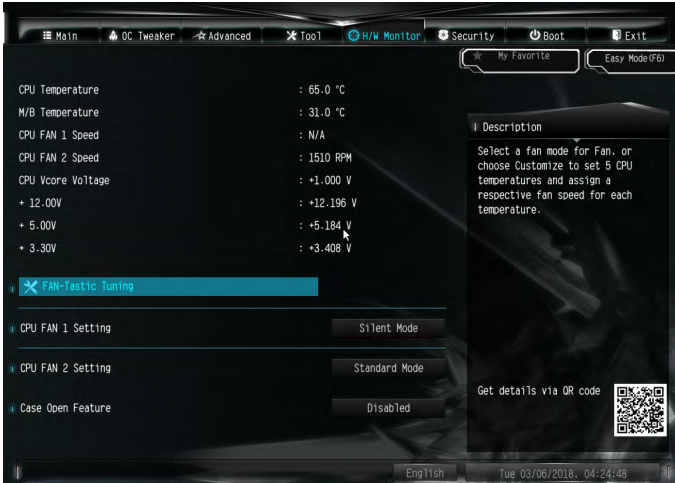

### Fan-Tastic Tuning

Select a fan mode for CPU Fan, or choose Customize to set 5 CPU temperatures and assign a respective fan speed for each temperature.

### CPU Fan 1 Setting

Select a fan mode for CPU Fan 1, or choose Customize to set 5 CPU temperatures and assign a respective fan speed for each temperature.

### CPU Fan 2 Setting

Select a fan mode for CPU Fan 2, or choose Customize to set 5 CPU temperatures and assign a respective fan speed for each temperature.

### Case Open Feature

Enable or disable Case Open Feature to detect whether the chassis cover has been removed.

## 5.9 Security Screen

In this section you may set or change the supervisor/user password for the system. You may also clear the user password.

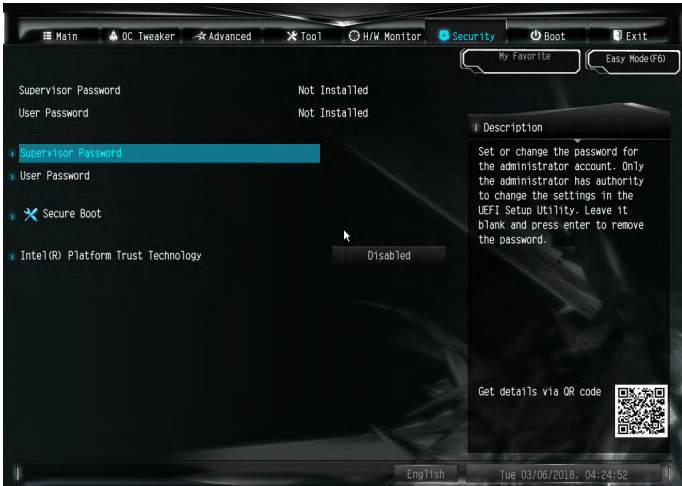

### Supervisor Password

Set or change the password for the administrator account. Only the administrator has authority to change the settings in the UEFI Setup Utility. Leave it blank and press enter to remove the password.

### User Password

Set or change the password for the user account. Users are unable to change the settings in the UEFI Setup Utility. Leave it blank and press enter to remove the password.

### Secure Boot

Use this item to enable or disable support for Secure Boot.

### Intel(R) Platform Trust Technology

Enable/disable Intel PTT in ME. Disable this option to use discrete TPM Module.

## 5.10 Boot Screen

This section displays the available devices on your system for you to configure the boot settings and the boot priority.

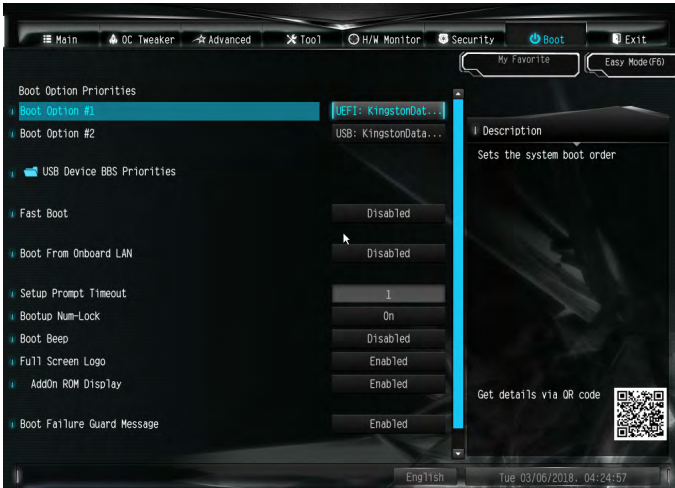

### Fast Boot

Fast Boot minimizes your computer's boot time. In fast mode you may not boot from an USB storage device. The VBIOS must support UEFI GOP if you are using an external graphics card. Please notice that Ultra Fast mode will boot so fast that the only way to enter this UEFI Setup Utility is to Clear CMOS or run the Restart to UEFI utility in Windows.

### Boot From Onboard LAN

Allow the system to be waked up by the onboard LAN.

### Setup Prompt Timeout

Configure the number of seconds to wait for the setup hot key.

### Bootup Num-Lock

Select whether Num Lock should be turned on or off when the system boots up.

### Boot Beep

Select whether the Boot Beep should be turned on or off when the system boots up. Please note that a buzzer is needed.

## Full Screen Logo

Enable to display the boot logo or disable to show normal POST messages.

## AddOn ROM Display

Enable AddOn ROM Display to see the AddOn ROM messages or configure the AddOn ROM if you've enabled Full Screen Logo. Disable for faster boot speed.

## Boot Failure Guard Message

If the computer fails to boot for a number of times the system automatically restores the default settings.

## CSM (Compatibility Support Module)

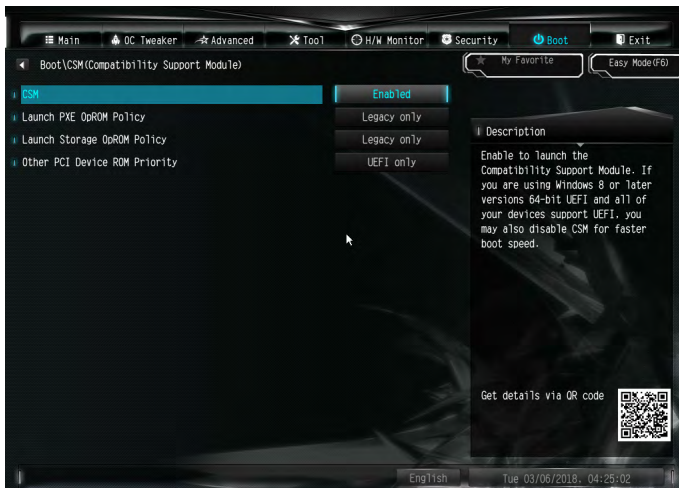

## CSM

Enable to launch the Compatibility Support Module. Please do not disable unless you're running a WHCK test.

## Launch PXE OpROM Policy

Select UEFI only to run those that support UEFI option ROM only. Select Legacy only to run those that support legacy option ROM only. Select Do not launch to not execute both legacy and UEFI option ROM.

## Launch Storage OpROM Policy

Select UEFI only to run those that support UEFI option ROM only. Select Legacy only to run those that support legacy option ROM only. Select Do not launch to not execute both legacy and UEFI option ROM.

## Other PCI Device ROM Priority

For PCI devices other than Network. Mass storage or Video defines which OpROM to launch.

## 5.11 Exit Screen

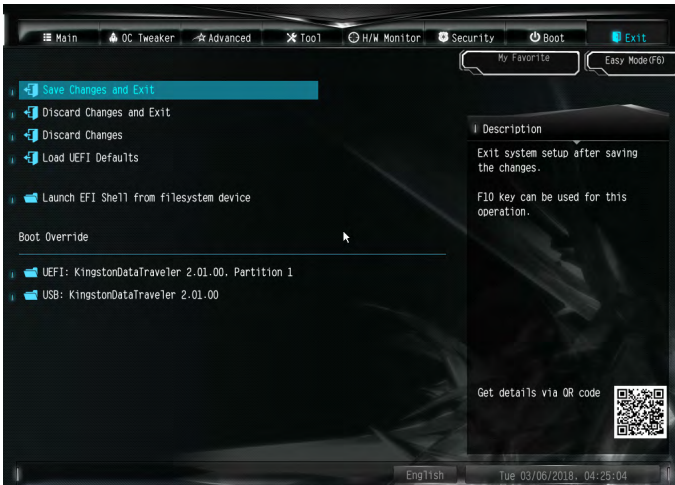

### Save Changes and Exit

When you select this option the following message, “Save configuration changes and exit setup?” will pop out. Select [OK] to save changes and exit the UEFI SETUP UTILITY.

### Discard Changes and Exit

When you select this option the following message, “Discard changes and exit setup?” will pop out. Select [OK] to exit the UEFI SETUP UTILITY without saving any changes.

### Discard Changes

When you select this option the following message, “Discard changes?” will pop out. Select [OK] to discard all changes.

### Load UEFI Defaults

Load UEFI default values for all options. The F9 key can be used for this operation.

### Launch EFI Shell from filesystem device

Copy shellx64.efi to the root directory to launch EFI Shell.