



# NAS

## Quick Installation Guide

快速安裝手冊 빠른 설치 설명서 Guía de Instalación Rápida

クイックインストールガイド Hızlı Kurulum Kılavuzu

คู่มือการติดตั้งแบบเร็ว Gyors telepítési útmutató

Instrukcja szybkiej instalacji Průvodce rychlou in

Kurzinstallationsanleitung 快速安裝指南

Guida di installazione rapida Pika-asennusopas

Краткое руководство по установке

Snabbinstallationsguide

Guia de Instalação Rápida

Hurtiginstallasjonsveiledning

Hurtig installationsvejledning

Pika-asennusopas Installatiegids

Snelle Installatiegids

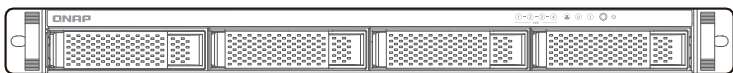

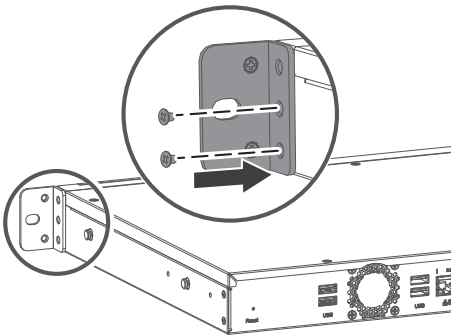
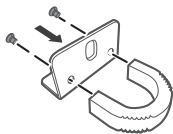
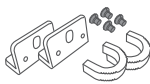
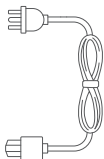
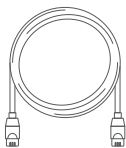
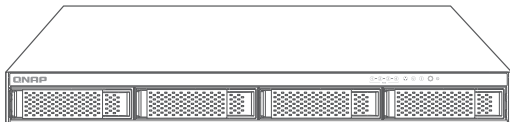



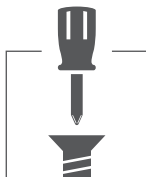

- EN** | Tighten the screws to prevent the tray from getting stuck to the chassis.
- DE** | Ziehen Sie die Schrauben an, um zu verhindern, dass der Einschub am Gehäuse stecken bleibt.
- FR** | Serrez les vis pour éviter que le plateau ne reste collé au châssis.
- IT** | Serrare le viti per evitare che il vano si blocchi nello chassis.
- ES** | Apriete los tornillos para evitar que la bandeja quede atascada en el chasis.
- NL** | Draai de schroeven vast om te voorkomen dat de lade bekneld raakt in het frame.
- SV** | Dra åt skruvarna för att förhindra att facket fastnar i chassina.
- FI** | Kiristä ruuvit, jotta alusta ei juutu runkoon.
- DA** | Spænd skruerne for at forhindre bakken i at sidde fast i kabinettet.
- NO** | Trekk til skruene for å unngå at skuffen setter seg fast i kabinettet.
- PT** | Aperte os parafusos para evitar que a bandeja fique travada no chassi.
- RU** | Затяните винты, чтобы лоток не сошел с шасси.
- ZH** | 鎖緊螺絲以防止托盤卡在機殼裡。
- CN** | 拧紧螺丝，以免托盘卡在机箱上。
- JA** | トレーがシャーシに引っかからないようにネジを締めます。
- KO** | 트레이가 새시에 걸리지 않도록 나사를 조여 주십시오.
- TH** | ขันสกรูให้แน่น เพื่อป้องกันไม่ให้ถาดไปติดกับแชสซี
- TR** | Tepsinin çerçeveye sıkışmasını önlemek için vidaları sıkın.
- HU** | Húzza meg a csavarokat, hogy a tálca ne akadjon el a házban.
- CS** | Abyste zabránili zaklínění přihrádky k šasi, utáhněte šrouby.
- PL** | Dokładnie dokręć wkręty, aby kieszeń nie zaklinowała się w obudowie.
- AR** | لكيهالاب قاصرتلالا نم قبلعالا عنمل ريماسملا طبرم كحمأ.
- ID** | Kencangkan sekrup untuk mencegah laci macet pada rangka
- VI** | Hã y vãn chặt các ốc vít để đảm bảo khay không bị kẹt vào khung máy.

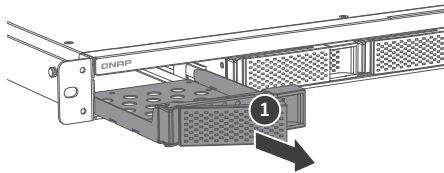

3.5-inch SATA HDD

2.5-inch SATA SSD

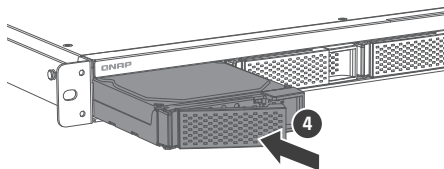
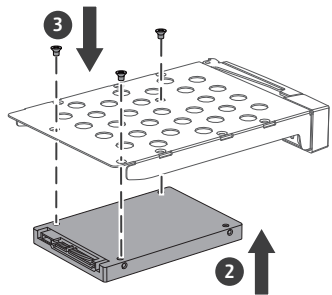
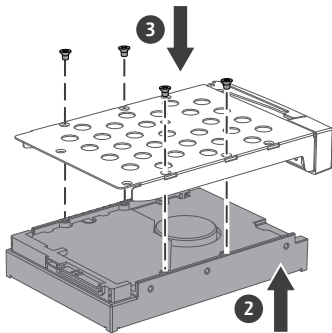

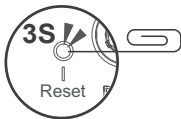
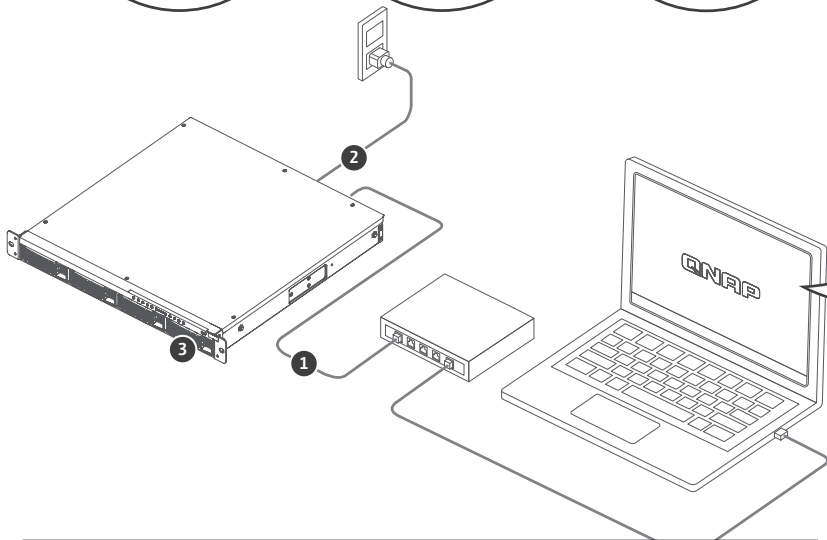
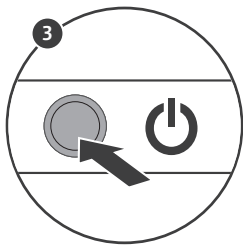
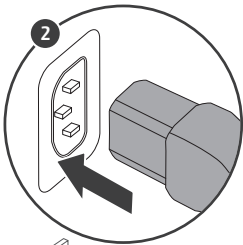
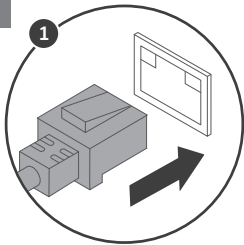

### QTS 5.1.x or earlier



### QTS 5.2.x or later

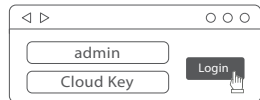

 **Qfinder Pro**     
<http://www.qnap.com/qfinderpro>

a



**Cloud Installation** <https://install.qnap.com/>

b

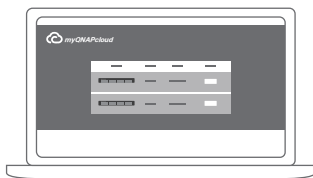

c

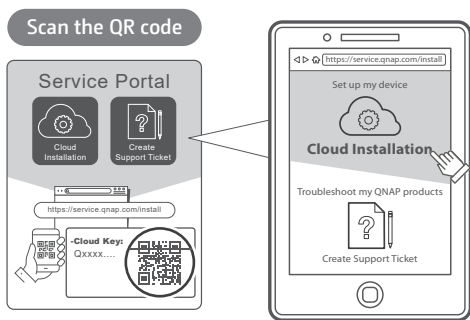



Download Center  
[www.qnap.com/download](http://www.qnap.com/download)

- EN** | Visit Download Center for our full guides and utilities.
- DE** | Unsere vollständigen Handbücher und Dienstprogramme finden Sie im Download Center.
- FR** | Visitez le Centre de téléchargement pour accéder à nos guides et utilitaires complets.
- IT** | Per le guide e le utilità complete, visitare il Centro download.
- ES** | Visite el Centro de descargas para ver todas nuestras guías y utilidades.
- NL** | Bezoek het downloadcentrum voor onze uitgebreide gidsen en hulpprogramma's.
- SV** | Besök Nedladdningscenter för våra fullständiga guider och verktyg.
- FI** | Katso täydelliset oppaat ja apuohjelmat latauskeskuksestamme.
- DA** | Besøg Downloadcenter for at se alle vores vejledninger og hjælpværktøjer.
- NO** | Gå til Nedlastingscenter for fullstendige veiledninger og verktøy.
- PT** | Visite a Central de Download para acessar nossos guias e utilitários completos.
- RU** | Чтобы ознакомиться с полным набором руководств и служебных программ, посетите Центр загрузки. ru
- ZH** | 請前往下載中心取得完整指南和應用工具
- CN** | 有关完整指南和实用工具·请访问“下载中心”
- JA** | 完全なガイドとユーティリティについては、ダウンロードセンターをご覧ください
- KO** | 다운로드 센터에서 전체 지침 및 유틸리티를 확인하십시오.
- TH** | กรุณาเข้าสู่ศูนย์การดาวน์โหลดเพื่อดาวน์โหลดคู่มือฉบับสมบูรณ์และโปรแกรมมอรรถประโยชน์ต่างๆ
- TR** | Tam kılavuzumuz ve yardımcı hizmetlerimiz için İndirme Merkezi'ni ziyaret edin.
- HU** | A teljes útmutatók és segédprogramok megtekintéséhez keresse fel a Letöltési központot.
- CS** | Komplettního průvodce a nástroje najdete na webu Centrum stahování.
- PL** | Odwiedź Centrum pobierania, aby uzyskać kompletne przewodniki i narzędzia.
- AR** | لمزيد من التوجيهات والبرامج المفيدة، يرجى زيارة مركز التنزيل أو مركز المساعدة.
- ID** | Silakan kunjungi Pusat Unduhan untuk panduan dan utilitas lengkap kami
- VI** | Truy cập Trung tâm Tải xuống để xem đầy đủ hướng dẫn và tiện ích.



This device complies with Part 15 of the FCC Rules. Operation is subject to the following two conditions:

1. This device may not cause harmful interference.
2. This device must accept any interference received, including interference that may cause undesired operation.

**FCC Class B Notice:**

This equipment has been tested and found to comply with the limits for a Class B digital device, pursuant to Part 15 of the FCC Rules. These limits are designed to provide reasonable protection against harmful interference in a residential installation. This equipment generates, uses, and can radiate radio frequency energy and, if not installed and used in accordance with the instructions, may cause harmful interference to radio communications. However, there is no guarantee that interference will not occur in a particular installation. If this equipment does cause harmful interference to radio or television reception, which can be determined by turning the equipment off and on, the user is encouraged to try to correct the interference by one or more of the following measures:

- Reorient or relocate the receiving antenna.
- Increase the separation between the equipment and receiver.
- Connect the equipment into an outlet on a circuit different from that to which the receiver is connected.
- Consult the dealer or an experienced radio/television technician for help.

**Modifications:**

Any modifications made to this device that are not approved by QNAP Systems, Inc. may void the authority granted to the user by the FCC to operate this equipment.



This device complies with CE compliance Class B.



According to the requirement of the WEEE legislation the following user information is provided to customers for all branded QNAP products subject to the WEEE directive.

This symbol on the product or on its packaging indicates that this product must not be disposed of with your other household waste. Instead, it is your responsibility to dispose of your waste equipment by handing it over to a designated collection point for the recycling of waste electrical and electronic equipment. The separate collection and recycling of your waste equipment at the time of disposal will help to conserve natural resources and ensure that it is recycled in a manner that protects human health and the environment. For more information about where you can drop off your waste equipment for recycling, please contact your local city office, your household waste disposal service or the shop where you purchased the product.



**Office in EU;**

QNAP GmbH,  
Karl-Arnold-Straße 26,  
47877 Willich, Germany

**Office in UK;**

QNAP Ltd,  
2 Drakes Meadow, Swindon SN3 3LL  
United Kingdom

This device complies with the UKCA requirements for products sold in Great Britain.



D33B77  
RoHS

更多關於安全、法規、與環境法令遵循相關的資訊，請參閱以下網址 [www.qnap.com/regulatory/](http://www.qnap.com/regulatory/)。



**WARNING**

| Operation of this equipment in a residential environment could cause radio interference.

| 付属の電源コードは当該製品専用です。他の機器に使用しないでください。

| 斷接裝置：器具耦合器应当便于操作・附近不得被其他物体遮挡；  
注意：用错误型号号电池更换会有爆炸危险・务必按照说明处置用完的电池。

| CAN ICES-003(B) / NMB-003(B)

## ⚠ WARNING

- **INGESTION HAZARD:** This product contains a button cell or coin battery.
- **DEATH** or serious injury can occur if ingested.
- A swallowed button cell or coin battery can cause **Internal Chemical Burns** in as little as **2 hours**.
- **KEEP** new and used batteries **OUT OF REACH of CHILDREN**
- **Seek immediate medical attention** if a battery is suspected to be swallowed or inserted inside any part of the body.



1. Battery type: CR2032.

2. Nominal battery voltage: 3.0 volts.

- Remove and immediately recycle or dispose of used batteries according to local regulations and keep away from children. Do NOT dispose of batteries in household trash or incinerate.
- Even used batteries may cause severe injury or death.
- Call a local poison control center for treatment information.
- Non-rechargeable batteries are not to be recharged.
- Do not force discharge, recharge, disassemble, heat above (manufacturer's specified temperature rating) or incinerate. Doing so may result in injury due to venting, leakage or explosion resulting in chemical burns.
- Ensure the batteries are installed correctly according to polarity (+ and -).
- Do not mix old and new batteries, different brands or types of batteries, such as alkaline, carbon-zinc, or rechargeable batteries.
- Remove and immediately recycle or dispose of batteries from equipment not used for an extended period of time according to local regulations.
- Always completely secure the battery compartment. If the battery compartment does not close securely, stop using the product, remove the batteries, and keep them away from children.

EC

REP

QNAP GmbH

Karl-Arnold-Straße 26, 47877 Willich, Germany

[www.qnap.com](http://www.qnap.com)

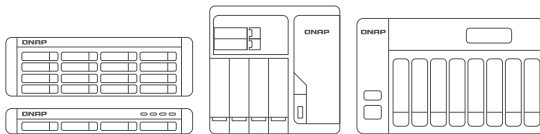

---

---

---

---

---

---

---

---



[install.qnap.com](https://install.qnap.com)



[service.qnap.com](https://service.qnap.com)



[download.qnap.com](https://download.qnap.com)

**QNAP**<sup>®</sup>



51000-025562-HF