

# Hardware Maintenance Manual



IdeaCentre AIO i (27", 11)

**First Edition (January 2026)**

**© Copyright Lenovo 2026.**

LIMITED AND RESTRICTED RIGHTS NOTICE: If data or software is delivered pursuant to a General Services Administration "GSA" contract, use, reproduction, or disclosure is subject to restrictions set forth in Contract No. GS-35F-05925.

---

# Contents

## About this manual . . . . . ii

## Chapter 1. Product overview . . . . . 1

Overview . . . . . 1

Rear . . . . . 2

## Chapter 2. Safety requirements for hardware maintenance . . . . . 3

General safety requirements . . . . . 3

Electrical safety requirements . . . . . 4

Safety inspection guide . . . . . 5

Handle devices that are sensitive to electrostatic discharge . . . . . 6

Important danger warning in multiple languages . . . . . 7

## Chapter 3. Diagnostics and troubleshooting . . . . . 30

Overall procedure . . . . . 30

Diagnostic tools . . . . . 31

    Hardware scan in Vantage . . . . . 31

    Lenovo UEFI diagnostic tool . . . . . 31

    Advanced diagnostic tools . . . . . 32

Symptom-to-CRU/FRU index . . . . . 33

    POST error codes . . . . . 33

    Beep symptoms . . . . . 33

    Storage drive boot error . . . . . 34

    Power supply problems . . . . . 34

    Miscellaneous error conditions . . . . . 34

Undetermined problems . . . . . 36

Call Lenovo . . . . . 37

    Before contacting Lenovo support . . . . . 37

    Find the serial number . . . . . 38

    Lenovo Customer Support Center . . . . . 38

## Chapter 4. Hardware replacement . . . . . 39

Before hardware replacement . . . . . 39

    Service tools . . . . . 39

    Screw list . . . . . 42

    CRU/FRU definition . . . . . 42

    Prerequisites for hardware replacement . . . . . 46

    System board illustration . . . . . 47

    Scalar board illustration . . . . . 48

    Handling thermal interface materials . . . . . 48

External options . . . . . 49

Power cord and ac power adapter . . . . . 49

Hinge cover (top) . . . . . 50

Rear cover . . . . . 50

System board shielding . . . . . 51

M.2 solid-state drive and thermal pad . . . . . 52

Duet clip . . . . . 52

Coin-cell battery and rubber . . . . . 53

Wi-Fi card and Wi-Fi card cover . . . . . 54

Power switch board and power switch board FFC . . . . . 55

Side I/O board, side I/O board cable, and side I/O board FFC . . . . . 57

Thermal module . . . . . 58

Front cover . . . . . 59

Cover cap (left and right) . . . . . 60

Hinge cover (front) . . . . . 61

System board . . . . . 61

Stand assembly . . . . . 64

Speaker . . . . . 65

Thermal fan and bracket . . . . . 66

Golden finger board, golden finger board cable, and golden finger board FCC . . . . . 67

LCD cover . . . . . 69

Touch cable (for selected models) . . . . . 70

Backlight cable . . . . . 71

Scalar board . . . . . 72

LCD frame assembly . . . . . 75

Camera assembly . . . . . 76

LVDS cable 1 . . . . . 77

LVDS cable 2 . . . . . 78

LCD panel bezel . . . . . 79

LCD panel . . . . . 80

## Appendix A. Important notice for Quebec consumers . . . . . 82

## Appendix B. Self-help resource . . . . . 83

## Appendix C. Notices and trademarks . . . . . 86

---

## About this manual

This manual contains hardware maintenance instructions for the product listed in the following table.

Product name	Machine type (MT)
IdeaCentre AIO 27IPH11	F0JH, F0JJ

### Important:

- Hardware or software configurations vary by machine type. Some statements or illustrations in this manual may differ slightly from your computer.
- It is recommended that the computer be repaired by trained service technicians.
- For customers electing to service the computer on their own, it is still recommended to contact Lenovo Customer Support Center for guidance. See “Call Lenovo” on page 37. Depending on the complexity of the repair, it may be recommended to have a Lenovo-authorized service provider repair the computer.
- Before servicing a computer, be sure to follow all instructions carefully and read all the information under Chapter 2 “Safety requirements for hardware maintenance” on page 3 and “Before hardware replacement” on page 39.

# Chapter 1. Product overview

## Overview

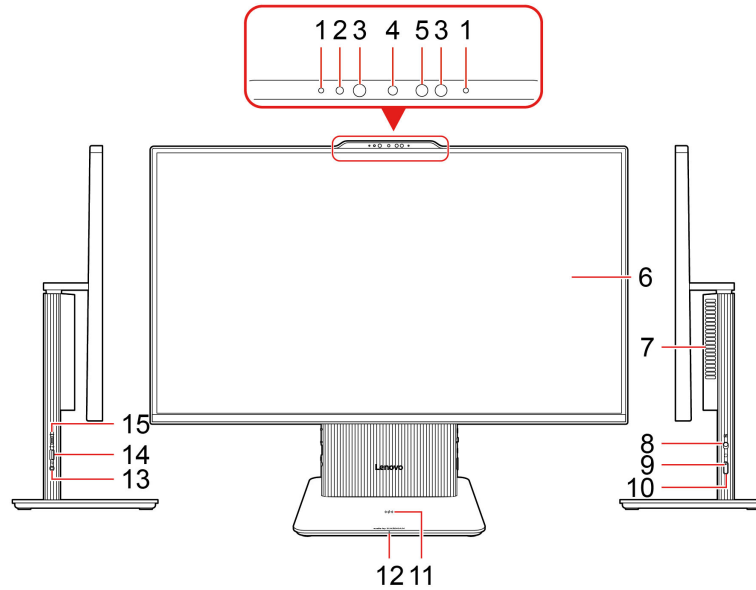

Item	Description	Item	Description
1	Microphones	2	Integrated camera activity indicator
3	Infrared LED*	4	Integrated camera
5	Infrared camera*	6	Multi-touch screen*
7	Air vent	8	Camera switch
9	Power button indicator	10	Power button
11	Wireless charging pad*	12	Wireless charging indicator*
13	Combo audio jack	14	USB-A connectors (USB 10Gbps)
15	USB-C® connector (USB 10Gbps)		

\* for selected models

## Rear

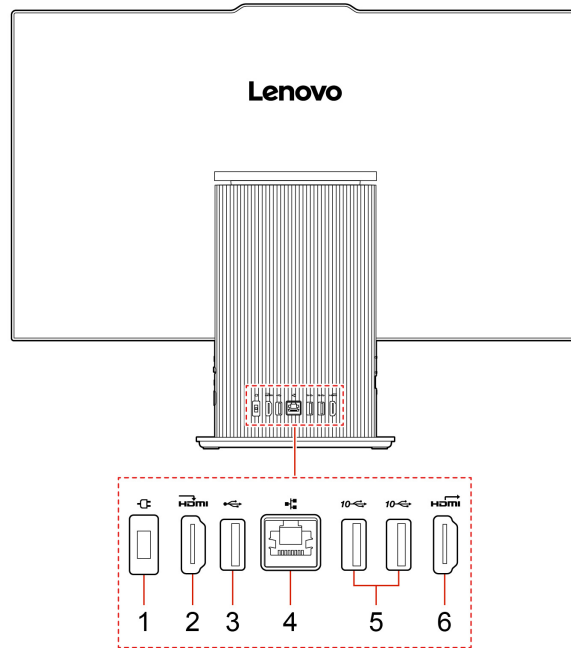

Item	Description	Item	Description
1	Power connector	2	HDMI™ in connector
3	USB-A connector (Hi-Speed USB)	4	Ethernet connector
5	USB-A connectors (USB 10Gbps)	6	HDMI 2.1 TMDS out connector

---

## Chapter 2. Safety requirements for hardware maintenance

---

### General safety requirements

Meet the following requirements on environment, personnel and outfit, and operation to ensure general safety:

#### Environment requirements

Observe good housekeeping in the area of the machine during and after maintenance.

#### Personnel and outfit requirements

- Do not wear loose clothing that can be trapped in the moving parts of a machine. Ensure that your sleeves are fastened or rolled up above your elbows. If your hair is long, fasten it.
- Insert the ends of your necktie or scarf inside clothing or fasten it with a nonconductive clip, about 8 centimeters (3 inches) from the end.
- Do not wear jewelry, chains, metal-frame eyeglasses, or metal fasteners for your clothing, because metal objects are good electrical conductors.
- Wear safety glasses when you are hammering, drilling, soldering, cutting wire, attaching springs, using solvents, or working in any other conditions that might be hazardous to your eyes.

#### Operation requirements

- Before you start the machine, ensure that no one is in a hazardous position.
- Do not perform any action that causes personal injury or that makes the equipment unsafe.
- Keep your tool case away from walk areas so that other people will not trip over it.
- When lifting any heavy object:
  1. Ensure that you can stand safely without slipping.
  2. Distribute the weight of the object equally between your feet.
  3. Use a slow lifting force. Never move suddenly or twist when you attempt to lift.
  4. Lift by standing or by pushing up with your leg muscles; this action removes the strain from the muscles in your back. Do not attempt to lift any object that weighs more than 16 kg (35 lb) or that you think is too heavy for you.
- Place removed covers and other parts in a safe place, away from all personnel, while you are servicing the machine.
- After service, reinstall all safety shields, guards, labels, and ground wires. Replace any safety device that is worn or defective. Reinstall all covers correctly.

#### CAUTION:



**Keep fingers and other parts of your body away from hazardous, moving parts. If you suffer an injury, seek medical care immediately. Never remove the cover on a power supply or any part that has the following label attached.**



**Hazardous voltage, current, and energy levels are present inside any component that has this label attached. There are no serviceable parts inside these components. If you suspect a problem with one of these parts, contact a service technician.**

**CAUTION:**



**Avoid contact with hot components inside the computer. During operation, some components become hot enough to burn the skin. Before you open the computer cover, turn off the computer, disconnect the power, and wait approximately 10 minutes for the components to cool.**

---

## Electrical safety requirements

To ensure electrical safety, meet the following requirements on environment, outfit, and operation when working on the computer:

### Environment requirements

- Find the room emergency power-off (EPO) switch, disconnecting switch, or electrical outlet. If an electrical accident occurs, you can then operate the switch or unplug the power cord quickly.
- Do not work alone under hazardous conditions or near equipment that has hazardous voltages.
- Always look carefully for possible hazards in your work area. Examples of these hazards are moist floors, nongrounded power extension cables, power surges, and missing safety grounds.

### Outfit requirements

- Do not use worn or broken tools and testers.
- Use only approved tools and test equipment. Some hand tools have handles covered with a soft material that does not insulate you when working with live electrical currents.
- Regularly inspect and maintain your electrical hand tools for safe operational condition.
- Many customers have, near their equipment, rubber floor mats that contain small conductive fibers to decrease electrostatic discharges (ESD). Do not use this type of mat to protect yourself from electrical shock.

### Operation requirements



**CAUTION:**

**Electrical current from power, telephone, and communication cables can be hazardous. To avoid personal injury or equipment damage, disconnect the attached power cords, telecommunication systems, networks, and modems before you open the computer covers, unless instructed otherwise in the installation and configuration procedures.**

- Disconnect all power before:
  - Performing a mechanical inspection
  - Working near power supplies
  - Removing or installing Field Replaceable Units (FRUs) or Customer Replaceable Units (CRUs)
- Do not service the following parts with the power on when they are removed from their normal operating places in a machine:
  - Power supply units
  - Pumps
  - Blowers and fans

- Motor generators

This practice ensures the correct grounding of the units.

- Electrical grounding of the computer is required for operator safety and correct system function. Proper grounding of the electrical outlet can be verified by a certified electrician.
- Observe the special safety precautions when you work with very high voltages. Instructions for these precautions are in the safety sections of maintenance information. Use extreme care when measuring high voltages.
- Before you start to work on the machine, unplug the power cord. If you cannot unplug it, power off the wall box that supplies power to the machine and lock the wall box in the off position.
- Never assume that power has been disconnected from a circuit. First, check that it has been powered off.
- Avoid touching live electrical circuits with the reflective surface of a plastic dental mirror. The surface is conductive; such touching can cause personal injury and machine damage.
- If you need to work on a machine that has exposed electrical circuits, observe the following precautions:
  - Ensure that another person, familiar with the power-off controls, is nearby. That person must be there to switch off the power, if necessary.
  - Use only one hand when working with powered-on electrical equipment; keep the other hand in your pocket or behind your back.

**CAUTION:**

**An electrical shock can occur only when there is a complete circuit. By observing the above rule, you may prevent a current from passing through your body.**

- When using testers, set the controls correctly and use the approved probe leads and accessories for that tester.
- Stand on suitable rubber mats (obtained locally, if necessary) to insulate you from grounds such as metal floor strips and machine frames.
- If an electrical accident occurs:
  - Use caution; do not become a victim yourself.
  - Switch off power.
  - Send another person to get medical aid.

---

## Safety inspection guide

The intent of this inspection guide is to assist you in identifying potentially unsafe conditions on these products. Each machine, as it was designed and built, had required safety items installed to protect users and service personnel from injury. This guide addresses only those items. However, good judgment should be used to identify potential safety hazards due to attachment of features or options not covered by this inspection guide.

If any unsafe conditions are present, you must determine how serious the apparent hazard could be and whether you can continue without first correcting the problem. Consider these conditions and the safety hazards they present:

- Electrical hazards, especially primary power (primary voltage on the frame can cause serious or fatal electrical shock)
- Explosive hazards, such as a damaged CRT face or a bulging capacitor
- Mechanical hazards, such as loose or missing hardware

To determine whether there are any potentially unsafe conditions, use the following checklist at the beginning of every service task. Begin the checks with the power off and the power cord disconnected:

- Before removing the cover:
  1. Check exterior covers for damage (loose, broken, or sharp edges).

2. Power off the computer. Disconnect the power cord. Check the power cord for:
  - a. A third-wire ground connector in good condition. Use a meter to measure third-wire ground continuity for 0.1 ohm or less between the external ground pin and the frame ground.
  - b. The power cord should be the authorized type specified for your computer.
  - c. Insulation must not be frayed or worn.
- After removing the cover:
  1. Check for any obvious alterations. Use good judgment as to the safety of any alterations.
  2. Check inside the unit for any obvious unsafe conditions, such as metal filings, contamination, water or other liquids, or signs of fire or smoke damage.
  3. Check for worn, frayed, or pinched cables.
  4. Check that the power-supply cover fasteners (screws or rivets) have not been removed or tampered with.

---

## Handle devices that are sensitive to electrostatic discharge

Any computer part containing transistors or integrated circuits (ICs) should be considered sensitive to electrostatic discharge (ESD). ESD damage can occur when there is a difference in charge between objects. Static electricity, although harmless to you, can seriously damage computer components and options. It is necessary to protect against ESD damage by equalizing the charge so that the machine, the part, the work mat, and the person handling the part are all at the same charge.

### Notes:

1. Use product-specific ESD procedures when they exceed the requirements noted here.
2. Make sure that the ESD protective devices you use have been certified (ISO 9000) as fully effective.

When handling ESD-sensitive parts:

- Wear a grounded wrist strap against your skin to eliminate static on your body.
- Use the black side of a grounded work mat to provide a static-free work surface. The mat is especially useful when handling ESD-sensitive devices.
- Select a grounding system, such as those listed below, to provide protection that meets the specific service requirement.
  - Attach the ESD ground clip to any frame ground, ground braid, or green-wire ground.
  - Use an ESD common ground or reference point when working on a double-insulated or battery-operated system. You can use coax or connector-outside shells on these systems.
  - Use the round ground-prong of the ac plug on ac-operated computers.

**Note:** The use of a grounding system is desirable but not required to protect against ESD damage.

- Avoid contact with other people while handling the part.
- Prevent others from touching the options and other computer components.
- Prevent the part from touching your clothing. Most clothing is insulative and retains a charge even when you are wearing a wrist strap.
- Limit your movement. Movement can cause static electricity to build up around you.
- Do not place the part on the computer cover or other metal surface.
- Always handle computer components and options carefully. Hold PCI/PCIe cards, memory modules, system boards, and CPUs only by the edges. Never touch any exposed circuitry.

- Touch the static-protective package containing the part to a metal expansion-slot cover or other unpainted metal surface on the computer for at least two seconds. This reduces static electricity from the package and your body before you install or replace a new part.
- Do not open the static-protective package containing the new part until the defective part has been removed and you are ready to install the new part. Static electricity, although harmless to you, can seriously damage computer components and options.
- Keep the parts in protective packages until they are inserted into the product.
- When possible, remove the new part from the static-protective package, and install it directly in the computer without setting the part down. When this is not possible, place the static-protective package on a smooth and level surface and place the part on the package.

---

## Important danger warning in multiple languages

The safety notices in this section are provided in the following languages:

- English
- Arabic
- Brazilian/Portuguese
- Chinese (simplified)
- Chinese (traditional)
- French
- German
- Hebrew
- Italian
- Korean
- Spanish

### English



### DANGER

Electrical current from power, telephone and communication cables is hazardous.

#### To avoid a shock hazard:

- **Do not connect or disconnect any cables or perform installation, maintenance, or reconfiguration of this product during an electrical storm.**
- **Connect all power cords to a properly wired and grounded electrical outlet.**
- **Connect to properly wired outlets any equipment that will be attached to this product.**
- **When possible, use one hand only to connect or disconnect signal cables.**
- **Never turn on any equipment when there is evidence of fire, water, or structural damage.**
- **Disconnect the attached power cords, telecommunications systems, networks, and modems before you open the device covers, unless instructed otherwise in the installation and configuration procedures.**
- **Connect and disconnect cables as described in the following tables when installing, moving, or opening covers on this product or attached devices.**

To Connect	To Disconnect
<ol style="list-style-type: none"> <li>1. Turn everything OFF.</li> <li>2. First, attach all cables to devices.</li> <li>3. Attach signal cables to connectors.</li> <li>4. Attach power cords to outlet.</li> <li>5. Turn device ON.</li> </ol>	<ol style="list-style-type: none"> <li>1. Turn everything OFF.</li> <li>2. First, remove power cords from outlet.</li> <li>3. Remove signal cables from connectors.</li> <li>4. Remove all cables from devices.</li> </ol>



**CAUTION:**

If your system has a module containing a lithium battery, replace it only with the same module type made by the same manufacturer. The battery contains lithium and can explode if not properly used, handled, or disposed of. *Do not:*

- Throw or immerse into water
- Heat to more than 100°C (212°F)
- Repair or disassemble

Dispose of the battery as required by local ordinances or regulations.



**CAUTION:**

When laser products (such as CD-ROMs, DVD-ROM drives, fiber optic devices, or transmitters) are installed, note the following:

- Do not remove the covers. Removing the covers of the laser product could result in exposure to hazardous laser radiation. There are no serviceable parts inside the device.
- Use of controls or adjustments or performance of procedures other than those specified herein might result in hazardous radiation exposure.



**DANGER**

Some laser products contain an embedded Class 3A or Class 3B laser diode. Note the following:

Laser radiation when open. Do not stare into the beam, do not view directly with optical instruments, and avoid direct exposure to the beam.



**CAUTION:**

Use safe practices when lifting.



≥18 kg (37 lb)



≥32 kg (70.5 lb)



≥55 kg (121.2 lb)



**CAUTION:**

The power control button on the device and the power switch on the power supply do not turn off the electrical current supplied to the device. The device also might have more than one power cord. To remove all electrical current from the device, ensure that all power cords are disconnected from the power source.

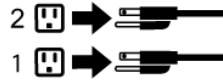

Arabic



التيار الكهربائي الموجود بمصدر الطاقة أو أجهزة التليفون أو أسلاك الاتصالات يشكل خطورة.

لتنقادي مخاطر الصدمات الكهربائية:

لا تحاول توصيل أو فصل أي أسلاك أو القيام بعمليات تركيب أو صيانة أو إعادة توصيف لهذا المنتج أثناء وجود عاصفة كهربائية.

يجب توصيل كل أسلاك الكهرباء في مخارج كهرباء ذات توصيلات أسلاك وتوصيلات أرضية صحيحة

يجب توصيل أي جهاز سيتم الحاقه بهذا المنتج في مخارج كهرباء ذات توصيلات أسلاك صحيحة.

وإن أمكن يجب استخدام يد واحدة فقط في توصيل أو فصل أسلاك الإشارة.

لا تحاول تشغيل أي جهاز إذا كان هناك أثر لحرق أو مياه أو تلف بالمكونات

يجب فصل أسلاك الكهرباء وأنظمة الاتصالات وشبكات الاتصال وأجهزة المسود الملحقة قبل فتح أغطية الجهاز، مالم يتم طلب خلاف ذلك في التعليمات الخاصة بالتركيب والتوصيف.

قم بتوصيل وفصل الأسلاك كما هو موضح في الجدول التالي وذلك عند القيام بعمليات التركيب أو النقل أو فتح أغطية هذا المنتج أو الأجهزة الملحقة.

للتوصيل:	للفصل:
قم بإيقاف كل شيء.	قم بإيقاف كل شيء.
أولاً، قم بتوصيل كل الأسلاك بالأجهزة.	أولاً، قم بفصل كل أسلاك الكهرباء من المخرج.
قم بتوصيل أسلاك الإشارة في لموصلات.	قم بفصل أسلاك الإشارة من الموصلات.
قم بتوصيل أسلاك الكهرباء في المخارج.	قم بفصل كل الأسلاك من الأجهزة.
قم بتشغيل الجهاز.	



تنبيه :

إذا كان النظام الخاص يستخدم معه بطارية ليثيوم قم باستبدالها بنفس النوع الذي تم صناعته من خلال نفس المصنع. تحتوي البطارية على مادة الليثيوم ويمكن أن تنفجر في حالة عدم استخدامها أو التعامل معها بطريقة صحيحة أو عند التخلص منها بطريقة خطأ.

لا تقم بـ:

- القاء البطارية أو غمرها في الماء
- تسخينها أعلى من ١٠٠ درجة مئوية (٢١٢ ° فهرنهايت)
- بتصلحها أو فكها

تخلص من البطارية طبقاً للقانون أو النظام المحلي .



تنبيه :  
أثناء تركيب منتجات ليزر (مثل CD-ROMs أو وحدة تشغيل DVD أو أجهزة Fiber Optic أو وحدات الإرسال) يجب مراعاة الآتي:

لا تنزع الأغطية. قد ينتج عن نزع أغطية منتج الليزر انفجار أشعة الليزر شديدة الخطورة.  
لا يوجد أجزاء يمكن تغييرها داخل الجهاز. قد ينتج عن استخدام تحكمات أو تعديلات أو عمل أي تصرفات أخرى تخالف ما هو محدد هنا إلى انفجار أشعة شديدة الخطورة.



خطر

تحتوي بعض منتجات الليزر على الفئة دايود ليزر مدمج من الفئة Class 3A أو Class 3B. يجب مراعاة الآتي .

أشعة الليزر عند الفتح. لا تحقق إلى الإشعاع و لا تنظر اليه مباشرة بواسطة أي أجهزة مرئية وتجنب التعرض المباشر للإشعاع .



تنبيه :  
يجب استخدام ممارسات آمنة عند الرفع



≥18 kg (37 lb)



≥32 kg (70.5 lb)



≥55 kg (121.2 lb)



تنبيه :  
لا يقر التحكم في التشغيل الموجود على الجهاز والمفتاح الكهربائي الموجود على لوحة التحكم بإيقاف التيار الكهربائي المار بالجهاز. قد يكون للجهاز أكثر من سلك كهربائي واحد. لإيقاف التيار الكهربائي المار بالجهاز، تأكد من فصل جميع أسلاك الكهرباء من مصدر الكهرباء .

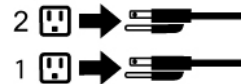

## Brazilian Portuguese



### PERIGO

A corrente elétrica proveniente de cabos de alimentação, de telefone e de comunicações é perigosa.

Para evitar risco de choque elétrico:

- Não conecte nem desconecte nenhum cabo ou execute instalação, manutenção ou reconfiguração deste produto durante uma tempestade com raios.
- Conecte todos os cabos de alimentação a tomadas elétricas corretamente instaladas e aterradas.
- Todo equipamento que for conectado a este produto deve ser conectado a tomadas corretamente instaladas.
- Quando possível, utilize apenas uma das mãos para conectar ou desconectar cabos de sinal.
- Nunca ligue nenhum equipamento quando houver evidência de fogo, água ou danos estruturais.
- Antes de abrir tampas de dispositivos, desconecte cabos de alimentação, sistemas de telecomunicação, redes e modems conectados, a menos que especificado de maneira diferente nos procedimentos de instalação e configuração.
- Conecte e desconecte os cabos conforme descrito na tabela apresentada a seguir ao instalar, mover ou abrir tampas deste produto ou de dispositivos conectados.

Para Conectar:	Para Desconectar:
<ol style="list-style-type: none"><li>1. DESLIGUE Tudo.</li><li>2. Primeiramente, conecte todos os cabos aos dispositivos.</li><li>3. Conecte os cabos de sinal aos conectores.</li><li>4. Conecte os cabos de alimentação às tomadas.</li><li>5. LIGUE os dispositivos.</li></ol>	<ol style="list-style-type: none"><li>1. DESLIGUE Tudo.</li><li>2. Primeiramente, remova os cabos de alimentação das tomadas.</li><li>3. Remova os cabos de sinal dos conectores.</li><li>4. Remova todos os cabos dos dispositivos.</li></ol>



### CUIDADO:

**Se o seu sistema possui um módulo com uma bateria de lítio, substitua-o apenas por um módulo do mesmo tipo e do mesmo fabricante. A bateria contém lítio e pode explodir se não for utilizada, manuseada ou descartada de maneira correta.**

Não:

- Jogue ou coloque na água
- Aqueça a mais de 100°C (212°F)
- Conserte nem desmonte

Descarte a bateria conforme requerido pelas leis ou regulamentos locais.



### PRECAUCIÓN:

Quando produtos a laser (como unidades de CD-ROMs, unidades de DVD-ROM, dispositivos de fibra ótica ou transmissores) estiverem instalados, observe o seguinte:

- Não remova as tampas. A remoção das tampas de um produto a laser pode resultar em exposição prejudicial à radiação de laser. Não existem peças que podem ser consertadas no interior do dispositivo.
- A utilização de controles ou ajustes ou a execução de procedimentos diferentes dos especificados aqui pode resultar em exposição prejudicial à radiação.

### PERIGO

Alguns produtos a laser contêm diodo de laser integrado da Classe 3A ou da Classe 3B. Observe o seguinte:

Radiação a laser quando aberto. Não olhe diretamente para o feixe a olho nu ou com instrumentos ópticos e evite exposição direta ao feixe.



### CUIDADO:

Utilize procedimentos de segurança para levantar equipamentos.



≥18 kg (37 lb)



≥32 kg (70.5 lb)



≥55 kg (121.2 lb)



### CUIDADO:

O botão de controle de alimentação do dispositivo e o botão para ligar/desligar da fonte de alimentação não desligam a corrente elétrica fornecida ao dispositivo. O dispositivo também pode ter mais de um cabo de alimentação. Para remover toda a corrente elétrica do dispositivo, assegure que todos os cabos de alimentação estejam desconectados da fonte de alimentação.

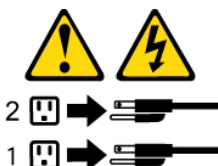

## Chinese (simplified)



危险

电源、电话和通信电缆中的电流是危险的。

为避免电击危险：

- 请勿在雷电期间连接或断开任何电缆的连接，或者对本产品进行安装、维护或重新配置。
- 将所有电源线连接到正确连线和妥善接地的电源插座。
- 将所有要连接到该产品的设备连接到正确连线的插座。
- 如果可能，请仅使用一只手来连接或断开信号电缆的连接。
- 切勿在有火、水、结构损坏迹象的情况下开启任何设备。
- 在打开设备外盖之前请断开已连接的电源线、远程通信系统、网络和调制解调器，除非在安装和配置过程中另有说明。
- 当安装、移动或打开该产品或连接设备的外盖时，请按照下表所述来连接或断开电缆的连接。

要连接	要断开连接
<ol style="list-style-type: none"><li>1. 切断所有电源。</li><li>2. 首先将所有电缆连接到设备。</li><li>3. 将信号电缆连接到接口。</li><li>4. 将电源线连接到插座。</li><li>5. 开启设备。</li></ol>	<ol style="list-style-type: none"><li>1. 切断所有电源。</li><li>2. 首先从插座上拔出电源线。</li><li>3. 从接口上拔出信号电缆。</li><li>4. 从设备上拔出所有电缆。</li></ol>



警告：

如果您的系统有包含锂电池的模块，请仅使用同一制造商生产的相同模块类型来替换该模块。该电池中含有锂，如果使用、操作或处理不当，可能会发生爆炸。

切勿：

- 投入或浸入水中
- 加热到 100 °C (212 °F) 以上
- 维修或拆卸

请按照当地法令或条例的要求处理电池。



警告：

安装激光产品（例如 CD-ROM、DVD-ROM 驱动器、光纤设备或发射设备）时，请注意以下声明：

- 请勿卸下外盖。卸下激光产品的外盖可能导致遭受激光辐射的危险。该设备内没有可维修的部件。
- 如果不按照此处指定的过程进行控制、调整或操作，则有可能导致遭受辐射的危险。



危险

某些激光产品包含嵌入式 3A 类或 3B 类激光二极管。请注意以下声明：

打开后有激光辐射。请勿注视光束，请勿直接用光学仪器查看，并请避免直接暴露在光束中。



警告：  
抬起时请采取安全措施。



≥18 千克 (37 磅)    ≥32 千克 (70.5 磅)    ≥55 千克 (121.2 磅)



警告：  
设备上的电源控制按钮和电源上的电源开关不会切断供给该设备的电流。该设备还可能有多条电源线。要切断该设备的所有电流，请确保所有电源线都与电源断开连接。

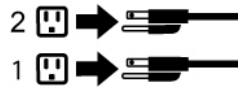

Chinese (traditional)



## 危險

電源、電話及通訊纜線上的電流都具有危險性。

若要避免觸電危險：

- 請勿在雷雨期間，連接或拔除纜線、執行安裝、維護或重新配置本產品。
- 將所有電源線連接到正確配線及接地的電源插座。
- 任何與本產品連接的設備都必須連接到配線妥當的電源插座。
- 請盡可能用單手連接或拔除信號線。
- 發生火災、水災或結構損害時，絕對不要開啟任何設備。
- 除非在安裝及配置程序中另有指示，否則在開啟裝置機蓋之前，請拔掉連接的電源線、電信系統、網路及數據機。
- 安裝、移動或開啟本產品或附屬裝置的機蓋時，請遵循下列說明連接及拔掉纜線。

連線	切斷連線
<ol style="list-style-type: none"><li>1. 關閉所有開關。</li><li>2. 首先，連接所有接線到裝置。</li><li>3. 連接信號線到接頭。</li><li>4. 連接電源線到插座。</li><li>5. 開啟裝置。</li></ol>	<ol style="list-style-type: none"><li>1. 關閉所有開關。</li><li>2. 首先，拔掉插座上的電源線。</li><li>3. 拔掉接頭上的信號線。</li><li>4. 拔掉裝置上所有接線。</li></ol>



### 警告：

如果您的系統中含有鋰電池模組，請僅使用同一家製造商所生產的相同模組進行更換。如果未以正確方式使用、處理或棄置含鋰的電池，會有爆炸的危險。

請勿：

- 沾溼或浸入水中
- 置於 **100°C (212°F)** 以上的高溫環境
- 修理或拆開

請按照各地區有關廢棄電池的法令和規定處理舊電池。



### 警告：

- 請勿移除機蓋。移除雷射產品的機蓋，可能會導致暴露在危險的雷射輻射中。裝置內部並無可自行維修的零件。
- 利用或執行非本文中指定的控制、調整及執行程序，可能會導致危險的輻射外洩。



## 危險

部分雷射產品含有內嵌式 **Class 3A** 或 **Class 3B** 雷射二極體。請注意下列事項：

在開啟光碟機時，會發生雷射輻射。請勿直視光束或用光學儀器直接檢視，並避免直接暴露在光束中。



### 警告：

搬運時請注意安全。



≥ 18 公斤 (37 磅)    ≥ 32 公斤 (70.5 磅)    ≥ 55 公斤 (121.2 磅)



警告：  
裝置上的電源控制按鈕及電源供應器上的電源開關，無法關閉裝置所產生的電流。  
該裝置可能有多條電源線。若要除去裝置流出的所有電流，請確認已切斷所有電源線的電源。

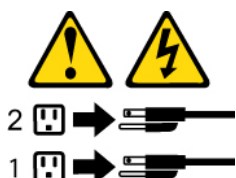

#### French



#### DANGER

Le courant électrique provenant de l'alimentation, du téléphone et des câbles de transmission peut présenter un danger.

Pour éviter tout risque de choc électrique :

- Ne manipulez aucun câble et n'effectuez aucune opération d'installation, d'entretien ou de reconfiguration de ce produit au cours d'un orage.
- Branchez tous les cordons d'alimentation sur un socle de prise de courant correctement câblé et mis à la terre.
- Branchez sur des socles de prise de courant correctement câblés tout équipement connecté à ce produit.
- Lorsque cela est possible, n'utilisez qu'une seule main pour connecter ou déconnecter les câbles d'interface.
- Ne mettez jamais un équipement sous tension en cas d'incendie ou d'inondation, ou en présence de dommages matériels.
- Avant de retirer les carters de l'unité, mettez celle-ci hors tension et déconnectez ses cordons d'alimentation, ainsi que les câbles qui la relie aux réseaux, aux systèmes de télécommunication et aux modems (sauf instruction contraire mentionnée dans les procédures d'installation et de configuration).
- Lorsque vous installez, que vous déplacez, ou que vous manipulez le présent produit ou des périphériques qui lui sont raccordés, reportez-vous aux instructions ci-dessous pour connecter et déconnecter les différents cordons.

Connexion	Déconnexion
<ol style="list-style-type: none"> <li>1. Mettez les unités HORS TENSION.</li> <li>2. Commencez par brancher tous les cordons sur les unités.</li> <li>3. Branchez les câbles d'interface sur des connecteurs.</li> <li>4. Branchez les cordons d'alimentation sur des prises.</li> <li>5. Mettez les unités SOUS TENSION.</li> </ol>	<ol style="list-style-type: none"> <li>1. Mettez les unités HORS TENSION.</li> <li>2. Débranchez les cordons d'alimentation des prises.</li> <li>3. Débranchez les câbles d'interface des connecteurs.</li> <li>4. Débranchez tous les câbles des unités.</li> </ol>



**ATTENTION:**

Si votre système est doté d'un module contenant une pile au lithium, vous devez le remplacer uniquement par un module identique, produit par le même fabricant. La pile contient du lithium et peut exploser en cas de mauvaise utilisation, de mauvaise manipulation ou de mise au rebut inappropriée.

Ne pas :

- la jeter à l'eau,
- l'exposer à des températures supérieures à 100°C,
- chercher à la réparer ou à la démonter.

Ne pas mettre la pile à la poubelle. Pour la mise au rebut, se reporter à la réglementation en vigueur.



**ATTENTION:**

Si des produits à laser (tels que des unités de CD-ROM, de DVD-ROM, des unités à fibres optiques, ou des émetteurs) sont installés, prenez connaissance des informations suivantes :

- Ne retirez pas le carter. En ouvrant l'unité de CD-ROM ou de DVD-ROM, vous vous exposez au rayonnement dangereux du laser. Aucune pièce de l'unité n'est réparable.
- Pour éviter tout risque d'exposition au rayon laser, respectez les consignes de réglage et d'utilisation des commandes, ainsi que les procédures décrites dans le présent manuel.



**DANGER**

Certains produits à laser contiennent une diode à laser intégrée de classe 3A ou 3B. Prenez connaissance des informations suivantes:

Rayonnement laser lorsque le carter est ouvert. Evitez toute exposition directe au rayon laser. Evitez de regarder fixement le faisceau ou de l'observer à l'aide d'instruments optiques.



**ATTENTION:**

**Soulevez la machine avec précaution.**



≥18 kg (37 lb)



≥32 kg (70.5 lb)



≥55 kg (121.2 lb)



**ATTENTION:**

L'interrupteur de contrôle d'alimentation de l'unité et l'interrupteur dubloc d'alimentation ne coupent pas le courant électrique alimentant l'unité. En outre, le système peut être équipé de plusieurs cordons d'alimentation. Pour mettre l'unité hors tension, vous devez déconnecter tous les cordons de la source d'alimentation.

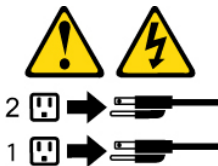

**German**



**VORSICHT**

An Netz-, Telefon- und Datenleitungen können gefährliche Spannungen anliegen.

**Aus Sicherheitsgründen:**

- Bei Gewitter an diesem Gerät keine Kabel anschließen oder lösen. Ferner keine Installations-, Wartungs- oder Rekonfigurationsarbeiten durchführen.
- Gerät nur an eine Schutzkontaktsteckdose mit ordnungsgemäß geerdetem Schutzkontakt anschließen.
- Alle angeschlossenen Geräte ebenfalls an Schutzkontaktsteckdosen mit ordnungsgemäß geerdetem Schutzkontakt anschließen.

- Die Signalkabel nach Möglichkeit einhändig anschließen oder lösen, um einen Stromschlag durch Berühren von Oberflächen mit unterschiedlichem elektrischem Potenzial zu vermeiden.
- Geräte niemals einschalten, wenn Hinweise auf Feuer, Wasser oder Gebäudeschäden vorliegen.
- Die Verbindung zu den angeschlossenen Netzkabeln, Telekommunikationssystemen, Netzwerken und Modems ist vor dem Öffnen des Gehäuses zu unterbrechen, sofern in den Installations- und Konfigurationsprozeduren keine anders lautenden Anweisungen enthalten sind.
- Zum Installieren, Transportieren und Öffnen der Abdeckungen des Computers oder der angeschlossenen Einheiten die Kabel gemäß der folgenden Tabelle anschließen und abziehen.

Zum Anschließen der Kabel gehen Sie wie folgt vor	Zum Abziehen der Kabel gehen Sie wie folgt vor
<ol style="list-style-type: none"> <li>1. Schalten Sie alle Einheiten AUS.</li> <li>2. Schließen Sie erst alle Kabel an die Einheiten an.</li> <li>3. Schließen Sie die Signalkabel an die Buchsen an.</li> <li>4. Schließen Sie die Netzkabel an die Steckdose an.</li> <li>5. Schalten Sie die Einheit EIN.</li> </ol>	<ol style="list-style-type: none"> <li>1. Schalten Sie alle Einheiten AUS.</li> <li>2. Ziehen Sie zuerst alle Netzkabel aus den Netzsteckdosen.</li> <li>3. Ziehen Sie die Signalkabel aus den Buchsen.</li> <li>4. Ziehen Sie alle Kabel von den Einheiten ab.</li> </ol>



#### ACHTUNG:

Enthält das System ein Modul mit einer Lithiumbatterie, dieses nur durch ein Modul desselben Typs und von demselben Hersteller ersetzen. Die Batterie enthält Lithium und kann bei unsachgemäßer Verwendung, Handhabung oder Entsorgung explodieren.

Die Batterie nicht:

- mit Wasser in Berührung bringen.
- über 100 C erhitzen.
- reparieren oder zerlegen.

Die örtlichen Bestimmungen für die Entsorgung von Sondermüll beachten.



#### ACHTUNG:

Bei der Installation von Lasergeräten (wie CD-ROM-Laufwerken, DVD- aufwerken, Einheiten mit Lichtwellenleitertechnik oder Sendern) Folgendes beachten:

- Die Abdeckungen nicht entfernen. Durch Entfernen der Abdeckungen des Lasergeräts können gefährliche Laserstrahlungen freigesetzt werden. Das Gerät enthält keine zu wartenden Teile.
- Werden Steuerelemente, Einstellungen oder Durchführungen von Prozeduren anders als hier angegeben verwendet, kann gefährliche Laserstrahlung auftreten.



#### VORSICHT

Einige Lasergeräte enthalten eine Laserdiode der Klasse 3A oder 3B. Beachten Sie Folgendes:

Laserstrahlung bei geöffneter Verkleidung. Nicht in den Strahl blicken. Keine Lupen oder Spiegel verwenden. Strahlungsbereich meiden.



**ACHTUNG:**

Arbeitsschutzrichtlinien beim Anheben der Maschine beachten.



≥18 kg



≥32 kg



≥55 kg



**ACHTUNG:**

Mit dem Netzschalter an der Einheit und am Netzteil wird die Stromversorgung für die Einheit nicht unterbrochen. Die Einheit kann auch mit mehreren Netzkabeln ausgestattet sein. Um die Stromversorgung für die Einheit vollständig zu unterbrechen, müssen alle zum Gerät führenden Netzkabel vom Netz getrennt werden.



Hebrew



## סכנה

זרם חשמלי המועבר בכבלי חשמל, טלפון ותקשורת הוא מסוכן.

כדי להימנע מסכנת התחשמלות:

- אל תחברו או תנתקו כבלים, ואל תבצעו פעולת התקנה, תחזוקה או שינוי תצורה במוצר זה במהלך סופת ברקים.
- חברו את כל כבלי החשמל לשקע חשמל מחווט ומוארק כהלכה.
- חברו כל ציוד שיחובר למוצר זה לשקעי חשמל מחוטים כהלכה.
- במידת האפשר, השתמשו ביד אחת בלבד לחיבור או לניתוק של כבלי אותות.
- לעולם אל תפעילו ציוד כלשהו כאשר יש עדות לנזק מבני או לנזק כתוצאה מאש או ממים.
- נתקו את כבלי החשמל, מערכות התקשורת, התקני הרשת והמודמים המחוברים לפני פתיחת כיסויי ההתקן, אלא אם הליכי ההתקנה וקביעת התצורה מורים אחרת.
- בעת התקנה, העברה או פתיחת כיסויים במוצר זה או בהתקנים המחוברים, חברו ונתקו את הכבלים כמתואר בטבלה שלהלן.

כדי לחבר	כדי לנתק
1. כבו הכל.	1. כבו הכל.
2. ראשית, חברו את כל הכבלים להתקנים.	2. ראשית, נתקו את כבלי החשמל מהשקעים.
3. חברו את כבלי האותות למחברים.	3. נתקו את כבלי האותות מהמחברים.
4. חברו את כבלי החשמל לשקעים.	4. הסירו את כל הכבלים מההתקנים.
5. הפעילו את ההתקן.	



זהירות:

אם המערכת כוללת מודול המכיל סוללת ליתיום, החליפו אותו רק במודול מאותו סוג ומתוצרת אותו יצרן. הסוללה מכילה ליתיום, ועלולה להתפוצץ אם לא משתמשים ומטפלים בה או משליכים אותה כראוי.

לעולם:

- אל תטבלו במים

- אל תחממו לטמפרטורה הגבוהה מ-100°C (212°F)

- אל תתקנו או תפרקו

השליכו את הסוללה כנדרש לפי התקנות והחוקים המקומיים.



זהירות:

בעת התקנת מוצרי ליזר (כגון כונני תקליטורים ו-DVD, התקני סיב אופטי או משדרים), שימו לב לאזהרות הבאות:

- אל תסירו את הכיסויים. הסרת הכיסויים של מוצר הליזר עלולה לגרום לחשיפה לקרינת ליזר מסוכנת. אין חלקים ברי טיפול בתוך ההתקן.

- שינויים, שימוש בבקורות או ביצוע הליכים אחרים מאלה המתוארים כאן, עלולים לגרום לחשיפה לקרינה מסוכנת.



מוצרי ליזר מסוימים מכילים דיודת ליזר מסוג Class 3A או Class 3B. שימו לב לאזהרה הבאה:  
 כאשר הוא פתוח, המוצר פולט קרינת ליזר. אל תביטו ישירות בקרן, אל תביטו ישירות בעזרת ציוד אופטי,  
 והימענו מחשיפה לקרן.



זהירות:  
 השתמשו בהליכים  
 הנאותים בעת  
 הרמת הציוד.



$18 \leq$  ק"ג (37 ליב')



$32 \leq$  ק"ג (70.5 ליב')



$55 \leq$  ק"ג (121.2 ליב')



זהירות:  
 לחצן ההפעלה של ההתקן ומתג ההפעלה של ספק החשמל אינם מפסיקים את זרם החשמל המסופק להתקן.  
 בנוסף, ההתקן עשוי לכלול יותר מכבל חשמל אחד. כדי לסלק את כל הזרם החשמלי מההתקן,  
 ודאו שכל כבלי החשמל מנותקים ממקור החשמל.

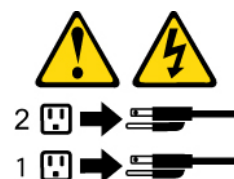

**Italian**



**PERICOLO**

La corrente elettrica proveniente dai cavi di alimentazione, del telefono e di comunicazione può essere pericolosa.

**Per evitare il rischio di scosse elettriche:**

- Non collegare o scollegare qualsiasi cavo oppure effettuare l'installazione, la manutenzione o la riconfigurazione del prodotto durante un temporale.
- Collegare tutti i fili elettrici a una presa di alimentazione correttamente cablata e dotata di messa a terra.
- Collegare alle prese elettriche appropriate tutte le apparecchiature che verranno utilizzate per questo prodotto.
- Se possibile, utilizzare solo una mano per collegare o scollegare i cavi di segnale.
- Non accendere assolutamente apparecchiature in presenza di incendi, perdite d'acqua o danno strutturale.
- Scollegare i cavi di alimentazione, i sistemi di telecomunicazione, le reti e il modem prima di aprire i coperchi del dispositivo, salvo istruzioni contrarie relative alle procedure di installazione e configurazione.
- Collegare e scollegare i cavi come descritto nella seguente tabella quando vengono effettuate operazioni di installazione, spostamento o apertura dei coperchi di questo prodotto o delle unità collegate.

Per collegarsi	Per scollegarsi
<ol style="list-style-type: none"> <li>1. SPEGNERE le apparecchiature.</li> <li>2. Innanzitutto, collegare tutti i cavi alle unità.</li> <li>3. Collegare i cavi di segnale ai connettori.</li> <li>4. Collegare i cavi di alimentazione alla presa.</li> <li>5. Accendere l'unità.</li> </ol>	<ol style="list-style-type: none"> <li>1. SPEGNERE le apparecchiature.</li> <li>2. Innanzitutto, rimuovere i cavi di alimentazione dalla presa.</li> <li>3. Rimuovere i cavi di segnale dai connettori.</li> <li>4. Rimuovere tutti i cavi dalle unità.</li> </ol>



#### ATTENZIONE:

Se sul sistema è presente un modulo che contiene una batteria al litio, sostituirlo solo con un tipo di modulo dello stesso tipo della stessa casa di produzione. La batteria contiene litio e può esplodere se usata, maneggiata o smaltita in modo non corretto.

*Non:*

- Gettare o immergere la batteria nell'acqua
- Riscaldarla ad una temperatura superiore ai 100 gradi C (212 gradi F)
- Smontarla, ricaricarla o tentare di ripararla

Le batterie usate vanno smaltite in accordo alla normativa in vigore (DPR 915/82 e successive disposizioni e disposizioni locali).



#### ATTENZIONE:

Quando vengono installati prodotti laser (quali CD-ROM, unità DVD-ROM, unità a fibre ottiche o trasmettenti), tener presente quanto segue:

- Non rimuovere gli sportelli. L'apertura di un'unità laser può determinare l'esposizione a radiazioni laser pericolose. All'interno dell'unità non vi sono parti su cui effettuare l'assistenza tecnica.
- L'utilizzo di controlli, regolazioni o l'esecuzione di procedure non descritti nel presente manuale possono provocare l'esposizione a radiazioni pericolose.



## PERICOLO

Alcune unità laser contengono un diodo laser di Classe 3A o Classe 3B. Tener presente quanto segue:

Aperto l'unità vengono emesse radiazioni laser. Non fissare il fascio, non guardarlo direttamente con strumenti ottici ed evitare l'esposizione al fascio.



## ATTENZIONE:

Prestare attenzione nel sollevare l'apparecchiatura.



≥18 kg



≥32 kg



≥55 kg



## ATTENZIONE:

Il pulsante di controllo dell'alimentazione presente sull'unità e l'interruttore dell'alimentatore non disattivano l'alimentazione corrente fornita all'unità. E' possibile che l'unità disponga di più cavi di alimentazione. Per disattivare l'alimentazione dall'unità, accertarsi che tutti i cavi di alimentazione siano scollegati dalla fonte di alimentazione.

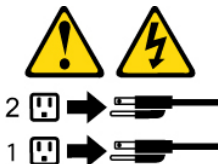

## Korean



## 위험

전원, 전화, 통신 케이블의 전류는 위험합니다.

감전의 위험을 피하려면 다음과 같이 하십시오.

- 번개가 치는 날에는 케이블을 연결 또는 분리하거나 본 제품을 설치, 보수, 재구성하지 마십시오.
- 모든 전원 코드는 올바르게 접지된 전기 콘센트에 연결하십시오.
- 본 제품에 연결될 장치는 올바르게 배선된 콘센트에 연결하십시오.
- 신호 케이블을 연결 또는 분리할 때 가능하면 한 손만을 사용하십시오.
- 불 또는 물로 인한 손상이나 구조적인 손상이 있을 경우 장치의 전원을 절대 켜지 마십시오.
- 설치 및 구성 과정에 별도의 지시 사항이 없는 경우, 장치의 덮개를 열기 전에 연결된 전원 코드, 원격 통신 시스템, 네트워크, 모뎀을 분리하십시오.
- 본 제품이나 연결된 장치를 설치, 이동하거나 덮개를 열 때 다음 표와 같은 순서로 케이블을 연결하거나 분리하십시오.

연결할 때:	분리할 때:
<ol style="list-style-type: none"><li>1. 모든 장치의 전원을 끄십시오.</li><li>2. 먼저 모든 케이블을 장치에 연결하십시오.</li><li>3. 커넥터에 신호 케이블을 연결하십시오.</li><li>4. 콘센트에 전원 코드를 연결하십시오.</li><li>5. 장치의 전원을 켜십시오.</li></ol>	<ol style="list-style-type: none"><li>1. 모든 장치의 전원을 끄십시오.</li><li>2. 먼저 콘센트에서 전원 코드를 분리하십시오.</li><li>3. 커넥터에서 신호 케이블을 분리하십시오.</li><li>4. 장치에서 모든 케이블을 분리하십시오.</li></ol>



## 주의:

사용자의 시스템이 리튬 배터리를 포함하는 모듈일 경우, 동일한 제조업체에서 동일한 모듈 유형으로 생산된 제품으로 교체하십시오. 배터리에는 리튬이 함유되어 있어 잘못 사용, 취급 또는 폐기할 경우 폭발의 위험이 있습니다.

사고를 방지하려면 다음 사항을 준수하십시오.

- 배터리를 물 속에 던지거나 침수시키지 마십시오.
- 100℃ (212°F) 이상 가열하지 마십시오.
- 수리하거나 분해하지 마십시오.

배터리를 폐기할 때는 법령 또는 회사의 안전 수칙에 따라 폐기하십시오.



## 주의:

CD-ROM, DVD-ROM 장치, 광섬유 장치 또는 송신 장치와 같은 레이저 제품을 설치할 때, 다음과 같은 취급 주의사항을 참고하십시오.

- 덮개를 열지 마십시오. 덮개를 열면 레이저 복사 에너지에 노출될 위험이 있습니다. 장치 내부에는 사용자가 조정하거나 수리할 수 있는 부품이 없습니다.
- 규정된 것 이외의 절차 수행, 제어 조정 등의 행위로 인해 해로운 레이저 복사에 노출될 수 있습니다.



## 위험

일부 장비에는 임베디드 클래스 3A 또는 클래스 3B 레이저 다이오드가 있습니다. 다음 주의사항에 유의하십시오.

드라이브가 열리면 레이저 복사 에너지가 방출됩니다. 광선이 눈에 직접 쏘이지 않도록 하십시오. 나안 또는 광학 기구를 착용한 상태에서 광선을 직접 바라보지 않도록 하십시오.



**주의:**  
제품을 들어 올릴 때  
안전 규제를 따르십시오.



≥ 18 kg (37 lbs)



≥ 32 kg (70.5 lbs)



≥ 55 kg (121.2 lbs)



**주의:**  
장치의 전원 제어 버튼 및 전원 공급 장치의 전원 스위치를 사용하여 장치에 공급되는 전기를 차단하지 마십시오.  
장치는 둘 이상의 코드를 가지고 있을 수 있습니다. 장치에서 모든 전원을 차단하려면 콘센트에서 코드가 모두 분리되어 있는지 확인하십시오.

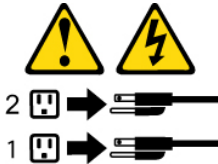

## Spanish



## PELIGRO

La corriente eléctrica procedente de cables de alimentación, teléfonos y cables de comunicación puede ser peligrosa.

**Para evitar el riesgo de descarga eléctrica:**

- **No conecte ni desconecte los cables ni realice ninguna tarea de instalación, mantenimiento o reconfiguración de este producto durante una tormenta eléctrica.**
- **Conecte todos los cables de alimentación a tomas de corriente debidamente cableadas y conectadas a tierra.**

- Cualquier equipo que se conecte a este producto también debe conectarse a tomas de corriente debidamente cableadas.
- Siempre que sea posible, utilice una sola mano para conectar o desconectar los cables de señal.
- No encienda nunca un equipo cuando hay señales de fuego, agua o daños estructurales.
- Desconecte los cables de alimentación, los sistemas de telecomunicaciones, las redes y los módems conectados antes de abrir las cubiertas de los dispositivos, a menos que se indique lo contrario en los procedimientos de instalación y configuración.
- Conecte y desconecte los cables, como se describe en la tabla siguiente, cuando instale, mueva o abra las cubiertas de este producto o de los dispositivos conectados.

Para conectar	Para desconectar
<ol style="list-style-type: none"> <li>1. APÁGUELO todo.</li> <li>2. En primer lugar, conecte todos los cables a los dispositivos.</li> <li>3. Conecte los cables de señal a los conectores.</li> <li>4. Enchufe los cables de alimentación a las tomas de corriente.</li> <li>5. Encienda el dispositivo.</li> </ol>	<ol style="list-style-type: none"> <li>1. APÁGUELO todo.</li> <li>2. En primer lugar, desenchufe los cables de alimentación de las tomas de corriente.</li> <li>3. Desconecte los cables de señal de los conectores.</li> <li>4. Desconecte todos los cables de los dispositivos.</li> </ol>



#### PRECAUCIÓN:

Si su sistema dispone de un módulo que contiene una batería de litio, reemplácelo sólo con el mismo tipo de módulo, del mismo fabricante. La batería contiene litio y puede explotar si no se utiliza, manipula o desecha correctamente.

*No debe:*

- Arrojarla al agua o sumergirla en ella
- Exponerla a temperaturas superiores a 100°C (212°F)
- Repararla o desmontarla

Deshágase de la batería según especifiquen las leyes o normas locales.



#### PRECAUCIÓN:

Cuando haya productos láser (como unidades de CD-ROM, unidades de DVD, dispositivos de fibra óptica o transmisores) instalados, tenga en cuenta lo siguiente:

- No quite las cubiertas. Si quita las cubiertas del producto láser, podría quedar expuesto a radiación láser peligrosa. Dentro del dispositivo no existe ninguna pieza que requiera servicio técnico.
- Si usa controles o ajustes o realiza procedimientos que no sean los especificados aquí, podría exponerse a radiaciones peligrosas.



## PELIGRO

Algunos productos láser tienen incorporado un diodo láser de clase 3A o clase 3B. Tenga en cuenta lo siguiente:

Cuando se abre, queda expuesto a radiación láser. No mire directamente al rayo láser, ni siquiera con instrumentos ópticos, y evite exponerse directamente al rayo láser.



## PRECAUCIÓN:

Adopte procedimientos seguros al levantar el equipo.



≥18 kg



≥32 kg



≥55 kg



## PRECAUCIÓN:

El botón de control de alimentación del dispositivo y el interruptor de alimentación de la fuente de alimentación no desconectan la corriente eléctrica suministrada al dispositivo. Además, el dispositivo podría tener más de un cable de alimentación. Para suprimir toda la corriente eléctrica del dispositivo, asegúrese de que todos los cables de alimentación estén desconectados de la toma de corriente.

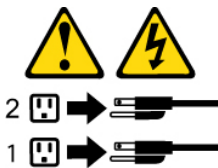

---

## Chapter 3. Diagnostics and troubleshooting

---

### Overall procedure

Use the following procedures as a guide in identifying and correcting problems.

Step 1. Quick diagnostics and troubleshooting:

- a. If a general error is reported by a program or operating system (OS), check the software documentation (like error messages, readme, or help guides) for instructions.
- b. Use an antivirus program to see if the computer has been infected by a virus. If the program detects a virus, remove the virus.
- c. Check if any necessary fixes or updates for software, OS, drivers, or UEFI BIOS are available. If yes, install them.
- d. Check all cable, power cord, and device connections.
- e. Check and ensure that all connected devices are enabled in the UEFI BIOS.
- f. Set all display controls to the middle position.
- g. Restart the computer and all connected devices.

Step 2. Further diagnostics and troubleshooting:

- a. Use diagnostic tools to narrow down the issue. See “Diagnostic tools” on page 31.
- b. Recover the OS if you suspect an OS issue. See Appendix B “Self-help resource” on page 83.
- c. Determine if any action or hardware replacement is required based on the symptoms in “Symptom-to-CRU/FRU index” on page 33  
Turn to Chapter 4 “Hardware replacement” on page 39 for detailed replacement instructions.
- d. For undetermined problems, see “Undetermined problems” on page 36.

Step 3. If the diagnosing procedures above cannot help you isolate and repair the problems, save and print the log files and contact Lenovo for support. See “Call Lenovo” on page 37.

#### Notes:

- The diagnostic tests are intended to test only Lenovo products. The use of non-Lenovo products, prototype cards, or modified options can lead to false indications of errors and invalid system responses.
- The troubleshooting steps or the diagnostic tools might tell you that you need additional or updated device drivers or other software. For the latest drivers and technical updates, go to <https://support.lenovo.com>.
- **Be extremely careful during write operations such as copying, saving, or formatting.** The drives in the computer you are servicing might have been rearranged or the drive startup sequence changed. If you select an incorrect drive, data or programs might be overwritten.
- Due to the variety of hardware and software combinations that can be encountered, use the information listed in “Before contacting Lenovo support” on page 37 to assist you in problem determination.
- Comparing the configuration and software set-up between working and non-working systems will often lead to problem resolution. To eliminate confusion, identical systems are considered identical only if the following criteria are the same.
  - Same machine type and model
  - Same BIOS version
  - Same adapters/attachments in the same locations

- Same address jumpers/terminators/cabling
- Same software versions and levels
- Same Diagnostic Diskette and version
- Same configuration options set in the system
- Same setup for OS control files

## Diagnostic tools

The following table lists some common diagnostic tools for Lenovo computers, including their running environments and brief introductions.

Table 1. Diagnostic tools

Diagnostic tool	Running environment	Brief introduction
Hardware scan in Vantage	Run in the OS.	The hardware scan feature in the Vantage application allows you to have a quick test of key hardware modules on the computer.
Lenovo UEFI diagnostic tool	Run in the UEFI BIOS.	The Lenovo UEFI diagnostic tool enables you to test hardware modules, view system information, and check and recover bad sectors on internal storage devices during system startup.
Advanced diagnostic tools	Run in the OS or boot from USB.	If the computer does not have the diagnostic tools above, or if you want an extensive hardware test, you can download an advanced diagnostic tool from the Lenovo Support Web site.

**Note:** Tool availability may vary by model.

## Hardware scan in Vantage

The hardware scan feature in the Vantage application allows you to have a quick test of key hardware modules on the computer.

To run the hardware scan:

- Step 1. Launch the Vantage app.
- Step 2. Click **Hardware scan** or **Support Services → Hardware scan**.
- Step 3. Choose one of the following ways to run the hardware scan:

Click **Refresh Modules** and check the list of hardware components currently available in the computer. Select **QUICK SCAN** to test all the hardware components detected.

Select **CUSTOMIZE** to choose one or several hardware components to be tested.

- Step 4. If any hardware failure is detected, the result varies depending on the warranty status and varies by country or region. Follow the on-screen instructions to resolve the issue.

## Lenovo UEFI diagnostic tool

The preloaded Lenovo UEFI diagnostic tool enables you to test and diagnose hardware modules in the computer during system startup.

To use the Lenovo UEFI diagnostic tool:

- Step 1. Turn on the computer.
- Step 2. When the logo screen is displayed, repeatedly press and release the F10 key.
- Step 3. When the home screen of the diagnostic tool appears, select a specific hardware module for targeted testing or select **RUN ALL** for a full test.

**Note:** Some tests may require user interaction. Follow the prompts carefully.

Table 2. Options on the home screen of the UEFI diagnostic tool

Category	Items
Tests	<ul style="list-style-type: none"> <li>• Storage</li> <li>• Memory</li> <li>• CPU</li> <li>• Display</li> <li>• Motherboard</li> <li>• RAID</li> <li>• Optical</li> </ul>
Tools	<ul style="list-style-type: none"> <li>• System Information</li> <li>• Bad Block Recovery</li> <li>• Smart Information</li> </ul>

**Note:** The options on the home screen might vary, depending on the hardware configuration and the corresponding protocol the BIOS supports.

Prepare a USB flash drive formatted in FAT32. After testing, select **View Log → Export Log** and save the log to the USB drive. You can view the log to find possible solutions or send the log to Lenovo for helps.

## Advanced diagnostic tools

The advanced diagnostic tools is a suite of downloadable packages that can be run in different operating environments. These tools offer extended tests over various hardware modules. Depending on whether you can boot the Windows OS, select either of the following for diagnostics.

### Use the advanced diagnostic tool (Windows version)

- Step 1. Go to <https://www.lenovo.com/diags>.
- Step 2. Select a Windows package that fits your scenario for download.
- Step 3. Double-click the downloaded file and complete the installation.
- Step 4. Launch the application and follow the on-screen instructions for diagnostics.

After testing, select **Export Log** to save the diagnostic result. You can view the log to find possible solutions or send the log to Lenovo for helps.

### Use the advanced diagnostic tool (bootable versions for Linux/UEFI)

- Step 1. Prepare a USB flash drive (more than 2 GB) formatted in FAT32.

**Note:** Back up any important data on the USB drive, as it will be erased during the process.

- Step 2. Go to <https://support.lenovo.com/solutions/bootableusb>.
- Step 3. Follow the instructions to download a diagnostic package that fits your scenario, create the bootable USB drive, and run the diagnostic tool from the USB drive.

**Note:** For diagnostic packages, UEFI offers both x64 and ARM versions, while Linux offers only an x64 version.

Step 4. When the home screen of the diagnostic tool appears, select a specific hardware module for targeted testing or select **RUN ALL** for a full test.

**Note:** Some tests may require user interaction. Follow the prompts carefully.

After testing, select **View Log** → **Export Log** and save the log to the USB drive. You can view the log to find possible solutions or send the log to Lenovo for helps.

For more information, go to <https://www.lenovo.com/diags>.

---

## Symptom-to-CRU/FRU index

The Symptom-to-CRU/FRU index lists error symptoms and possible causes. The most likely cause is listed first. This index can also be used to help you decide which CRUs/FRUs are likely to need replacing next. If you are unable to correct the problem using this index, go to “Undetermined problems” on page 36.

### Notes:

- The Symptom-to-CRU/FRU index is not specific to any machine type and is applicable to all computers.
- If you have both an error message and an incorrect audio response, diagnose the error message first.
- If you cannot run the diagnostic tests or you get a diagnostic error code when running a test, but did receive a POST error message, diagnose the POST error message first.
- If you did not receive any error message, look for a description of the error symptoms in this index.

## POST error codes

Each time you turn on the system, it performs a series of tests that check the operation of the system and some options. This series of tests are called the *Power-On Self-Test*, or *POST*. POST checks the following operations:

- Some basic system-board operations
- Memory operation
- Video operation
- Whether the boot drive is working

If the POST detects a problem, an error code appears on the screen. If more than one error code is displayed, begin the diagnosis with the first error code. Whatever causes the first error code might also cause false error codes.

POST error code	POST error message	Description	Action
0135	System fan failure	This error message is displayed when a fan fails and the system might be overheating.	Press F10 to exit.

## Beep symptoms

Beep symptoms are tones or a series of tones separated by pauses (intervals without sound) during POST. The following table describes the beep symptoms.

Beep symptom	Error	CRU/FRU or Action
2 short beeps	Common POST error	See the detailed failure information in “POST error codes” on page 33.
3 short and 1 long beeps	DRAM memory error	Perform the following actions in order: <ol style="list-style-type: none"> <li>1. Make sure that the memory modules are properly seated in the memory slots.</li> <li>2. Replace the memory modules.</li> <li>3. Replace the system board.</li> </ol>

## Storage drive boot error

A storage drive boot error can have the following causes.

Possible cause	CRU/FRU or Action
The start-up drive is not in the boot sequence in configuration.	Check the configuration and ensure that the start-up drive is in the boot sequence.
No operating system is installed on the boot drive.	Install an operating system on the boot drive.
The boot sector on the startup drive is corrupted.	The drive must be formatted. Do the following: <ol style="list-style-type: none"> <li>1. Attempt to back up the data on the failing storage drive.</li> <li>2. Using the operating system programs, format the storage drive.</li> </ol>
The drive is defective.	Replace the storage drive.

## Power supply problems

If you suspect a power problem, use the following procedures.

Check/Verify	CRU/FRU or Action
Check the following for proper installation. <ul style="list-style-type: none"> <li>• Power cord</li> <li>• On/Off switch connector</li> <li>• On/Off switch power supply connector</li> <li>• System board power supply connectors</li> <li>• CPU connection</li> </ul>	Reseat connectors.
Check the power cord for continuity.	Power cord
Check the power-on switch for continuity.	Power-on switch

## Miscellaneous error conditions

Message/Symptom	CRU/FRU or Action
Changing display colors	Display/Monitor
The computer will <i>not</i> power-off. See “Storage drive boot error” on page 34.	<ol style="list-style-type: none"> <li>1. Power switch</li> <li>2. System board</li> <li>3. Riser card, if installed.</li> </ol>

Message/Symptom	CRU/FRU or Action
The computer will <i>not</i> RPL from server	<ol style="list-style-type: none"> <li>1. Ensure that the network is in startup sequence as the first device or the first device after diskette.</li> <li>2. Ensure that the network adapter is enabled for RPL.</li> <li>3. Network adapter (Advise network administrator of new MAC address)</li> </ol>
The computer will <i>not</i> perform a Wake On LAN® (if applicable)	<ol style="list-style-type: none"> <li>1. Check the power supply and signal cable connections to the network adapter.</li> <li>2. Ensure that the operating system settings are set to enable Wake on LAN.</li> <li>3. Ensure that the Wake On LAN feature is enabled in Setup/Configuration.</li> <li>4. Ensure that the network administrator is using the correct MAC address.</li> <li>5. Ensure no interrupt or I/O address conflicts.</li> <li>6. Network adapter (advise network administrator of new MAC address)</li> </ol>
Dead computer. See "Storage drive boot error" on page 34.	<ol style="list-style-type: none"> <li>1. Power supply</li> <li>2. System board</li> </ol>
Diskette drive in-use light remains on or does not light when drive is active.	<ol style="list-style-type: none"> <li>1. Diskette drive</li> <li>2. System board</li> <li>3. Diskette drive cable</li> </ol>
Blank screen except for flashing cursor.	<ol style="list-style-type: none"> <li>1. System board</li> <li>2. Primary hard disk drive</li> <li>3. Hard disk drive cable</li> </ol>
Incorrect memory size during POST	<ol style="list-style-type: none"> <li>1. Run the memory tests.</li> <li>2. Memory module</li> <li>3. System board</li> </ol>
"Insert a Diskette" icon appears with a known-good diagnostics diskette in the first 3.5-inch diskette drive.	<ol style="list-style-type: none"> <li>1. System board</li> <li>2. Diskette drive cable</li> <li>3. Network adapter</li> </ol>
Intensity or color varies from left to right of characters and color bars	<ol style="list-style-type: none"> <li>1. Display</li> <li>2. Video adapter (if present)</li> <li>3. System board</li> </ol>
No power or fan not running	<ol style="list-style-type: none"> <li>1. See "Storage drive boot error" on page 34.</li> </ol>
Non-system disk or disk error-type message with a known-good diagnostic diskette.	<ol style="list-style-type: none"> <li>1. Diskette drive</li> <li>2. System board</li> <li>3. Diskette drive cable</li> </ol>
Other display symptoms not listed above (including blank or illegible display)	<ol style="list-style-type: none"> <li>1. Display</li> <li>2. System board</li> </ol>

Message/Symptom	CRU/FRU or Action
Power-on indicator or hard disk drive in-use light not on, but computer works correctly	<ol style="list-style-type: none"> <li>1. Power switch/LED assembly</li> <li>2. System board</li> </ol>
Printer problems	<ol style="list-style-type: none"> <li>1. Printer</li> <li>2. System board</li> </ol>
Program loads from the hard disk with a known-good diagnostics diskette in the first 3.5-inch diskette drive	<ol style="list-style-type: none"> <li>1. Run the Setup Utility program and check the startup sequence.</li> <li>2. Diskette drive</li> <li>3. Diskette drive cable</li> <li>4. System board</li> <li>5. Power supply</li> </ol>
RPL computer cannot access programs from its own hard disk.	<ol style="list-style-type: none"> <li>1. If the network administrator is using LCCM Hybrid RPL, check the startup sequence: <ol style="list-style-type: none"> <li>a. <b>First device - network</b></li> <li>b. <b>Second device - hard disk</b></li> </ol> </li> <li>2. Hard disk drive</li> </ol>
RPL computer does not RPL from server	<ol style="list-style-type: none"> <li>1. Check the startup sequence.</li> <li>2. Check the network adapter LED status.</li> </ol>
Serial or parallel connector device failure (system board connector)	<ol style="list-style-type: none"> <li>1. External device self-test OK?</li> <li>2. External device</li> <li>3. Cable</li> <li>4. System board</li> </ol>
Serial or parallel connector device failure (adapter connector)	<ol style="list-style-type: none"> <li>1. External device self-test OK?</li> <li>2. External device</li> <li>3. Cable</li> <li>4. Alternate adapter</li> <li>5. System board</li> </ol>
Some or all keys on the keyboard do not work	<ol style="list-style-type: none"> <li>1. Keyboard</li> <li>2. Keyboard cable</li> <li>3. System board</li> </ol>

## Undetermined problems

It is recommended that you take the steps below to isolate the failing CRU/FRU (if any) in the following situations:

- The diagnostic procedures above did not identify the device that has failed.
- The wrong devices are installed.
- The system simply is not operating.

Step 1. Verify that all attached devices are supported by the computer.

Step 2. Turn off the computer.

- Step 3. Visually check each CRU/FRU for damage. Replace any damaged CRU/FRU.
- Step 4. Remove or disconnect all of the following devices (if present).
- External devices (modem, printer, or mouse)
  - Any adapters
  - Memory modules
  - Extended video memory
  - External Cache
  - External Cache RAM
  - Solid-state drive
  - Hard disk drive
  - Diskette drive
- Step 5. Turn on the computer to see whether the problem has been solved.
- Step 6. If the problem does not recur, reconnect the removed devices one at a time until you find the failing FRU/CRU.
- Step 7. If the problem remains, replace the following FRUs one at a time (do not replace a nondefective FRU):
- System board
  - Display assembly (if present)

---

## Call Lenovo

If you have tried to correct the problem yourself and still need help, you can call Lenovo Customer Support Center.

## Before contacting Lenovo support

Prepare the following information (especially those shown in **bold**) as much as possible before requesting assistance from Lenovo Service Support and Engineering functions.

- **Product name, machine type and model (MTM), and serial number (SN)**
- Failure symptom
  - **What is the problem?**
  - When and where does it happen (e.g., on single or multiple systems)?
  - **Is the problem continuous or intermittent?**
  - **Are there any error messages or codes?**
  - **Can the problem be reproduced? If yes, describe how.**
  - Has the current configuration ever worked before?
  - If it was working, what changed before the failure occurred?
  - Is this the original reported issue, or has it evolved?
- Software information
  - **Operating system type and version**
  - **Software applications running at the time of failure (name and version)**
- Hardware information
  - BIOS version

- Processor or hard disk drive upgrades information
- Hardware configuration currently in use
- Diagnostics information
  - Did diagnostics indicate a failure?
  - What is the diagnostics type and version used?

## Find the serial number

This topic helps you find the computer serial number.

You can find the serial number via one of the following.

- Open the Vantage app and navigate to **Dashboard** or **Device**.
- Check the machine-type and serial-number label on the computer (see illustration below).

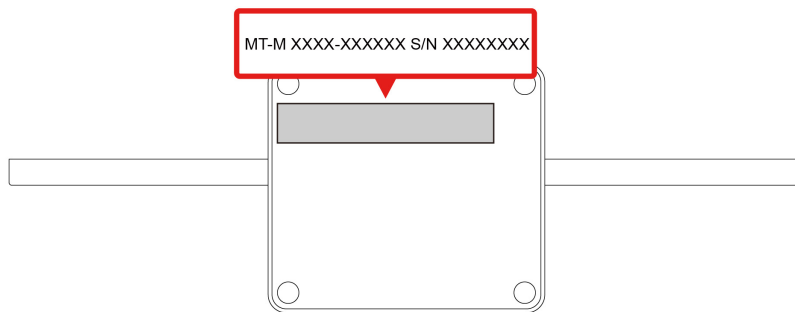

## Lenovo Customer Support Center

During the warranty period, you can call Lenovo Customer Support Center for help.

### Telephone numbers

For a list of the Lenovo Support phone numbers for your country or region, go to:

<https://pcsupport.lenovo.com/supportphonenumberlist>

**Note:** Phone numbers are subject to change without notice. If the number for your country or region is not provided, contact your Lenovo reseller or Lenovo marketing representative.

---

## Chapter 4. Hardware replacement

---

### Before hardware replacement

Carefully read this section before replacing or installing any hardware component.

### Service tools

The following table lists all tools for servicing Lenovo products. Tools required to service a part are listed in the specific part disassembly topic. Prepare them before you service the product.

Table 3. Service tools







No.	Reference image	Tool name	Specification	Tool type
1		Screwdriver set	<ul style="list-style-type: none"><li>• PH0, PH00, PH1, PH2</li><li>• T5, T15, T20, T30</li></ul> <b>Note:</b> Use a screwdriver with the shank length more than 6 inches for desktop, workstation, and smart device products.	Common tool
2		Pry tool	N/A	Common tool
3		Tweezers	<ul style="list-style-type: none"><li>• Conductive</li><li>• Isolated</li></ul>	Common tool
4		Suction cup	N/A	Common tool
5		Hexagonal socket	<ul style="list-style-type: none"><li>• For VGA: H5 mm or H4.8 mm</li><li>• For Tiny antenna: H8 mm</li></ul>	Common tool
6		Adjustable torque screwdriver	0.2 Nm to 4.0 Nm, Threadripper CPU, CAMM, etc.	Common tool

Table 3. Service tools (continued)















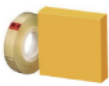

No.	Reference image	Tool name	Specification	Tool type
7		ESD mat	N/A	Common tool
8		USB flash drive	For Golden Key, Chrome Reloads, AutoPilot, etc	Common tool
9		USB-C to USB-A converter	N/A	Common tool
10		Thermal pad	Thermal pads are typically used under the component in different thickness, the most common being 0.5 mm.	Consumable tool
11		Thermal interface materials	N/A	Consumable tool
12		Acetate tape	N/A	Consumable tool
13		Polyimide tape	N/A	Consumable tool
14		Mylar tape	N/A	Consumable tool
15		Electrical tape	N/A	Consumable tool

Table 3. Service tools (continued)

No.	Reference image	Tool name	Specification	Tool type
16		Double-sided tape	N/A	Consumable tool
17		Conductive tape	N/A	Consumable tool
18		Eraser	N/A	Consumable tool
19		Cleaning wipes	N/A	Consumable tool
20		Touchpad jig (this might come with touchpad)	N/A	Consumable tool
21		Heat gun	N/A	Special tool
22		Brown brush	25 mm to 35 mm wide	Special tool
23		Contact cleaner spray	WD-40 Contact cleaner for battery connector	Special tool
24		Hexagonal socket	H17 mm	Special tool

## Screw list

The following table includes the screw list of this product and the recommended screwdriver type.



Table 4. Screw list of this product and the recommended screwdriver type

Screw head type	Thread (mm)	Length (mm)	Color	Screwdriver type
Phillips head	M2	L2.5	Black	PH1
Phillips head	M2.5	L3	White	PH1
Phillips head	M3	L3.6	Black	PH1
Phillips head	M3	L4	Black	PH2
Phillips head	M3	L6	White	PH2
Phillips head	M4	L20	Black	PH2

### Notes:

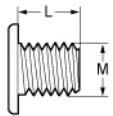
- The number after the letter M refers to the diameter of the screw shank measured across the outermost points in a metric screw. The number after the letter L refers to the length of the screw shank, measured from the underside of the head to the tip.



-  The Phillips head screw has a cross-shaped slot in the screw head. It is recommended to use a PH1 or PH2 Phillips screwdriver for removal or installation.
-  The Torx head screw has a six-pointed star in the screw head.
-  The Hex head screw has a hexagonal head.

## CRU/FRU definition

Your computer contains the following types of “Customer Replaceable Unit” (CRU)s and “Field Replaceable Unit” (FRU)s:

- **Self-service CRUs:** Refer to parts that can be replaced easily by customers themselves or by trained service technicians at an additional cost.
- **Optional-service CRUs:** Refer to parts that can be replaced by customers with a greater skill level. Trained service technicians can also provide service to replace the parts under the type of warranty designated for the customer’s product.
- **FRUs:** Refer to parts that are more complicated to replace and it is recommended that these parts should be replaced by trained service technicians. If customers elect to replace the FRU by themselves, we recommend that you ensure the correct instructions are carefully followed.

### Important notes:

- **CRU/FRU statement:**
  - Each CRU/FRU is available for all types or models, unless otherwise specified.
  - **Replace a CRU/FRU only with another CRU/FRU of the correct model.** When you replace a CRU/FRU, ensure that the model of the product and the CRU/FRU part number are correct.
  - **A CRU/FRU should not be replaced because of a single unreproducible failure.** Single failures can occur for a variety of reasons that have nothing to do with a hardware defect, such as cosmic radiation,

ESD, or software errors. Consider replacing a CRU/FRU only when a problem recurs. If you suspect that a CRU/FRU is defective, clear the error log and run the test again. If the error does not recur, do not replace the CRU/FRU.

- **Be careful not to replace a nondefective CRU/FRU.**

- When you need to return a CRU/FRU after servicing a computer, include the following information in the parts exchange form or parts return form that you attach to it:

1. Name and phone number of service technician
2. Date of service
3. Date on which the machine failed
4. Date of purchase
5. Failure symptoms, error codes appearing on the display, and beep symptoms
6. Procedure index and page number in which the failing CRU/FRU was detected
7. Failing CRU/FRU name and part number
8. Machine type, model number, and serial number
9. Customer's name and address

- **CRU/FRU replacement strategy:**

Use the following strategy to prevent unnecessary expense for replacing and servicing parts:

- If you are instructed to replace a part but the replacement does not correct the problem, reinstall the original part before you continue.
- Some computers have both a processor board and a system board. If you are instructed to replace either the processor board or the system board, and replacing one of them does not correct the problem, reinstall that board, and then replace the other one.
- If an adapter or a device consists of more than one part, any of the parts may be the cause of the error. Before replacing the adapter or device, remove the parts one by one to see if the symptoms change. Replace only the part that changed the symptoms.

- **CRU statement for customers:**

- You can resolve some problems with your product by replacing a CRU. *For self-service CRUs, installation is your responsibility. For optional-service CRUs, you can either install the CRU yourself or you can request that a Service Provider install the CRU according to the warranty service for your product.*

**Important:** For users in mainland China, users shall not perform maintenance on their own. Any faults or damage due to improper operation, modification, or failure to use parts provided by Lenovo are not covered by the warranty for this product. For product warranty information, refer to the warranty document provided with the product or go to the official Lenovo website at <https://newsupport.lenovo.com.cn>.

- If you intend on installing the CRU, Lenovo will ship the CRU to you. CRU information and replacement instructions are shipped with your product and are available from Lenovo at any time upon request.
- When you are required to return the defective CRU, (1) return instructions, a prepaid shipping label, and a container will be included with the replacement CRU; and (2) you might be charged for the replacement CRU if Lenovo does not receive the defective CRU within thirty (30) days of your receipt of the replacement CRU. See your Lenovo Limited Warranty documentation for full details.

## CRU list

### Exploded view

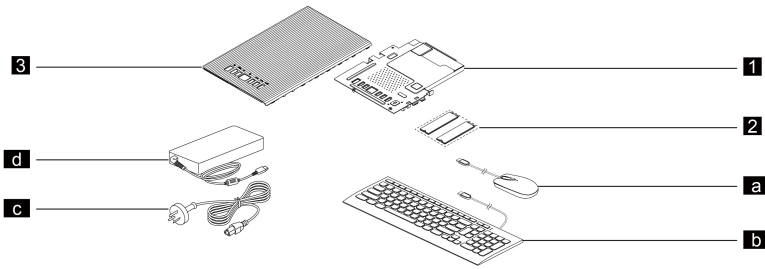

### Part list

#### Self-service CRUs:

- 3** "Rear cover" on page 50
- 4** Mouse
- 5** Keyboard
- 4 5** "Power cord and ac power adapter" on page 49

#### Optional-service CRUs:

- 1** "System board shielding" on page 51
- 2** M.2 solid-state drive - "M.2 solid-state drive and thermal pad" on page 52

## FRU list

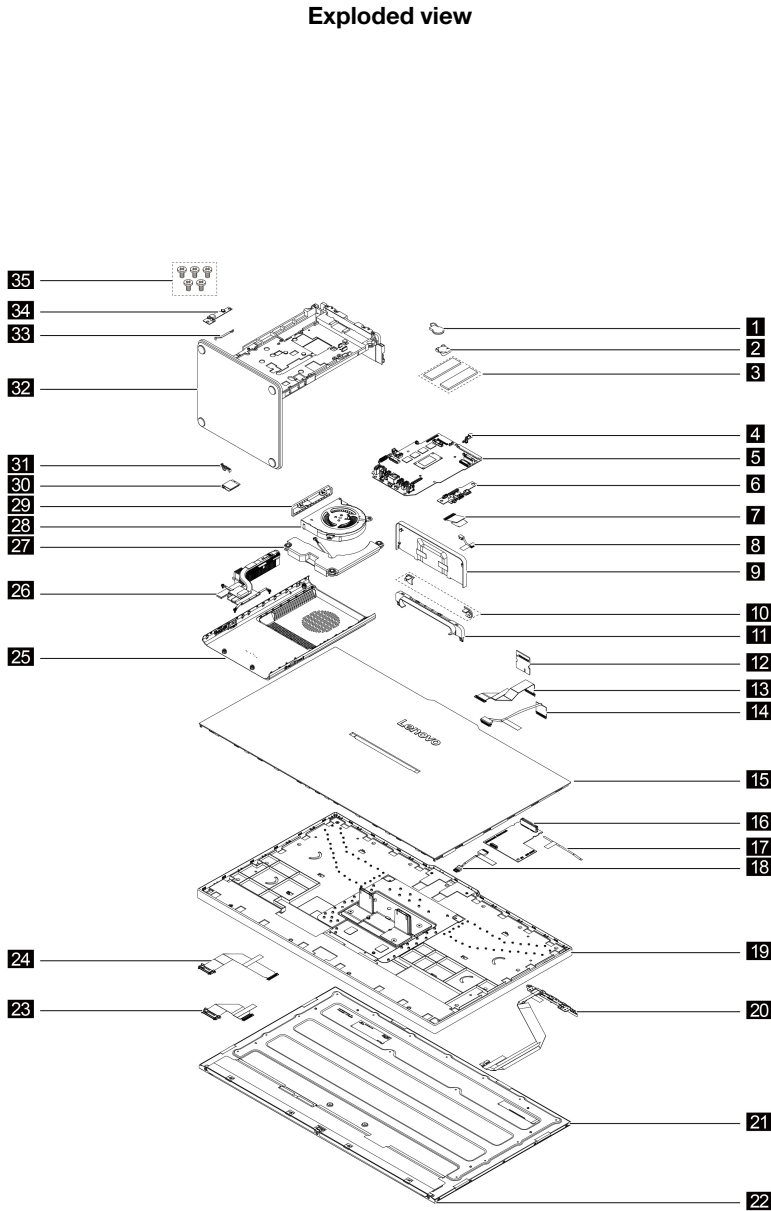

## Part list

### FRUs

- 1 2** “Coin-cell battery and rubber” on page 53
- 3** Thermal pads - “M.2 solid-state drive and thermal pad” on page 52
- 4** “Duet clip” on page 52
- 5** “System board” on page 61
- 6 7 8** “Side I/O board, side I/O board cable, and side I/O board FFC” on page 57
- 9** “Hinge cover (top)” on page 50
- 10** “Cover cap (left and right)” on page 60
- 11** “Hinge cover (front)” on page 61
- 12 13 14** “Golden finger board, golden finger board cable, and golden finger board FCC” on page 67
- 15** “LCD cover” on page 69
- 16** “Scalar board” on page 72
- 17\*** “Touch cable (for selected models)” on page 70
- 18** “Backlight cable” on page 71
- 19** “LCD frame assembly” on page 75
- 20** “Camera assembly” on page 76
- 21** “LCD panel” on page 80
- 22** “LCD panel bezel” on page 79
- 23** “LVDS cable 1” on page 77
- 24** “LVDS cable 2” on page 78
- 25** “Front cover” on page 59
- 26** “Thermal module” on page 58
- 27** “Speaker” on page 65
- 28 29** “Thermal fan and bracket” on page 66
- 30 31** “Wi-Fi card and Wi-Fi card cover” on page 54
- 32** “Stand assembly” on page 64
- 33 34** “Power switch board and power switch board FFC” on page 55
- 35** Screw kit

\* for selected models

## Look up a part

1. For more detailed CRU/FRU information, including part numbers, descriptions, and substitution part numbers, go to <https://support.lenovo.com/partslookup>.
2. Type the product name, the machine type or the serial number in the corresponding field to get a general CRU/FRU list.

# Prerequisites for hardware replacement

## General prerequisites

Before replacing any parts, make sure you have:

- Read *Generic Safety and Compliance Notices* and any safety requirements for hardware maintenance in this manual.
- Installed any necessary software fixes, drivers, and UEFI BIOS downloads.  
To access these, go to <https://support.lenovo.com> and follow the on-screen instructions.

## Prerequisites for opening computer covers



During operation, some components become hot enough to burn the skin. Before you open the computer cover, remove any media from the drives, turn off the computer and connected devices, disconnect power, remove all cables and locking devices, and wait approximately 10 minutes until the computer is cool.

## Prerequisites for replacing parts with cables

Before reaching parts with cables, record the cable routing for future reference and then disconnect the cables from the system board.

## Prerequisites for replacing internal storage drives

**Attention:** The internal storage drive is sensitive. Inappropriate handling might cause damage and loss of data. When handling the internal storage drive, observe the following guidelines:

- Replace internal storage drives only for repair. The internal storage drives are not designed for frequent changes or replacement.
- Before replacing an internal storage drive, make a backup copy of all the data that you want to keep, then perform a low-level format to erase all data.
- Be extremely careful during write operations such as copying, saving, or formatting. The drives in the computer you are servicing might have been rearranged or the drive startup sequence changed. If you select an incorrect drive, data or programs might be overwritten.
- Do not touch the contact edge of the internal storage drive. Otherwise, the internal storage drive might get damaged.
- Do not apply pressure or expose the drive to physical shocks or vibration. Place it on a soft surface, such as a cloth, for protection.

## System board illustration

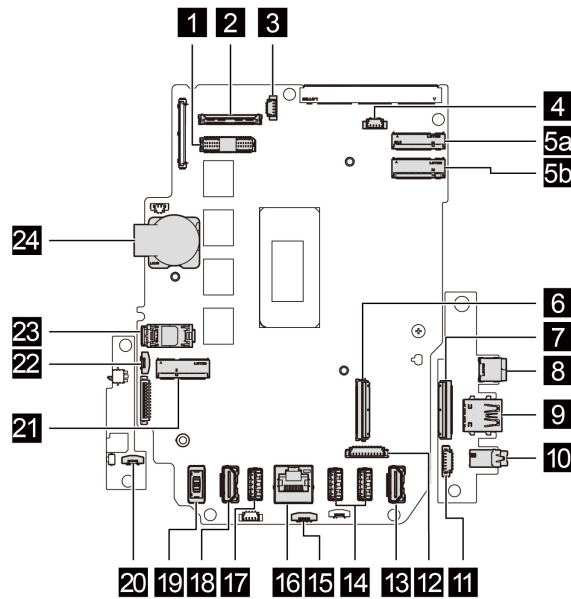

Item	Description	Item	Description
<b>1</b>	Scalar board connector 1	<b>2</b>	Scalar board connector 2
<b>3</b>	Thermal fan connector	<b>4</b>	Speaker connector
<b>5a</b>	Secondary M.2 solid-state drive slot	<b>5b</b>	Primary M.2 solid-state drive slot
<b>6</b>	Side I/O board FFC connector 1 (on system board)	<b>7</b>	Side I/O board FFC connector 2 (on side I/O board)
<b>8</b>	USB-C connector (USB 10Gbps)	<b>9</b>	USB-A connectors (USB 10Gbps)
<b>10</b>	Combo audio jack	<b>11</b>	Side I/O board cable connector 1 (on side I/O board)
<b>12</b>	Side I/O board cable connector 2 (on system board)	<b>13</b>	HDMI 2.1 TMDS out connector
<b>14</b>	USB-A connectors (USB 10Gbps)	<b>15</b>	Wireless charging connector
<b>16</b>	Ethernet connector	<b>17</b>	USB-A connector (Hi-Speed USB)
<b>18</b>	HDMI in connector	<b>19</b>	Power connector
<b>20</b>	Power switch board connector 1 (on power switch board)	<b>21</b>	Wi-Fi card slot
<b>22</b>	Power switch board connector 2 (on system board)	<b>23</b>	ROM socket*
<b>24</b>	Coin-cell battery		

\* for selected models

**Note:** The CPU is affixed to the system board via soldering.

## Scalar board illustration

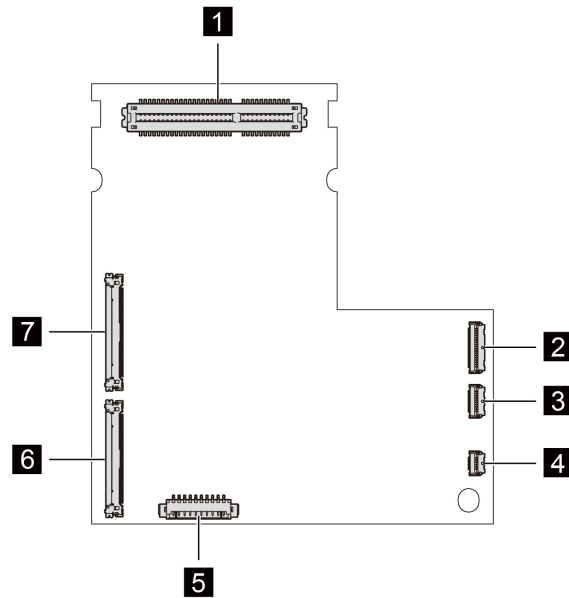

Item	Description	Item	Description
<b>1</b>	Golden finger board connector	<b>2</b>	Camera assembly connector 1
<b>3</b>	Camera assembly connector 2	<b>4</b>	Touch cable connector
<b>5</b>	Backlight cable connector	<b>6</b>	LVDS cable connector 1
<b>7</b>	LVDS cable connector 2		

## Handling thermal interface materials

Thermal interface materials (TIMs) are applied at key thermal interfaces, such as between the processor and the heat sink or between the system board bottom and a structural cover, to eliminate air gaps and maximize thermal conductivity. Proper handling of TIMs is essential during servicing procedures like heat sink or processor replacement.

Before installing a part involving a TIM:

1. Remove all residual TIMs from both contact surfaces.
2. Apply new TIMs following the specifications below.

**Note:** Some replacement parts may have factory-applied TIMs. If present, check if the TIMs are intact and free of defects. If damaged or dried, clean and apply fresh TIMs per specifications below.

### TIM specifications

The table below outlines the recommended TIM type, quantity, and application area.

Type	Quantity	Size	Thickness	Area
PTM7958-SP	1	33 mm x 14 mm	0.2 mm	<b>A</b>

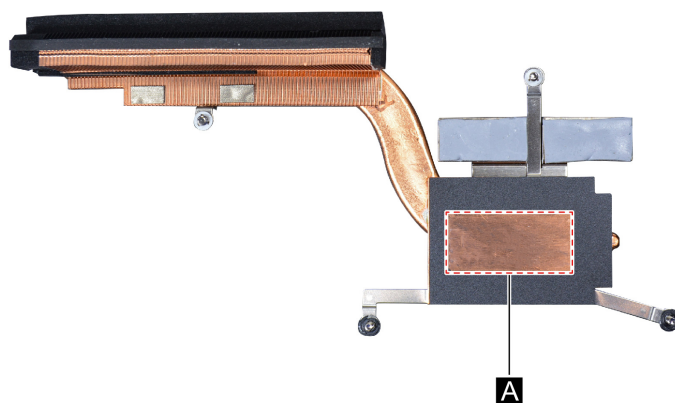

Figure 1. Designated TIM application area on the heat sink

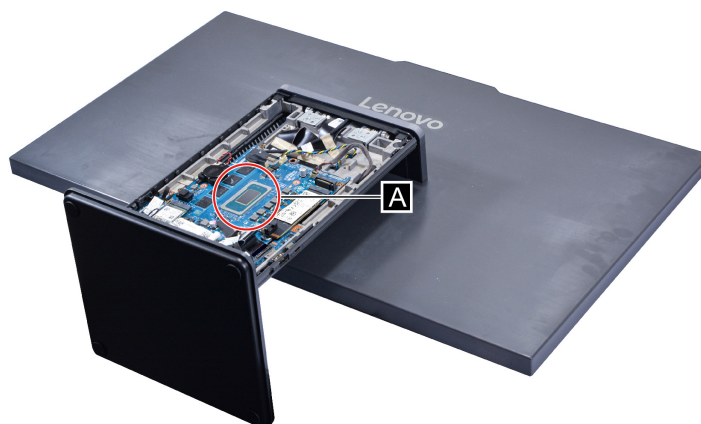

Figure 2. Processor surface area requiring TIM removal prior to reinstallation

---

## External options

You can connect external options to your computer, such as external speakers, a printer, or a scanner. For some external options, you must install additional software in addition to making the physical connection. When installing an external option, see Chapter 1 “Product overview” on page 1 to identify the required connector. Then, use the instructions that come with the option to help you make the connection and install any required software or device drivers.

---

## Power cord and ac power adapter

Before you start, read “Prerequisites for hardware replacement” on page 46.

### Replacement steps

- Step 1. Place a soft, clean towel or cloth on the desk or surface. Hold the computer sides and gently lay it down so that the computer cover is facing up.
- Step 2. Remove the power cord and the ac power adapter.

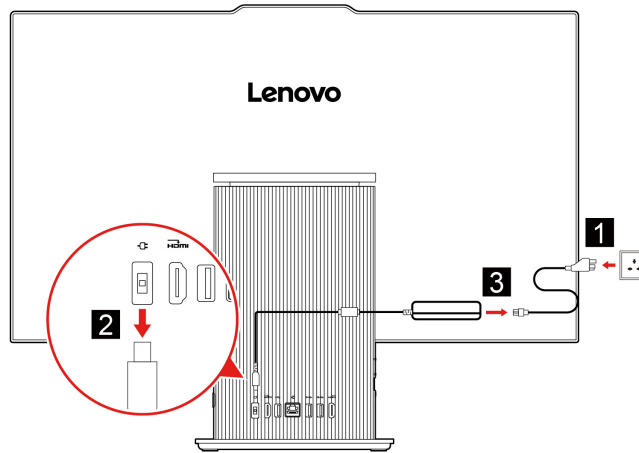

Step 3. Install the power cord and the ac power adapter in reverse order.

## Hinge cover (top)

Before you start, read “Prerequisites for hardware replacement” on page 46.

### Replacement steps

- Step 1. Place a soft, clean towel or cloth on the desk or surface. Hold the computer sides and gently lay it down so that the computer cover is facing up.
- Step 2. Remove “Power cord and ac power adapter” on page 49.
- Step 3. Remove the hinge cover (top).

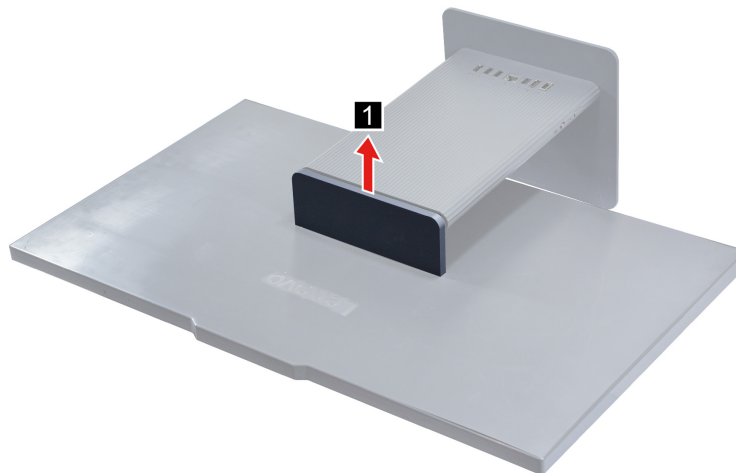

Step 4. Install the hinge cover (top) and other removed parts in reverse order.

## Rear cover

Before you start, read “Prerequisites for hardware replacement” on page 46.

### Replacement steps

- Step 1. Place a soft, clean towel or cloth on the desk or surface. Hold the computer sides and gently lay it down so that the computer cover is facing up.

Step 2. Remove “Power cord and ac power adapter” on page 49.

Step 3. Remove the rear cover.

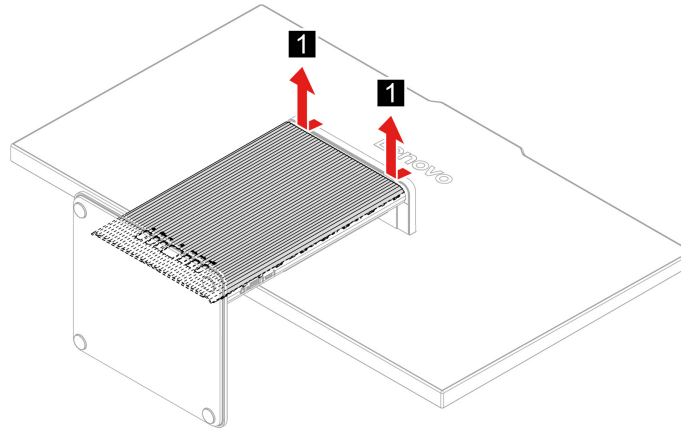

Step 4. Install the rear cover in reverse order.

---

## System board shielding

Before you start, read “Prerequisites for hardware replacement” on page 46.

### Replacement steps

Step 1. Remove the following parts, if any, in order.

- “Power cord and ac power adapter” on page 49
- “Rear cover” on page 50.

Step 2. Remove screws **1a**, partially loosen screws **1b**, then remove the system board shielding.

**Note:** The screws **1b** are fixed to the system board shielding and cannot be removed completely.

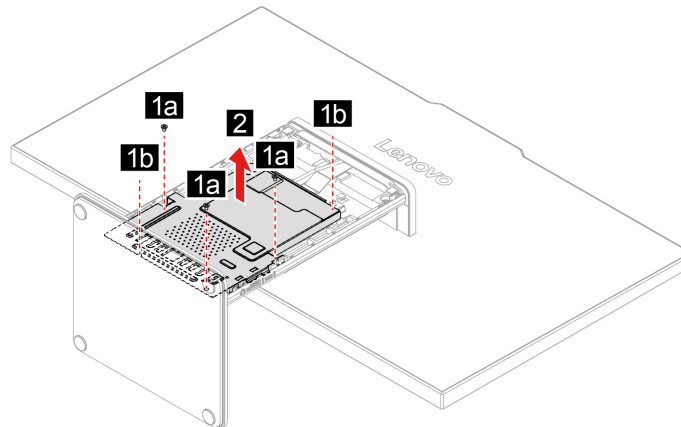

Label	Thread (mm)	Length (mm)	Torque (kgf. cm)	Color	Quantity
<b>1a 1b</b>	M3	L4	6 ± 0.22	Black	5

Step 3. Install the system board shielding and other removed parts in reverse order.

---

## M.2 solid-state drive and thermal pad

Before you start, read “Prerequisites for hardware replacement” on page 46.

### Important notice for installing the SSD

- The thermal pad should be applied to the M.2 solid-state drive to help prevent overheating.
- For better performance, it's recommended that you install M.2 SSDs of the same generation to the on-board SSD slots.

### Replacement steps

Step 1. Remove the following parts, if any, in order.

- “Power cord and ac power adapter” on page 49
- “Rear cover” on page 50.
- “System board shielding” on page 51

Step 2. Locate the M.2 SSD slots based on the “System board illustration” on page 47.

Step 3. Remove the SSD.

1. Gently pull up the duet clip that secures the SSD.
2. Gently pull the SSD away from the M.2 SSD slot.
3. Remove the thermal pad.

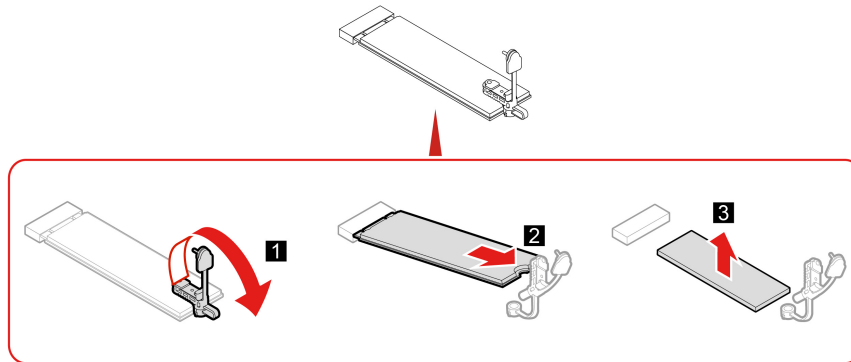

Step 4. Install the SSD, the thermal pad, and other removed parts in reverse order.

---

## Duet clip

Before you start, read “Prerequisites for hardware replacement” on page 46.

### Replacement steps

Step 1. Remove the following parts, if any, in order.

- “Power cord and ac power adapter” on page 49
- “Rear cover” on page 50.
- “System board shielding” on page 51
- “M.2 solid-state drive and thermal pad” on page 52

Step 2. Remove the duet clip.

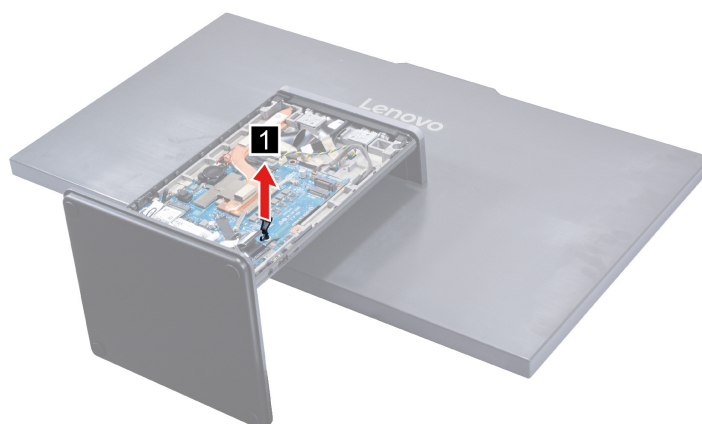

Step 3. Install the duet clip and other removed parts in reverse order.

---

## Coin-cell battery and rubber

Before you start, read “Prerequisites for hardware replacement” on page 46.

### About the coin-cell battery

The computer has a special type of memory that maintains the date, time, and settings for built-in features, such as parallel connector assignments (configurations). A coin-cell battery keeps this information active when you turn off the computer.

The coin-cell battery normally requires no charging or maintenance throughout its life; however, no coin-cell battery lasts forever. If the coin-cell battery fails, the date and time information is lost. An error message is displayed when you turn on the computer.

To dispose of the coin-cell battery, refer to the “Lithium coin-cell battery notice” in the *Safety and Warranty Guide*.

### Replacement steps

Step 1. Remove the following parts, if any, in order.

- “Power cord and ac power adapter” on page 49
- “Rear cover” on page 50.
- “System board shielding” on page 51

Step 2. Locate the coin-cell battery based on the “System board illustration” on page 47.

Step 3. Remove the coin-cell battery and coin-cell battery rubber.

1. Disconnect the coin-cell battery cable from the system board and then remove the coin-cell battery.

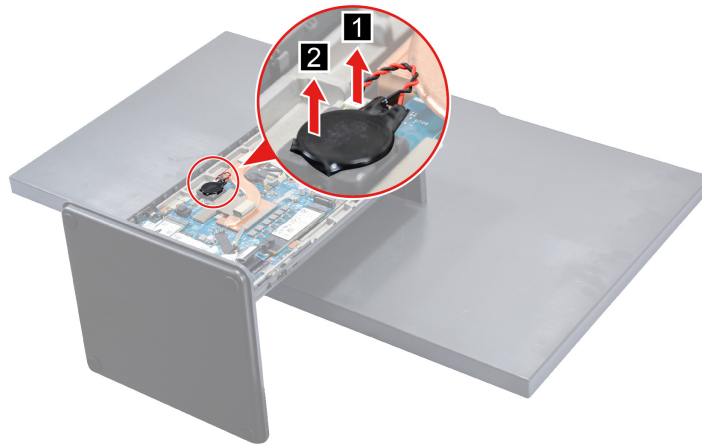

2. Remove the coin-cell battery rubber.

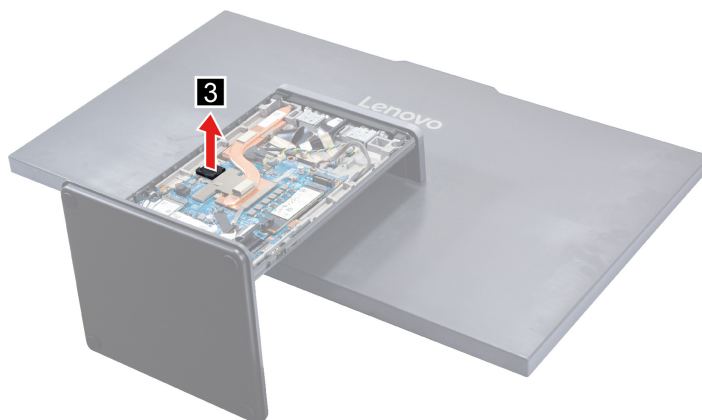

Step 4. Install the coin-cell battery, coin-cell battery rubber, and other removed parts in reverse order.

### After replacement

After installing a new coin-cell battery, reset the system date and time in the UEFI BIOS menu.

---

## Wi-Fi card and Wi-Fi card cover

Before you start, read “Prerequisites for hardware replacement” on page 46.

### Replacement steps

Step 1. Remove the following parts, if any, in order.

- “Power cord and ac power adapter” on page 49
- “Rear cover” on page 50.
- “System board shielding” on page 51

Step 2. Locate the Wi-Fi card slot based on the “System board illustration” on page 47.

Step 3. Remove the Wi-Fi card and Wi-Fi card cover.

1. Remove one screw securing the Wi-Fi card and the cover to the system board, and then remove the Wi-Fi card cover.

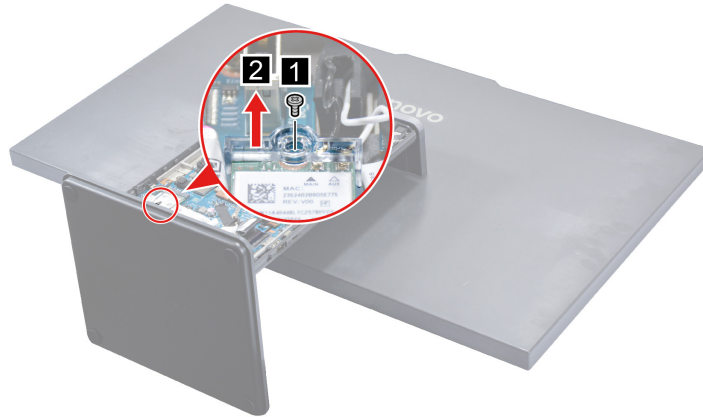

Location	Thread (mm)	Length (mm)	Torque (kgf. cm)	Color	Quantity
<b>1</b>	M3	L6	3.22 ± 0.22	White	1

2. Detach the main and auxiliary antenna cable connectors and then remove the Wi-Fi card by pulling it away from the slot.

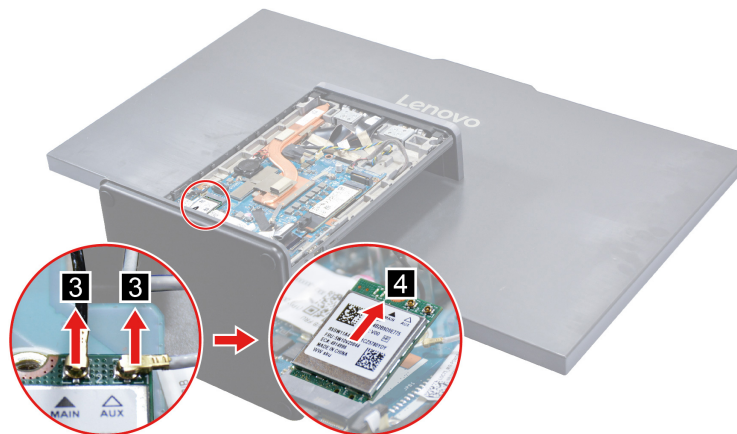

Step 4. Install the Wi-Fi card, the Wi-Fi card cover, and other removed parts in reverse order.

**Note:** While installing the Wi-Fi card, ensure that you connect the gray antenna cable to the connector labeled 1 (or AUX) and the black antenna cable to the connector labeled 2 (or MAIN) on the card.

---

## Power switch board and power switch board FFC

Before you start, read “Prerequisites for hardware replacement” on page 46.

### Replacement steps

Step 1. Remove the following parts, if any, in order.

- “Power cord and ac power adapter” on page 49
- “Rear cover” on page 50.
- “System board shielding” on page 51

Step 2. Locate the power connect based on the “System board illustration” on page 47.

Step 3. Remove the power switch board and power switch board FFC.

**Note:** Before removing the power switch board, make sure the camera switch is set to OFF to prevent damage to the board.

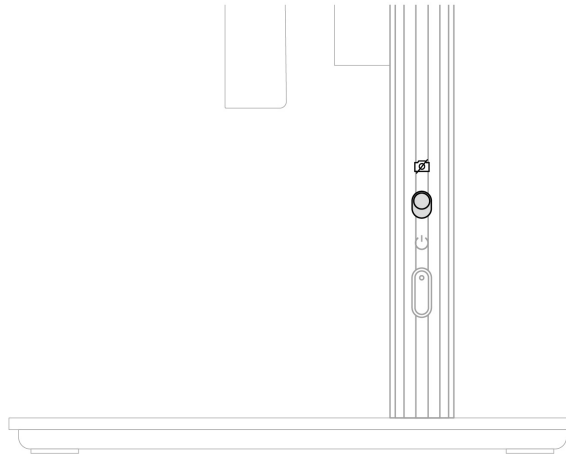

1. Disconnect the power switch board FFC from the system board. Remove one screw, and then remove the power switch board.

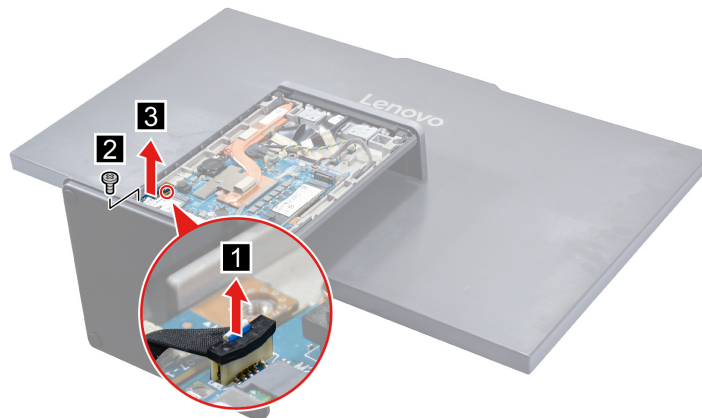

Location	Thread (mm)	Length (mm)	Torque (kgf. cm)	Color	Quantity
<b>2</b>	M3	L4	3.22 ± 0.2	White	1

2. Remove the power switch board FFC from the power switch board.

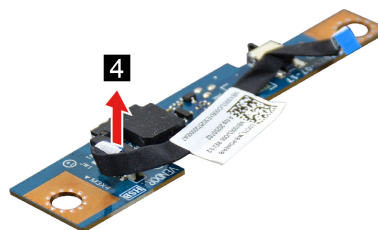

Step 4. Install the power switch board, power switch board FFC, and other removed parts in reverse order.

---

## Side I/O board, side I/O board cable, and side I/O board FFC

Before you start, read “Prerequisites for hardware replacement” on page 46.

### Replacement steps

Step 1. Remove the following parts, if any, in order.

- “Power cord and ac power adapter” on page 49
- “Rear cover” on page 50.
- “System board shielding” on page 51

Step 2. Locate the side I/O board cable and FFC connector based on the “System board illustration” on page 47.

Step 3. Remove the side I/O board, side I/O board cable, and side I/O board FFC.

1. Peel off the tape and then disconnect the side I/O board cable from the system board.

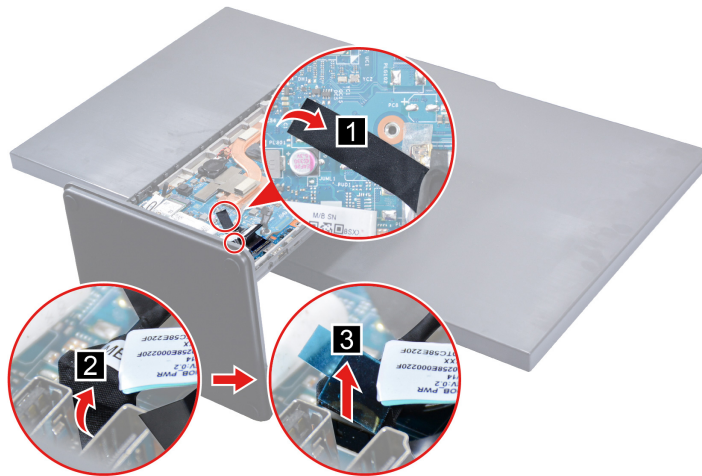

2. Disconnect the side I/O board FFC from the system board.

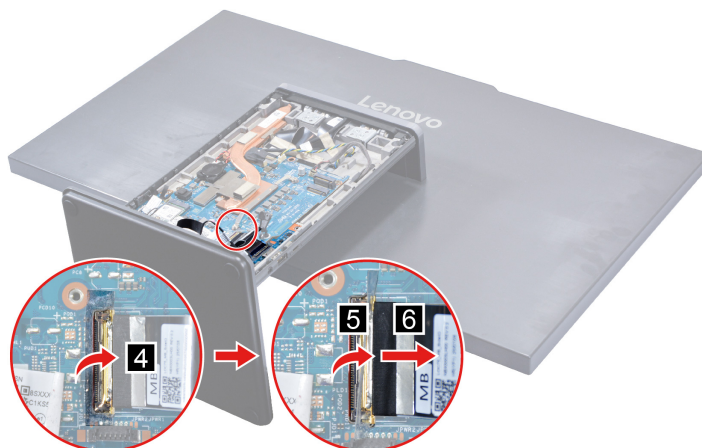

3. Remove one screw and then remove the side I/O board.

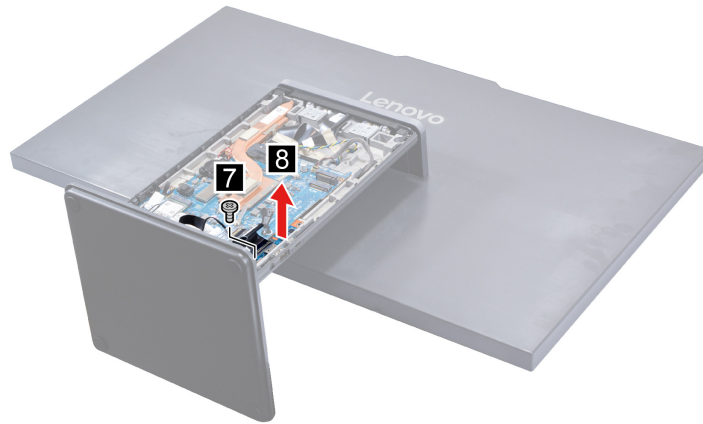

Location	Thread (mm)	Length (mm)	Torque (kgf. cm)	Color	Quantity
7	M3	L4	3.22 ± 0.2	Black	1

4. Remove the side I/O board FFC from the side I/O board.

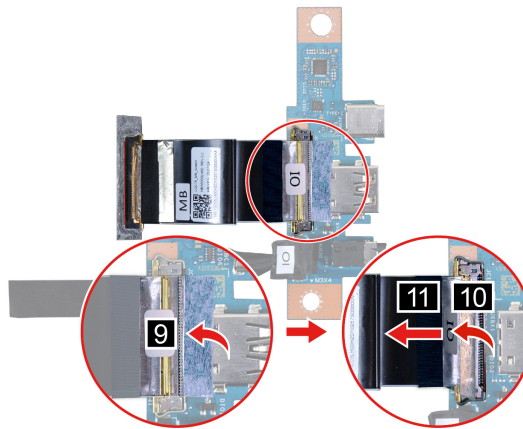

5. Remove the side I/O board cable from the side I/O board.

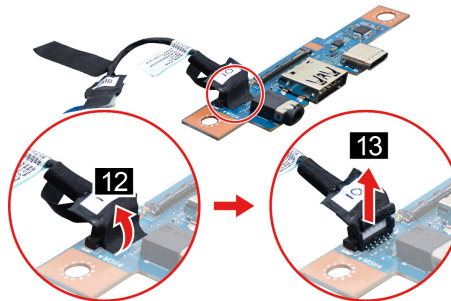

Step 4. Install the side I/O board, side I/O board cable, side I/O board FFC, and other removed parts in reverse order.

## Thermal module

Before you start, read “Prerequisites for hardware replacement” on page 46.

### Replacement steps

Step 1. Remove the following parts, if any, in order.

- “Power cord and ac power adapter” on page 49
- “Rear cover” on page 50.
- “System board shielding” on page 51

Step 2. Loosen four captive screws on the thermal module according to the alphabetical order shown below. Then, gently remove the thermal module to free it from the CPU.

**Note:** Avoid touching the thermal interface materials (TIMs) while handling the thermal module.

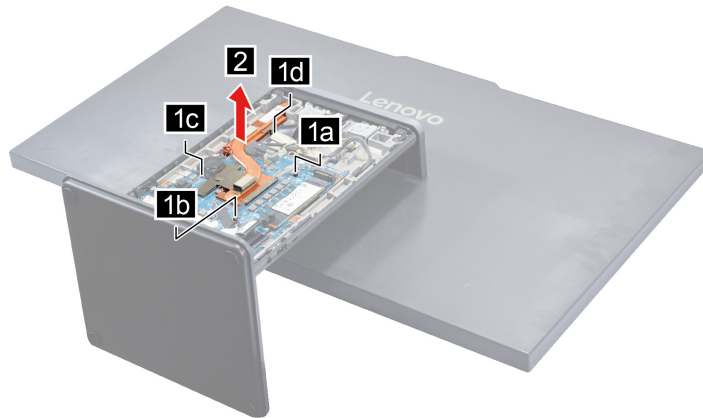

Step 3. Remove old TIMs and apply new TIMs following the instructions in “Handling thermal interface materials” on page 48.

Step 4. Install the thermal module and other removed parts in reverse order.

---

## Front cover

Before you start, read “Prerequisites for hardware replacement” on page 46.

### Replacement steps

Step 1. Remove the following parts, if any, in order.

- “Power cord and ac power adapter” on page 49
- “Rear cover” on page 50.
- “System board shielding” on page 51
- “Side I/O board, side I/O board cable, and side I/O board FFC” on page 57

Step 2. Remove four screws and then remove the front cover.

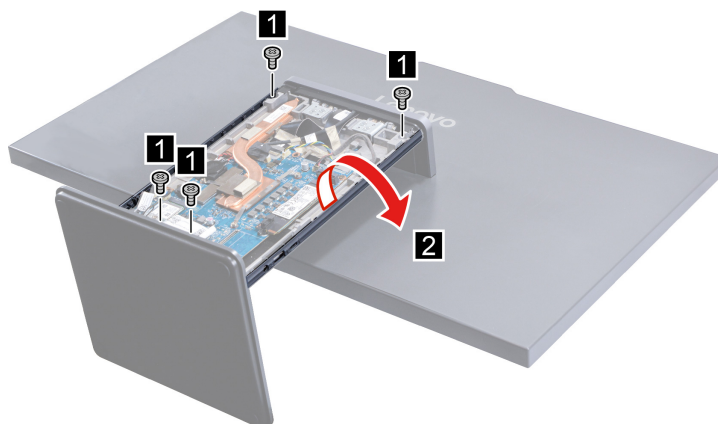

Location	Thread (mm)	Length (mm)	Torque (kgf. cm)	Color	Quantity
<b>1</b>	M3	L4	3.22 ± 0.22	Black	4

Step 3. Install the front cover and other removed parts in reverse order.

## Cover cap (left and right)

Before you start, read “Prerequisites for hardware replacement” on page 46.

### Replacement steps

Step 1. Remove the following parts, if any, in order.

- “Power cord and ac power adapter” on page 49
- “Hinge cover (top)” on page 50
- “Rear cover” on page 50.
- “System board shielding” on page 51
- “Front cover” on page 59

Step 2. Remove the cover cap (left and right).

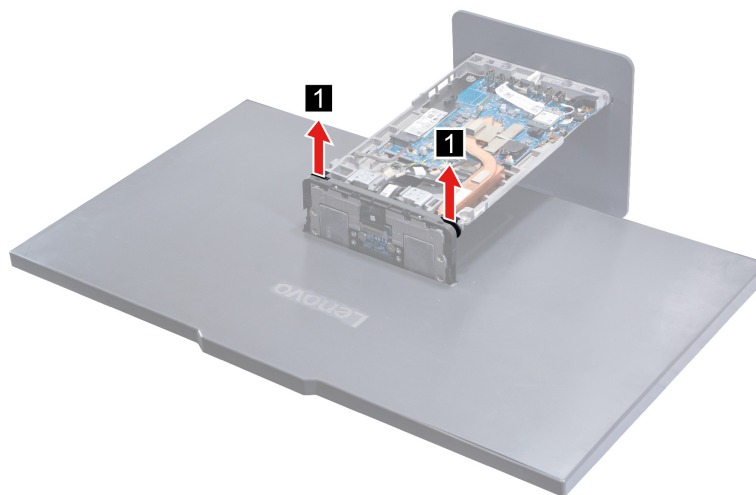

Step 3. Install the cover cap (left and right) and other removed parts in reverse order.

---

## Hinge cover (front)

Before you start, read “Prerequisites for hardware replacement” on page 46.

### Replacement steps

Step 1. Remove the following parts, if any, in order.

- “Power cord and ac power adapter” on page 49
- “Hinge cover (top)” on page 50
- “Rear cover” on page 50.
- “System board shielding” on page 51
- “Front cover” on page 59
- “Cover cap (left and right)” on page 60

Step 2. Pull the left and right buckles outward and then remove the hinge cover (front).

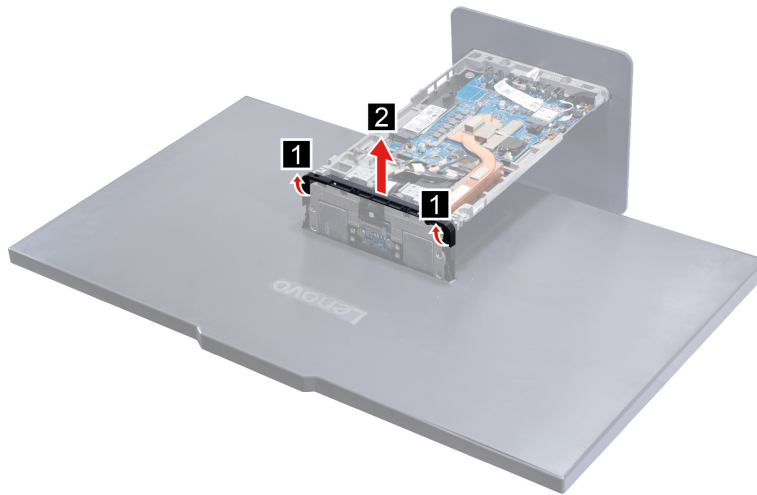

Step 3. Install the hinge cover (front) and other removed parts in reverse order.

---

## System board

Before you start, read “Prerequisites for hardware replacement” on page 46.

### Important notice for handling the system board

Some components mounted on a system board are very sensitive. Improper handling of a system board can cause damage to those components, and may cause a system malfunction. When handling a system board, follow these precautions:

- Do not drop, bend, or apply any excessive force to the system board.
- Avoid rough handling of any kind.

### Replacement steps

Step 1. Remove the following parts, if any, in order.

- “Power cord and ac power adapter” on page 49

- “Rear cover” on page 50.
- “System board shielding” on page 51
- “M.2 solid-state drive and thermal pad” on page 52
- “Duet clip” on page 52
- “Coin-cell battery and rubber” on page 53
- “Wi-Fi card and Wi-Fi card cover” on page 54
- “Thermal module” on page 58

Step 2. Record the cable routing and cable connections, and then disconnect all cables from the system board. See “System board illustration” on page 47.

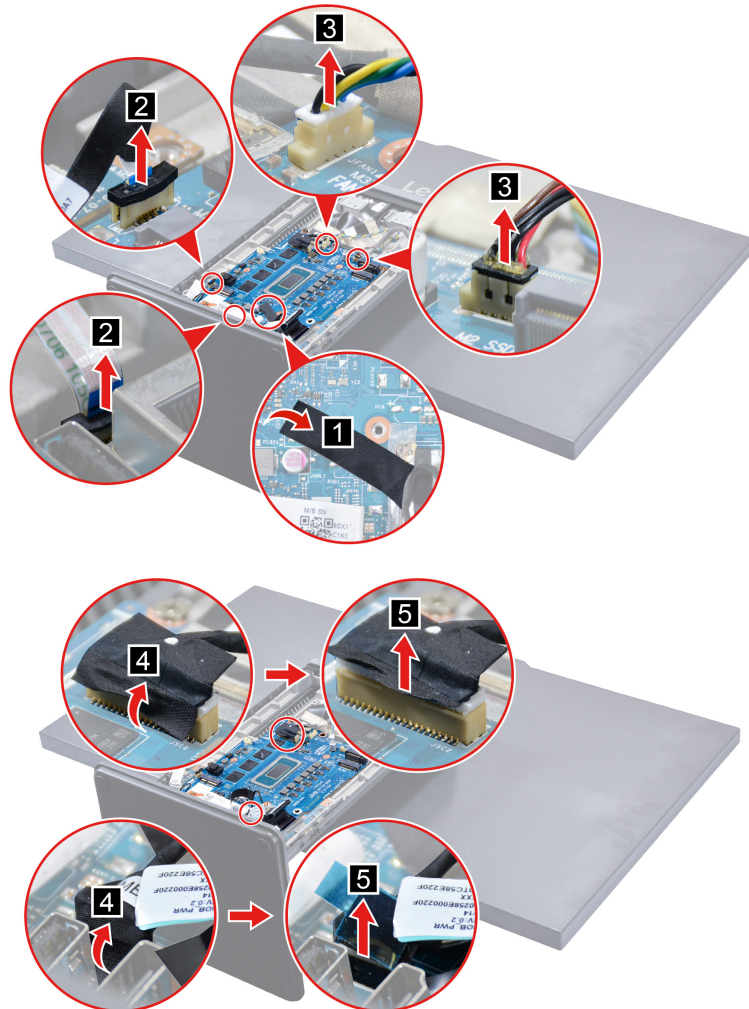

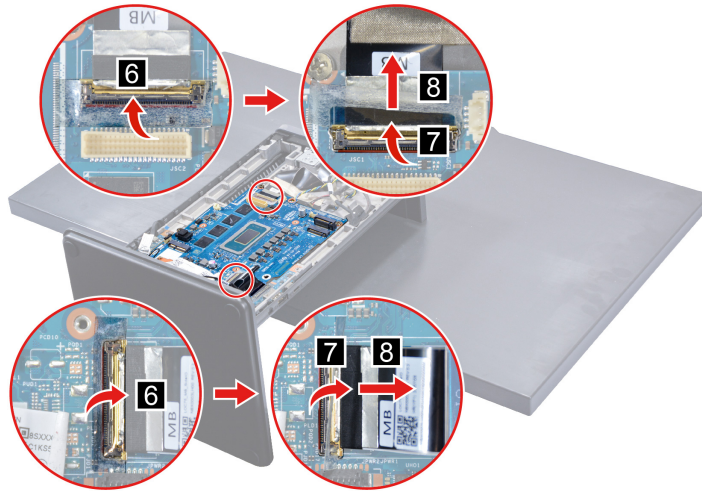

Step 3. Remove five screws and gently lift the system board.

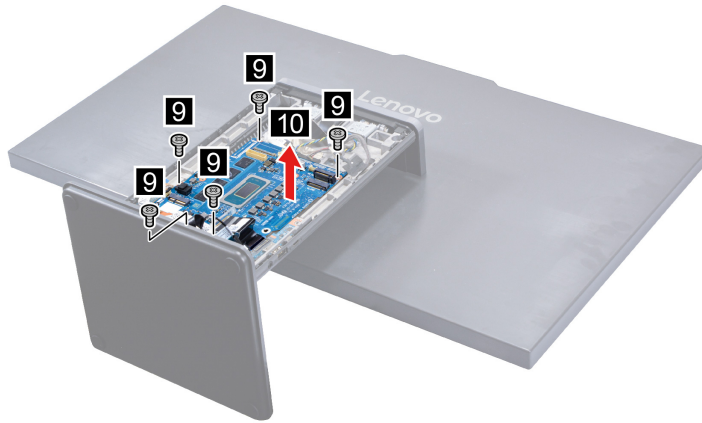

Location	Thread (mm)	Length (mm)	Torque (kgf. cm)	Color	Quantity
9	M3	L4	3.22 ± 0.22	Black	5

Step 4. Remove old TIMs and apply new TIMs following the instructions in “Handling thermal interface materials” on page 48.

Step 5. Install the system board, reconnect all cables to the system board firmly, and reinstall other removed parts in reverse order.

### After replacement

Each computer has its unique SMBIOS (system management BIOS) data stored in the nonvolatile memory on the system board. This information is essential for using or servicing the computer. After you replace the system board, the original SMBIOS data such as the MTM, SN, and brand ID (product name) should be written back into the new system board.

- For service technicians, use the Golden Key U1 tool to write back the product information. Refer to <https://support.lenovo.com/solutions/ht102004> for instructions.

**Note:** In addition to write the product information, ensure that the latest UEFI BIOS is loaded to the system board before you complete the service action.

- For end users, download and install the latest BIOS package from Lenovo Support Web site to write back the product information. For the MTM and SN information of the product, see “Find the serial number” on page 38.

**CAUTION:**

**Take extreme caution when entering the product information. Once written to the system board, the data becomes unalterable. If you are uncertain about any step, consult Lenovo Service before proceeding.**

---

## Stand assembly

Before you start, read “Prerequisites for hardware replacement” on page 46.

### Replacement steps

Step 1. Remove the following parts, in order.

- “Power cord and ac power adapter” on page 49
- “Hinge cover (top)” on page 50
- “Rear cover” on page 50.
- “System board shielding” on page 51
- “M.2 solid-state drive and thermal pad” on page 52
- “Duet clip” on page 52
- “Coin-cell battery and rubber” on page 53
- “Wi-Fi card and Wi-Fi card cover” on page 54
- “Power switch board and power switch board FFC” on page 55
- “Side I/O board, side I/O board cable, and side I/O board FFC” on page 57
- “Thermal module” on page 58
- “Front cover” on page 59
- “Cover cap (left and right)” on page 60
- “Hinge cover (front)” on page 61
- “System board” on page 61

Step 2. Remove four screws and then remove the stand assembly.

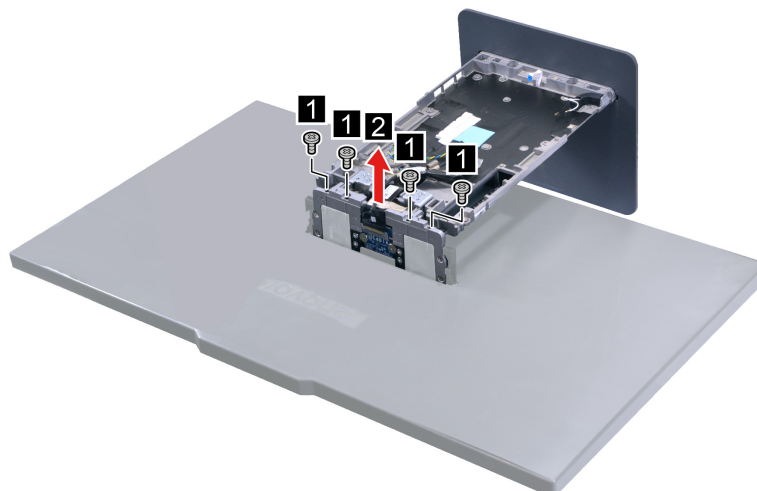

Location	Thread (mm)	Length (mm)	Torque (kgf. cm)	Color	Quantity
2	M4	L20	12 ± 0.25	Black	4

Step 3. Install the stand assembly and other removed parts in reverse order.

## Speaker

Before you start, read “Prerequisites for hardware replacement” on page 46.

### Replacement steps

Step 1. Remove the following parts, if any, in order.

- “Power cord and ac power adapter” on page 49
- “Hinge cover (top)” on page 50
- “Rear cover” on page 50.
- “System board shielding” on page 51
- “M.2 solid-state drive and thermal pad” on page 52
- “Duet clip” on page 52
- “Coin-cell battery and rubber” on page 53
- “Wi-Fi card and Wi-Fi card cover” on page 54
- “Power switch board and power switch board FFC” on page 55
- “Side I/O board, side I/O board cable, and side I/O board FFC” on page 57
- “Thermal module” on page 58
- “Front cover” on page 59
- “Cover cap (left and right)” on page 60
- “Hinge cover (front)” on page 61
- “System board” on page 61
- “Stand assembly” on page 64

Step 2. Locate the speaker connector based on the “System board illustration” on page 47.

Step 3. Remove three screws and then remove the speaker.

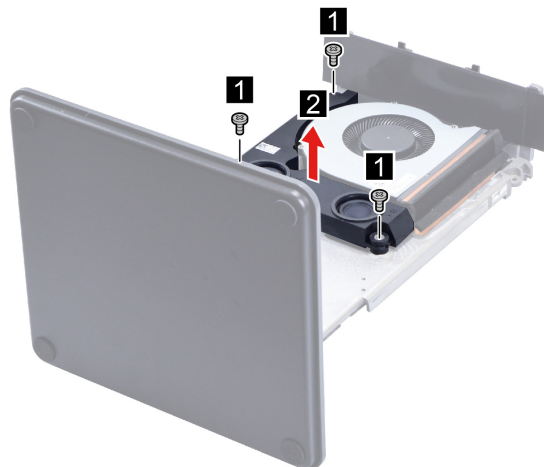

Location	Thread (mm)	Length (mm)	Torque (kgf. cm)	Color	Quantity
<b>1</b>	M3	L4	3.22 ± 0.22	Black	3

Step 4. Install the speaker and other removed parts in reverse order.

## Thermal fan and bracket

Before you start, read “Prerequisites for hardware replacement” on page 46.

### Replacement steps

Step 1. Remove the following parts, if any, in order.

- “Power cord and ac power adapter” on page 49
- “Hinge cover (top)” on page 50
- “Rear cover” on page 50.
- “System board shielding” on page 51
- “M.2 solid-state drive and thermal pad” on page 52
- “Duet clip” on page 52
- “Coin-cell battery and rubber” on page 53
- “Wi-Fi card and Wi-Fi card cover” on page 54
- “Power switch board and power switch board FFC” on page 55
- “Side I/O board, side I/O board cable, and side I/O board FFC” on page 57
- “Thermal module” on page 58
- “Front cover” on page 59
- “Cover cap (left and right)” on page 60
- “Hinge cover (front)” on page 61
- “System board” on page 61
- “Stand assembly” on page 64

Step 2. Locate the thermal fan connector based on the “System board illustration” on page 47.

Step 3. Remove the thermal fan and bracket.

1. Remove three screws and then remove the thermal fan.

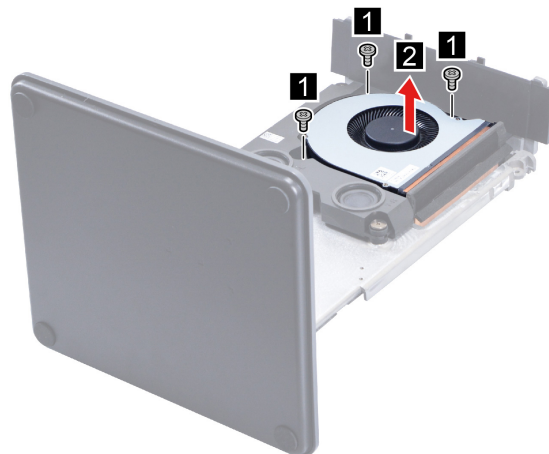

Location	Thread (mm)	Length (mm)	Torque (kgf. cm)	Color	Quantity
<b>1</b>	M3	L4	3.22 ± 0.22	Black	3

2. Remove two screws and then remove the thermal fan bracket.

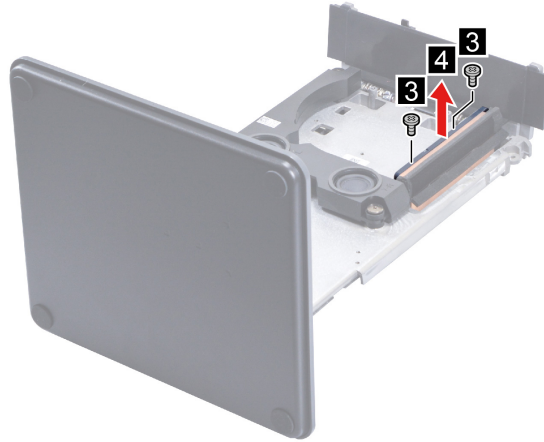

Location	Thread (mm)	Length (mm)	Torque (kgf. cm)	Color	Quantity
<b>3</b>	M3	L4	3.22 ± 0.22	Black	2

Step 4. Install the thermal fan, thermal fan bracket, and other removed parts in reverse order.

## Golden finger board, golden finger board cable, and golden finger board FCC

Before you start, read “Prerequisites for hardware replacement” on page 46.

### Replacement steps

Step 1. Remove the following parts, if any, in order.

- “Power cord and ac power adapter” on page 49
- “Hinge cover (top)” on page 50
- “Rear cover” on page 50.
- “System board shielding” on page 51
- “M.2 solid-state drive and thermal pad” on page 52
- “Duet clip” on page 52
- “Coin-cell battery and rubber” on page 53
- “Wi-Fi card and Wi-Fi card cover” on page 54
- “Power switch board and power switch board FFC” on page 55
- “Side I/O board, side I/O board cable, and side I/O board FFC” on page 57
- “Thermal module” on page 58
- “Front cover” on page 59
- “Cover cap (left and right)” on page 60
- “Hinge cover (front)” on page 61

- “System board” on page 61
- “Stand assembly” on page 64

Step 2. Remove the golden finger board, golden finger board cable, and golden finger board FCC.

1. Remove two screws, and then remove the golden finger board from the stand assembly.

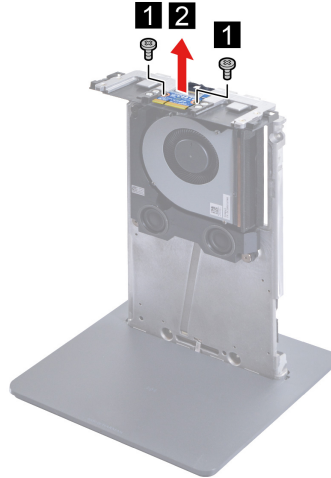

Location	Thread (mm)	Length (mm)	Torque (kgf. cm)	Color	Quantity
<b>1</b>	M2.5	L3	3.22 ± 0.22	White	2

2. Remove the golden finger board cable.

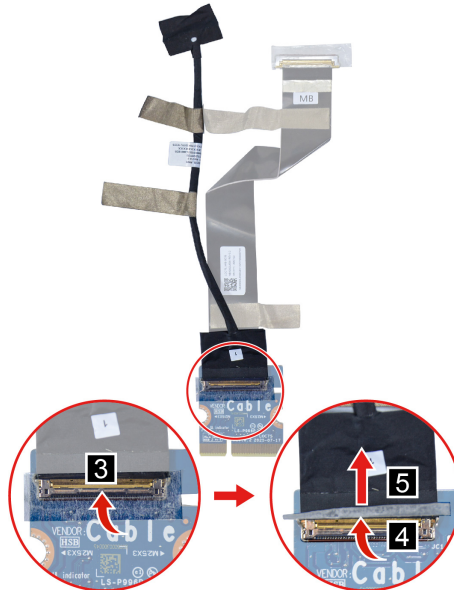

3. Remove the golden finger board FCC.

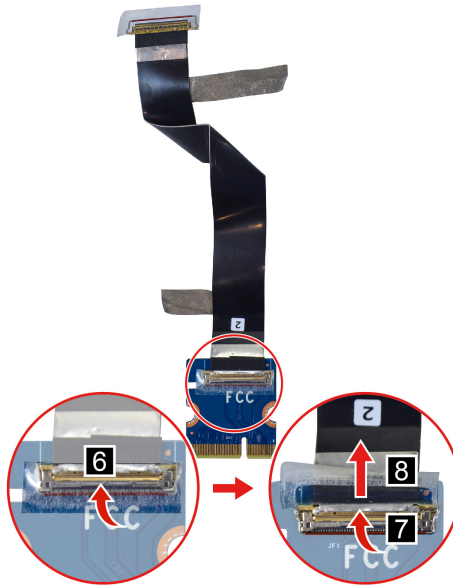

Step 3. Install the golden finger board, golden finger board cable, golden finger board FCC, and other removed parts in reverse order.

---

## LCD cover

Before you start, read “Prerequisites for hardware replacement” on page 46.

### Replacement steps

Step 1. Remove the following parts, if any, in order.

- “Power cord and ac power adapter” on page 49
- “Hinge cover (top)” on page 50
- “Rear cover” on page 50.
- “System board shielding” on page 51
- “M.2 solid-state drive and thermal pad” on page 52
- “Duet clip” on page 52
- “Coin-cell battery and rubber” on page 53
- “Wi-Fi card and Wi-Fi card cover” on page 54
- “Power switch board and power switch board FFC” on page 55
- “Side I/O board, side I/O board cable, and side I/O board FFC” on page 57
- “Thermal module” on page 58
- “Front cover” on page 59
- “Cover cap (left and right)” on page 60
- “Hinge cover (front)” on page 61
- “System board” on page 61
- “Stand assembly” on page 64

Step 2. Use the suction cup tool to remove the LCD cover.

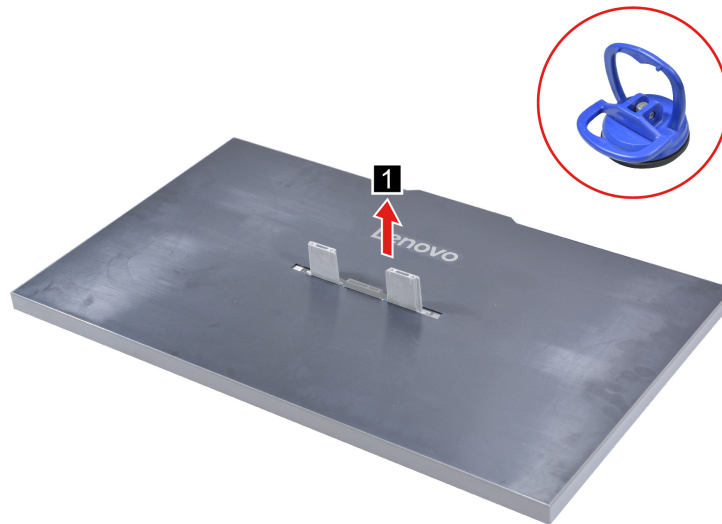

Step 3. Install the LCD cover and other removed parts in reverse order.

---

## Touch cable (for selected models)

Before you start, read “Prerequisites for hardware replacement” on page 46.

### Replacement steps

Step 1. Remove the following parts, if any, in order.

- “Power cord and ac power adapter” on page 49
- “Hinge cover (top)” on page 50
- “Rear cover” on page 50.
- “System board shielding” on page 51
- “M.2 solid-state drive and thermal pad” on page 52
- “Duet clip” on page 52
- “Coin-cell battery and rubber” on page 53
- “Wi-Fi card and Wi-Fi card cover” on page 54
- “Power switch board and power switch board FFC” on page 55
- “Side I/O board, side I/O board cable, and side I/O board FFC” on page 57
- “Thermal module” on page 58
- “Front cover” on page 59
- “Cover cap (left and right)” on page 60
- “Hinge cover (front)” on page 61
- “System board” on page 61
- “Stand assembly” on page 64
- “LCD cover” on page 69

Step 2. Remove the touch cable.

1. Peel off the tapes.

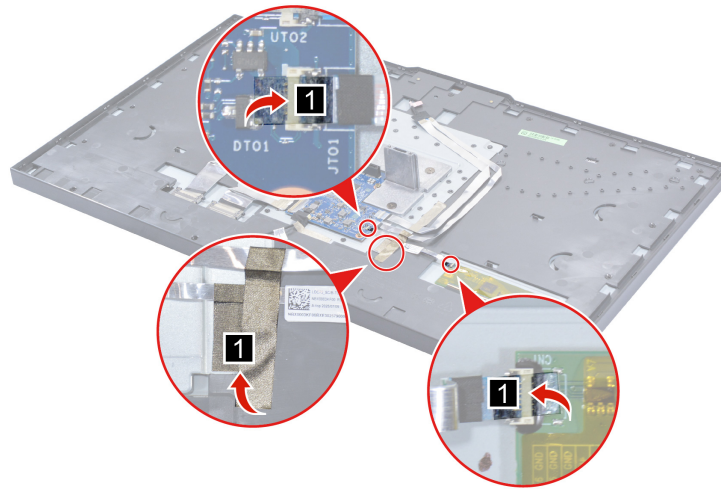

2. Remove the touch cable.

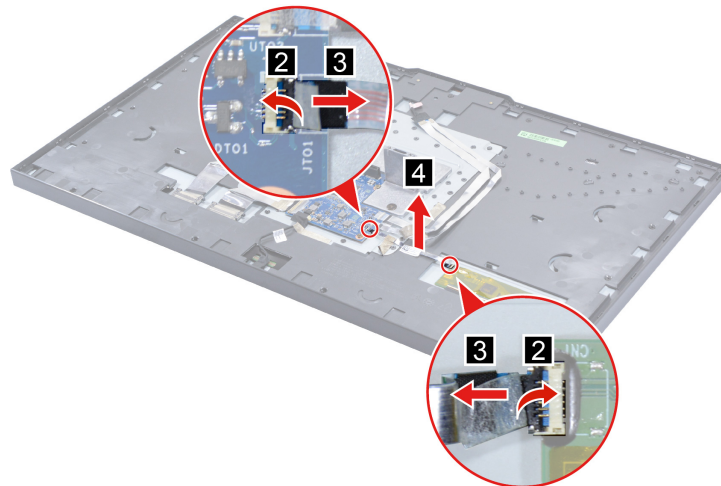

Step 3. Install the touch cable and other removed parts in reverse order.

---

## Backlight cable

Before you start, read “Prerequisites for hardware replacement” on page 46.

### Replacement steps

Step 1. Remove the following parts, if any, in order.

- “Power cord and ac power adapter” on page 49
- “Hinge cover (top)” on page 50
- “Rear cover” on page 50.
- “System board shielding” on page 51
- “M.2 solid-state drive and thermal pad” on page 52
- “Duet clip” on page 52
- “Coin-cell battery and rubber” on page 53
- “Wi-Fi card and Wi-Fi card cover” on page 54
- “Power switch board and power switch board FFC” on page 55

- “Side I/O board, side I/O board cable, and side I/O board FFC” on page 57
- “Thermal module” on page 58
- “Front cover” on page 59
- “Cover cap (left and right)” on page 60
- “Hinge cover (front)” on page 61
- “System board” on page 61
- “Stand assembly” on page 64
- “LCD cover” on page 69

Step 2. Remove the backlight cable.

1. Peel off the tapes.

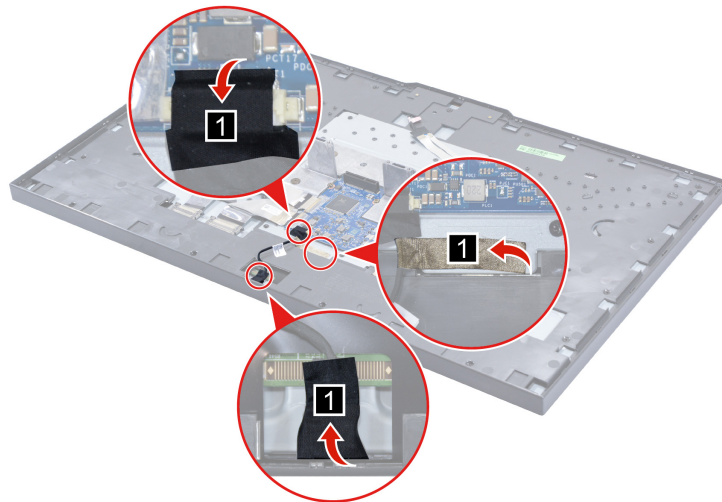

2. Remove the backlight cable.

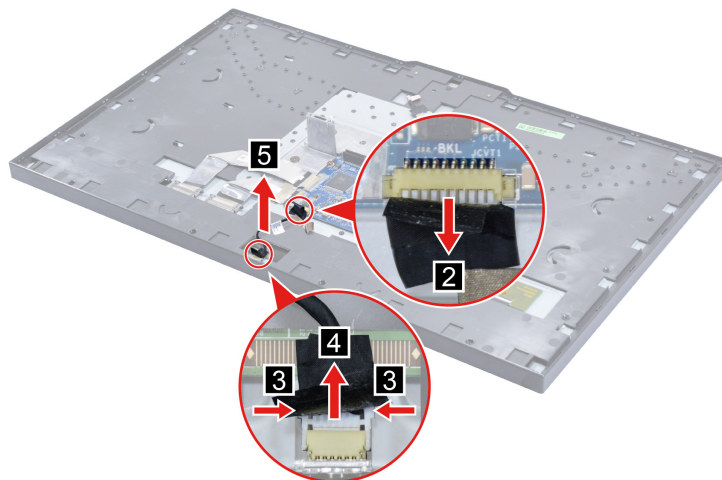

Step 3. Install the backlight cable and other removed parts in reverse order.

---

## Scalar board

Before you start, read “Prerequisites for hardware replacement” on page 46.

## Replacement steps

Step 1. Remove the following parts, if any, in order.

- “Power cord and ac power adapter” on page 49
- “Hinge cover (top)” on page 50
- “Rear cover” on page 50.
- “System board shielding” on page 51
- “M.2 solid-state drive and thermal pad” on page 52
- “Duet clip” on page 52
- “Coin-cell battery and rubber” on page 53
- “Wi-Fi card and Wi-Fi card cover” on page 54
- “Power switch board and power switch board FFC” on page 55
- “Side I/O board, side I/O board cable, and side I/O board FFC” on page 57
- “Thermal module” on page 58
- “Front cover” on page 59
- “Cover cap (left and right)” on page 60
- “Hinge cover (front)” on page 61
- “System board” on page 61
- “Stand assembly” on page 64
- “LCD cover” on page 69

Step 2. Locate the scalar board as shown in the figure below, and refer to “Scalar board illustration” on page 48 for connector locations.

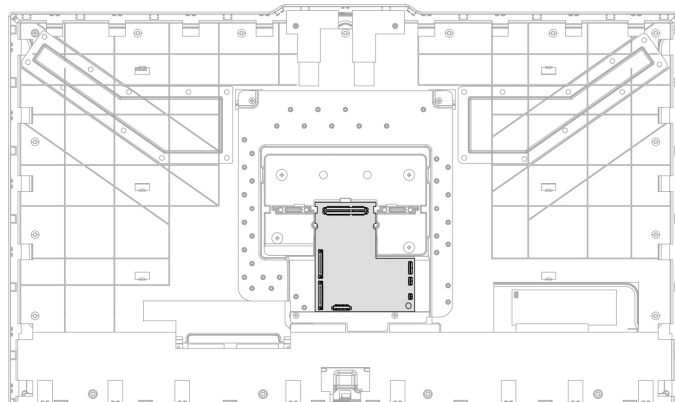

Step 3. Remove the scalar board.

1. Peel off the tapes.

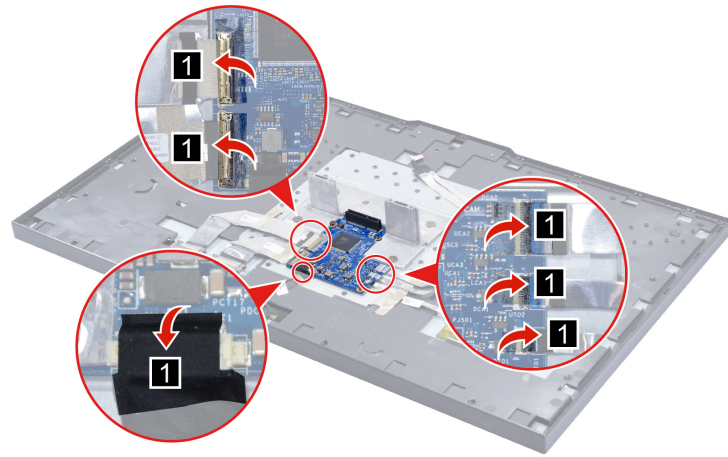

2. Disconnect all cables connected to the scalar board.

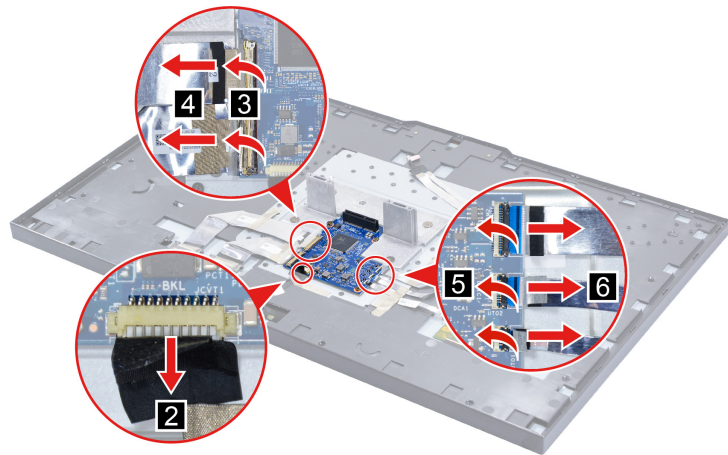

3. Remove three screws and then remove the scalar board.

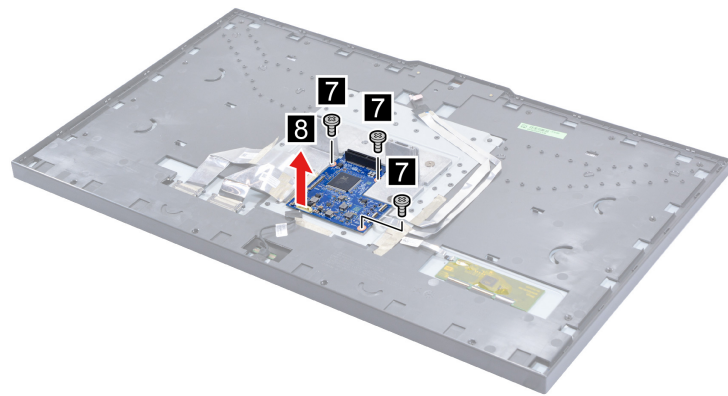

Location	Thread (mm)	Length (mm)	Torque (kgf. cm)	Color	Quantity
<b>7</b>	M3	L3.6	3.22 ± 0.22	Black	3

Step 4. Install the scalar board and other removed parts in reverse order.

---

## LCD frame assembly

Before you start, read “Prerequisites for hardware replacement” on page 46.

**Note:** The appearance of the LCD panel may differ by model.

### Replacement steps

Step 1. Remove the following parts, if any, in order.

- “Power cord and ac power adapter” on page 49
- “Hinge cover (top)” on page 50
- “Rear cover” on page 50.
- “System board shielding” on page 51
- “M.2 solid-state drive and thermal pad” on page 52
- “Duet clip” on page 52
- “Coin-cell battery and rubber” on page 53
- “Wi-Fi card and Wi-Fi card cover” on page 54
- “Power switch board and power switch board FFC” on page 55
- “Side I/O board, side I/O board cable, and side I/O board FFC” on page 57
- “Thermal module” on page 58
- “Front cover” on page 59
- “Cover cap (left and right)” on page 60
- “Hinge cover (front)” on page 61
- “System board” on page 61
- “Stand assembly” on page 64
- “LCD cover” on page 69
- “Scalar board” on page 72

Step 2. Remove seventeen screws and then remove the LCD frame assembly.

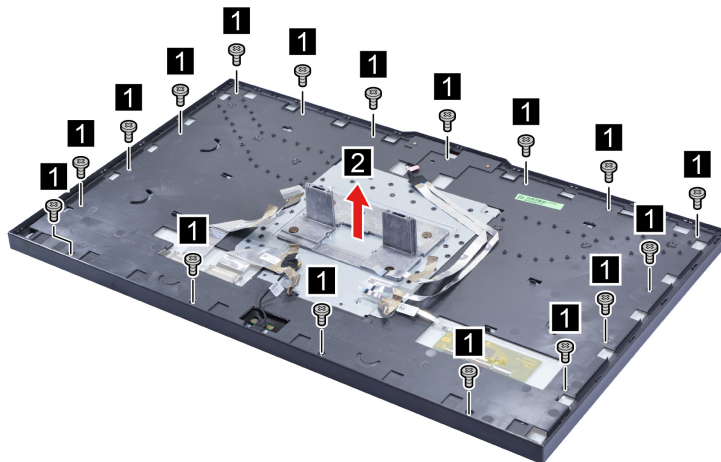

Location	Thread (mm)	Length (mm)	Torque (kgf. cm)	Color	Quantity
<b>1</b>	M3	L3.6	3.22 ± 0.22	Black	17

Step 3. Install the LCD frame assembly and other removed parts in reverse order.

## Camera assembly

Before you start, read “Prerequisites for hardware replacement” on page 46.

### Replacement steps

Step 1. Remove the following parts, if any, in order.

- “Power cord and ac power adapter” on page 49
- “Hinge cover (top)” on page 50
- “Rear cover” on page 50.
- “System board shielding” on page 51
- “M.2 solid-state drive and thermal pad” on page 52
- “Duet clip” on page 52
- “Coin-cell battery and rubber” on page 53
- “Wi-Fi card and Wi-Fi card cover” on page 54
- “Power switch board and power switch board FFC” on page 55
- “Side I/O board, side I/O board cable, and side I/O board FFC” on page 57
- “Thermal module” on page 58
- “Front cover” on page 59
- “Cover cap (left and right)” on page 60
- “Hinge cover (front)” on page 61
- “System board” on page 61
- “Stand assembly” on page 64
- “LCD cover” on page 69
- “Scalar board” on page 72
- “LCD frame assembly” on page 75

Step 2. Remove two screws and then remove the camera assembly.

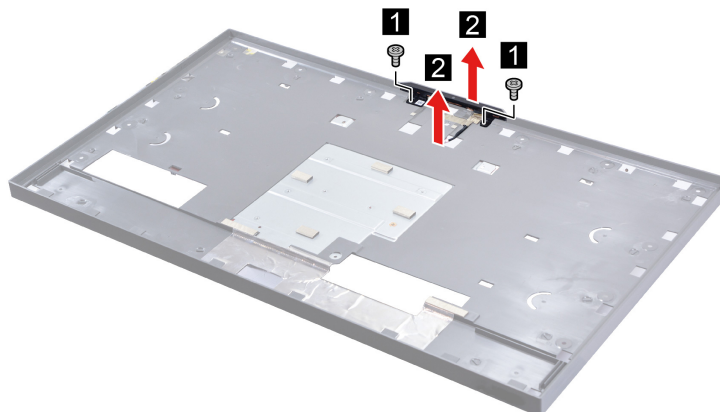

Location	Thread (mm)	Length (mm)	Torque (kgf. cm)	Color	Quantity
<b>1</b>	M2	L2.5	2 ± 0.25	Black	2

Step 3. Install the camera assembly and other removed parts in reverse order.

---

## LVDS cable 1

Before you start, read “Prerequisites for hardware replacement” on page 46.

### Replacement steps

Step 1. Remove the following parts, if any, in order.

- “Power cord and ac power adapter” on page 49
- “Hinge cover (top)” on page 50
- “Rear cover” on page 50.
- “System board shielding” on page 51
- “M.2 solid-state drive and thermal pad” on page 52
- “Duet clip” on page 52
- “Coin-cell battery and rubber” on page 53
- “Wi-Fi card and Wi-Fi card cover” on page 54
- “Power switch board and power switch board FFC” on page 55
- “Side I/O board, side I/O board cable, and side I/O board FFC” on page 57
- “Thermal module” on page 58
- “Front cover” on page 59
- “Cover cap (left and right)” on page 60
- “Hinge cover (front)” on page 61
- “System board” on page 61
- “Stand assembly” on page 64
- “LCD cover” on page 69
- “Scalar board” on page 72
- “LCD frame assembly” on page 75

Step 2. Remove the LVDS cable 1.

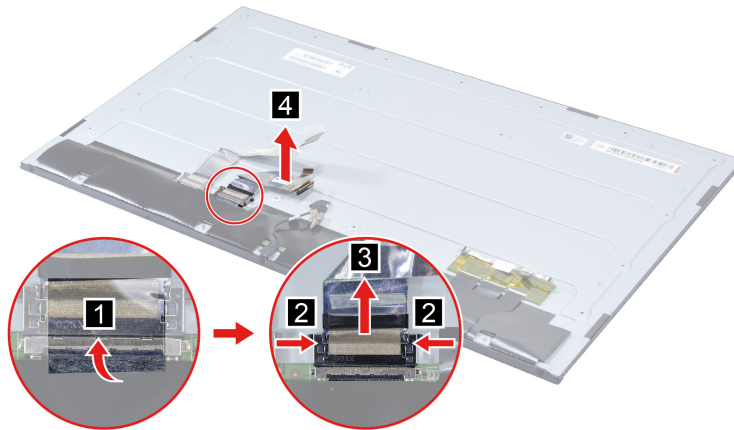

Step 3. Install the LVDS cable 1 and other removed parts in reverse order.

---

## LVDS cable 2

Before you start, read “Prerequisites for hardware replacement” on page 46.

### Replacement steps

Step 1. Remove the following parts, if any, in order.

- “Power cord and ac power adapter” on page 49
- “Hinge cover (top)” on page 50
- “Rear cover” on page 50.
- “System board shielding” on page 51
- “M.2 solid-state drive and thermal pad” on page 52
- “Duet clip” on page 52
- “Coin-cell battery and rubber” on page 53
- “Wi-Fi card and Wi-Fi card cover” on page 54
- “Power switch board and power switch board FFC” on page 55
- “Side I/O board, side I/O board cable, and side I/O board FFC” on page 57
- “Thermal module” on page 58
- “Front cover” on page 59
- “Cover cap (left and right)” on page 60
- “Hinge cover (front)” on page 61
- “System board” on page 61
- “Stand assembly” on page 64
- “LCD cover” on page 69
- “Scalar board” on page 72
- “LCD frame assembly” on page 75

Step 2. Remove the LVDS cable 2.

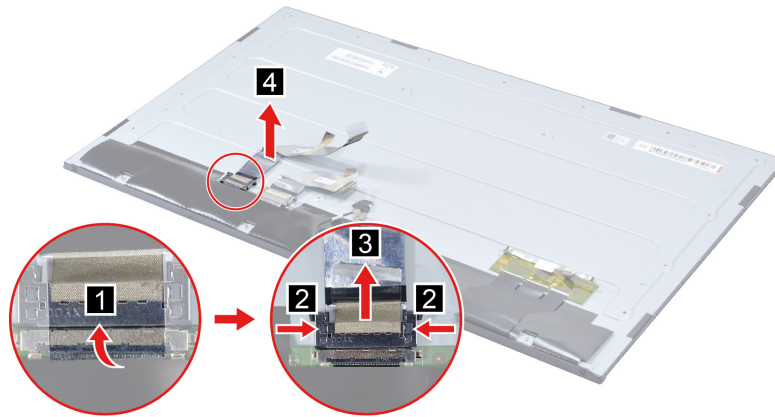

Step 3. Install the LVDS cable 2 and other removed parts in reverse order.

---

## LCD panel bezel

Before you start, read “Prerequisites for hardware replacement” on page 46.

### Replacement steps

Step 1. Remove the following parts, if any, in order.

- “Power cord and ac power adapter” on page 49
- “Hinge cover (top)” on page 50
- “Rear cover” on page 50.
- “System board shielding” on page 51
- “M.2 solid-state drive and thermal pad” on page 52
- “Duet clip” on page 52
- “Coin-cell battery and rubber” on page 53
- “Wi-Fi card and Wi-Fi card cover” on page 54
- “Power switch board and power switch board FFC” on page 55
- “Side I/O board, side I/O board cable, and side I/O board FFC” on page 57
- “Thermal module” on page 58
- “Front cover” on page 59
- “Cover cap (left and right)” on page 60
- “Hinge cover (front)” on page 61
- “System board” on page 61
- “Stand assembly” on page 64
- “LCD cover” on page 69
- “Scalar board” on page 72
- “LCD frame assembly” on page 75

Step 2. Remove two screws and then remove the LCD panel bezel.

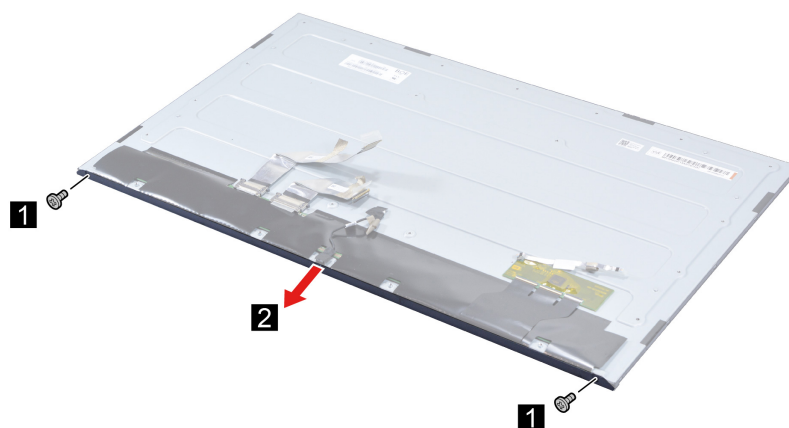

Location	Thread (mm)	Length (mm)	Torque (kgf. cm)	Color	Quantity
<b>1</b>	M2	L2.5	2 ± 0.25	Black	2

Step 3. Install the LCD panel bezel and other removed parts in reverse order.

## LCD panel

Before you start, read “Prerequisites for hardware replacement” on page 46.

### Replacement steps

Step 1. Remove the following parts, if any, in order.

- “Power cord and ac power adapter” on page 49
- “Hinge cover (top)” on page 50
- “Rear cover” on page 50.
- “System board shielding” on page 51
- “M.2 solid-state drive and thermal pad” on page 52
- “Duet clip” on page 52
- “Coin-cell battery and rubber” on page 53
- “Wi-Fi card and Wi-Fi card cover” on page 54
- “Power switch board and power switch board FFC” on page 55
- “Side I/O board, side I/O board cable, and side I/O board FFC” on page 57
- “Thermal module” on page 58
- “Front cover” on page 59
- “Cover cap (left and right)” on page 60
- “Hinge cover (front)” on page 61
- “System board” on page 61
- “Stand assembly” on page 64
- “LCD cover” on page 69
- “Touch cable (for selected models)” on page 70
- “Backlight cable” on page 71
- “Scalar board” on page 72

- “LCD frame assembly” on page 75
- “LVDS cable 1” on page 77
- “LVDS cable 2” on page 78
- “LCD panel bezel” on page 79

Step 2. You can get the LCD panel after removing the FRUs (CRUs) above.



Step 3. Install the LCD panel and reinstall other removed parts in reverse order.

---

## Appendix A. Important notice for Quebec consumers

In regard to section 79.18 of Quebec's Regulation respecting the application of the Consumer Protection Act, Lenovo in no way guarantees the availability of (a) replacement parts; (b) repair services; and (c) information necessary to maintain or repair the goods. For up-to-date information on the technical support and parts available for your purchase, please consult <https://support.lenovo.com/ca/en>.

En ce qui concerne l'article 79.18 du Règlement d'application de la Loi sur la protection du consommateur du Québec, Lenovo ne garantit en aucune façon la disponibilité des éléments suivants : (a) les pièces de rechange; (b) les services de réparation; et (c) les renseignements nécessaires à l'entretien à la réparation du bien. Pour obtenir des renseignements à jour sur le soutien technique et les pièces disponibles pour votre achat, veuillez consulter <https://support.lenovo.com/ca/fr>.

---

## Appendix B. Self-help resource

Find more information about your device through the following self-help resources.

### Product information

- Product specifications: <https://psref.lenovo.com>
- Technical specifications for Lenovo workstations: <https://thinkstation-specs.com>

### Lenovo Support resource

- Lenovo PC Technical Support web site: <https://pcsupport.lenovo.com>. You can obtain the following information and resources:
  - Drivers and software
  - Troubleshoot and diagnose
  - How to's
  - Guides and manuals
  - Warranty lookup
  - Parts lookup
  - Accessories
  - Contact us
  - Repair status check
  - Imaging and security resources
  - Glossary
- Lenovo Support phone numbers: <https://pcsupport.lenovo.com/supportphonenumber>
- Vantage app: Type **vantage** in the Windows search box. You can use the app to:
  - Configure device settings
  - Download and install UEFI BIOS, drivers, and firmware updates
  - Secure your device from outside threats
  - Diagnose hardware problems
  - Check the warranty status of your device
  - Access *User Guide* and helpful articles
- Lenovo communities:
  - Forums: <https://forums.lenovo.com>
  - Legion Gaming Community: <https://gaming.lenovo.com>
  - Lenovo EDU Community: <https://education.lenovo.com>
  - Lenovo Pro Community: <https://smbcommunity.lenovo.com>
- Troubleshooting tips: <https://www.lenovo.com/tips>

### Service information

- Warranty lookup: <https://support.lenovo.com/warranty-lookup>. You can check the warranty status of your device.

- Repair status check: <https://support.lenovo.com/track-repair-status>. You can check the repair status of your device by repair ticket, serial number, or IMEI number.
- Parts lookup and purchase: <https://support.lenovo.com/parts-lookup>. You can find service parts by serial number or machine type.
- Lenovo BIOS Simulation Center: <https://download.lenovo.com/bsco/index.html>. You can explore the BIOS settings of your device.
- Additional services purchase: <https://pcsupport.lenovo.com/warrantyupgrade>. You can protect your device with extended warranty, Accidental Damage Protection, Premium Care & Support, and Vantage Smart Performance.

## Product documentation

Documentation title	Information included	How to Access
<i>Setup Guide</i>	Initial setup and overview information	<ul style="list-style-type: none"> <li>• Access the printed version from the product package.</li> <li>• Go to <a href="https://pcsupport.lenovo.com">https://pcsupport.lenovo.com</a> and search by the product name or serial number. Then, click <b>Guides &amp; Manuals</b>.</li> </ul>
<i>User Guide</i>	Instructions, guidance, resources, and contact information	<ul style="list-style-type: none"> <li>• Scan the QR code in <i>Setup Guide</i>.</li> <li>• In Windows Start menu, click <b>User Guide</b> .</li> <li>• Type <b>vantage</b> in the Windows search box and press Enter. Then, find the <i>User Guide</i> in the app.</li> <li>• Go to <a href="https://pcsupport.lenovo.com">https://pcsupport.lenovo.com</a> and search by the product name or serial number. Then, click <b>Guides &amp; Manuals</b>.</li> </ul>
<i>Hardware Maintenance Manual</i>	Hardware diagnostic and replacement information for technicians	Go to <a href="https://pcsupport.lenovo.com">https://pcsupport.lenovo.com</a> and Search by the product name or serial number. Then, click <b>Guides &amp; Manuals</b> .

## Operating system support resource

- Windows help information
  - Type **get help** in the Windows search box
  - Use Windows Search
  - Microsoft Support Web site: <https://support.microsoft.com>
- Reset or restore Windows
  - Use Lenovo recovery options: <https://support.lenovo.com/HowToCreateLenovoRecovery>
  - Use Windows recovery options: Go to <https://pcsupport.lenovo.com> and search by the product name or serial number. Then, navigate to the troubleshooting menu to diagnose the operating system for recovery instructions.

## Accessory information

- Purchase accessories: <https://www.lenovo.com/accessories>
- Service recommendation and accessory configurator: <https://smartfind.lenovo.com>
- Accessories and option compatibility matrix: <https://www.lenovo.com/accessoriesguide>

## Legal and compliance information

- Product compliance: <https://www.lenovo.com/compliance>
- Legal information: <https://www.lenovo.com/us/en/legal>

- Regulatory documentation: Go to <https://pcsupport.lenovo.com> and search by the product name or serial number. Then, click **Guides & Manuals**.
  - *Safety and Warranty Guide*: Safety, warranty, recycling, and other information
  - *Generic Safety and Compliance Notices*: Compliance, accessibility, RoHS, and other information
  - *Regulatory Notice*: Regulatory notices for wireless modules

### **Lenovo responsibility**

- Accessibility information: <https://www.lenovo.com/accessibility>
- Environment information: <https://www.lenovo.com/us/en/sustainability-operational-impact>
- Product security: <https://www.lenovo.com/us/en/product-security/landing/>

---

## Appendix C. Notices and trademarks

### Notices

Lenovo may not offer the products, services, or features discussed in this document in all countries. Consult your local Lenovo representative for information on the products and services currently available in your area. Any reference to a Lenovo product, program, or service is not intended to state or imply that only that Lenovo product, program, or service may be used. Any functionally equivalent product, program, or service that does not infringe any Lenovo intellectual property right may be used instead. However, it is the user's responsibility to evaluate and verify the operation of any other product, program, or service.

Lenovo may have patents or pending patent programs covering subject matter described in this document. The furnishing of this document does not give you any license to these patents. You can send license inquiries, in writing, to:

*Lenovo (United States), Inc.  
8001 Development Drive  
Morrisville, NC 27560  
U.S.A.  
Attention: Lenovo Director of Licensing*

LENOVO PROVIDES THIS PUBLICATION "AS IS" WITHOUT WARRANTY OF ANY KIND, EITHER EXPRESS OR IMPLIED, INCLUDING, BUT NOT LIMITED TO, THE IMPLIED WARRANTIES OF NON-INFRINGEMENT, MERCHANTABILITY OR FITNESS FOR A PARTICULAR PURPOSE. Some jurisdictions do not allow disclaimer of express or implied warranties in certain transactions, therefore, this statement may not apply to you.

Changes are made periodically to the information herein; these changes will be incorporated in new editions of the publication. To provide better service, Lenovo reserves the right to improve and/or modify the products and software programs described in the manuals included with your computer, and the content of the manual, at any time without additional notice.

The software interface and function and hardware configuration described in the manuals included with your computer might not match exactly the actual configuration of the computer that you purchase. For the configuration of the product, refer to the related contract (if any) or product packing list, or consult the distributor for the product sales. Lenovo may use or distribute any of the information you supply in any way it believes appropriate without incurring any obligation to you.

The products described in this document are not intended for use in implantation or other life support applications where malfunction may result in injury or death to persons. The information contained in this document does not affect or change Lenovo product specifications or warranties. Nothing in this document shall operate as an express or implied license or indemnity under the intellectual property rights of Lenovo or third parties. All information contained in this document was obtained in specific environments and is presented as an illustration. The result obtained in other operating environments may vary.

Lenovo may use or distribute any of the information you supply in any way it believes appropriate without incurring any obligation to you.

Any references in this publication to non-Lenovo Web sites are provided for convenience only and do not in any manner serve as an endorsement of those Web sites. The materials at those Web sites are not part of the materials for this Lenovo product, and use of those Web sites is at your own risk.

Any performance data contained herein was determined in a controlled environment. Therefore, the result obtained in other operating environments may vary significantly. Some measurements may have been made on development-level systems and there is no guarantee that these measurements will be the same on generally available systems. Furthermore, some measurements may have been estimated through extrapolation. Actual results may vary. Users of this document should verify the applicable data for their specific environment.

This document is copyrighted by Lenovo and is not covered by any open source license, including any Linux® agreement(s) which may accompany software included with this product. Lenovo may update this document at any time without notice.

For the latest information or any questions or comments, contact or visit the Lenovo Web site:

<https://pcsupport.lenovo.com>

### **Trademarks**

Lenovo, the Lenovo logo, IdeaCentre, and IdeaCentre logo are trademarks of Lenovo. Linux is the registered trademark of Linus Torvalds in the U.S. and other countries. Microsoft and Windows are trademarks of the Microsoft group of companies. The terms HDMI and HDMI High-Definition Multimedia Interface are trademarks or registered trademarks of HDMI Licensing LLC in the United States and other countries. USB-C® is a registered trademark of USB Implementers Forum. Wi-Fi and Miracast are registered trademarks of Wi-Fi Alliance. All other trademarks are the property of their respective owners.

**Lenovo**