

**LX720-4K/LX720-4KE/LX720-4KB/
LX720-4KN/V724K**

**LX750-4K/LX750-4KN/LX750-4KE/
LX750-4KB/V754K**

Projector

User Guide 

IMPORTANT: Please read this User Guide to obtain important information on installing and using your product in a safe manner, as well as registering your product for future service. Warranty information contained in this User Guide will describe your limited coverage from ViewSonic® Corporation, which is also found on our web site at <http://www.viewsonic.com> in English, or in specific languages using the Regional selection box of our website.

Model Number : VS20621 | VS20764

Product Name : LX720-4K/LX720-4KE/LX720-4KB/
LX720-4KN/V724K | LX750-4K/LX750-
4KN/LX750-4KE/LX750-4KB/V754K

Thank you for choosing ViewSonic®

As a world-leading provider of visual solutions, ViewSonic® is dedicated to exceeding the world's expectations for technological evolution, innovation, and simplicity. At ViewSonic®, we believe that our products have the potential to make a positive impact in the world, and we are confident that the ViewSonic® product you have chosen will serve you well.

Once again, thank you for choosing ViewSonic®!

Safety Precautions

Read these instructions carefully, keep them in a safe place, and follow all warnings and instructions.

General Safety Precautions

- During normal operation, warm air and a slight odor may come from the ventilation.
- When using the projector, avoid direct exposure to the projector's exhaust vent.
- Keep the remote control or loose batteries away from children or pets.

Installation

- Follow the manufacturer's recommended installation guidelines to ensure safe and optimal operation.
- Leave at least 50 cm (20 in.) of open space around the projector to ensure proper ventilation.
- Place the projector in a well-ventilated area. Do not place anything on the projector that prevents heat dissipation.
- Do not place any heavy objects on the projector or cables.
- Do not place the projector in an unstable location. The projector may fall, resulting in injury or damage.
- Do not stand the projector upright. The projector may fall, resulting in injury or damage.
- Do not use the projector near open flames, sparks, or hot surfaces.
- Do not use the projector near water or in humid conditions and avoid exposing it to rain or moisture.
- Do not expose the projector to direct sunlight or other sources of sustained heat.
- Always route and manage cables connected to your projector to prevent tripping, pulling, or grabbing.
- The projector is designed to operate at 120/240V AC. Unstable voltages can harm the projector. Use a power stabilizer, surge protector, or UPS in areas with frequent power cuts or surges.

Power Cord Safety

- Do not compress the power cord, particularly at the plug and at the point where it connects to the projector.
- Do not use the projector if the power cord or plug is damaged.
- The power cord is designed with a grounding prong to ensure safe operation. Do not remove or damage the grounding prong.
- Only use the original power cord and do not use damaged or modified cords.
- Unplug the projector when it will be unused for long periods of time.

Handling

- When moving the projector, handle it with care to avoid damage or injury.
- Only use attachments and accessories specifically designed and approved by the manufacturer to ensure compatibility and safety.

Troubleshooting

- If smoke appears, an abnormal noise, or a strange odor is present, immediately turn the projector off and contact your reseller or ViewSonic. It is dangerous to continue using the projector.
- Refer all servicing to qualified service personnel.
- Do not disassemble the projector. It contains electrical components that can cause shock.

Lens Safety

- When using the projector, avoid looking directly at the projector lens.
- Avoid blocking the projection lens when using the projector, as this can cause objects to overheat and potentially ignite.
- When using the projector, make sure the lens shutter is open and the lens cap is removed.

Lamp Safety

- Unplug the projector before replacing the lamp assembly or component.
- Allow the projector to cool for approximately 45 minutes before replacing the lamp or performing basic maintenance.
- Lamps should be replaced at the recommended lifespan to avoid unexpected failure.

Ceiling Mounting

- Use a compatible ceiling mount kit and ensure secure installation for safe operation.
- Improper ceiling mount kits can lead to projector falls due to incorrect screw size or length.
- Ceiling mounting is recommended to place the projector above the eyes of children.

Caution

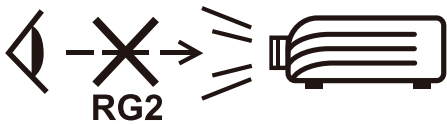

Possibly hazardous optical radiation is emitted from this product. As with any bright light source, do not stare into the beam, RG2 IEC 62471-5:2015.

Additional warning against eye exposure for close exposures less than 1 m (3.28 ft).

CLASS 1 CONSUMER LASER PRODUCT EN50689:2021

- a. Notice is given to supervise children and to never allow them to stare into the projector beam at any distance from the projector.
- b. Notice is given to use caution when using the remote control for starting the projector while in front of the projection lens.
- c. Notice is given to the user to avoid the use of optical aids such as binoculars or telescopes inside the beam.

Contents

Safety Precautions.....	3
Introduction	9
Package Contents	9
Projector	10
Overview	10
Keypad.....	11
Indicator Lights.....	11
I/O Ports	12
Remote Control	13
Overview	13
Receiver Range.....	16
Installing the Batteries	17
Pairing the Remote Control.....	18
Initial Setup.....	19
Positioning the Projector	19
Projection Dimensions.....	20
16:9 Image on a 16:9 Screen	20
Mounting the Projector	21
Protecting Against Unauthorized Access.....	22
Using the Security Bar	22
Using the Password Function	23
Locking the Keypad	25
Making Connections.....	26
Connecting to Power	26
Connecting to External Devices	27
Connecting to Bluetooth Devices	28
Screen Mirroring.....	29
Cast.....	29

Using the Projector.....	30
Turning the Projector On.....	30
Turning the Projector Off	30
Selecting an Input Source	31
Adjusting the Projected Image	32
Projection Angle	32
Image Size and Clarity	32
Correcting Keystone	33
Corner Adjustment.....	34
Menu Operation.....	35
Google TV Home Screen (Smart System)	35
On-Screen Display Menu	36
Menu Navigation	37
Menu Options.....	38
DISPLAY	38
IMAGE	40
POWER MANAGEMENT.....	42
BASIC	44
ADVANCED	46
SYSTEM.....	49
INFORMATION.....	50
Appendix.....	51
Specifications.....	51
Projector Dimensions	52
On-Screen Display Menu Tree	53
Supported Resolutions and Timings	59
HDMI	59
Troubleshooting	60
LED Indicators	63
Maintenance.....	64
General Precautions.....	64
Cleaning the Lens	64
Cleaning the Case	64
Storing the Projector	64
Disclaimer.....	64

Regulatory and Service Information 65

Compliance Information.....	65
FCC Compliance Statement.....	65
FCC Radiation Exposure Statement.....	66
Industry Canada Statement.....	66
IC Warning Statement.....	66
Country Code Statement.....	66
IC Radiation Exposure Statement.....	67
CE Conformity for European Countries.....	67
Declaration of RoHS2 Compliance.....	68
Indian Restriction of Hazardous Substances.....	69
Product Disposal at End of Product Life.....	69
Copyright Information.....	70
Customer Service.....	71
Limited Warranty.....	72
Mexico Limited Warranty.....	75

Introduction

Package Contents

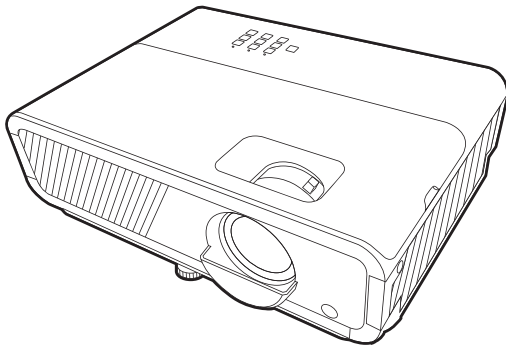

①



②

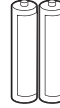

③

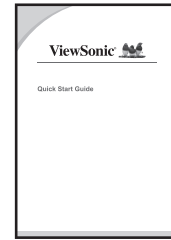

④



⑤

Number	Item
1	Projector
2	Remote Control
3	Batteries
4	Quick Start Guide
5	Power Cord

Note: The cables and remote control may vary depending on the region or country you purchased the product.

Projector

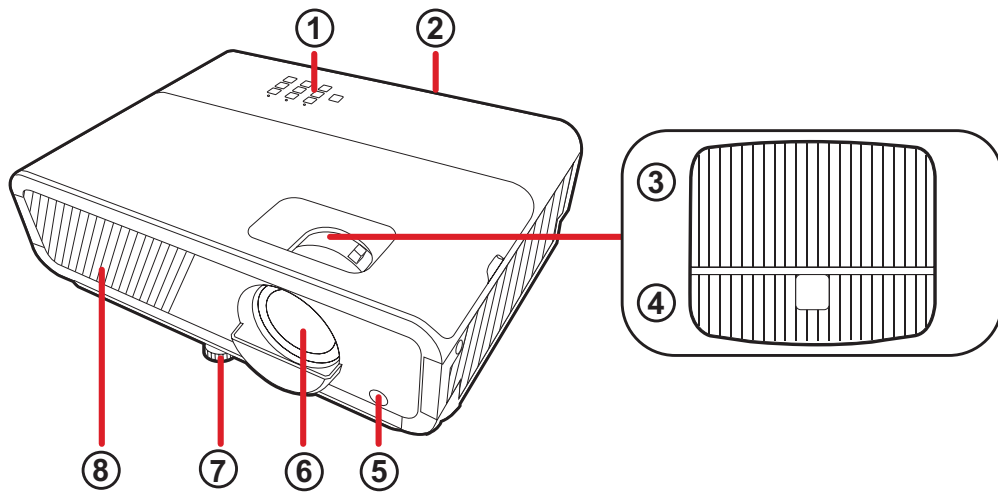

Overview



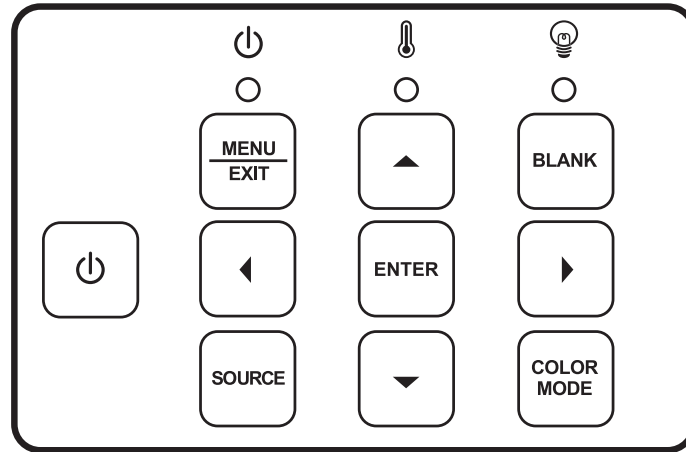

Number	Part
1	Keypad and Indicator Lights
2	I/O Ports
3	Focus Ring
4	Zoom Ring
5	Remote Control IR Receiver
6	Projection Lens
7	Adjustable Foot
8	Vent

Keypad



Button		Description
	Power	Turns the projector on and off.
	Menu	Opens the On-Screen Display Menu.
	Exit	Closes the On-Screen Display Menu.
BLANK	Blank	Hides the projected image.
ENTER	Enter	Confirms the selected item.
SOURCE	Source	Opens the input source menu.
COLOR MODE	Color Mode	Opens the Color Mode menu.
	Navigation	Selects an item or adjusts the value in the menu.

Indicator Lights

Indicator Light	Description
	Power indicator light
	Temperature indicator light
	Light source indicator light



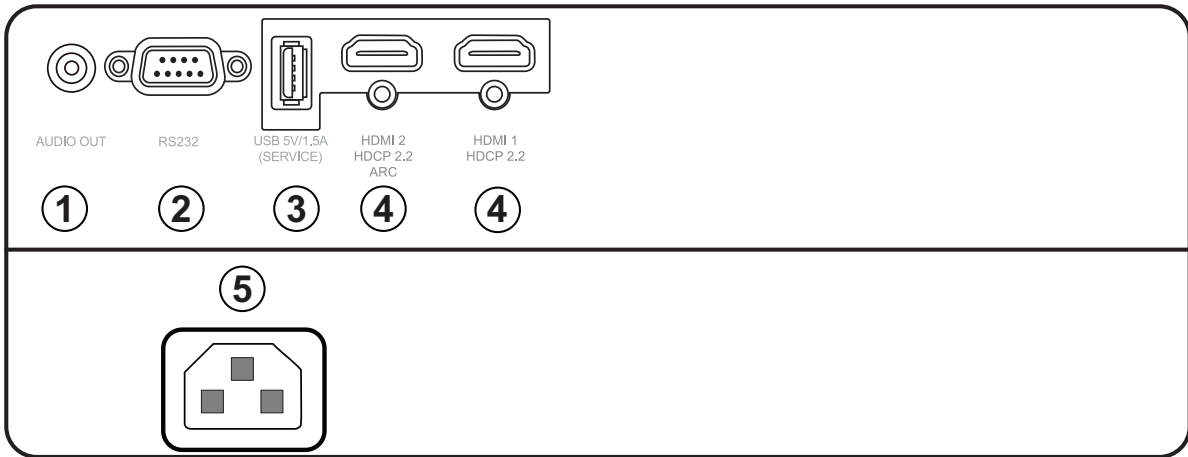





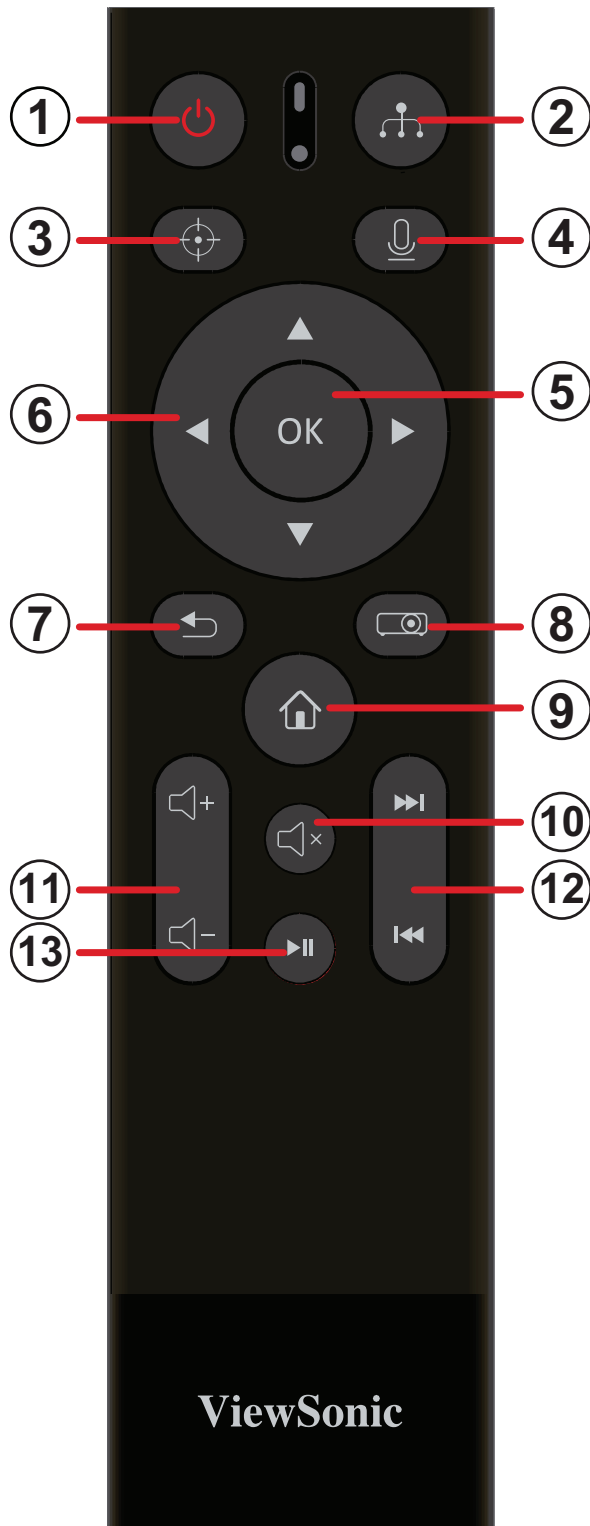



I/O Ports

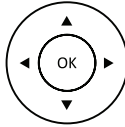

Connection Type		Usage
1	Audio Out	For use with external speakers.
2	RS-232	For remote operation of the projector's power, volume, input selection, brightness, and other functions from an external computer.
3	USB Type A	For servicing and powering devices.
4	HDMI	HDMI 2.0 that supports HDCP 2.2 for audio/video projection.
5	AC IN	For powering the projector.

Remote Control Overview



Button		Description
1		Power Turns the projector on and off.
2		Source Opens the input source menu.
3		Auto Focus¹ Focuses the image automatically.
4		Voice Control² Inputs voice commands.
5		OK Confirms the selected item.
6		Navigation Selects an item or adjusts the value in the menu.
7		Return Returns to the previous screen.
8		Settings Opens the On-Screen Display Menu.
9		Home Goes to the Home screen.
10		Mute Stops audio output.
11		Volume Up Increases the volume level.
		Volume Down Decreases the volume level.
12		Next Fast forwards or skips media.
		Previous Rewinds media or returns to previous media.
13		Play Plays media.
		Pause Pauses media.

1 – Not available on this model.

2 – To use **Voice Control**, the remote control must be paired with the projector.

Media Button Use

Applications	▶	▶▶	◀◀
Netflix	Plays or pauses the video	Advances the video 10 seconds	Rewinds the video 10 seconds
YouTube	Pauses the video	Goes to the next video	Goes to the previous video
Disney+			<i>Unsupported button</i>
Prime Video		Fast forwards the video	Rewinds the video

Receiver Range

For optimal performance, aim the remote control directly at the IR receiver. The maximum operation range is 8 m (26 ft) with a horizontal and vertical field of view of ± 30 degrees.

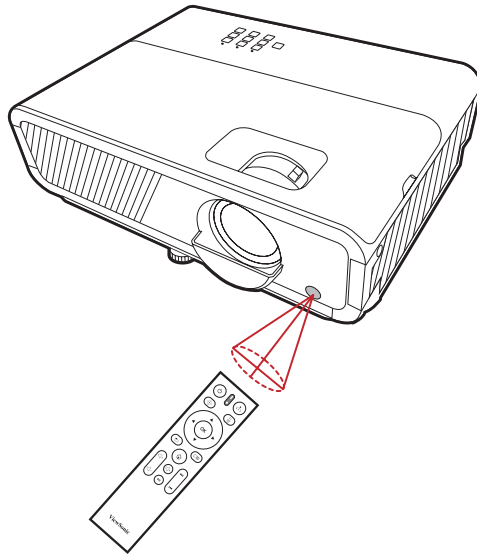

Installing the Batteries

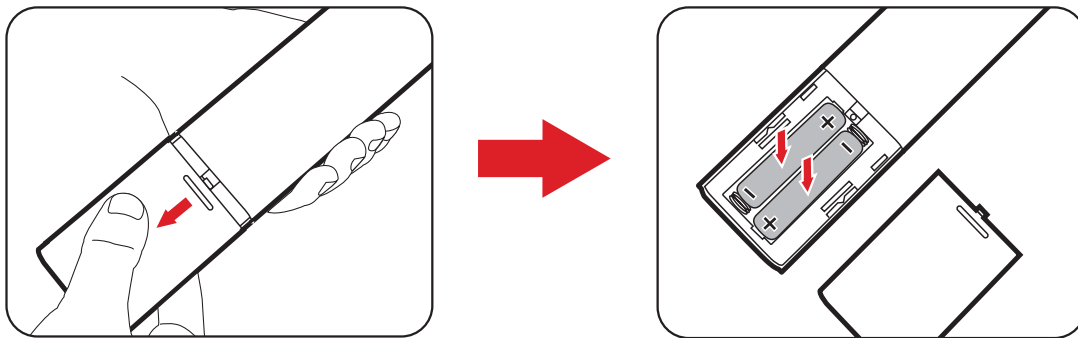

1. Open the battery compartment by removing the battery cover.
2. Insert two AAA batteries, ensuring correct polarity.
3. Replace the battery cover and press it down until it clicks into place.

Note:

- Store the remote control and batteries away from heat and humidity.
- Use only recommended battery types.
- Remove batteries when not in use for extended periods.
- Dispose of old batteries following the manufacturer's instructions and local regulations.

Pairing the Remote Control

1. Press the **Power** button to turn on the projector.
2. Make sure the input source is set to **Smart System**.
3. On the Google TV Home screen, go to **Settings** in the upper-right corner, then select **Remote & Accessories > Pair accessory**.
4. When the pairing screen is displayed, press and hold the **Return** and **Home** buttons until the LED indicator on the remote control starts flashing.

Note:

- To use **Voice Control**, the remote control must be paired with the projector.
- The Bluetooth pairing directions will appear on the screen during the initial setup or after factory reset.

Initial Setup

Positioning the Projector

The projector can be positioned either in front of or behind the screen. Alternatively, it can be mounted on the ceiling.

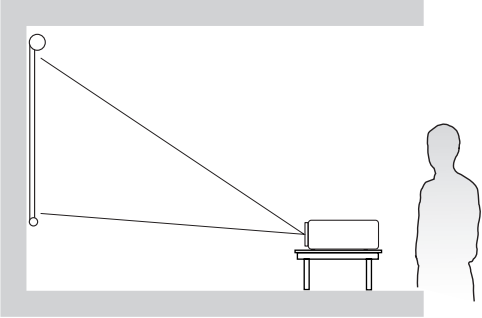
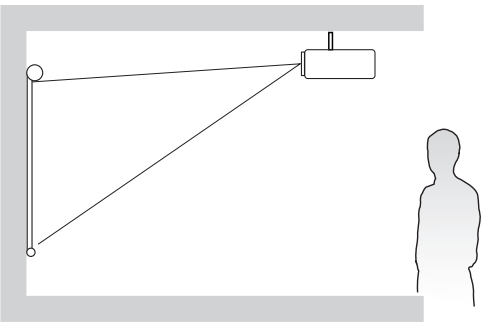
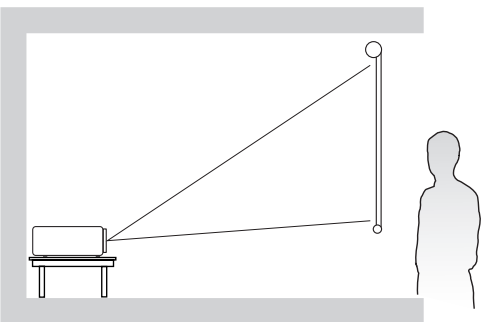
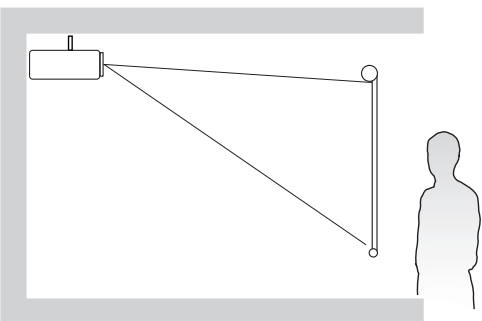
Position	Description
Front Table	
Front Ceiling	
Rear Table ¹	
Rear Ceiling ¹	

¹ – A rear projection screen is required.

Projection Dimensions

Use the tables below to determine the recommended projector-to-screen distance for your desired image height.

16:9 Image on a 16:9 Screen

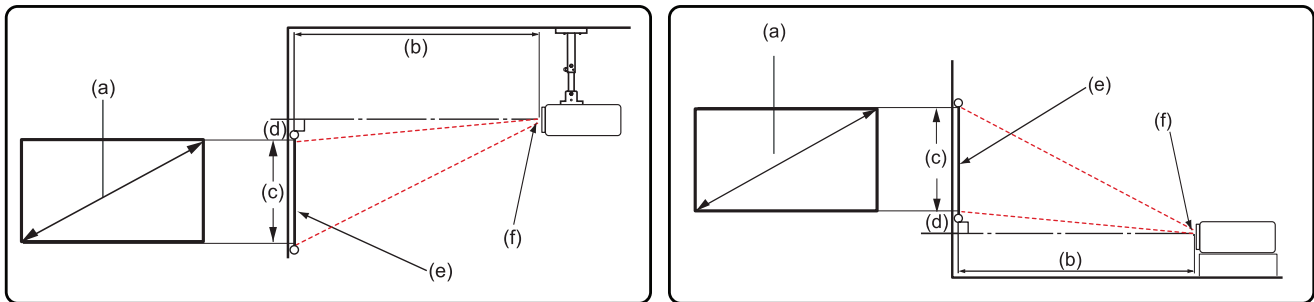

Note: (e) = Screen / (f) = Center of Lens

(a) Screen Size		(b) Projection Distance				(c) Image Height		(d) Vertical Offset			
		Minimum		Maximum				Minimum		Maximum	
in.	mm	in.	mm	in.	mm	in.	mm	in.	mm	in.	mm
60	1524	59	1497	77	1946	29	747	1.47	37	1.47	37
70	1778	69	1746	89	2270	34	872	1.72	44	1.72	44
80	2032	79	1996	102	2595	39	996	1.96	50	1.96	50
90	2286	88	2245	115	2919	44	1121	2.21	56	2.21	56
100	2540	98	2495	128	3243	49	1245	2.45	62	2.45	62
110	2794	108	2744	140	3567	54	1370	2.70	68	2.70	68
120	3048	118	2994	153	3892	59	1494	2.94	75	2.94	75
130	3302	128	3243	166	4216	64	1619	3.19	81	3.19	81
140	3556	138	3493	179	4540	69	1743	3.43	87	3.43	87
150	3810	147	3742	192	4865	74	1868	3.68	93	3.68	93
160	4064	157	3992	204	5189	78	1992	3.92	100	3.92	100
170	4318	167	4241	217	5513	83	2117	4.17	106	4.17	106
180	4572	177	4491	230	5838	88	2241	4.41	112	4.41	112
190	4826	187	4740	243	6162	93	2366	4.66	118	4.66	118
200	5080	196	4989	255	6486	98	2491	4.90	125	4.90	125
250	6350	246	6237	319	8108	123	3113	6.13	156	6.13	156
300	7620	295	7484	383	9729	147	3736	7.35	187	7.35	187

Note:

- These figures are for reference purposes only when setting up the projector.
- For optimal results, test the projector's image size and distance before permanent installation.

Mounting the Projector

When mounting the projector:

- For optimal compatibility, please use a ViewSonic mount.
- When using a third-party mount, please note that screw sizes may vary depending on the mounting plate thickness.
- Use screws that meet the below specifications to ensure a secure attachment.

Screw Type	Maximum Screw Length
M4 x 8	8 mm

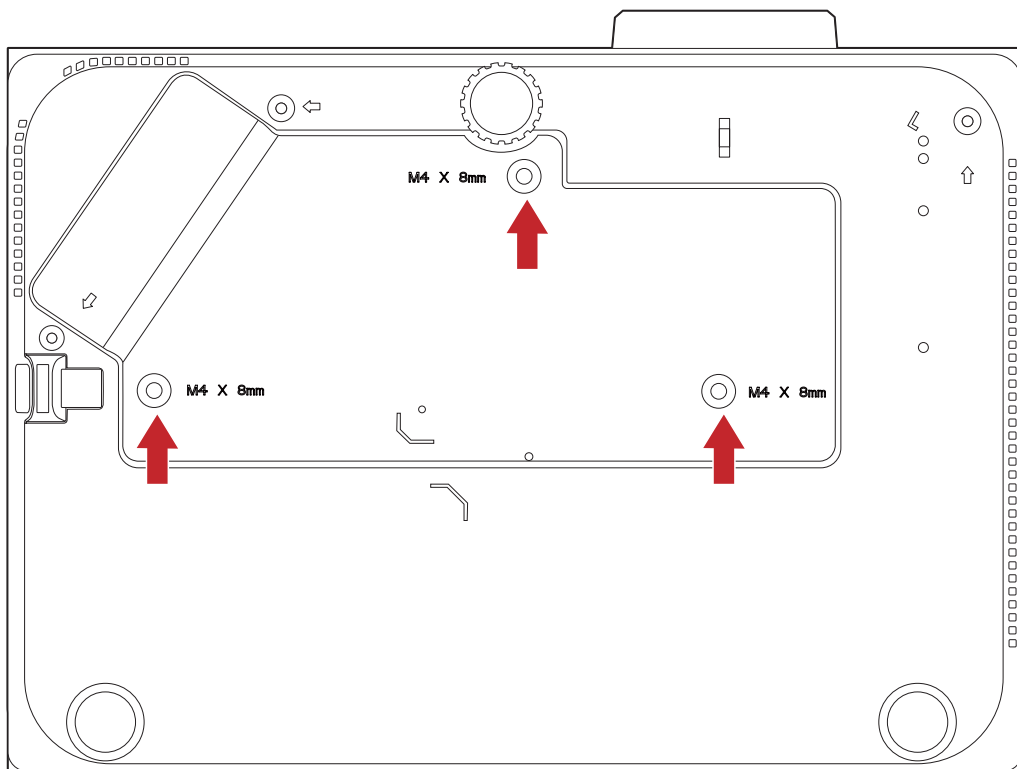

Important: Do not install the projector near a heat source or air conditioner.

Protecting Against Unauthorized Access

The projector includes built-in security features to prevent theft, unauthorized access, and accidental changes.

Using the Security Bar

To help prevent the projector from falling or being stolen, use a locking device to secure the projector to a fixed object.

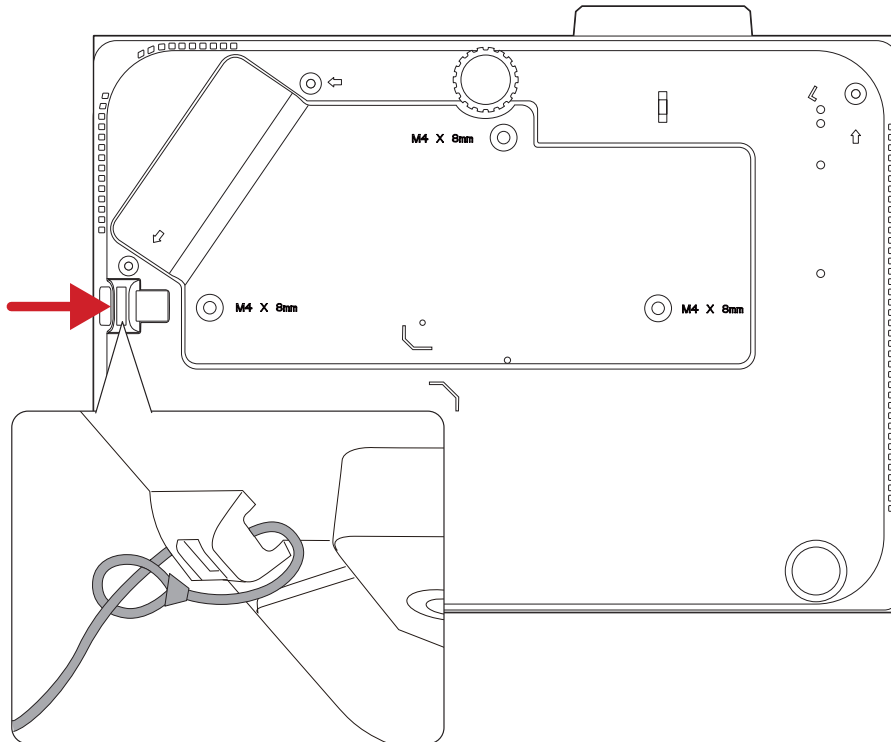

Using the Password Function

To prevent unauthorized access, the projector offers a password security option. The password can be set through the On-Screen Display Menu.

Note: Store your password in a secure location.

Setting a Password

1. Press **Menu / Settings** to open the On-Screen Display Menu, then go to **SYSTEM > Security Settings** and press **Enter**.

2. Select **Power On Lock**.

3. Press the **Navigation** (↑/↓/←/→) buttons to enter a six-digit password.

Note: The **Navigation** (↑/↓/←/→) buttons represent four digits (e.g., 1, 2, 3, 4).

4. Re-enter the new password to confirm it. The On-Screen Display Menu will return to the **Security Settings** page after confirmation.

5. Press **Exit** to leave the menu.

Note: Once set, the correct password must be entered every time the projector is started.

Changing the Password

1. Press **Menu / Settings** to open the On-Screen Display Menu, then go to **SYSTEM > Security Settings > Change Password** and press **Enter**.

2. Enter the old password.

Note: If the password is correct, the dialog “Input New Password” will appear. If the password is incorrect, the message “Input Current Password” will appear. You can try again or press **Exit** to cancel.

3. Enter a new password.

4. Re-enter the new password to confirm it.

5. Press **Exit** to leave the menu.

Note: The digits will be displayed as asterisks (*).

Disabling the Password Function

1. Press **Menu / Settings** to open the On-Screen Display Menu, then go to **SYSTEM > Security Settings** and press **Enter**.
2. Select **Power On Lock** then select **Off** by pressing the **Navigation (←/→)** button.
3. Enter the current password.

Note:

- If the password is correct, the projector will return to the **Security Settings** menu. If the password is incorrect, the dialog “Input Current Password” will appear. You can try again or press **Exit** to cancel.
- Store your current password in a secure location, as you’ll need it to reactivate the password feature if needed.

Forgetting the Password

If the password function is enabled, you will be asked to enter the six-digit password every time you turn on the projector.

If you enter an incorrect password, the password error message, as pictured to the right, will appear for five seconds followed by the dialog “Input Password”.

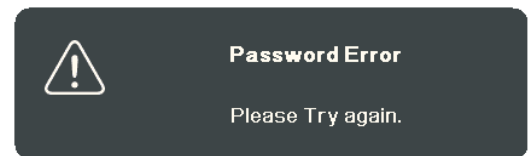

You can try again or use the Password Clear Procedure.

Note: Five unsuccessful password attempts will trigger the projector to automatically shut down.

Password Clear Procedure

1. Once the projector turns off and enters standby mode, disconnect the power cord from the power socket of the projector.
2. While pressing and holding the **Power** button and the **Right (→)** button simultaneously, plug the power cord back in.
3. You will now be able to access the projector without entering a password.

Locking the Keypad

Lock the keypad to prevent your settings from being accidentally changed.

Note: When the **Panel Key Lock** is set to **On**, no Keypad buttons will function except for **Power**.

1. Press **Menu / Settings** to open the On-Screen Display Menu, then go to **SYSTEM > Panel Key Lock**.
2. Select **On** by pressing the **Navigation (←/→)** button.
3. Select **Yes** and press **Enter** to confirm.
4. To unlock the Keypad, press and hold the **Navigation (→)** button on the projector for three seconds.

Note: You can also use the remote control to enter the **SYSTEM > Panel Key Lock** menu and select **Off**.

Making Connections

Connecting to Power

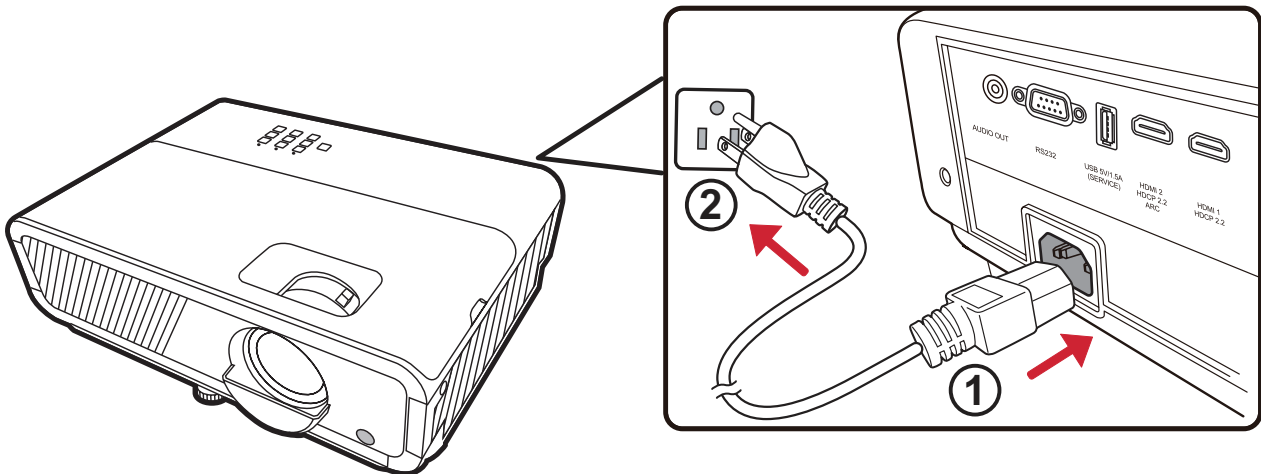

1. Connect the power cord to the **AC IN** jack at the rear of the projector.
2. Plug the power cord into a power outlet.

Note: When installing the projector, place a convenient disconnect device in the wiring or connect the power cord to an easily accessible outlet. In case of any issues, use this device or unplug the power cord to shut off the power supply immediately.

Connecting to External Devices

Note:

- For more information about the connection ports, please refer to “I/O Ports”.
- Compatibility and connectivity may differ between models.

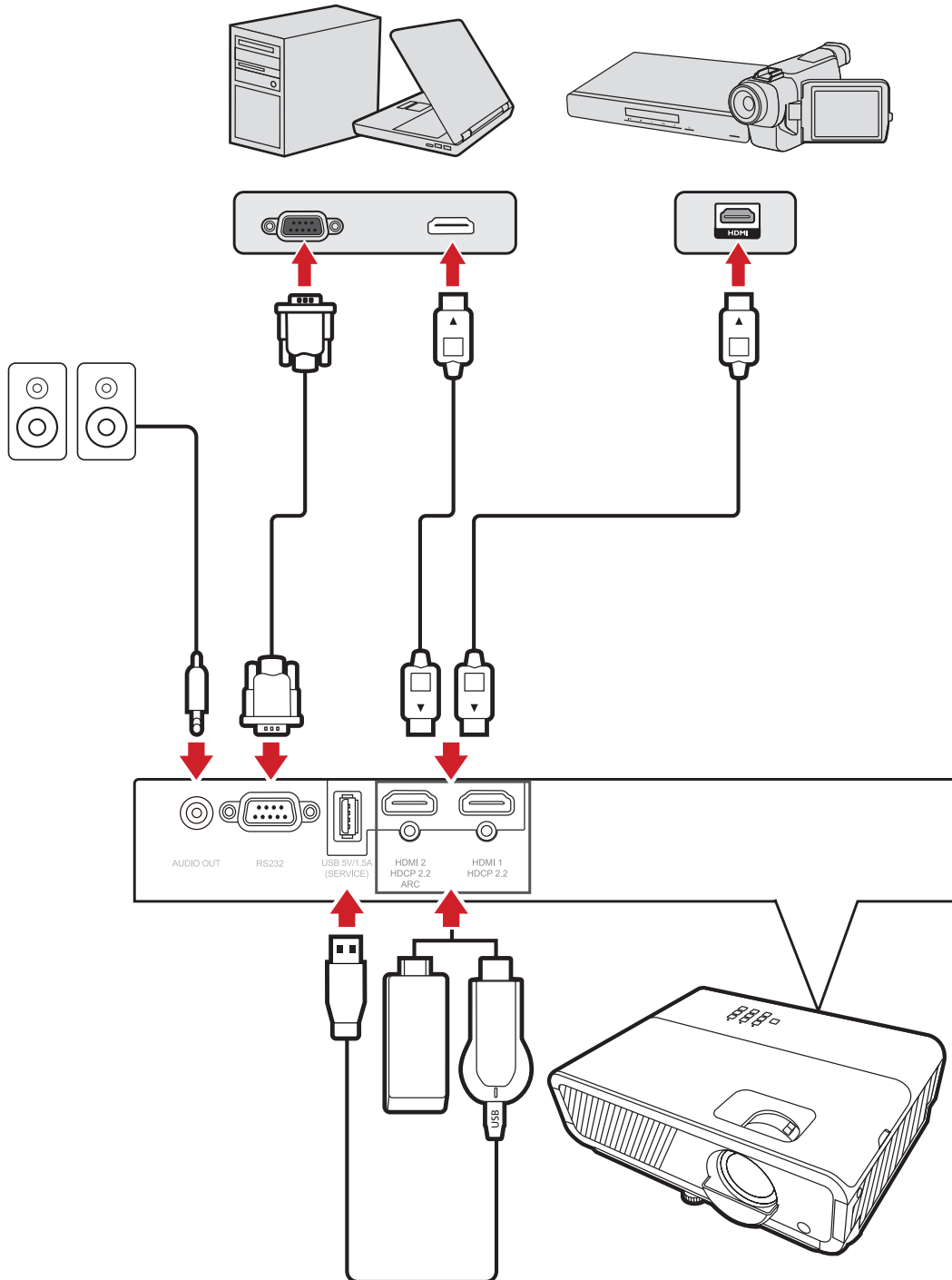

Connecting to Bluetooth Devices

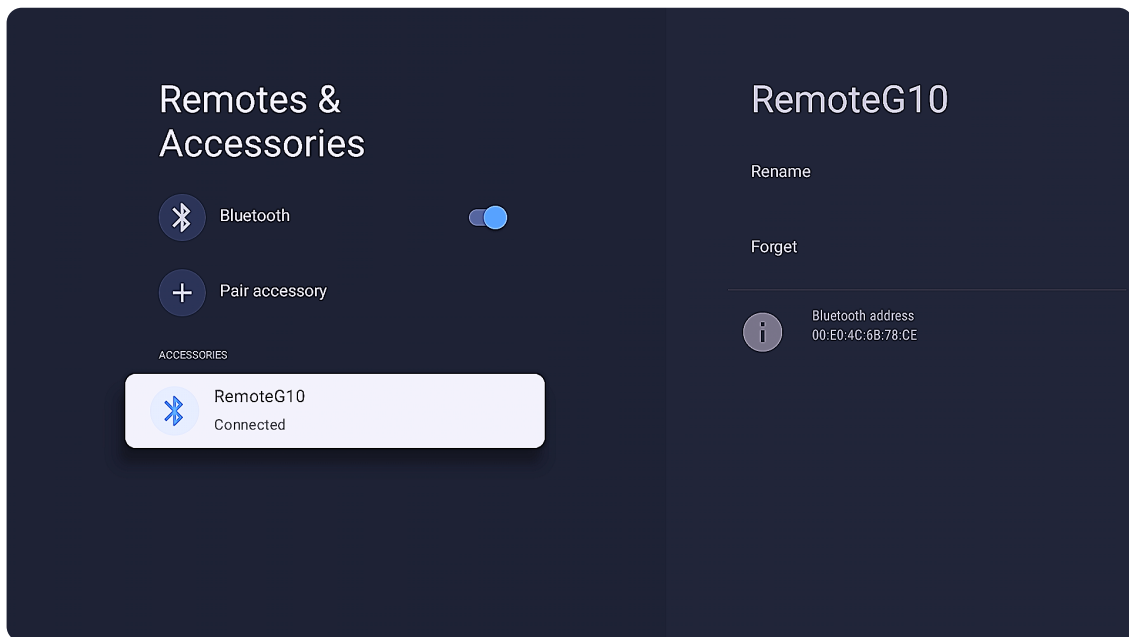

1. Press the **Source** button.
2. Select **Smart System**.
3. On the Google Home TV screen, go to **Settings** in the upper-right corner, then select **Remote & Accessories > Pair accessory**.
4. Turn on your Bluetooth device and make sure it is in pairing mode.

Note: For more information about how to pair the remote control, see “Pairing the Remote Control”.

5. Select the device you want to pair and press the **OK** button.
6. Follow the on-screen directions to complete pairing.

Note:

- Only one Bluetooth device can be paired at a time.
- Paired or previously-paired devices will be listed under **ACCESSORIES** in the **Remote & Accessories** setting. To rename or forget an already-paired device, select it, then select **Rename** or **Forget**.

Screen Mirroring

Note: Features may vary by device.

Before mirroring your Android/iOS screen to the projector, check the following:

- Connect your device to the same network as the projector.
- Make sure the projector's input source is set to **Smart System** and the projector stays on the Google TV Home screen.

For Android devices

1. Download and install the Google Home application and open it.
2. Refresh the device list by swiping down from the top of the screen. Wait up to 30 seconds for the device to appear.
3. Select your device's name to begin screen mirroring.

For iOS devices

Mirroring your iOS device's screen requires third-party applications such as AirScreen or AirDroidCast TV.

Cast

Before casting from your Android/iOS device to the projector, check the following:

- Connect your device to the same network as the projector.
- Make sure the projector's input source is set to **Smart System** and the projector stays on the Google TV Home screen.
- Make sure you are using the latest version of a casting-enabled application or a Chrome browser.

1. Open the application containing the content you want to share.
2. Look for the casting option within the application and select it.
3. On your device, select the name of your projector from the list of available devices.
4. When the cast icon changes color, you are successfully connected.
5. To stop casting, select **Disconnect** from the casting menu on your device.

Using the Projector

Turning the Projector On

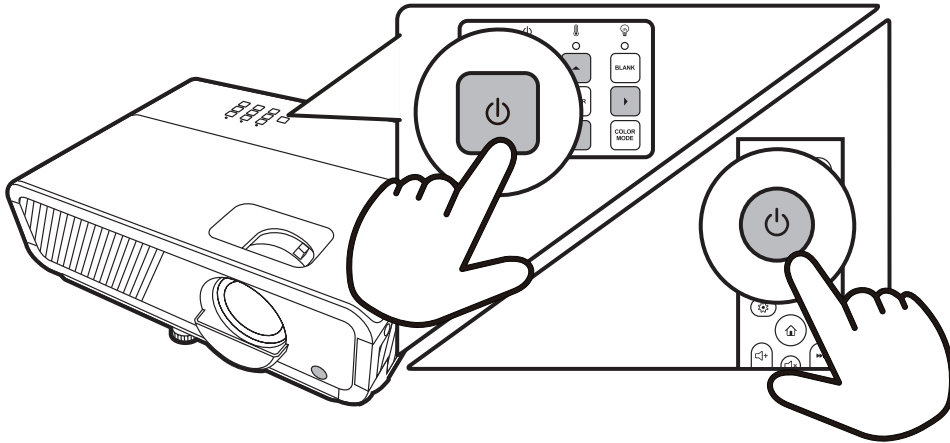

1. Make sure the projector's power cord is connected to a power outlet.
2. Press the **Power** button to turn on the projector. The Power Indicator Light will turn steady green and an audible tone will play.

Note:

- If the projector is turned on for the first time or reset to factory defaults, the On-Screen Display Menu's language and projector projection position will need to be set before using the projector.
- The fan will run for 90 seconds before activating the light source if the projector is still warm from previous use.
- To extend the light source life, wait at least five minutes before turning the projector off.

Turning the Projector Off

1. Press the **Power** button and a dialog will appear.
2. Press the **Power** button again to confirm and turn off the projector. The Power Indicator Light will turn blinking green and an audible tone will play.

Note:

- To protect the light source, the projector will not respond to commands during the cooling process.
- Do not unplug the power cord before the projector completely shuts down.

Selecting an Input Source

The projector supports multiple connections, but can only display one full-screen image at a time. When **Quick Auto Search** is turned on, it automatically detects available inputs. To manually switch between sources, press the **Source** button.

Note: Make sure connected sources are also turned on.

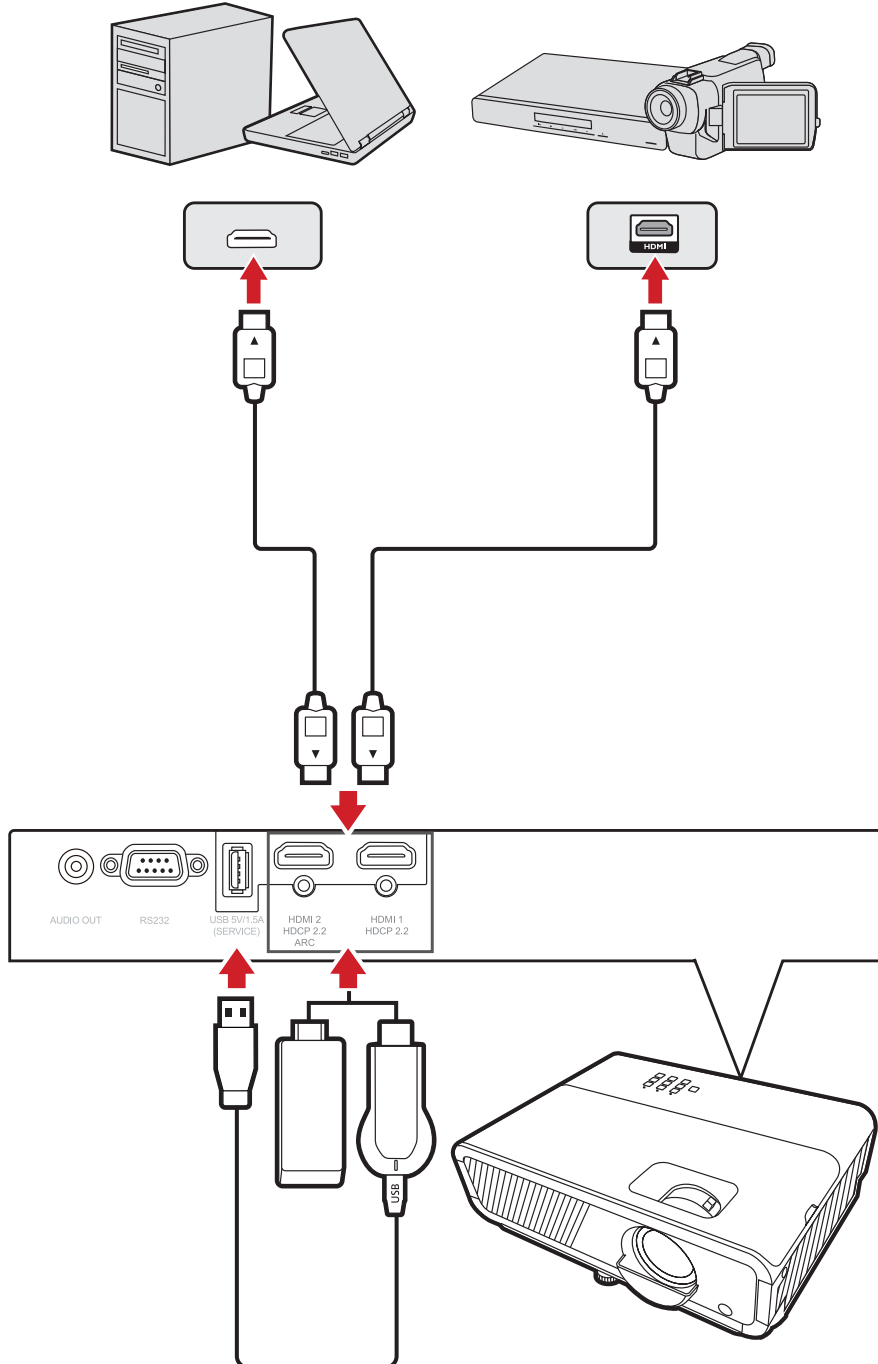

Adjusting the Projected Image

Projection Angle

The projector has one adjustable foot. Adjusting the foot will change the projector's projection angle.

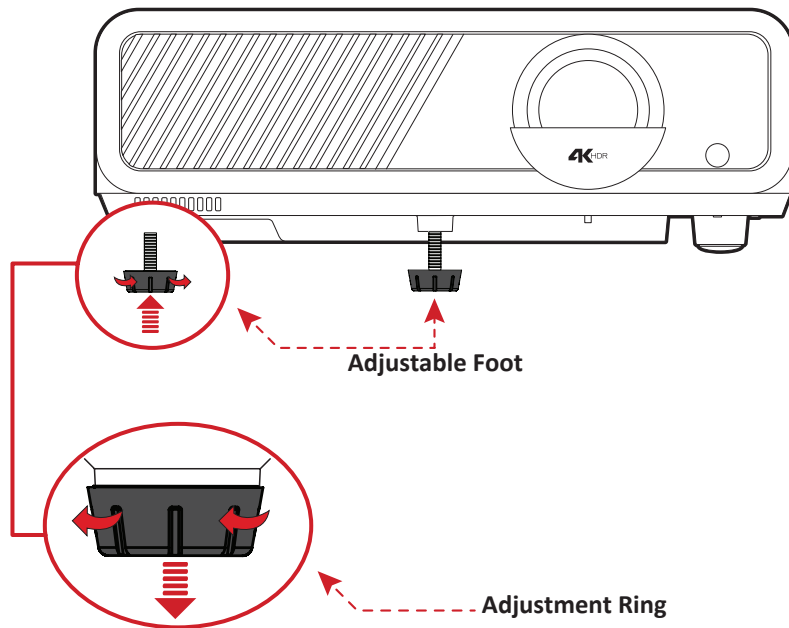
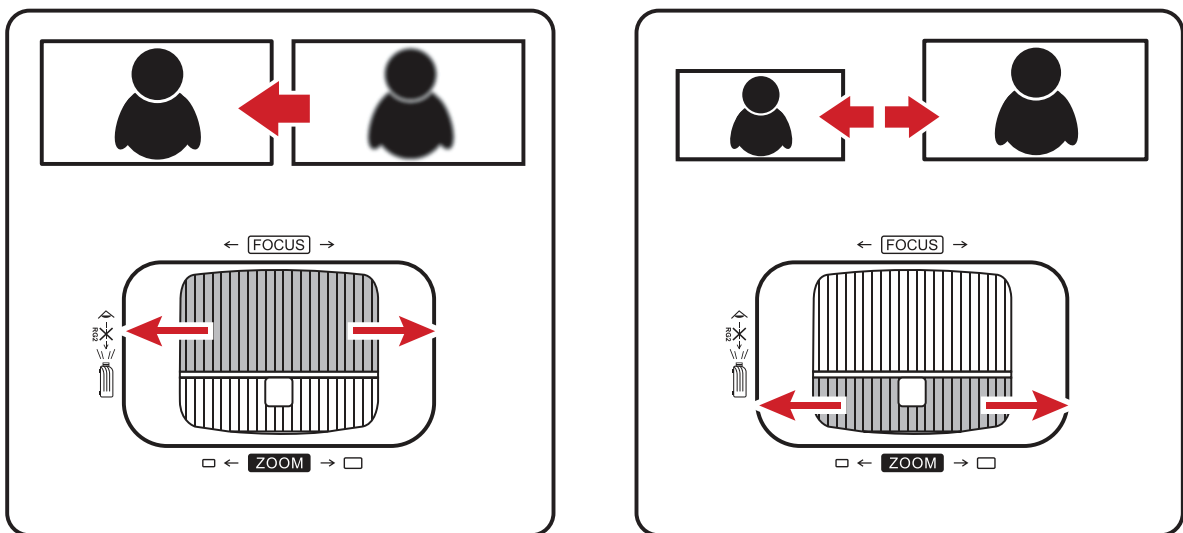

Image Size and Clarity

To adjust the projected image's size, turn the **Zoom Ring**. Image clarity can be improved by fine-tuning the **Focus Ring**.



Correcting Keystone

The keystone effect causes distorted images on curved surfaces. This can be corrected by aligning images to appear as straight and rectangular.

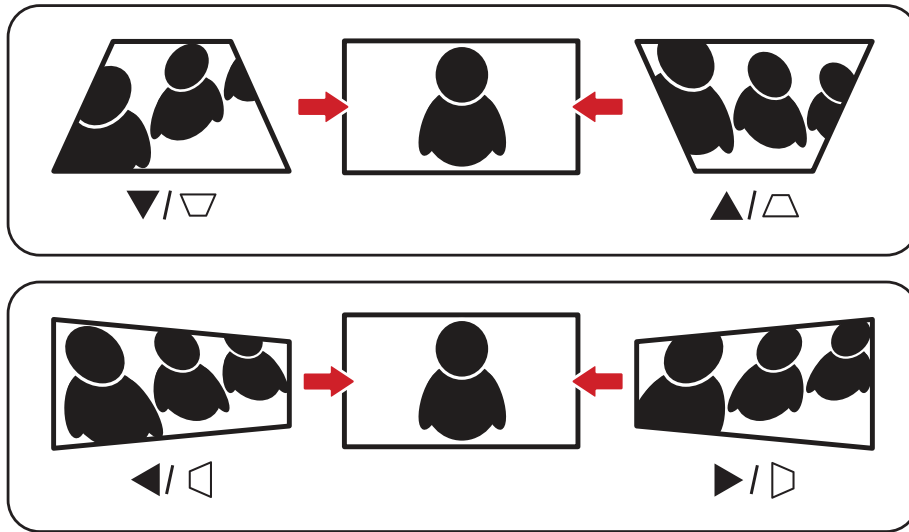

To correct keystone manually

1. Go to **DISPLAY > Keystone > Vertical** or **Horizontal**.
2. Use the **Navigation** buttons (**↑/↓/←/→**) to adjust the image shape as needed.

Corner Adjustment

Manually adjust the shape and size of a projected image that is unevenly rectangular on all sides.

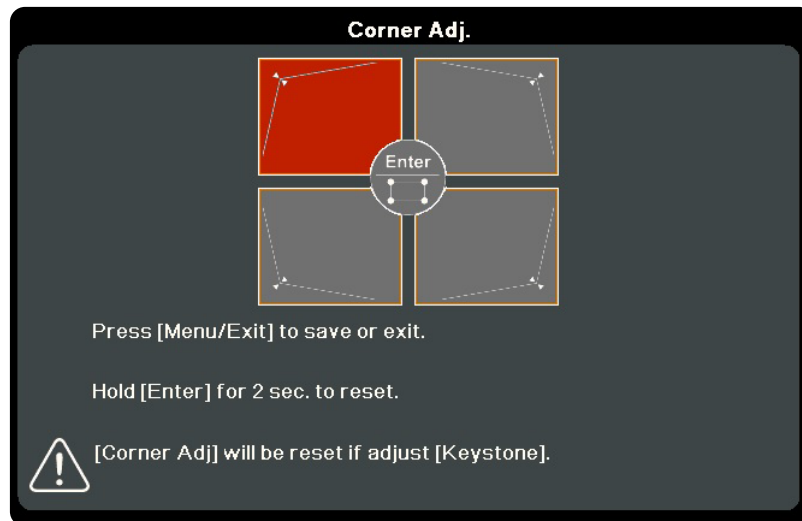

To adjust the corners

1. Open the **Corner Adj.**
2. Press the **Navigation** ($\uparrow/\downarrow/\leftarrow/\rightarrow$) buttons to select the corner that needs adjustment, then press **Enter** to confirm the selection.
3. Press the **Navigation** (\leftarrow/\rightarrow) buttons to select 45-degree or 90-degree angle adjustment, then press the **Enter** button to confirm the selection.
4. Follow the on-screen directions to adjust the shape and size of the projected image. Press the **Menu/Exit** button to go back to a previous step. Press and hold the **Enter** button for two seconds to reset the settings on the selected corner.

Note:

- Adjusting Keystone will reset the **Corner Adjustment** settings.
- After the **Corner Adjustment** settings have been modified, some aspect ratios or timings will not be available.

Menu Operation

Google TV Home Screen (Smart System)

Smart System is the default input source. When you turn on the projector or press the **Home** button, the Google TV Home screen is displayed.

Note: The content of your Google TV Home screen may vary depending on the Google TV version.

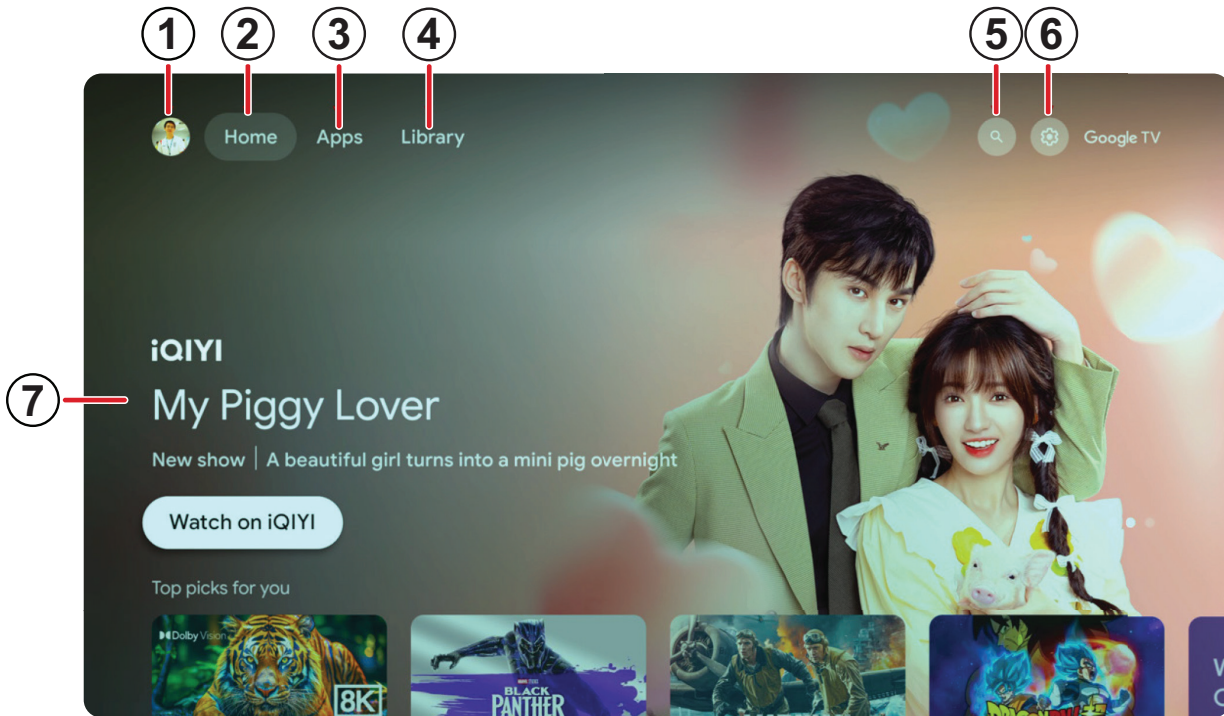

	Menu	Description
1	Account	Allows you to manage your Google TV account.
2	Home	Goes to the Google TV Home screen.
3	Apps	Shows installed applications.
4	Library	Shows the purchased or viewed movies or shows.
5	Search	Finds applications or other online content.
6	Search	Opens the Google TV settings.
7	Recommended Content	Displays suggested movies or shows to watch next.

Note:

- Google TV remote TCP port: 6466 / 6467
- Google Cast TCP port: 8008 / 8009 / 8443 / 9000 and used in conjunction with two TCP dynamic ports (e.g., ports above 40000)

On-Screen Display Menu

The projector has on-screen display menus for making image adjustments and changing settings.

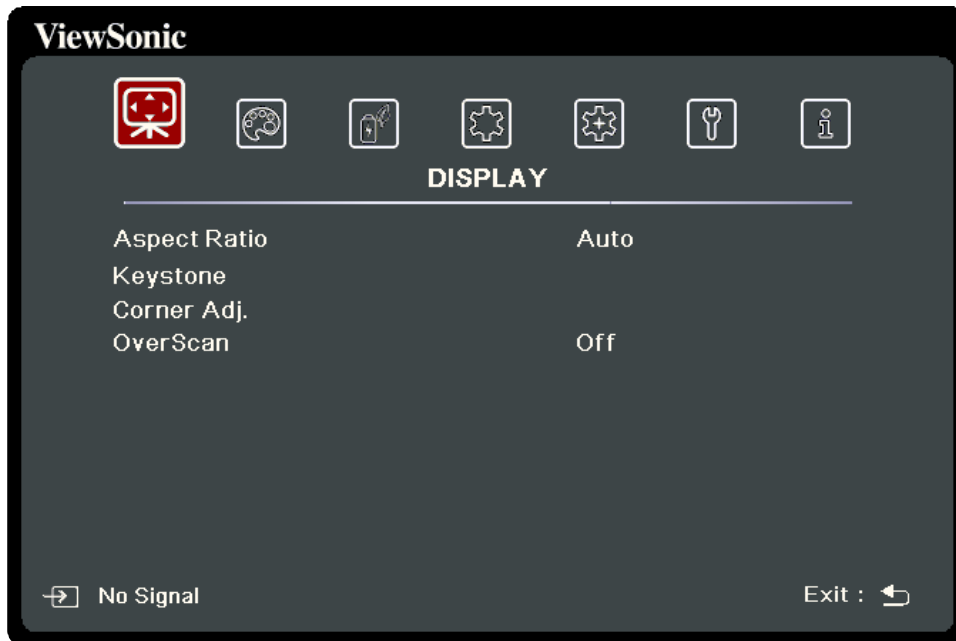

Menu	Description
DISPLAY	Adjusts Aspect Ratio, Keystone, Corner Adj., and OverScan settings.
IMAGE	Adjusts Color Mode, Brightness, Contrast, Color Temp., and Advanced settings.
POWER MANAGEMENT	Adjusts Auto Power On, Smart Energy, and Power On Source settings.
BASIC	Adjusts Audio Settings, Presentation Timer, Blank Timer, Message, and Splash Screen settings.
ADVANCED	Adjusts HDR, HDMI Settings, Ultra Fast Input, and Light Source Settings settings.
SYSTEM	Adjusts Language, Projector Position, Menu Settings, High Altitude Mode, Quick Auto Search, Security Settings, Panel Key Lock, and Baud Rate settings.
INFORMATION	Displays projector information.

Menu Navigation

1. To open the On-Screen Display Menu, press the **Menu / Settings** button on the projector or the remote control.
2. Press the **Navigation** (←/→) buttons to select a main menu, then press the **Enter** button to confirm the selection and enter the sub-menu.
3. Press the **Navigation** (↑/↓/←/→) buttons to select an item in the sub-menu, then press the **Enter** button to view further settings or press the **Navigation** (←/→) buttons to make adjustments.
4. To exit the menu, press the **Menu / Exit** button.

Menu Options

DISPLAY

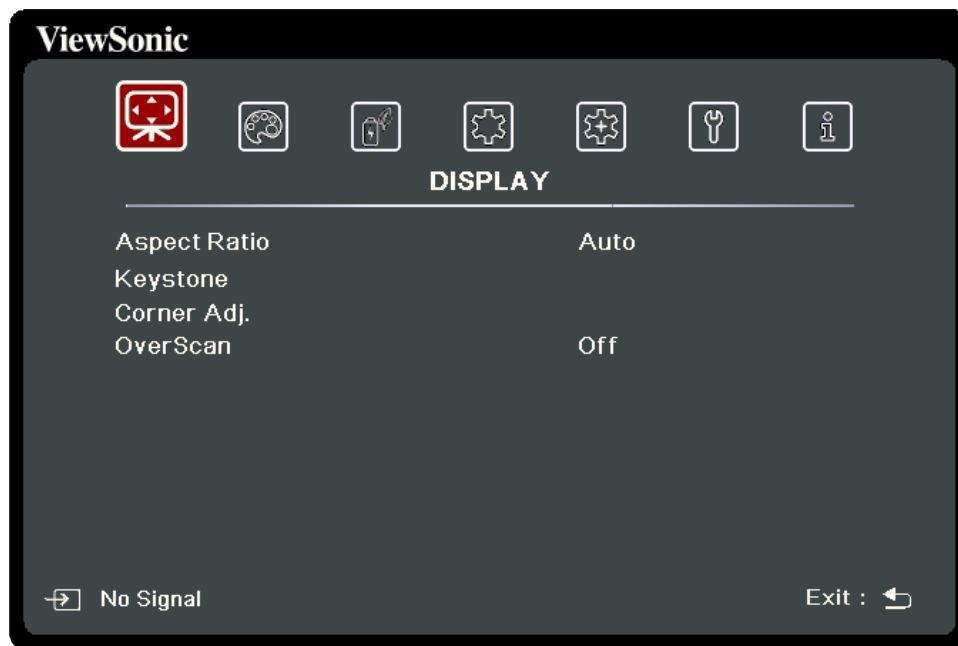

Menu	Description	
Aspect Ratio	Auto	Sets the aspect ratio according to the projector's resolution setting and connected input signal.
	4:3	Centers a scaled image on the screen with a fixed 4:3 aspect ratio.
	16:9	Centers a scaled image on the screen with a fixed 16:9 aspect ratio.
	16:10	Centers a scaled image on the screen with a fixed 16:10 aspect ratio.
	2.35:1	Centers a scaled image on the screen with a fixed 2.35:1 aspect ratio.
	Native	Preserves the original resolution of the input signal while resizing it to fit the display area, maintaining its full native dimensions.

Menu	Description	
Keystone	Vertical	Manually adjusts image distortion vertically.
	Horizontal	Manually adjusts image distortion horizontally.
	Rotation	Rotates the image.
	<p>Note:</p> <ul style="list-style-type: none"> • Adjusting Rotation will clear the current Keystone settings; adjusting Keystone will clear the current Rotation settings. • Under native timing, keystone correction supports $\pm 25^\circ$ for vertical or horizontal adjustment. The range decreases when both are adjusted together. 	
Corner Adj.	Adjusts each corner to make a square image when the projection surface is not level.	
OverScan	<p>Enlarges the original picture horizontally and vertically to an equal aspect ratio that fills the screen.</p> <p>Note: This function is only available when a Composite Video or HDMI input signal is detected.</p>	

IMAGE

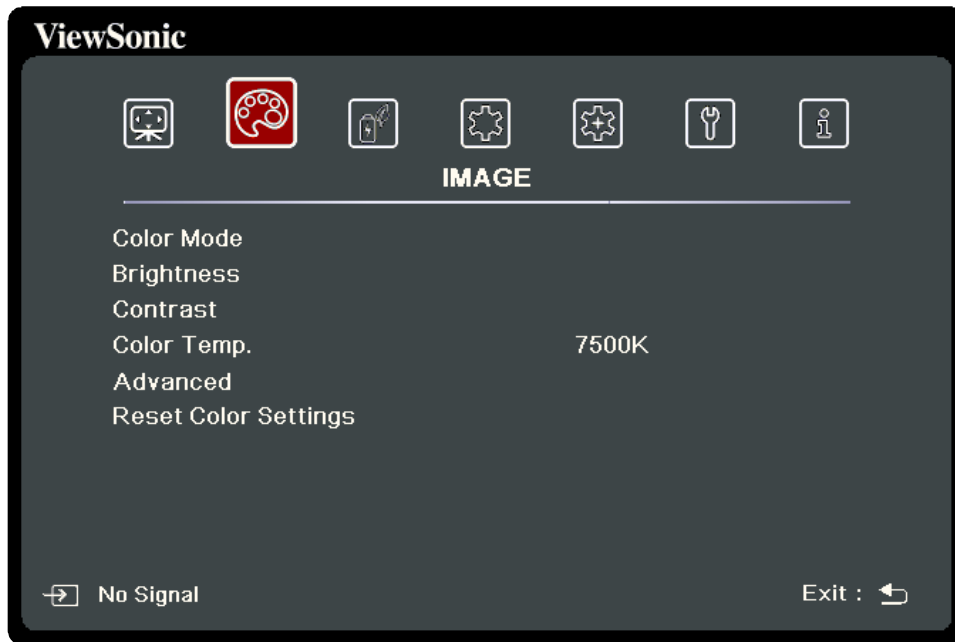

Menu	Description	
Color Mode	Brightest	Adjusts the projected image's brightness to maximum for well-lit settings.
	TV	Optimized for viewing sports in well-lit environments.
	Gaming	Optimizes the projector for maximum contrast and vivid colors.
	Movie	Provides a balance of detail and colors for watching movies.
	Golf	Tailored for golf simulators, enhancing the blue sky and vibrant green grass colors.
	Low Blue Light	Reduces the emission of harmful low-blue light that is harmful to human's eyesight.
	User	Sets user-specific custom settings. Note: After User is selected, some sub-menus under the IMAGE menu can be adjusted according to the selected input source.
Brightness	Adjusts how bright or how dark the projected image will be.	
Contrast	Adjusts the difference between the brightest and darkest parts of the projected image.	

Menu	Description	
Color Temp.	9300K	Sets a color temperature: warm (6500K) to cold (9300K).
	7500K	
	6500K	
	Red Gain	Adjusts the brightness levels of red.
	Green Gain	Adjusts the brightness levels of green.
	Blue Gain	Adjusts the brightness levels of blue.
	Red Offset	Adjusts the hue levels of red.
	Green Offset	Adjusts the hue levels of green.
	Blue Offset	Adjusts the hue levels of blue.
Advanced	Sharpness	Adjusts the projected image's details. Note: Supports the YUV color space only.
	Gamma	Adjusts the brightness level of the projector's grayscale levels.
	Color Management	Fine-tunes the colors (Hue), purity (Saturation), and brightness/white-temperature (Gain) in the projected image.
Reset Color Settings	Returns the IMAGE settings to their default values.	

POWER MANAGEMENT

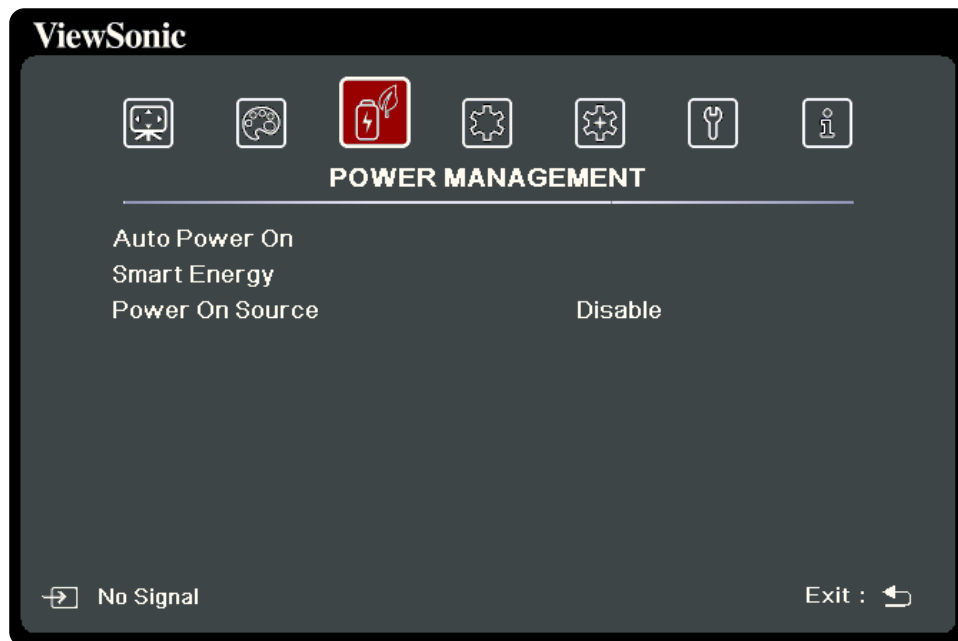

Menu	Description						
Auto Power On	Signal	Turns on the projector automatically when an input signal is detected.					
	CEC	Turns on or off HDMI CEC-compatible devices connected to the projector with a single button press. Note: For the CEC function to work properly, make sure that the device is properly connected to the HDMI input of the projector, and its CEC function is turned on.					
	Direct Power On	Turns on the projector automatically when power is supplied.					
	<p>Note: Enabling Auto Power On will increase energy consumption.</p> <div data-bbox="528 1603 1366 2004" style="border: 1px solid black; padding: 5px;"> <p style="text-align: center;">Auto Power On</p> <table style="width: 100%; border-collapse: collapse;"> <tr> <td style="width: 70%;">Signal</td> <td style="text-align: right;">Disable</td> </tr> <tr> <td>CEC</td> <td style="text-align: right;">Disable</td> </tr> <tr> <td>Direct Power On</td> <td style="text-align: right;">Disable</td> </tr> </table> <p style="font-size: small; margin-top: 10px;">* Enable this setting will increase energy consumption!</p> <p style="text-align: right; font-size: small;">Return : [back arrow]</p> </div>		Signal	Disable	CEC	Disable	Direct Power On
Signal	Disable						
CEC	Disable						
Direct Power On	Disable						

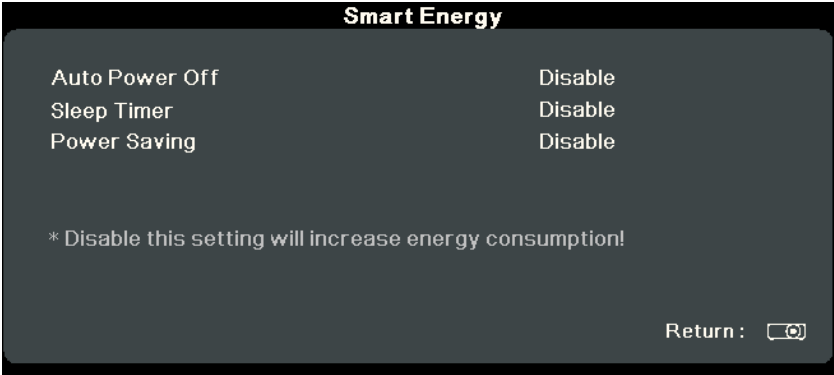
Menu	Description	
Smart Energy	Auto Power Off	Turns the projector off automatically after a set period of time once no input signal is detected.
	Sleep Timer	Turns the projector off automatically after a set period of time.
	Power Saving	Reduces power consumption if no input source is detected.
	<p>Note: Disabling Smart Energy will increase energy consumption.</p> 	
Power On Source	Enters the desired input source directly after turning on the projector.	

BASIC

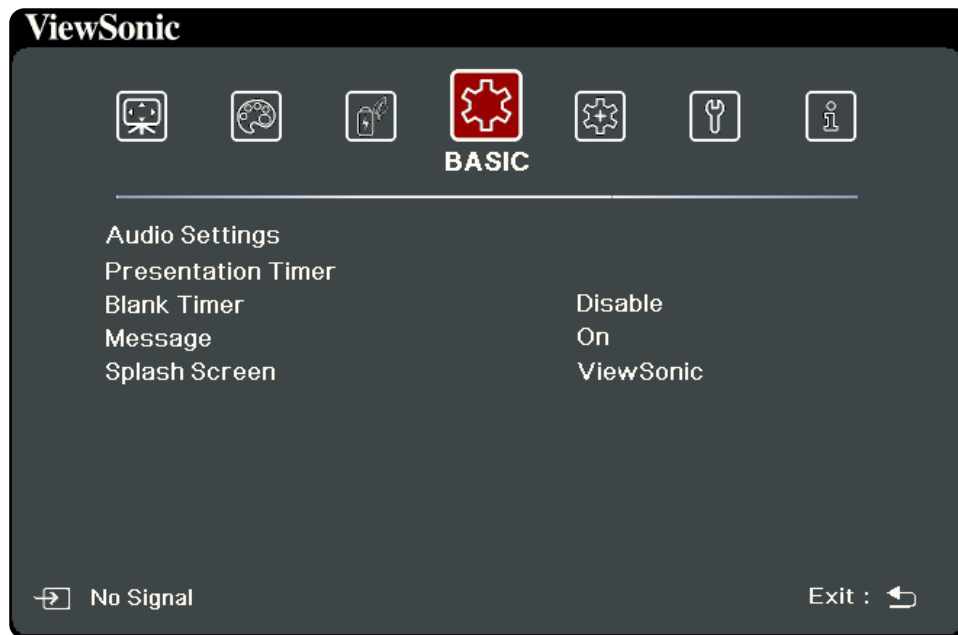

Menu	Description	
Audio Settings	Audio Mode	Sets a preferred audio mode to fit your audio content.
	Mute	Stops audio output.
	Audio Volume	Adjusts the volume level.
	Power On/Off Ring Tone	Turns on or off the audible tone during the start up and shut down process.
	Audio Out	Select an audio output method from built-in speakers (Internal Speaker), the audio output jack (Audio Out), or the HDMI 2 port (HDMI ARC).
Presentation Timer	Displays the presentation time on the projected image to improve time management when giving presentations.	
	Timer Period	Sets the time period. If the timer is already running, the timer will restart whenever the Timer Period is reset.

Menu	Description		
Presentation Timer	Timer Display	Sets whether the timer displays on screen and for how long.	
		Always	Displays the timer on screen throughout the presentation time.
		1 min/2 min/3 min	Displays the timer on screen in the last 1/2/3 minute(s).
		Never	Hides the timer throughout the presentation time.
	Timer Position	Sets the timer position.	
	Timer Counting Direction	Sets the counting direction.	
		Count Down	Decreases from the preset time to zero.
Count Up	Increases from the zero to the preset time.		
Sound Reminder	Turns on an audio reminder. A double beep will sound at the last 30 seconds of counting down/up, and a triple beep when the timer is up.		
Start Counting/Off	Select Start Counting to activate the timer. Select Off to cancel it.		
Blank Timer	<p>Allows the projector to return to the projected image automatically after a period of time when there is no action taken when on a blank screen.</p> <p>Caution: Do not block the projection lens while the projector is in use, as this can cause objects to overheat and potentially ignite.</p>		
Message	Turns on or off reminder messages.		
Splash Screen	Sets the startup logo when turning on the projector.		

ADVANCED

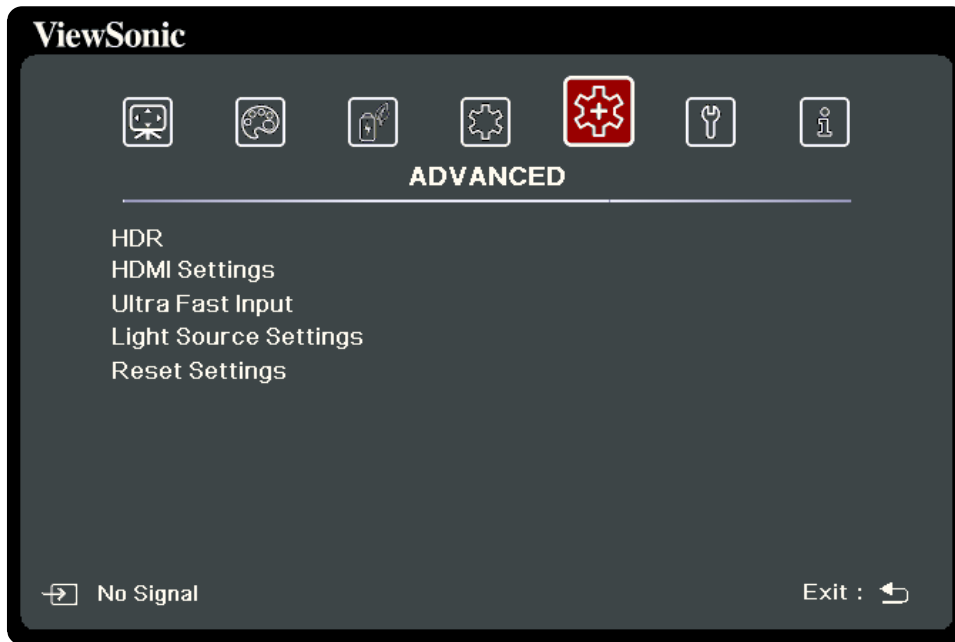

Menu	Description	
HDR	HDR/HLG	<p>Automatically detects the dynamic range of the source, and optimizes image gamma and color settings to reproduce content under a wide range of light conditions.</p> <p>Note: SDR can also be selected.</p>
	EOTF	<p>Automatically adjusts the brightness levels of the projected image according to the input source.</p> <p>Note: The default setting, Mid, is recommended. If the brightness of the projected image is too dark, use Low.</p>

Menu	Description		
HDMI Settings	HDMI Format	Auto	Sets the projector to detect the color space setting of the input signal automatically.
		RGB	Sets the color space as RGB.
		YUV	Sets the color space as YUV.
	HDMI Range	Auto	Sets the projector to detect the HDMI range of the input signal automatically.
		Enhanced	Sets the HDMI color range as 0–255.
		Normal	Sets the HDMI color range as 16–235.
Ultra Fast Input	<p>Reduces the input delay/lag to the projector.</p> <p>Note: Ultra Fast Input supports up to 240Hz at 1080p resolution and up to 60Hz at 4K resolution. This feature is automatically activated when Keystone, Corner Adj., OverScan, and Aspect Ratio are set to default.</p>		

Menu	Description		
Light Source Settings	Light Source Mode	Normal	Sets the brightness level to full.
		Eco	Reduces light source power consumption by 40% and lowers the brightness level.
		Custom	Allows you to adjust the light source power.
	Light Source Power	Only available when Light Source Mode is Custom .	
	Reset Light Source Hours	Resets the light source timer after a new light source is installed.	
	Light Source Hours Information	Light Source Usage Time	Displays the number of hours the light source has been used.
Normal			
Eco			
Custom			
Reset Settings	Returns the ADVANCED settings to their default values. Note: When selected, the following settings will remain unchanged: Language, Projector Position, High Altitude Mode, Security Settings, Corner Adj., Keystone.		

SYSTEM

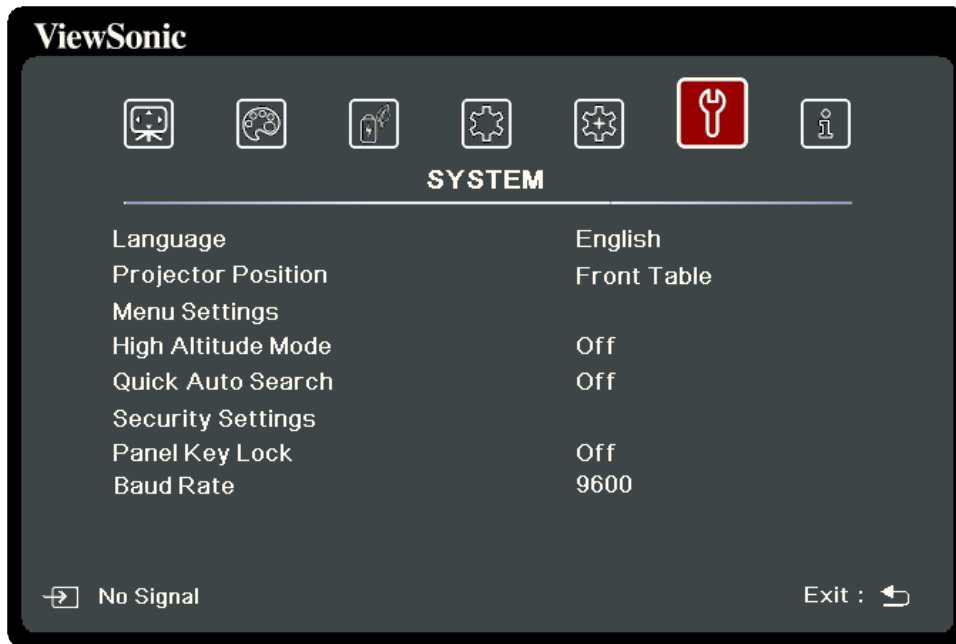

Menu	Description	
Language	Sets the language for the On-Screen Display Menu.	
Projector Position	Sets the projector position.	
Menu Settings	Menu Display Time	Sets the length of time the On-Screen Display Menu will remain active after the last interaction.
	Menu Position	Sets the On-Screen Display Menu's on-screen position.
High Altitude Mode	When turned on, the fan speed will increase for better cooling and performance. It is recommended for environments 1,501–3,000 m (4,924–9843 ft) above sea level.	
Quick Auto Search	Searches automatically for an available input signal.	
Security Settings	Prevents unauthorized access to the projector.	
Panel Key Lock	Locks the projector's keypad buttons.	
Baud Rate	Sets the baud rate to 9600 so that you can connect to the projector using a proper RS-232 cable and control the projector via RS-232 commands.	

INFORMATION

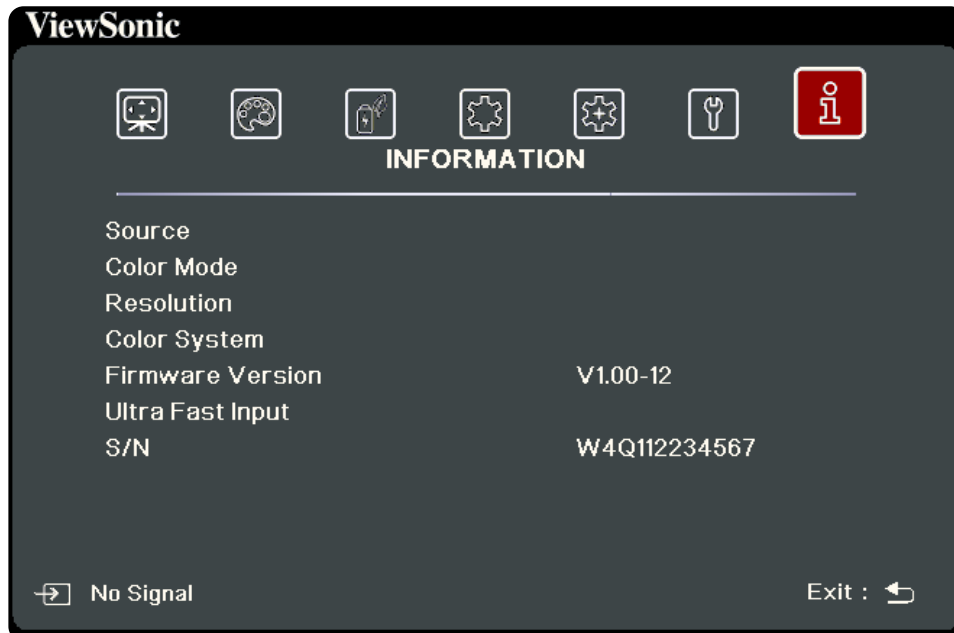

Menu	Description
Source	Shows the current input signal.
Color Mode	Shows the selected mode in the IMAGE menu.
Resolution	Shows the current resolution.
Color System	Shows input system format.
Firmware Version	Shows the current firmware version.
Ultra Fast Input	Shows whether the function is turned on or off.
S/N	Shows the projector's serial number.

Appendix

Specifications

Item	Category	Specification	
		LX720-4K/LX720-4KE/LX720-4KB/LX720-4KN/V724K	LX750-4K/LX750-4KN/LX750-4KE/LX750-4KB/V754K
Projector	Type	0.47" 4K UHD, Laser	
	Display Size	60 in.–300 in.	
	Throw Ratio	1.127~1.465 (100"±3% @ 2.49 m)	
	Light Source Type	Laser	
	Display System	1-CHIP DMD	
Input Signal	HDMI	f _n : 15–255 kHz, f _v :23–240 Hz, Maximum pixel rate: 600 MHz	
Resolution	Native	3840 x 2160	
Power	Input Voltage	AC 100-240V, 50/60 Hz (Auto Switch)	
Operating Conditions	Altitude	0 m–762 m at 0°C–40°C	
		0 ft–2,500 ft at 32°F–104°F	
		762 m–1,524 m at 0°C–35°C	
		2,500 ft–5,000 ft at 32°F–95°F	
		1,524 m–3,657.6 m at 0°C–30°C	
		5,000 ft–12,000 ft at 32°F–86°F	
	Relative Humidity	10%–90% (non-condensing)	
Temperature	0°C–40°C		
	32°F–104°F		
Storage Conditions	Altitude	0 km–12.1 km	
		0 ft–40,000 ft	
	Relative Humidity	10%–90% (non-condensing)	
	Temperature	-20°C–60°C	
-4°F–140°F			
Dimensions	Physical (W x H x D)	312 mm x 104 mm x 234 mm	
		12.3 in. x 4.1 in. x 9.2 in.	
Weight	Physical	3.5 kg	
		7.72 lb	
Power Consumption	On ¹	143W (Typical)	173W (Typical)
	Off	< 0.5W (Standby)	



The terms HDMI, HDMI High-Definition Multimedia Interface, HDMI Trade dress and the HDMI Logos are trademarks or registered trademarks of HDMI Licensing Administrator, Inc.

¹ – The test conditions follow EEI standards.

Projector Dimensions

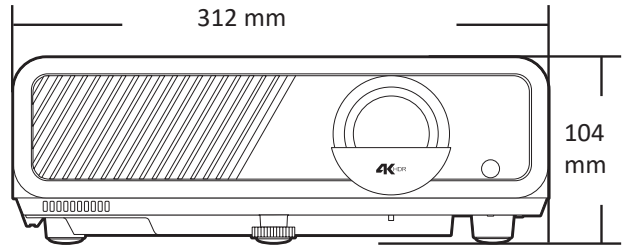
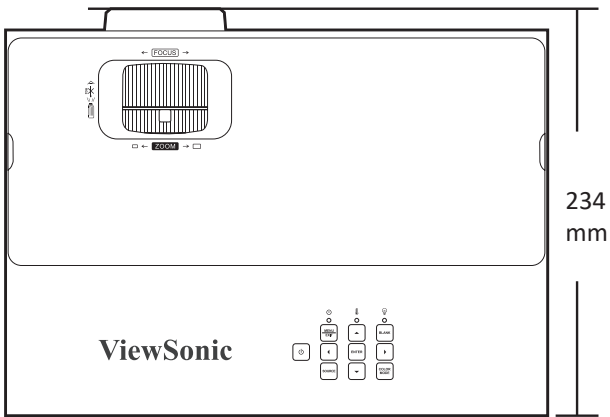

On-Screen Display Menu Tree

Main Menu	Sub-menu	Menu Option	
DISPLAY	Aspect Ratio	Auto	
		4:3	
		16:9	
		16:10	
		2.35:1	
		Native	
	Keystone	Vertical	+40~-40
		Horizontal	+40~-40
		Rotation	+40~-40
	Corner Adj.	Top-Right	45 degrees
			90 degrees
		Top-Left	45 degrees
			90 degrees
		Bottom-Right	45 degrees
			90 degrees
	Bottom-Left	45 degrees	
		90 degrees	
	OverScan	Off	
		1	
		2	
		3	
4			
5			

Main Menu	Sub-menu	Menu Option		
IMAGE	Color Mode	Brightest		
		TV		
		Gaming		
		Movie		
		Golf		
		Low Blue Light		
		User		
	Brightness	(0–100)		
	Contrast	(-50–50)		
	Color Temp.	9300K		
		7500K		
		6500K		
		Red Gain		(0–100)
		Green Gain		(0–100)
		Blue Gain		(0–100)
		Red Offset		(-50–50)
		Green Offset		(-50–50)
	Blue Offset	(-50–50)		
	Advanced	Sharpness		(0–31)
		Gamma		1.8
				2.2
				2.35
				2.5
				Cubic
		Color Management		Primary Color
				Hue
				Saturation
Gain				
Reset Color Settings	Reset			
	Cancel			

Main Menu	Sub-menu	Menu Option	
POWER MANAGEMENT	Auto Power On	Signal	Disable
			Enable
		CEC	Disable
			Enable
		Direct Power On	Disable
			Enable
	Smart Energy	Auto Power Off	Disable
			10 min
			20 min
			30 min
		Sleep Timer	Disable
			30 min
			1 hr
			2 hr
			3 hr
			4 hr
			8 hr
12 hr			
Power Saving	Disable		
	Enable		
Power On Source	Disable		
	HDMI 1		
	HDMI 2		
BASIC	Audio Settings	Audio Mode	Music
			Speech
			Movie
		Mute	On
			Off
		Audio Volume	(0–20)
		Power On/Off Ring Tone	On
			Off
		Audio Out	Internal Speaker
			Audio Out
HDMI ARC			

Main Menu	Sub-menu	Menu Option	
BASIC	Presentation Timer	Timer Period	(1–240 min)
		Timer Display	Always
			1 min
			2 min
			3 min
			Never
		Timer Position	Top-Left
			Bottom-Left
			Top-Right
			Bottom-Right
		Timer Counting Direction	Count Down
			Count Up
		Sound Reminder	On
			Off
	Start Counting		
		Off	
	Blank Timer	Disable	
		5 min	
		10 min	
		15 min	
		20 min	
		25 min	
		30 min	
	Message	On	
		Off	
	Splash Screen	Black	
		Blue	
ViewSonic			

Main Menu	Sub-menu	Menu Option	
ADVANCED	HDR	HDR/HLG	Auto
			SDR
		EOTF	Low
			Mid
			High
		HDMI Settings	HDMI Format
	RGB		
	YUV		
	HDMI Range		Auto
			Enhanced
			Normal
	Ultra Fast Input	Inactive	
		Active	
	Light Source Settings	Light Source Mode	Normal
			Eco
			Custom
		Light Source Power	40%–100%
		Reset Light Source Hours	
		Light Source Hours Information	Light Source Usage Time
			Normal
			Eco
	Custom		
	Reset Settings	Reset	
Cancel			

Main Menu	Sub-menu	Menu Option		
SYSTEM	Language	Multi-language OSD Selection		
	Projector Position	Front Table		
		Rear Table		
		Rear Ceiling		
		Front Ceiling		
	Menu Settings	Menu Display Time	5 sec	
			10 sec	
			15 sec	
			20 sec	
			25 sec	
			30 sec	
		Menu Position	Center	
			Top-Left	
			Top-Right	
			Bottom-Left	
	Bottom-Right			
	High Altitude Mode	On		
		Off		
	Quick Auto Search	On		
		Off		
	Security Settings	Change Password		
Power On Lock		On		
	Off			
Panel Key Lock	On			
	Off			
Baud Rate	9600			
INFORMATION	Source			
	Color Mode			
	Resolution			
	Color System			
	Firmware Version			
	Ultra Fast Input			
	S/N			

Supported Resolutions and Timings

HDMI

PC Signal

Signal	Aspect Ratio	Resolution	Refresh Rate
VGA	4:3	640 x 480	60, 72, 75 Hz
SVGA	4:3	800 x 600	60, 72, 75, 120 Hz
XGA	4:3	1024 x 768	60, 72, 75, 120 Hz
	4:3	1152 x 864	75 Hz
HD	16:9	1280x 720	60, 120 Hz
WXGA	15:9	1280 x 768	60 Hz
	16:10	1280 x 800	60, 75, 120 Hz
	16:9	1366 x 768	60 Hz
Quad-VGA	4:3	1280 x 960	60 Hz
SXGA	5:4	1280 x 1024	60, 75 Hz
SXGA+	4:3	1400 x 1050	60 Hz
WXGA+	16:10	1440 x 900	60 Hz
UXGA	4:3	1600 x 1200	60 Hz
WSXGA+	16:10	1680 x 1050	60 Hz
WUXGA	16:10	1920 x 1200	60 Hz
MAC 19"	4:3	1024 x 768	75 Hz
HDTV (1080p)	16:9	1920 x 1080	60, 120, 240 Hz
	21:9	2560 x 1080	60 Hz
	16:9	2560 x 1440	60, 120 Hz
4K UHD	16:9	3840 x 2160	30, 60 Hz

Video Signal

Signal	Aspect Ratio	Resolution	Refresh Rate
SDTV (480p)	4:3/16:9	720 x 480	60 Hz
SDTV (576p)	4:3/16:9	720 x 576	50 Hz
HDTV (720p)	16:9	1280 x 720	50, 60 Hz
HDTV (1080p)	16:9	1920 x 1080	24, 50, 60, 120, 240 Hz
HDTV (4K)	16:9	3840 x 2160	24, 25, 30, 50, 60 Hz

Troubleshooting

Projector does not turn on

Troubleshooting Checks	Yes/No	Possible Solutions
Is the Power Indicator lit?	Yes	Turn the projector off, then turn it back on.
	No	Check the power connection between the projector and the power outlet.
Is the power cord plugged into a power outlet?	Yes	Try another Power outlet or use some other electrical device to confirm the same power outlet is working.
	No	Plug the power cord into a power outlet and press the Power button on the projector's keypad or remote control.

No image appears

Troubleshooting Checks	Yes/No	Possible Solutions
Is your PC/video device turned on or in sleep mode?	Yes	Check the cable connection between your PC/video device and the projector.
	No	Turn your PC/video device on or wake it up from sleep mode. If in any doubts, consult your PC/video device's documentation.
Is the image input selected correctly?	Yes	Turn the projector off, then turn it back on.
	No	Select the correct input source. If multiple devices are connected, manually adjust the input source by pressing the Source Input button on the projector's keypad or remote control.

Image is flipped upside down or mirrored left to right

Troubleshooting Checks	Yes/No	Possible Solutions
Is the projector hung from the ceiling?	Yes	Check the Front Ceiling/Rear Ceiling option.
	No	Turn the projector off, then turn it back on.
Is the projector placed on a desk/floor?	Yes	Check the Front Table/Rear Table option.
	No	Turn the projector off, then turn it back on.

Image is blurred

Troubleshooting Checks	Yes/No	Possible Solutions
Is the lens dirty?	Yes	Follow the procedure in the "Maintenance" section to clean the lens.
	No	Adjust the Focus Ring until the image is clear.

Image is not displayed correctly

Troubleshooting Checks	Yes/No	Possible Solutions
Is the image cut off, or not fitting on the screen?	Yes	Press the Zoom In/Zoom Out button on the remote control to return to the original image size. If the image is still not displayed correctly, reset the IMAGE settings.
	No	Reset the IMAGE settings.

Remote control does not work

Troubleshooting Checks	Yes/No	Possible Solutions
Are there any obstacles between the remote control and projector?	Yes	Remove the obstacle(s).
	No	Aim the remote control at the projector's IR receiver within the effective distance and angles when performing an operation. Related sections: <ul style="list-style-type: none"> • "Receiver Range"
Are the batteries installed correctly?	Yes	If the remote control still does not work, try another set of new batteries to confirm the current batteries have power.
	No	Install the batteries again. Related sections: <ul style="list-style-type: none"> • "Installing the Batteries"



Important

If a problem is still not solved or not listed here, follow the steps below to restart your projector.

1. Press the **Power** button on the projector's keypad or remote control to turn it off.
2. Unplug the power cord from the power outlet and wait for at least five minutes.
3. Plug the power cord back in.
4. Press the **Power** button to turn on the projector.

If normal operation does not resume after the projector restarts, contact your reseller or service center for assistance.

LED Indicators

Status and Description			
Normal Standby (> 0.5W)	Flashing Green (quick)	Off	Off
Power On (Warming)	Steady Green	Off	Steady Green
Power Off (Cooling)	Flashing Green	Off	Off
Light Source Error	Off	Off	Steady Red
Fan Error	Off or Flashing Red	Steady Red or Flashing Red	Off, Steady Red, Steady Green or Steady Orange
Temperature Error	Steady Orange	Red	Steady Red or Steady Green

Note: If normal operation does not resume, contact your reseller or service center for assistance.

Maintenance

General Precautions

- Before performing any maintenance, turn off the projector and unplug the power cord from the outlet.
- Do not spray or pour liquid directly onto the projector.
- Handle the projector with care, as scratches may be more visible on dark-colored models.

Cleaning the Lens

- Use an air blower to remove dust.
- Use lens-cleaning paper or a soft, moist cloth with lens cleaner to gently wipe away smudges from the lenses.

Important: Do not use abrasive materials or glass cleaner to clean the lens.

Cleaning the Case

- Clean with a soft, dry cloth.
- If the case is still not clean, apply a small amount of non-ammonia, non-alcohol based, mild non-abrasive detergent onto a clean, soft, lint-free cloth; then wipe the surface.

Important: Do not use wax, alcohol, benzene, thinner, or other chemical detergents for cleaning.

Storing the Projector

If the projector will not be used for an extended period of time, observe the following:

- Retract the adjustable foot completely.
- Remove the batteries from the remote control.
- Pack the projector in its original packaging.
- Store the projector in a location that falls within the projector's storage conditions.

Disclaimer

- ViewSonic® does not recommend the use of any ammonia or alcohol-based cleaners on the lens or case. Some chemical cleaners have been reported to damage the lens and/or case of the projector.
- ViewSonic® will not be liable for damage resulting from use of any ammonia or alcohol-based cleaners.

Regulatory and Service Information

Compliance Information

This section addresses all connected requirements and statements regarding regulations. Confirmed corresponding applications shall refer to nameplate labels and relevant markings on the unit.

FCC Compliance Statement

This device complies with part 15 of FCC Rules. Operation is subject to the following two conditions: (1) this device may not cause harmful interference, and (2) this device must accept any interference received, including interference that may cause undesired operation. This equipment has been tested and found to comply with the limits for a Class B digital device, pursuant to part 15 of the FCC Rules.

These limits are designed to provide reasonable protection against harmful interference in a residential installation. This equipment generates, uses, and can radiate radio frequency energy, and if not installed and used in accordance with the instructions, may cause harmful interference to radio communications. However, there is no guarantee that interference will not occur in a particular installation. If this equipment does cause harmful interference to radio or television reception, which can be determined by turning the equipment off and on, the user is encouraged to try to correct the interference by one or more of the following measures:

- Reorient or relocate the receiving antenna.
- Increase the separation between the equipment and receiver.
- Connect the equipment into an outlet on a circuit different from that to which the receiver is connected.
- Consult the dealer or an experienced radio/TV technician for help.

Warning: You are cautioned that changes or modifications not expressly approved by the party responsible for compliance could void your authority to operate the equipment.

FCC Radiation Exposure Statement

This equipment complies with FCC radiation exposure limits set forth for an uncontrolled environment. End users must follow the specific operating instructions for satisfying RF exposure compliance.

This transmitter must not be co-located or operating in conjunction with any other antenna or transmitter. This equipment should be installed and operated with a minimum distance of 20 centimeters between the radiator and your body.

The users manual or instruction manual for an intentional or unintentional radiator shall caution the user that changes or modifications not expressly approved by the party responsible for compliance could void the user's authority to operate the equipment.

Industry Canada Statement

This Class B digital apparatus complies with Canadian ICES-003.

Cet appareil numérique de classe B est conforme à la norme NMB-003 du Canada.

CAN ICES (B) / NMB (B)

IC Warning Statement

This device complies with Industry Canada licence-exempt RSS standard(s). Operation is subject to the following two conditions: (1) This device may not cause interference, and (2) This device must accept any interference, including interference that may cause undesired operation of the device.

Le présent appareil est conforme aux CNR d'Industrie Canada applicables aux appareils radio exempts de licence. L'exploitation est autorisée aux deux conditions suivantes : (1) l'appareil ne doit pas produire de brouillage, et (2) l'utilisateur de l'appareil doit accepter tout brouillage radioélectrique subi, même si le brouillage est susceptible d'en compromettre le fonctionnement.

Country Code Statement

For product available in the USA/Canada market, only channel 1~11 can be operated. Selection of other channels is not possible.

Pour les produits disponibles aux États-Unis/Canada du marché, seul le canal 1 à 11 peuvent être exploités. Sélection d'autres canaux n'est pas possible.

IC Radiation Exposure Statement

This equipment complied with IC RSS-102 radiation exposure limits set forth for an uncontrolled environment. This equipment should be installed and operated with minimum distance 20cm between the radiator & your body. The device for the band 5150-5825 MHz is only for indoor usage to reduce potential for harmful interference to co-channel mobile satellite systems.

Cet équipement est conforme aux limites d'exposition aux rayonnements IC établies pour un environnement non contrôlé. Cet équipement doit être installé et utilisé avec un minimum de 20cm de distance entre la source de rayonnement et votre corps. Les dispositifs fonctionnant dans la bande 5150-5825 MHz sont réservés uniquement pour une utilisation à l'intérieur afin de réduire les risques de brouillage.

Operation in the band 5150-5250 MHz is only for indoor use to reduce the potential for harmful interference to co-channel mobile satellite systems.

La bande 5 150-5 250 MHz est réservés uniquement pour une utilisation à l'intérieur afin de réduire les risques de brouillage préjudiciable aux systèmes de satellites mobiles utilisant les mêmes canaux.

CE Conformity for European Countries



The device complies with the EMC Directive 2014/30/EU and Low Voltage Directive 2014/35/EU. Ecodesign Directive 2009/125/EC and Radio Equipment Directive 2014/53/EU.

Frequency Range: 2400-2483.5 MHz, 5150-5250 MHz

Max Output Power: under 20dBm

The following information is only for EU-member states:

The mark shown to the right is in compliance with the Waste Electrical and Electronic Equipment Directive 2012/19/EU (WEEE). The mark indicates the requirement NOT to dispose of the equipment as unsorted municipal waste, but use the return and collection systems according to local law.



Declaration of RoHS2 Compliance

This product has been designed and manufactured in compliance with Directive 2011/65/EU of the European Parliament and the Council on restriction of the use of certain hazardous substances in electrical and electronic equipment (RoHS2 Directive) and is deemed to comply with the maximum concentration values issued by the European Technical Adaptation Committee (TAC) as shown below:

Substance	Proposed Maximum Concentration	Actual Concentration
Lead (Pb)	0.1%	< 0.1%
Mercury (Hg)	0.1%	< 0.1%
Cadmium (Cd)	0.01%	< 0.01%
Hexavalent Chromium (Cr6 ⁺)	0.1%	< 0.1%
Polybrominated biphenyls (PBB)	0.1%	< 0.1%
Polybrominated diphenyl ethers (PBDE)	0.1%	< 0.1%
Bis (2-ethylhexyl) phthalate (DEHP)	0.1%	< 0.1%
Butyl benzyl phthalate (BBP)	0.1%	< 0.1%
Dibutyl phthalate (DBP)	0.1%	< 0.1%
Diisobutyl phthalate (DIBP)	0.1%	< 0.1%

Certain components of products as stated above are exempted under the Annex III of the RoHS2 Directives as noted below. Examples of exempted components are:

- Mercury in cold cathode fluorescent lamps and external electrode fluorescent lamps (CCFL and EEFL) for special purposes not exceeding (per lamp):
 - » Short length (500 mm): maximum 3.5 mg per lamp.
 - » Medium length (> 500 mm and 1,500 mm): maximum 5 mg per lamp.
 - » Long length (> 1,500 mm): maximum 13 mg per lamp.
- Lead in glass of cathode ray tubes.
- Lead in glass of fluorescent tubes not exceeding 0.2% by weight.
- Lead as an alloying element in aluminum containing up to 0.4% lead by weight.
- Copper alloy containing up to 4% lead by weight.
- Lead in high melting temperature type solders (i.e. lead-based alloys containing 85% by weight or more lead).
- Electrical and electronic components containing lead in a glass or ceramic other than dielectric ceramic in capacitors, e.g. piezoelectronic devices, or in a glass or ceramic matrix compound.

Indian Restriction of Hazardous Substances

Restriction on Hazardous Substances statement (India). This product complies with the “India E-waste Rule 2011” and prohibits use of lead, mercury, hexavalent chromium, polybrominated biphenyls or polybrominated diphenyl ethers in concentrations exceeding 0.1 weight % and 0.01 weight % for cadmium, except for the exemptions set in Schedule 2 of the Rule.

Product Disposal at End of Product Life

ViewSonic® respects the environment and is committed to working and living green. Thank you for being part of Smarter, Greener Computing. Please visit the ViewSonic® website to learn more.

USA & Canada:

<https://www.viewsonic.com/us/go-green-with-viewsonic>

Europe:

<https://www.viewsonic.com/eu/environmental-social-governance/recycle>

Taiwan:

<https://recycle.moenv.gov.tw/>

For EU users, please contact us for any safety/accident issue experienced with this product:

ViewSonic Europe Limited

 Flevolaan 38, 1382JZ, Weesp,
the Netherlands

 +31 08000232999

 EPREL@viewsoniceurope.com

 <https://www.viewsonic.com/eu/>

Copyright Information

Copyright© ViewSonic® Corporation, 2025. All rights reserved.

Macintosh and Power Macintosh are registered trademarks of Apple Inc.

Microsoft, Windows, and the Windows logo are registered trademarks of Microsoft Corporation in the United States and other countries.

ViewSonic® and the three birds logo are registered trademarks of ViewSonic® Corporation.

VESA is a registered trademark of the Video Electronics Standards Association. DPMS, DisplayPort, and DDC are trademarks of VESA.

ENERGY STAR® is a registered trademark of the U.S. Environmental Protection Agency (EPA).

As an ENERGY STAR® partner, ViewSonic® Corporation has determined that this product meets the ENERGY STAR® guidelines for energy efficiency.

Disclaimer: ViewSonic® Corporation shall not be liable for technical or editorial errors or omissions contained herein; nor for incidental or consequential damages resulting from furnishing this material, or the performance or use of this product.

In the interest of continuing product improvement, ViewSonic® Corporation reserves the right to change product specifications without notice. Information in this document may change without notice.

No part of this document may be copied, reproduced, or transmitted by any means, for any purpose without prior written permission from ViewSonic® Corporation.

Customer Service

For technical support or product service, see the table below or contact your reseller.

Note: You will need the product's serial number.

Country/ Region	Website	Country/ Region	Website
Asia Pacific & Africa			
Australia	www.viewsonic.com/au/	Bangladesh	www.viewsonic.com/bd/
中国 (China)	www.viewsonic.com.cn	香港 (繁體中文)	www.viewsonic.com/hk/
Hong Kong (English)	www.viewsonic.com/hk-en/	India	www.viewsonic.com/in/
Indonesia	www.viewsonic.com/id/	Israel	www.viewsonic.com/il/
日本 (Japan)	www.viewsonic.com/jp/	Korea	www.viewsonic.com/kr/
Malaysia	www.viewsonic.com/my/	Middle East	www.viewsonic.com/me/
Myanmar	www.viewsonic.com/mm/	Nepal	www.viewsonic.com/np/
New Zealand	www.viewsonic.com/nz/	Pakistan	www.viewsonic.com/pk/
Philippines	www.viewsonic.com/ph/	Singapore	www.viewsonic.com/sg/
臺灣 (Taiwan)	www.viewsonic.com/tw/	ประเทศไทย	www.viewsonic.com/th/
Việt Nam	www.viewsonic.com/vn/	South Africa & Mauritius	www.viewsonic.com/za/
Americas			
United States	www.viewsonic.com/us	Canada	www.viewsonic.com/us
Latin America	www.viewsonic.com/la		
Europe			
Europe	www.viewsonic.com/eu/	France	www.viewsonic.com/fr/
Deutschland	www.viewsonic.com/de/	Қазақстан	www.viewsonic.com/kz/
Россия	www.viewsonic.com/ru/	España	www.viewsonic.com/es/
Türkiye	www.viewsonic.com/tr/	Україна	www.viewsonic.com/ua/
United Kingdom	www.viewsonic.com/uk/		

Limited Warranty

ViewSonic® Projector

What the warranty covers:

ViewSonic® warrants its products to be free from defects in material and workmanship, under normal use, during the warranty period. If a product proves to be defective in material or workmanship during the warranty period, ViewSonic® will, at its sole option, repair or replace the product with a like product. Replacement product or parts may include remanufactured or refurbished parts or components.

Limited Three (3) year General Warranty:

Subject to the more limited one (1) year warranty set out below, North and South America: Three (3) years warranty for all parts excluding the lamp, three (3) years for labor, and one (1) year for the original lamp from the date of the first consumer purchase.

Other regions or countries: Please check with your local dealer or local ViewSonic® office for the warranty information.

Limited One (1) year Heavy Usage Warranty:

Under heavy usage settings, where a projector's use includes more than fourteen (14) hours average daily usage, North and South America: One (1) year warranty for all parts excluding the lamp, one (1) year for labor, and ninety (90) days for the original lamp from the date of the first consumer purchase; Europe: One (1) year warranty for all parts excluding the lamp, one (1) year for labor, and ninety (90) days for the original lamp from the date of the first consumer purchase. Other regions or countries: Please check with your local dealer or local ViewSonic® office for the warranty information. Lamp warranty subject to terms and conditions, verification and approval. Applies to manufacturer's installed lamp only. All accessory lamps purchased separately are warranted for 90 days.

Who the warranty protects:

This warranty is valid only for the first consumer purchaser.

What the warranty does not cover:

1. Any product on which the serial number has been defaced, modified, or removed.
2. Damage, deterioration, or malfunction resulting from:
 - » Accident, misuse, neglect, fire, water, lightning, or other acts of nature, unauthorized product modification, or failure to follow instructions supplied with the product.
 - » Operation outside of product specifications.
 - » Operation of the product for other than the normal intended use or not under normal conditions.
 - » Repair or attempted repair by anyone not authorized by ViewSonic®.
 - » Any damage of the product due to shipment.
 - » Removal or installation of the product.
 - » Causes external to the product, such as electric power fluctuations or failure.
 - » Use of supplies or parts not meeting Viewsonic's specifications.
 - » Normal wear and tear.
 - » Any other cause which does not relate to a product defect.
3. Removal, installation, and set-up service charges.

How to get service:

1. For information about receiving service under warranty, contact ViewSonic® Customer Support (Please refer to the "Customer Support" page). You will need to provide your product's serial number.
2. To obtain warranted service, you will be required to provide: (a) the original dated sales slip, (b) your name, (c) your address, (d) a description of the problem, and (e) the serial number of the product.
3. Take or ship the product, freight prepaid, in the original container to an authorized ViewSonic® service center or ViewSonic®.
4. For additional information or the name of the nearest ViewSonic® service center, contact ViewSonic®.
5. If any network security vulnerabilities are identified, an upgrade service will be provided. Users will be notified via the official website to visit an authorized service center or return the unit for an upgrade.

Limitation of implied warranties:

There are no warranties, express or implied, which extend beyond the description contained herein including the implied warranty of merchantability and fitness for a particular purpose.

Exclusion of damages:

ViewSonic's liability is limited to the cost of repair or replacement of the product. ViewSonic® shall not be liable for:

1. Damage to other property caused by any defects in the product, damages based upon inconvenience, loss of use of the product, loss of time, loss of profits, loss of business opportunity, loss of goodwill, interference with business relationships, or other commercial loss, even if advised of the possibility of such damages.
2. Any other damages, whether incidental, consequential or otherwise.
3. Any claim against the customer by any other party.

Effect of state law:

This warranty gives you specific legal rights, and you may also have other rights which vary from local authority. Some local governments do not allow limitations on implied warranties and/or do not allow the exclusion of incidental or consequential damages, so the above limitations and exclusions may not apply to you.

Sales outside the U.S.A. and Canada:

For warranty information and service on ViewSonic® products sold outside of the U.S.A. and Canada, contact ViewSonic® or your local ViewSonic® dealer.

The warranty period for this product in mainland China (Hong Kong, Macao, and Taiwan Excluded) is subject to the terms and conditions of the Maintenance Guarantee Card.

For users in Europe and Russia, full details of warranty provided can be found at: <http://www.viewsonic.com/eu/> under "Support/Warranty Information".

Mexico Limited Warranty

ViewSonic® Projector

What the warranty covers:

ViewSonic® warrants its products to be free from defects in material and workmanship, under normal use, during the warranty period. If a product proves to be defective in material or workmanship during the warranty period, ViewSonic® will, at its sole option, repair or replace the product with a like product. Replacement product or parts may include remanufactured or refurbished parts or components & accessories.

How long the warranty is effective:

3 years for all parts excluding the lamp, 3 years for labor, 1 year for the original lamp from the date of the first consumer purchase.

Lamp warranty subject to terms and conditions, verification and approval. Applies to manufacturer's installed lamp only.

All accessory lamps purchased separately are warranted for 90 days.

Who the warranty protects:

This warranty is valid only for the first consumer purchaser.

What the warranty excludes and does not cover:

1. Any product on which the serial number has been defaced, modified or removed.
2. Damage, deterioration, or malfunction resulting from:
 - » Accident, misuse, neglect, fire, water, lightning, or other acts of nature, unauthorized product modification, unauthorized attempted repair, or failure to follow instructions supplied with the product.
 - » Any damage of the product due to shipment.
 - » Causes external to the product, such as electrical power fluctuations or failure.
 - » Use of supplies or parts not meeting ViewSonic®'s specifications.
 - » Normal wear and tear.
 - » Any other cause which does not relate to a product defect.
3. Any product exhibiting a condition commonly known as "image burn-in" which results when a static image is displayed on the product for an extended period of time.
4. Removal, installation, insurance, and set-up service charges.

How to get service:

For information about receiving service under warranty, contact ViewSonic® Customer Support (Please refer to the attached “Customer Service” page). You will need to provide your product’s serial number, so please record the product information in the space provided below on your purchase for your future use. Please retain your receipt of proof of purchase to support your warranty claim.

For Your Records

Product Name: _____ Model Number: _____

Document Number: _____ Serial Number: _____

Purchase Date: _____ Extended Warranty Purchase? _____ (Y/N)

If so, what date does warranty expire? _____

1. To obtain warranty service, you will be required to provide (a) the original dated sales slip, (b) your name, (c) your address, (d) a description of the problem, and (e) the serial number of the product.
2. Take or ship the product, in the original container packaging, to an authorized ViewSonic® service center.
3. Round trip transportation costs for in-warranty products will be paid by ViewSonic®.

Limitation of implied warranties:

There are no warranties, express or implied, which extend beyond the description contained herein including the implied warranty of merchantability and fitness for a particular purpose.

Exclusion of damages:

ViewSonic®’s liability is limited to the cost of repair or replacement of the product. ViewSonic® shall not be liable for:

1. Damage to other property caused by any defects in the product, damages based upon inconvenience, loss of use of the product, loss of time, loss of profits, loss of business opportunity, loss of goodwill, interference with business relationships, or other commercial loss, even if advised of the possibility of such damages.
2. Any other damages, whether incidental, consequential or otherwise.
3. Any claim against the customer by any other party.
4. Repair or attempted repair by anyone not authorized by ViewSonic®.

Contact Information for Sales & Authorized Service (Centro Autorizado de Servicio) within Mexico:	
Name, address, of manufacturer and importers: México, Av. de la Palma #8 Piso 2 Despacho 203, Corporativo Interpalmas, Col. San Fernando Huixquilucan, Estado de México Tel: (55) 3605-1099 http://www.viewsonic.com/la/soporte/index.htm	
NÚMERO GRATIS DE ASISTENCIA TÉCNICA PARA TODO MÉXICO: 001.866.823.2004	
Hermosillo: Distribuciones y Servicios Computacionales SA de CV. Calle Juarez 284 local 2 Col. Bugambilias C.P: 83140 Tel: 01-66-22-14-9005 E-Mail: disc2@hmo.megared.net.mx	Villahermosa: Compumantenimientos Garantizados, S.A. de C.V. AV. GREGORIO MENDEZ #1504 COL, FLORIDA C.P. 86040 Tel: 01 (993) 3 52 00 47 / 3522074 / 3 52 20 09 E-Mail: compumantenimientos@prodigy.net.mx
Puebla, Pue. (Matriz): RENTA Y DATOS, S.A. DE C.V. Domicilio: 29 SUR 721 COL. LA PAZ 72160 PUEBLA, PUE. Tel: 01(52).222.891.55.77 CON 10 LINEAS E-Mail: datos@puebla.megared.net.mx	Veracruz, Ver.: CONEXION Y DESARROLLO, S.A DE C.V. Av. Americas # 419 ENTRE PINZÓN Y ALVARADO Fracc. Reforma C.P. 91919 Tel: 01-22-91-00-31-67 E-Mail: gacosta@qplus.com.mx
Chihuahua: Soluciones Globales en Computación C. Magisterio # 3321 Col. Magisterial Chihuahua, Chih. Tel: 4136954 E-Mail: Cefeo@soluglobales.com	Cuernavaca: Compusupport de Cuernavaca SA de CV Francisco Leyva # 178 Col. Miguel Hidalgo C.P. 62040, Cuernavaca Morelos Tel: 01 777 3180579 / 01 777 3124014 E-Mail: aquevedo@compusupportcva.com
Distrito Federal: QPLUS, S.A. de C.V. Av. Coyoacán 931 Col. Del Valle 03100, México, D.F. Tel: 01(52)55-50-00-27-35 E-Mail : gacosta@qplus.com.mx	Guadalajara, Jal.: SERVICRECE, S.A. de C.V. Av. Niños Héroes # 2281 Col. Arcos Sur, Sector Juárez 44170, Guadalajara, Jalisco Tel: 01(52)33-36-15-15-43 E-Mail: mmiranda@servicrece.com
Guerrero Acapulco: GS Computación (Grupo Sesicomp) Progreso #6-A, Colo Centro 39300 Acapulco, Guerrero Tel: 744-48-32627	Monterrey: Global Product Services Mar Caribe # 1987, Esquina con Golfo Pérsico Fracc. Bernardo Reyes, CP 64280 Monterrey N.L. México Tel: 8129-5103 E-Mail: aydeem@gps1.com.mx
MERIDA: ELECTROSER Av Reforma No. 403Gx39 y 41 Mérida, Yucatán, México CP97000 Tel: (52) 999-925-1916 E-Mail: rrrb@sureste.com	Oaxaca, Oax.: CENTRO DE DISTRIBUCION Y SERVICIO, S.A. de C.V. Murguía # 708 P.A., Col. Centro, 68000, Oaxaca Tel: 01(52)95-15-15-22-22 Fax: 01(52)95-15-13-67-00 E-Mail: gpotai2001@hotmail.com
Tijuana: STD Av Ferrocarril Sonora #3780 L-C Col 20 de Noviembr Tijuana, Mexico	FOR USA SUPPORT: ViewSonic® Corporation 381 Brea Canyon Road, Walnut, CA. 91789 USA Tel: 800-688-6688 E-Mail: http://www.viewsonic.com



ViewSonic®