

EVNIA

27M2N3500PF



EN

User manual

Register your product and get support at www.philips.com/welcome

PHILIPS

Table of Contents

1. Important	1
1.1 Safety precautions and maintenance	1
1.2 Notational Descriptions	3
1.3 Disposal of product and packing material	4
2. Setting up the monitor	5
2.1 Installation	5
2.2 Operating the monitor	6
2.3 Remove the Base Assembly for VESA Mounting	11
3. Image Optimization	12
3.1 SmartImage	12
3.2 SmartContrast	14
3.3 Customize color space	15
4. NVIDIA® G-SYNC® Compatible	16
5. HDR	17
6. Technical Specifications	18
6.1 Resolution & Preset Modes	21
7. Power Management	23
8. Customer care and warranty	24
8.1 Philips' Flat Panel Monitors Pixel Defect Policy	24
8.2 Customer Care & Warranty	27
9. Troubleshooting & FAQs	28
9.1 Troubleshooting	28
9.2 General FAQs	29

1. Important

This electronic user's guide is intended for anyone who uses the Philips monitor. Take time to read this user manual before you use your monitor. It contains important information and notes regarding the operation of your monitor.

The Philips guarantee applies provided that the product is handled for its intended use, by its operating instructions, and accompanied by the presentation of the original invoice or cash receipt that indicates the date of purchase, dealer's name and model, and production number of the product.

1.1 Safety precautions and maintenance

Warnings

The use of controls, adjustments, or procedures other than those specified in this document may result in exposure to shock, electrical hazards, and/or mechanical hazards.

Read and follow these instructions when connecting and using your monitor.

Excessive sound pressure from earphones and headphones can cause hearing loss. Adjustment of the equalizer to maximum capacity increases the earphones and headphones output voltage; thereby increasing the sound pressure level.

Operation

- Please keep the monitor out of direct sunlight. Lengthy exposure to this type of environment may result in discoloration and damage to the monitor.
- Keep the display away from oil. Oil may damage the plastic cover of the display and void the warranty.
- Remove any object that could fall into ventilation holes or prevent proper cooling of the monitor's electronics.
- Do not block the ventilation holes in the cabinet.
- When positioning the monitor, make sure the power plug and outlet are easily accessible.
- If turning off the monitor by detaching the power cable or DC power cord, wait for 6 seconds before attaching the power cable or DC power cord before returning to normal operation.
- Please use the approved power cord provided by Philips all the times. If your power cord is missing, please contact your local service center. (Please refer to the Service contact information located in the Important information manual.)
- Operate under the specified power supply. Use of incorrect voltage will cause malfunction and may cause fire or electric shock.
- Do not disassemble the AC adapter. Disassembling the AC adapter may expose you to the danger of fire or electric shock.
- Protect the cable. Do not pull or bend the power cable and signal cable. Do not place the monitor or any other heavy objects on the cables. If damaged, the cables may cause fire or electric shock.
- Do not subject the monitor to severe vibration or high-impact conditions during operation.
- To avoid potential damage, like the panel peeling from the bezel, ensure that the monitor does not tilt

downward by more than -5 degrees. If the -5 degree downward tilt angle maximum is exceeded, the monitor damage will not be covered under warranty.

- Do not knock or drop the monitor during operation and/or transportation.
- Excessive usage of the monitor can cause eye discomfort. It's recommended to take shorter breaks more often at your workstation than longer breaks and less often. For example, a 5-10 minute break after 50-60-minute continuous screen use is likely to be better than a 15-minute break every two hours. Prevent eye strain while using the screen for a constant period by :
 - Looking at something varying distances after a long period of focusing on the screen.
 - Conscious Blinking while you work.
 - Gently closing and rolling your eyes to relax.
 - Reposition your screen to the appropriate height and angle.
 - Adjust the brightness and contrast to an appropriate level.
 - Adjust the environment lighting similar to that of your screen brightness. Avoid fluorescent lighting and surfaces that don't reflect too much light.
 - Seeing a doctor if your symptoms worsen.

Maintenance

- To protect your monitor from possible damage, do not put excessive pressure on the LCD panel. When moving your monitor, grasp the frame to lift; do not lift the monitor by placing your hand or fingers on the LCD panel.

- Oil-based cleaning solutions may damage the plastic parts and void the warranty.
- Unplug the monitor if you are not going to use it for an extensive period.
- Unplug the monitor if you need to clean it with a slightly damp cloth. The screen may be wiped with a dry cloth when the power is off. However, never use organic solvents, such as alcohol or ammonia-based liquids.
- To avoid the risk of shock or permanent damage to the set, do not expose the monitor to dust, rain, water, or excessive moisture.
- If your monitor gets wet, wipe it with a dry cloth as soon as possible.
- If a foreign substance or water gets in your monitor, please turn the power off immediately and disconnect the power cord. Then, if damaged, send it to the maintenance center.
- Do not store or use the monitor in locations exposed to heat, direct sunlight, or extreme cold.
- To maintain the best performance of your monitor and use it for a longer lifetime, please use the monitor in a location that falls within the following temperature and humidity ranges:
 - Temperature: 0°C~40°C
32°F~104°F
 - Humidity: 20% RH~80% RH

Important information for Burn-in/ Ghost image

- Always activate a moving screen saver program when you leave your monitor unattended. Always activate a periodic screen refresh application if your monitor will display unchanging static content.

Uninterrupted display of still or static images over an extended period may cause “burn-in”, also known as “after-imaging” or “ghost imaging”, on your screen.

- “Burn-in”, “after-imaging”, or “ghost imaging” is a well-known phenomenon in LED panel technology. In most cases, the “burn-in”, “after-imaging” or “ghost imaging” will disappear gradually over some time after the power has been switched off.

Warning

Failure to activate a screen saver, or a periodic screen refresh application may result in severe “burn-in” or “after-image” or “ghost image” symptoms that will not disappear and cannot be repaired. The damage mentioned above is not covered under your warranty.

Service

- The casing cover should be opened only by qualified service personnel.
- If there is any need for any document for repair or integration, please contact your local service center. (You can refer to the service contact information listed in the important information manual.)
- For transportation information, please refer to “Technical Specifications”.
- Do not leave your monitor in a car under direct sunlight.

Note

Consult a service technician if the monitor does not operate normally or you are not sure what procedure to take when the operating instructions given in this manual.

1.2 Notational Descriptions

The following subsections describe the notational conventions used in this document.

Notes, Cautions, and Warnings

Throughout this guide, blocks of text may be accompanied by an icon and printed in bold or italic type. These blocks contain notes, cautions, and/or warnings.

They are used as follows:

Note

This icon indicates important information and tips that help you make better use of your computer system.

Caution

This icon indicates information that tells you how to avoid either potential damage to the hardware or loss of data.

Warning

This icon indicates the potential for bodily harm and tells you how to avoid the problem.

Some warnings may appear in alternate formats and may not be accompanied by an icon. In such cases, the specific presentation of the warning is mandated by the relevant regulatory mechanism.

1.3 Disposal of product and packing material

Waste Electrical and Electronic Equipment-WEEE



This marking on the product or its packaging illustrates that, under European Directive 2012/19/EU governing used electrical and electronic appliances, this product may not be disposed with normal household waste. You are responsible for the disposal of this equipment through a designated waste electrical and electronic equipment collection. To determine the locations for dropping off such waste, contact your local government office, the waste disposal organization that serves your household, or the store at which you purchased the product.

Your new monitor contains materials that can be recycled and reused. Specialized companies can recycle your product to increase the number of reusable materials and minimize the amount to be disposed of.

All redundant packing material has been omitted. We have done our utmost to make the packaging easily separable into mono materials.

Please find out about the local regulations on how to dispose of your old monitor and packing from your sales representative.

Taking back/Recycling Information for Customers

Philips establishes technically and economically viable objectives to optimize the environmental performance of the organization's products, services, and activities.

From the planning, design, and production stages, Philips emphasizes the importance of making products that can easily be recycled. At Philips, end-of-life management primarily entails participation in national take-back initiatives and recycling programs whenever possible, preferably in cooperation with competitors, which recycle all materials (products and related packaging material) following all Environmental Laws and taking back programs with the contractor company.

Your display is manufactured with high-quality materials and components which can be recycled and reused.

To learn more about our recycling program please visit:

<http://www.philips.com/a-w/about/sustainability.html>

2. Setting up the monitor

2.1 Installation

1 Package contents



Power



*HDMI



*DP

*Different according to region

2 Install the base

1. Place the monitor face down on a smooth surface. Pay attention not to scratch or damage the screen.

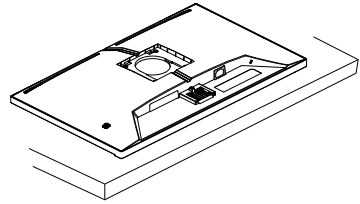

2. Hold the stand with both hands.
 - (1) Attach/Slide the base column with the monitor until it clicks into position.
 - (2) Gently attach the base to the stand.
 - (3) Use your fingers to tighten the screw located at the bottom of the base.
 - (4) Turn the TOP arrow up and 180 degrees left and right.
 - (5) Insert VESA Cover diagonally into rear cover.
 - (6) Press the VESA Cover to snap back the rear cover.

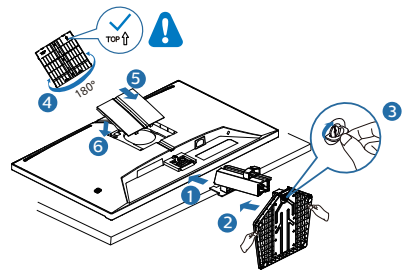

! Caution

Place the monitor face down on a smooth surface. Pay attention not to scratch or damage the screen.

3 Connecting to your PC

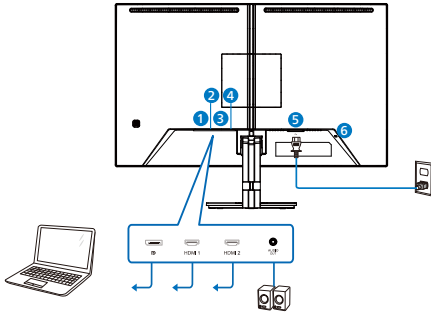

- ❶ DisplayPort input
- ❷ HDMI input 1
- ❸ HDMI input 2
- ❹ Audio Out
- ❺ AC power input
- ❻ Kensington anti-theft lock

Connect to PC

1. Connect the power cord to the back of the monitor firmly.
2. Turn off your computer and unplug its power cable.
3. Connect the monitor signal cable to the video connector on the back of your computer.
4. Plug the power cord of your computer and your monitor into a nearby outlet.
5. Turn on your computer and monitor. If the monitor displays an image, installation is complete.

2.2 Operating the monitor

1 Description of the control buttons

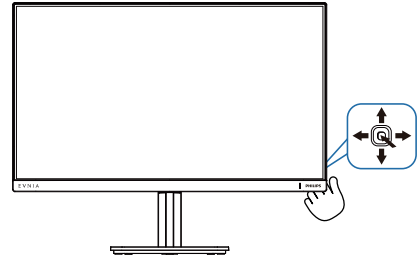

❶		Press to switch power on. Press more than 3 seconds to switch power off.
❷		Access the OSD menu. Confirm the OSD adjustment.
❸		Adjust the Game Setting. Adjust the OSD menu.
❹		Change the signal input source. Adjust the OSD menu.
❺		SmartImage Game menu. There are multiple selections: Standard, FPS, Racing, RTS, Movie, LowBlue Mode, EasyRead, Economy, SmartUniformity, Game1 and Game2. When the monitor receives HDR signal, SmartImage will show the HDR menu. There are multiple selections in this menu: HDR Game, HDR Movie, HDR Vivid, Personal, and Off.
		Return to previous OSD level.

2 Description of the On-Screen Display

What is On-Screen Display (OSD)?

On-Screen Display (OSD) is a feature in all Philips LED monitors. It allows an end user to adjust screen performance or select functions of the monitors directly through an on-screen instruction window. A user-friendly OSD interface is shown below:

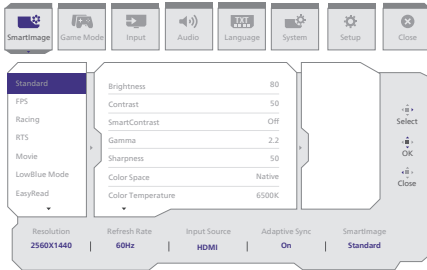

Basic and simple instructions on the control keys

To access the OSD menu on this Philips display, simply use the single toggle button located on the rear side of the display. The single button operates like a joystick. To move the cursor, simply toggle the button in four directions. Press the button to select the desired option.

The OSD Menu

Below is an overall view of the structure of the On-Screen Display. You can use this as a reference when you want to work your way around the different adjustments later on.

Main menu	Sub menu				
SmartImage	Standard, FPS, Racing, RTS, Movie, LowBlue Mode, EasyRead, Economy, SmartUniformity, Gamet, Game2	Brightness	0-100		
		Contrast	0-100		
		SmartContrast	On, Off		
		Gamma	1.8, 2.0, 2.2, 2.4, 2.6		
		Sharpness	0-100		
		Color Space	Native, sRGB, DCI-P3, Adobe RGB		
		Color Temperature	Native, Preset, 5000K, 6500K, 7500K, 8200K, 9300K, 11500K		
		R.G.B. Settings	On, Off		
		Red	0-100		
		Green	0-100		
		Blue	0-100		
		Reset	Yes, No		
		SmartImage(HDR) (HDR source)	HDR Game, HDR Movie, HDR Vivid, Personal	Brightness	0-100
				Contrast	0-100
				Light Enhancement	0-3
				Color Enhancement	0-3
				Reset	Yes, No
			Off		
		Game Mode	Adaptive Sync, Smart MBR, Smart MBR Sync, Crosshair, Stark ShadowBoost, Smart Sniper, Low Input Lag, SmartResponse, Overclock, SmartFrame	Adaptive Sync On, Adaptive Sync Off	
				MBR Level	0-20
Smart MBR Sync On, Smart MBR Sync Off					
Off, On, Smart Crosshair On					
Off, Level 1, Level 2, Level 3					
Size	Off, 1.0, 1.5, 2.0				
Position	Top, Central				
Low Input Lag On, Low Input Lag Off					
Off, Fast, Faster, Fastest					
On, Off					
SmartFrame Off					
SmartFrame On					
Size	1, 2, 3, 4, 5, 6, 7				
Brightness	0-100				
Contrast	0-100				
H, Position	0-Max				
V, Position	0-Max				
Input	Input	HDMI 1			
		HDMI 2			
		DisplayPort			
		Auto	On, Off		
Audio	Volume, Mute	Volume(0-100)	0-100		
		Mute On, Mute Off			
Language	Language	English, Deutsch, Español, Ελληνικά, Français, Italiano, Magyar, Nederlands, Português, Português do Brasil, Polski, Русский, Svenska, Suomi, Türkçe, Čeština, Українська, 简体中文, 繁體中文, 日本語, 한국어			
System	OSD Setting, Smart Size, Pixel Orbiting, Over Scan	Horizontal	0-100		
		Vertical	0-100		
		Transparency	Off, 1, 2, 3, 4		
		OSD Time out	5s, 10s, 20s, 30s, 60s		
		Screen Size	27"W, 24"W, 23"W, 22"W, 21.5"W, 20"W, 19.5"W, 19"W, 19", 18.5"W, 17"		
		1:1			
		4:3			
Pixel Orbiting On, Pixel Orbiting Off					
Over Scan On, Over Scan Off					
Setup	Power LED, Resolution Notice, Information, Reset	0-4			
		Resolution Notice On, Resolution Notice Off			
		Model			
		SN			
	Reset	Yes, No			
Close					

⊞ Note

- **Game mode:** This model is equipped with new features in OSD which gives you high-quality visual experience.
 - **Smart MBR**
In an effort to reduce motion blur, this monitor's LED backlight will work simultaneously with the refresh rate to control brightness levels for the best picture clarity. Please note that Smart MBR is a type of gaming mode and it is recommended to turn the function off when not gaming as it may cause screen-flickering.
 - **Smart MBR Sync**
This feature pairs Smart MBR together with Adaptive Sync technology; which effectively eliminates motion blur and ghosting on screen. Sharp and speedy gaming visuals are guaranteed, even at high frame rates. Please note that Smart MBR Sync is a type of gaming mode.
 - **Smart Crosshair**
Color of Crosshair is set by default. When Smart Crosshair is on, the color will change as complementary color to the background color. Smart Crosshair enhances the accuracy of aiming so you can spot the enemies more easily.
 - **Stark ShadowBoost**
This feature enhances dark scenes without overexposing lightened areas. The Stark ShadowBoost feature has three selectable levels that offer texturized images with better color saturation with higher contrast so you can see better in both light and dark

environments. In addition, this feature helps you fine-tune your sight so that enemies get exposed more quickly when gaming.

- **Smart Sniper**
This feature enables you to zoom in to multiple targets at once; ultimately making it easier to aim and hit your enemies.
- This Philips monitor is certified with NVIDIA® G-Sync® compatible. Both technologies are used to match the refresh rate of the monitor to the graphic cards. Providing the smoothest gaming experience by reducing or eliminating judder, tearing, and stuttering.

Enabling Adaptive-Sync from the On-Screen Display menu will automatically activate the appropriate technology depending on the graphics card installed in your computer:

Go to www.philips.com/support to download the latest version of leaflet to get more information on G-Sync certification.

3 Resolution notification

This monitor is designed for optimal performance at its native resolution: 2560 x 1440.

When the monitor is powered on at a different resolution, an alert is displayed on the screen as follows: Use 2560 x 1440 for best results.

Display of the native resolution alert can be switched off from Setup in the OSD (On Screen Display) menu.

4 OverClock Your Monitor

The OverClock function increases the native refresh rate, however, it does have some associated risks along with it. Please follow the instructions below to activate the OverClock feature on your monitor:

1. First, check your PC's graphics card and make sure it is capable of achieving the maximum resolution and refresh rate of this monitor.
2. If needed, install the latest version of graphics card driver.
3. Ensure the OverClock signal port is available (Please refer to the chapter Resolution & Preset Modes in the dedicated user manual).
4. Modify the refresh rate in the On Screen Display (OSD) settings.

To enable the OverClock feature, you will need to go to OSD menu > Game Settings > OverClock.

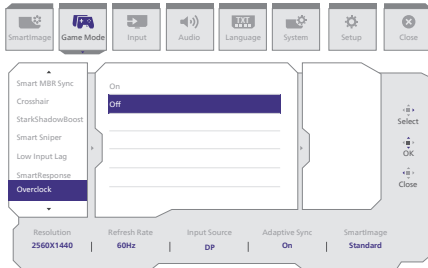

Note

Please note that the default setting for OverClock is off as it can cause irreversible damage to your monitor. If the screen is displayed abnormally after rebooting, please switch off the OverClock setting located in the monitor's OSD menu. Alternatively, you can unplug the power cable. Then, press and hold the left button of the menu toggle on the monitor while plugging the power cable back in. Keep holding

the button until the screen turns on. This will turn off the Overclock function, and the monitor will return to its default refresh rate.

5 Physical Function

Tilt

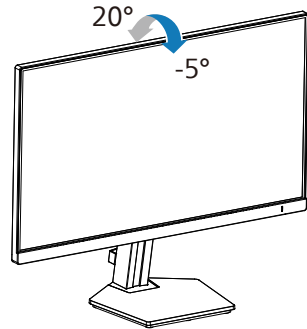

Warning

- To avoid potential screen damage, such as panel peeling, ensure that the monitor does not tilt downward by more than -5 degrees.
- Do not press the screen while adjusting the angle of the monitor. Grasp only the bezel.

2.3 Remove the Base Assembly for VESA Mounting

Before you start disassembling the monitor base, please follow the instructions below to avoid any possible damage or injury.

1. Place the monitor face down on a smooth surface. Pay attention not to scratch or damage the screen.

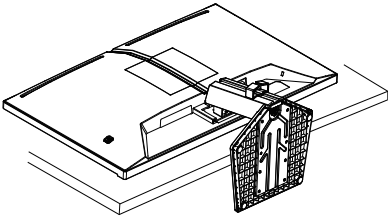

2. While keeping the release button pressed, tilt the base and slide it out.

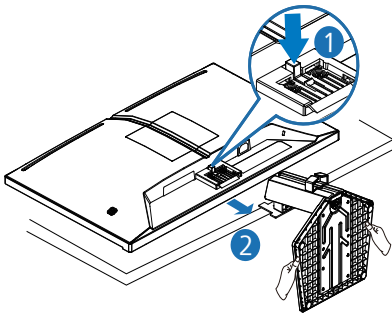

3. Press both corners of the VESA Cover and the other side of the cover will pop out.

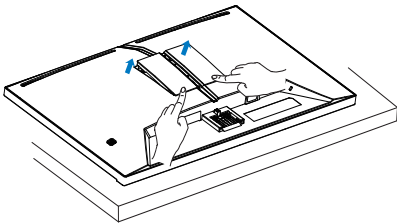

4. Remove the VESA Cover

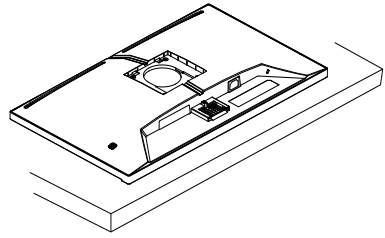

Note

This monitor accepts a 100mm x 100mm VESA-Compliant mounting interface. VESA Mounting Screw M4. Always contact manufacturer for wall-mount installation.

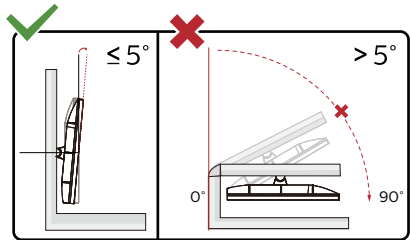
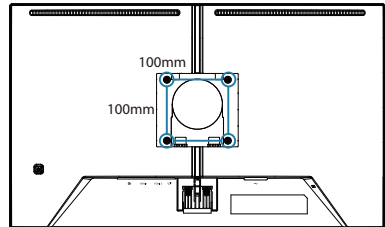

* Display design may differ from those illustrated in this manual.



Warning

- To avoid potential screen damage, such as panel peeling, ensure that the monitor does not tilt downward by more than -5 degrees.
- Do not press the screen while adjusting the angle of the monitor. Grasp only the bezel.

3. Image Optimization

3.1 SmartImage

1 What is it?

SmartImage provides presets that optimize display for different types of content, dynamically adjusting brightness, contrast, color, and sharpness in real-time. Whether you're working with text applications, displaying images, or watching a video, Philips SmartImage delivers great monitor performance.

2 Why do I need it?

It is ideal to have a monitor that delivers an optimized display of all your favorite types of content. Our SmartImage software dynamically adjusts brightness, contrast, color, and sharpness in real-time to enhance your monitor viewing experience.

3 How does it work?

SmartImage is an exclusive, leading-edge Philips technology that analyzes the content displayed on your screen. Based on the scenario you select, SmartImage dynamically enhances the contrast, color saturation, and sharpness of images to enhance the contents being displayed - all in real time by the press of a single button.

4 How to enable SmartImage?

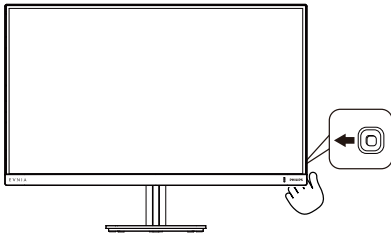

1. Toggle to the left to launch the SmartImage on-screen display.

2. Toggle the up or down to select between the SmartImage modes.
3. The SmartImage on-screen display will remain on screen for 5 seconds, or you can also toggle to the left to make confirmation.

There are multiple selections: Standard, FPS, Racing, RTS, Movie, LowBlue Mode, EasyRead, Economy, SmartUniformity, Gamer1 and Gamer2.

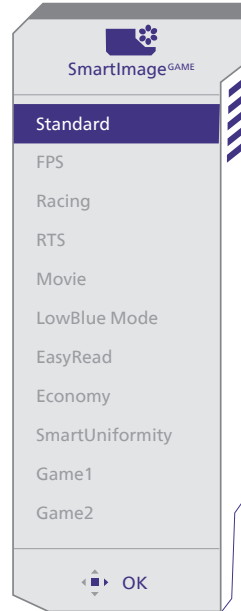

- **Standard:** Enhances text and dampens brightness to increase readability and reduce eye strain. This mode significantly enhances readability and productivity when working with spreadsheets, PDF files, scanned articles, or other similar office applications.
- **FPS:** For playing FPS (First Person Shooters) games. Improves dark theme black level details.
- **Racing:** For playing Racing games. Provides the fastest response time and high color saturation.

- **RTS:** For playing RTS (Real Time Strategy) games, a user-selected portion can be highlighted for RTS games (through SmartFrame). The picture quality can be adjusted for the highlighted portion.
- **Movie:** Ramped up luminance, deepened color saturation, dynamic contrast, and razor sharpness displays every detail in darker areas of your videos without experiencing color washout.
- **LowBlue Mode:** LowBlue Mode for easy-on-the-eyes productivity. Studies have shown that just as ultra-violet rays can cause eye damage, shortwave length blue light rays from LED displays can cause eye damage and affect vision over time. Developed for well-being, the Philips LowBlue Mode setting uses smart software technology to reduce harmful shortwave blue light.
- **EasyRead:** Helps improve reading of text-based applications like PDF ebooks. By using a special algorithm that increases the contrast and boundary sharpness of text content. The display is optimized for a stress-free reading by adjusting the brightness, contrast, and color temperature of the monitor.
- **Economy:** Under this profile, brightness and contrast are adjusted and backlighting is fine-tuned to produce the right display for everyday office applications.
- **Smartuniformity:** Fluctuations in brightness on different parts of a screen are a common phenomenon among LCD displays. Typical uniformity is measured around 75-80%. By enabling Philips SmartUniformity feature, display uniformity is increased to above

95%. This produces more consistent and true images.

- **Gamer1:** User's preference settings saved as Gamer1.
- **Gamer2:** User's preference settings saved as Gamer2.

When this display receives an HDR signal from the connected device, select a picture mode that best fits your needs.

There are 5 modes to select: HDR Game, HDR Movie, HDR Vivid, Personal, and Off.

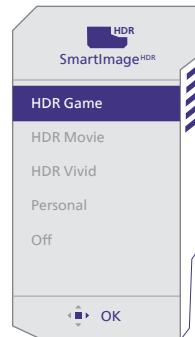

- **HDR Game:** Ideal setting to optimize for playing video games. With brighter white and darker black, the gaming scene is vivid and reveals more details, easily spotting enemies hiding in the dark corner and shadows.
- **HDR Movie:** Ideal setting for watching HDR movies. Deliver better contrast and brightness for a more realistic and immersing viewing experience.
- **HDR Vivid:** Enhancing red, green, and blue for true-to-life visuals.
- **Personal:** Customize available settings in the picture menu.
- **Off:** No optimization by SmartImage HDR.

Note

To switch off the HDR function, please disable the Input device and its content. Inconsistent HDR settings between the input device and monitor may cause unsatisfying images.

3.2 SmartContrast

1 What is it?

It is a unique technology that dynamically analyzes displayed content and automatically optimizes a monitor's contrast ratio for maximum visual clarity and viewing enjoyment.

2 Why do I need it?

Because SmartContrast offers the best visual clarity and viewing comfort for every type of content. It dynamically controls contrast and adjusts backlighting for bright gaming and video imagery. In addition, by reducing your monitor's power consumption, you save on energy costs and extend the lifetime of your monitor.





3 How does it work?

When you activate SmartContrast, it will analyze the content you are displaying in real time to adjust colors and control backlight intensity. This function will dynamically enhance contrast for a great entertainment experience when viewing videos or playing games.

3.3 Customize color space

You can manually select the appropriate color space mode to properly display the content you are viewing.

1 Select appropriate color space mode to fit the content you're viewing:

1. Press  button to enter OSD menu.
2. Press  or  button to select main menu [Color], then press OK button.
3. Press  or  button to select [Color Space].
4. Select one of colors modes.
5. Press OK button to confirm your selection.

2 There are multiple selections:

- **Native:** The full range of colors that the display is capable of.
- **sRGB:** Most personal computer applications and games, Internet, and web design.
- **DCI-P3:** Digital cinema projectors, some movies and games, and Apple products. Photography.
- **Adobe RGB:** Graphics applications.

 **Note**

HDR and color space mode cannot be enabled simultaneously. Please disable HDR before you select one of color space modes.

4. NVIDIA® G-SYNC® Compatible



When playing intense games with high refresh rates, screen tearing may appear without optimal graphics synchronization. Certified as NVIDIA® G-SYNC® Compatible, variable refresh rate (VRR) reducing screen tearing and syncing your monitor's refresh rate with your graphic card's output for a smoother gaming experience. Scenes appear instantly, objects look sharper, and gameplay is smooth, giving you a stunning visual experience and a serious competitive edge.

Note

- For best output performance, please always ensure that your graphic card is capable of achieving the maximum resolution and refresh rate of this Philips display.
- NVIDIA® G-SYNC® support interface: DisplayPort.
- Make sure your graphic card supports NVIDIA® G-SYNC®.
- Make sure to update NVIDIA® G-SYNC® driver to the latest version, see more information on NVIDIA website: <https://www.nvidia.com/>.
- ©2019 NVIDIA, the NVIDIA logo, and NVIDIA G-SYNC are trademarks and/or registered trademarks of NVIDIA Corporation in the U.S. and other countries.

5. HDR

HDR Settings in Windows10 system.

Steps

1. Right-click on the desktop, and enter Display settings.
2. Select the display/monitor.
3. Select an HDR-capable display under Rearrange your displays.
4. Select Windows HD Color settings.
5. Adjust Brightness for SDR content.

Note

Windows 10 edition is required. Always upgrade to the most updated version. The link below is for further information from the Microsoft official website.

<https://support.microsoft.com/en-au/help/4040263/windows-10-hdr-advanced-color-settings>

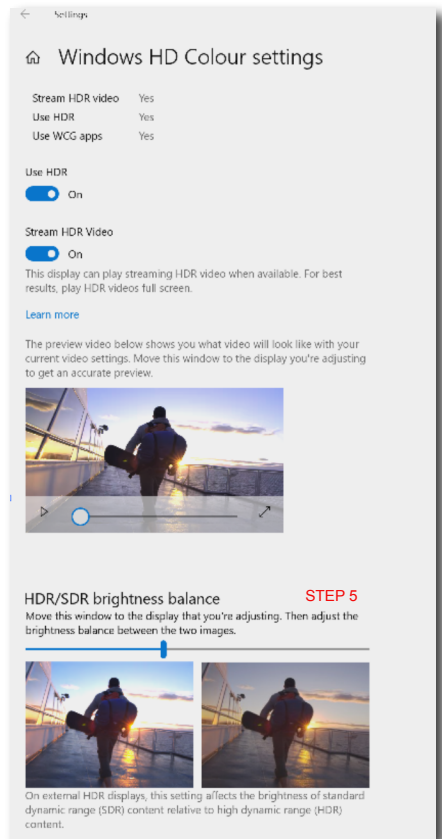
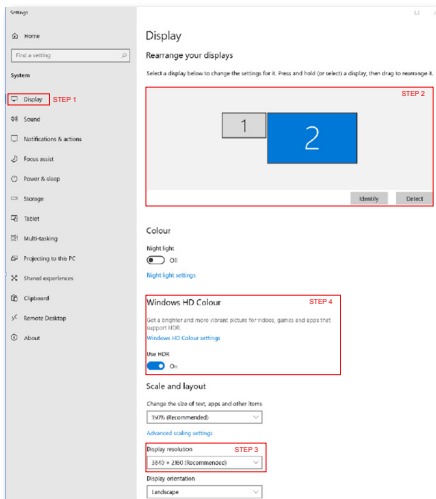

Note

To switch off the HDR function, please disable it from an Input device and its content. Inconsistent HDR settings between the input device and monitor may cause unsatisfying images.

6. Technical Specifications

Picture/Display	
Monitor Panel Type	IPS Technology
Backlight	W-LED
Panel Size	27" W (68.5 cm)
Aspect Ratio	16:9
Pixel Pitch	0.2331 (H) mm x 0.2331 (V) mm
Contrast Ratio(typ.)	1000:1
Recommended Resolution	2560 x 1440 @ 60 Hz
Maximum Resolution	2560 x 1440 @ 260 Hz
Viewing Angle	178° (H) / 178° (V) @ C/R > 10 (typ.)
Display Colors	1.07B (8bits + FRC) ¹
Flicker Free	Yes
Picture Enhancement	SmartImage Game /SmartImage HDR
Vertical Refresh Rate	48 Hz - 144 Hz (HDMI) 48 Hz - 240 Hz (DP) 48 Hz - 260 Hz (DP OverClock)
Horizontal Frequency	30 KHz - 230 KHz (HDMI) 30 KHz - 360 KHz (DP) 30 KHz - 400 KHz (DP OverClock)
sRGB	YES
EasyRead	YES
Smartuniformity	YES
Delta E	YES
G Sync	YES
SoftBlue technology	YES ²
HDR	YES
Connectivity	
Signal Input source	HDMI, DisplayPort
Connectors	2 x HDMI 2.0 (HDCP 1.4 / HDCP 2.3) 1 x DisplayPort 1.4 (HDCP 1.4 / HDCP 2.3) 1 x Audio out
Sync input	Separate Sync
Convenience	
OSD Languages	English, German, Spanish, Greek, French, Italian, Hungarian, Dutch, Portuguese, Brazil Portuguese, Polish, Russian, Swedish, Finnish, Turkish, Czech, Ukranian, Simplified Chinese, Traditional Chinese, Japanese, Korean
Other Convenience	VESA mount (100 x 100 mm), Kensington Lock
Plug & Play Compatibility	DDC/CI, sRGB, Windows 11/10, Mac OS X

Stand			
Tilt	-5 / +20 degree		
Power			
Consumption	AC Input Voltage at 100VAC , 60Hz	AC Input Voltage at 115VAC , 60Hz	AC Input Voltage at 230VAC, 50Hz
Normal Operation	38.4 W (typ.)	37.8 W (typ.)	37.2 W (typ.)
Sleep (Standby mode)	0.5 W (typ.)	0.5 W (typ.)	0.5 W (typ.)
Off mode	0.3 W (typ.)	0.3 W (typ.)	0.3 W (typ.)
Heat Dissipation*	AC Input Voltage at 100VAC , 60Hz	AC Input Voltage at 115VAC , 60Hz	AC Input Voltage at 230VAC , 50Hz
Normal Operation	131.06 BTU/hr (typ.)	129.01 BTU/hr (typ.)	126.96 BTU/hr (typ.)
Sleep (Standby mode)	1.71 BTU/hr (typ.)	1.71 BTU/hr (typ.)	1.71 BTU/hr (typ.)
Off mode	1.02 BTU/hr (typ.)	1.02 BTU/hr (typ.)	1.02 BTU/hr (typ.)
Power LED indicator	On mode: White, Standby/Sleep mode: White (blinking)		
Power Supply	Built-in, 100-240VAC, 50/60Hz		
Dimensions			
Product with stand (WxHxD)	614 x 462 x 215 mm		
Product without stand (WxHxD)	614 x 368 x 60 mm		
Product with packaging (WxHxD)	690 x 420 x 141 mm		
Weight			
Product with stand	4.25 kg		
Product without stand	3.69 kg		
Product with packaging	6.70 kg		
Operating Condition			
Temperature range (operation)	0°C to 40°C		
Relative humidity (operation)	20% to 80%		
Atmospheric pressure (operation)	700hPa to 1060hPa		
Temperature range (Non-operation)	-20°C to 60°C		
Relative humidity (Non-operation)	10% to 90%		
Atmospheric pressure (Non-operation)	500hPa to 1060hPa		
Environmental and energy			
ROHS	YES		
Packaging	100% recyclable		
Specific Substances	100% PVC BFR free housing		

Cabinet	
Color	Charcoal
Finish	Texture

- ¹ For mor information, please refer to Chapter 6.1 on Display Input Format.
- ² This monitor features SoftBlue technology. This integrated feature offers increased visual comfort and protection against adverse health effects caused by prolonged exposure to blue light. With the low blue-light panel, the ratio of display emission light in the range from 415-455 nm to the display emission of 400-500nm shall be less than 50%. This monitor provides optimal visual comfort, minimizes eye strain, and supports sustained focus.

 **Note**

1. The data mentioned in this section is subject to change without notice. Go to www.philips.com/support to download the latest version of the leaflet.
2. SmartUniformity and Delta E information sheets are included in the box.

6.1 Resolution & Preset Modes

H. freq (kHz)	Resolution	V. freq (Hz)
31.47	720 x 400	70.00
31.47	640 x 480	60.00
35.00	640 x 480	67.00
37.86	640 x 480	72.00
37.50	640 x 480	75.00
35.16	800 x 600	56.00
37.88	800 x 600	60.00
46.88	800 x 600	75.00
47.73	832 x 624	75.00
48.36	1024 x 768	60.00
56.48	1024 x 768	70.00
60.02	1024 x 768	75.00
67.50	1920 x 1080	60.00
63.89	1280 x 1024	60.00
88.86	2560 x 1440	60.00
151.00	2560 x 1440	100.00
183.00	2560 x 1440	120.00
222.19	2560 x 1440	144.00
247.66	2560 x 1440	165.00 (DP)
300.20	2560 x 1440	200.00 (DP)
364.80	2560 x 1440	240.00 (DP)
382.20	2560 x 1440	260.00 (DP OverClock)

Note

Please note that your display works best at the native resolution of 2560 x 1440. For best output performance, please always ensure that your graphic card is capable of achieving the maximum resolution and refresh rate of this Philips display.

Display Input Format

	422/420	444/RGB	422/420	444/RGB
	HDMI 2.0	HDMI 2.0	DP 1.4	DP 1.4
2560 x 1440 260Hz, 10bits	N/A	N/A	OK	N/A
2560 x 1440 260Hz, 8bits	N/A	N/A	OK	OK
2560 x 1440 240Hz, 10bits	N/A	N/A	OK	N/A
2560 x 1440 240Hz, 8bits	N/A	N/A	OK	OK
2560 x 1440 200Hz, 10bits	N/A	N/A	OK	OK
2560 x 1440 200Hz, 8bits	N/A	N/A	OK	OK
2560 x 1440 144Hz, 10bits	OK	N/A	OK	OK
2560 x 1440 144Hz, 8bits	OK	OK	OK	OK
2560 x 1440 60Hz, 10bits	OK	OK	OK	OK
2560 x 1440 60Hz, 8bits	OK	OK	OK	OK
Minimum:1920*1080@60HZ	OK	OK	OK	OK

Note

In order for the monitor to function properly, your PC's graphics card must support DisplayPort 1.4 or HDMI 2.0. The display resolution and refresh rate are also dependent on the computer's graphic card capability.

7. Power Management

If you have a VESA DPM compliance display card or software installed on your PC, the monitor can automatically reduce its power consumption when not in use. If an input from a keyboard, mouse, or other input device is detected, the monitor will 'wake up' automatically. The following table shows the power consumption and signaling of this automatic power saving feature:

Power Management Definition					
VESA Mode	Video	H-sync	V-sync	Power Used	LED Color
Active	ON	Yes	Yes	37.8 W (typ.) 61.4 W (max.)	White
Sleep (Standby mode)	OFF	No	No	0.5 W	White (blink)
Off mode	OFF	-	-	0.3 W	OFF

The following setup is used to measure power consumption on this monitor.

- Native resolution: 2560 x 1440
- Contrast: 50%
- Brightness: 80%
- Color temperature: 6500k with full white pattern

Note

This data is subject to change without notice.

8. Customer care and warranty

8.1 Philips' Flat Panel Monitors Pixel Defect Policy

Philips strives to deliver the highest quality products. We use some of the industry's most advanced manufacturing processes and practice stringent quality control. However, pixel or sub-pixel defects on the TFT Monitor panels used in flat panel monitors are sometimes unavoidable. No manufacturer can guarantee that all panels will be free from pixel defects, but Philips guarantees that any monitor with an unacceptable number of defects will be repaired and/or replaced under warranty. This notice explains the different types of pixel defects and defines acceptable defect levels for each type. To qualify for repair or replacement under warranty, the number of pixel defects on a TFT Monitor panel must exceed these acceptable levels. For example, no more than 0.0004% of the sub-pixels on a monitor may be defective. Furthermore, Philips sets even higher quality standards for certain types or combinations of pixel defects that are more noticeable than others. This policy is valid worldwide.

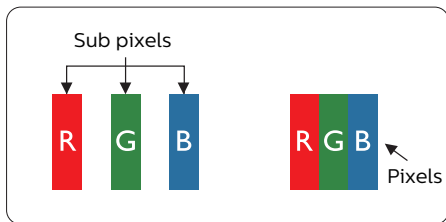

Pixels and Sub pixels

A pixel, or picture element, is composed of three sub-pixels in the primary colors of red, green, and blue. Many pixels

together form an image. When all the sub-pixels of a pixel are lit, the three colored sub-pixels together appear as a single white pixel. When all are dark, the three colored sub-pixels together appear as a single black pixel. Other combinations of lit and dark sub-pixels appear as single pixels of other colors.

Types of Pixel Defects

Pixel and sub-pixel defects appear on the screen in different ways. There are two categories of pixel defects and several types of sub-pixel defects within each category.

Bright Dot Defects

Bright dot defects appear as pixels or sub-pixels that are always lit or 'on'. Meaning, a bright dot is a sub-pixel that stands out on the screen when the monitor displays a dark pattern. There are three types of bright dot defects: One lit red, green, or blue sub-pixel.

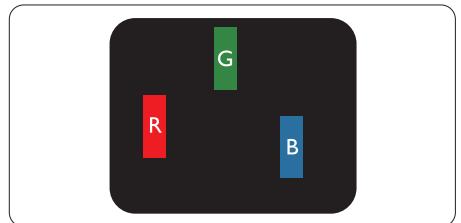

One lit red, green or blue sub pixel.

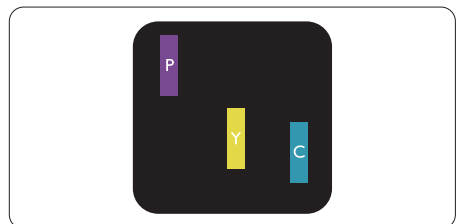

Two adjacent lit sub-pixels:

- Red + Blue = Purple
- Red + Green = Yellow
- Green + Blue = Cyan (Light Blue)

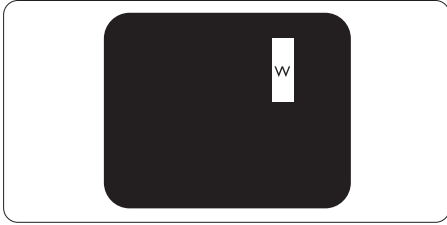

Three adjacent lit sub pixels (one white pixel).

Note
A red or bright blue dot must be more than 50 percent brighter than neighboring dots, while a bright green dot is 30 percent brighter than neighboring dots.

Black Dot Defects

Black dot defects appear as pixels or sub-pixels that are always dark or 'off'. Meaning, a dark dot is a sub-pixel that stands out on the screen when the monitor displays a light pattern. These are the types of black dot defects.

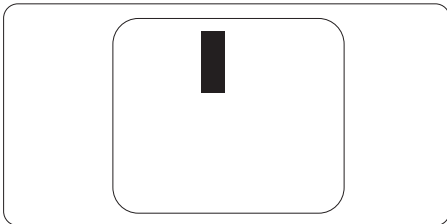

Proximity of Pixel Defects

Because pixel and sub pixels defects of the same type that are near to one another may be more noticeable, Philips also specifies tolerances for the proximity of pixel defects.

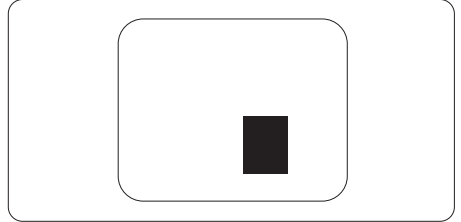

Pixel Defect Tolerances

To qualify for repair or replacement due to pixel defects during the warranty period, a TFT Monitor panel in a Philips flat panel monitor must have pixel or sub-pixel defects exceeding the tolerances listed in the following tables.

BRIGHT DOT DEFECTS	ACCEPTABLE LEVEL
1 lit subpixel	2
2 adjacent lit subpixels	1
3 adjacent lit subpixels (one white pixel)	0
Distance between two bright dot defects*	>15mm
Total bright dot defects of all types	2
BLACK DOT DEFECTS	ACCEPTABLE LEVEL
1 dark subpixel	3 or fewer
2 adjacent dark subpixels	2 or fewer
3 adjacent dark subpixels	0
Distance between two black dot defects*	>15mm
Total black dot defects of all types	3 or fewer
TOTAL DOT DEFECTS	ACCEPTABLE LEVEL
Total bright or black dot defects of all types	5 or fewer

 **Note**

1 or 2 adjacent sub pixel defects = 1 dot defect

8.2 Customer Care & Warranty

For warranty coverage information and additional support requirements valid for your region, please visit www.philips.com/support website for details or contact your local Philips Customer Care Center.

For an extended warranty, if you would like to extend your general warranty period, an Out of Warranty service package is offered via our Certified Service Center.

For the Warranty Period please refer to Warranty Statement in the Important information manual.

If you wish to make use of this service, please be sure to purchase the service within 30 calendar days of your original purchase date. During the extended warranty period, the service includes pickup, repair, and return service, however, the user will be responsible for all costs accrued.

If the Certified Service Partner cannot perform the required repairs under the offered extended warranty package, we will find alternative solutions for you, if possible, up to the extended warranty period you have purchased.

Please contact our Philips Customer Service Representative or local contact center (by Consumer care number) for more details.

Philips Customer Care Center number listed below.

• Local Standard Warranty Period	• Extended Warranty Period	• Total Warranty Period
• Depend on different Regions	• + 1 Year	• Local Standard warranty period +1
	• + 2 Years	• Local Standard warranty period +2
	• + 3 Years	• Local Standard warranty period +3

**Proof of original purchase and extended warranty purchase required.

Note

Please refer to the Important information manual for the regional service hotline, which is available on the Philips website support page.

9. Troubleshooting & FAQs

9.1 Troubleshooting

This page deals with problems that can be corrected by a user. If the problem persists after you have tried these solutions, contact a Philips customer service representative.

1 Common Problems

No Picture (Power LED not lit)

- Make sure the power cord is plugged into the power outlet and the back of the monitor.
- First, ensure that the power button on the rear of the monitor is in the OFF position, then press it to the ON position.

No Picture (Power LED is White)

- Make sure the computer is turned on.
- Make sure the signal cable is properly connected to your computer.
- Make sure the monitor cable has no bent pins on the connecting side. If yes, repair or replace the cable.
- The Energy Saving feature may be activated. Screen says.

Check cable connection

- Make sure the monitor cable is properly connected to your computer. (Also refer to the Quick Start Guide).
- Check to see if the monitor cable has bent pins.
- Make sure the computer is turned on.

Visible signs of smoke or sparks

- Do not perform any troubleshooting steps
- Disconnect the monitor from mains power source immediately for safety
- Contact with Philips customer service representative immediately.

2 Imaging Problems

Image vibrates on the screen

- Check that the signal cable is properly securely connected to the graphics board or PC.

The image appears blurred, indistinct or too dark

- Adjust the contrast and brightness on On-Screen Display.

An "after-image", "burn-in" or "ghost image" remains after the power has been turned off.

- Uninterrupted display of still or static images over an extended period may cause "burn-in", also known as "after-imaging" or "ghost imaging", on your screen. "Burn-in", "after-imaging", or "ghost imaging" is a well-known phenomenon in LED panel technology. In most cases, the "burn-in" "after-imaging" or "ghost imaging" will disappear gradually over some time after the power has been switched off.
- Always activate a moving screen saver program when you leave your monitor unattended.
- Always activate a periodic screen refresh application if your LCD monitor will display unchanging static content.
- Failure to activate a screen saver, or a periodic screen refresh application may result in severe "burn-in" "after-imaging" or "ghost imaging" symptoms that will not disappear

and cannot be repaired. The damage mentioned above is not covered under your warranty.

The image appears distorted or the text is fuzzy or blurred.

- Set the PC's display resolution to the same mode as the monitor's recommended screen native resolution.

Green, red, blue, dark, and white dots appear on the screen

- The remaining dots are a normal characteristic of the liquid crystal used in today's technology, Please refer to the pixel policy for more detail.

* The "power on" light is too strong and is disturbing

- You can adjust the "power on" light using the power LED Setup in OSD Main Controls.

For further assistance, refer to the Service contact information listed in the Important information manual and contact a Philips customer service representative.

* [Functionality is different according to display.](#)

9.2 General FAQs

Q1: When I install my monitor what should I do if the screen shows 'Cannot display this video mode'?

Ans.: Recommended resolution for this monitor: 2560 x 1440.

- Unplug all cables, then connect your PC to the monitor that you used previously.
- In the Windows Start Menu, select Settings/Control Panel. In the Control Panel Window, select the Display icon. Inside the Display Control Panel, select the 'Settings' tab. Under the setting tab, in the box labeled 'desktop area', move the sidebar to 2560 x 1440 pixels.
- Open 'Advanced Properties' and set the Refresh Rate to 60 Hz, then click OK.
- Restart your computer and repeat Restart your computer and repeat steps 2 and 3 to verify that your PC is set at 2560 x 1440.
- Shut down your computer, disconnect your old monitor, and reconnect your Philips LED monitor.
- Turn on your monitor and then turn on your PC.

Q2: What is the recommended refresh rate for an LED monitor?

Ans.: Recommended refresh rate in LED monitors is 60 Hz, In case of any disturbance on the screen, you can set it up to 75 Hz to see if that removes the disturbance.

Q3: What are the .inf and .icm files? How do I install the drivers (.inf and .icm)?

Ans.: These are the driver files for your monitor. Your computer may ask you for monitor drivers (.inf and .icm files) when you

first install your monitor. Follow the instructions in your user manual, and monitor drivers (.inf and .icm files) will be installed automatically.

Q4: How do I adjust the resolution?

Ans.: Your video card/graphic driver and monitor together determine the available resolutions. You can select the desired resolution under Windows® Control Panel with the "Display properties".

Q5: What if I get lost when I am making monitor adjustments via OSD?

Ans.: Simply press the ➡ button, then select [Reset] to recall all the original factory settings.

Q6: Is the LCD screen resistant to scratches?

Ans.: In general it is recommended that the panel surface is not subjected to excessive shocks and is protected from sharp or blunt objects. When handling the monitor, make sure that there is no pressure or force applied to the panel surface side. This may affect your warranty conditions.

Q7: How should I clean the LCD surface?

Ans.: For normal cleaning, use a clean, soft cloth. For extensive cleaning, please use isopropyl alcohol. Do not use other solvents such as ethyl alcohol, ethanol, acetone, hexane, etc.

Q8: Can I change the color setting of my monitor?

Ans.: Yes, you can change your color setting through OSD control as per the following procedures.

- Press the ➡ button to show the OSD (On Screen Display) menu
- Press the ↓ button to select the option [Color] then press the ➡ button to enter the color setting, there are three settings as below.
 1. Color Temperature: The settings are as follows. Native, 5000K, 6500K, 7500K, 8200K, 9300K, and 11500K. With settings in the 5000K range the panel appears "warm, with a red-white color tone", while a 11500K temperature yields "cool, blue-white toning".
 2. sRGB: This is a standard setting for ensuring the correct exchange of colors between different devices (e.g. digital cameras, monitors, printers, scanners, etc).
 3. User Define: The user can choose his/her preferred color setting by adjusting red, green, and blue colors.

Note

A measurement of the color of light radiated by an object while it is being heated. This measurement is expressed in terms of absolute scale, (degrees Kelvin). Lower Kevin temperatures such as 2004K are red; higher temperatures such as 9300K are blue. The neutral temperature is white, at 6504K.

Q9: Can I connect my LED monitor to any PC, workstation, or Mac?

Ans.: Yes. All Philips LED monitors are fully compatible with standard PCs, Macs, and workstations. You may need a cable adapter to connect the monitor to your Mac system. Please contact your Philips sales representative for more information.

Q10: Are Philips LCD monitors Plug-and- Play?

Ans.: Yes, the monitors are Plug-and-Play compatible with Windows 11/10, Mac OSX.

Q11: What is Image Sticking, Image Burn-in, After Image, or Ghost Image in LCD panels?

Ans.: Uninterrupted display of still or static images over an extended period may cause "burn-in", also known as "after-imaging" or "ghost imaging", on your screen. "Burn-in", "after-imaging", or "ghost imaging" is a well-known phenomenon in LCD panel technology. In most cases, the "burn-in" or "after-imaging" or "ghost imaging" will disappear gradually over a period of time after the power has been switched off.

Always activate a moving screen saver program when you leave your monitor unattended.

Always activate a periodic screen refresh application if your LCD monitor will display unchanging static content.

Warning

Failure to activate a screen saver, or a periodic screen refresh application may result in severe "burn-in" "after-image" or "ghost image" symptoms that will not disappear and cannot be repaired. The damage mentioned above is not covered under your warranty.

Q12: Why is my Display not showing sharp text, and is displaying jagged characters?

Ans.: Your LCD monitor monitor works best at its native resolution of 2560 x 1440. For the best display, please use this resolution.

Q13: How to unlock/lock my hotkey?

Ans.: Please press  for 10 seconds to unlock/lock the hotkey, by doing so, your display pops out "Attention" to show the unlock/lock status as shown below illustrators.



Monitor controls unlocked



Monitor controls locked

Q14: Where can I find the Important information manual mentioned in EDFU?

Ans.: Important information manual can be downloaded on the Philips website support page.



2025 © TOP Victory Investments Ltd. All rights reserved.

This product has been manufactured by and is sold under the responsibility of Top Victory Investments Ltd., and Top Victory Investments Ltd. is the warrantor in relation to this product. Philips and the Philips Shield Emblem are registered trademarks of Koninklijke Philips N.V. and are used under license.

Specifications are subject to change without notice.

Version: 27M2N3500PFE1T