



JBOD Enclosure Quick Installation Guide

快速安裝手冊 빠른 설치 설명서 Snelle Installatiegids

クイックインストールガイド Hızlı Kurulum Kılavuzu

คู่มือการติดตั้งแบบเร็ว Gyors telepítési útmutató

Instrukcja szybkiej instalacji 快速安裝指南

Kurzinstallationsanleitung Guía de Instalación Rápida

Guida di installazione rapida Pika-asennusopas

Краткое руководство по установке

Snabbinstallationsguide Guia de Instalação Rápida

Hurtiginstallasjonsveiledning Průvodce rychlou instalací

Hurtig installationsvejledning

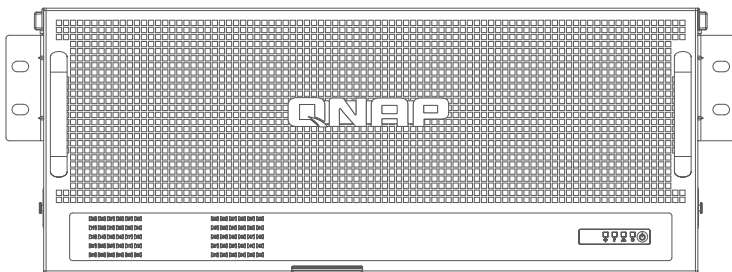

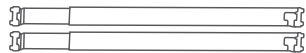
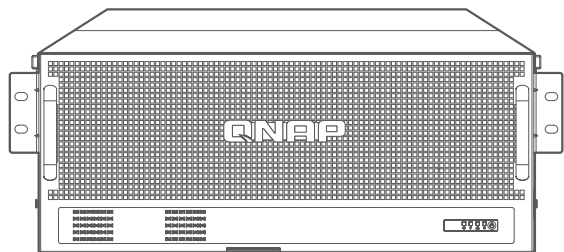

x1

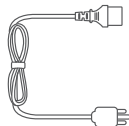

x2

Optional Accessory

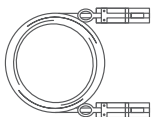

CAB-SAS05M-8644 (0.5m)
CAB-SAS10M-8644 (1m)
CAB-SAS20M-8644 (2m)
CAB-SAS30M-8644 (3m)

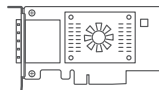

QXP-1630S-3816

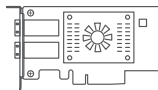

QXP-830S-3808



SSD/HDD

<http://www.qnap.com/compatibility>

- EN | All the drive data will be cleared upon SSD / HDD initialization
- DE | Alle Laufwerksdaten werden bei SSD/HDD-Initialisierung gelöscht
- FR | Toutes les données présentes sur les disques seront effacées lors de l'initialisation des SSD/HDD
- IT | Tutti i dati presenti verranno cancellati durante l'inizializzazione degli SSD / HDD
- ES | Todos los datos del disco serán borrados con la inicialización del SSD / HDD
- NL | Alle gegevens worden gewist tijdens de initialisatie van de SSD / HDD's
- SV | All data kommer att raderas när SSD / HDD initieras
- FI | SSD / HDD alustaminen poistaa kaikki tiedostot
- DA | Alle data på drevet vil blive ryddet efter initialisering af SSD / HDD
- NO | All data vil bli stettet når SSD / HDD er initialisert
- PT | Todos os dados do SSD / HDD serão apagados com a inicialização do SSD / HDD
- RU | После инициализации SSD/HDD все данные на нем будут удалены
- ZH | 硬碟初始化時，所有資料皆會被清除
- CN | 所有SSD / HDD上的数据都将会被清除
- JA | SSD/HDD を初期化すると、すべてのデータが消去されます
- KO | SSD / HDD 를 초기화 시키면 드라이브의 모든 데이터가 손실됩니다
- TH | ข้อมูลในไดรฟ์จะถูกลบออก เมื่อมีการตั้งค่าเริ่มต้น
- TR | Kurulum başladığında SSD / HDD disk üzerinde ki tüm veri siline cektir
- HU | Minden korábbi adat törlődik az SSD / HDD-ről az első rendszeri ndítás során
- CS | Všechna data na SSD / HDD budou smazána v důsledku inicializace
- PL | Podczas instalacji wszystkie dane na dyskach SSD / HDD zostaną usunięte
- AR | قىبهت وءن صراقأأا الءرءم ءاناب لك ءسم هءء HDD(ءبل صرلا ءلءال صرءق)SSD(ءبل صرلا صراقأأا الءرءم)
- ID | Semua data pada drive akan dihapus saat inisialisasi SSD/HDD
- VI | Tất cả dữ liệu trên ổ đĩa sẽ bị xóa khi khởi tạo SSD / HDD

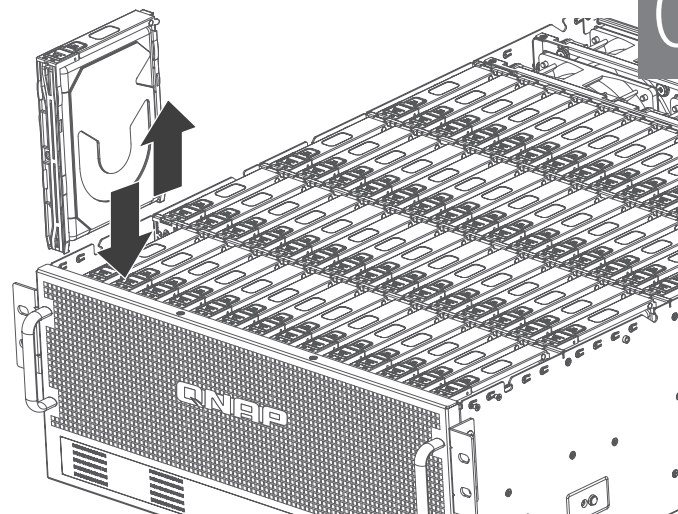
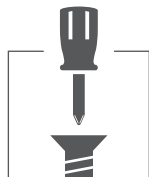

- EN** | Tighten the screws to prevent the tray from getting stuck to the chassis.
- DE** | Ziehen Sie die Schrauben an, um zu verhindern, dass der Einschub am Gehäuse stecken bleibt.
- FR** | Serrez les vis pour éviter que le plateau ne reste collé au châssis.
- IT** | Serrare le viti per evitare che il vano si blocchi nello chassis.
- ES** | Apriete los tornillos para evitar que la bandeja quede atascada en el chasis.
- NL** | Draai de schroeven vast om te voorkomen dat de lade bekneld raakt in het frame.
- SV** | Dra åt skruvarna för att förhindra att facket fastnar i chassina.
- FI** | Kiristä ruuvit, jotta alusta ei juutu runkoon.
- DA** | Spænd skruerne for at forhindre bakken i at sidde fast i kabinettet.
- NO** | Trekk til skruene for å unngå at skuffen setter seg fast i kabinettet.
- PT** | Aperte os parafusos para evitar que a bandeja fique travada no chassi.
- RU** | Затяните винты, чтобы лоток не сошел с шасси.
- ZH** | 鎖緊螺絲以防止托盤卡在機殼裡。
- CN** | 拧紧螺丝，以免托盘卡在机箱上。
- JA** | トレイがシャーシに引っかからないようにネジを締めます。
- KO** | 트레이가 세시에 걸리지 않도록 나사를 조여 주십시오.
- TH** | ขันสกรูให้แน่น เพื่อป้องกันไม่ให้ถาดไปติดกับแชสซี
- TR** | Tepsinin çerçeveye sıkışmasını önlemek için vidaları sıkın.
- HU** | Húzza meg a csavarokat, hogy a tálca ne akadjon el a házban.
- CS** | Abyste zabránili zaklínění přihrádky k šasi, utáhněte šrouby.
- PL** | Dokładnie dokręć wkręty, aby kieszeń nie zaklinowała się w obudowie.
- AR** | لتثبيت باب قراص الال انم عب لال انم ل ريم اسم لال ط ب م ك ح أ
- ID** | Kencangkan sekrup untuk mencegah laci macet pada rangka
- VI** | Hãy vặn chặt các ốc vít để đảm bảo khay không bị kẹt vào khung máy.

Install 3.5-inch HDD

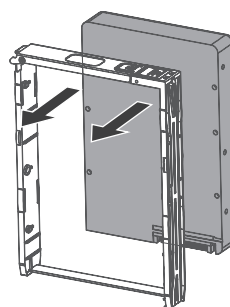

Remove 3.5-inch HDD

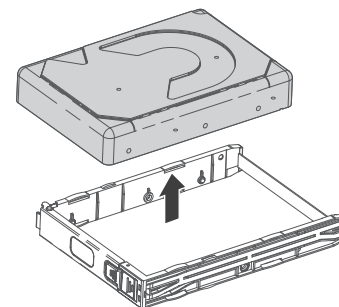

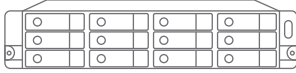

JBOD Compatibility List
<https://www.qnap.com/go/compatibility-expansion/>

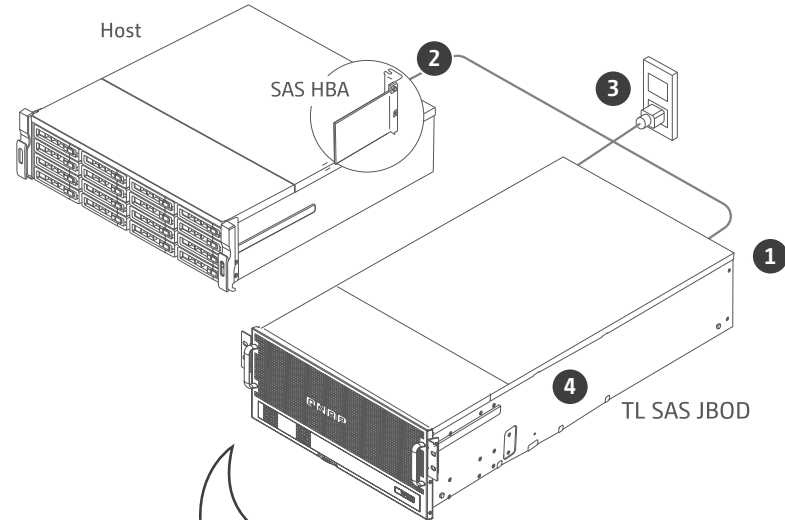
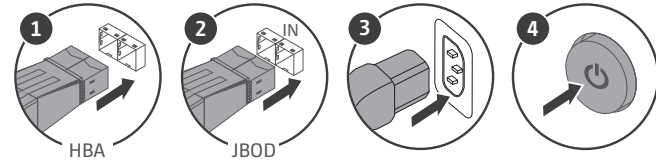

QNAP NAS -QuTS hero 5.2+



Storage
& Snapshots

- EN** | To connect a SAS JBOD enclosure to the NAS, you must install a QXP SAS expansion card on the NAS and use a supported cable.
- DE** | Um ein SAS JBOD Enclosure mit dem NAS zu verbinden, müssen Sie eine QXP SAS Erweiterungskarte auf dem NAS installieren und ein unterstütztes Kabel verwenden.
- FR** | Pour connecter un boîtier SAS JBOD au NAS, vous devez installer une carte d'extension QXP SAS sur le NAS et utiliser un câble pris en charge.
- IT** | Per collegare un alloggiamento SAS JBOD al NAS, è necessario installare una scheda di espansione QXP SAS sul NAS e utilizzare un cavo supportato.
- ES** | Para conectar una caja SAS JBOD con el NAS, debe instalar una tarjeta de expansión QXP SAS en el NAS y usar un cable compatible.
- NL** | Om een SAS JBOD-behuizing op de NAS aan te kunnen sluiten, moet u een QXP SAS-uitbreidingskaart in de NAS installeren en een ondersteunde kabel gebruiken.
- SV** | För att ansluta ett SAS JBOD-kabinett till NAS:en måste du installera ett QXP SAS-utökningskort på NAS:en och använda en medföljande kabel.
- FI** | Jotta voit yhdistää SAS JBOD -kotelon NASiin, sinun on asennettava QXP SAS -laajennuskortti NASille ja käytettävä tuettua kaapelia.
- DA** | Hvis du vil tilslutte en SAS JBOD-inddækning til NAS-enheden, skal du installere et QXP SAS-udvidelseskort på NAS-enheden og bruge et understøttet kabel.
- NO** | Hvis du vil koble et SAS JBOD-kabinett til NAS-enheten, må du installere et QXP SAS-utvidelseskort på NAS-enheten og bruke en støttet kabel.
- PT** | Para ligar um compartimento JBOD do SAS no NAS, deve instalar uma placa de expansão QXP SAS no NAS e utilizar um cabo suportado.
- RU** | Чтобы подключить к NAS дисковую полку SAS JBOD, в NAS необходимо установить карту расширения QXP SAS и использовать поддерживаемую модель кабеля.
- ZH** | 若要連接 SAS JBOD 擴充裝置至 NAS，您必須在 NAS 上安裝 QXP SAS 擴充卡並使用支援的連接線。
- CN** | 要将 SAS JBOD 设备连接到 NAS，必须在 NAS 上安装 QXP SAS 扩展卡并使用受支持的线缆。
- JA** | SAS JBOD エンクロージャーを NAS に接続するには、その NAS に QXP SAS 拡張カードをインストールし、対応するケーブルを使用する必要があります。
- KO** | SAS JBOD 인클로저를 NAS에 연결하려면 NAS에 QXP SAS 확장 카드를 설치하고 지원되는 케이블을 사용해야 합니다.
- TH** | ถ้าคุณเชื่อมต่ออุปกรณ์ขยายพื้นที่จัดเก็บ SAS JBOD เข้ากับ NAS คุณต้องติดตั้งการ์ดขยายเคอร์เซอร์ SAS QXP บน NAS และใช้สายเคเบิลที่รองรับระบบนี้
- TR** | NAS'a bir SAS JBOD kutusu bağlamak için NAS'a QXP SAS genişletme kartı takmanız ve desteklenen bir kablo kullanmanız gerekir.
- HU** | Egy SAS JBOD-ház NAS-hoz való csatlakoztatásához telepítenie kell egy QXP SAS bővítkártyát a NAS-ra, és támogatott kábelt kell használnia.
- CS** | Pro připojení jednotky SAS JBOD k úložišti NAS musíte na NAS nainstalovat rozšiřovací kartu QXP SAS a použít podporovaný kabel.
- PL** | Aby podłączyć obudowę JBOD SAS do serwera NAS, należy zainstalować w serwerze nas kartę rozszerzeń SAS QXP i użyć obsługiwanego kabla.
- AR** | وعودم لىك مدخمتست و NAS لى SAS QXP عسوت قواط بىكارت نأ بىس، NAS بى SAS JBOD قواط لىصوتل
- ID** | Untuk menghubungkan enklosur SAS JBOD ke NAS, Anda harus memasang kartu ekspansi QXP SAS pada NAS dan menggunakan kabel yang didukung.
- VI** | Để kết nối vỏ thiết bị SAS JBOD với NAS, bạn phải lắp thẻ mở rộng QXP SAS vào NAS và sử dụng cáp được hỗ trợ.



conditions: (1) this device may not cause harmful interference, and (2) this device must accept any interference received, including interference that may cause undesired operation.

FCC Class A Notice:

This equipment has been tested and found to comply with the limits for a Class A digital device, pursuant to Part 15 of the FCC Rules. These limits are designed to provide reasonable protection against harmful interference when the equipment is operated in a commercial environment. This equipment generates, uses, and can radiate radio frequency energy, and if not installed and used in accordance with the instruction manual, may cause harmful interference to radio communications. Operation of this equipment in a residential area is likely to cause harmful interference, in which case the user will be required to correct the interference at his own expense.

Modifications: Any modifications made to this device that are not approved by QNAP Systems, Inc. may void the authority granted to the user by the FCC to operate this equipment.



This device complies with CE compliance Class A.



According to the requirement of the WEEE legislation the following user information is provided to customers for all branded QNAP Electronics products subject to the WEEE directive.

This symbol on the product or on its packaging indicates that this product must not be disposed of with your other household waste. Instead, it is your responsibility to dispose of your waste equipment by handing it over to a designated collection point for the recycling of waste electrical and electronic equipment. The separate collection and recycling of your waste equipment at the time of disposal will help to conserve natural resources and ensure that it is recycled in a manner that protects human health and the environment. For more information about where you can drop off your waste equipment for recycling, please contact your local city office, your household waste disposal service or the shop where you purchased the product.



Office in EU;
QNAP GmbH,
Karl-Arnold-Straße 26,
47877 Willich, Germany

Office in UK;
QNAP Ltd,
2 Drakes Meadow, Swindon SN3 3LL
United Kingdom

This device complies with the UKCA requirements for products sold in Great Britain.



更多關於安全、法規、與環境法令遵循相關的資訊，請參閱以下網址 www.qnap.com/regulatory/



| Operation of this equipment in a residential environment could cause radio interference.

| 付属の電源コードは当該製品専用です。他の機器に使用しないでください。

| 斷接裝置：器具耦合器应当便于操作，附近不得被其他物体遮挡；
注意：用错误型号电池更换会有爆炸危险，务必按照说明处置用完的电池。

| CAN ICES-003(A) / NMB-003(A)

⚠ WARNING

- **INGESTION HAZARD:** This product contains a button cell or coin battery.
- **DEATH or serious injury can occur if ingested.**
- **A swallowed button cell or coin battery can cause Internal Chemical Burns in as little as 2 hours.**
- **KEEP new and used batteries OUT OF REACH of CHILDREN**
- **Seek immediate medical attention if a battery is suspected to be swallowed or inserted inside any part of the body.**



1. Battery type: CR2032.
2. Nominal battery voltage: 3.0 volts.

- Remove and immediately recycle or dispose of used batteries according to local regulations and keep away from children. Do NOT dispose of batteries in household trash or incinerate.
- Even used batteries may cause severe injury or death.
- Call a local poison control center for treatment information.
- Non-rechargeable batteries are not to be recharged.
- Do not force discharge, recharge, disassemble, heat above (manufacturer's specified temperature rating) or incinerate. Doing so may result in injury due to venting, leakage or explosion resulting in chemical burns.
- Ensure the batteries are installed correctly according to polarity (+ and -).
- Do not mix old and new batteries, different brands or types of batteries, such as alkaline, carbon-zinc, or rechargeable batteries.
- Remove and immediately recycle or dispose of batteries from equipment not used for an extended period of time according to local regulations.
- Always completely secure the battery compartment. If the battery compartment does not close securely, stop using the product, remove the batteries, and keep them away from children.

EC

REP

QNAP GmbH
Karl-Arnold-Straße 26, 47877 Willich, Germany

www.qnap.com



install.qnap.com



service.qnap.com



download.qnap.com

QNAP[®]



51000-025510-HF