

1

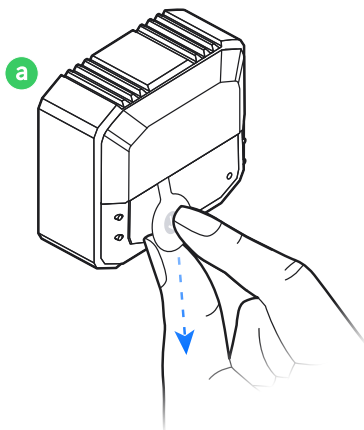

2

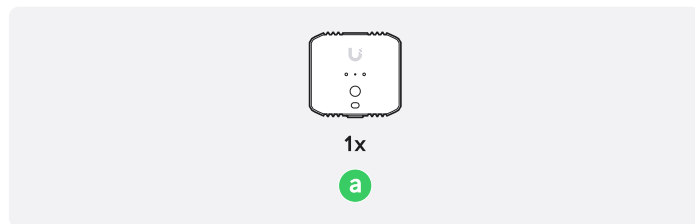
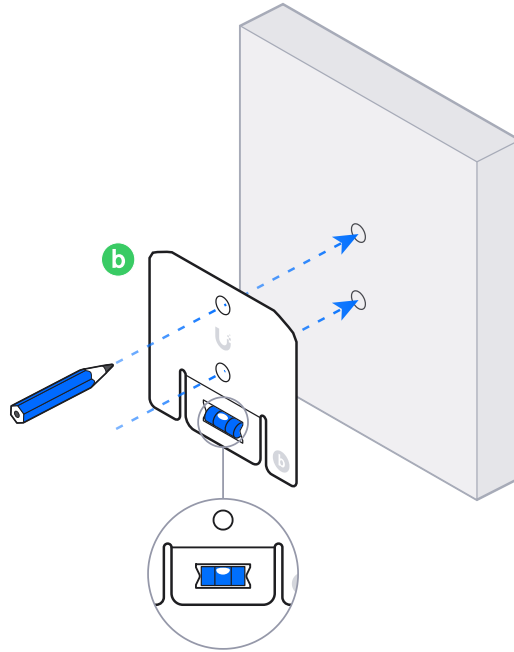
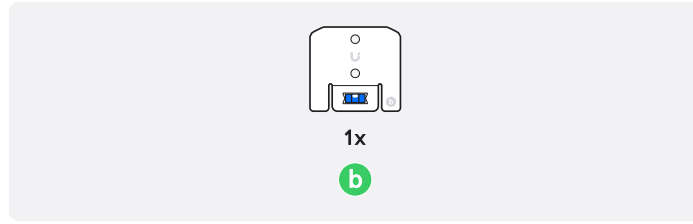

3

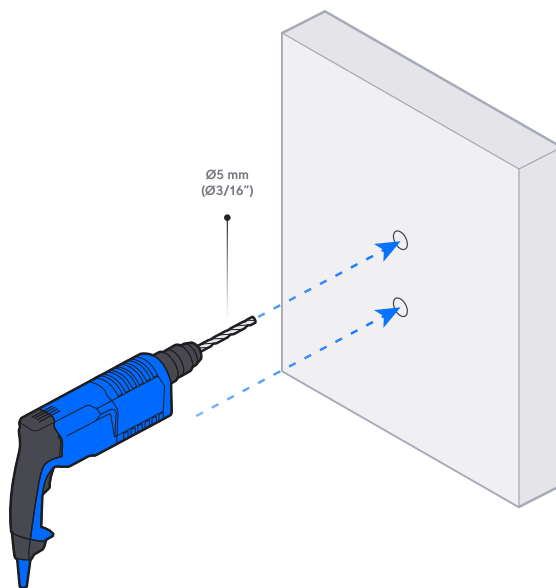

4

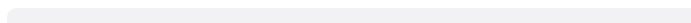

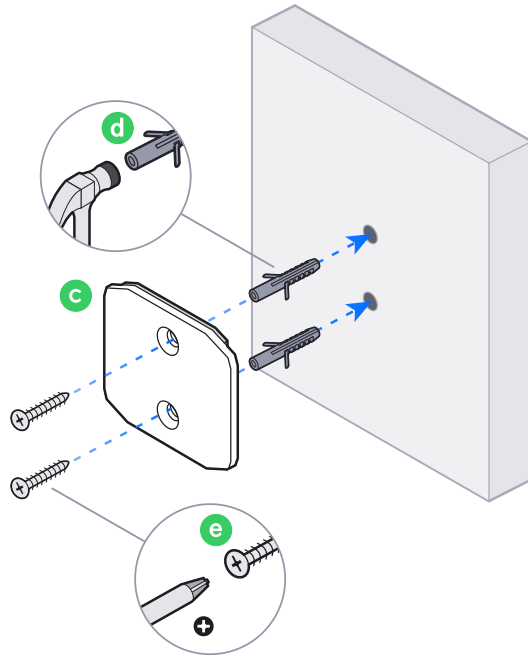
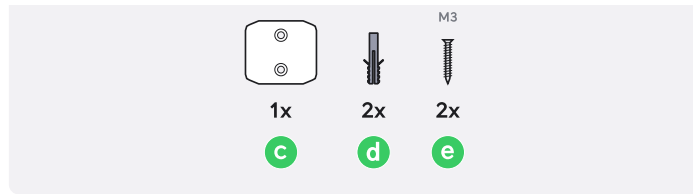

5

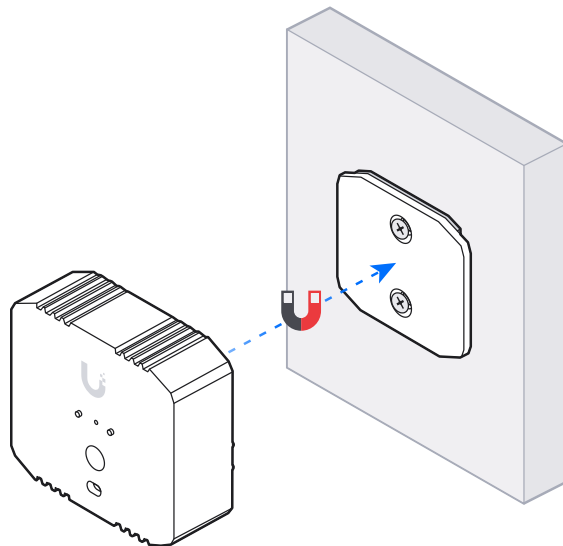

6



Internet

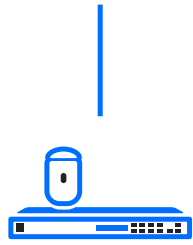

UniFi Cloud
Gateway

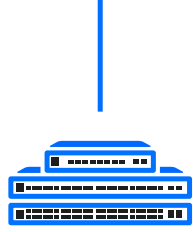

UniFi Switching



SuperLink
Gateway

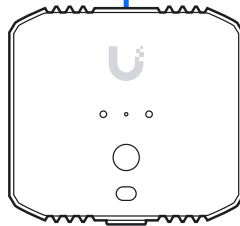

7



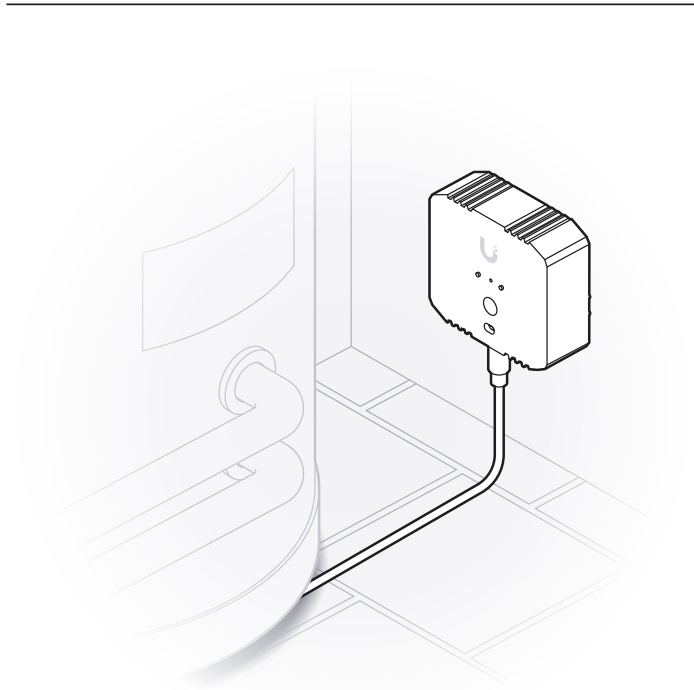

Water Detection Sensor Cable

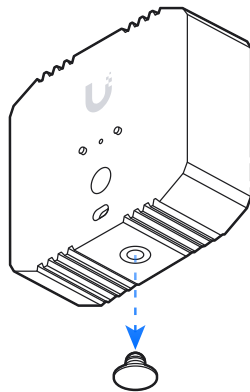
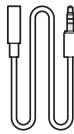

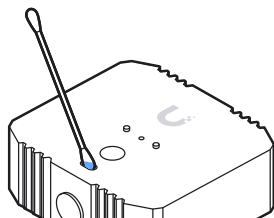
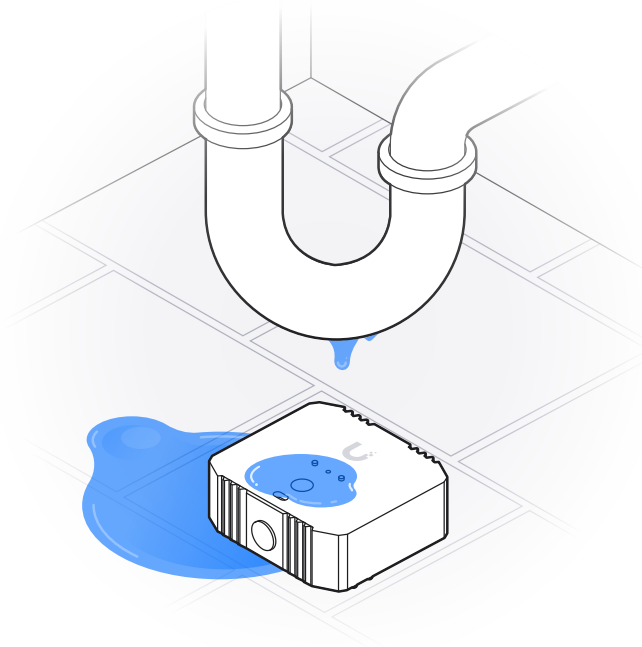
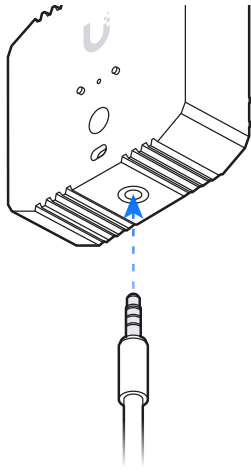

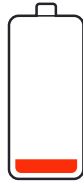

CR123A Battery

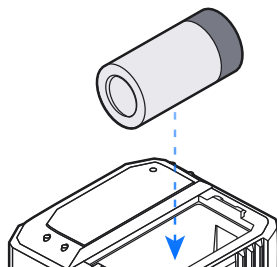
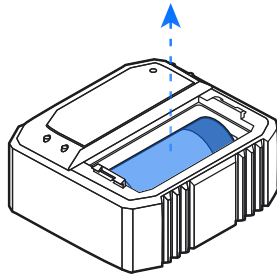
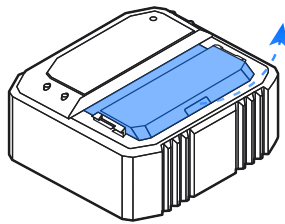
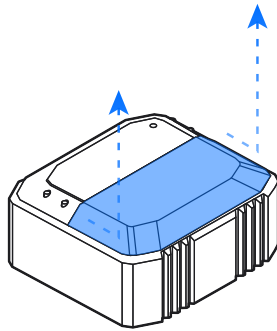

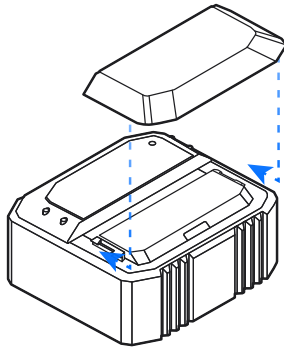
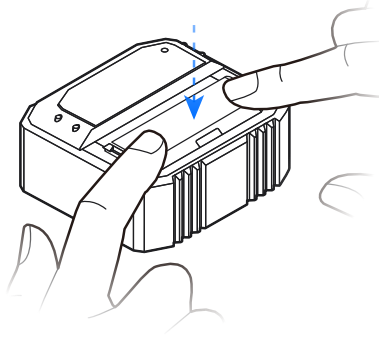
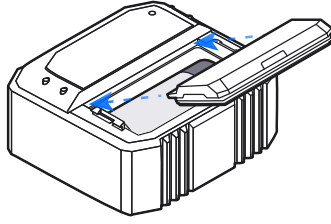
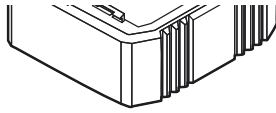

If you need further assistance, visit our [Help Center](#) or contact [Ubiquiti Support](#).

