

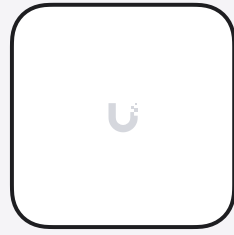

PoE Audio Port



1x

a

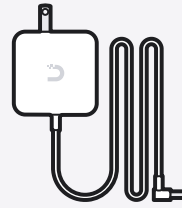

1x

b

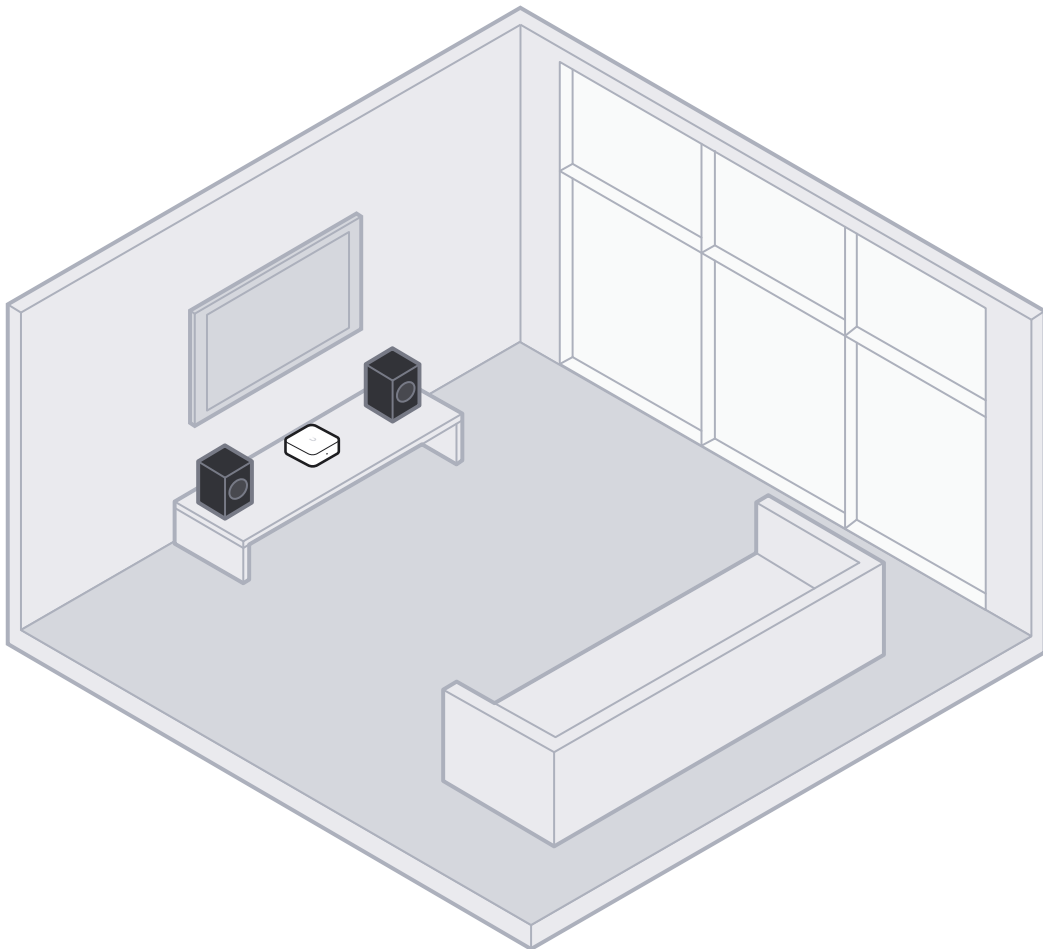

1

A

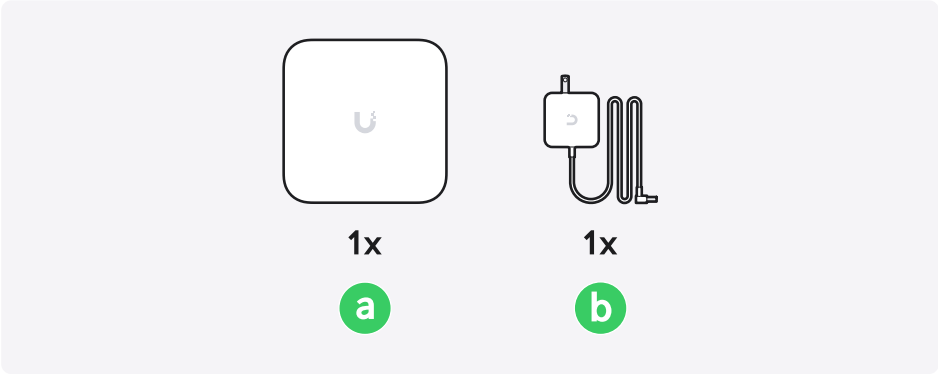

Internet

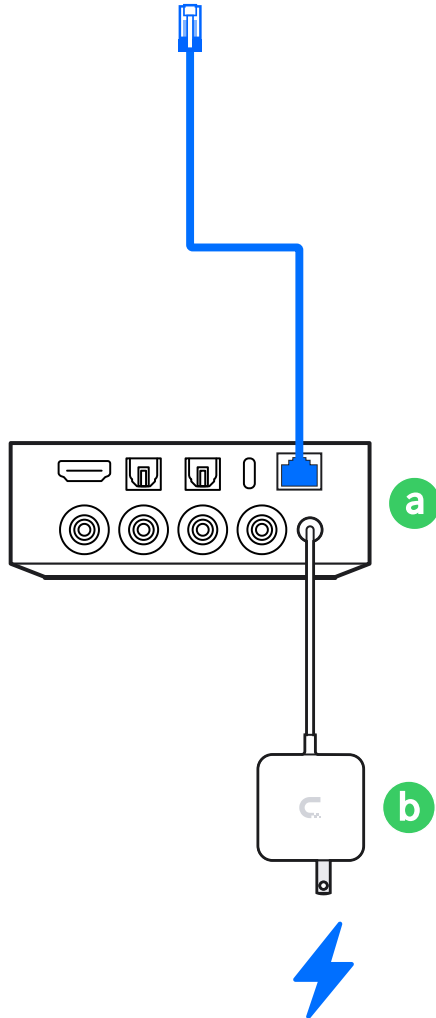

B

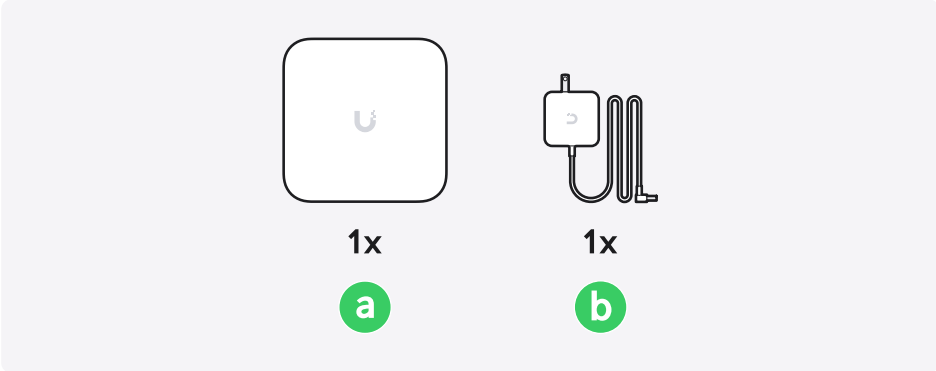

Internet



UniFi Cloud Gateway





Switching



UniFi Access Point

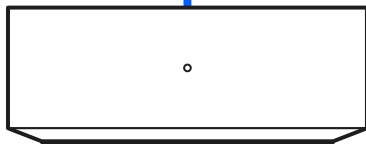

a

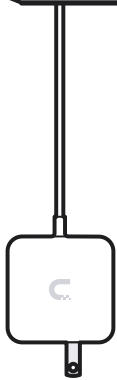

b



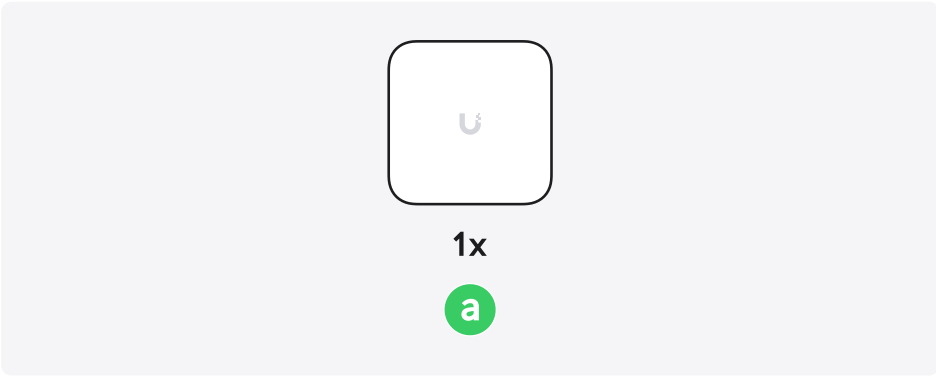

Internet

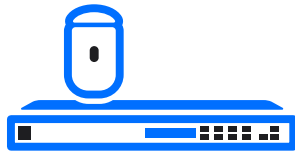

**UniFi Cloud
Gateway**



Switching



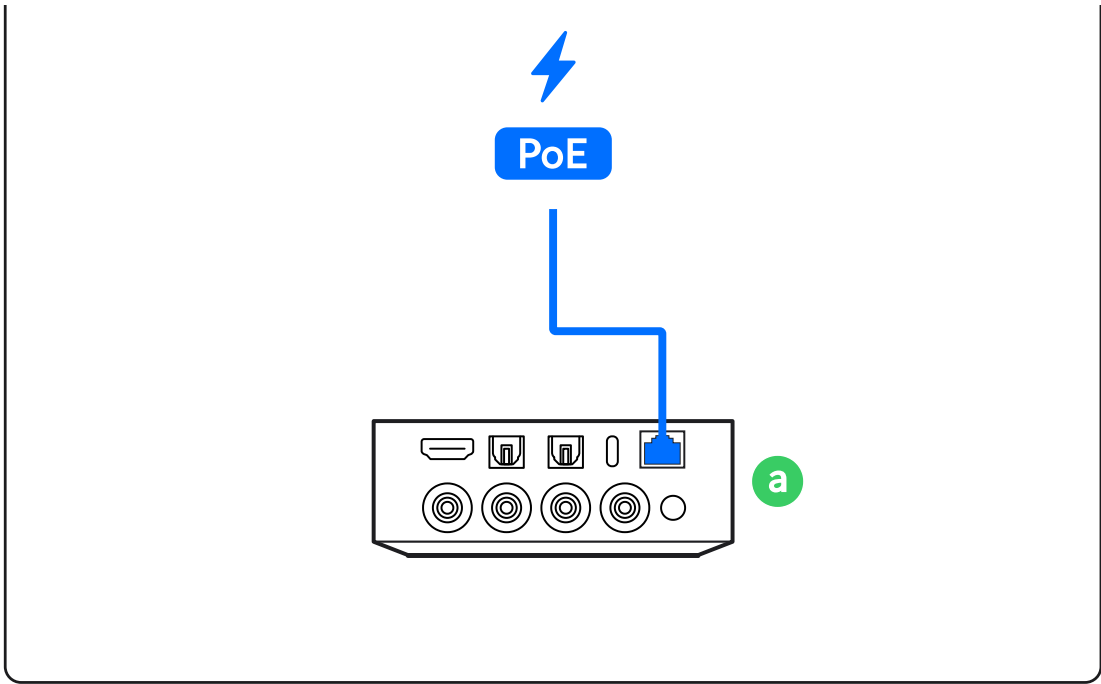

2

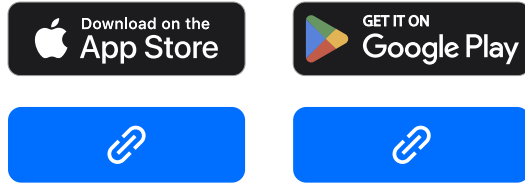

3

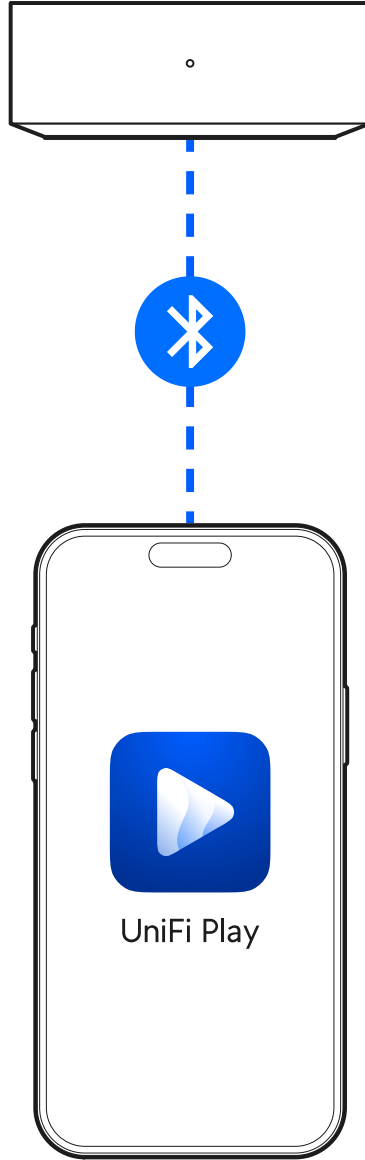

4

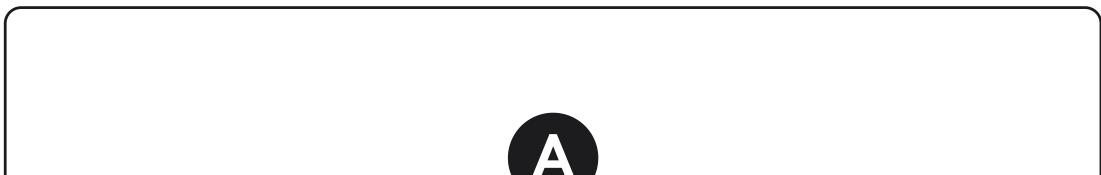

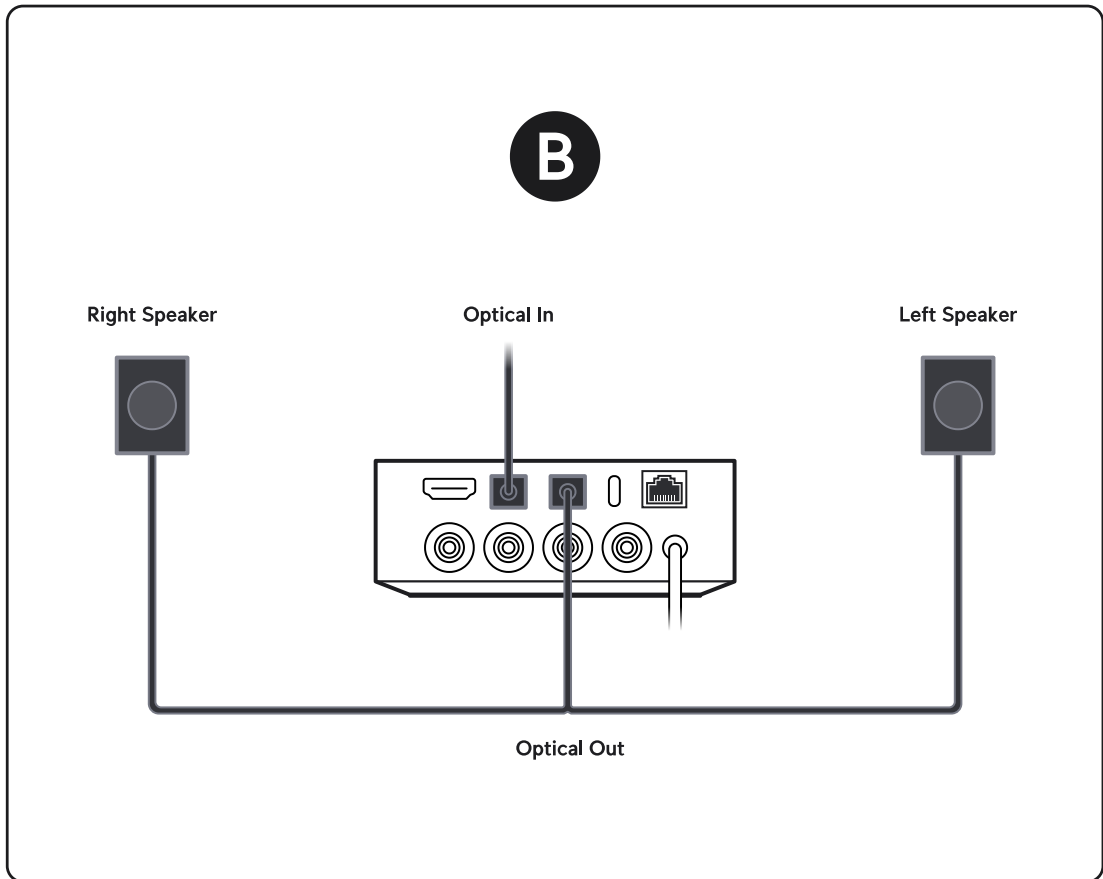
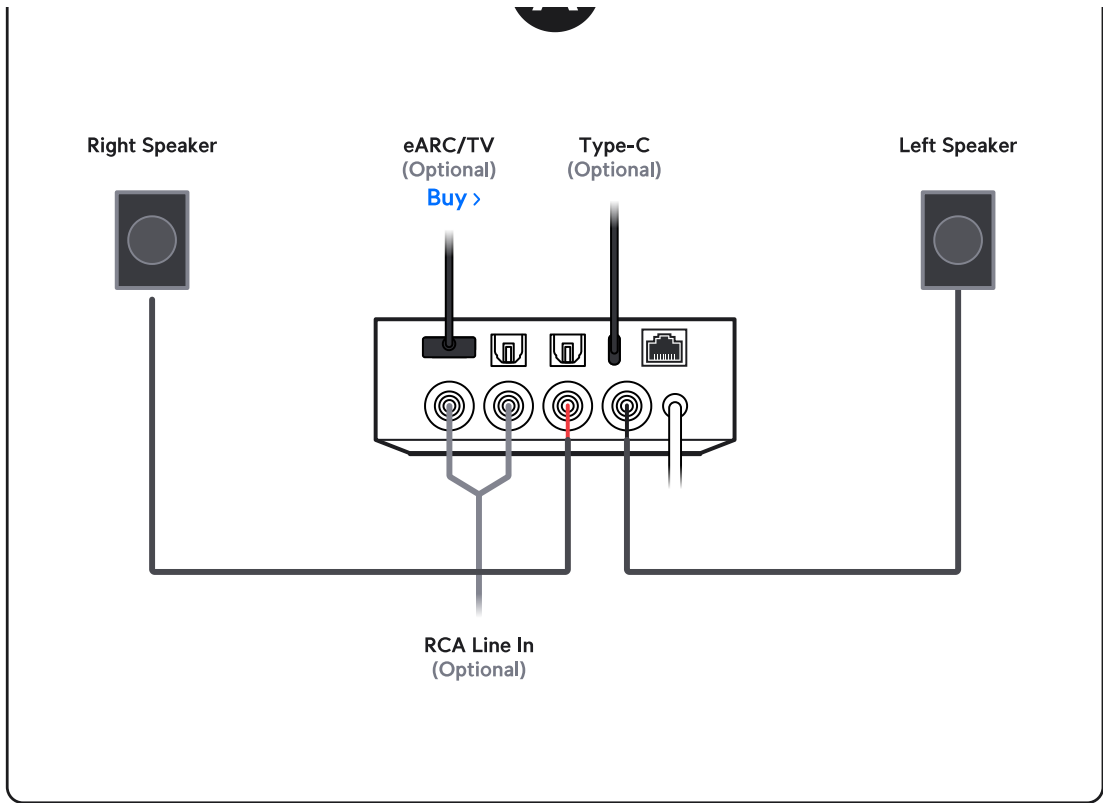

If you need further assistance, visit our [Help Center](#) or contact [Ubiquiti Support](#).



Use your phone, tablet or computer as a remote control for Spotify.
Go to spotify.com/connect to learn how.

©2025 Ubiquiti Inc. All rights reserved. Ubiquiti, the Ubiquiti U logo, UniFi and UniFi Play are trademarks or registered trademarks of Ubiquiti Inc. in the United States and other countries and regions. Apple, AirPlay and the Apple logo are trademarks of Apple Inc., registered in the U.S. and other countries and regions. App Store is a service mark of Apple Inc., registered in the U.S. and other countries and regions. Use of the Works with Apple AirPlay badge means that an accessory has been designed to work specifically with the technology identified in the badge and has been certified by the developer to meet Apple performance standards. To use AirPlay with UPL-Port the latest version of iOS, iPadOS, or macOS is recommended. Android, Google, Google Play, and the Google Play logo are trademarks of Google LLC. Spotify and the Spotify logo are trademarks of Spotify Technology SA. The Spotify Software is subject to third party licenses found here: <https://www.spotify.com/connect/third-party-licenses>. The terms HDMI, HDMI High-Definition Multimedia Interface, HDMI trade dress and the HDMI Logos are trademarks or registered trademarks of HDMI Licensing Administrator, Inc. All other trademarks are the property of their respective owners.