

# Lenovo Legion 27Q-11 User Guide

**Lenovo**

---

## Product numbers

A25270QG1  
67D3GAC1WW

First Edition (Jul, 2025)

© Copyright Lenovo 2025.

LENOVO products, data, computer software, and services have been developed exclusively at private expense and are sold to governmental entities as commercial items as defined by 48 C.F.R. 2.101 with limited and restricted rights to use, reproduction and disclosure.

LIMITED AND RESTRICTED RIGHTS NOTICE: If products, data, computer software, or services are delivered pursuant a General Services Administration "GSA" contract, use, reproduction, or disclosure is subject to restrictions set forth in Contract No. GS-35F-05925.

---

## Contents

<b>Safety information</b> .....	<b>iv</b>
General Safety guidelines .....	iv
<b>Chapter 1. Getting started</b> .....	<b>1-1</b>
Shipping contents .....	1-1
Notice for use .....	1-2
Product overview .....	1-2
Setting up your monitor .....	1-6
<b>Chapter 2. Adjusting and using your monitor</b> .....	<b>2-1</b>
Comfort and accessibility .....	2-1
Arranging your work area .....	2-1
Positioning and viewing your monitor .....	2-1
Quick tips for healthy work habits .....	2-2
Adjusting your monitor image .....	2-3
Selecting a supported display mode .....	2-8
Understanding power management .....	2-10
Caring for your monitor .....	2-11
Detaching the monitor base and stand .....	2-11
Wall Mounting (Optional) .....	2-11
<b>Chapter 3. Reference information</b> .....	<b>3-1</b>
Monitor specifications .....	3-1
Troubleshooting .....	3-3
Manually installing the monitor driver .....	3-5

---

<b>Appendix A. Service and Support.....</b>	<b>A-1</b>
Registering your option .....	A-1
Online technical support.....	A-1
Telephone technical support .....	A-1
<b>Appendix B. Notices.....</b>	<b>B-1</b>
Recycling information .....	B-2
Trademarks.....	B-3
Power cords and power adapters .....	B-3

---

# Safety information

---

## General Safety guidelines

For tips to help you use your computer safely, go to:  
<http://www.lenovo.com/safety>

Before installing this product, read the Safety Information.



### **DANGER**

#### **To avoid shock hazard:**

- Do not remove the covers.
- Do not operate this product unless the stand is attached.
- Do not connect or disconnect this product during an electrical storm.
- The power cord plug must be connected to a properly wired and grounded power outlet.
- Any equipment to which this product will be attached must also be connected to properly wired and grounded power outlets.
- To isolate the monitor from the electrical supply, you must remove the plug from the power outlet. The power outlet should be easily accessible.

The machine does not support 180 screen rotation.

To take special precautions to avoid the introduction of hazards when operating, installing, servicing, transporting or storing equipment, the necessary instructions shall be made available.

To reduce the risk of electric shock, do not perform any servicing other than that contained in the operating instructions unless you are qualified to do so.

#### **Handling:**

- If your monitor weighs more than 18 kg (39.68 lb), it is recommended that it be moved or lifted by two people.

---

# Chapter 1. Getting started

This User's Guide provides detailed operation instructions for the user. For quick instruction overview, please see the Setup Poster for brief information.

Legion 27Q-11 supports Lenovo Accessories and Display Manager **-Artery**.

---

## Shipping contents

The product package should include the following items:

- Information Flyer
- Lenovo Limited Warranty Booklet
- Stand
- Base
- Flat Panel Monitor
- Power Cord
- DP Cable
- Screws

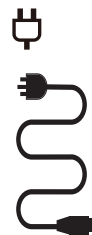
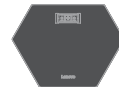
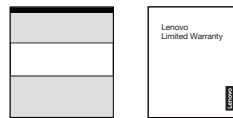

---

## Notice for use

To set up your monitor, please see the illustrations below.

**Note:** Do not touch the monitor within the screen area. The screen area is glass and can be damaged by rough handling or excessive pressure.

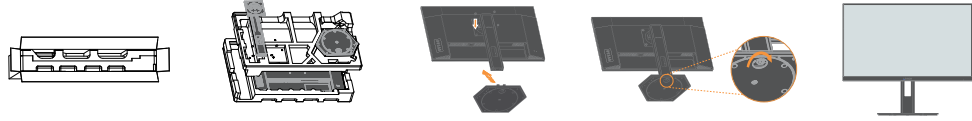

1. Take out the Top cushion and accessories.
2. Insert the base towards the stand and tighten the thumbscrew.
3. Mounting the stand to monitor's recess and tighten the screws.
4. Stand up the monitor with both hands carefully.

**Note:** To install a VESA mount, please see "Wall Mounting (Optional)" on page 2-11.

## Product overview

This section will provide information on adjusting monitor positions, setting user controls, and using the cable lock slot.

### Types of adjustments

#### Tilt

Please see the illustration below for an example of the tilt range.

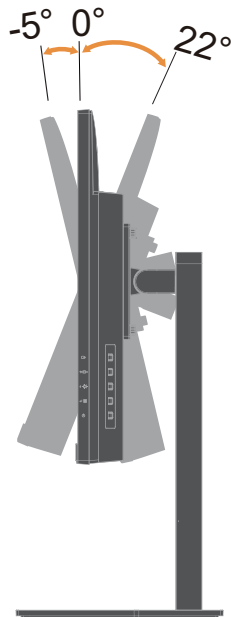

---

## Swivel

With the built-in pedestal, you can tilt and swivel the monitor for the most comfortable viewing angle.

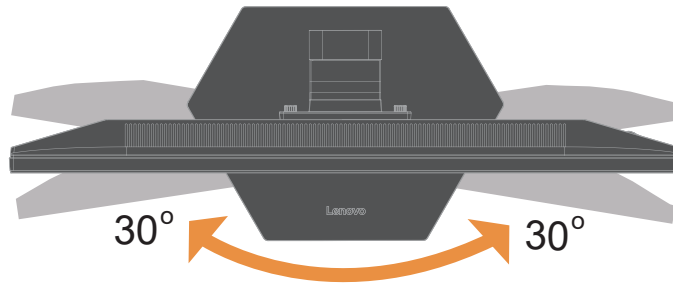

## Height Adjustment

For height adjustment, user needs to press down or lift up the monitor.

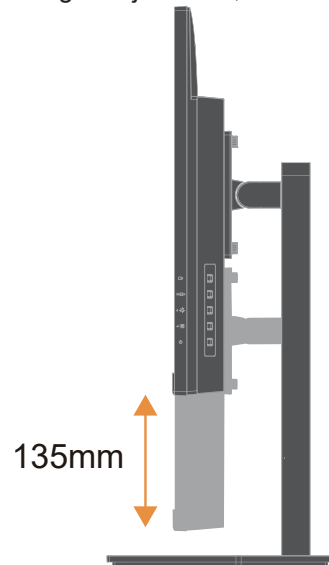

---

## Monitor

- Adjust the screen position before rotating the monitor screen. (Make sure that the monitor screen ascent to its highest point, and it inclines backward at 22°.)
- Then rotate until the monitor stops at 90°.

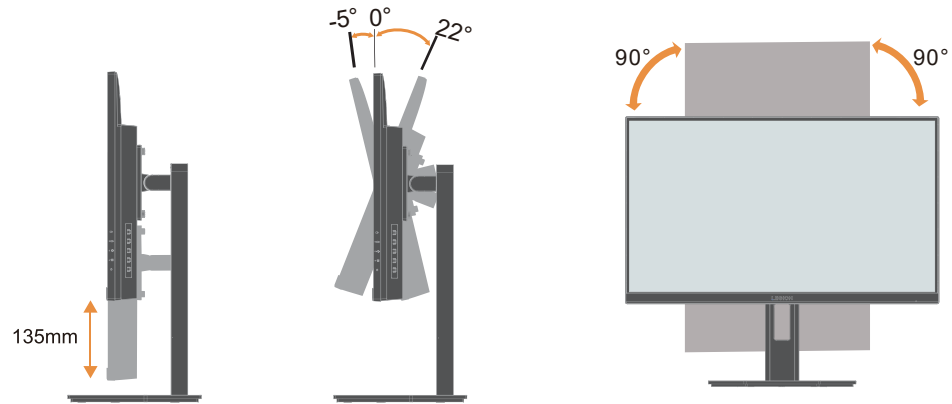

## Monitor controls

The keypad controls on the panel frame are accesses to various functions.

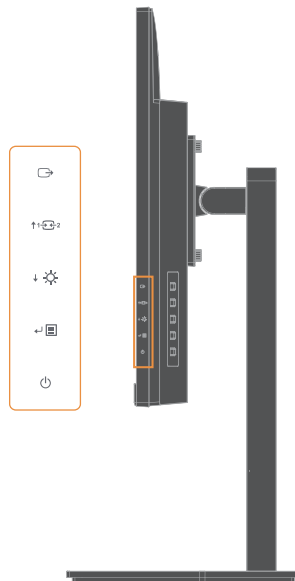

For information on how to utilize these keypad controls, please see “Adjusting your monitor image” on page 2-3.

---

## Kensington anti-theft lock

Your monitor is equipped with a Kensington anti-theft lock located on the rear of your monitor.

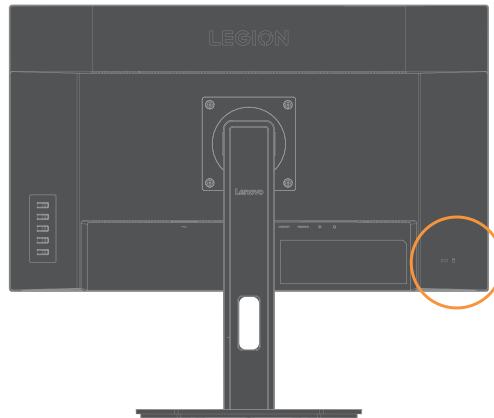

---

# Setting up your monitor

This section provides information on how to set up your monitor.

## Connecting and turning on your monitor

**Note:** Be sure to read the Safety information on page iv before carrying out this procedure.

1. Power off your computer and all attached devices, and unplug the computer power cord.

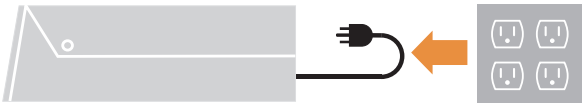

2. Connect the cables according to below icon indication.

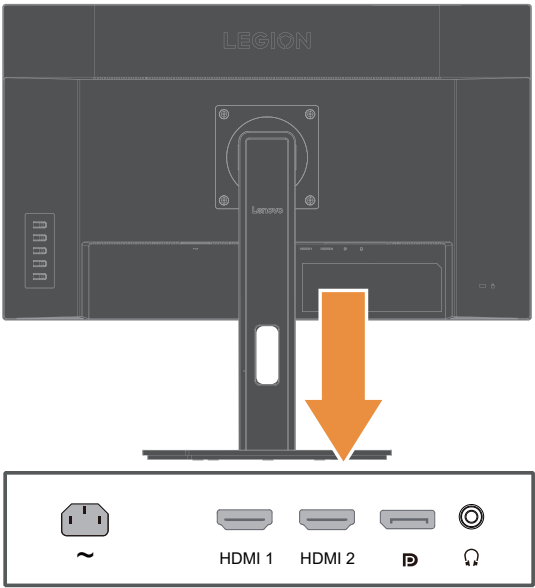

3. For computer in DP connecting.

DP

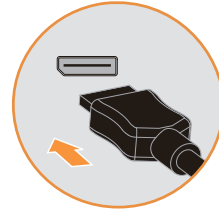
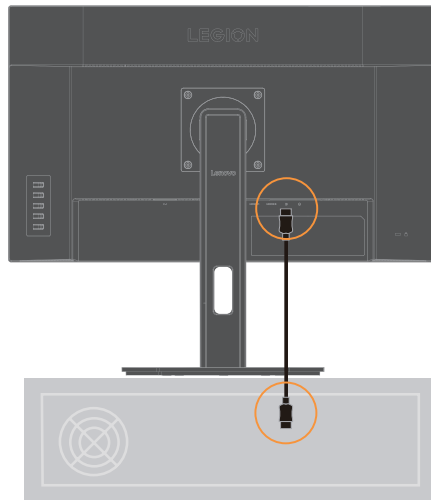

DP

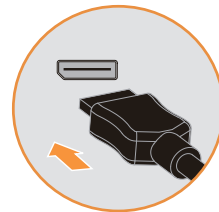

4. For computer in HDMI connecting.

**Note:** For other regions Lenovo recommends that customers who require to use the HDMI input on their monitor purchase the "Lenovo HDMI to HDMI cable OB47070"

<http://www.lenovo.com/support/monitoraccessories>

HDMI

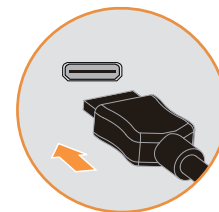

HDMI

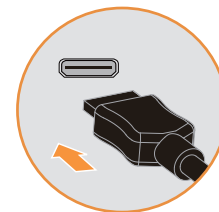

- 
5. Connect the speaker's audio cable and audio jack of monitor to transfer audio source from HDMI/DP.

**Note:** The audio output in HDMI/DP modes.

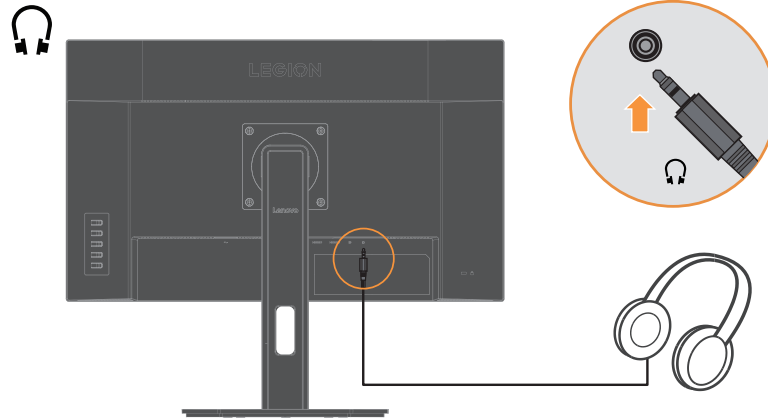

6. Insert the power cord into the monitor, then plug the monitor power cord and the computer cord into grounded electrical outlets.

**Note:** A certified power supply cord has to be used with this equipment. The relevant national installation and or equipment regulations shall be considered. A certified power supply cord not lighter than ordinary polyvinyl chloride flexible cord according to IEC 60227 (designation H05VV-F 3G 0.75mm<sup>2</sup> or H05VVH2-F2 3G 0.75mm<sup>2</sup> ) shall be used. Alternative a flexible cord be of synthetic rubber according to IEC 60245 (designation H05RR-F 3G 0.75mm<sup>2</sup> ) shall be used.

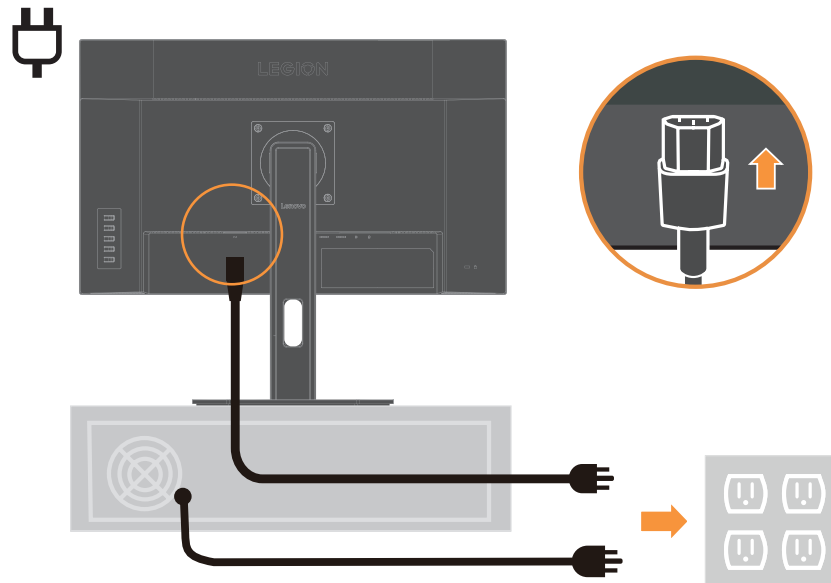

---

7. Connect the cables with cable clip.

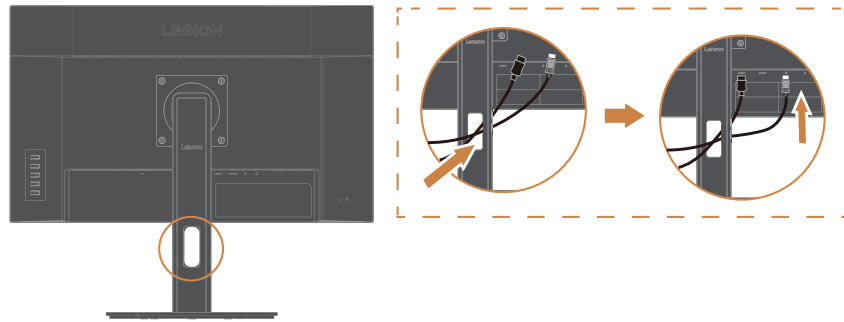

8. Power on the monitor and the computer.

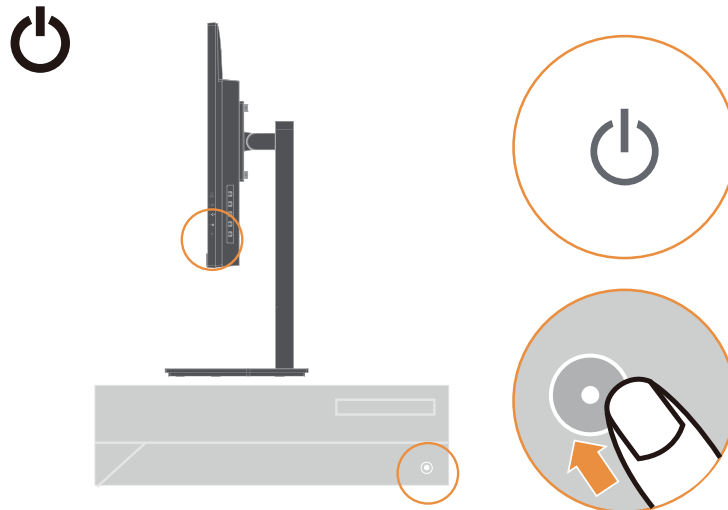

9. When you install the monitor driver, download the driver that corresponds to your monitor model from the Lenovo website [https://pcsupport.lenovo.com/solutions/legion\\_27q\\_11](https://pcsupport.lenovo.com/solutions/legion_27q_11). Refer to the ““Manually installing the monitor driver” on page 3-5” section to install the driver.



---

## Chapter 2.Adjusting and using your monitor

This section will give you information on adjusting and using your monitor.

---

### Comfort and accessibility

Good ergonomic practice is important to get the most from your personal computer and to avoid discomfort. Arrange your workplace and the equipment you use to suit your individual needs and the kind of work that you perform. In addition, use healthy work habits to maximize your performance and comfort while using your computer.

---

### Arranging your work area

Use a work surface of appropriate height and available working area to allow you to work in comfort.

Organize your work area to match the way you use materials and equipment. Keep your work area clean and clear for the materials that you typically use and place the items that you use most frequently, such as the computer mouse or telephone, within the easiest reach.

Equipment layout and setup play a large role in your working posture. The following topics describe how to optimize equipment setup to achieve and maintain good working posture.

---

### Positioning and viewing your monitor

Position and adjust your computer monitor for comfortable viewing by considering the following items:

- **Viewing distance:** Recommended viewing distance between the eye and the monitor screen is 1.5 x the diagonal of the screen. Solutions in meeting this required distance in cramped office situations include pulling desk away from wall or divider to make room for monitor, using flat panel or compact displays placing the monitor in the desk corner, or placing the keyboard in an adjustable drawer to create a deeper working surface.
- **Monitor height:** Position the monitor so your head and neck are in a comfortable and neutral (vertical, or upright) position. If your monitor does not have height adjustments, you might have to place books or other sturdy objects under the base of the monitor to achieve the desired height. A general guideline is to position the monitor such that the top of the screen is at or slightly below your eye-height when you are comfortably seated. However, be sure to optimize your monitor height so the line of site between your eyes and the center the monitor suits your preferences for visual distance and comfortable viewing when your eye muscles are in a relaxed state.
- **Tilt:** Adjust the tilt of your monitor to optimize the appearance of the screen content and to accommodate your preferred head and neck posture.
- **General location:** Position your monitor to avoid glare or reflections on the screen from overhead lighting or nearby windows.

The following are some other tips for comfortable viewing of your monitor:

- Use adequate lighting for the type of work you are performing.

- 
- Use the monitor brightness, contrast, and image adjustment controls, if equipped, to optimize the image on your screen to meet your visual preferences.
  - Keep your monitor screen clean so you can focus on the screen's contents.

Any concentrated and sustained visual activity can be tiring for your eyes. Be sure to periodically look away from your monitor screen and focus on a far object to allow your eye muscles to relax. If you have questions on eye fatigue or visual discomfort, consult a vision care specialist for advice.

---

## Quick tips for healthy work habits

The following information is a summary of some important factors to consider to help you remain comfortable and productive while you use your computer.

- **Good posture starts with equipment setup:** The layout of your work area and the setup of your computer equipment have a large effect on your posture while using your computer. Be sure to optimize the position and orientation of your equipment by following the tips outlined in “Arranging your work area ” on page 2-1 so you can maintain a comfortable and productive posture. Also, be sure to use the adjustment capabilities of your computer components and office furniture to best suit your preferences now and as your preferences change over time.
- **Minor changes in posture can help avoid discomfort:** The longer you sit and work in front of your computer, the more important it is to observe your working posture. Avoid assuming any one posture for an extended period of time. Periodically make minor modifications in your posture to help deter any discomforts that might arise. Make use of any adjustments that your office furniture or equipment provide to accommodate changes in posture
- **Short, periodic breaks help ensure healthy computing:** Because computing is primarily a static activity, it is particularly important to take short breaks from your work. Periodically, stand up in front of your work area, stretch, walk for a drink of water, or otherwise take a short break from using your computer. A short break from work gives your body a welcome change in posture and helps to ensure you remain comfortable and productive while you do work.





---

## Adjusting your monitor image

This section describes the user control features used to adjust your monitor image.

### Using the direct access controls

The direct access controls can be used when the On Screen Display (OSD) is not displayed.

	Icon	Control	Description
1		Exit	(1) Press to exit menu opened or return to previous level. (2) Press and hold for 10 seconds to Enable/Disable DDC/CI.
2		Source-selecting/Up	(1) Press to move the currently selected item on the main menu up from the current item. (2) Pressing the key increases the current value on the adjustment bar. (3) It is a shortcut for directly opening the menu of source-selecting while there is no OSD on the screen.
3		Brightness Adjustment/Down	(1) It is a shortcut for directly opening the adjustment bar of brightness while there is no OSD on the screen. (2) Press to move the currently selected item on the main menu down from the current item. (3) Press the key to reduce the current value on the adjustment bar.
4		Menu/OK	(1) Press to open main menu while there is no OSD on the screen. (2) Press to enter next level on main menu or sub menu, or return back to previous level while on adjustment bar. (3) Press and hold for 10 seconds to Lock/un-Lock main menu.
5		Power key	Press to turn On/Off the monitor.

---

## Using the On-Screen Display(OSD) controls

To adjust the settings, the user controls can be viewed through the OSD.

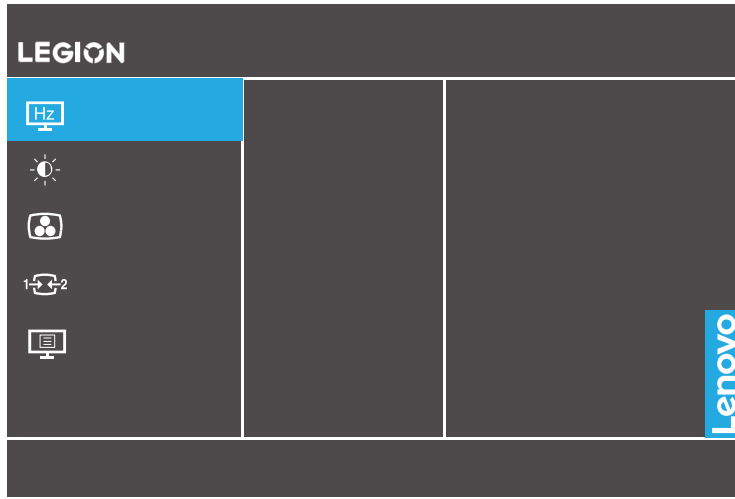

To use the controls:

1. Press  $\leftarrow$  to open the main OSD menu.
2. Use  $\uparrow$  or  $\downarrow$  to move among the icons. Select an icon and press  $\leftarrow$  to access that function. If there is a sub-menu, you can move between options using  $\uparrow$  or  $\downarrow$ , then press  $\leftarrow$  to select that function. Use  $\uparrow$  or  $\downarrow$  to make adjustments then press  $\leftarrow$  to save.
3. Press  $\leftarrow$  to move backwards through the sub-menus and exit from the OSD.

Table 2-1. OSD functions

OSD Icon on Main Menu	Sub menu	Description	Controls and Adjustments
Game Settings	Game Mode	<ul style="list-style-type: none"> <li>• Standard</li> <li>• FPS1</li> <li>• FPS2</li> <li>• Racing</li> <li>• RTS</li> <li>• Game1</li> <li>• Game2</li> </ul>	All input ports
	Over Drive	<ul style="list-style-type: none"> <li>• Off</li> <li>• Level 1</li> <li>• Level 2</li> <li>• Level 3</li> <li>• Level 4</li> </ul>	
	MPRT	<ul style="list-style-type: none"> <li>• On</li> <li>• Off</li> </ul> <p><b>Note:</b>            1)To enable MPRT, first disable FreeSync and HDR.            2)When MPRT is turned on, the brightness will be reduced.            3)When &gt;100Hz, MPRT turn on.  <b>Note:</b> Activate the MPRT function would create side-effects of ghosting and coronas by human eye and is restricted by refresh rate visibility period.</p>	
	AdaptiveSync	<ul style="list-style-type: none"> <li>• Auto (AMD FreeSync Premium )</li> <li>• Off</li> </ul>	for DP、 Type-C ports
	FreeSync	<ul style="list-style-type: none"> <li>• Auto</li> <li>• Off</li> </ul>	for HDMI ports
	Refresh Rate Num	<ul style="list-style-type: none"> <li>• Off</li> <li>• Left Top</li> <li>• Right Top</li> <li>• Left Bottom</li> <li>• Right Bottom</li> </ul>	All input ports

OSD Icon on Main Menu	Sub menu	Description	Controls and Adjustments
Screen Settings	Brightness	Adjusts overall screen brightness.	All input ports
	Contrast	Adjusts difference between light and dark areas.	
	DCR	Enable dynamic contrast ratio. • On • Off	
	HDR	• Auto • Off	
	Dark Boost	• Level1 • Level2 • Level3 • Level4	
	Scaling Mode	• Original AR • Full Screen	
	Sharpness	Adjust bar	
	Relative Gamma	• -0.4 • -0.2 • Default • +0.2 • +0.4 • Off	
	Video range	• Auto • Full range 0-255 • Limited range 16-235 <b>Note:</b> Refers to RGB range of HDMI input.	HDMI port
	DSC	• On • Off	All input ports
Color Settings	Color mode	• DCI-P3 • sRGB • Warm • Neutral • Cool • User *Custom mode can enter layer4 for RGB select, and enter layer 5 for RGB value tuning via slide bar	All input ports
Port Settings	Input Signal	• Auto Switch Input • DP • HDMI1 • HDMI2	
	DP Select	• DP1.2 • DP1.4	
	Mirrored Power Button	• HDMI	All input ports

OSD Icon on Main Menu	Sub menu	Description	Controls and Adjustments
Menu Settings	Information	<ul style="list-style-type: none"> <li>• Model</li> <li>• Firmware</li> <li>• Serial Number</li> <li>• HDR</li> <li>• Mode</li> <li>• Format</li> </ul>	All input ports
	Language	Select OSD Languages. <b>Note:</b> The language chosen only affects the language of the OSD. It has no effect on any software running on the computer.	
	Volume	Adjust Bar	
	Button Repeat Rate	<ul style="list-style-type: none"> <li>• Default</li> <li>• Slow</li> <li>• Off</li> </ul>	
	LED Indicator	<ul style="list-style-type: none"> <li>• On</li> <li>• Off</li> </ul>	
	OSD Timeout	Adjust Bar (5-60)	
	Menu Horizontal	Adjust Bar (0-100)	
	Menu Vertical	Adjust Bar (0-100)	
	Transparency	<ul style="list-style-type: none"> <li>• 0</li> <li>• 20</li> <li>• 40</li> <li>• 60</li> <li>• 80</li> <li>• 100</li> </ul>	
	DDC/CI	<ul style="list-style-type: none"> <li>• On</li> <li>• Off</li> </ul>	
Reset All Settings	<ul style="list-style-type: none"> <li>• Cancel</li> <li>• Factory Reset</li> </ul>		

\*The use of Level 3/Level 4 may result in reduced display quality when fast moving video graphics are displayed.

Users should check Level 3/Level 4 to verify if it is compatible with any applications they would like to use it with.

\*Low Blue Light: The display uses the low blue light panel. It complies with TÜV Rheinland Low Blue Light Hardware Solution certification under factory reset/default setting (Low Blue Light=Standard, Brightness:75%, Contrast: 75%, CCT: Warm).

\*Enable the display HDR function requires that the connected PC system supports the HDR function.

---

## Selecting a supported display mode

The display mode the monitor uses is controlled by the computer. Therefore, refer to your computer documentation for details on how to change display modes.

The image size, position and shape might change when the display mode changes. This is normal and the image can be re-adjusted using automatic image setup and the image controls.

Unlike CRT monitors, which require a high refresh rate to minimize flicker, LCD or Flat Panel technology is inherently flicker-free.

**Note:** According to the VESA standard, there may be a certain error (+/-1Hz) when calculating the refresh rate (field frequency) of different operating systems and graphics cards. In order to improve compatibility, the nominal refresh rate of this product has been rounded off. Please refer to the actual product.

*Table 2-2. Factory set display modes*

Timing	Refresh rate(Hz)
720x400	70Hz
640x480	60Hz
640x480	67Hz
640x480	72Hz
640x480	75Hz
800x600	60Hz
800x600	72Hz
800x600	75Hz
832x624	75Hz
1024x768	60Hz
1024x768	70Hz
1024x768	75Hz
1280x800	60Hz
1280x1024	60Hz
1280x1024	75Hz
1440x900	60Hz
1600x900	60Hz
1680x1050	60Hz
1920x1080	50Hz
1920x1080	60Hz
1920x1080	100Hz
1920x1080	120Hz
1920x1080	240Hz (only for DP)
2560x1440	60Hz
2560x1440	100Hz
2560x1440	120Hz
2560x1440	144Hz
2560x1440	165Hz (only for DP)
2560x1440	170Hz (only for DP)
2560x1440	180Hz (only for DP)
2560x1440	200Hz (only for DP)
2560x1440	240Hz (only for DP)
2560x1440	300Hz (only for DP)

---

Supports game console modes

PS 5	1080p@60Hz
	1080p@120Hz
	720p@60Hz
PS 4	1080p@60Hz
	720p@60Hz
X BOX one X	2160p@50Hz
	2160p@60Hz
	1080p@60Hz
	1080p@120Hz
	720p@60Hz
	640x480@60Hz
X BOX one S	2160p@50Hz
	2160p@60Hz
	1080p@60Hz
	1080p@120Hz
	720p@60Hz
	640x480@60Hz

---

## Understanding power management

Power management is invoked when the computer recognizes that you have not using your mouse or keyboard for a user-definable period. There are several states as described in the table below.

For optimal performance, switch off your monitor at the end of each working day, or whenever you expect to leave it unused for long periods during the day.

Table 2-3. Power indicator

State	Power Indicator	Screen	Restoring Operation
On	White	Normal	
Standby/ Suspend	Amber	Blank	Press a key or move the mouse. There may be a slight delay reappears. <b>Note:</b> Standby also occurs if there is no image output to the monitor.
Off	Off	Blank	Press power key to switch on There may be a slight delay before the image reappears.

### Power Management Modes

VESA Modes	Horizontal Sync	Vertical Sync	Video	Power Indicator	Power Consumption
Normal operation	Active	Active	Active	White	37 W (maximum)* 23 W (typical)
Active-off mode	Inactive	Inactive	Off	Amber	Less than 0.5 W
Switch off	-	-	-	Off	Less than 0.3 W

\*\* Maximum power consumption with max luminance.

This document is informational only and reflects laboratory performance. Your product may perform differently, depending on the software, components and peripherals you ordered and shall have no obligation to update such information. Accordingly, the customer should not rely upon this information in making decisions about electrical tolerances or otherwise. No warranty as to accuracy or completeness is expressed or implied.

---

## Caring for your monitor

Be sure to turn off the power before you perform any maintenance on the monitor.

### Do not:

- Apply water or liquid directly to your monitor.
- Use solvents or abrasives.
- Use flammable cleaning materials to clean your monitor or any other electrical equipment.
- Touch the screen area of your monitor with sharp or abrasive items. This type of contact may cause permanent damage to your screen.
- Use any cleaner which contains an anti-static solution or similar additives. This may harm the coating of the screen area.

### Do:

- Lightly dampen a soft cloth with water and use this to gently wipe the covers and the screen.
- Remove grease or finger marks with a damp cloth and a little mild detergent.

---

## Detaching the monitor base and stand

After placing the monitor face down on box with caution protected, remove the screws and lift the stand up to remove it from the monitor.

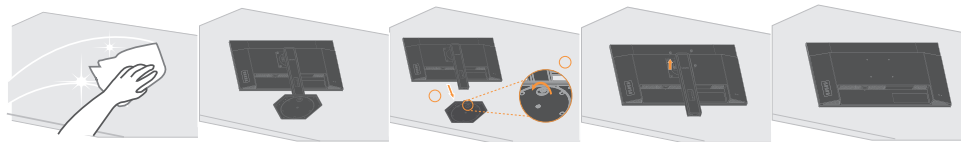

---

## Wall Mounting (Optional)

Refer to the instructions that come with the base mounting kit. To convert your LCD display from a desk-mounted to a wall-mounted display, do the following:

- Step 1: Verify that the Power button is turned off, then disconnect the power cord.  
Step 2: Lay the LCD display face down on a towel or blanket.

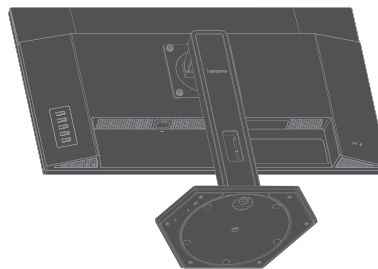

Step 3: Remove the base and stand from the monitor, refer to "Detaching the monitor base and stand" on page 2-11.

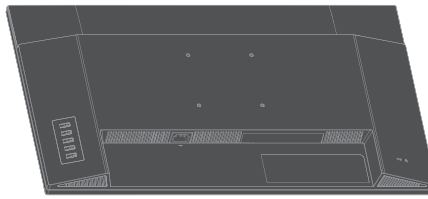

Step 4: Attach the mounting bracket from the VESA compatible wall mounting kit. (100mm x100mm distance), the type of VESA mounting screw is M4 x 10 mm.

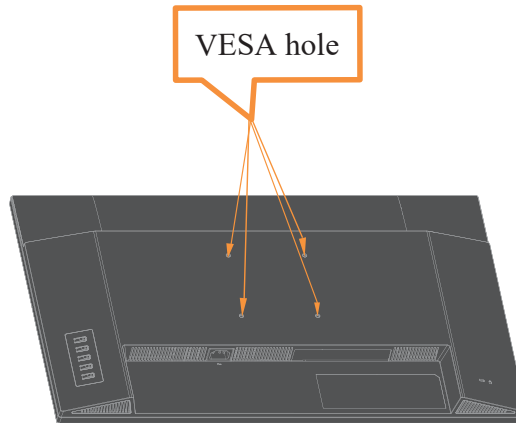

Step 5: Attach the LCD display to the wall, and follow the instructions in the wall-mounting kit. For use only with UL Listed Wall Mount Bracket with minimum weight/load: 8kg

**Note:**

When you use a flexible arm, do not tilt the monitor downward by more than 5 degrees.

The machine does not support 180° screen rotation.

---

## Chapter 3.Reference information

This section contains monitor specifications, instructions to manually install the monitor driver, troubleshooting information.

---

### Monitor specifications

Table 3-1. Monitor specifications for type-model Legion 27Q-11

Dimensions	Depth	214mm (8.42 in.)
	Height	529.2mm (20.83 in.)
	Width	613.73mm (24.16 in.)
Stand	Tilt	Range: -5°~22°
VESA mount	Supported	100 mm x 100 mm (3.94 in. x 3.94 in.)
Image	Viewable image size	685.8mm (27 in.)
	Maximum height	335.664mm (13.22 in.)
	Maximum width	596.736mm (23.49 in.)
	Pixel pitch	0.2331(H) x 0.2331(W)
Power input	Supply voltage	100-240V AC
	Max supply current	1.5A
Power consumption <b>Note:</b> Power consumption figures are for the monitor and the power supply combined. <b>Note:</b> Typical power consumption is tested under OSD default setting.	Normal operation	<37 W (Max) <23 W (Typical)
	Standby/Suspend	<0.5 W
	Off <b>Note:</b> without USB/ Webcam/external speaker	<0.3 W at 100VAC and 240VAC
DP	Interface	DP
	Horizontal addressability	2560 pixels (max)
	Vertical addressability	1440 lines (max)
	Clock frequency	1300 MHz (max)
HDMI	Interface	HDMI
	Input signal	VESA TMDS (Panel Link™)
	Horizontal addressability	2560 pixels (max)
	Vertical addressability	1440 lines (max)
	Clock frequency	600 MHz (max)
	Horizontal frequency	270 kHz – 470 kHz (DP)
	Vertical frequency	48 Hz – 144 Hz (HDMI) 48 Hz – 300Hz (DP)
Communications	VESA DDC/CI	

Supported Display Modes	Horizontal frequency	30 kHz – 230 kHz(HDMI) 270 kHz – 360 kHz(DP)
	Vertical frequency	48 Hz – 144 Hz (HDMI) 48 Hz – 240 Hz (DP)
	Native Resolution	2560 x 1440 @ 60 Hz
Temperature	Operating	0° to 40°C (32°F to 104° F)
	Storage	-20° to 60°C (-4°F to 140° F)
	Shipping	-20° to 60°C (-4° F to 140° F)
Humidity	Operating	10% to 80% non-condensing
	Storage	5% to 95% non-condensing
	Shipping	5% to 95% non-condensing
Weight	Net Weight	5.55kg

## Troubleshooting

If you have a problem setting up or using your monitor, you might be able to solve it yourself. Before calling your dealer or Lenovo, try the suggested actions that are appropriate to your problem.

Table 3-2. Troubleshooting

Problem	Possible cause	Suggested action	Reference
The words "Out of Range" are shown on the screen, and the power indicator is flashing white.	The system is set to a display mode which is not supported by the monitor	<ul style="list-style-type: none"> <li>• If you are replacing an old monitor, reconnect it and adjust the display mode to within the specified range for your new monitor.</li> <li>• If using a Windows system, restart the system in safe mode, then select a supported display mode for your computer.</li> <li>• If these options do not work, contact the Customer Support Centre.</li> </ul>	"Selecting a supported display mode" on page 2-8
The image quality is unacceptable	The video signal cable is not connected with the monitor or system completely.	Be sure the signal cable is firmly plugged into the system and monitor.	"Connecting and turning on your monitor" on page 1-6
	The color settings may be incorrect.	Select another color setting from the OSD menu.	"Adjusting your monitor image" on page 2-3
	The automatic image setup function was not performed.	Perform automatic image setup.	"Adjusting your monitor image" on page 2-3
The power indicator is not lit and there is no image.	<ul style="list-style-type: none"> <li>• The monitor's power switch is not switched on.</li> <li>• The power cord is loose or disconnected.</li> <li>• There is no power at the outlet.</li> </ul>	<ul style="list-style-type: none"> <li>• Be sure the power cord is connected properly.</li> <li>• Be sure the outlet has power.</li> <li>• Power on the monitor.</li> <li>• Try using another power cord.</li> <li>• Try using another electrical outlet.</li> </ul>	"Connecting and turning on your monitor" on page 1-6
Screen is blank and power indicator is amber.	The monitor is in Standby / Suspend mode	<ul style="list-style-type: none"> <li>• Press any key on the keyboard or move the mouse to restore operation.</li> <li>• Check the Power options settings on your computer.</li> </ul>	"Understanding power management" on page 2-7
The power indicator is amber, but there is no image	The video signal cable is loose or disconnected from the system or monitor	Be sure the video cable is connected with the system properly	"Connecting and turning on your monitor" on page 1-6
	The monitor brightness and contrast are at the lowest setting.	Adjust the brightness and contrast setting on the OSD menu.	"Adjusting your monitor image" on page 2-3

<b>Problem</b>	<b>Possible cause</b>	<b>Suggested action</b>	<b>Reference</b>
One or more of the pixels appear discolored	This is a characteristic of the LCD technology and is not an LCD defect	If there are more than five pixels missing, contact the Support Center	"Appendix A, Service and Support" on page A-1
<ul style="list-style-type: none"> <li>• Fuzzy lines in text or a blurry image</li> <li>• Horizontal or vertical lines through the image.</li> </ul>	<ul style="list-style-type: none"> <li>• Image setup has not been optimized</li> <li>• Your system Display Properties setting have not been optimized.</li> </ul>	Adjust the resolution settings on your system to match the native resolution for this monitor: 2560 x 1440 @ 60 Hz.	"Adjusting your monitor image" on page 2-3
		Perform automatic image setup. If automatic image setup does not help, perform manual image setup.	"Selecting a supported display mode" on page 2-8
		When working in the native resolution, you may find additional improvements by adjusting the Dots Per Inch (DPI) setting on your system.	See the Advanced section of your system's display properties.

---

## Manually installing the monitor driver

Below are steps for manually installing the monitor driver in Microsoft Windows 10, Microsoft Windows 11.

1. Turn off the computer, all attached devices.
2. Ensure that the monitor is connected correctly.
3. Turn on the monitor and then the system unit. Allow your computer to start the Windows operating system.
4. From the Lenovo website [https://pcsupport.lenovo.com/solutions/legion\\_27q\\_11](https://pcsupport.lenovo.com/solutions/legion_27q_11), find the corresponding monitor driver and download it to a PC to which this monitor is connected (such as a desktop).
5. Right-click the Windows Start button on the desktop, then click Device Manager, and double click Monitor.
6. Double-click Generic Monitor.
7. Click the Driver tab.
8. Click Update Driver, and then click Browse Computer to find the driver.
9. Click Let me pick from a list of available drivers on my computer.
10. Click the Have Disk... button. By clicking the Browse button, browse and point to the following path: X:\Monitor Drivers\Windows (where X indicates "the folder in which the downloaded driver is located" (such as a desktop)).
11. Select 27q-11.inf file, Click Open button. Click OK button.
12. In the new window, select Legion 27Q-11 and click Next.
13. After the installation is complete, delete all downloaded files and close all Windows.
14. Restart the system. The system will automatically select the refresh rate and the corresponding color matching profile.

---

## Appendix A. Service and Support

The following information describes the technical support that is available for your product, during the warranty period or throughout the life of the product. Refer to your Lenovo Statement of Limited Warranty for a fully explanation of Lenovo warranty terms.

---

### Registering your option

Register to receive product service and support updates, as well as free and discounted computer Accessories and content. Go to: <http://www.lenovo.com/support>

---

### Online technical support

Online technical support is available during the life of your product through the Lenovo Support Web site at <http://www.lenovo.com/support>

Product replacement assistance or exchange of defective components also is available during the warranty period, assistance for replacement or exchange of defective components is available. In addition, if your option is installed in a Lenovo computer, you might be entitled to service at your location. Your technical support representative can help you determine the best alternative.

---

### Telephone technical support

Installation and configuration support through the Customer Support Center will be available until 90 days after the option has been withdrawn from marketing. After that time, the support is cancelled, or made available for a fee, at Lenovo's discretion. Additional support is also available for a nominal fee.

Before contacting a Lenovo technical support representative, please have the following information available: option name and number, proof of purchase, computer manufacturer, model, serial number and manual, the exact wording of any error message, description of the problem, and the hardware and software configuration information for your system.

Your technical support representative might want to walk you through the problem while you are at your computer during the call.

Telephone numbers are subject to change without notice. The most up-to-date telephone list for Lenovo Support is always available at: <http://www.lenovo.com/support>

Country or Region	Telephone Number
China	400-990-8888
South Africa	800982393
Argentina	0800-444-2722(Spanish)
Australia	1300-557-073
Austria	800295730(German)
Belgium	80076524(French, Dutch)
Bolivia	800-100-764(Spanish)

---

## Appendix B. Notices

Lenovo may not offer the products, services, or features discussed in this document in all countries. Consult your local Lenovo representative for information on the products and services currently available in your area. Any reference to a Lenovo product, program, or service is not intended to state or imply that only that Lenovo product, program, or service may be used. Any functionally equivalent product, program, or service that does not infringe any Lenovo intellectual property right may be used instead. However, it is the user's responsibility to evaluate and verify the operation of any other product, program, or service.

Lenovo may have patents or pending patent applications covering subject matter described in this document. The furnishing of this document does not give you any license to these patents. You can send license inquiries, in writing to:

*Lenovo (United States), Inc.  
1009 Think Place - Building One  
Morrisville, NC 27560  
U.S.A.  
Attention: Lenovo Director of Licensing*

LENOVO PROVIDES THIS PUBLICATION "AS IS" WITHOUT WARRANTY OF ANY KIND, EITHER EXPRESS OR IMPLIED, INCLUDING, BUT NOT LIMITED TO THE IMPLIED WARRANTIES OF NON-INFRINGEMENT, MERCHANTABILITY OR FITNESS FOR A PARTICULAR PURPOSE.

Some jurisdictions do not allow disclaimer of express or implied warranties in certain transactions, therefore, this statement may not apply to you.

This information could include technical inaccuracies or typographical errors. Changes are periodically made to the information herein; these changes will be incorporated in new editions of the publication. Lenovo may make improvements and/or changes in the product(s) and/or the program(s) described in this publication at any time without notice.

The products described in this document are not intended for use in implantation or other life support applications where malfunction may result in injury or death to persons. The information contained in this document does not affect or change Lenovo product specifications or warranties. Nothing in this document shall operate as an express or implied license or indemnity under the intellectual property rights of Lenovo or third parties. All information contained in this document was obtained from specific environments and presented as an illustration. The result obtained in other operating environments may vary.

Lenovo may use or distribute any of the information you supply in any way it believe appropriate without incurring any obligation to you.

Any references in this publication to non-Lenovo Web sites are provided for convenience only and do not in any manner serve as an endorsement of those Web sites. The materials at those Web sites are not part of the materials for this Lenovo product, and use of those Web sites is at your own risk.

Any performance data contained herein was determined in a controlled environment. Therefore, the result obtained in other operating environments may vary significantly. Some measurements may have been made on development-level systems and there is no guarantee that these measurements will be the same on generally available systems. Furthermore, some measurements may have been estimated through extrapolation. Actual results may vary. Users of this

---

document should verify the applicable data for their specific environment.

## Recycling information

Lenovo encourages owners of information technology (IT) equipment to responsibly recycle their equipment when it is no longer needed. Lenovo offers a variety of programs and services to assist equipment owners in recycling their IT products. For information on recycling Lenovo products, go to:

<http://www.lenovo.com/recycling>

環境配慮に関して

本機器またはモニターの回収リサイクルについて

企業のお客様が、本機器が使用済みとなり廃棄される場合は、資源有効利用促進法の規定により、産業廃棄物として、地域を管轄する県知事あるいは、政令市長の許可を持った産業廃棄物処理業者に適正処理を委託する必要があります。また、弊社では資源有効利用促進法に基づき使用済みパソコンの回収および再利用・再資源化を行う「PC回収リサイクル・サービス」を提供しています。詳細は、[https://www.lenovo.com/jp/ja/services\\_warranty/recycle/pcrecycle/](https://www.lenovo.com/jp/ja/services_warranty/recycle/pcrecycle/)をご参照ください。

また、同法により、家庭で使用済みとなったパソコンのメーカー等による回収再資源化が2003年10月1日よりスタートしました。詳細は、[https://www.lenovo.com/jp/ja/services\\_warranty/recycle/pcrecycle/](https://www.lenovo.com/jp/ja/services_warranty/recycle/pcrecycle/)をご参照ください。

重金属を含む内部部品の廃棄処理について

本機器のプリント基板等には微量の重金属（鉛など）が使用されています。使用後は適切な処理を行うため、上記「本機器またはモニターの回収リサイクルについて」に従って廃棄してください。

### Collecting and recycling a disused Lenovo computer or monitor

If you are a company employee and need to dispose of a Lenovo computer or monitor that is the property of the company, you must do so in accordance with the Law for Promotion of Effective Utilization of Resources. Computers and monitors are categorized as industrial waste and should be properly disposed of by an industrial waste disposal contractor certified by a local government. In accordance with the Law for Promotion of Effective Utilization of Resources, Lenovo Japan provides, through its PC Collecting and Recycling Services, for the collecting, reuse, and recycling of disused computers and monitors. For details, visit the Lenovo Web site at

[https://www.lenovo.com/jp/ja/services\\_warranty/recycle/pcrecycle/](https://www.lenovo.com/jp/ja/services_warranty/recycle/pcrecycle/). Pursuant to the Law for Promotion of Effective Utilization of Resources, the collecting and recycling of home-used computers and monitors by the manufacturer was begun on October 1, 2003. This service is provided free of charge for home-used computers sold after October 1, 2003. For details, visit the Lenovo Web site at [https://www.lenovo.com/jp/ja/services\\_warranty/recycle/personal/](https://www.lenovo.com/jp/ja/services_warranty/recycle/personal/).

### Disposing of Lenovo computer components

Some Lenovo computer products sold in Japan may have components that contain heavy metals or other environmental sensitive substances. To properly dispose of disused components, such as a printed circuit board or drive, use the methods described above for collecting and recycling a disused computer or monitor.

---

## Trademarks

The following terms are trademarks of Lenovo in the United States, other countries, or both:

- Lenovo
- The Lenovo logo
- ThinkCentre
- ThinkPad
- ThinkVision

Microsoft, Windows, and Windows NT are trademarks of the Microsoft group of companies.

Other company, product, or service names may be trademarks or service marks of others.

---

## Power cords and power adapters

Use only the power cords and power adapters supplied by the product manufacturer. Do not use the ac power cord for other devices.