

5.5" HDMI High Bright Field Monitor

F970 Install and Power Kit

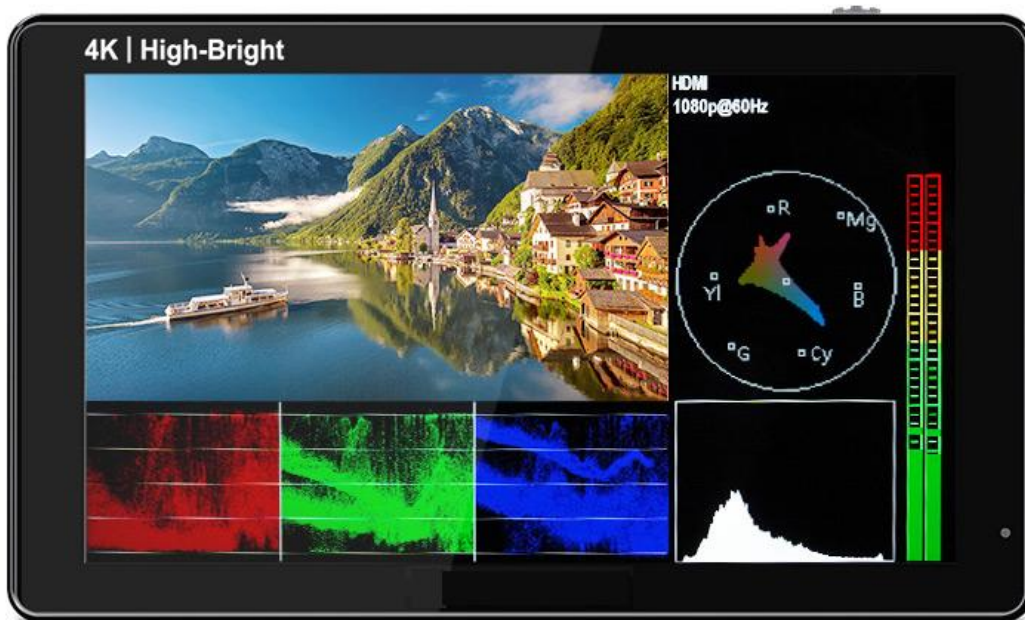

User Manual

Product Overview

Thank you for using our 5.5-inch high bright touch screen monitor. This monitor is clearly visible in sunlight, full HD LCD touch screen for easy operation. Supports HDMI signal up to 4K@30Hz, HDR monitoring, custom 3D LUT and other professional auxiliary composition tools.

The rear of monitor comes with a F970 external install and power kit, can install such as wireless transmission, LED light, etc. It combines the monitor with wireless transmission to get rid of unnecessary cables, , which is perfect for director monitoring, 1st AC to focus pulling in the film crew. The compact size and lightweight can be used with a gimbal to move quickly on set.



To insure the best use of the unit, please read the user's manual carefully

CAUTION

1. Please avoid the heavy impact and drop onto the ground when move the product.
2. The screen of this product is made of glass.Keep away from injury if the screen is broken.
3. Keep the product away from the heat source, and avoid the prolonged exposures to the sun as the LCD screen will be damaged.
4. Please do NOT use chemical solutions to clean this product. Please wipe the monitor with a clean soft cloth to maintain the brightness of the surface.
5. No adjustable components are in the monitor. Please do not take apart or repair the unit by yourself, to avoid the damage of the product.

FEATURES

- ✦ 1920x1080 full HD IPS screen
- ✦ Touch screen menu operation, improve shooting efficiency
- ✦ Ultra-bright 1600nit, clearly visible in the sun
- ✦ Light sensor auto dimming
- ✦ Support HDR monitoring, what you see is what you get
- ✦ Support 3D LUT Log to REC.709 and user 3D LUT upload
- ✦ Sony F970 external install and power kit design can be used to install and supply power to external equipment, easy to install and disassemble, simplify your photography equipment.
- ✦ With Waveform, Vector scope, RGB Histogram, Focus Assist, Monochrome etc. functions, can help you accurately exposure and focus every shot.
- ✦ Stereo Earphone output
- ✦ DC 8V power out to power your DSLR camera or mirrorless camera

CONTENTS

1. Product Description	4
1.1 Front Panel Instruction	4
1.2 Rear Panel Instruction	4
1.3 Top Button Instruction	5
1.4 Bottom Port Instruction	6
1.5 Left Port Instruction	6
1.6 Power Supply Way	7
1.7 Sony F970 Install and Power Kit	7
1.8 Installation Way	8
2. Menu Operation Instruction	9
3. Menu Function Instruction	11
4. How to Load LUT	15
5. Support Formats	16
6. Technical Parameters	16
7. Trouble Shooting	17

1. Product Description

1.1 Front Panel Instruction

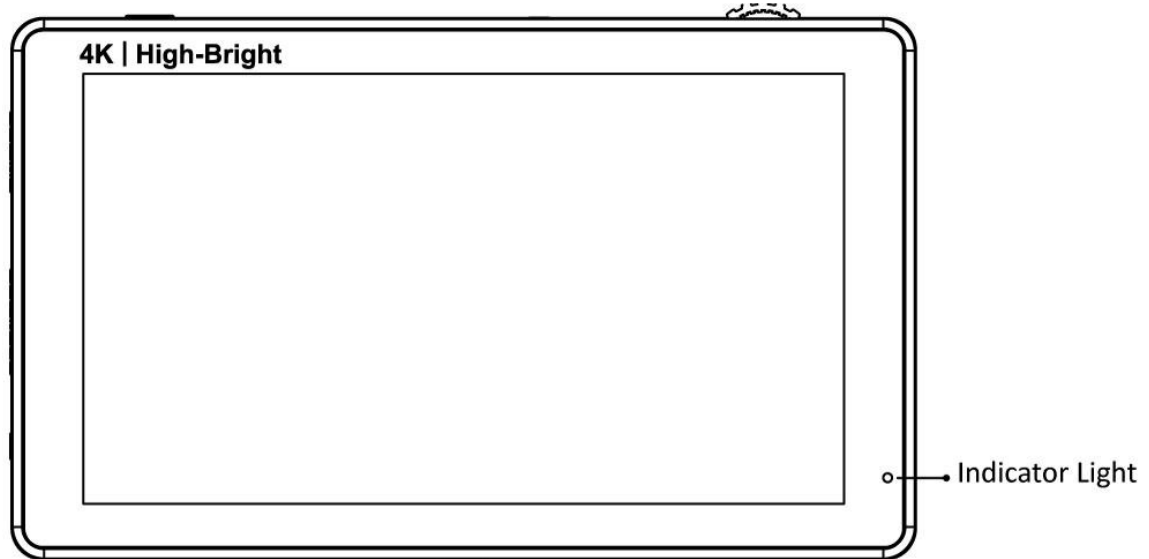

Indicator Light: After connecting the power, the indicator light is on (red). Long Press  / TOUCH button to turn on the monitor, it turns yellow. After the signal is connected, it turns green.

1.2 Rear Panel Instruction

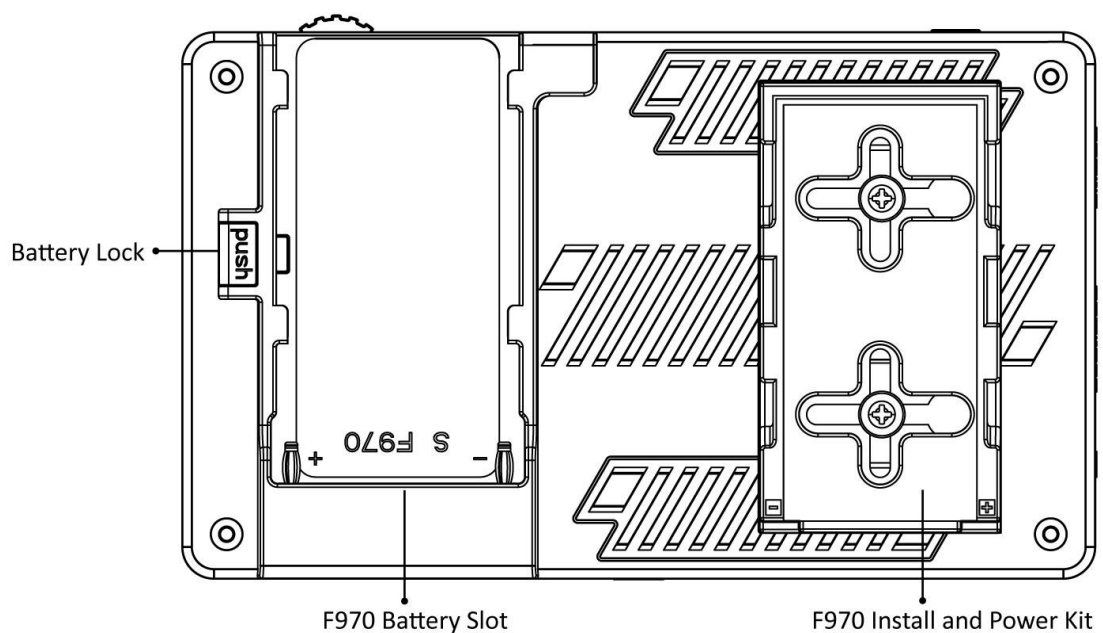

Battery Lock: The PUSH lock will lock after the battery installed, please press PUSH firstly before remove the battery.

F970 Battery Slot: It is applicable to install NP-F series of batteries.

F970 Install and Power Kit: Installing the external equipment, like wireless transmitter, LED light, video converter and others which can be powered by Sony F970 battery. (The details see: **1.7 Sony F970 Install and Power Kit**)

1.3 Top Button Instruction

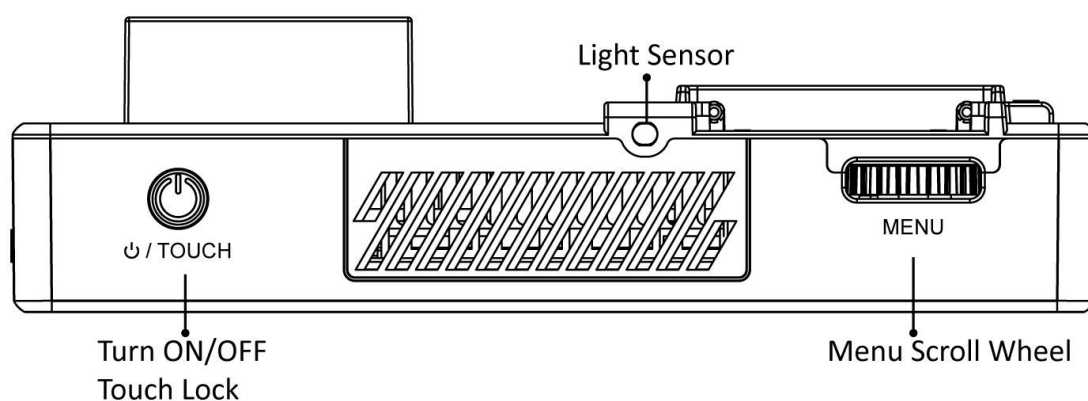

⏻ / TOUCH : Long press to turn on and off the power; short press to turn on and off the screen touch function

Light Sensor: The backlight mode under the icon  is set to Auto, and the brightness of the backlight can be adjusted automatically by the light sensor.

MENU: Long press to open the main menu and short press to open the shortcut menu. Rotate the wheel to select a menu item, press it again to open the corresponding menu function.

(The details see: **2. Menu Operation Instruction**)

1.4 Bottom Port Instruction

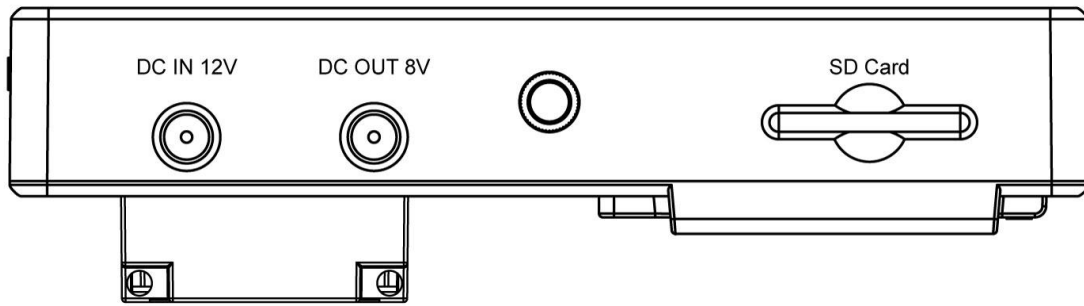

DC IN 12V: DC power input, polarity as the input power 

DC OUT 8V: DC power output, polarity as the output power 

Barrel output for powering your camera with a separately available DC coupler via adaptor (like NP-FW50 Sony & LP-E6

Canon&DMW-BLF19 Panasonic).

SD Card: SD card slot, 3DLUT upload via SD card and for firmware upgrade

1.5 Left Port Instruction

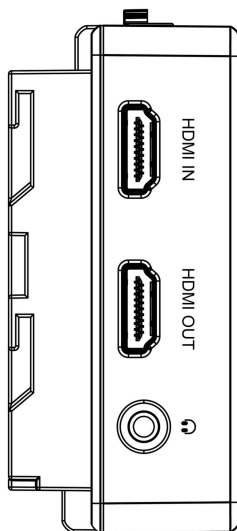

HDMI IN: HDMI signal input, up to 4K@30Hz

HDMI OUT: HDMI signal output, up to 4K@30Hz

 : 3.5mm earphone port output

1.6 Power Supply Way

(1) The rear cover of the monitor is equipped with a F970 battery plate, which is applicable to NP-F series of batteries.

Sony F970 battery plate for battery of Sony DV:

Sony F970 F960 F950 F930 F770 F750 F730 F570 F550 F530 series

Remark: It is recommended to use standard original F970 batteries. Different specifications of the battery have different capability. The working time for the monitor will be different. Higher capability (working time) will be longer. Please take off the battery from the monitor if you don't use the monitor in a long time.

(2) **DC IN 12V:** DC power input, polarity as the input power , Barrel (5.5mm outer, 2.1mm inner) at the bottom of the monitor, DC 7~24V Input.

1.7 Sony F970 Install and Power Kit

A Sony F970 external install and power kit design is added to the back of the monitor. The external kit can be used to install and install the external equipment, like wireless transmitter, LED light, video converter and others which can be powered by Sony F970 battery.

The kit has two cross grooves, you can adjust the position of the external device by loosening 2 screws up and down / left or right, or install the kit upside down.

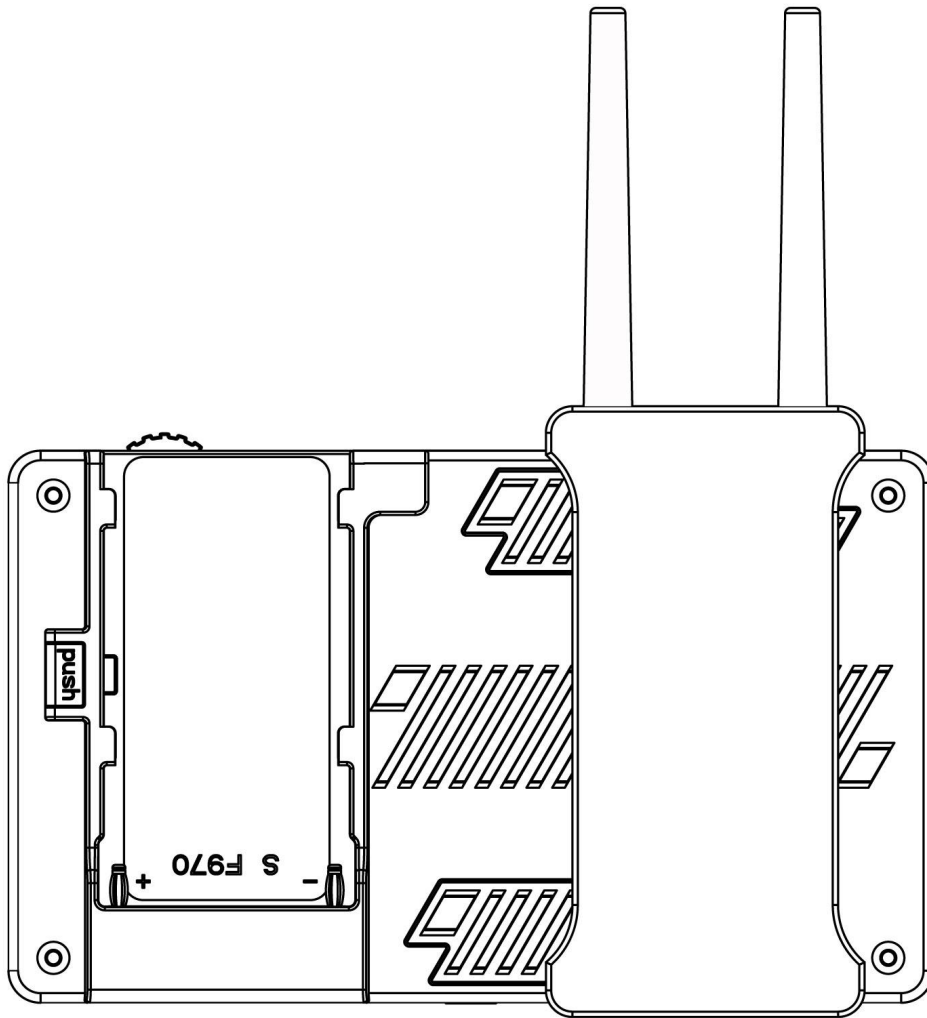

1.8 Installation Way

Mount Points

There are (2) 1/4-20 thread points (bottom & right side) can be easily connected to the hot shoe mount, tripod fixed installation.

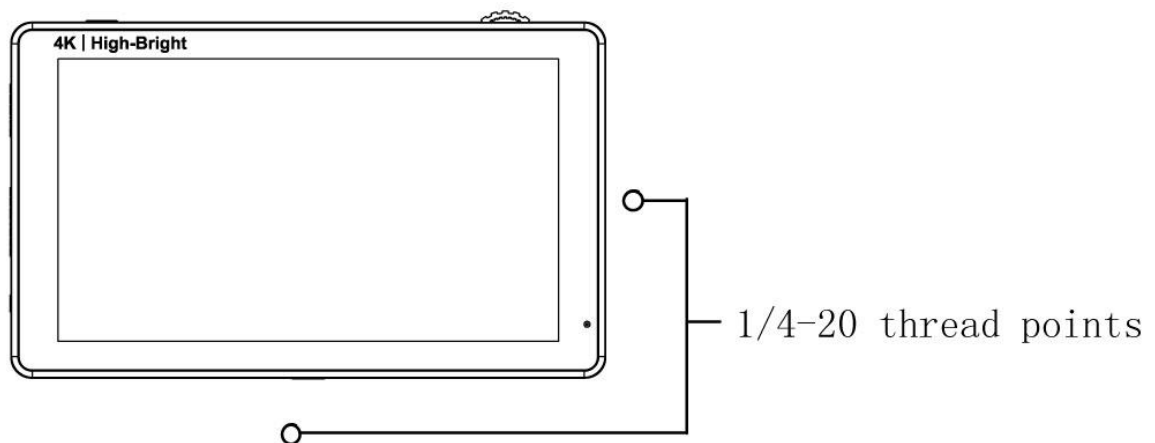

2. Menu Operation Instruction

After the monitor is properly connected to the power supply, the indicator light is on (red). Long press  / TOUCH button to turn on the monitor, the indicator light turns yellow. After the signal is connected, the indicator light turns green.

After startup, short press  / TOUCH to select to turn the screen touch function on or off.

2.1 Touch screen menu operation (default touch screen is on)



- ①. Double-click on the screen to open the main menu (on the left side of the screen) and click on the corresponding menu to display the secondary menu. You can enter the corresponding function option to select or set with the "<" or ">" key of the option. To exit the menu, click the main menu  menu or click the touch screen outside the menu.
- ②. When the menu is not displayed, swipe up from the bottom of the screen to open the shortcut menu, and click the shortcut menu function to open or set the function. Double-click the shortcut menu function, through the menu box "<" or ">" button, you can customize the function settings. Click the touch screen outside the shortcut menu to exit the shortcut menu display.
- ③. When the menu is not displayed, on the left side of the screen (1/2 split screen), you can directly adjust the brightness of the screen backlight; on the right side of the screen (1/2 split screen), you can directly adjust the volume.

Figure:

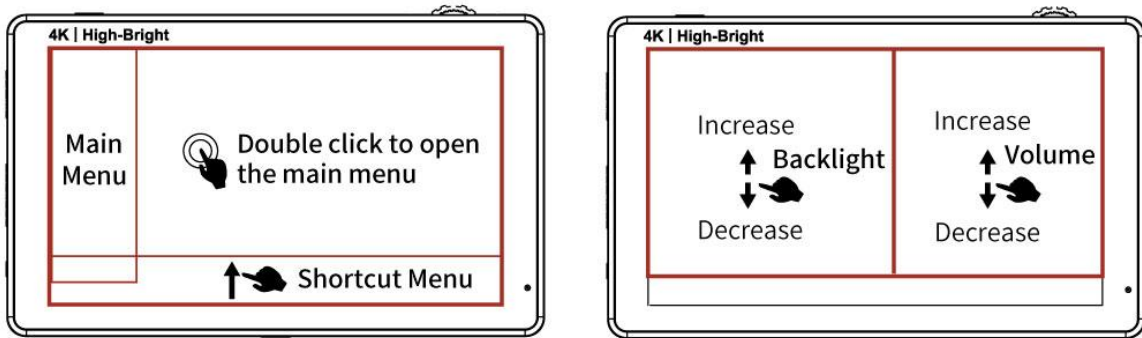

2.2 MENU Wheel Menu Operation

- ①. When the menu is not displayed, directly rotate the wheel to backlight or volume adjustment. The **wheel** option can be set to backlight or volume in the menu .
- ②. Long press the MENU wheel to open the main menu (left side of the screen), rotate the wheel to select the secondary menu. After selection, press the wheel to enter the secondary menu, and then rotate the wheel to select the secondary menu function. After selection, press the wheel to enter the secondary menu function, rotate the wheel to adjust the parameters. After the adjustment, press the wheel to confirm and exit the secondary menu function, rotate the wheel to enter the next adjustment. When finished, long press the MENU wheel to exit the main menu.
- ③. Short press the MENU wheel to open the shortcut menu (below the screen), rotate the wheel to select the shortcut menu option, press the wheel to directly turn on/off the function, if you press the parameter selection, repeat the above operation. When finished, long press the MENU wheel to exit the shortcut menu.

3. Menu Function Instruction



All Waves	OFF, ON After turning on, waveform, vector, histogram and embedded audio will be shown.
Parade	OFF, RGB, YUV, Y This essential feature assists with the calibration of professional video cameras. It shows the overall brightness of the image assisting the video professional in correcting exposure. The waveform feature also checks the evenness of the lighting when lighting a chromakey or background.
Vector	OFF, ON Shows how saturated the image is and where the pixels in the image land on the color spectrum.
Histogram	OFF, ON
Focus Assist	OFF, ON After the Focus Assist is turned on, the Focus Level (1~10) and Focus Color (yellow, red, green, blue, white) can be adjusted.
Audio Meter	OFF, ON
Zebra	OFF, ON After the Zebra is turned on, the Zebra Value (1%~100%) can be adjusted.
Monochrome	OFF, gray, red, green, blue
False Color	OFF, type 1, type2

Return 	Back to the previous OSD menu
--	-------------------------------



Nine Grid	OFF, ON
Safety Marker	OFF, 70%, 80%, 90%, 16:9, 16:10, 4:3, 5:4, 1:1, 1.91:1.1, 4:5, 9:16, 1.85:1, 2.35:1
Center Marker	OFF, ON
Marker Mat	OFF, 16:9, 16:10, 4:3, 1.85:1, 2.35:1, 2.41:1, 1.9:1, 5:4, 1:1.9 After the Marker Mat is turned on, the Marker Mat Alpha (0%, 25%, 50%, 75%) can be adjusted.
Marker Color	yellow, red, green, blue, white, black
Return 	Back to the previous OSD menu



Scan Mode	Under Scan, Over Scan
Video Aspect	auto, 16:9, 16:10, 4:3, 5:4, 1.85:1, 2.35:1, stretch, user Under the “user”, you can customize the Video Width (100% ~ 200%), Video Height (100% ~ 200%) .
Anamorphic Mode	OFF, 1.25x, 1.33x, 1.5x, 1.6x, 1.8x, 2.0x, 2.0x mag
Auto Mirror	OFF, ON After turning on, the image will automatically adjust upside down.

Flip H	OFF, ON
Flip V	OFF, ON
Zoom Times	OFF, 100%~500%
Freeze	OFF, ON
Pixel to Pixel	OFF, ON
Return ←	Back to the previous OSD menu

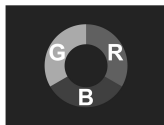

HDR	OFF、HLG 2020、HLG 709、HLG P3
Lut Switch	OFF, ON After the LUT Switch is turned on, you can use the Lut (SLOG2, SLOG3, LOGC, VLOG) .
Lut Import (SD)	After copying the 3D LUT file to the SD card and inserting it into the SD card slot, you can click the “<” or “>” key in the Lut (SD) option, or rotate the wheel to import the 3D LUT file. (details see 4.How to load LUT) Note: the chip should be faced up when inserting the SD card, and press it after inserting to ensure that the SD card is fully inserted.
Colortemp	5600K, 6500K, 9300K, user Under the “ user ”, the red , green , and blue values of the image can be adjusted.
Backlight Mode	auto, manual when selecting auto mode, the device will adjusting the backlight automatically according to the around environment
Backlight	0~100

Brightness	0~100
Contrast	0~100
Saturation	0~100
Hue	0~100
Sharpness	0~100
Return ←	Back to the previous OSD menu



Wheel	Backlight, Volume After selecting the wheel option, you can click the “<” or “>” button in the wheel option, or rotate the wheel to select one of the shortcut keys to set it to the rotary wheel adjustment (when the menu is not displayed).
Language	中文, 繁體中文, 日本語, Deutsch, Français, Italiano, Español, 한국, Русский, English
Transparency	OFF, low, middle, high
OSD Time	5s, 10s, 15s, 20s, 25s, always
Volume	0~100
Mute	OFF, ON
Reset	OFF, ON After selecting the reset option, you can click the “<” or “>” key in the reset option or rotate the wheel to restore the factory settings.
Firmware Update	After copying the update file to the SD card and inserting it into the SD card slot, you can click the “<” or “>” key in the firmware update option or rotate the wheel to update.

	Note: the chip should be faced up when inserting the SD card, and press it after inserting to ensure that the SD card is fully inserted.
Return 	Back to the previous OSD menu



	Exit the menu
---	---------------

4. How to Load LUT

4.1 SD card format

Support FAT32 or NTFS. For MAC system, the SD card should be formatted in MS-DOS (FAT)

4.2 Max Files Limit Maximum 50 Lut files

4.3 File requirements

- The LUT file format suffix should be **.cube**
- Single file not exceeded to 7.9Mb
- Support LUT-3D-Size 16,17,32,33,64,65

Remark: LUT file name must be English or Arabic numerals

4.4 Steps for loading

4.4.1 Make sure the SD card correctly insert

4.4.2 Enter main menu --Lut Import (SD)-- click "<" or ">" to load

the monitor will auto detect the SD card

A. There is no SD Card, the screen will show failed,can try once more,if not work, restart the monitor and try again

B. There is SD Card, the monitor will erase the exits user’s lut fill and show “Initializing” , If there is no valid lut file in SD card, the lut will not load.The monitor will show “clean up”

C. If there is valid lut file in sd card, the monitor will load lut files and show “[n] name. The [n] shows the quantity number. The “name” should in lut files’ name. If load successful, the screen will show “complete[n]”. [n] Stands for the quantity number for lut files should under 50.

5. Support Formats

HDMI Input/ Output Support Format	480i/480p/576i/576p 720p (60/59.94/50/30/29.97/25/24/23.98) 1080i (60/59.94/50) 1080p (60/59.94/50/30/29.97/25/24/23.98) 3840x2160p (30/29.97/25/24/23.98) 4096×2160p (24Hz)
--	---

6. Technical Parameters

Panel Size	5.5” touch screen
Resolution	1920 x 1080 pixels
Dot Pitch	0.069(L) x 0.069(W) (mm)
Aspect Ratio	16:9
Brightness	1600cd/m ²
Contrast	1000:1
Viewing Angle	80°/80°(L/R) 80°/80°(U/D)
Backlight	LED
Input	HDMI
Output	HDMI

Audio	3.5mm Stereo Headphone
Power Out	DC OUT 8V, Barrel (5.5mm outer, 2.1mm inner; Power DSLR or mirrorless camera)
Input Voltage	7~24V
Power Consumption	≦9W
Unit Size	142Lx86Hx28D (mm)
Unit Weight	270g
Mount Points	(2) 1/4-20 thread points (right, bottom)
Working Temperature	-20℃ ~ 50℃
Storage Temperature	-30℃ ~ 70℃

7. Trouble Shooting

7.1 Only black and white or monochrome picture:

- ① please check saturation, brightness & contrast adjustment.
- ② Please check "Monochrome" is in black, white or monochrome image or other condition.

7.2 NO Image after put on the power

- ① Check if signal cable connecting is in good condition.
- ② Check signal cable connecting, and make sure to use the standard adapter to connect the monitor. If power is supplied by battery, please check if the battery is fully charged.

7.3 Earphone No sound

Check if Volume control do not open, press the volume button, and try to increase the volume.

- If there are still other problems, please contact with our related technologists.

★ As we are improving product features and product performance,
so if there is any change on the specification without prior notice.