

LUT5 3000nit TOUCH·3D LUT

5.5" DAYLIGHT VIEWABLE FIELD MONITOR

Sony F970 External Install and Power Kit



- 

5.5"
3000nit Light Sensor
- 

1920x1200
FHD Resolution
- 

Touch Screen
- 

3D LUT
Custom 3D LUT
- 

HDR
HDR Monitoring
- 

4K HDMI
4K HDMI In & Out
- 

External Install and Power Design
- 

DC OUT
Power for Camera





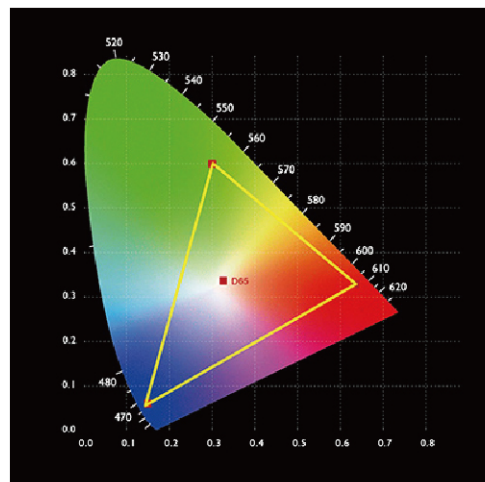









USE PROFESSIONAL REC.709 COLOR CALIBRATION STANDARD

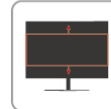

FEATURES

- 5.5-inch 1920x1080 full HD IPS screen
- Touch screen menu operation, improve shooting efficiency
- Ultra-bright 3000nit, clearly visible in the sun
- Light sensor auto dimming
- Supports 3D LUT Log to REC.709 and user 3D LUT upload
- Supports HDR monitoring, what you see is what you get
- Sony F970 external install and power kit design can be used to install and supply power to external equipment, easy to install and disassemble, simplify your photography equipment.
- With Waveform, Vectorscope, RGB Histogram, Focus Assist, Monochrome etc. functions, can help you accurately exposure and focus every shot.
- Stereo Earphone output
- DC 8V power out to power your DSLR camera or mirrorless camera

PROFESSIONAL AND RICH AUXILIARY FUNCTIONS

- | | | | | | |
|--|---|--|---|--|---|
| 
3D LUT | 
Waveform | 
Vector Scope | 
Histogram | 
Anamorphic Mode | 
Peaking Filter |
| 
False Colors | 
Exposure | 
Zoom-in | 
Image Flip | 
Embedded Audio | 
Nine Grid |

SD card slot import LUT



Flexible power supply mode
Sony F970 external power and install kit



R970

Sony F970 外挂供电套件



DC 12V

>> PARAMETER

Model	LUT5
Screen size	5.5" IPS
Display Colors	16.7M (8 bit)
Resolution	1920x1080 pixels
Dot pitch	0.069(L) x 0.069(W) (mm)
Aspect Ratio	16:9
Brightness	3000cd/m2
Contrast	1000:1
Backlight	LED
Response Time	Ton+Toff=35ms
Viewing Angle	80°/80°(L/R) 80°/80°(U/D)
Input	HDMI
Output	HDMI
Power Out	DC OUT 8V, Barrel (5.5mm outer, 2.1mm inner; Power DSLR or mirrorless camera)
Audio	3.5mm Stereo Headphone
HDMI Input/ Output Support Format	480i/576i/480p/576p
	720p (60/59.94/50/30/29.97/25/24/23.98)
	1080i (60/59.94/50)
	1080p (60/59.94/50/30/29.97/25/24/23.98)
	3840 × 2160p (30/29.97/25/24/23.98)
	4096 × 2160p (30/29.97/25/24/23.98)
Power Consumption	≤ 20W
Input Voltage	DC7 ~24V
Power Connector	DC
Battery Plate	F970 Battery Plate
Operating Temperature	-20°C ~ 70°C
Storage Temperature	-30°C ~ 80°C
Install Way	1/4"-20 Thread Point (Right, Bottom)
Unit Size	142Lx86Hx28D (mm)
Unit Weight	270g

>> STRUCTURE

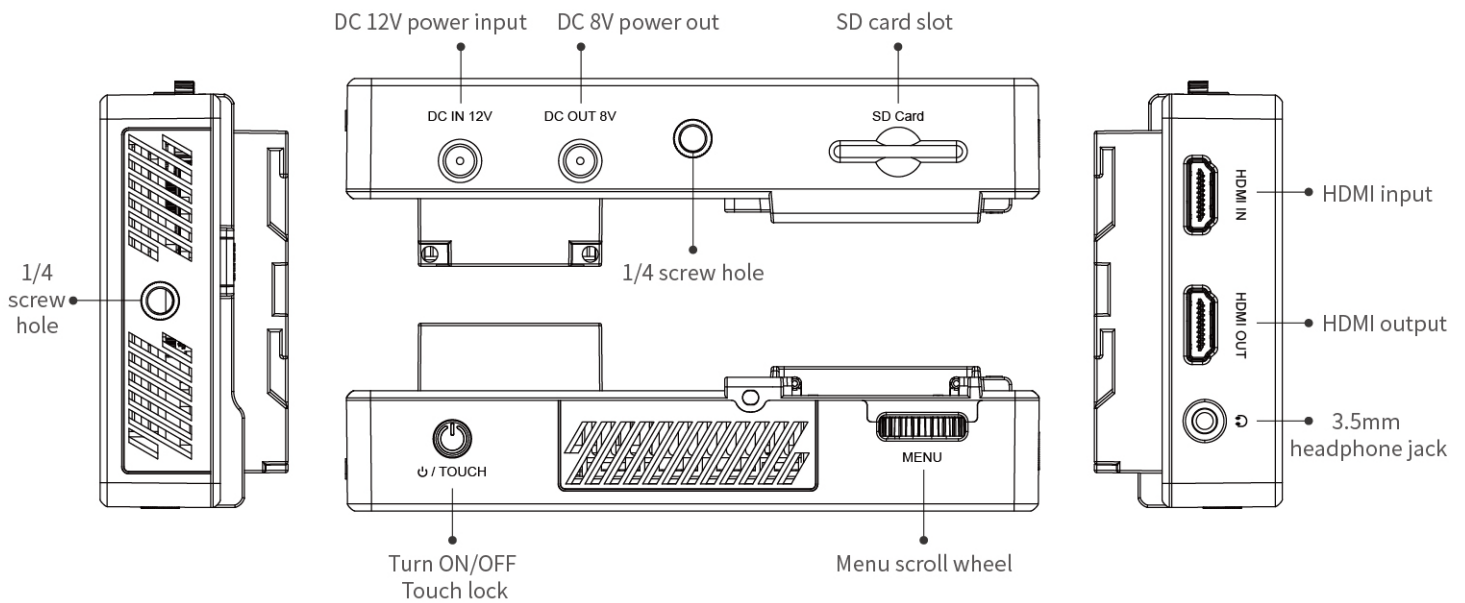
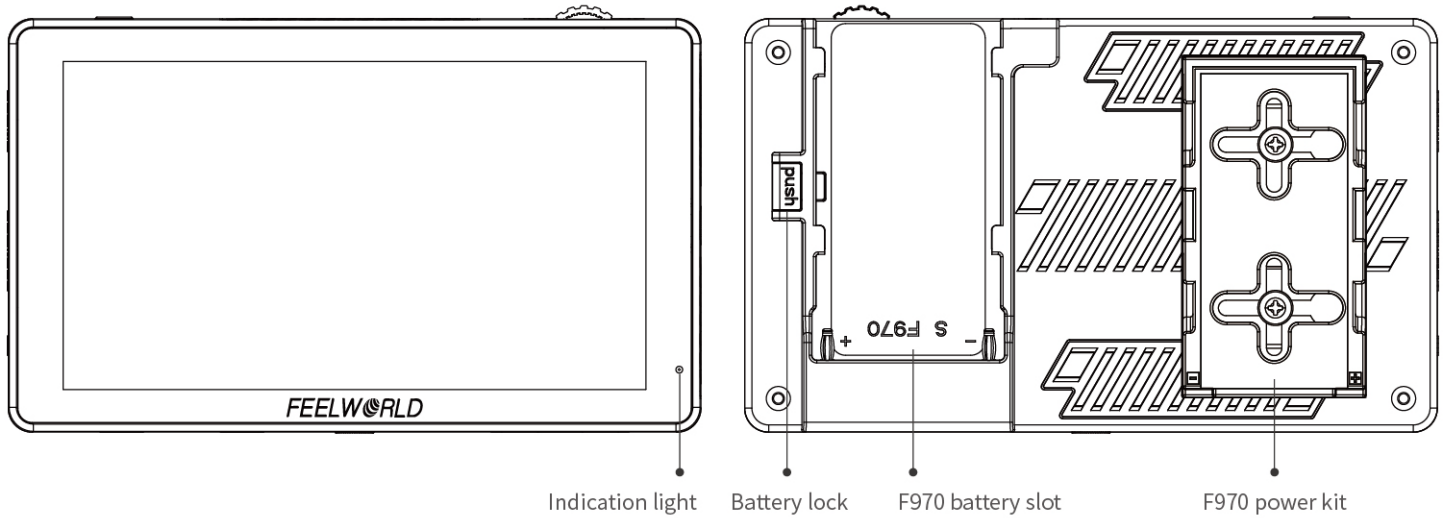

>> PACKING LIST

 <p>Monitor</p>	 <p>Micro HDMI cable</p>	 <p>Mini hot shoe mount + Hex wrench</p>	 <p>User manual</p>
--	---	--	--

HDMI[®]
HIGH-DEFINITION MULTIMEDIA INTERFACE

CE FC



Zhangzhou Seetec Optoelectronics Technology Co., Ltd

E-mail: sales@feelworld.cn

Tel: +86-596-2672627

Website: www.feelworld.com.cn

Fax: +86-596-2672617

www.seetec.com.cn