

LDP136-071C

All-in-One Direct View LED Display

Installation Guide

快速入門指南

Guide de démarrage rapide

Schnellstartanleitung

Guía rápida de inicio

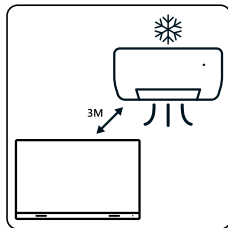
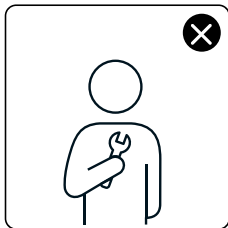
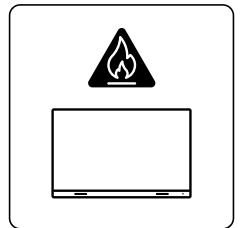
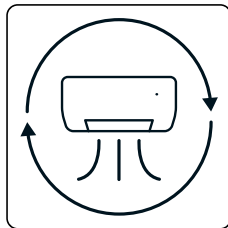
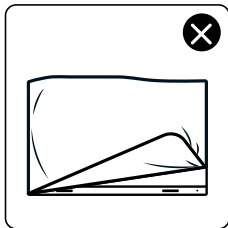
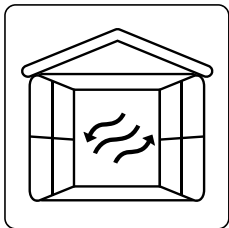
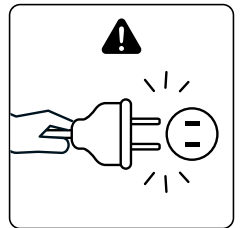
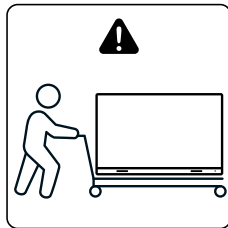
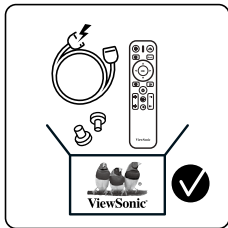
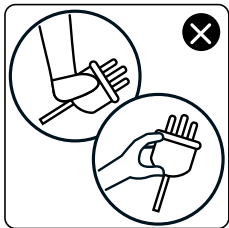
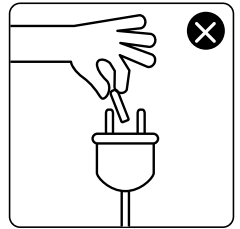
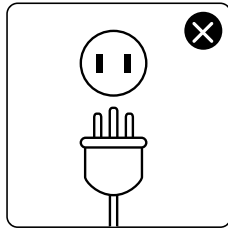
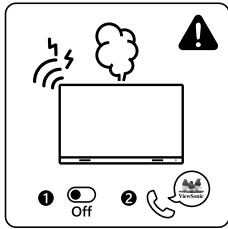
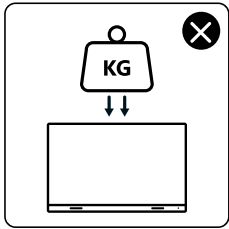
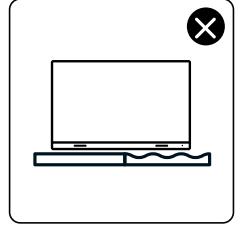
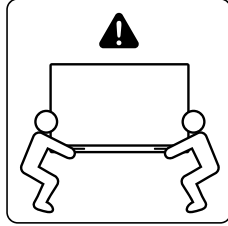
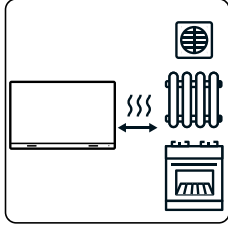
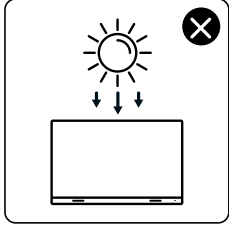
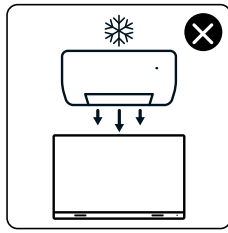
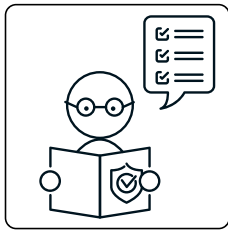
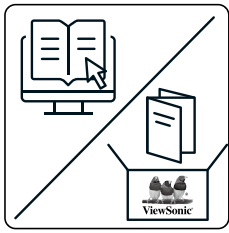

FCC Compliance Statement

This device complies with part 15 of FCC Rules. Operation is subject to the following two conditions: (1) this device may not cause harmful interference, and (2) this device must accept any interference received, including interference that may cause undesired operation.

Industry Canada ICES-003 Statement: CAN ICES (B) / NMB (B)

CE Conformity for European Countries

The device complies with the EMC Directive 2014/30/EU, Low Voltage Directive 2014/35/EU and Radio Equipment Directive 2014/53/EU.

Declaration of RoHS2 Compliance

This product has been designed and manufactured in compliance with Directive 2011/65/EU of the European Parliament and the Council on restriction of the use of certain hazardous substances in electrical and electronic equipment (RoHS2 Directive) and is deemed to comply with the maximum concentration values issued by the European Technical Adaptation Committee (TAC).

For EU users, please contact us for any safety/accident issue experienced with this product:

ViewSonic Europe Limited



Haaksbergweg 75
1101 BR Amsterdam
Netherlands



+31 (0) 650608655



EPREL@viewsoniceurope.com











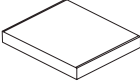
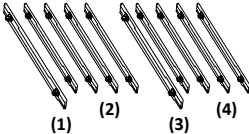
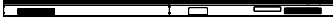

<https://www.viewsonic.com/eu/>

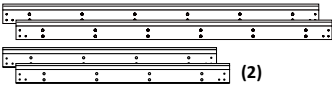

Package Contents

- ! It is recommended to use pliers to open the shipping crate.
- ! Please wear protective gear, such as gloves and protective shoes, at all times.

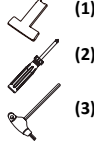
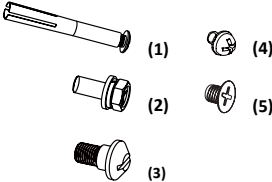
Before the installation, please take a moment to check if all components are included in the crate. The contents inside the case can be identified by the product labels on it. If anything is missing or damaged, contact your dealer immediately.

	Item	Quantity	Note
Installation Guide		1	
Cabinet Sections		5 sections total	One Left (A), three Middle (B, C, D), and one Right (E)
LED Modules		200 modules	The quantity of spare LED modules varies by country.
Screen Bezels		10	1 x Top Left (1) 4 x Left (2) 1 x Top Right (3) 4 x Right (4)
System Control Box		2 sides	
System Control Box Covers		2 sides	
Connector Plate		1	

Item	Quantity	Note
System Control Box Maintenance Tool		1 P/N: LD-MK-004
LED Module Maintenance Tool		1 P/N: LD-MK-006
Wall Mount Brackets	 (1) (2)	4 2 x 1799 mm (1) 2 x 1199 mm (2)
Wall Mount Connector Plates		2
IR Extension Cable		1 3 m
Ethernet Cable		1 3.5 m
Hand Tools	 (1) (2) (3)	2 x Cabinet magnet adjustment tools (1) 2 x Cross-head screwdrivers (2) 1 x T-line hex wrench (3)
Nuts and Bolts	 (1) (4) (2) (5) (3)	40 x M8 x 80 mm expansion (1) 10 x M8 x 20 mm (2) 12 x 6 x 10 mm (3) 6 x M3 x 6 mm (4) 5 x M2.5 x 4 mm (5)
Anti-Static Gloves		2 pairs

Item	Quantity	Note
Remote Control		1 With two AAA batteries
System Control Box Spacer		10



NOTE:

- This product is packed in a wooden crate.
- Due to the size and weight, it is recommended that two or more people handle it.
- The base stand (trolley) and the accessories for Hidden and Separate Installation are optional. They are sold separately.

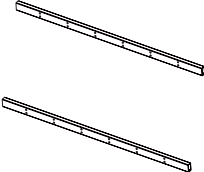
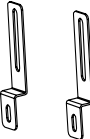

Optional Accessories

The accessories below are for the LED Display installed on the trolley or with the either hidden or separate System Control Box layout. These accessories are sold separately. If you are not sure of which ones to order, consult your dealer for technical support or product service.



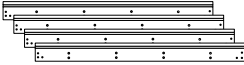
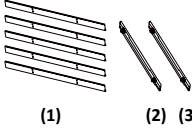
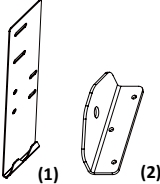

Base Stand (Trolley)

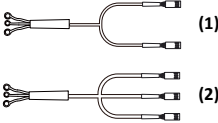
	Item	Quantity	Note
Supports		2	Left and Right
Cross Beams		2	Top and Bottom
Cabinet Brackets		2	
Screws		56 x M8 x 20 mm	

Hidden Installation

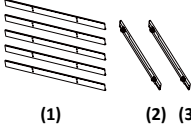
	Item	Quantity	Note
Wall Mount Brackets		4	1335 mm
Screen Bezels		7	5 x Bottom (1) 1 x Bottom Left (2) 1 x Bottom Right (3)
System Control Box Mount Brackets		4	2 x Upper (1) 2 x Lower (2)
Cable Zip Ties		20	
Ethernet Cable		15	4.8 m
Cabinet Power Cables		2	1 x 3482 mm (1) 1 x 5193 mm (2)

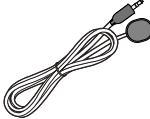
Separate Installation

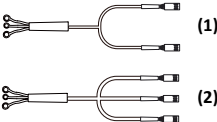
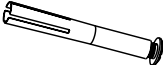
	Item	Quantity	Note
System Control Box Top Cover		2 sides	
Screen Bezels		7	5 x Bottom (1) 1 x Bottom Left (2) 1 x Bottom Right (3)
Cable Zip Ties		20	
IR Extension Cable		1	10 m
Ethernet Cable		15	15 m
Cabinet Power Cables		2	1 x 13 m (1) 1 x 15 m (2)
Fasteners		3 sets	

Product Overview

ENGLISH

Front Panel

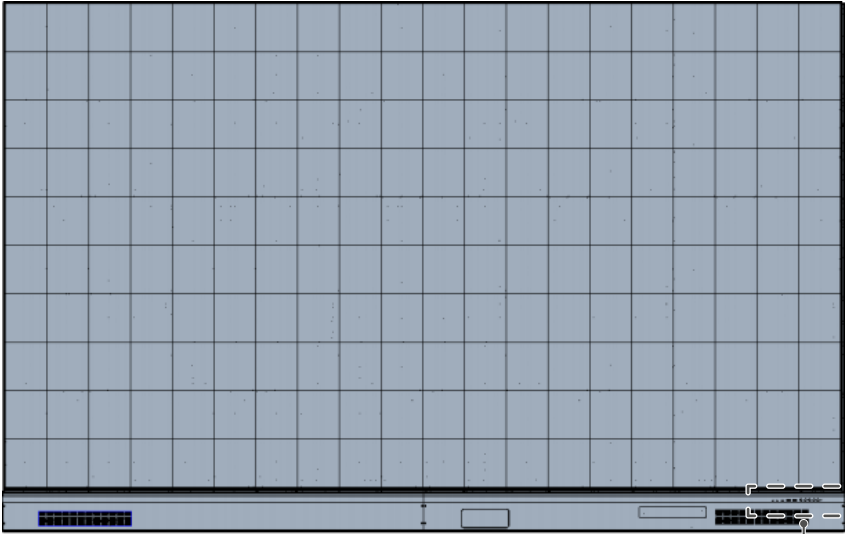

I/O &
Control Panel

Rear Panel

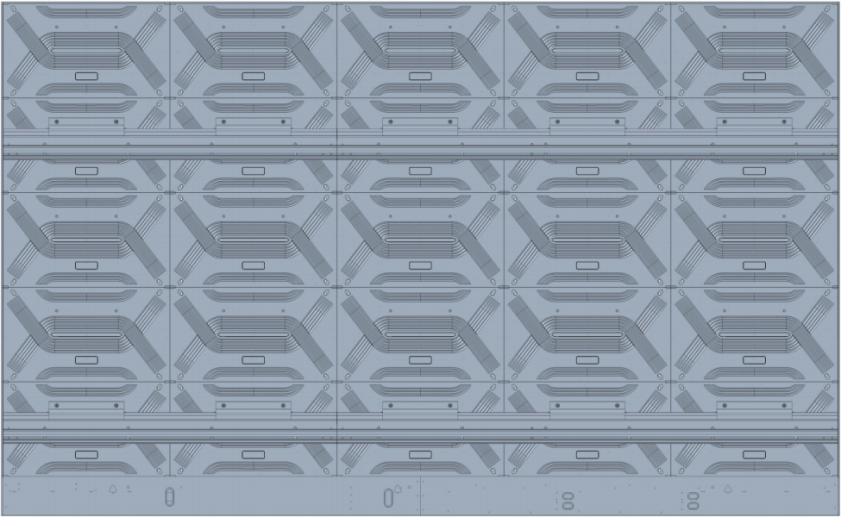

Introduction

The step-by-step instructions in this guide are a general reference for installing the LED Display. If any details in this document are unclear, please contact your reseller for more information.

Ensure your LED Display is installed and grounded properly by a qualified installer or serviceperson.

About the LED Display

The LED Display can be installed on the wall or on a trolley.

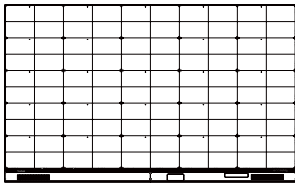

Wall Installation

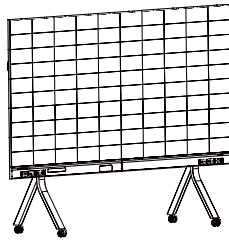

Trolley¹

You can mount the System Control Box in three different ways:

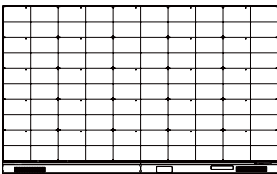

Under the Cabinets
(Standard Installation)

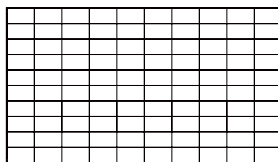

Behind the Cabinets
(Hidden Installation)

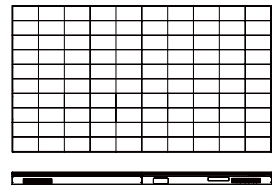

Apart from the Cabinets
(Separate Installation)

¹ – Hidden and Separate Installation are not applicable to the trolley.

Before Installing

Read these instructions carefully, keep them in a safe place, and follow all warnings and instructions.

General Safety Precautions

- Ensure there is no direct airflow from air conditioning or heating vents blowing on the LED Display.
- Always wear protective gear, such as gloves and protective shoes, when handling the LED Display.
- Electrical connections, and all associated servicing or adjusting, should only be performed by a qualified electrician approved or licensed as required by the locality.

Installation

- Avoid installing the LED Display in places with high humidity.
- Ensure that the wall can safely support 100 kg and the power outlet supplies enough voltage (max: 2031W; normal: 680W).
- Ensure the deviation of the wall surface is < 5 mm.
- Wood may split if holes are not pre-drilled before installing the Wall Mount Brackets.

System Control Box Power Cable Safety

- Due to high power usage, always use the power cord(s) specifically designed for this product.
- Do not damage or modify the Power Cable(s).
- Do not use extension cords. If the Power Cable(s) are too short, have a qualified electrician install an outlet near the LED Display.

Trolley

- Do not move the trolley over cords or uneven, dirty, soft, or high incline surfaces.
- To avoid injury, KEEP AWAY from moving parts.
- Do not move the trolley by pushing on the LED Display.
- Do not push the trolley from the front of the LED Display or attempt to lift it.

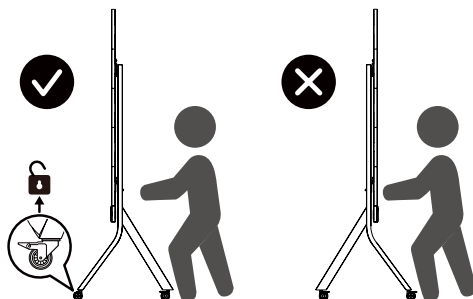

Wall Mounting (Standard Installation)

The Wall Mount Brackets come in with two different lengths. You need two of each to mount the screen to the wall.

The Left (1199 mm) and Right (1799 mm) Wall Mount Brackets

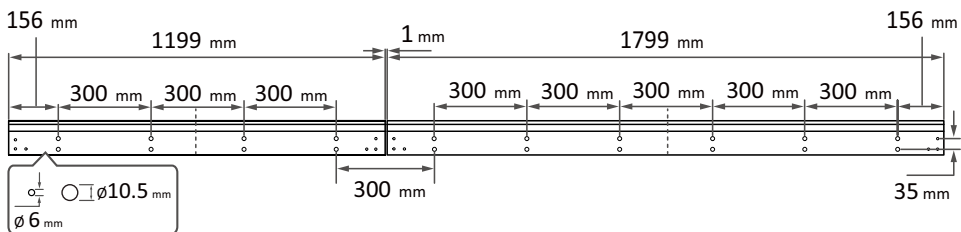

1. Ensure the wall area is an appropriate installation site.
NOTE: Refer to page 15 for more information.
2. Using the illustration as shown above as a guide, mark at least 10 mounting holes and pre-drill them.
NOTE: To ensure the marks are perfectly horizontal, it is recommended to use a laser or torpedo level.
3. Install the Left Upper Wall Mount Bracket with the provided screws (M8 x 80 mm Expansion for masonry; wood screws for load bearing wood).
4. Repeat **Step 3** for the Right Upper Wall Mount Bracket.
5. After mounting the Left and Right Upper Wall Mount Brackets to the wall, secure them with the Wall Mount Connector Plate using the six provided screws (M6 x 10 mm).

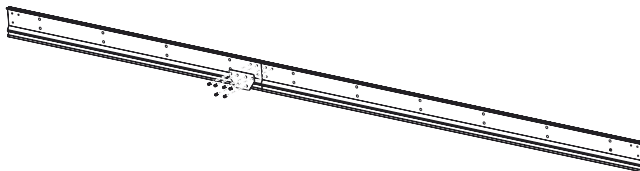

6. Install the Lower Wall Mount Brackets in the same manner as the Upper Wall Mount Brackets. The distance between the Upper and Lower Wall Mount Brackets is 675 mm.

7. After installing both Upper and Lower Wall Mount Brackets, the installation wall should look like:

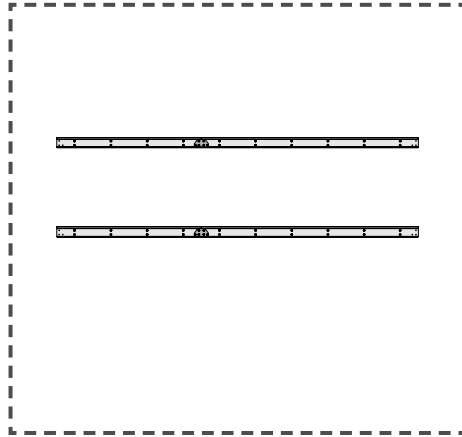

After the Wall Mount Brackets are installed, please go to page 27 for the Cabinets (Standard Installation).

Spacing Instructions for Wall Installation (Standard Installation)

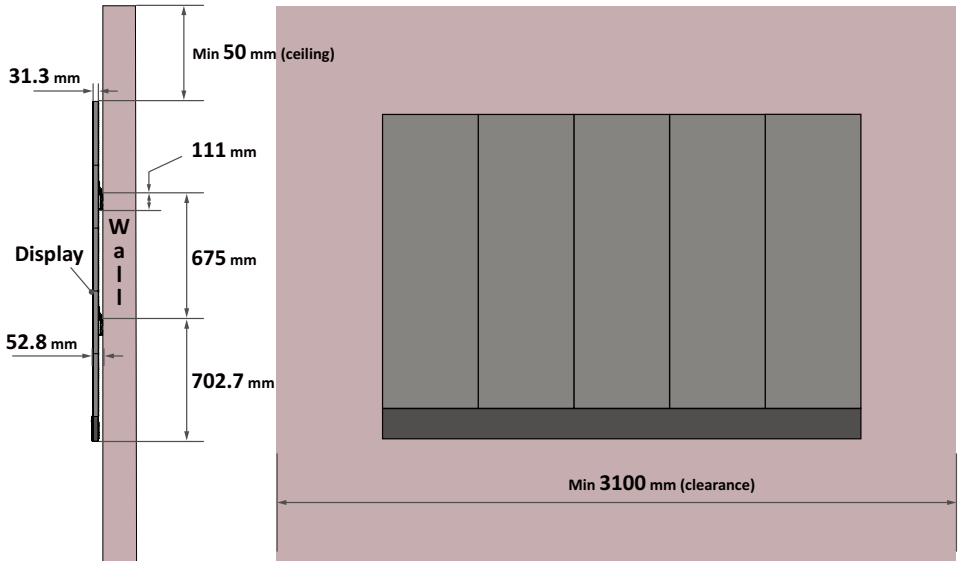

NOTE:

- You can also install the Upper Wall Mount Brackets, hang the screen, and then install the Lower Wall Mount Brackets for a more precise fit.
- Adjustment in floor clearance and ceiling height should be made according to the actual installation site.

Trolley Mounting

NOTE: The trolley is compatible only with ViewSonic Direct View LDP136-151C, LDP136-071C, and LDP136-091C. Using the trolley with other models may cause instability and injury.

Trolley Dimensions

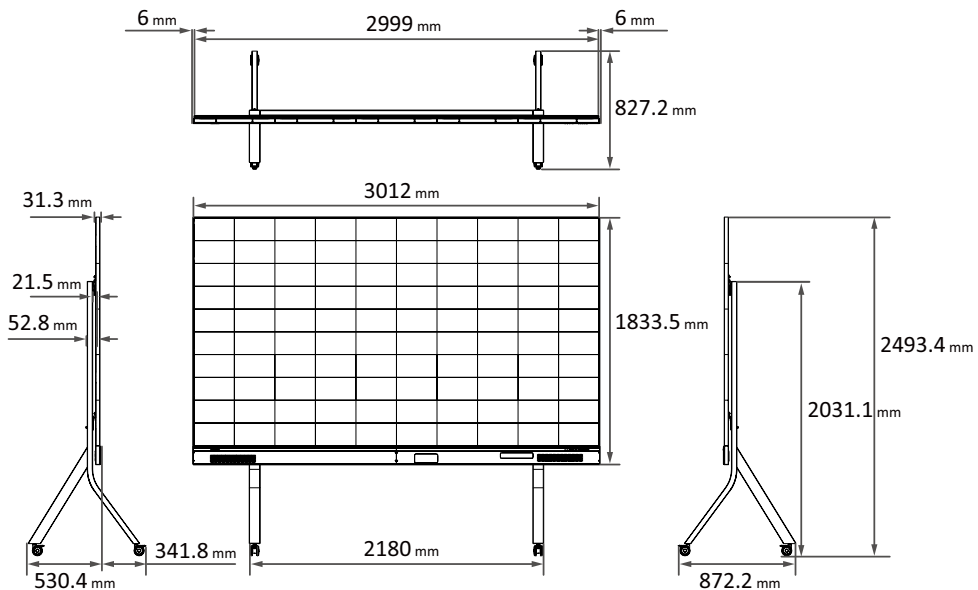

Building the Trolley

1. Pull down the brake locks of the four rollers until you feel the brakes click into locked position.

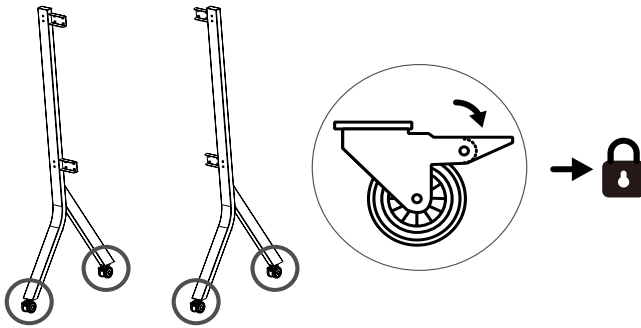

2. Install the Top and Bottom Cross Beams to the Left and Right Supports. Secure them together with the provided screws (M8 x 20 mm).

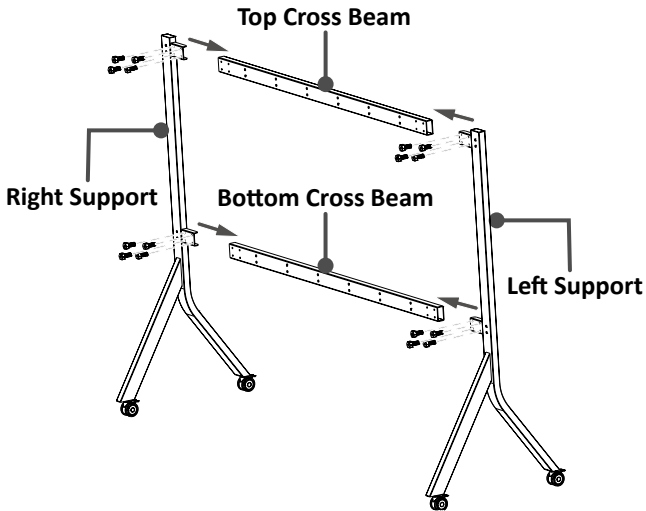

Building the Trolley (Rear View)

3. Connect the Left and Right Upper Wall Mount Brackets using the Wall Mount Connector Plate with the six provided screws (M6 x 10 mm).

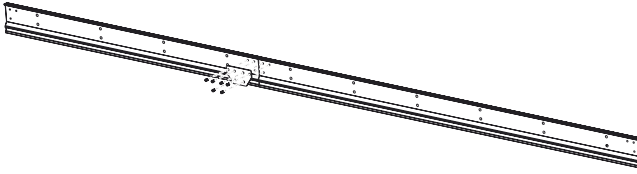

4. Install the Upper Wall Mount Brackets to the Top Cross Beam with the provided screws (M8 x 20 mm).

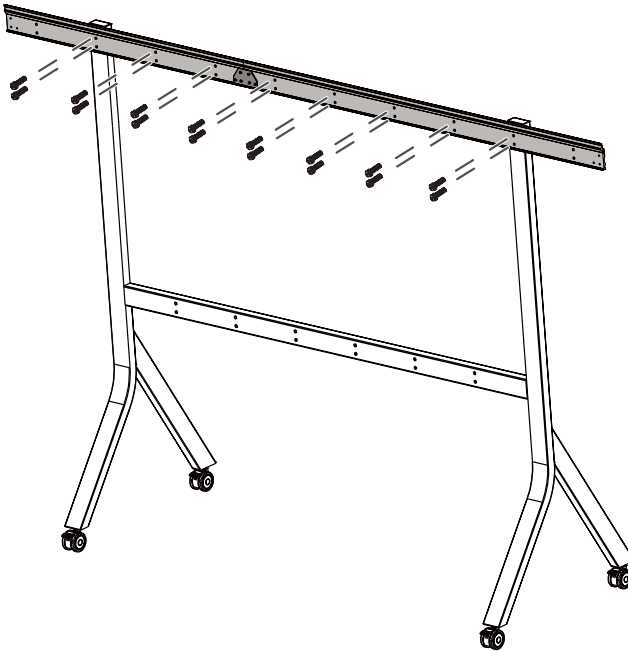

5. Install the Cabinet Brackets to the lower side of the Left and Right Supports with the provided screws (M8 x 20 mm), but do not tighten them. This allows the Brackets to rotate when installing the Cabinets.

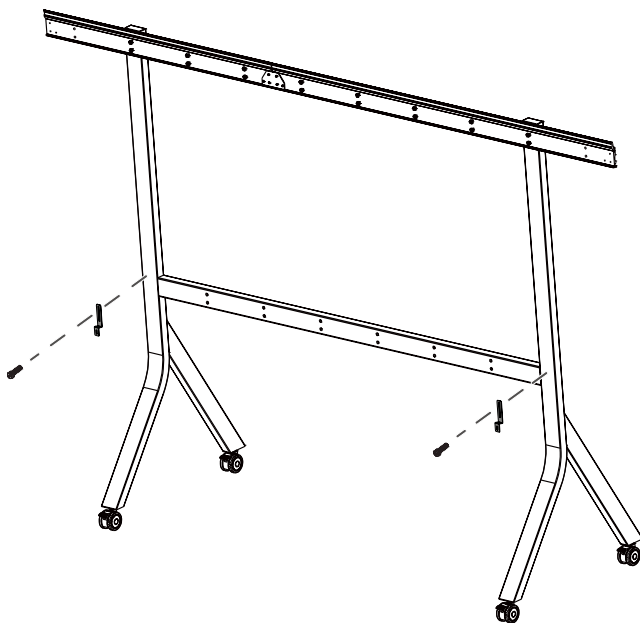

NOTE:

- There are two Cabinet Brackets to install.
- Ensure it is the longer side of the Cabinet Brackets (the side with a visible elongated slot) installed to the Left and Right Supports.

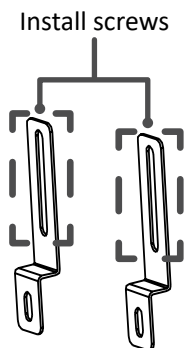

6. Connect the Left and Right Lower Wall Mount Brackets using the Wall Mount Connector Plate with the six provided screws (M6 x 10 mm).

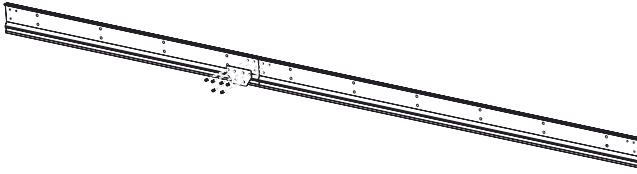

7. Install the Lower Wall Mount Bracket to the Bottom Cross Beam with the provided screws (M8 x 20 mm).

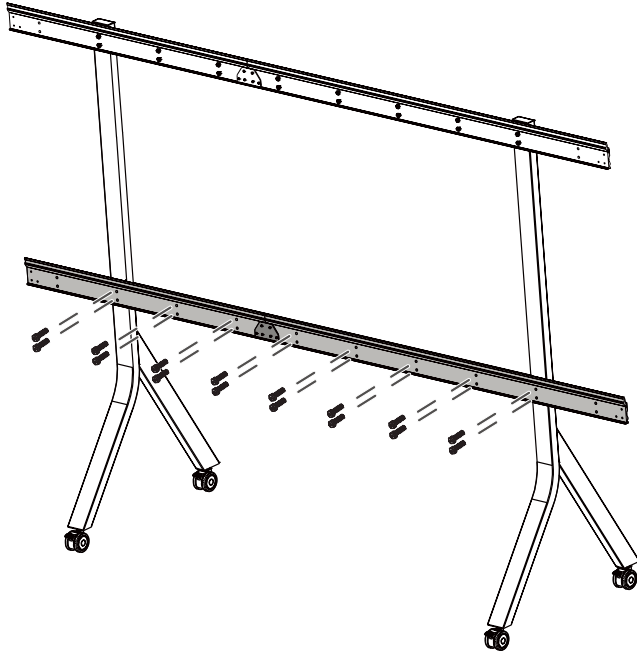

8. Rotate the two Cabinet Brackets 180°, ensuring the short side of the Brackets is facing upward. The Cabinet Brackets are used later for further securing the lower part of the Cabinets to the trolley.

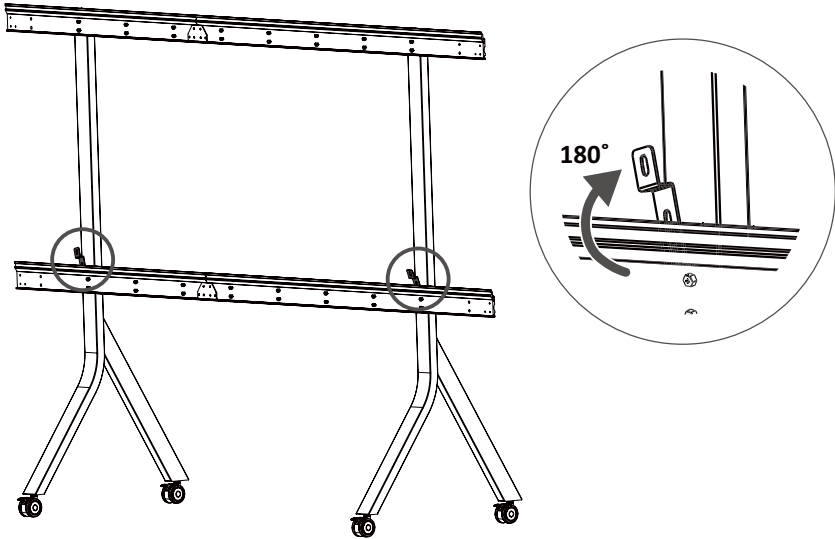

After the trolley is built, please go to page 30 for the Cabinets (Trolley Installation).

Wall Mounting (Hidden Installation)

When the System Control Box is installed behind the Cabinets, this installation type requires a different set of Wall Mount Brackets. You also need the System Control Box Mount Brackets to attach the System Control Box to the rear of the Cabinets.

Wall Mounting

Four Wall Mount Brackets are used for mounting the screen to the wall.

Installing the Upper and Lower Wall Mount Brackets

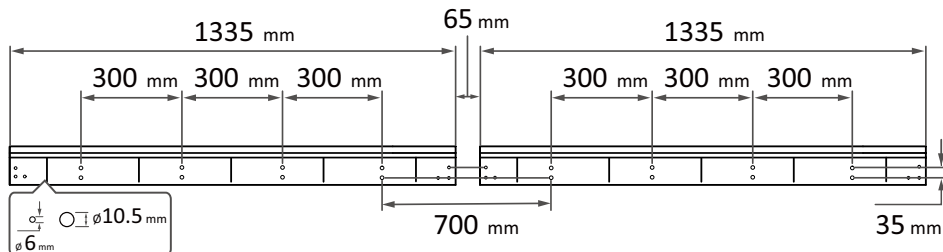

1. Ensure the wall area is an appropriate installation site.

NOTE: Refer to page 24 for more information.

2. Using the illustration as shown above as a guide, mark at least eight mounting holes and pre-drill them.

NOTE: To ensure the marks are perfectly horizontal, it is recommended to use a laser or torpedo level.

3. Install the first Upper Wall Mount Bracket with the provided screws (M8 x 80 mm Expansion for masonry; wood screws for load bearing wood).
4. Repeat **Step 3** for the second Upper Wall Mount Bracket.
5. Install the Lower Wall Mount Brackets in the same manner as the Upper Wall Mount Brackets. The distance between the Upper and Lower Wall Mount Brackets is 675 mm.

6. After installing both Upper and Lower Wall Mount Brackets, the installation wall should look like:

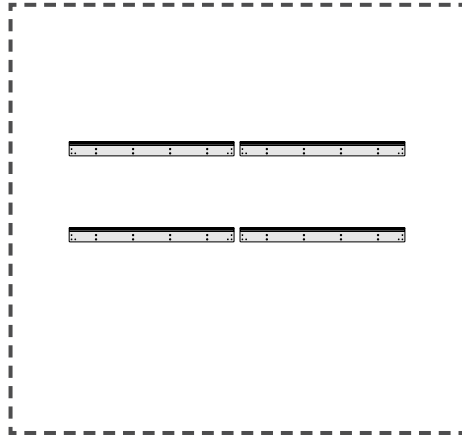

After the Wall Mount Brackets are installed, please go to page 33 for the Power and Network Cables of the Cabinets (Hidden and Separate Installation).

NOTE: The Power and Network Cables of each Cabinet must be connected before installing the Cabinets.

Spacing Instructions for Wall Installation (Hidden Installation)

ENGLISH

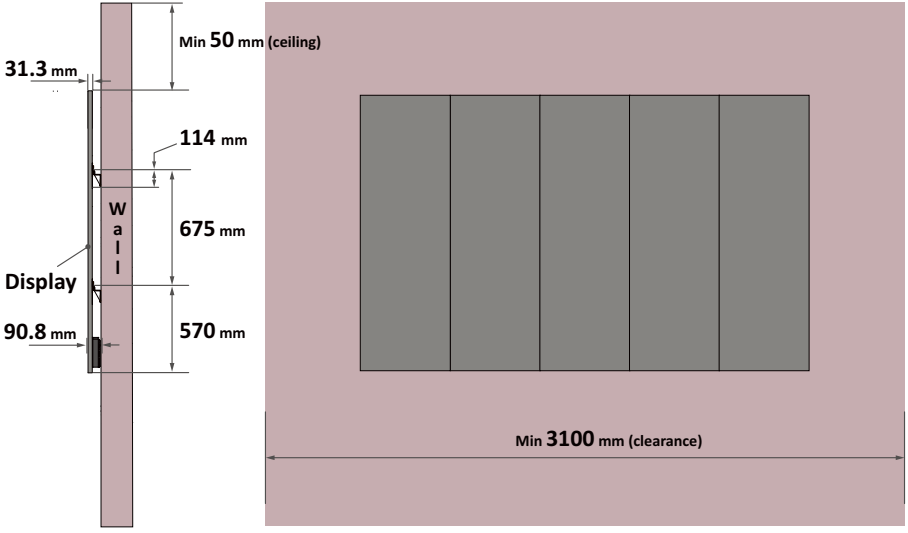

NOTE:

- You can also install the Upper Wall Mount Brackets, hang the screen, and then install the Lower Wall Mount Brackets for a more precise fit.
- Adjustment in floor clearance and ceiling height should be made according to the actual installation site.

Wall Mounting (Separate Installation)

When the System Control Box is installed apart from the Cabinets, this installation type uses the same Wall Mount Brackets as the Standard Installation. However, you will need to pre-drill additional holes for the System Control Box.

Drill Hole Spacing for System Control Box

- ❗ Ensure there is enough space between the mounting holes and cable access holes.

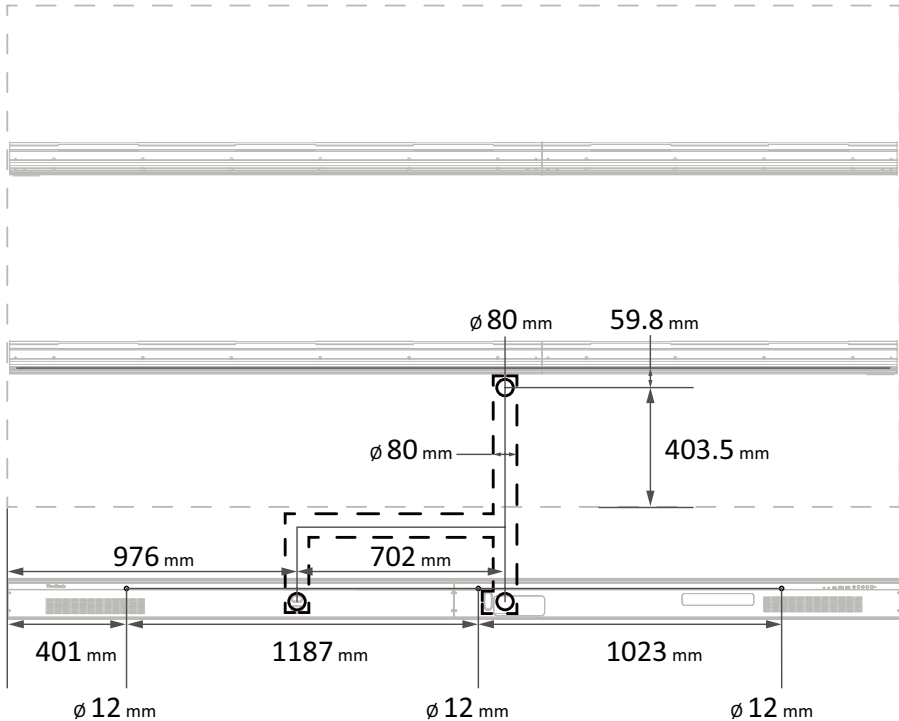

1. Please follow **Step 2~6** on page 13 for the Upper and Lower Wall Mount Brackets.

NOTE: To ensure the wall area is suitable for installation, refer to page 26 for more details.

2. Use the illustration as shown above as a guide to mark the following holes and pre-drill them.
 - At least three mounting holes for the System Control Box.
 - Three cable access holes, one at the top and two at the bottom. The distance between the Lower Wall Mount Bracket and the top cable access hole is 59.8 mm.

After the Wall Mount Brackets are installed, please go to page 33 for the Power and Network Cables of the Cabinets (Hidden and Separate Installation).

NOTE: The Power and Network Cables of each Cabinet must be connected before installing the Cabinets.

Spacing Instructions for Wall Installation (Separate Installation)

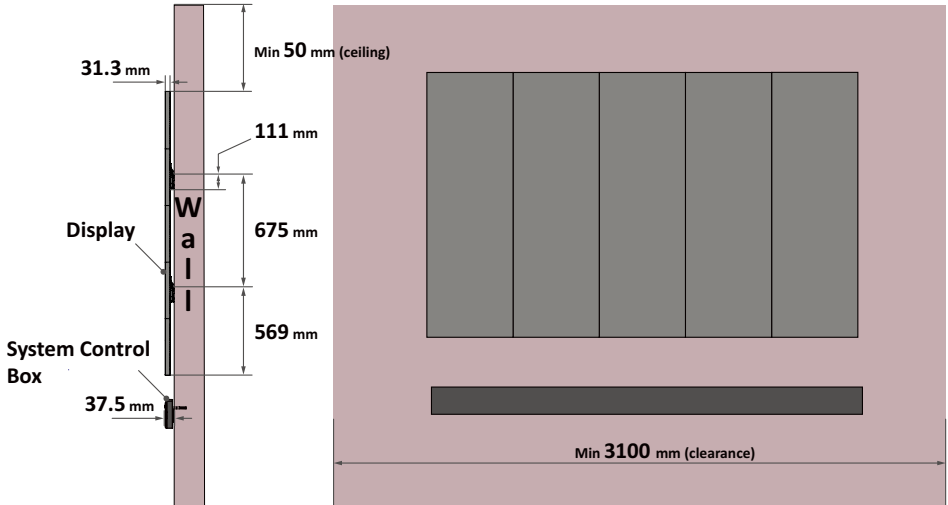

NOTE:

- You can also install the Upper Wall Mount Brackets, hang the screen, and then install the Lower Wall Mount Brackets for a more precise fit.
- Adjustment in floor clearance and ceiling height should be made according to the actual installation site.

Installing the Cabinets (Standard Installation)

1. Carefully lift Cabinet "C" onto the center of the Upper Wall Mount Brackets.

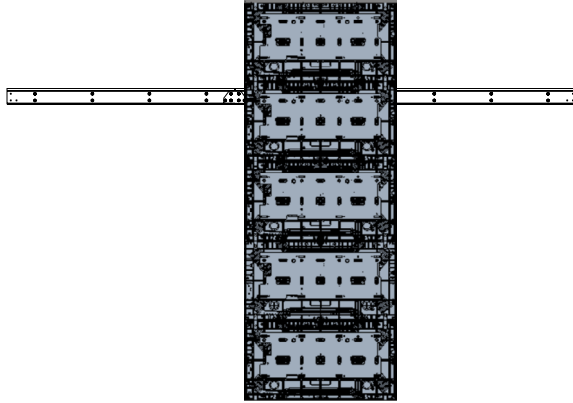

NOTE:

- One Cabinet, composed of five sections, weighs around 19.2 kg.
- You can identify Cabinets by the labels on the package and Cabinets.
- The arrow marks should be pointing down.

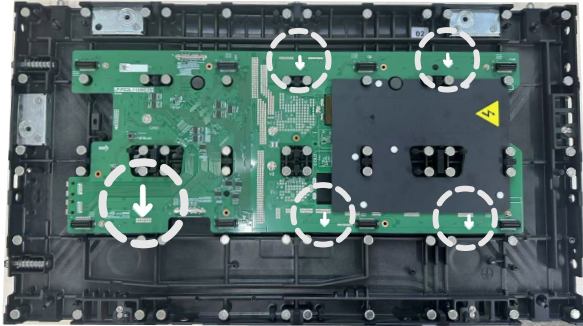

2. Ensure the Mounting Brackets sit securely on the Wall Mount Brackets as shown below.

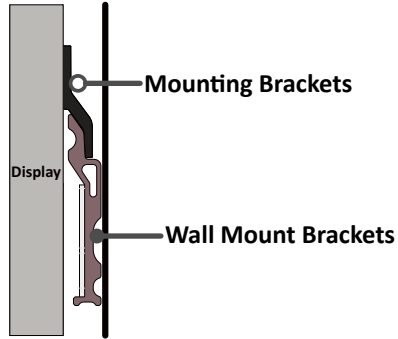

3. Lift Cabinet "B" and install it on the left side of Cabinet "C". Push each locking hook with the provided hex wrench to securely connect the two Cabinets together.

NOTE: There are five locking hooks between each Cabinet.

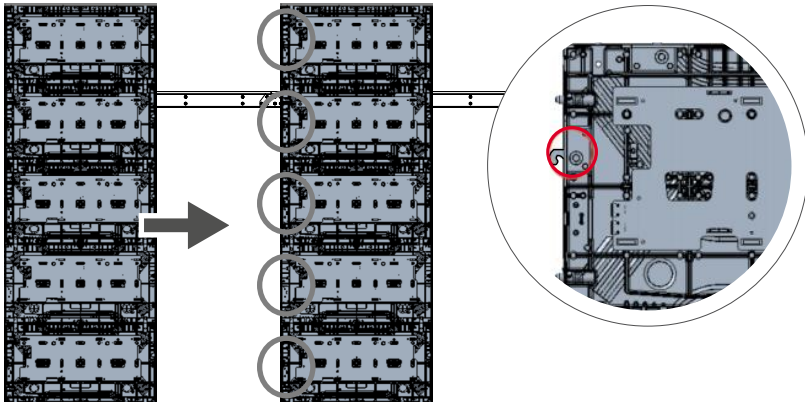

4. Check for unevenness of the Cabinets by rubbing the cross section between each Cabinet. If the cross section is not aligned, loosen the locking hook slightly and tap the Cabinets until the cross section is flat.

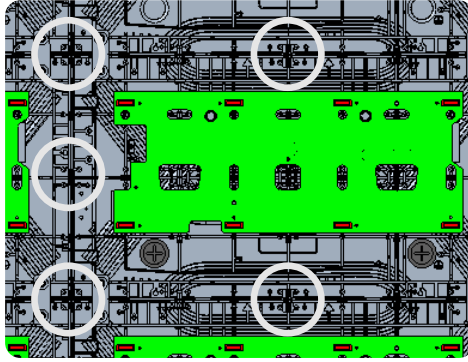

5. Place the remaining Cabinets onto the Wall Mount Brackets. Install from the center to the right and left sides of the Wall Mount Brackets.

NOTE: The installation sequence by Cabinet: C → B → D → A → E

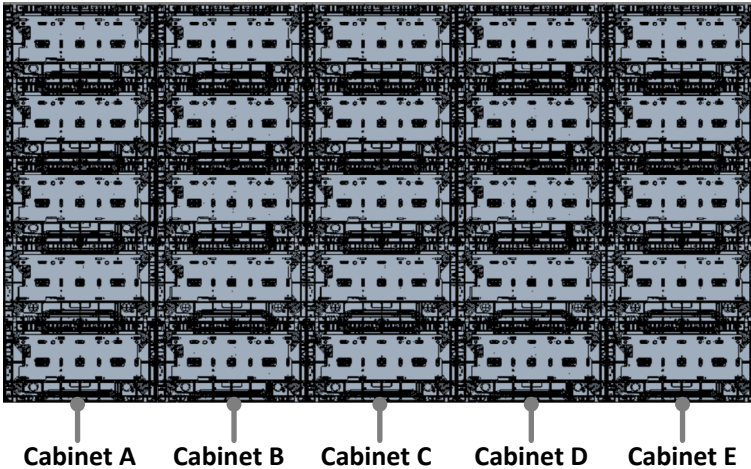

After all Cabinets are installed, please go to page 40 for the System Control Box (Standard and Trolley Installation).

Installing the Cabinets (Trolley Installation)

1. Place Cabinet "C", Cabinet "B", and Cabinet "D" facing down on stable furniture that can safely support three Cabinets.

NOTE:

- One Cabinet, composed of five sections, weighs around 19.2 kg.
 - You can identify Cabinets by the labels on the package and Cabinets.
2. Prepare Cabinet "C" by removing its Mounting Bracket and installing the Bracket to the lowest row of the Cabinet.

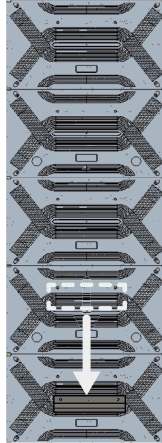

3. Repeat **Step 2** for the other two Cabinets "B" and "D".
4. Please follow **Step 1~4** on page 27~29 for Cabinet "C", Cabinet "B", and Cabinet "D".

NOTE: Ensure the Mounting Brackets sit securely on the Wall Mount Brackets.

5. Remove the Mounting Brackets of the remaining two Cabinets "A" and "E".

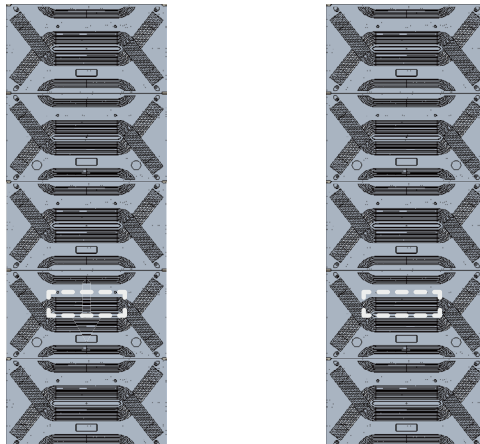

6. After removing the Mounting Brackets, place the Cabinets "A" and "E" onto the Wall Mount Brackets. Start with Cabinet "A" then "E".
7. Adjust the left Cabinet Bracket until it is aligned with the hole provided in the Cabinet. Then, properly tighten the M8 nut on the Left Support to lock the position.

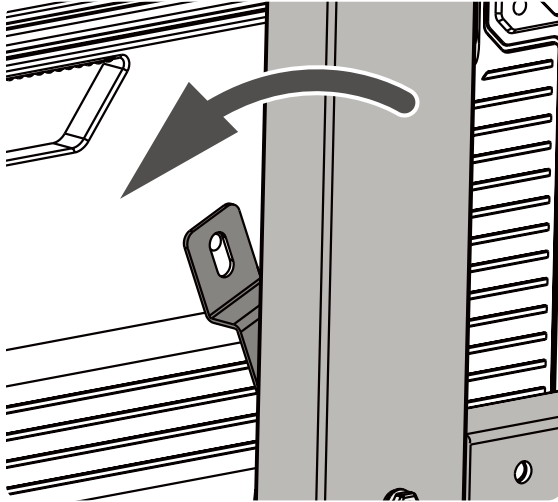

8. Secure the left Cabinet Bracket to the Cabinet with the provided screw (M8 x 20 mm).

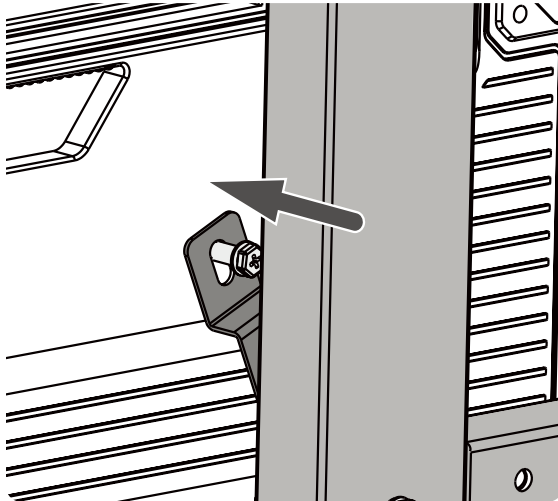

9. Install the right Cabinet Bracket in the same manner as the left Cabinet Bracket.
10. Ensure all parts are accurately and securely held together, as shown in the diagram below.

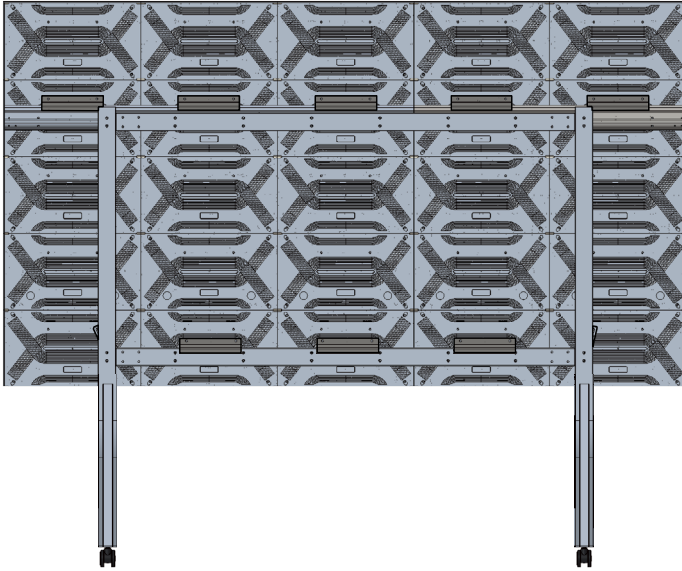

NOTE: When you use the trolley for your LED Display, the System Control Box can only be installed under the Cabinets (Standard Installation). Hidden and Separate Installation are not applicable to the trolley.

After all Cabinets are installed, please go to page 40 for the System Control Box (Standard and Trolley Installation).

Routing and Connecting the Power and Network Cables (Hidden and Separate Installation)

1. Prepare the following two items.

- 2 x Power Cables.
- 15 x Network Cables.

NOTE: Ensure the Cables prepared are of the correct length for your installation type.

2. Prepare the rubber hole plugs installed on the second row of the Cabinets by cutting the hole to size along the cross. The rubber hole plugs are used to protect the cables from rubbing against any pointed edges.

NOTE: The rubber hole plugs must always be placed in the holes.

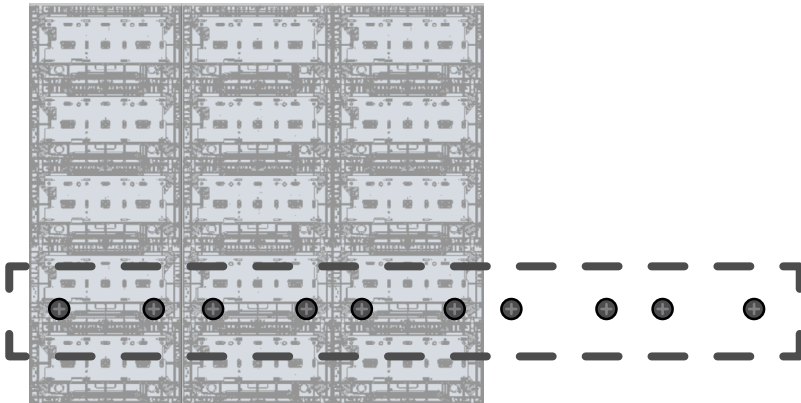

- Thread the connector end of the Power Cable of each Cabinet through the hole at the second row of the corresponding Cabinet to the front of the Cabinets. Then, thread one end of the Network Cable of each Cabinet in the same manner as the Power Cable.

NOTE:

- Avoid sharp bends or twists in the Cables.
- There are five Power and 15 Network Cables (three per one Cabinet) to thread.

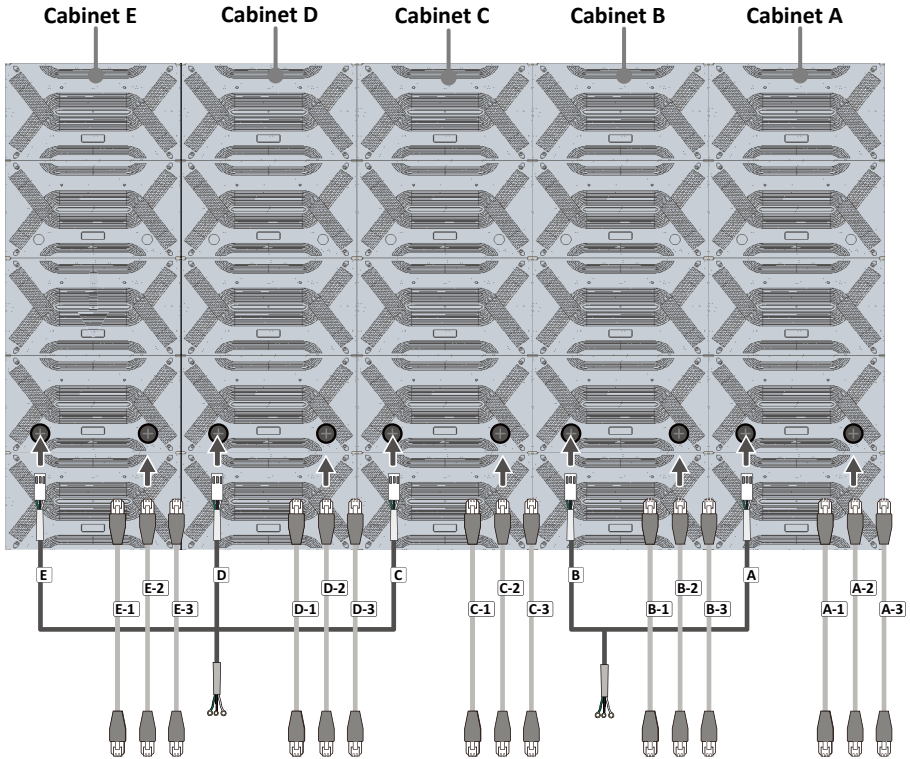

Rear View of the Cabinets

4. On the front of the Cabinets, connect the Power Cables to the appropriate power connectors on the lowest row of the Cabinets. Then, ground each Power Cable by installing its ground wire onto a rob provided in the Cabinets with the provided screw (M3 x 6 mm).

NOTE: There are five Power Cables and five ground wires to connect and install.

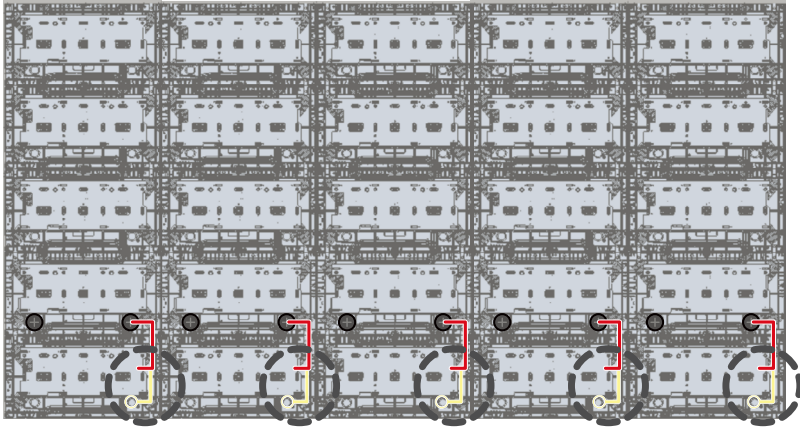

5. Connect the Network Cables of the Cabinets to the network ports of the Cabinets.

NOTE:

- There are 15 Network Cables (three per one Cabinet) to connect.
- Ensure the Network Cables labeled with "-1" are connected to the first row of the Cabinets, the Cables labeled with "-2" to the third row, and the Cables labeled with "-3" to the fifth row.

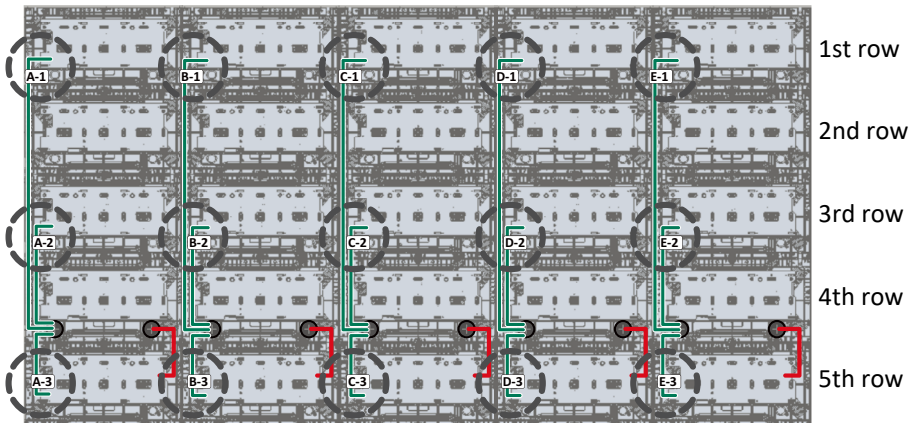

After connecting all cables and wires, please go to page 36 (Hidden Installation) or page 38 (Hidden Installation) for the Cabinets.

Installing the Cabinets (Hidden Installation)

Before installing the Cabinets, ensure that the Power and Network Cables of the Cabinets have already connected. Go to page 33 for how to route and connect the Power and Network Cables.

1. Place Cabinet "B" and Cabinet "D" facing down on stable furniture that can safely support the two Cabinets.

NOTE:

- One Cabinet, composed of five sections, weighs around 19.2 kg.
- You can identify Cabinets by the labels on the package.
- The arrow marks should be pointing down.

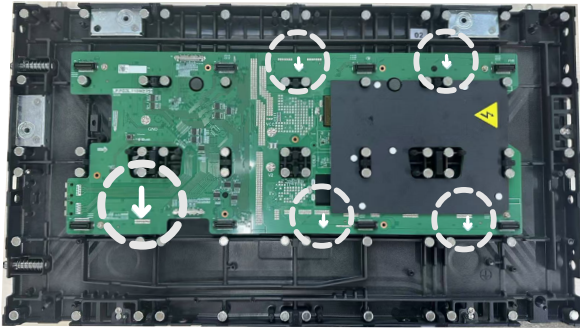

2. Install the Upper System Control Box Mount Brackets to the side of the two Cabinets "B" and "D" as shown below using the provided screws (M8 x 20 mm).

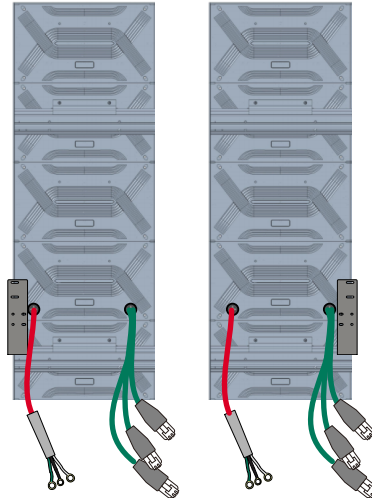

Rear View of Cabinet "B" (right) and Cabinet "D" (left)

3. Carefully lift Cabinet "C" onto the center of the Upper Wall Mount Brackets.

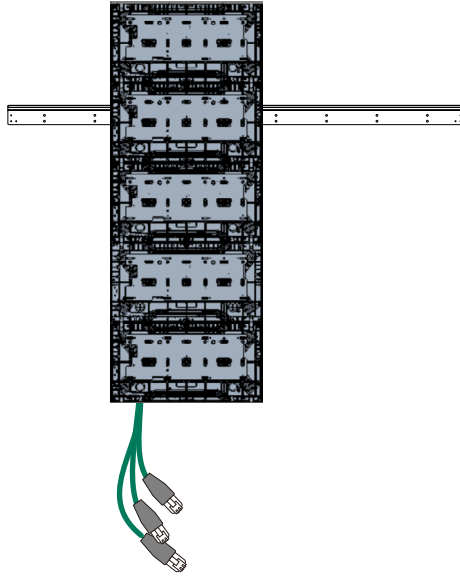

4. Ensure the Mounting Brackets sit securely on the Wall Mount Brackets as shown below.

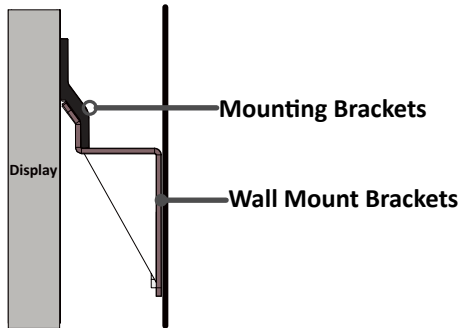

5. Please follow **Step 3~4** on page 28~29 for the remaining Cabinets. The installation sequence by Cabinet: C → B → D → A → E

After all Cabinets are installed, please go to page 47 for the System Control Box (Hidden Installation).

Installing the Cabinets (Separate Installation)

Before installing the Cabinets, ensure that the Power and Network Cables of the Cabinets have already connected. Go to page 33 for how to route and connect the Power and Network Cables.

1. Please follow **Step 1~2** on page 27~28 for Cabinet "C".
2. Carefully thread the other end of the Power Cable of the Cabinets behind the Cabinets from the top cable access hole through the bottom cable access hole on the left.

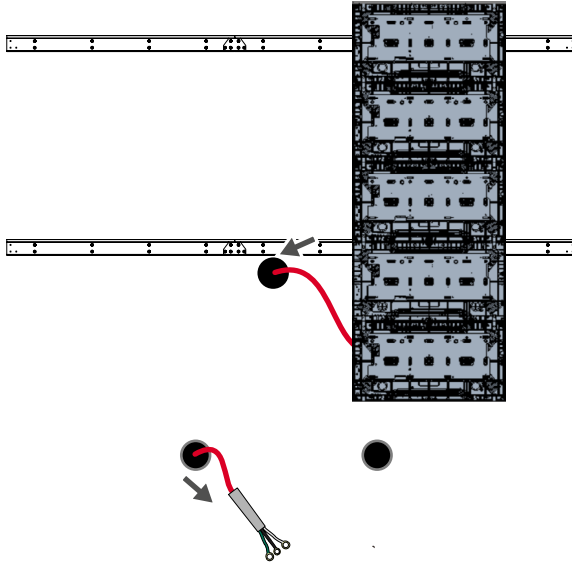

- Carefully thread the other end of the Network Cable of the Cabinet "C" in the same manner as the Power Cable, but run the Network Cable through the bottom cable access hole on the right instead.

NOTE: There are three Network Cables to thread.

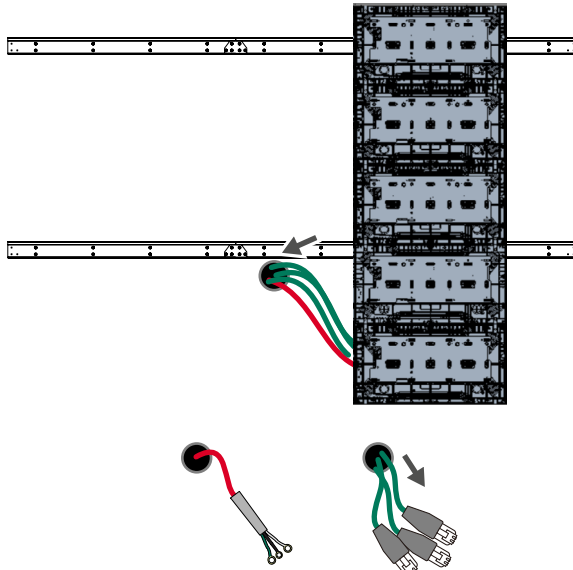

- Please follow **Step 1~4** on page 28~29 for Cabinet "B".
- Repeat **Step 1~3** for the other Power Cable and the Network Cables of the Cabinet "B".
- Place the remaining Cabinets onto the Wall Mount Brackets and thread the Network Cables through the bottom cable access hole on the right in the same manner as the first two Cabinets.

NOTE:

- There are nine Network Cables (three per one Cabinet) to thread.
- The installation sequence by Cabinet: C → B → D → A → E

After all Cabinets are installed, please go to page 52 for the System Control Box (Separate Installation).

Connecting the System Control Box (Standard and Trolley Installation)

The left and right sides of the System Control Box are pre-installed with its Covers in the factory. The main system control board is on the right.

- ❗ The safety wires are used to prevent the Right Cover from falling when accessing the System Control Box. Please ensure that the safety wires are never removed.
- ❗ Use caution as the System Control Box panel is separated into two pieces with wires attached.

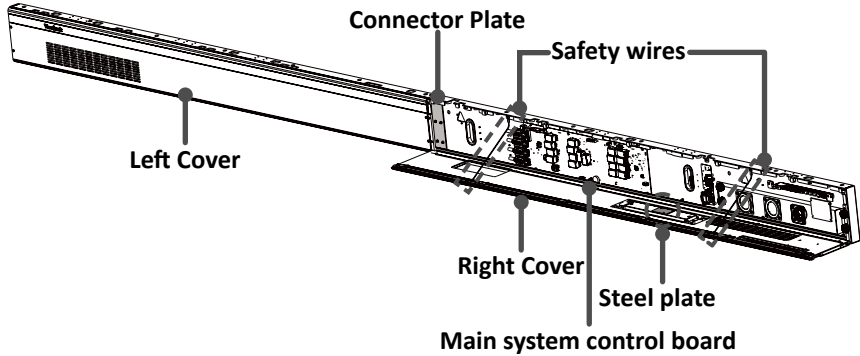

1. Carefully place the System Control Box on stable furniture that can safely support the System Control Box.
2. To open the Right Cover, slowly bring the supplied System Control Box Maintenance Tool near the surface of the Right Cover where the steel plate is located. Then, the Right Cover should detach from the System Control Box magnetically.

- ❗ DO NOT try to remove or disconnect the safety wires. Please ensure that the safety wires are never removed.

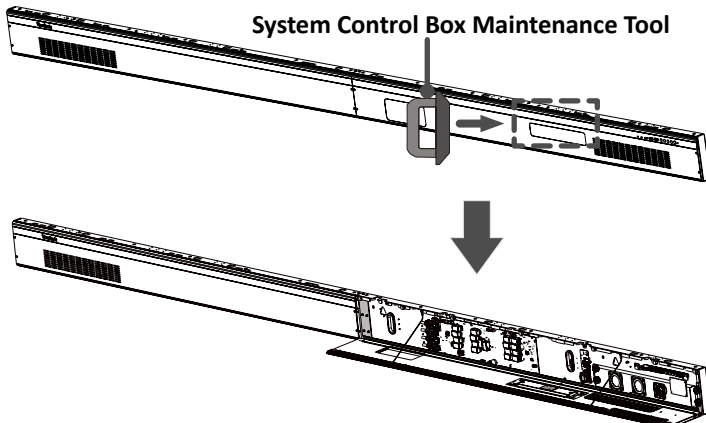

3. Remove the Left Cover by gripping the top edge of the Cover and pulling it toward you. The Left Cover should simply lift away.

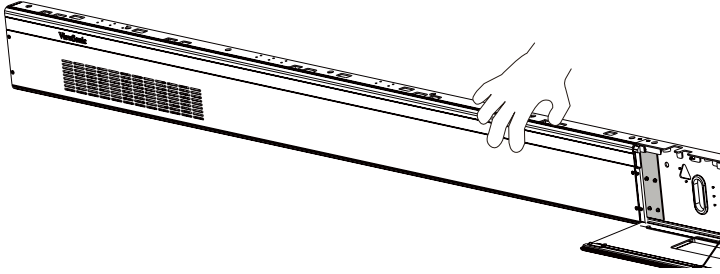

4. Secure the System Control Box panel with the Connector Plate using the provided screws (M3 x 6 mm).

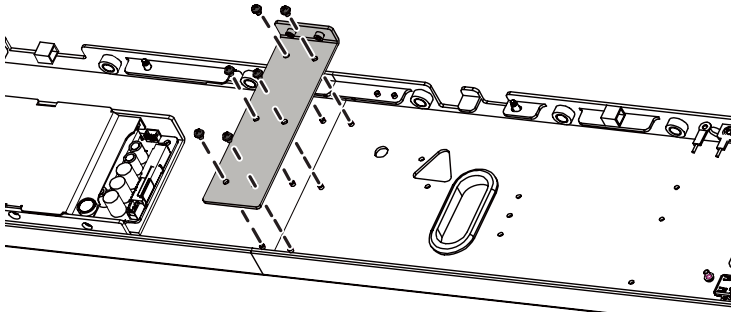

5. Further secure the Connector Plate with the two provided screws (M3 x 6 mm).

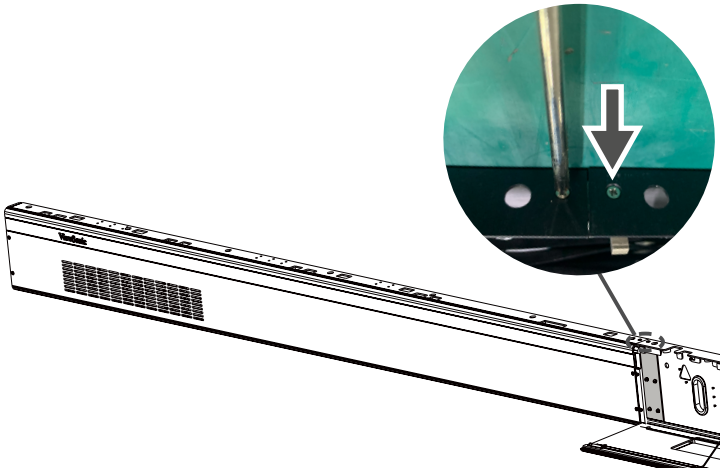

6. Align the holes of the Cabinets with the System Control Box to attach.
7. Carefully route the Power and Network Cables through the holes in each Cabinet.

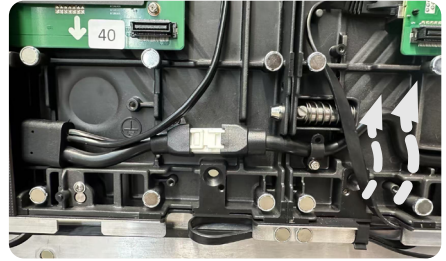
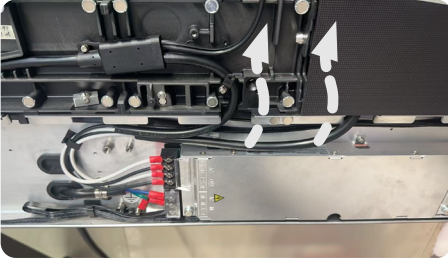

8. Install the System Control Box to the bottom of the Cabinets with the provided screws (M8 x 20 mm).

NOTE: There are 10 threaded holes between the Cabinets and the System Control Box.

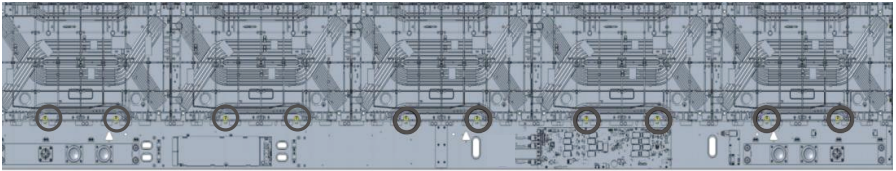

9. Slide a System Control Box Spacer on the M8 screw as shown below. Then, secure the Spacer with the provided screw (M3 x 8 mm) to connect the System Control Box with the Cabinets firmly.

NOTE: There are 10 System Control Box Spacers to install.

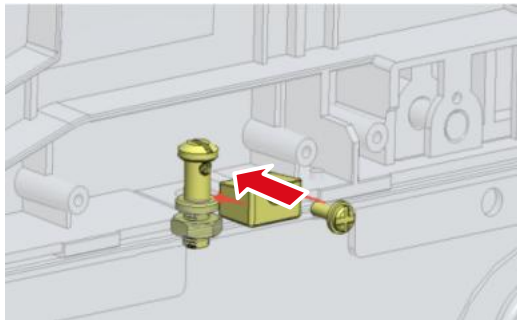

10. Connect the Power and Network Cables from the System Control Box to each Cabinet. Ensure the labels on the Cables match the cabinet labels (A to A, B to B, C to C, and so on).

NOTE:

- Each Cabinet has one Power and three Network Cables to connect.
- Ensure the Network Cables labeled with "-1" are connected to the first row of the Cabinets, the Cables labeled with "-2" to the third row, and the Cables labeled with "-3" to the fifth row.
- Connect the Power Cables only to the bottom of each Cabinet.

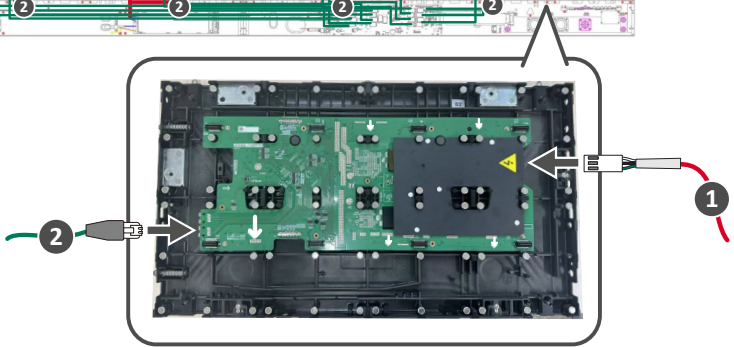
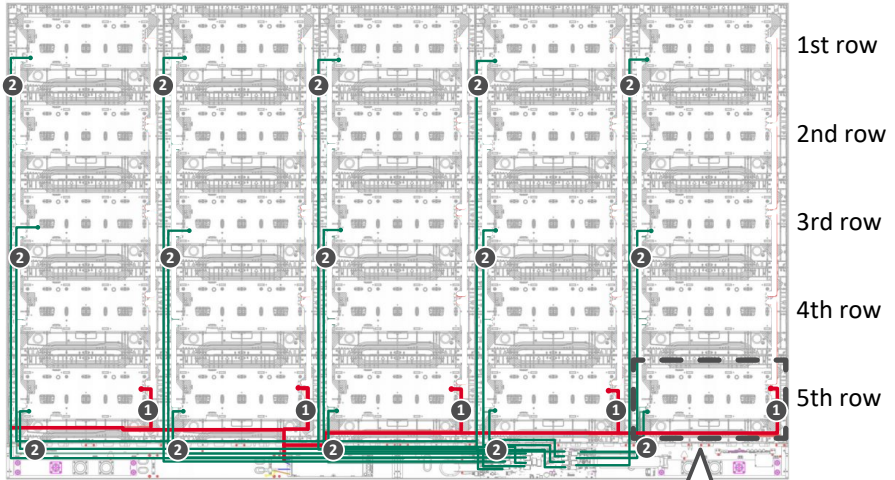

Number	Cables	Images
1	Power Cable	
2	Network Cable	

11. Connect the left system control board to the main system control board.

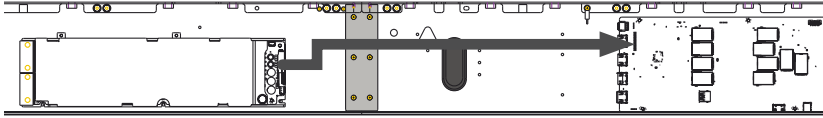

12. Connect the LED Display's left speaker to the Audio Out port of the system control board.

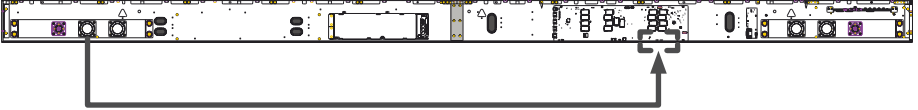

NOTE: Ensure the right speaker is properly connected to the other Audio Out port.

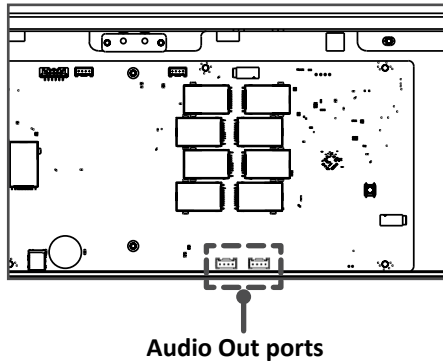

13. Ensure the AC unit of the System Control Box is properly connected.

❗ DO NOT connect the System Control Box Power Cables at this time.

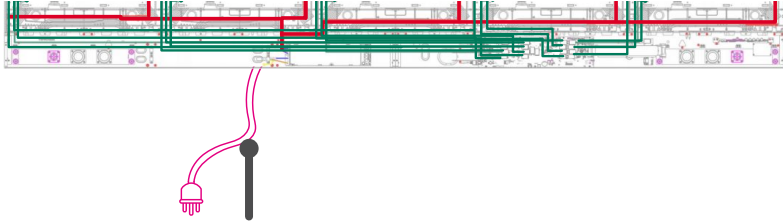

System Control Box Power Cables

- The neutral wires (usually white/blue) are connected to the "N1", "N2", and "N" terminals.
- The hot wires (usually black/brown) are connected to the "L1", "L2", and "L" terminals.
- The input and output terminals are properly grounded (2 x AC OUT and 1 x AC IN, usually in green-yellow/green).
- ❗ The meaning of wiring color may vary by country.

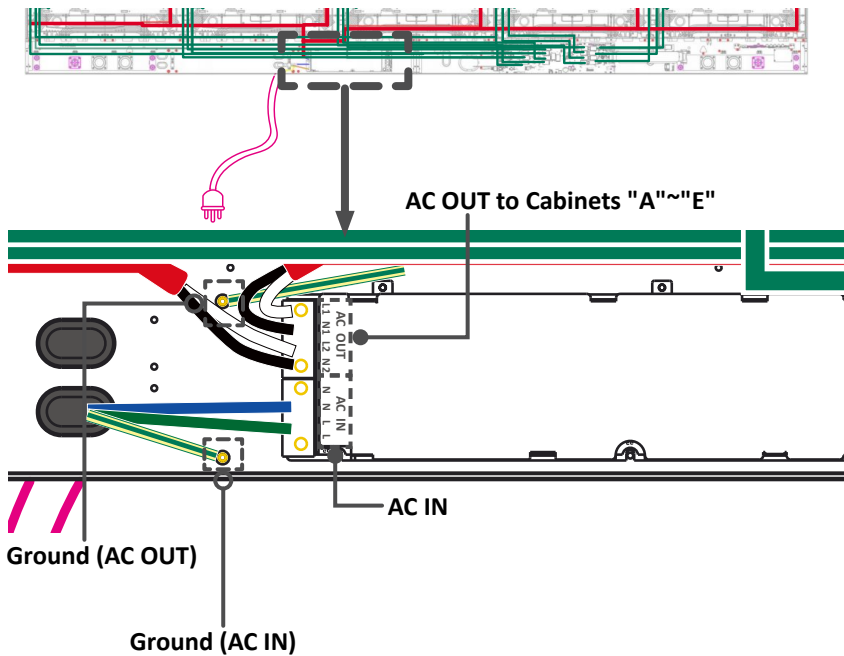

14. Locate and route the System Control Box's ground wire (usually in green-yellow/green) through the hole and into the Cabinet. Then, remove the pre-installed screw on the rod as shown below, connect the ground wire to the rod, and properly secure the wire with the screw.

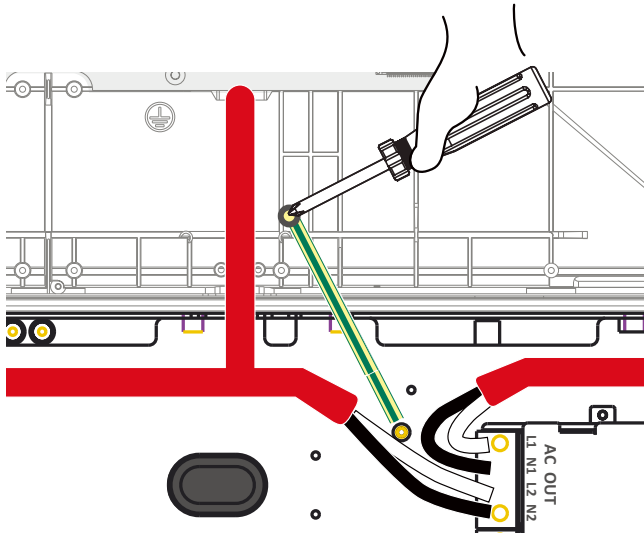

15. After connecting all cables and wires, hold the top edge of the Right Cover toward the System Control Box to replace it. Once the Right Cover is replaced, it will be held in place magnetically.

NOTE: Ensure the **Power** Button cable is connected before securing the Right Cover.

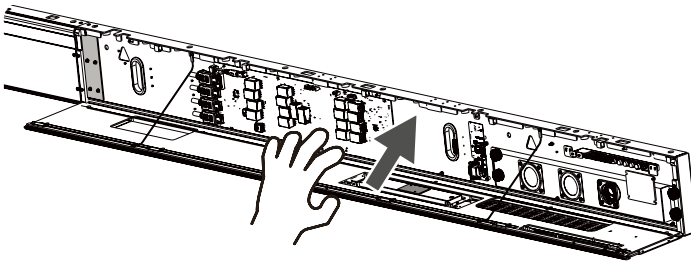

16. Replace the Left Cover by aligning it properly with the System Control Box; then the Left Cover should attach magnetically.

After the System Control Box is connected, please go to page 54 for the LED Modules.

Connecting the System Control Box (Hidden Installation)

The left and right sides of the System Control Box are pre-installed with its Covers in the factory. The main system control board is on the right.

- ❗ The safety wires are used to prevent the Right Cover from falling when accessing the System Control Box. Please ensure that the safety wires are never removed.
- ❗ Use caution as the System Control Box panel is separated into two pieces with wires attached.

1. Please follow **Step 1~5** on page 40~41 for the System Control Box and the Connector Plate.
 - ❗ DO NOT try to remove or disconnect the safety wires. Please ensure that the safety wires are never removed.
2. Install the short side of the Lower System Control Box Mount Bracket onto the top of the System Control Box with the provided screws (M3 x 6 mm).

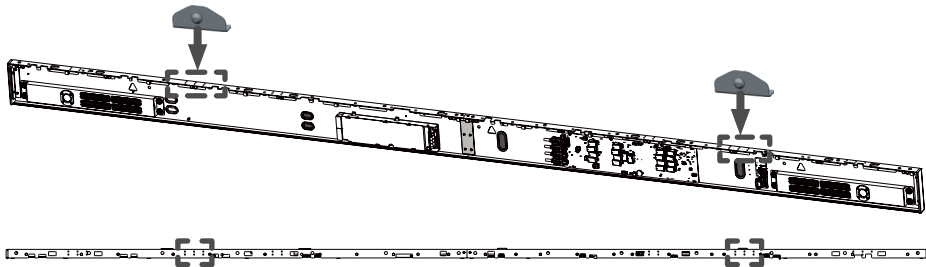

Installing the Lower System Control Box Mount Brackets onto the System Control Box (Front and Top Views)

3. Install the provided screw (M8 x 16 mm) on the Lower System Control Box Mount Bracket. Thread the provided M8 nut onto the screw and fully tighten the nut.

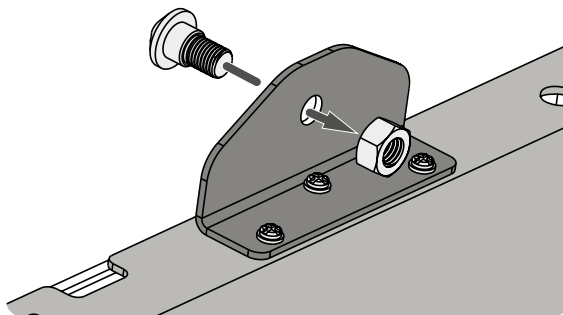

Installing the provided screw and nut to the Brackets (Rear View)

4. Repeat **Step 2~3** for the other Lower System Control Box Bracket.

- Prepare the rubber hole plugs installed on the System Control Box by cutting the hole to size along the cross. The rubber hole plugs are used to protect the Cables from rubbing against any pointed edges.

NOTE: The rubber hole plugs must always be placed in the holes.

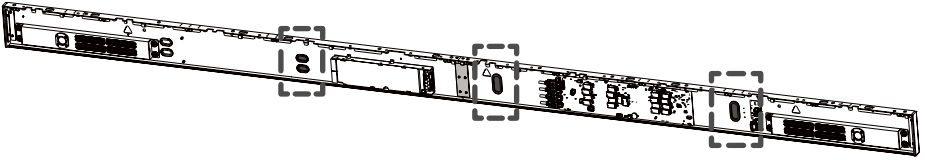

- Remove the pre-installed Power and Network Cables of the Cabinets from the System Control Box.

NOTE:

- There are five Power and 15 Network Cables to remove.
 - It is recommended to take photos of the completed wiring in the left and main system control boards before removing the Cables.
- Carefully thread the Power and Network Cables through the holes provided in the System Control Box from behind. Ensure to use the correct cable holes for the Power and Network Cables.

NOTE:

- There are two Power and 15 Network Cables to thread.
- Avoid sharp bends or twists on the Cables.

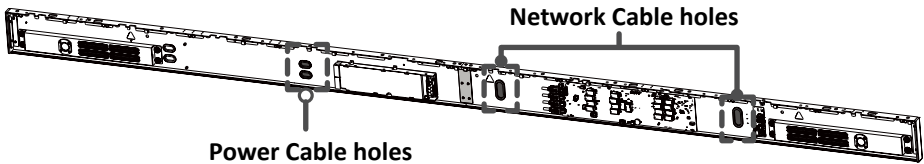

- Connect the other end of the Network Cable to the network port that was disconnected from the System Control Box in **Step 6**.

NOTE: There are 15 Network Cables to connect.

9. After connecting all the Network Cables, please follow the diagram below to connect the Power Cables of the Cabinets to the AC unit of the System Control Box.

❗ DO NOT connect the System Control Box Power Cable at this time.

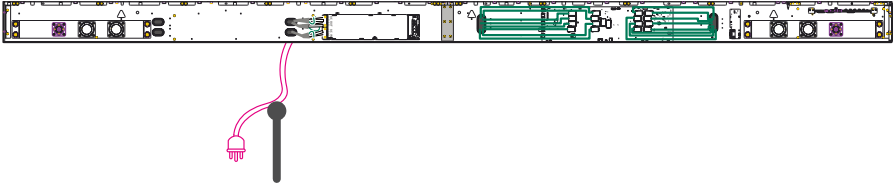

System Control Box Power Cables

- Connect the neutral wires (usually white/blue) to the "N1" and "N2" terminals.
 - Connect the hot wires (usually black/brown) to the "L1" and "L2" terminals.
 - Connect the ground wires (usually in green-yellow/green) to the ground terminals.
- ❗ The meaning of wiring color may vary by country.
- ❗ Use the provided wrench to tighten the neutral, hot, and ground conductors in the terminals properly.
- ❗ The Power Cable must be properly grounded. Follow the electrical codes in your area if additional grounding is required.

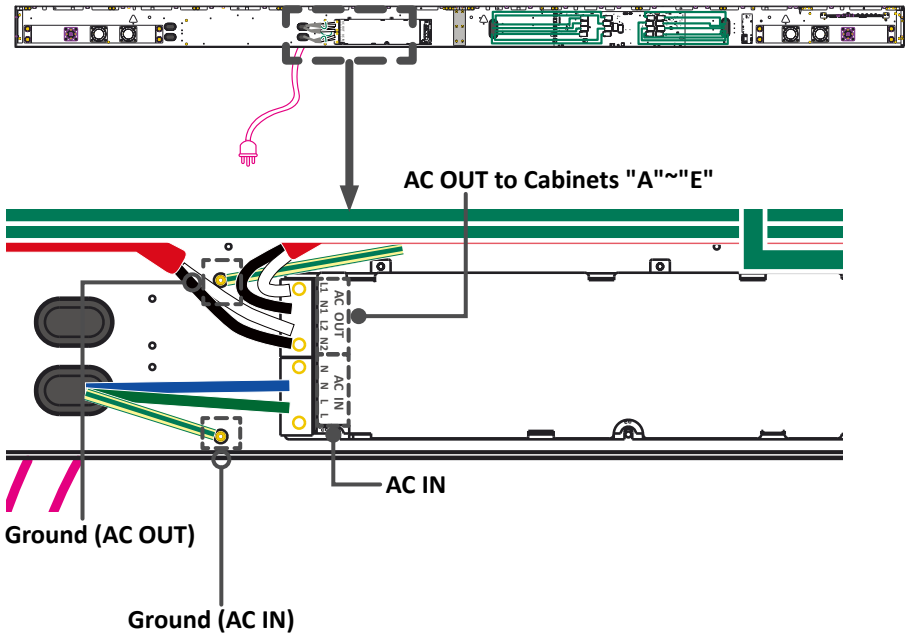

10. Remove the System Control Box's ground wire (usually in green-yellow/green).

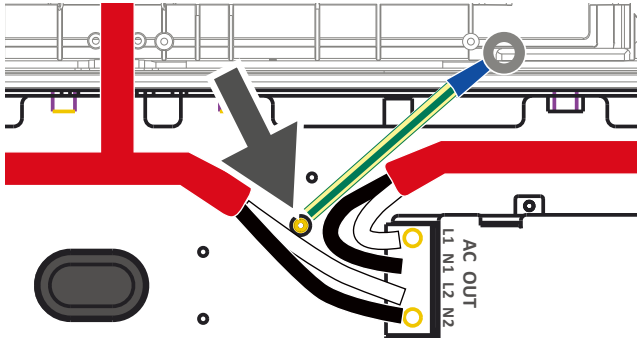

11. Please follow **Step 11~12** on page 44 for the system control board.

NOTE: After the IR Extension Cable is connected, route it through the adjacent cable hole as highlighted below to the rear.

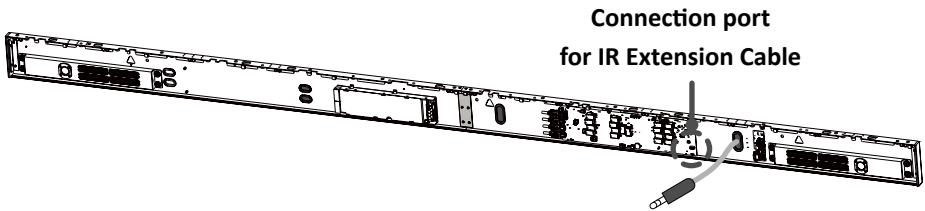

12. After connecting all Cables and wires, please follow **Step 15~16** on page 46 for the System Control Box Covers.

NOTE: Please ensure there are no sharp bends or twists in the Cables and wires.

13. Align the Lower System Control Box Mount Brackets with the Upper Mount Brackets to attach.

14. Carefully place the Lower System Control Box Mount Brackets onto the Upper System Control Box Mount Brackets.

NOTE: To avoid sharp bends or twists in the Cables, please pull them into the Cabinets and manage the Cables there.

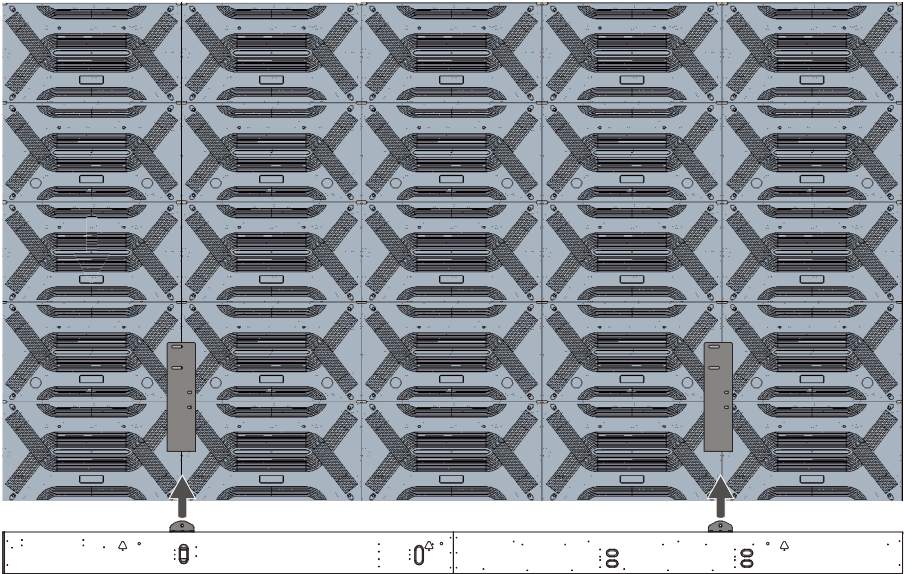

Placing the Lower System Control Box Mount Bracket onto the Upper (Rear View)

15. Ensure the Lower System Control Box Mount Brackets sit securely on the Upper.

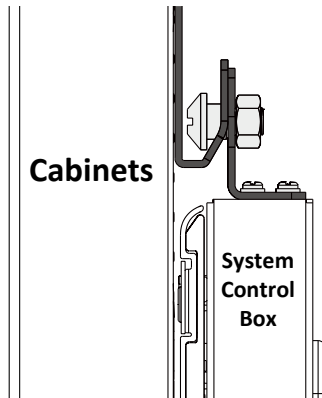

After the System Control Box is connected, please go to page 54 for the LED Modules.

Connecting the System Control Box (Separate Installation)

The left and right sides of the System Control Box are pre-installed with its Covers in the factory. The main system control board is on the right.

- ❗ The safety wires are used to prevent the Right Cover from falling when accessing the System Control Box. Please ensure that the safety wires are never removed.
- ❗ Use caution as the System Control Box panel is separated into two pieces with wires attached.

1. Please follow **Step 1~5** on page 40~41 for the System Control Box and the Connector Plate.

- ❗ DO NOT try to remove or disconnect the safety wires. Please ensure that the safety wires are never removed.

2. Prepare the rubber hole plugs installed on the System Control Box by cutting the hole to size along the cross. The rubber hole plugs are used to protect the Cables from rubbing against any pointed edges.
3. Place the System Control Box accordingly over the drilled mounting holes to attach.
4. Carefully thread the Power and Network Cables through the holes provided in the System Control Box from behind. Ensure to use the correct cable holes for the Power and Network Cables.

NOTE:

- There are two Power and 15 Network Cables to thread.
- Avoid sharp bends or twists on the Cables.

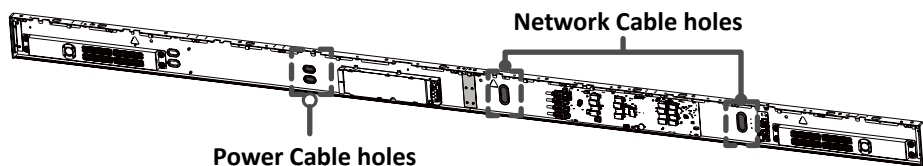

5. After threading the Power and Network Cables, install the System Control Box onto the wall with the provided screws (M8 x 80 mm Expansion for masonry; wood screws for load bearing wood).

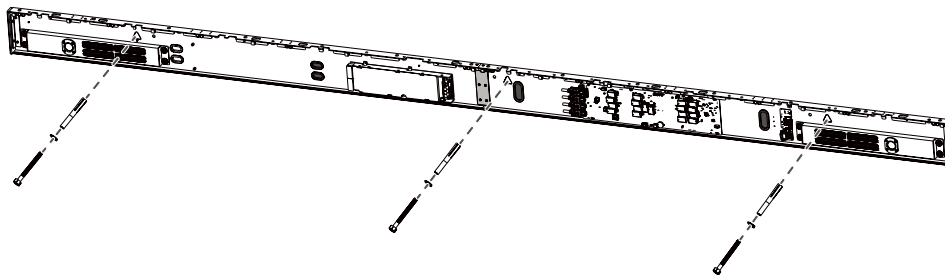

6. Remove the pre-installed Power and Network Cables of the Cabinets from the System Control Box.

NOTE:

- There are five Power and 15 Network Cables to remove.
- It is recommended to take photos of the completed wiring in the left and main system control boards before removing the Cables.

7. After removing the pre-installed Power and Network Cables of the Cabinets, connect the other end of the Network Cables to the network port that was disconnected from the System Control Box in **Step 6**.

NOTE: There are 15 Network Cables to connect.

8. Please follow **Step 9~10** on page 49~50 for the Power Cables and the System Control Box's ground wire.

9. Please follow **Step 11~12** on page 44 for the system control board.

NOTE: After the IR Extension Cable is connected, route it through the adjacent cable hole as highlighted below to the rear.

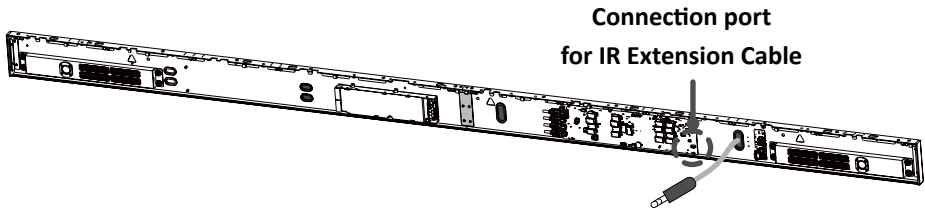

10. After connecting all cables and wires, please follow **Step 15~16** on page 46 for the System Control Box Covers.

⚠ Ensure there are no sharp bends or twists in the Cables and wires.

After the System Control Box is connected, please go to page 54 for the LED Modules.

Installing the LED Modules

- ❗ Please wear Anti-Static Gloves before handling the LED Modules.
- ❗ To avoid direct contact with the LED Modules, please remove watches, rings, bracelets, or other metal objects.
- ❗ Use caution when installing the LED Modules.

1. Starting from the LED Module labeled "1" in the top left corner, align each LED Module with the Cabinet, then carefully press the Module into place.

NOTE: The arrow mark on the back of the LED Modules should be pointing down.



2. Attach the remaining LED Modules onto the Cabinets. Install from top left and move to bottom right, ensuring to match the corresponding numbers on the Module to the Cabinet.



NOTE: Before installing the LED Module, ensure that each Module is flush and that there is little to no gap between each. It may be necessary to gently tap the module to make it flush.

After all LED Modules are installed, please go to page 55 (Standard and Trolley Installation) or page 56 (Hidden and Separate Installation) for the Screen Bezels.

Installing the Screen Bezels (Standard and Trolley Installation)

- ❗ The Screen Bezels' plastic tabs are pre-installed onto the Bezels. Ensure all plastic tabs are properly mounted before installing the Screen Bezels onto the screen.

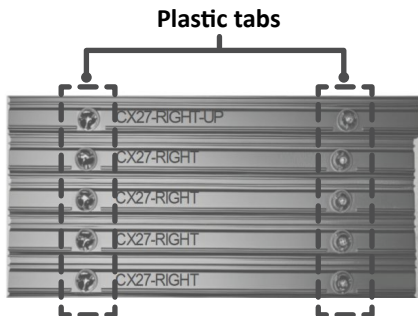

1. Place the Screen Bezels to the correct side of the screen to attach. It is easier to start with the top Bezels first then put on the sides. The top Screen Bezels (left and right) are around 2 mm longer than the others.

NOTE:

- Each Screen Bezel is marked, so you'll know which side to install.
 - If a Screen Bezel does not seem to fit, lift it up with caution and check if it is on the correct side to install. If the Bezel does not seem to fit at all, please contact your dealer. **DO NOT** force it into place.
2. Align the plastic tabs of the Screen Bezel with the holes in the screen.

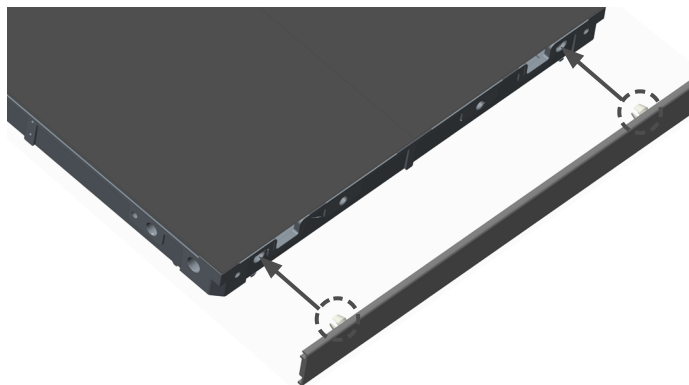

3. Press down on the Screen Bezel until you hear it click into place.
4. Place the remaining Screen Bezels onto the left and right sides of the screen.

NOTE: There are five Screen Bezels on either left or right side of the screen to install.

After all Screen Bezels are installed, please go to page 57 to finish the installation.

Installing the Screen Bezels (Hidden and Separate Installation)

- ❗ The Screen Bezels' plastic tabs are pre-installed onto the Bezels. Ensure all plastic tabs are properly mounted before installing the Screen Bezels onto the screen.

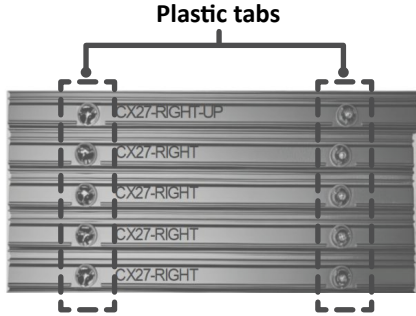

1. Please follow **Step 1~4** on page 55 for the left and right sides of the Screen Bezels.

NOTE:

- Each Screen Bezel is marked, so you'll know which side to install.
- If a Screen Bezel does not seem to fit, lift it up with caution and check if it is on the correct side to install. If the Bezel does not seem to fit at all, please contact your dealer. **DO NOT** force it into place.

2. Install the bottom Screen Bezels with the provided screws (M3 x10 mm).

NOTE: There are five Screen Bezels to install.

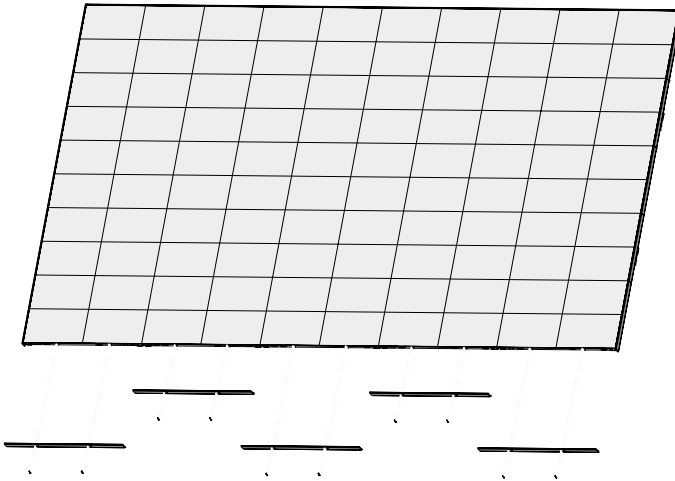

After all Screen Bezels are installed, please go to page 57 to finish the installation.

Turning On the LED Display

1. Make sure the System Control Box Power Cable is connected and plugged into a power outlet.

NOTE: When the System Control Box Power Cable is connected to a power outlet, the Power Indicator Light will be a steady red. This means the LED Display is in standby mode. Please refer to the User Guide for more details.

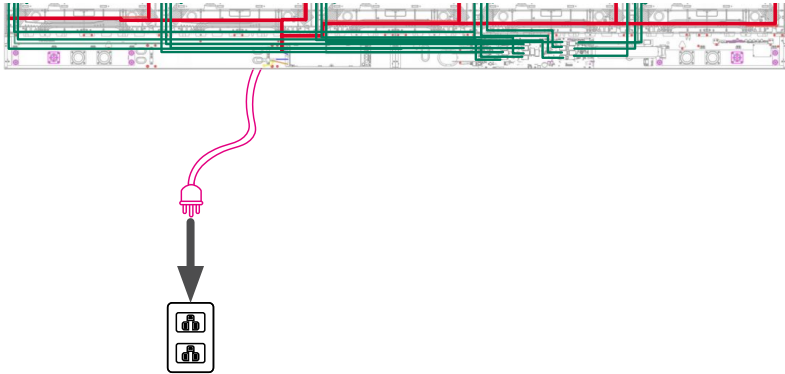

2. Your LED Display is now ready to power on.



ViewSonic®