

THE INFORMATION AND DESIGNS CONTAINED IN THIS DRAWING ARE CONFIDENTIAL AND THE PROPRIETARY PROPERTY OF LEGRAND | AV. NEITHER THIS DESIGN NOR ANY INFORMATION CONTAINED IN THIS DRAWING MAY BE REPRODUCED OR DISCLOSED TO OTHERS WITHOUT THE EXPRESS WRITTEN CONSENT OF LEGRAND | AV.

CAD GENERATED DRAWING, DO NOT MANUALLY UPDATE.						6436 CITY WEST PKWY EDEN PRAIRIE MN, 55344 PHONE: 866-977-3901 FAX: 877-894-6918	
DRAWN BY	NC	10/10/2023	DESCRIPTION				
ENG APPROVAL			FPIWMA101 TECH DRAWING				
MFG APPROVAL			MODEL NO.				
QA APPROVAL			SCALE				
SHEET 1 OF 3		1:6	SIZE	DWG. NO.	REV.		
		B	TECH-001288		00		

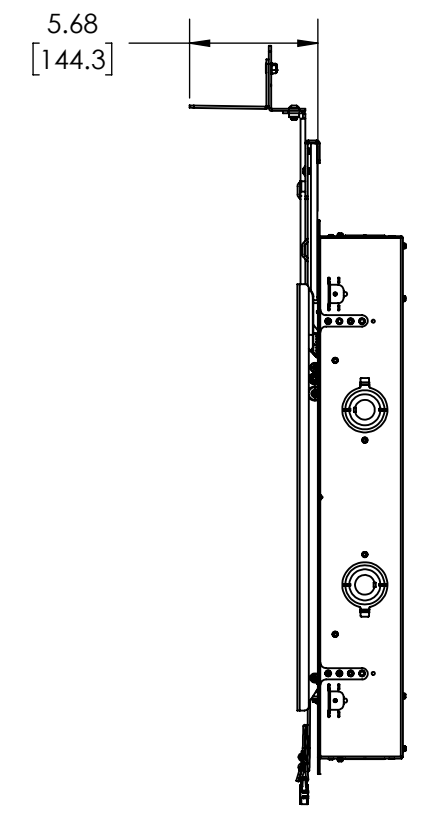

FPIWMS SHOWN AS REFERENCE ONLY

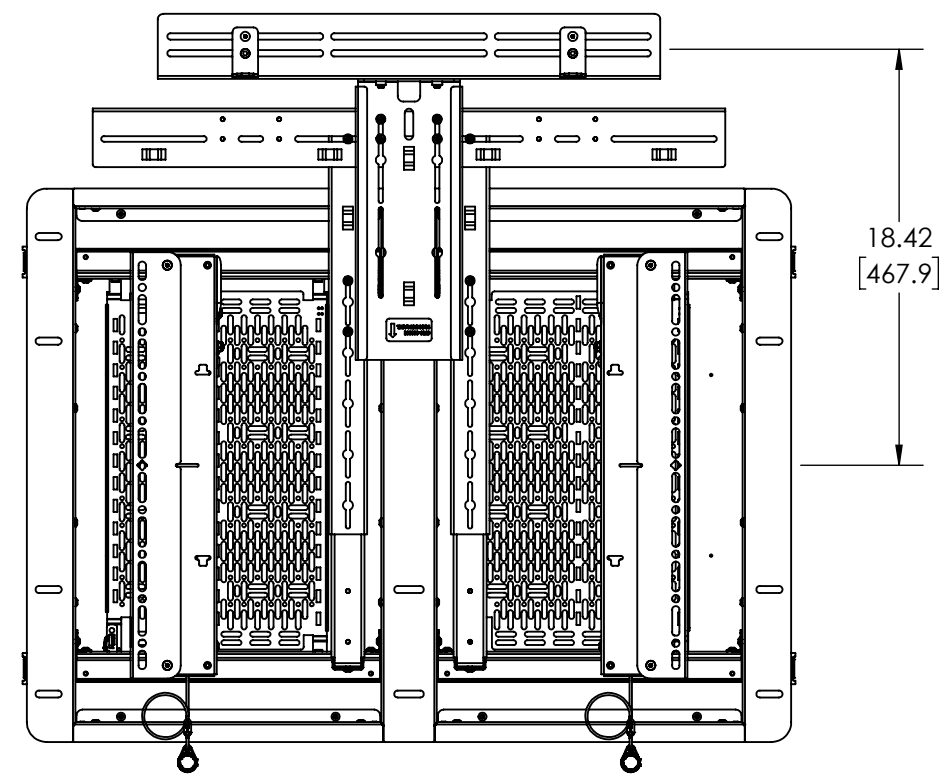
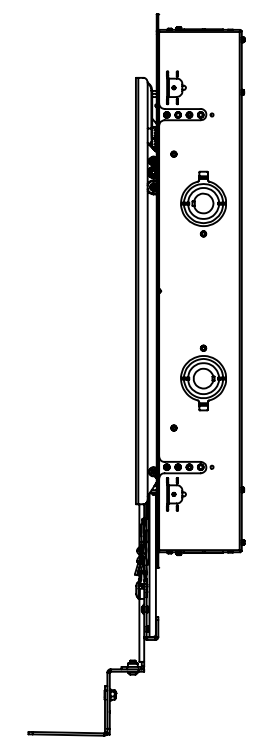
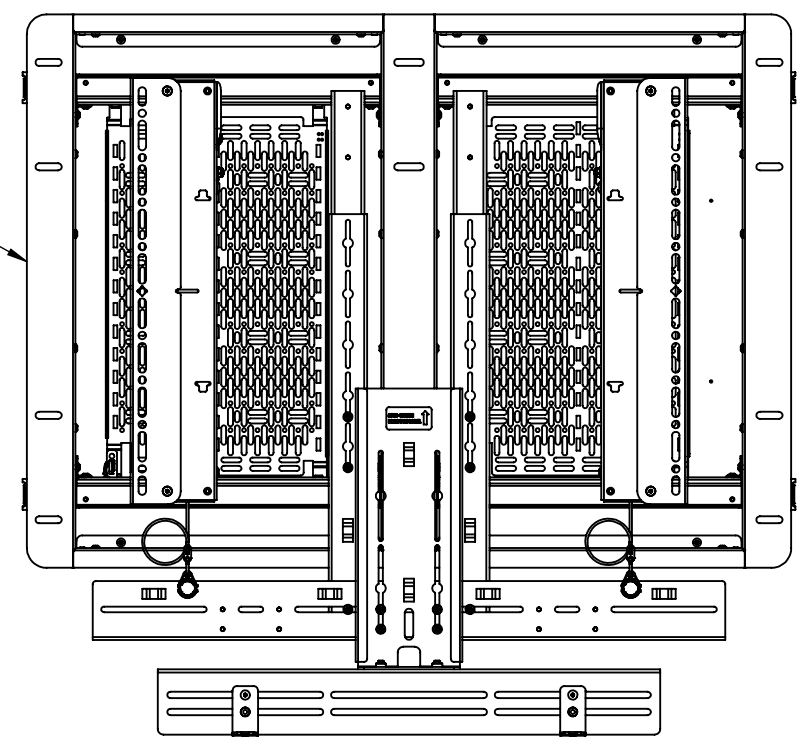

THE INFORMATION AND DESIGNS CONTAINED IN THIS DRAWING ARE CONFIDENTIAL AND THE PROPRIETARY PROPERTY OF LEGRAND | AV. NEITHER THIS DESIGN NOR ANY INFORMATION CONTAINED IN THIS DRAWING MAY BE REPRODUCED OR DISCLOSED TO OTHERS WITHOUT THE EXPRESS WRITTEN CONSENT OF LEGRAND | AV.

CAD GENERATED DRAWING, DO NOT MANUALLY UPDATE.				 6436 CITY WEST PKWY EDEN PRAIRIE, MN, 55344 PHONE: 866-977-3901 FAX: 877-894-6918	
DRAWN BY	NC	10/10/2023	DESCRIPTION		
ENG APPROVAL			FPIWMA101 TECH DRAWING		
MFG APPROVAL			MODEL NO.		
QA APPROVAL			SIZE	DWG. NO.	REV.
SHEET 2 OF 3		SCALE	B	TECH-001288	00
		1:8.5			

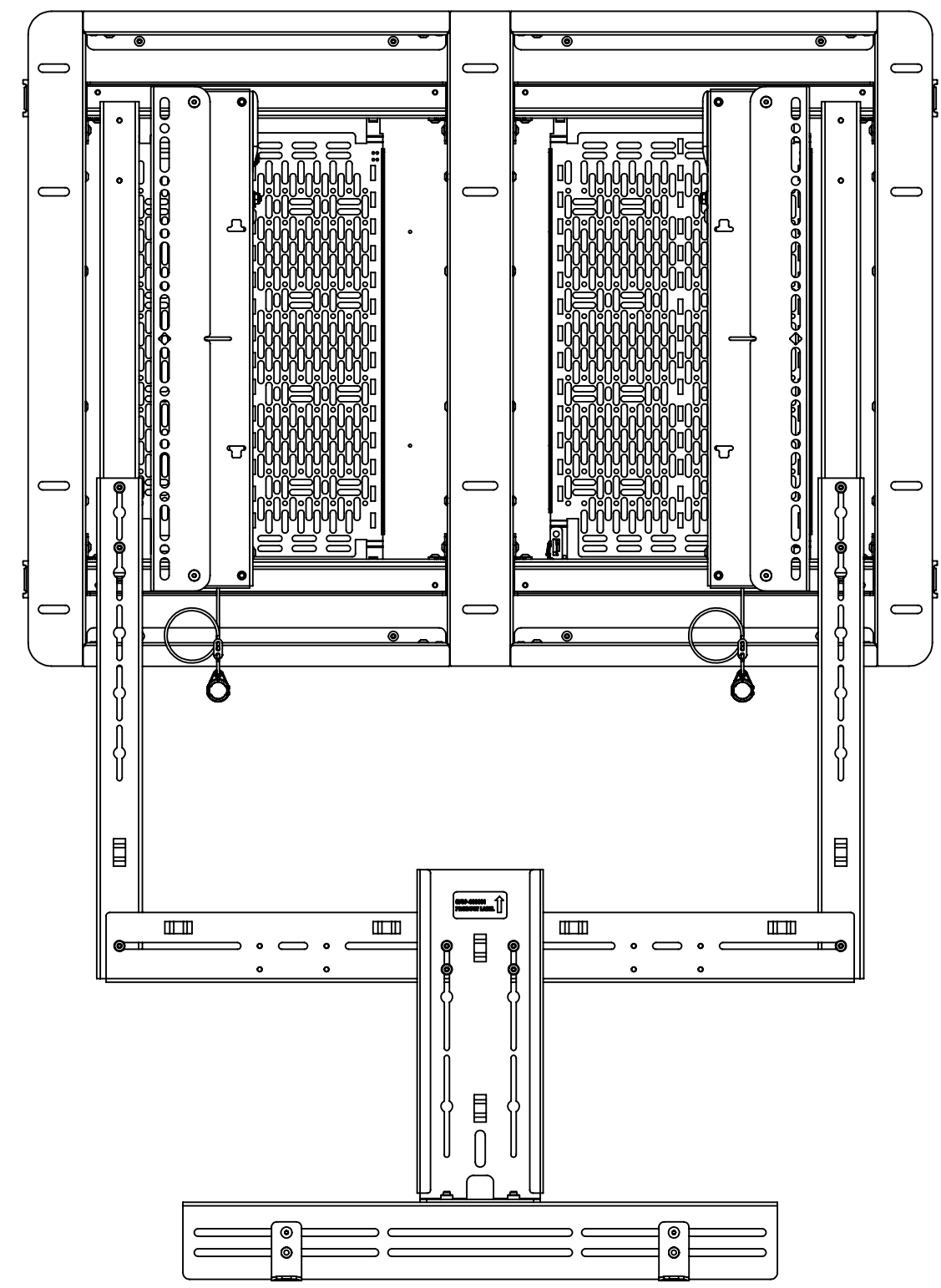
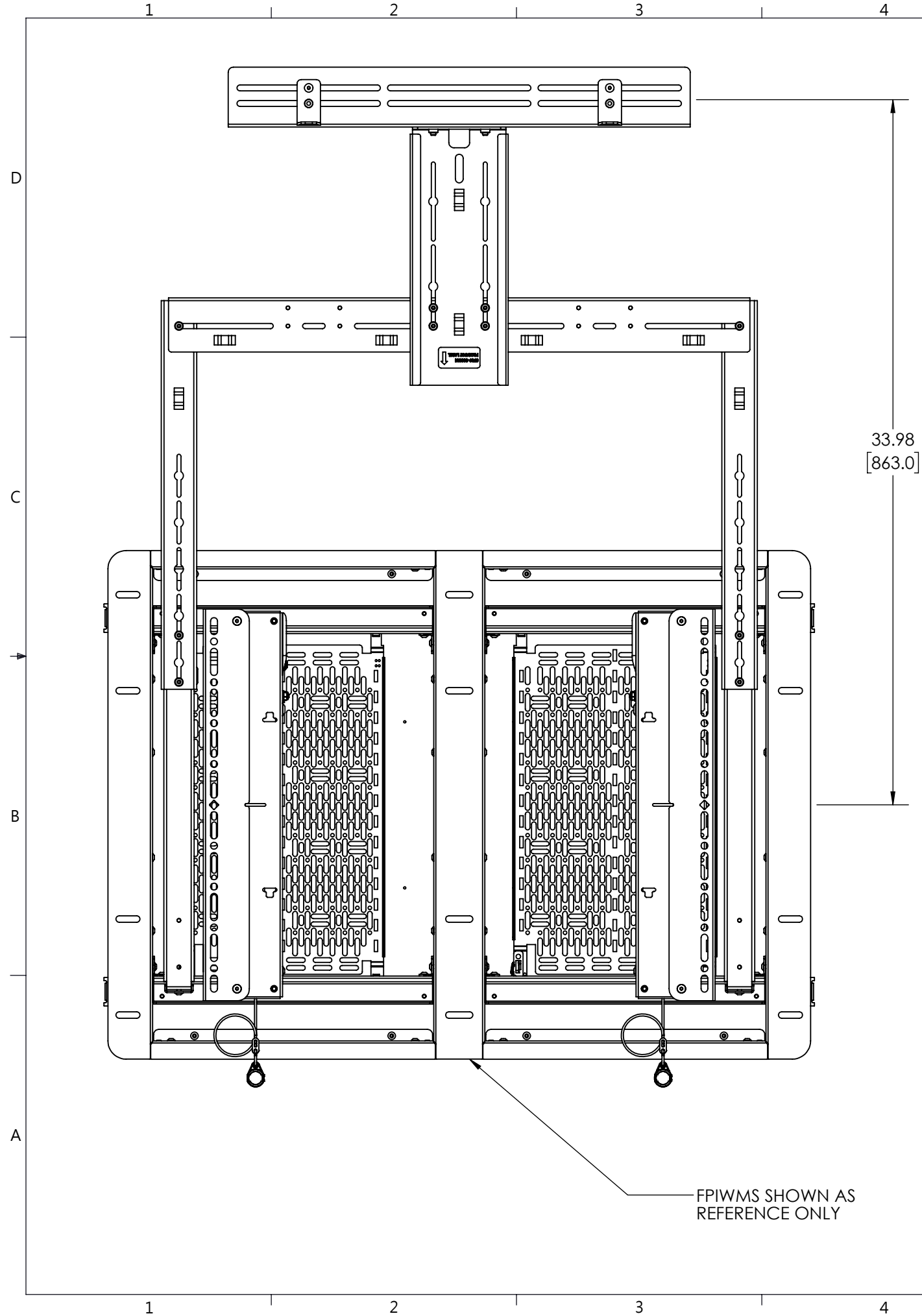

THE INFORMATION AND DESIGNS CONTAINED IN THIS DRAWING ARE CONFIDENTIAL AND THE PROPRIETARY PROPERTY OF LEGRAND | AV. NEITHER THIS DESIGN NOR ANY INFORMATION CONTAINED IN THIS DRAWING MAY BE REPRODUCED OR DISCLOSED TO OTHERS WITHOUT THE EXPRESS WRITTEN CONSENT OF LEGRAND | AV.

CAD GENERATED DRAWING, DO NOT MANUALLY UPDATE.			
DRAWN BY	NC	10/10/2023	
ENG APPROVAL			
MFG APPROVAL			
QA APPROVAL			
SHEET 3 OF 3		SCALE	1:6
		SIZE	B
		DWG. NO.	TECH-001288
		REV.	00

CHIEF
6436 CITY WEST PKWY
EDEN PRAIRIE MN, 55344
PHONE: 866-977-3901
FAX: 877-894-6918

DESCRIPTION
FPIWMA101 TECH DRAWING

MODEL NO.

FPIWMS SHOWN AS REFERENCE ONLY