

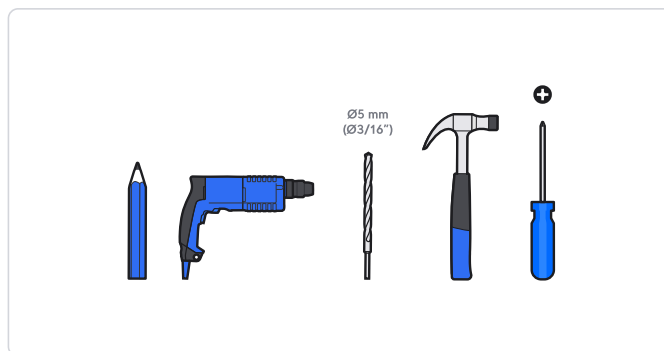

PoE+ Adapter (30W & USB-C)

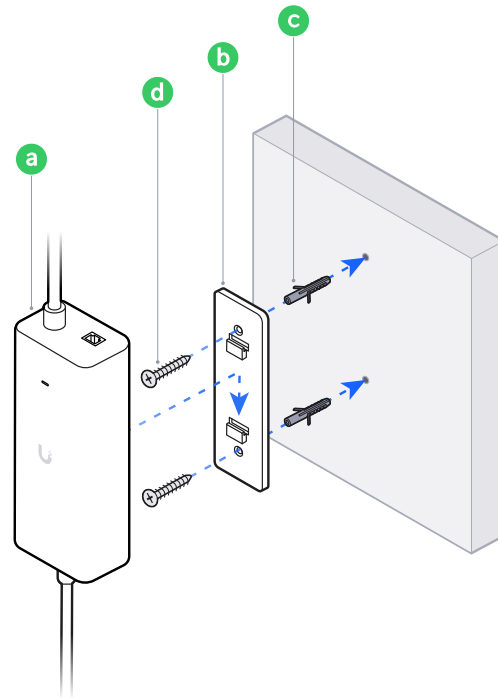

1

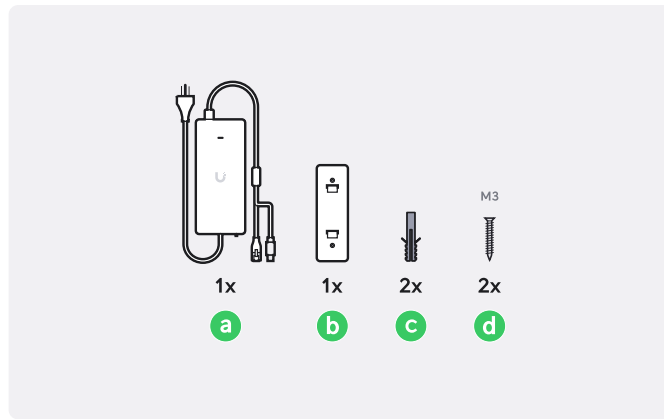
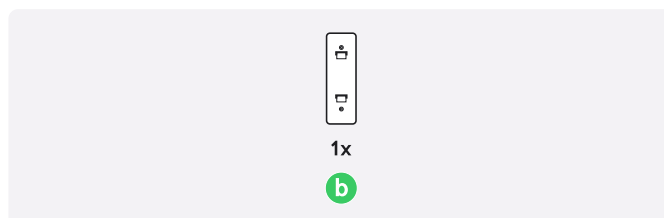

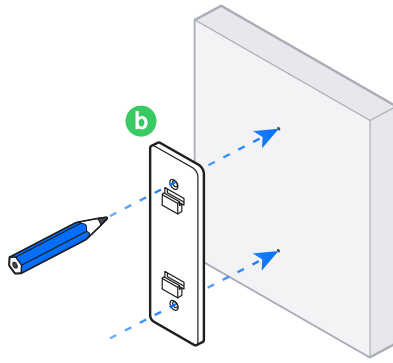

2

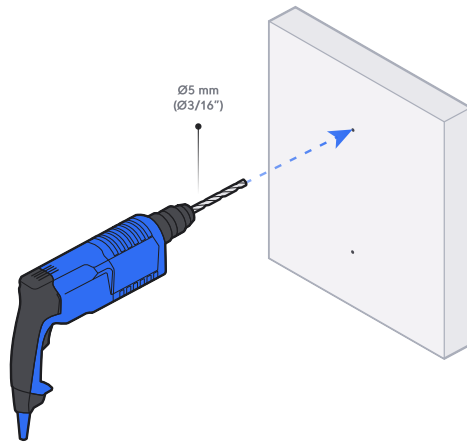

3

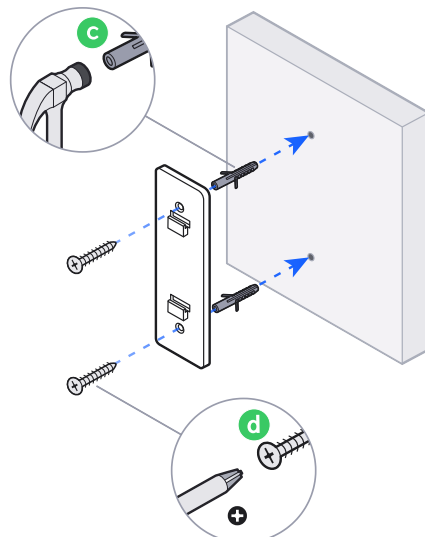
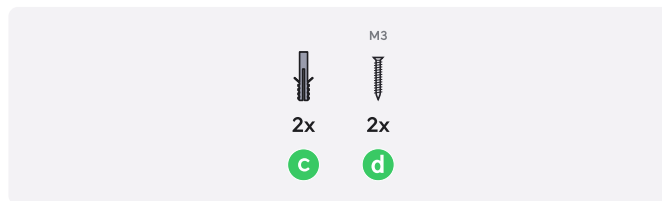

4

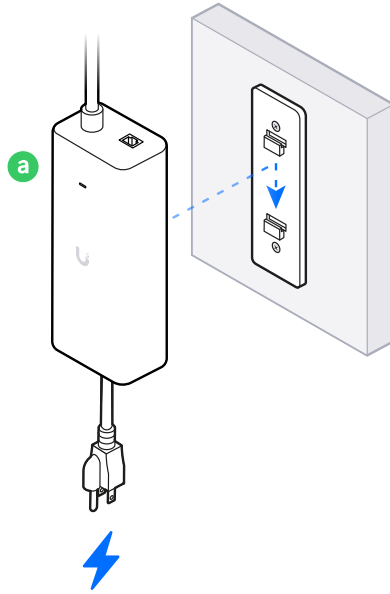
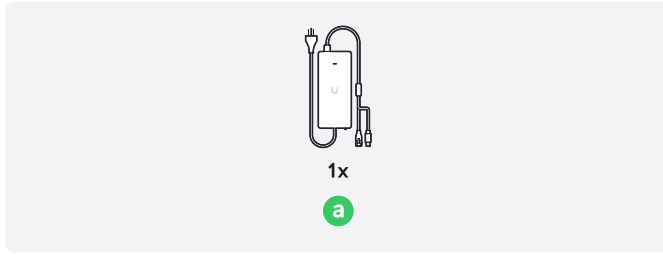

5

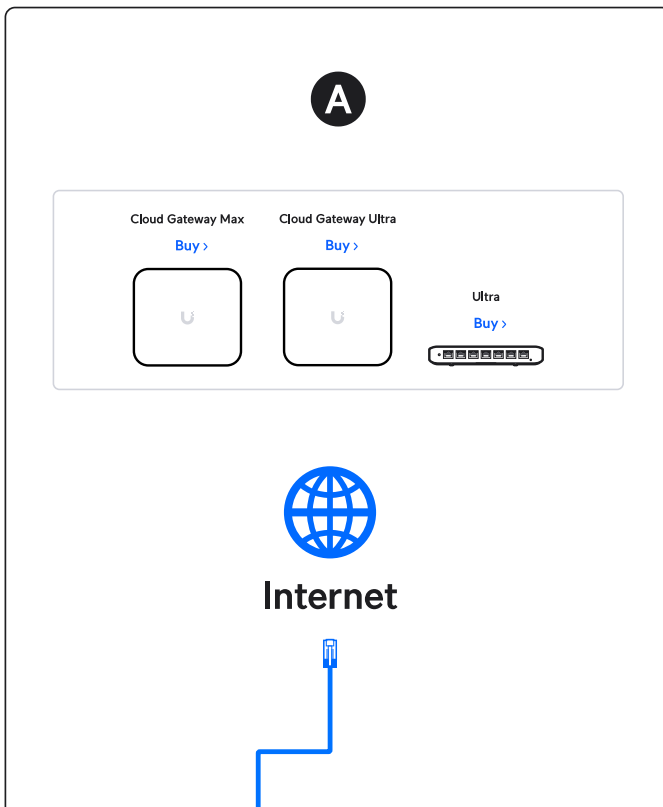

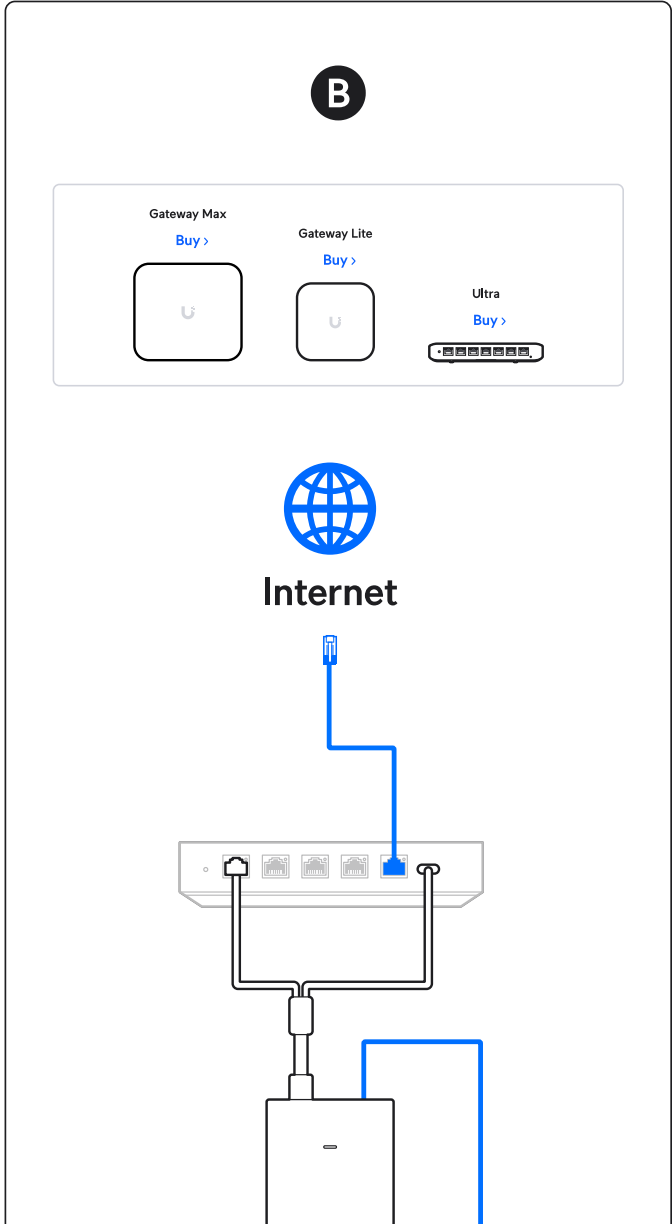
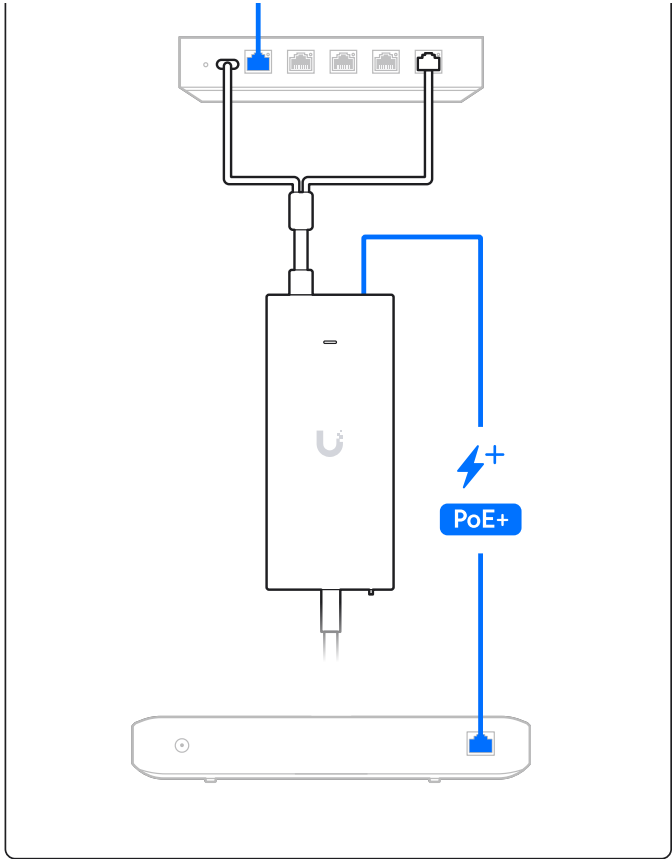

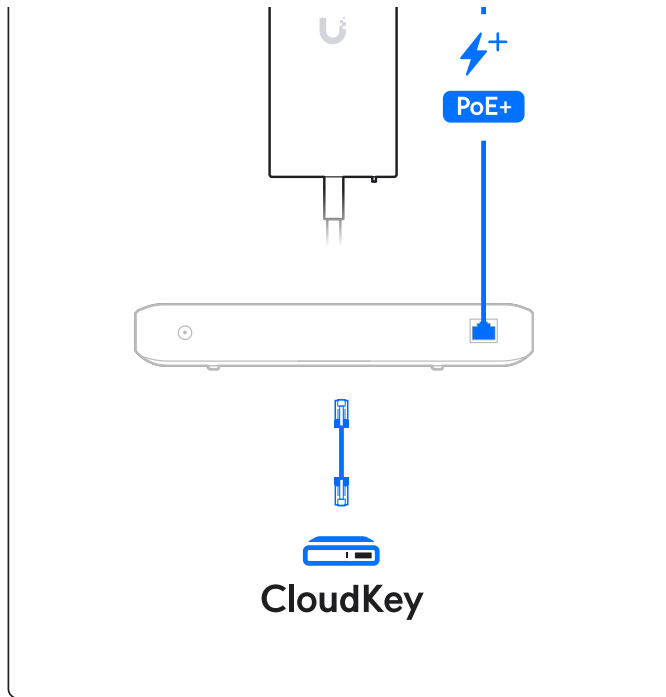

If you need further assistance, visit our [Help Center](#) or contact [Ubiquiti Support](#).