



# VERTUO POP



NESPRESSO

**CLICK AND CHOOSE YOUR LANGUAGE**

**EN**

**FR**

**DE**

**IT**

**ES**

**PT**

**CS**

**SK**

**HU**

**EL**

**PL**

**RU**

**NL**

**DA**

**NO**

**FI**

**SV**

**RO**

**TR**

**AR**

# CLICK AND CHOOSE YOUR LANGUAGE

EN



**SAFETY**



**OVERVIEW**



**CONNECTIVITY**



**FIRST STEPS**



**COFFEE PREPARATION**



**ADAPT YOUR COFFEE VOLUMES**



**CLEANING**



**DESCALING**



**EMPTYING THE SYSTEM**



**RESET TO FACTORY SETTINGS**



**BLINKING SUMMARY**



**TROUBLESHOOTING**



**SPECIFICATIONS**

## SAFETY

**CAUTION:** Before operating your coffee machine, please refer to the [safety instructions leaflet](#) to avoid possible harm and damage.

### DISPOSAL AND ENVIRONMENTAL PROTECTION

This appliance complies with the EU Directive 2012/19/EC. Packaging materials and appliance contain recyclable materials. Your appliance contains valuable materials that can be recovered or can be recycled. Separation of the remaining waste materials into different types facilitates the recycling of valuable raw materials. Leave the appliance at a collection point. You can obtain information on disposal from your local authorities.

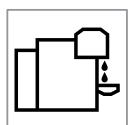

# OVERVIEW

## MACHINE OVERVIEW

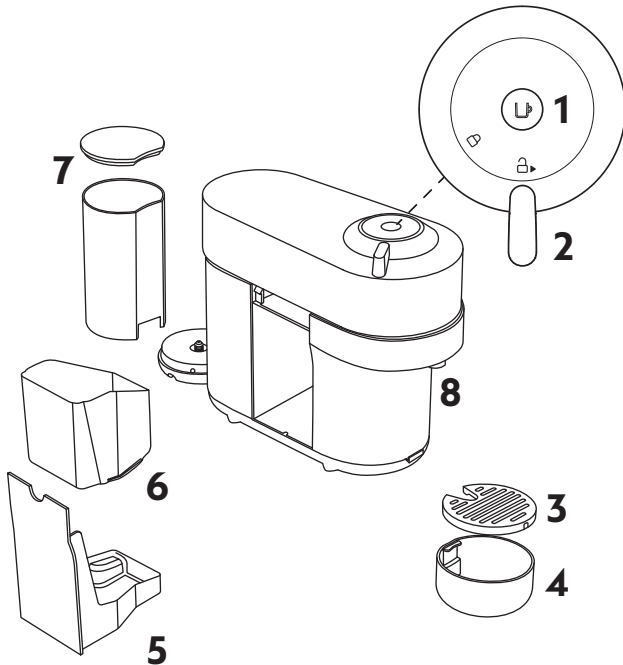

- 1 ON/OFF and Coffee Button
- 2 Locking/Unlocking Lever
- 3 Drip Grid
- 4 Adjustable Cup Support
- 5 Drip Tray
- 6 Container for used Capsules
- 7 Water Tank and Lid
- 8 Coffee Outlet

## PACKAGING CONTENT



- 1 Coffee Machine
- 2 **Nespresso** Capsules Box
- 3 **Nespresso** Welcome Material
- 4 Safety Instructions
- 5 Quick Start Guide
- 6 Warranty

**i Unboxing:** When unpacking the machine, remove the plastic film. Some dust may be present due to recycled materials being used within the packaging. This is not dangerous, simply clean with a soft tissue.

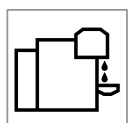



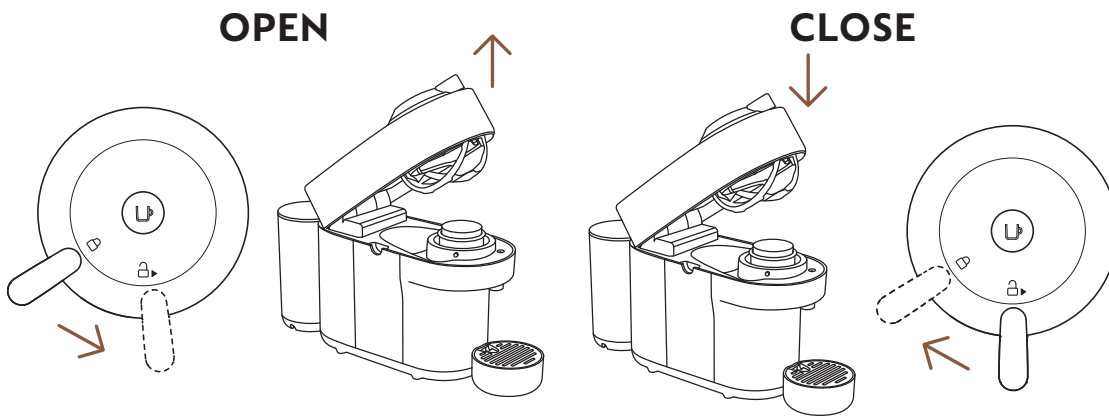

**OPEN / CLOSE**



**CAUTION:** for correct machine use, please do not open the machine head while the coffee is brewing, wait until the machine has stopped and the coffee button is steady and white. If you want to stop the brewing earlier, please press the Coffee Button once and wait until the coffee button goes back to steady white.

**THE VERTUO SYSTEM**

**CAPSULE COMPATIBILITY**

			
<b>S</b>	<b>M</b>	<b>L</b>	<b>XL</b>
<b>Ristretto</b> (25 ml / 0.84 fl oz)	<b>Double Espresso</b> (80 ml / 2.7 fl oz)	<b>Mug</b> (230 ml / 7.77 fl oz)	<b>Alto, Cold Brew Style</b> (355 ml / 12 fl oz)
<b>Espresso</b> (40 ml / 1.35 fl oz)	<b>Gran Lungo</b> (150 ml / 5.07 fl oz)		<b>Carafe</b> (535 ml / 18.8 fl oz)

**ACCESSORY COMPATIBILITY**



Accessory compatibility

**Ristretto Espresso Double Espresso Gran Lungo Mug (S) Mug (M) Reveal Glass**



Incompatible accessories



**Mug (L) Carafe**

Discover our full collection of accessories on [www.nespresso.com](http://www.nespresso.com)

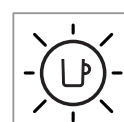
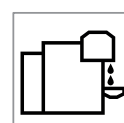
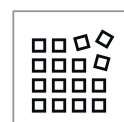
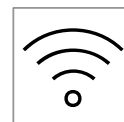

ON/OFF

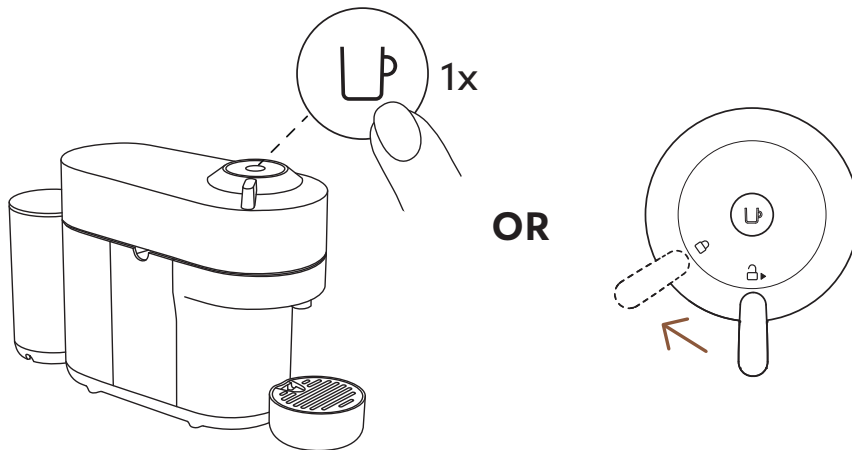

**ON**

Once the machine is plugged in, turn it on by pressing the Coffee Button once or by closing the lever into the lock position (whilst the head is closed).

**i** The light will blink for approximately 30 seconds while the machine is heating up. Once the light is steady, the machine is ready to be used.

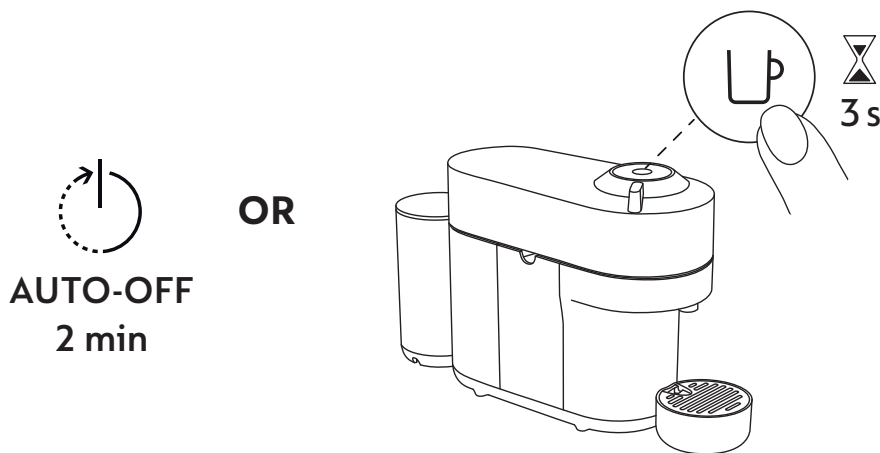

**OFF**

To save energy, the machine will turn off automatically after 2 minutes of non-use.

**i** The machine can be turned “OFF” manually at any time (when not in use) by pressing and holding the Coffee Button for 3 seconds.

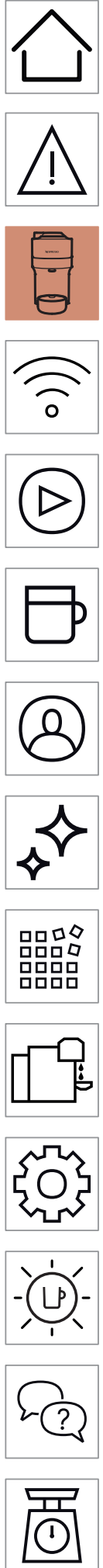

## CONNECTIVITY

### WHY SHOULD YOU PAIR YOUR VERTUO POP MACHINE?

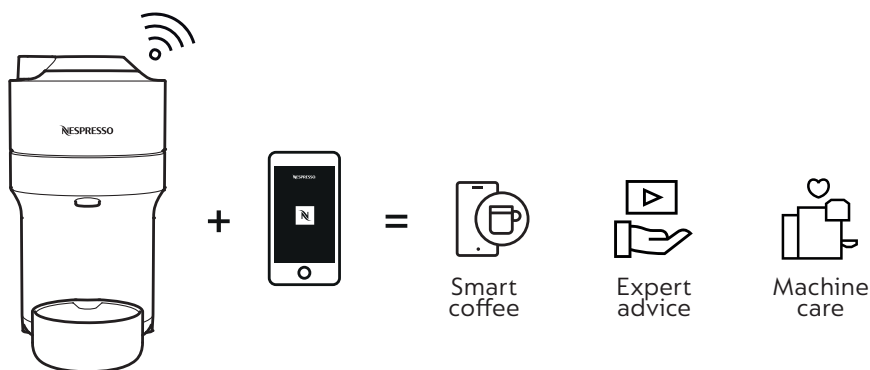

### BENEFITS OF CONNECTING YOUR VERTUO POP MACHINE

- **Smart coffee:** Always stay one step ahead and get the latest coffee innovations from **Nespresso** by keeping your machine up to date
- **Expert advice:** Get support and simple tutorial videos to accompany your coffee journey via your smartphone
- **Machine care:** Receive instant notification on how and when to service your machine with an easy-step guide on descaling, rinsing, cleaning, etc.

### HOW TO CONNECT YOUR VERTUO POP MACHINE?

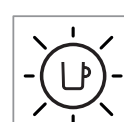
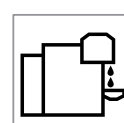
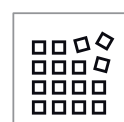





- 1 Download or update the **Nespresso** App. Launch the **Nespresso** App on your smartphone or your tablet. Press the machine icon at the top right of your screen.

**NOTE:** for optimal performance and a seamless experience, we recommend connecting your machine to a Wi-Fi router rather than using a smartphone hotspot.

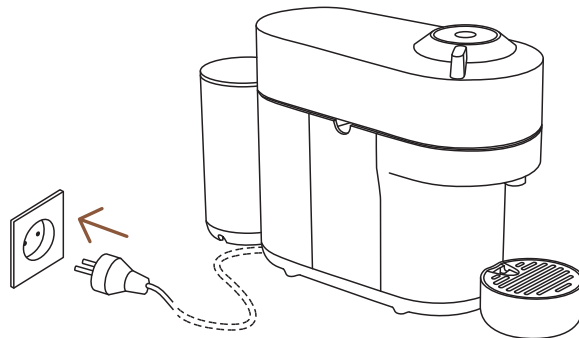

- 2 Plug in the power cord and switch on.



- 3 Follow the instructions via the **Nespresso** App.

**CAUTION:** First read the safety precautions to avoid risks of fatal electrical shock and fire. Please ensure ground continuity when plugging the machine into the power outlet.

- \* AppStore® is a trademark of Apple Inc., registered in the U.S. and other countries.
- \*\* Google Play and the Google Play logo are trademarks of Google LLC.

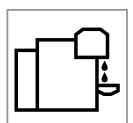
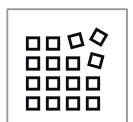

## DISABLING MACHINE BLUETOOTH AND WI-FI

The machine comes with a connectivity module, enabled by default. It gives access to additional features, enhancing your coffee experience. To disable the connectivity module, follow these steps:

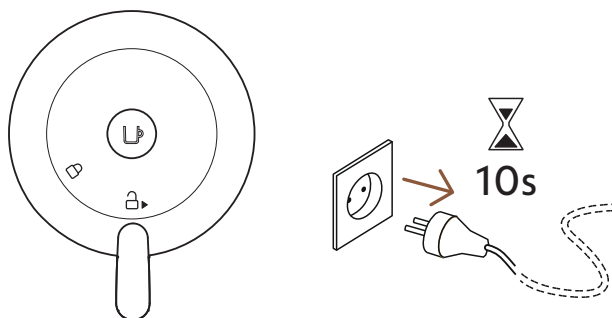

- 1 With the machine closed and the lever in **unlocked** position, unplug the machine for at least 10 seconds.

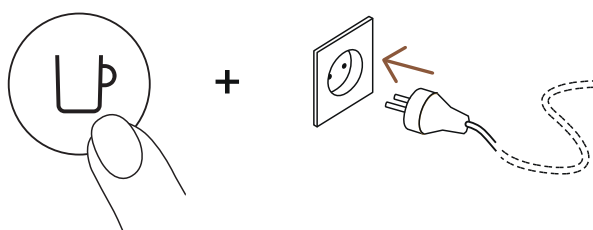

- 2 Press and hold the button whilst plugging in the machine. The button will blink orange to confirm that the connectivity module has now been disabled.

- i** Follow the same steps to set the connectivity module back on again. The button will blink white to confirm that the module has been reactivated.

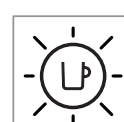
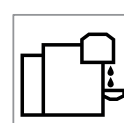
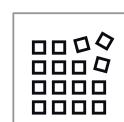

# FIRST STEPS

## FIRST RINSING

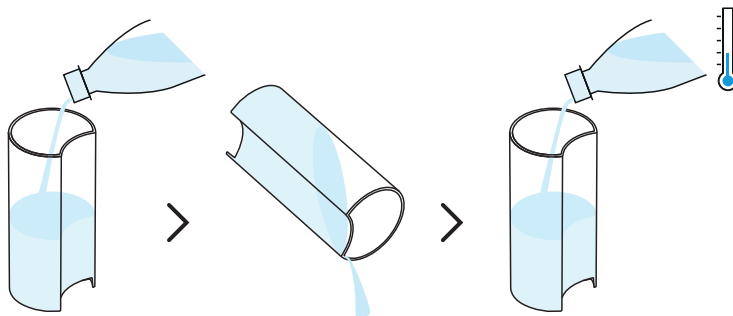

- 1** Rinse and clean the water tank and lid before filling it with fresh drinking water.

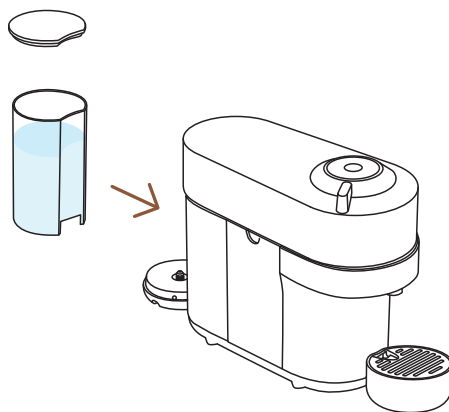

- 2** Put the lid on the water tank and put the water tank in place. Make sure it is properly attached.

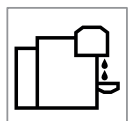
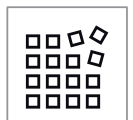

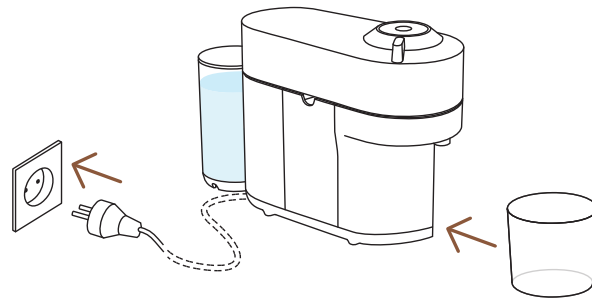

- 3** Plug the power cord in, remove the cup support and place an empty container (of at least 1 L / 34 fl oz) under the coffee outlet.

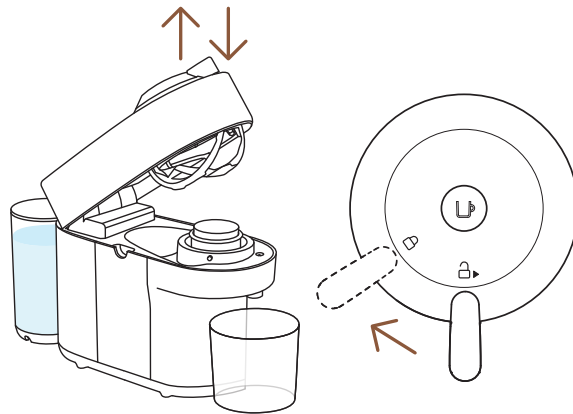

- 4** Open and close the machine. Ensure the lever is in lock position.

- i** The light will blink while the machine is heating up. It will take approximately 30 seconds. When the light becomes steady the machine is ready. Make sure that no capsule is inserted.

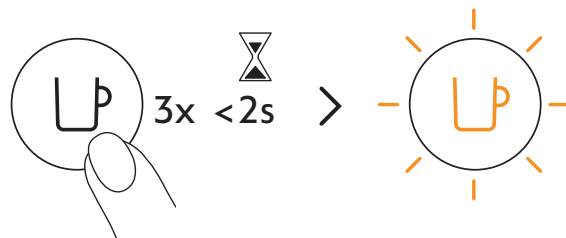

- 5** Press the button 3 times within 2 seconds to start rinsing. Let the rinsing procedure complete automatically. When the light becomes steady white, the cycle is complete.

- i** It should take less than 2 minutes before the rinsing process begins and water starts to flow. This procedure may take up to 7 minutes.

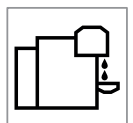

# COFFEE PREPARATION

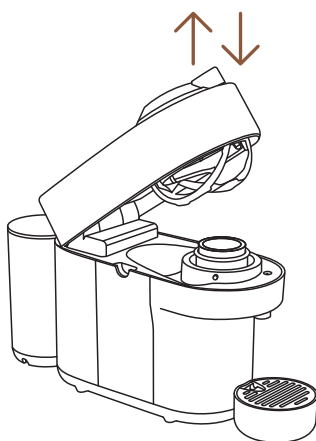

**1** Open and close the machine.

**i** The coffee button light will blink while the machine is heating up. When the light becomes steady, the machine is ready to use.

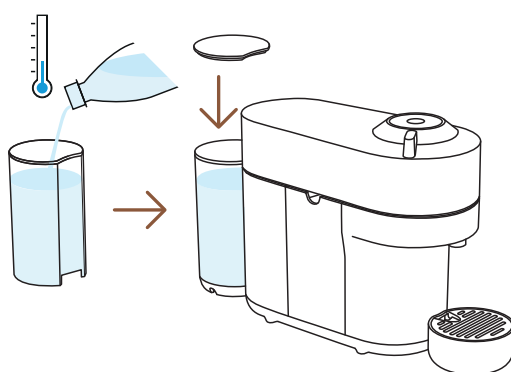

**2** Fill the water tank with fresh drinking water and put it back in position.

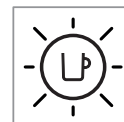
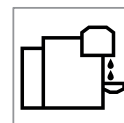
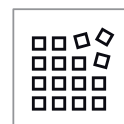
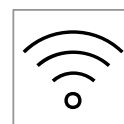

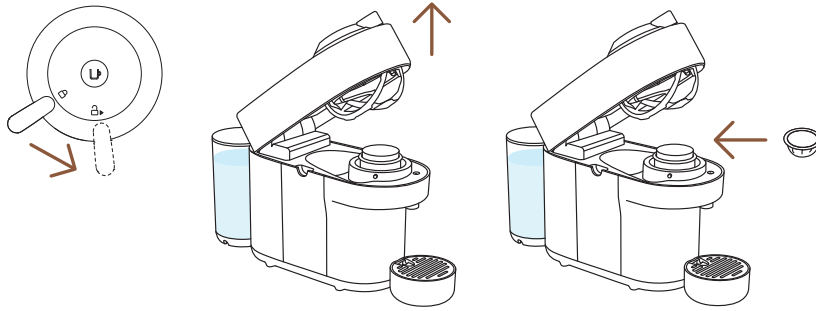

- 3** Unlock and open the machine head completely and insert a Vertuo capsule with the dome shape facing down.

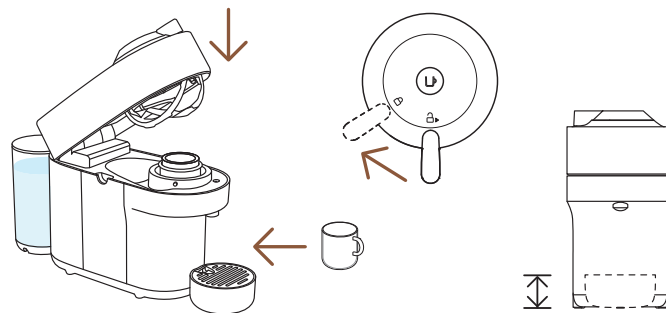

- 4** Close the machine head and lock by turning the lever left into the lock position and place a cup on the cup support. The cup support can be adjusted to accommodate your cup size.

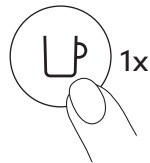

- 5** Start brewing by pressing the button once.

**CAUTION:** for correct machine use, please do not open the machine head while the coffee is brewing, wait until the machine has stopped and the coffee button is steady and white. If you want to stop the brewing earlier, please press the Coffee Button once and wait until the coffee button goes back to steady white.

- i** Due to the barcode reading, coffee pre-wetting and infusion time, it will take a moment before the coffee begins to flow. The machine will automatically recognize the inserted capsule and select the coffee preparation parameters and cup length defined by **Nespresso** coffee experts to extract the coffee blends at it's best.

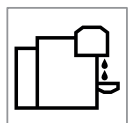

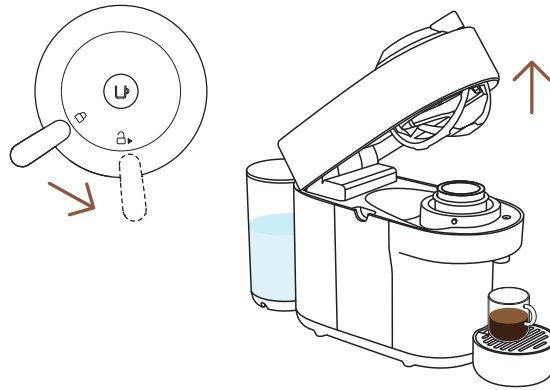

- 6** When the coffee stops brewing, open the machine head by turning the lever right towards the unlock position to automatically eject the capsule and enjoy your coffee.



- 7** Don't forget to recycle your **Nespresso** capsules.\*

\* THIS IS **NESPRESSO**. THIS IS RECYCLABLE. For more information about recycling your **Nespresso** capsules, visit [www.nespresso.com](http://www.nespresso.com)

## DISCOVER OUR COFFEE CREATIONS MODE



With this machine, **Nespresso** offers you a specific function to concentrate your coffee extractions to create your own recipes.

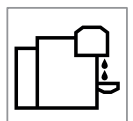
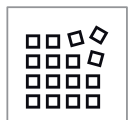

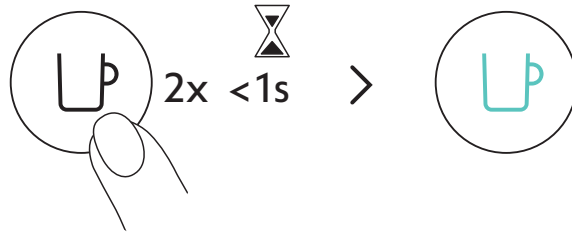

With your machine turned on and a capsule inserted and the head closed and locked, double click the coffee button. It will blink turquoise and your coffee brew will be concentrated, optimizing the coffee taste in recipes with add-ons (milk, cream, over ice...). For Incomparable Coffee Experience.

40 ml / 1.35 fl oz	80 ml / 2.7 fl oz	150 ml / 5.07 fl oz	230 ml / 7.77 fl oz	355 ml / 12 fl oz	535 ml / 18.8 fl oz
✓	✓	✓	✓	✗	✗
25 ml / 0.85 fl oz	40 ml / 1.35 fl oz	40 ml / 1.35 fl oz	80 ml / 2.7 fl oz		

To fully enjoy the benefits, we recommend brewing our Coffee+ range using only the official cup sizes. For the best in-cup results, we do not recommend brewing our XL (Alto Ambrato, Alto Onice), Cold Brew Style & Carafe Pour Over Style with this mode.

**NOTE:** An update of your machine via the **Nespresso** App may be necessary to enable this mode.



Discover how to upgrade your machine with our Aeroccino range on [www.nespresso.com](http://www.nespresso.com)

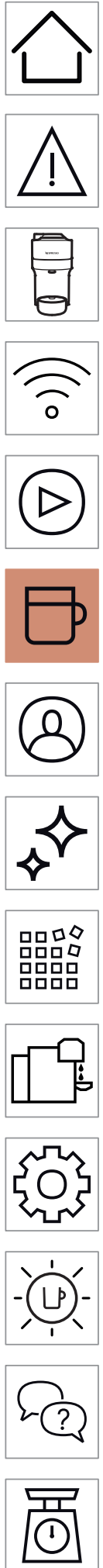



## ADAPT YOUR COFFEE VOLUMES

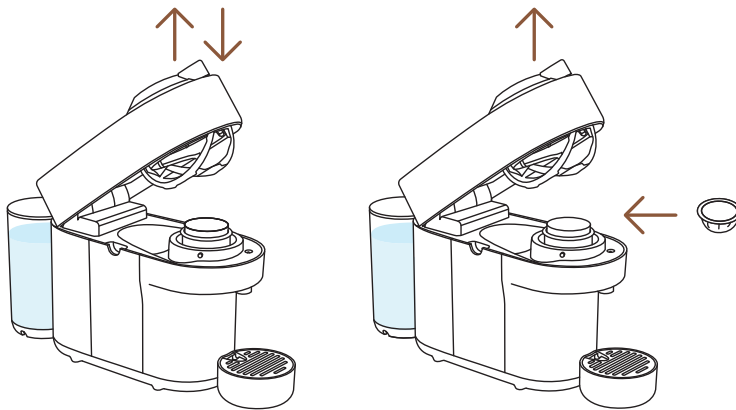

- 1** Open the machine and insert the capsule you want to program.

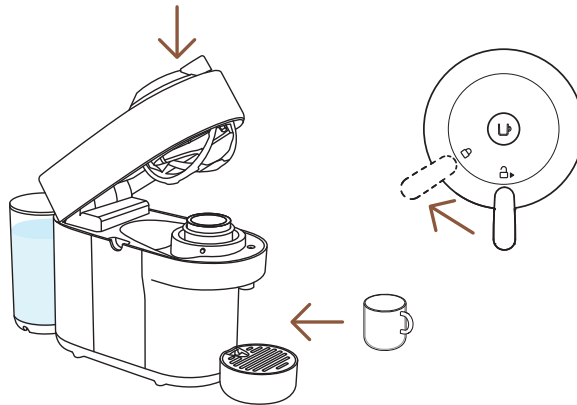

- 2** Close the machine head, turn the lever left towards the lock position and place a cup on the cup support.

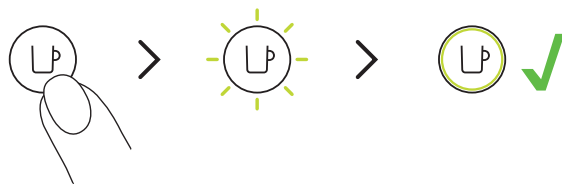

- 3** Press and hold the button, letting go a few seconds before the desired volume is reached. The new water volume is now programmed for the capsule type used during the setting.

- i** The programming is specific to each capsule type. Cup sizes may be programmed from 20 ml / 0.7 fl oz to 535 ml / 18 fl oz.

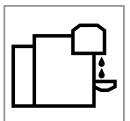

**CAUTION:** for correct machine use, please do not open the machine head while the coffee is brewing, wait until the machine has stopped and the coffee button is steady and white. If you want to stop the brewing earlier, please press the Coffee Button once and wait until the coffee button goes back to steady white.

**NOTE:** Once a customer-specific volume is programmed by the user, every time that capsule type is inserted in the machine, the preparation will stop at the user-programmed cup size. If you wish to come back to the default parameters see the paragraph “Reset to factory settings”.

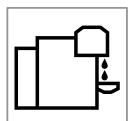

## CLEANING

Clean your machine on a monthly basis, when you start having coffee residue inside the machine head or after a long period of non-use.

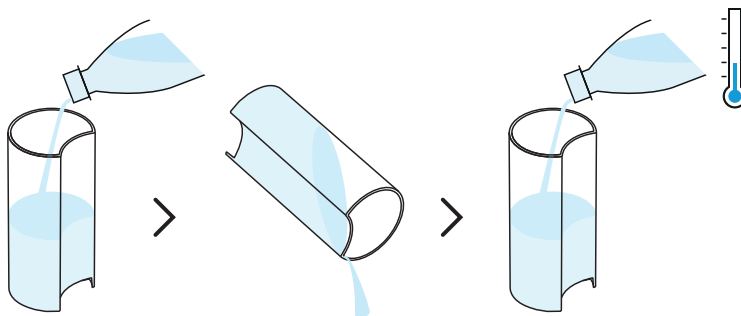

- 1** Rinse and clean the water tank and the lid before filling it with fresh drinking water.

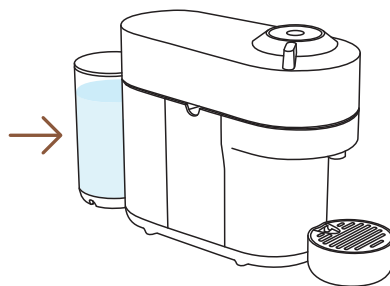

- 2** Put the water tank back in position on the machine.

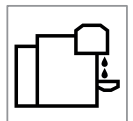
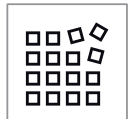

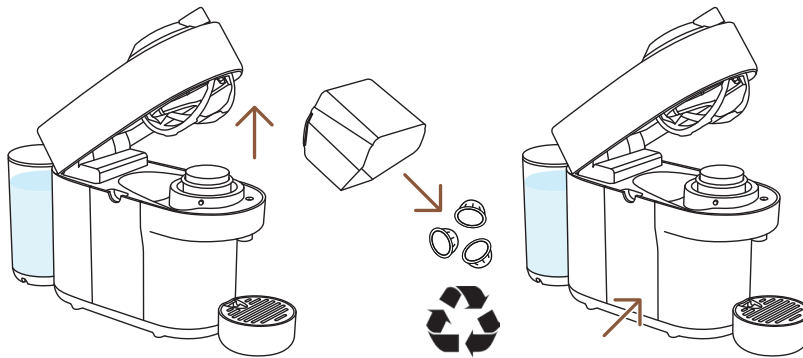

- 3** Unlock and open the machine and eject your used capsule\*. Empty and rinse the capsule container and the drip tray and put them back in place.

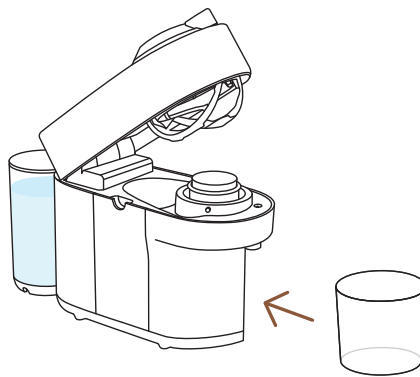

- 4** Remove the cup support and place an empty container (of at least 1 L / 34 fl oz) under the coffee outlet.

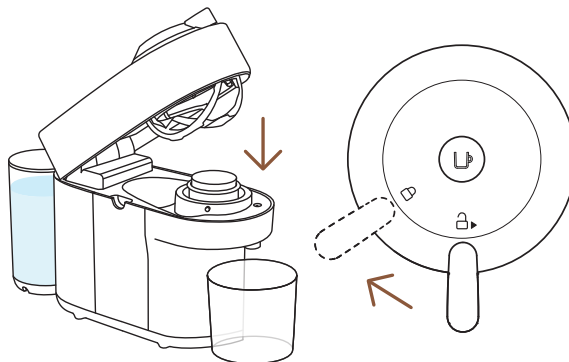

- 5** Close the machine head and turn the lever left towards lock position. Make sure no capsules are present in the machine before starting the cleaning procedure.

\* THIS IS **NESPRESSO**. THIS IS RECYCLABLE. For more information about recycling your **Nespresso** capsules, visit [www.nespresso.com](http://www.nespresso.com)

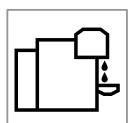

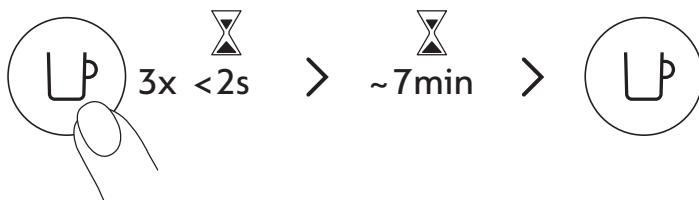

**6** Press the button 3 times within 2 seconds to start rinsing. Let the cleaning procedure complete automatically.

**i** It should take less than 2 minutes before the cleaning process begins and water starts to flow. This operation may take up to 7 minutes and will stop automatically when the cycle is complete. The procedure can be stopped at any time by pressing the button.

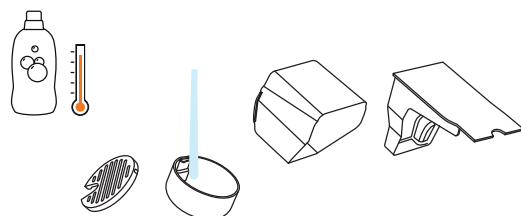

**7** Wash the capsule container, the cup support and the drip tray with hot water and mild odourless detergent.

**CAUTION:** Do not use any strong or abrasive cleaning agent or solvent cleaner. Do not put the machine in a dishwasher. Never immerse the appliance or part of it in water.

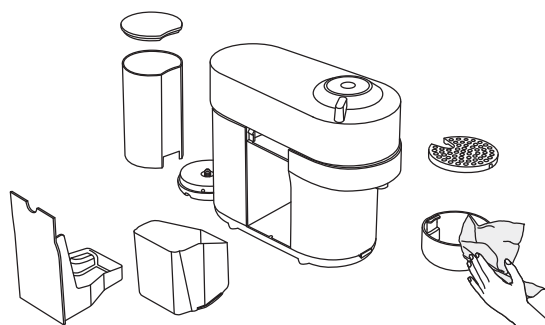

**8** Dry the machine with a clean and fresh towel.

**CAUTION:** Clean the coffee outlet regularly with a clean damp cloth. Always use soft cloths to clean the machine.

**NOTE:** Water may accumulate inside the machine's head during cleaning. If this happens, please dry visible parts with a clean dry cloth.

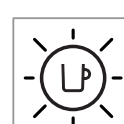
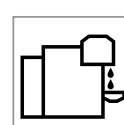
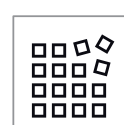
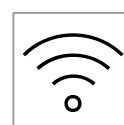

## DESCALING

Descaling your machine will ensure that it functions properly throughout its lifetime and will make your coffee experience as incomparable as it was the first day. Your machine will indicate when descaling is needed by blinking orange 3 times before steady white.



**i** The descaling procedure takes ~20 minutes and **cannot be interrupted**.

**NOTE:** Please carefully read the descaling instructions before starting.

### You will need:

- A descaling kit available on [www.nespresso.com](http://www.nespresso.com)
- An empty container (of 1 L / 34 fl oz)

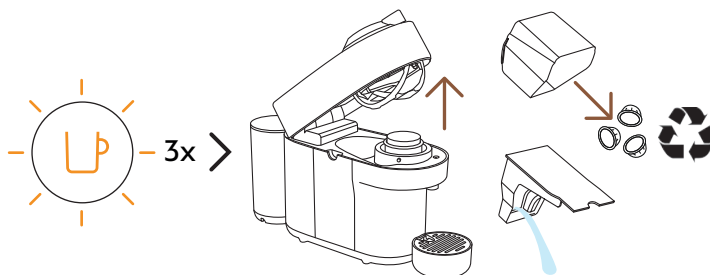

**1** With the button blinking orange 3 times: Unlock and open the machine head to eject any used capsule\*. Empty the capsule container and drip tray and put them back into position on the machine.

\* THIS IS **NESPRESSO**. THIS IS RECYCLABLE. For more information about recycling your **Nespresso** capsules, visit [www.nespresso.com](http://www.nespresso.com)

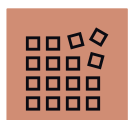

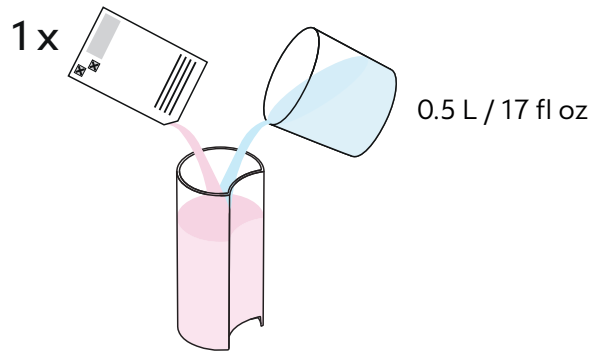

- 2** Fill the water tank with 0.5 L / 17 fl oz of water and add 1 unit of **Nespresso** descaling liquid.

**CAUTION:** Please note that the descaling solution can be harmful. Avoid contact with eyes, skin and surfaces.

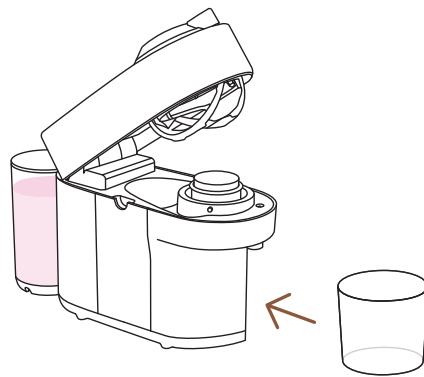

- 3** Remove the cup support and place an empty container (of at least 1 L / fl 34 oz) under the coffee outlet.

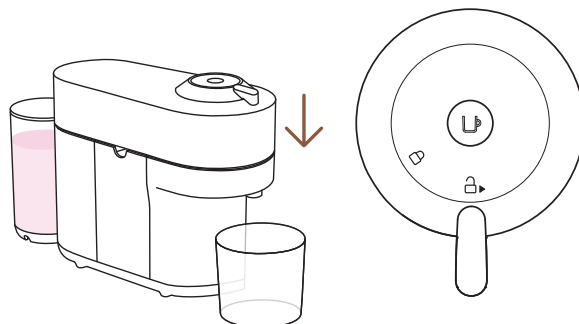

- 4** With the machine on, close the machine head and leave the lever in the unlock position.

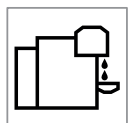
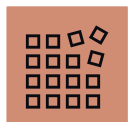

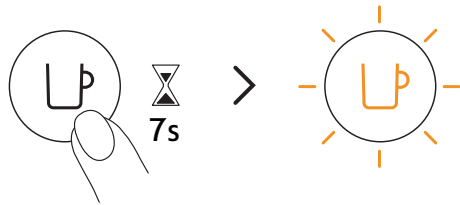

- 5** Hold the button for at least 7 seconds or until you see the light turn off. The button will start blinking orange rapidly.

**CAUTION:** You now have 45 seconds to enter the descaling mode, otherwise the machine will return to the brewing mode.

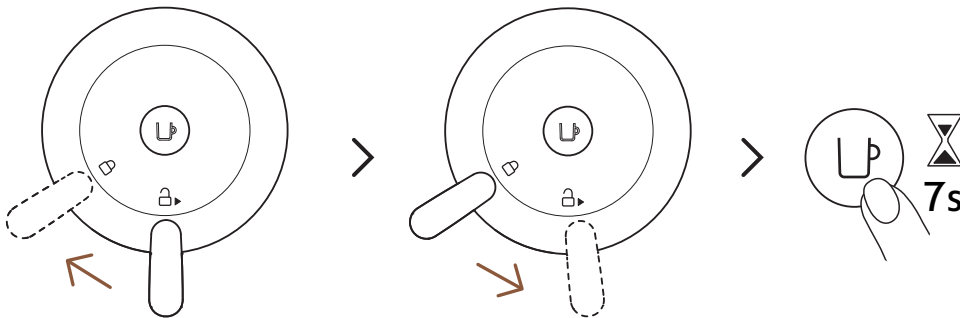

- 6** Lock the machine head by turning the lever left until the lock symbol and then unlock the lever by turning right to the unlock position. Press and hold the button again for approximately 7 seconds or until the light turns off. The button will start blinking orange rapidly.

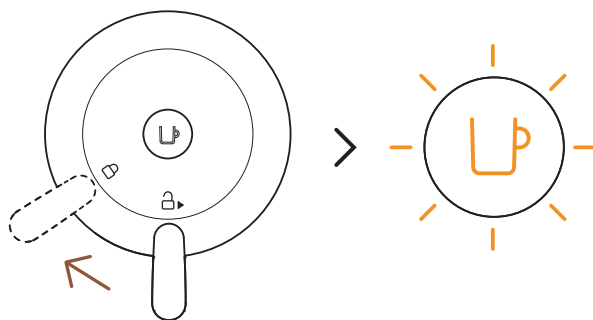

- 7** To enter the descaling mode, lock the machine by turning the lever left towards the lock position. The light should still be blinking orange quickly. This is an indication that you have entered descaling mode.

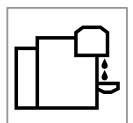
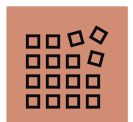



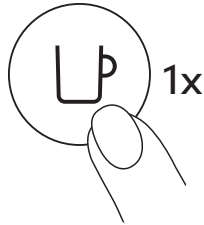

- 8** Press the coffee button once to begin the descaling process. The light will continuously blink orange throughout the process.

- i** The machine will stop automatically when the first phase of descaling is completed.

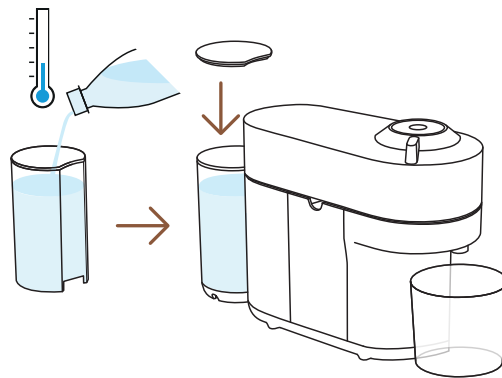

- 9** At the end of the descaling process, it is time to rinse the machine. Rinse the water tank and drip tray thoroughly. Fill the water tank with fresh drinking water and put it back in place. Empty the container and place it back under the coffee outlet.

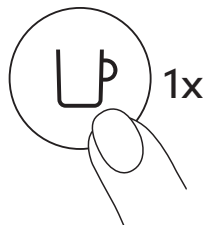

- 10** Press the button to rinse the machine. When the button stops blinking rapidly and becomes steady, the descaling procedure is completed.

- i** The machine will stop automatically when the procedure is completed.



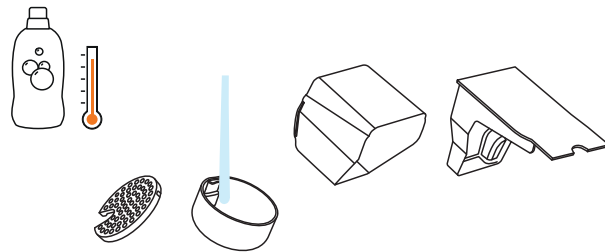

- 11** Wash the capsule container, the cup support and the drip tray with hot water and mild odourless detergent.

**CAUTION:** Do not use any strong or abrasive cleaning agent or solvent cleaner. Do not put the machine in a dishwasher. Never immerse the appliance or part of it in water.

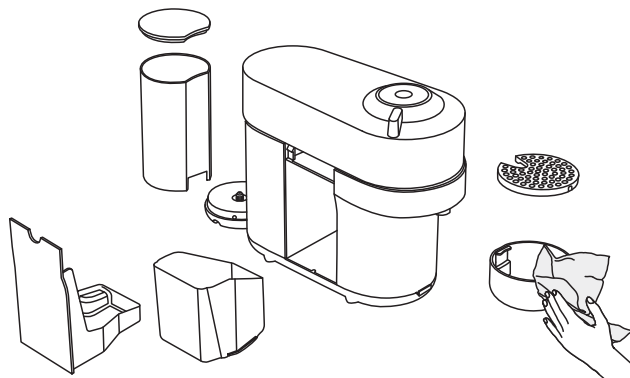

- 12** Dry the machine with a clean and fresh towel. Let the machine dry for 10 minutes before using it.

**NOTE:** Water may accumulate inside the machine's head during cleaning. If this happens, please dry visible parts with a clean dry cloth.

**NOTE:** the machine can only enter descaling mode after 30 or more coffees have been brewed.

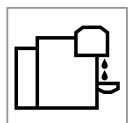
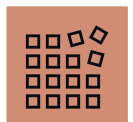

## EMPTING THE SYSTEM

Emptying the system is a process that could be done before a period of non-use, for frost protection or prior to sending the machine for a repair.

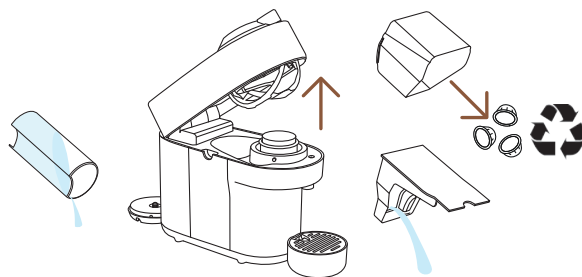

- 1** Empty the water tank, open the machine head, and let the used capsule be ejected. Empty the capsule container and the drip tray. Don't forget to recycle your **Nespresso** capsules.\*

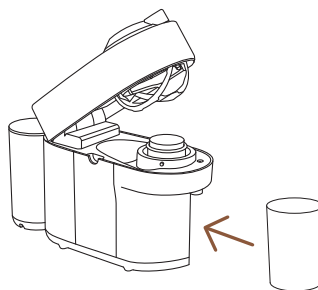

- 2** Place them back in position on the machine, remove the cup support and place an empty container (0.5 L / 17 fl oz) under the coffee outlet.

\* THIS IS **NESPRESSO**. THIS IS RECYCLABLE. For more information about recycling your **Nespresso** capsules, visit [www.nespresso.com](http://www.nespresso.com)

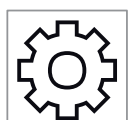

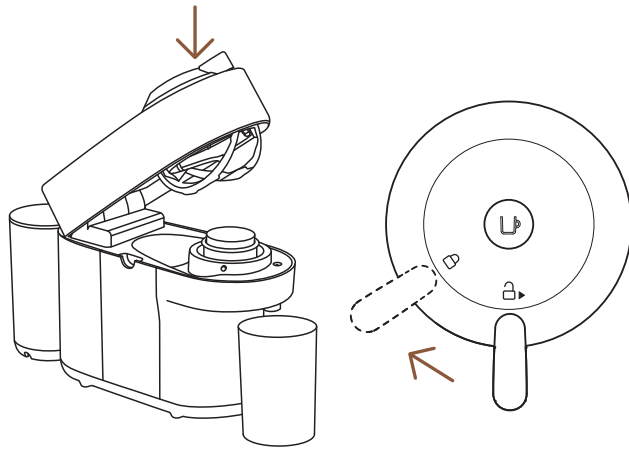

**3** With the machine plugged in, open and close the machine head and turn the lever towards the lock position.

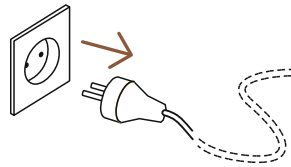

**4** Unplug the machine.

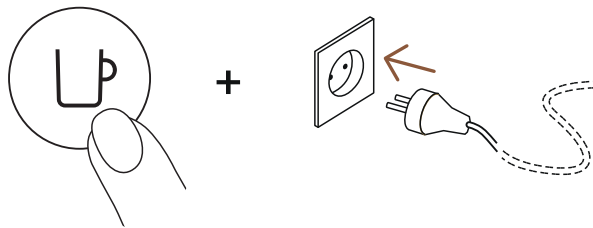

**5** Press and hold the button while plugging in the machine.



**6** Release the button. It will blink orange and the emptying process will start.

**i** It will take approximatively 30 seconds for the machine to complete the emptying process. The machine turns off automatically when it is empty.



## RESET TO FACTORY SETTINGS

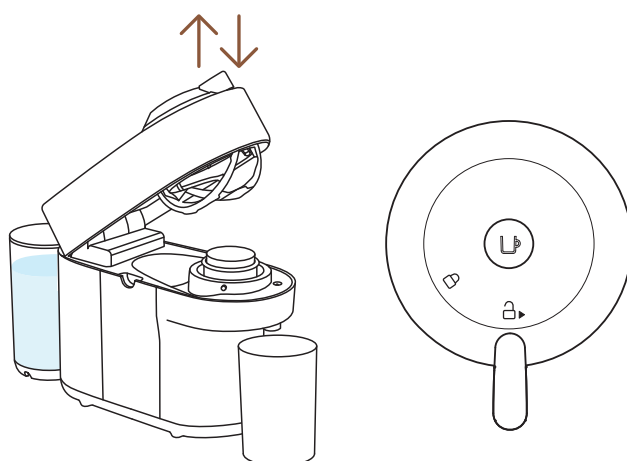

- 1 With the machine plugged in, open and then close the machine head before leaving the lever in the **unlock** position.

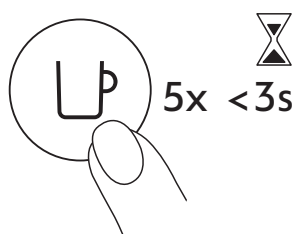

- 2 Press the button 5 times within 3 seconds. The machine is now programmed with the factory settings.

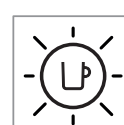
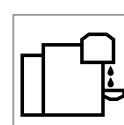
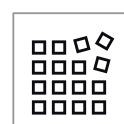
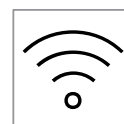

## BLINKING SUMMARY

You want to learn more about the Vertuo Pop blinkings?  
Please watch the following video:



## TROUBLESHOOTING

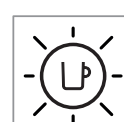
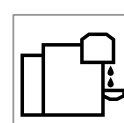
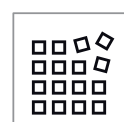
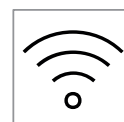

- No light on the button.**
- The machine has turned OFF automatically; press the button or “UNLOCK” the machine.
  - Check the mains, plug, voltage, and fuse.
- No coffee, no water.**
- Check that the water tank is filled.
  - Check that a fresh capsule is inserted in the correct position, that the lever is properly locked and press the button to start.
  - Descale if necessary.
  - Open the machine head and eject any used capsule that is in the machine. Then perform a clean as per the cleaning section.
- Coffee is not hot enough.**
- Preheat the cup with hot drinking water from the tap.
  - Descale if necessary.
- Leakage or unusual coffee flow.**
- Check that the water tank is well positioned.
  - Descale if necessary.
- Machine turns to “OFF mode”.**
- To save energy the machine will turn off after 2 minutes of non-use.
  - The machine can be turned “OFF” manually at any time (when not in use) by pressing and holding the button for 3 seconds.
- Coffee grounds in the cup.**
- Perform the cleaning procedure twice.
  - See paragraph on **“Cleaning”**.
- The machine doesn't start and has light steady on. If blinking, see next points.**
- Check that the lever is properly locked.
  - If you want to brew a Coffee or Espresso, check that a fresh capsule is inserted in the correct position, that the lever is properly locked and press the button to start.
  - If you are cleaning, descaling or emptying the system, check that no capsule is inserted then close, lock the machine and press the button to start one of these operations.
- The machine doesn't start and light blinks alternately; 1 blink and 1 pause.**
- Fill the water tank and press the button to start.
  - Check that the lever is properly locked.

### Light blinks while machine is running.

- If the coffee is flowing normally, this indicates the machine is working properly.
- If only water is flowing, the machine is executing a user request for either cleaning, descaling or emptying the system. Refer to the corresponding section in this user manual.
- Turn the machine to “OFF mode” by pressing the button for 3 seconds and then press it again to turn the machine ON. Now wait approximately 20 minutes to allow the machine to cool down after extensive use.



### Light blinks and machine is not running.

- It will take some time before the coffee flow comes out (due to code reading and pre-wetting the coffee).
- Check that a fresh capsule is inserted in the correct position, that the lever is properly locked and press the button to start.
- Fill the water tank and press the button to start.
- Turn the machine to “OFF mode” by pressing the button for 3 seconds and then press it again to turn the machine ON. Now, wait approximately 20 minutes to allow the machine to cool down after extensive use.



### Light blinks alternately 2 blinks and 1 pause continuously. Machine is not running.

- During regular Coffee/Espresso preparation:
  - 1) Unlock the lever and open the machine head to check that a fresh undamaged capsule is inserted in the correct position.
  - 2) Check that the lever is in “LOCKED” position.
  - 3) Check that the water tank is filled.
- During Descaling, Emptying and Cleaning:
  - 1) Check that the capsule is ejected.
  - 2) Check that the lever is in “LOCKED” position.
- During Programming Volume:
  - 1) Check if a capsule has been well inserted.
  - 2) Please refer to the corresponding chapter **“Adapt your coffee volume”**.

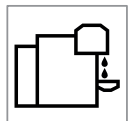
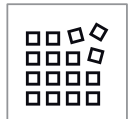



**Light alternately  
blinking 3 times and  
then steady on.**

- If the problem persists:
  - 1) Unlock the lever and open the machine head.
  - 2) Replace the capsule (if needed).
  - 3) Disconnect the power cord from the outlet and plug the machine back into the outlet after 10 seconds.
  - 4) Close the head and press the button to turn ON and press again to start brewing. If the problem persists, call **Nespresso**.
- Descaling needed: the machine can be used only a few times after the descaling alert appears before it becomes necessary.

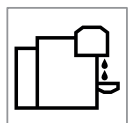

## SPECIFICATIONS

<b>Power</b>	<b>~220–240 V, 50–60 Hz, 1300–1500 W</b> <b>US, CA:</b> 120 V, 60 Hz, 1500 W <b>MX:</b> 127 V~, 60 Hz, 1380 W
<b>Frequency</b>	2.402–2.480 GHz
<b>RF output power (EIRP)</b>	Bluetooth 4 dBm Max. e.i.r.p. and Wi-Fi <20 dMm max. e.i.r.p.
<b>Standby</b>	0.39 W/h
<b>Power saving mode</b>	Auto-off after 2 min
<b>Heat-up time</b>	30 seconds (head closed and locked)
<b>Movable cup support for large recipes</b>	Removable single position
<b>Cable length from device dispatch</b>	75 cm / 30 in
<b>Dimensions (W x D x H)</b>	13.6 x 42.6 x 25 cm / 5.3 x 16.7 x 9.8 in
<b>Weight</b>	3.5 kg / 7.72 lbs
<b>Water tank capacity</b>	600 ml / 20 fl oz
<b>Capsule container capacity</b>	8 espresso or 5 mug capsules

## MACHINE CODES

<b>Nespresso</b>	<b>Breville</b>	<b>Delonghi</b>
GCV2, GDV2	BNV120, BNV150	ENV90
<b>Krups</b>	<b>Magimix</b>	
XN9201, XN9204, XN9205, XN9211	M800	

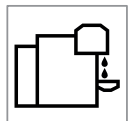
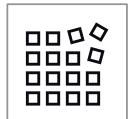

# CLIQUEZ ET CHOISISSEZ VOTRE LANGUE

FR



**CONSIGNES DE SÉCURITÉ**



**INFORMATIONS GÉNÉRALES**



**CONNECTIVITÉ**



**PREMIERS PAS**



**PRÉPARATION DU CAFÉ**



**RÉGLAGE DU VOLUME CAFÉ**



**ENTRETIEN**



**DÉTARTRAGE**



**VIDANGE DU SYSTÈME**



**RESTAUREZ LES RÉGLAGES D'USINE**



**IDENTIFICATION DES VOYANTS LUMINEUX**



**PANNES**



**CARACTÉRISTIQUES TECHNIQUES**

## CONSIGNES DE SÉCURITÉ

**ATTENTION :** Avant d'utiliser votre machine **Nespresso**, veuillez vous reporter à la [notice de sécurité](#) afin d'éviter blessure ou dommage.

## RECYCLAGE ET PROTECTION DE L'ENVIRONNEMENT

Cet appareil est conforme à la Directive de l'UE 2012/19/CE. Les matériaux d'emballage et l'appareil contiennent des matières recyclables. Votre appareil contient des matériaux valorisables qui peuvent être récupérés ou recyclés. Le tri des matériaux en différentes catégories facilite le recyclage des matières premières valorisables. Déposez l'appareil à un point de collecte. Pour obtenir des renseignements sur le recyclage, contactez les autorités locales.

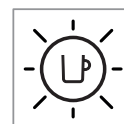
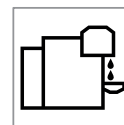
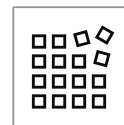
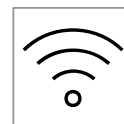

## INFORMATIONS GÉNÉRALES

### PRÉSENTATION DE LA MACHINE

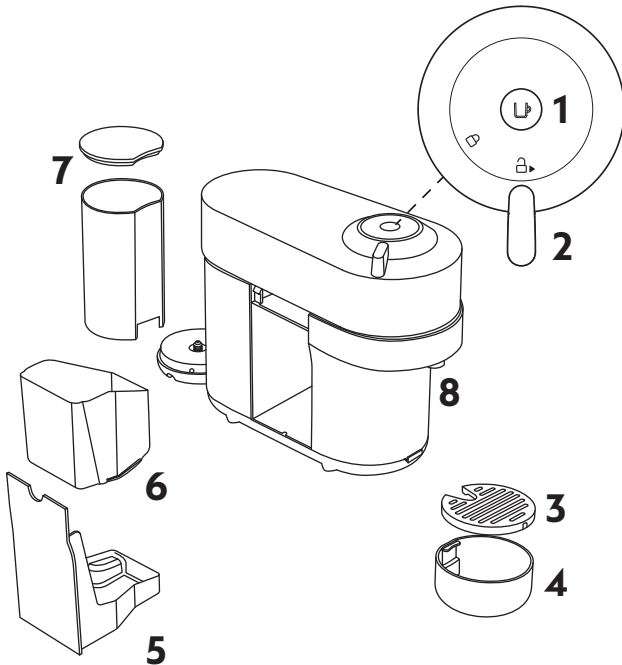

- 1 ON/OFF et touche café
- 2 Levier de verrouillage/déverrouillage
- 3 Grille d'égouttage
- 4 Support de tasse ajustable
- 5 Bac d'égouttage
- 6 Bac à capsules usagées
- 7 Réservoir d'eau et couvercle
- 8 Embout de sortie du café

### CONTENU DE L'EMBALLAGE



- 1 Machine à café
- 2 Boîte de capsules **Nespresso**
- 3 Kit de bienvenue **Nespresso**
- 4 Instructions de sécurité
- 5 Guide de démarrage rapide
- 6 Garantie

**i Déballage :** Il est possible qu'un peu de poussière soit présente sur la surface de la machine en raison des matériaux recyclés utilisés dans l'emballage. Cela n'est pas dangereux, il vous suffit de l'essuyer avec un chiffon doux.

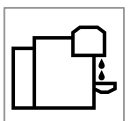
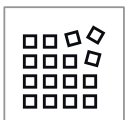

## OUVERTURE/FERMETURE

### OUVERTURE

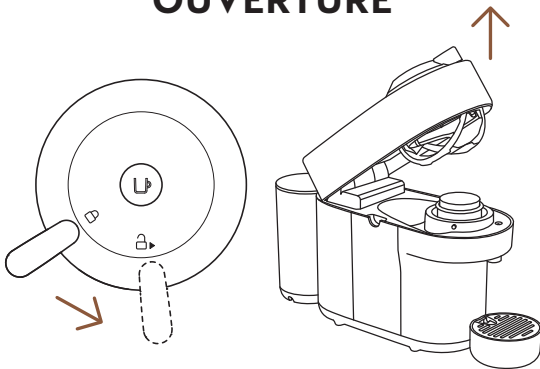

### FERMETURE

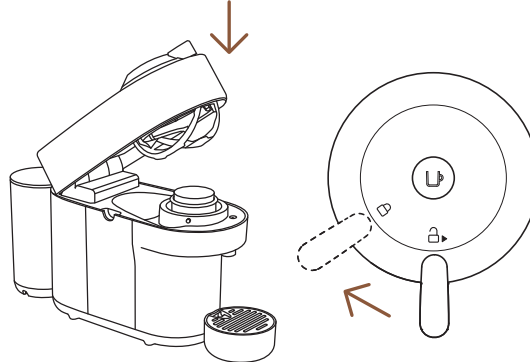

**ATTENTION :** Pour une utilisation appropriée, veuillez ne pas ouvrir la tête de la machine lorsque le café est en cours de préparation. Attendez que le voyant blanc de la touche café redevienne fixe. Si vous souhaitez interrompre la préparation avant la fin, appuyez une fois sur la touche café et attendez que le voyant blanc de la touche café redevienne fixe.

## LE SYSTÈME VERTUO

### COMPATIBILITÉ DES CAPSULES



**P**

**Ristretto**

(25 ml)

**Espresso**

(40 ml)



**M**

**Double espresso**

(80 ml)

**Gran Lungo**

(150 ml)



**G**

**Mug**

(230 ml)

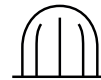

**TG**

**Alto, Cold Brew Style**

(355 ml)

**Carafe**

(535 ml)

### COMPATIBILITÉ DES ACCESSOIRES



Compati-  
bilité des  
accessoires



**Ristretto**



**Espresso**



**Double  
espresso**



**Gran  
Lungo**



**Mug (P)**



**Mug (M)**



**Verre  
Reveal**



Accessoires  
inadéquats



**Mug (G)**



**Carafe**

Découvrez notre collection complète d'accessoires sur  
[www.nespresso.com](http://www.nespresso.com)

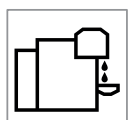

## ON/OFF

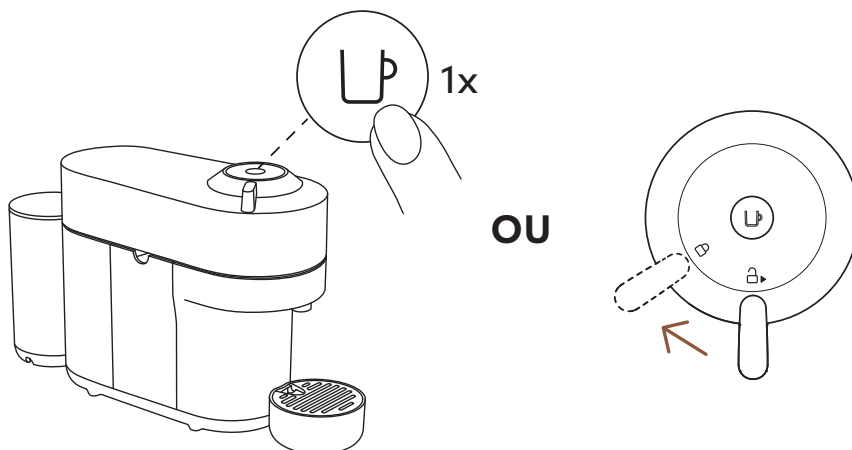
**ON**

Une fois la machine branchée, allumez-la en appuyant une fois sur la touche ou en plaçant le levier en position de verrouillage (tête de la machine fermée).

- i** Le voyant clignote pendant 30 secondes environ lorsque la machine est en phase de préchauffage. Lorsque le voyant devient fixe, la machine est opérationnelle.

**OFF**

Dans un souci d'économie d'énergie, la machine s'éteint après 2 minutes de non-utilisation.

- i** Pour éteindre la machine manuellement à tout moment (lorsqu'elle n'est pas en cours de fonctionnement), appuyez longuement sur la touche pendant 3 secondes.

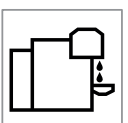

## CONNECTIVITÉ

### POURQUOI APPAIRER VOTRE MACHINE VERTUO POP ?

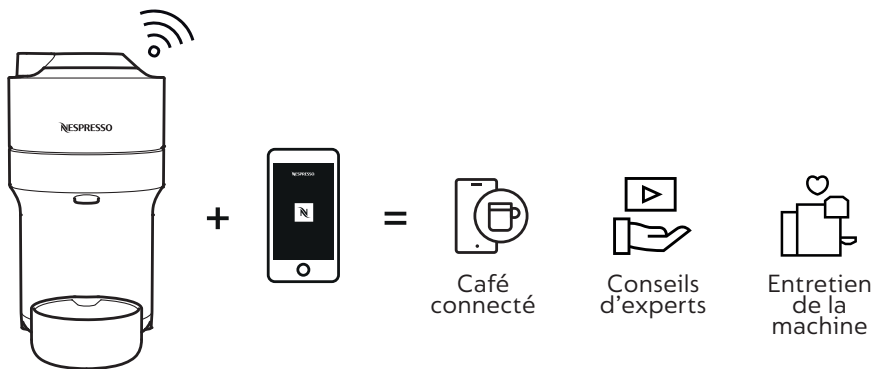

### AVANTAGES DE LA CONNEXION DE VOTRE MACHINE VERTUO POP

- **Café connecté :** Pour garder une longueur d'avance et toujours profiter des innovations proposées par **Nespresso** en matière de café, prenez soin de votre machine et veillez à la mettre à jour régulièrement.
- **Conseils d'experts :** Bénéficiez d'un service d'assistance et de tutoriels vidéo très simples sur votre smartphone tout au long de votre parcours café.
- **Entretien de la machine :** Recevez des notifications instantanées qui vous expliquent quand et comment entretenir votre machine avec un guide très simple décrivant les processus de détartrage, de rinçage, de nettoyage, etc.

### COMMENT CONNECTER VOTRE MACHINE VERTUO POP ?

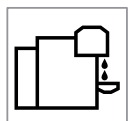
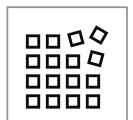





- 1** Téléchargez ou mettez à jour l'application **Nespresso**. Démarrez l'application sur votre smartphone ou votre tablette. Appuyez sur l'icône de la machine en haut à droite de votre écran.

**REMARQUE :** Pour des performances optimales et une expérience fluide, nous vous recommandons de connecter votre machine à un routeur Wi-Fi plutôt que d'utiliser une borne Wi-Fi pour smartphone.

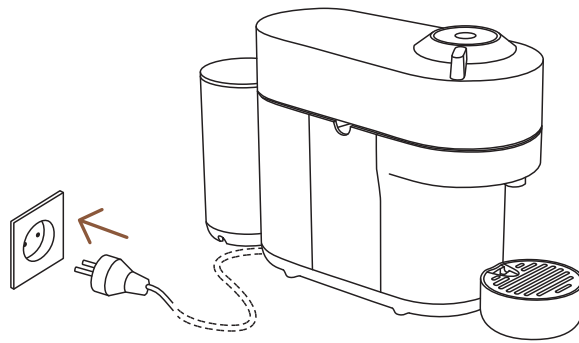

- 2** Branchez le câble d'alimentation.



- 3** Suivez les instructions affichées dans l'application **Nespresso**.

**ATTENTION :** Lisez tout d'abord les consignes de sécurité pour éviter les risques de décharge électrique mortelle et d'incendie. Veillez à la continuité de masse lorsque vous branchez la machine dans la prise d'alimentation.

\* App Store® est une marque d'Apple Inc., enregistrée aux États-Unis et dans d'autres pays.

\*\* Google Play et le logo Google Play sont des marques appartenant à Google LLC.

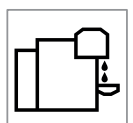

## DÉSACTIVATION DE LA CONNECTIVITÉ BLUETOOTH ET WI-FI

La machine est équipée d'un module de connectivité, activé par défaut. Il permet d'accéder à des fonctionnalités supplémentaires qui optimisent ainsi votre expérience café. Pour désactiver le module de connectivité, suivez les étapes ci-dessous :

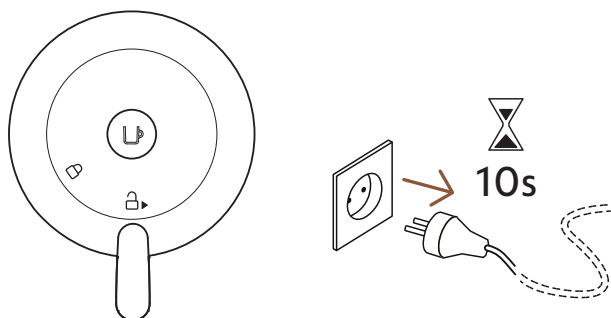

- 1 Lorsque la machine est fermée et le levier en **position de déverrouillage**, débranchez la machine pendant au moins 10 secondes.

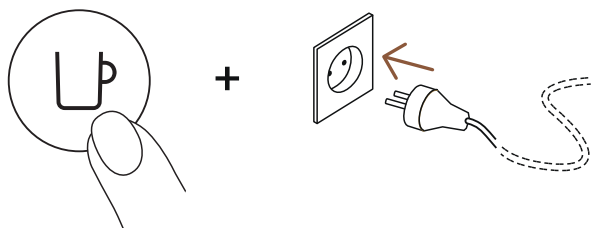

- 2 Appuyez longuement sur la touche tout en branchant la machine.  
La touche orange clignote pour confirmer que le module de connectivité est maintenant désactivé.
- i** Suivez les mêmes étapes pour réactiver le module de connectivité.  
La touche blanche clignote pour confirmer que le module est maintenant réactivé.

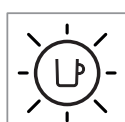
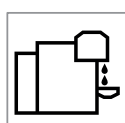
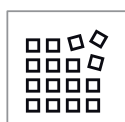

# PREMIERS PAS

## PREMIER RINÇAGE

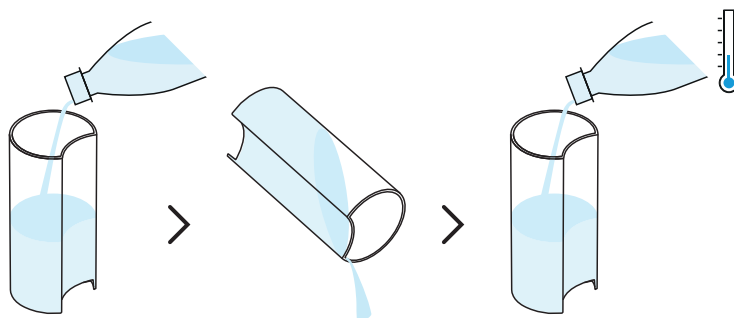

- 1** Tout d'abord, rincez et nettoyez le réservoir d'eau, ainsi que son couvercle, avant de le remplir d'eau douce et potable.

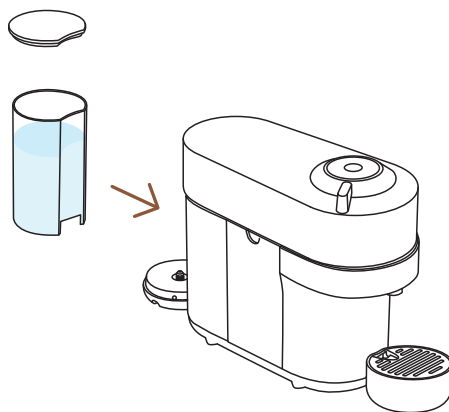

- 2** Fermez le couvercle du réservoir d'eau, remplacez ce dernier sur sa base et veillez à ce qu'il soit correctement fixé.

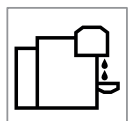
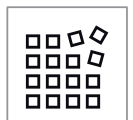

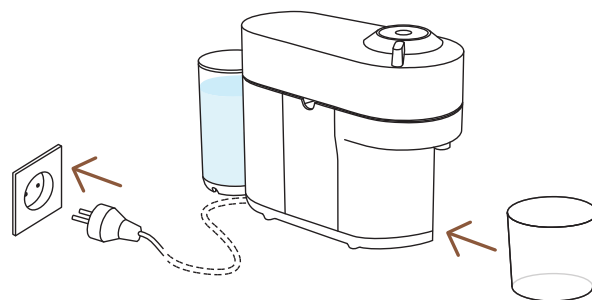

- 3** Raccordez le câble d'alimentation à la prise. Retirez le support de tasse et placez un récipient vide, de contenance suffisante (d'au moins 1 L), sous la sortie café.

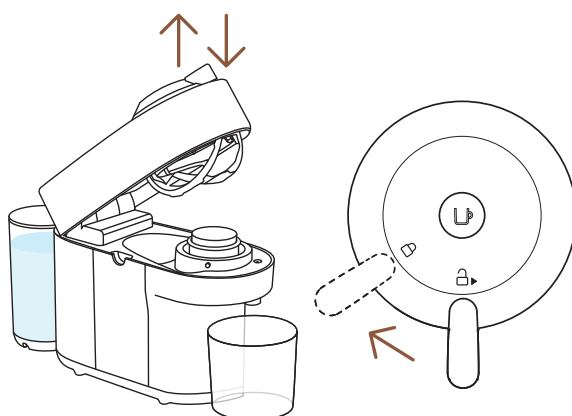

- 4** Ouvrez et fermez la machine. Assurez-vous que le levier est en position verrouillée.

- i** Le voyant clignote lorsque la machine est en phase de préchauffage. Veuillez patienter environ 30 secondes. Lorsque le voyant devient fixe, la machine est opérationnelle. Vérifiez qu'aucune capsule n'a été insérée.

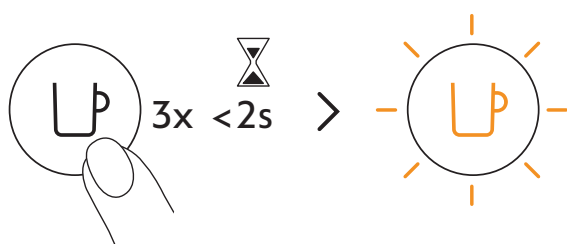

- 5** Appuyez sur la touche à 3 reprises dans un intervalle de 2 secondes pour lancer le rinçage. Lorsque le voyant orange clignote, attendez que la procédure de rinçage s'achève automatiquement. Lorsque le voyant blanc devient fixe, le cycle est terminé.

- i** Le processus de rinçage et l'écoulement de l'eau commencent généralement en moins de 2 minutes. Ce processus peut durer jusqu'à 7 minutes.

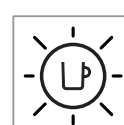
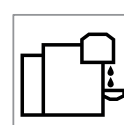
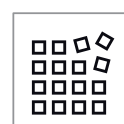
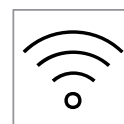

# PRÉPARATION DU CAFÉ

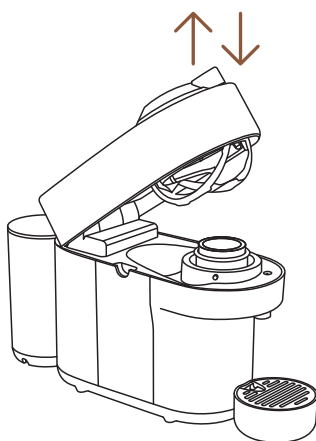

**1** Ouvrez et fermez la machine.

**i** Le voyant de la touche café clignote lorsque la machine est en phase de préchauffage. Lorsque le voyant devient fixe, la machine est opérationnelle.

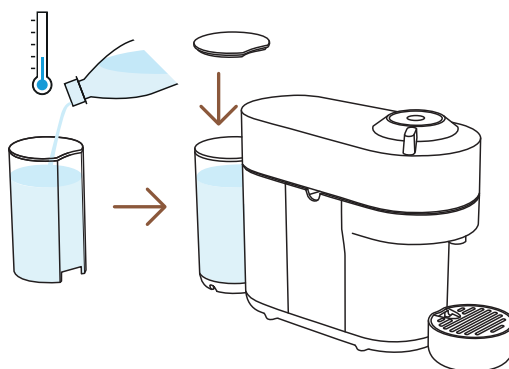

**2** Remplissez le réservoir avec de l'eau douce et potable, puis replacez-le sur sa base.

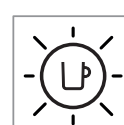
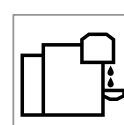
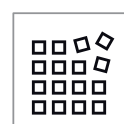
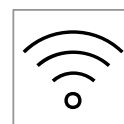

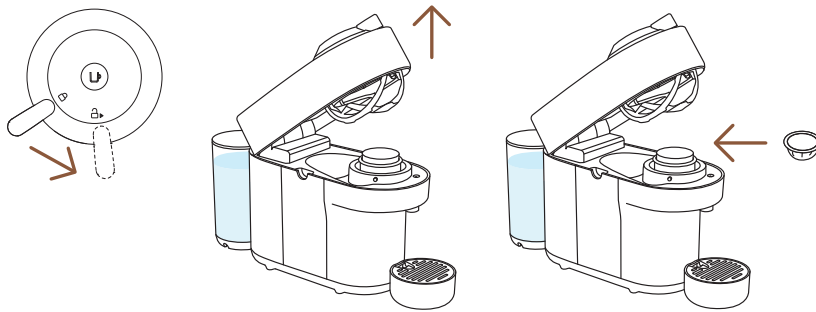

- 3** Déverrouillez la machine et ouvrez entièrement sa partie supérieure, puis insérez une capsule **Vertuo** en plaçant le côté bombé vers le bas.

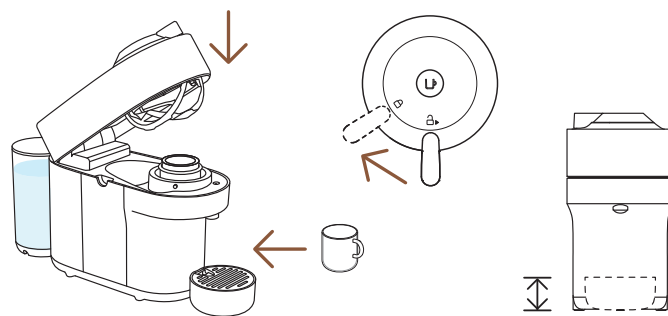

- 4** Fermez la tête de la machine et verrouillez-la en tournant le levier vers la gauche en position de verrouillage, puis placez votre tasse. Il est possible de régler le support de tasse en fonction de la longueur du café que vous voulez préparer.

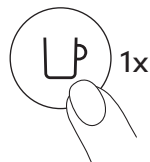

- 5** Commencez la préparation en appuyant une fois sur la touche café.

**ATTENTION :** Pour une utilisation appropriée, veuillez ne pas ouvrir la tête de la machine lorsque le café est en cours de préparation. Attendez que le voyant blanc de la touche café redevienne fixe. Si vous souhaitez interrompre la préparation avant la fin, appuyez une fois sur la touche café et attendez que le voyant blanc de la touche café redevienne fixe.

- i** En raison de la lecture du code-barres, du prémouillage du café et du temps d'infusion, le café ne peut pas s'écouler immédiatement. La machine reconnaît automatiquement la capsule insérée et choisit les paramètres de préparation et le volume d'eau prévus par les experts café de **Nespresso** afin de vous proposer le meilleur café possible.

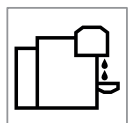

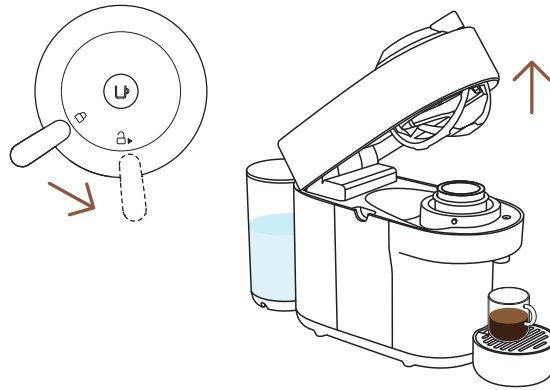

- 6** Lorsque la préparation du café s'arrête, ouvrez la tête de la machine en tournant le levier vers la droite en position de déverrouillage pour éjecter automatiquement la capsule, puis savourez votre café.



- 7** N'oubliez pas de recycler vos capsules **Nespresso**.\*

\* C'EST **NESPRESSO**. C'EST RECYCLABLE. Pour plus d'informations sur le recyclage de vos capsules **Nespresso**, visitez le site [FR : www.nespresso.com/agit](http://www.nespresso.com/agit) | [CH : www.nespresso.com](http://www.nespresso.com)

## DÉCOUVREZ NOTRE MODE CRÉATION DE RECETTES



Avec cette machine, **Nespresso** vous propose une fonction spécifique qui vous permet de concentrer les préparations de vos cafés et de créer vos propres recettes.

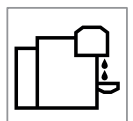
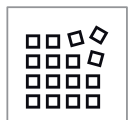

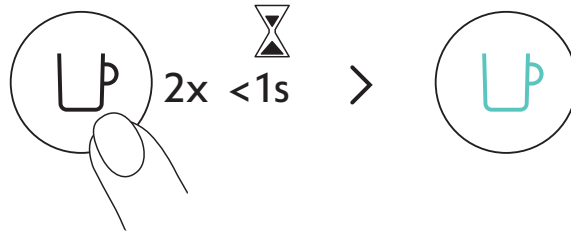

Allumez votre machine, puis appuyez deux fois sur la touche café. La touche devient turquoise, puis clignote. La préparation de votre café est plus concentrée, ce qui renforcera le goût du café lors de vos recettes agrémentées d'ingrédients supplémentaires (lait, crème, glaçons...). Pour une expérience café incomparable.

40 ml	80 ml	150 ml	230 ml	355 ml	535 ml
✓	✓	✓	✓	✗	✗
25 ml	40 ml	40 ml	80 ml		

Pour profiter pleinement des avantages, nous vous recommandons de préparer les cafés de notre gamme Coffee+ en utilisant uniquement les longueurs de tasse officielles. Pour obtenir les meilleurs résultats en tasse, nous vous déconseillons de préparer nos cafés XL (Alto Ambrato, Alto Onice), Cold Brew Style et Carafe Pour Over Style à partir de ce mode.

**REMARQUE :** Il est peut-être nécessaire de mettre à jour votre machine à partir de l'application **Nespresso** pour activer ce mode.



Découvrez comment mettre à niveau votre machine avec notre gamme Aeroccino sur [www.nespresso.com](http://www.nespresso.com)

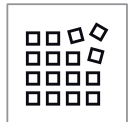



## RÉGLAGE DU VOLUME CAFÉ

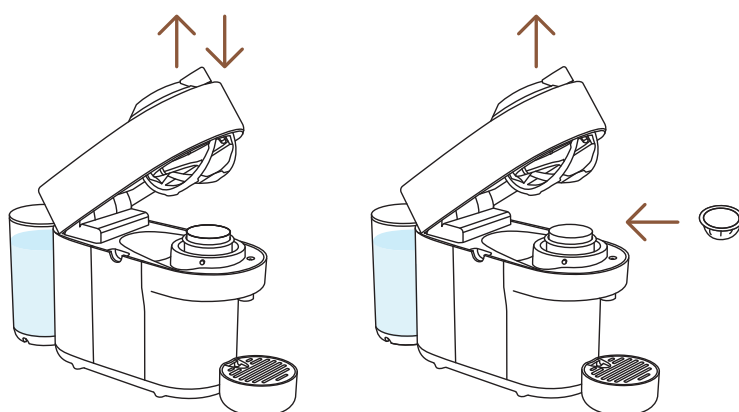

- 1 Allumez votre machine, ouvrez la machine et insérez la capsule que vous souhaitez programmer.

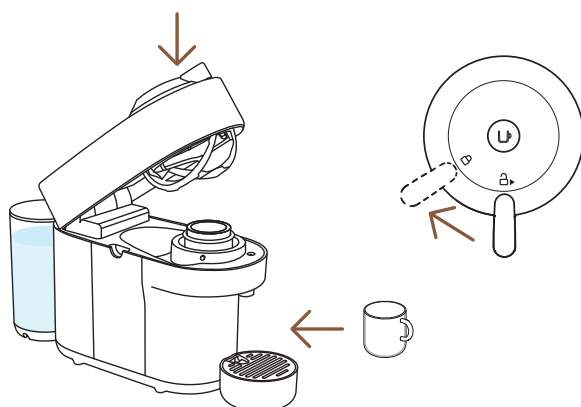

- 2 Fermez la tête de la machine, tournez le levier vers la gauche en position de verrouillage, puis placez votre tasse sur le support.

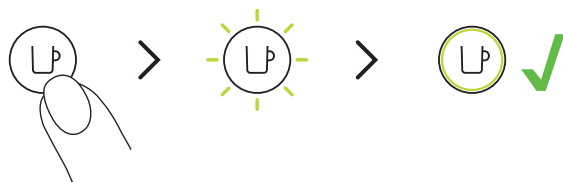

- 3 Appuyez longuement sur la touche café jusqu'à obtenir la longueur souhaitée. Le nouveau volume d'eau est maintenant programmé pour le type de capsule utilisé lors du paramétrage.

- i** La programmation est spécifique à chaque type de capsule. La longueur de tasse peut être reprogrammée de 20 ml à 535 ml.

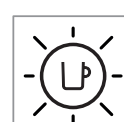
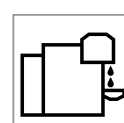
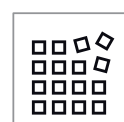
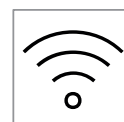

**ATTENTION :** Pour une utilisation appropriée, veuillez ne pas ouvrir la tête de la machine lorsque le café est en cours de préparation. Attendez que le voyant blanc de la touche café redevienne fixe. Si vous souhaitez interrompre la préparation avant la fin, appuyez une fois sur la touche café et attendez que le voyant blanc de la touche café redevienne fixe.

**À NOTER :** Lorsqu'un volume spécifique personnalisé est programmé par l'utilisateur pour une capsule donnée, chaque fois qu'une capsule de ce type sera insérée dans la machine, la préparation s'arrêtera au niveau de la longueur de tasse définie. Si vous souhaitez rétablir les réglages par défaut, consultez le paragraphe « Restaurer les réglages d'usine ».

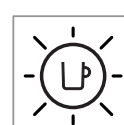
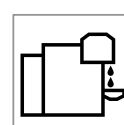
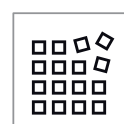
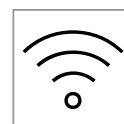

## ENTRETIEN

Nettoyez votre machine tous les mois, lorsque des résidus de café commencent à se déposer à l'intérieur de la tête de la machine ou après une longue période de non-utilisation.

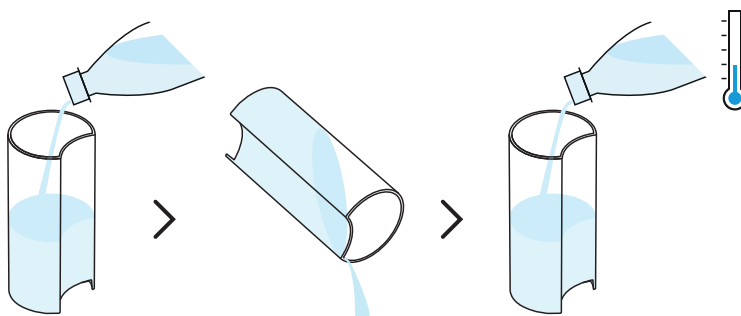

- 1** Rincez et nettoyez le réservoir d'eau et le couvercle avant de le remplir d'eau douce et potable.

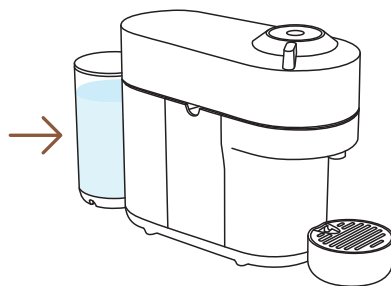

- 2** Remettez le réservoir d'eau en place sur la machine.

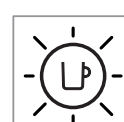
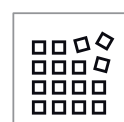
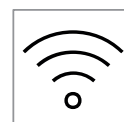

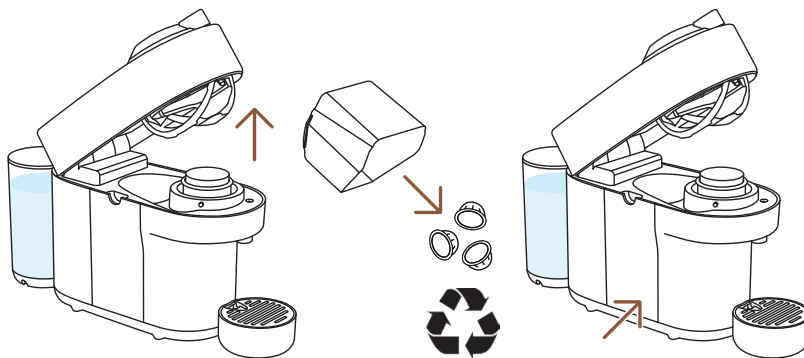

- 3** Une fois allumée, déverrouillez la machine et ouvrez-la pour éjecter automatiquement la capsule usagée. Videz et rincez le bac à capsules usagées et le bac d'égouttage, puis remettez-les en place. N'oubliez pas de recycler vos capsules **Nespresso**.\*

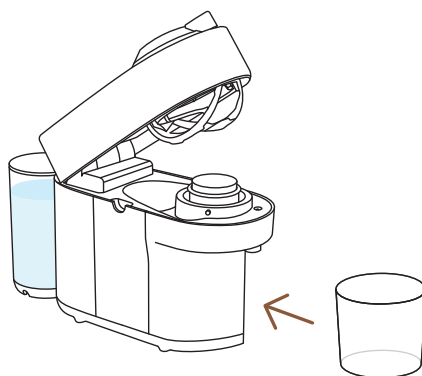

- 4** Retirez le support de tasse et placez un récipient vide (d'au moins 1 L) sous la sortie café.

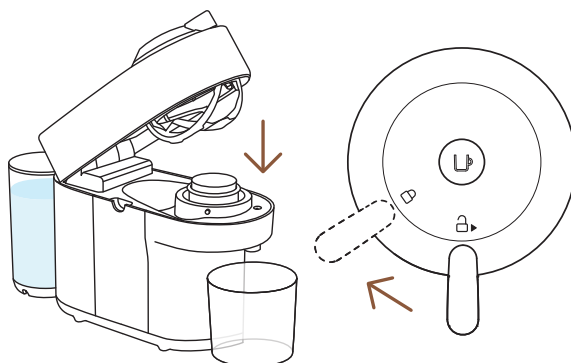

- 5** Fermez la tête de la machine et tournez le levier vers la gauche en position de verrouillage. Veillez à ce qu'aucune capsule n'ait été insérée dans la machine avant de procéder au rinçage.

\* C'EST **NESPRESSO**. C'EST RECYCLABLE. Pour plus d'informations sur le recyclage de vos capsules **Nespresso**, visitez le site [FR : www.nespresso.com/agit](http://www.nespresso.com/agit) | [CH : www.nespresso.com](http://www.nespresso.com)

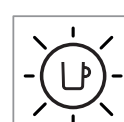
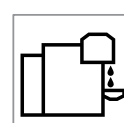
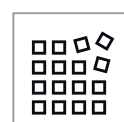
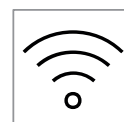

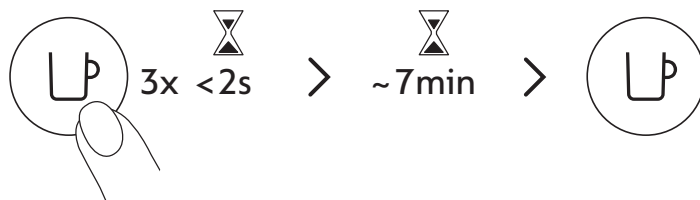

- 6** Appuyez sur la touche à 3 reprises dans un intervalle de 2 secondes pour lancer le rinçage. Lorsque le voyant orange clignote, attendez que la procédure de rinçage s'achève automatiquement.

- i** Le processus de rinçage et l'écoulement de l'eau commencent généralement en moins de 2 minutes. Cette opération peut durer jusqu'à 7 minutes et s'arrêtera automatiquement à la fin du cycle. Vous pouvez interrompre le processus à tout moment en appuyant sur la touche.

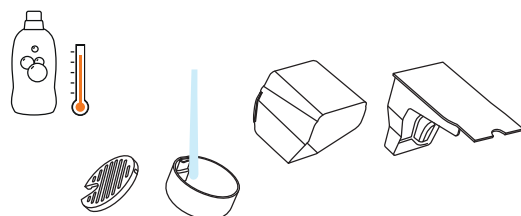

- 7** Lavez le bac à capsules usagées, le support de tasse et le bac d'égouttage avec de l'eau chaude et un détergent doux sans odeur.

**ATTENTION :** Ne nettoyez jamais votre machine avec des solvants ou des produits nettoyants puissants ou abrasifs. Ne placez pas la machine au lave-vaisselle. Ne plongez jamais la machine ou une partie de celle-ci dans l'eau.

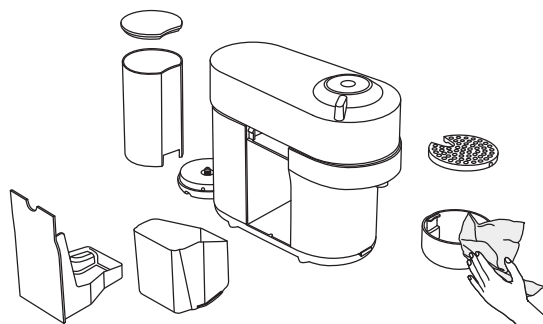

- 8** Séchez avec un linge propre et doux.

**ATTENTION :** Nettoyez régulièrement l'embout de sortie du café avec un chiffon propre et humide. Utilisez toujours un chiffon doux pour nettoyer la machine.

**À NOTER :** De l'eau peut s'accumuler à l'intérieur de la tête de la machine. Si c'est le cas, veillez à sécher les parties visibles avec un linge propre et sec.

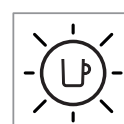
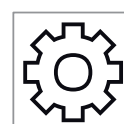
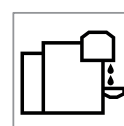
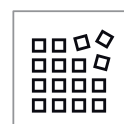
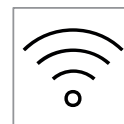

## DÉTARTRAGE

Le détartrage de votre machine vous permet d'assurer son bon fonctionnement tout au long de sa durée de vie et de profiter d'une expérience café aussi incomparable qu'au premier jour. Votre machine vous avertit lorsqu'elle a besoin d'être détartrée au moyen d'un voyant orange qui clignote 3 fois, suivi d'un voyant blanc fixe.



**i** Le processus de détartrage dure environ 20 minutes et ne **peut pas être interrompu**.

**REMARQUE :** Veuillez lire attentivement les instructions de détartrage avant de commencer.

### Accessoires :

- Un kit de détartrage disponible sur [www.nespresso.com](http://www.nespresso.com)
- Un récipient vide (1 L)

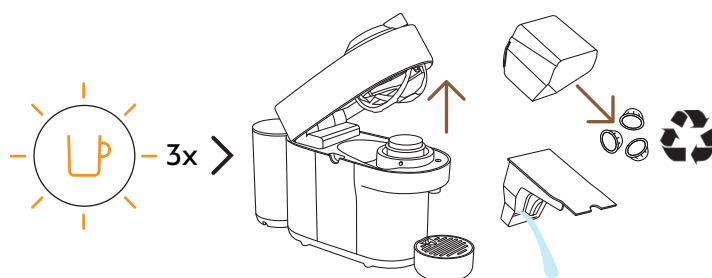

- 1** Lorsque la touche orange clignote 3 fois : ouvrez la tête de la machine pour la déverrouiller et éjecter automatiquement la capsule usagée. Videz le bac à capsules usagées et le bac d'égouttage, puis remettez-les en place. N'oubliez pas de recycler vos capsules **Nespresso**.\*

\* C'EST **NESPRESSO**. C'EST RECYCLABLE. Pour plus d'informations sur le recyclage de vos capsules **Nespresso**, visitez le site [FR : www.nespresso.com/agit](http://www.nespresso.com/agit) | [CH : www.nespresso.com](http://www.nespresso.com)

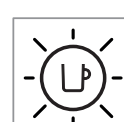
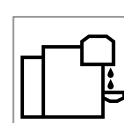
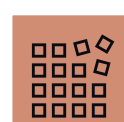
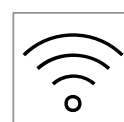

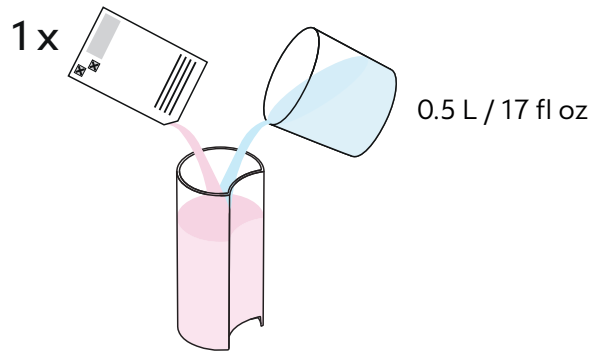

- 2** Versez 0,5 L d'eau dans le réservoir et ajoutez 1 dose de liquide de détartrage **Nespresso**.

**ATTENTION :** La solution de détartrage peut être dangereuse. Évitez tout contact avec les yeux, la peau et les surfaces.

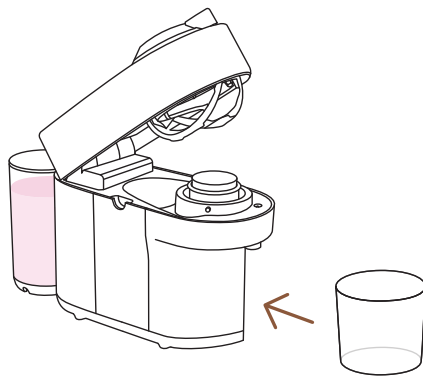

- 3** Retirez le support de tasse et placez un récipient vide (d'au moins 1 L) sous la sortie café.

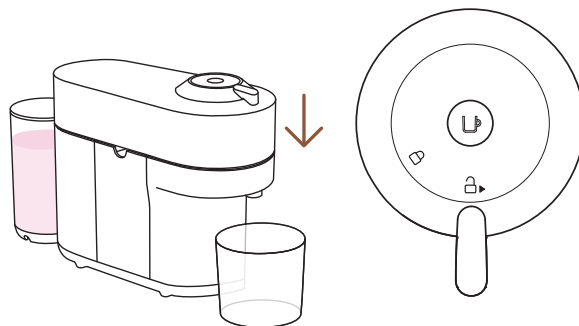

- 4** Lorsque la machine est allumée, fermez la tête de la machine et laissez le levier en position de déverrouillage.



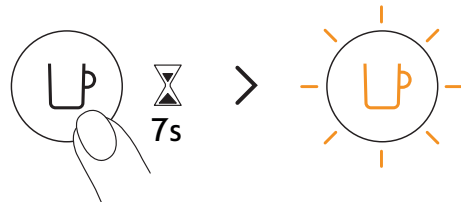

- 5** Appuyez sur la touche pendant au moins 7 secondes ou jusqu'à ce que le voyant s'éteigne. La touche orange commence à clignoter rapidement.

**ATTENTION :** Vous avez maintenant 45 secondes pour activer le mode détartrage. Passé ce délai, la machine repassera en mode préparation.

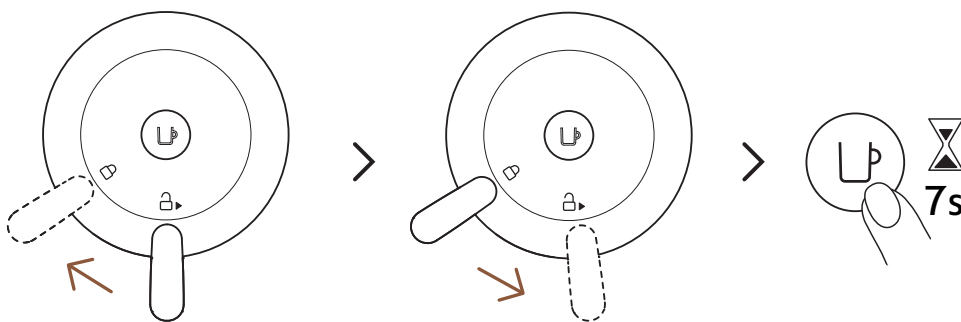

- 6** Verrouillez la tête de la machine en tournant le levier vers la gauche jusqu'au symbole de verrouillage, puis déverrouillez-la en le tournant vers la droite en position de déverrouillage. Appuyez de nouveau longuement sur la touche pendant environ 7 secondes ou jusqu'à ce que le voyant s'éteigne. La touche orange commence à clignoter rapidement.

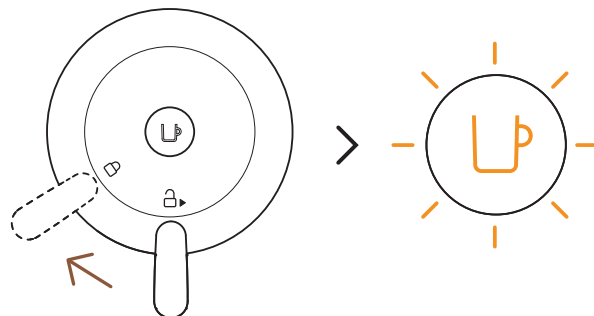

- 7** Pour accéder au mode détartrage, verrouillez la machine en tournant le levier vers la gauche en position de verrouillage. Le voyant orange devrait continuer à clignoter rapidement. Il indique que vous avez activé le mode détartrage.

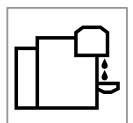
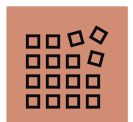



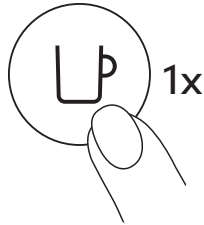

- 8** Appuyez une fois sur la touche café pour lancer le processus de détartrage. Le voyant orange clignote de façon continue tout au long du processus.

- i** La machine s'arrête automatiquement lorsque la première phase de détartrage est terminée.

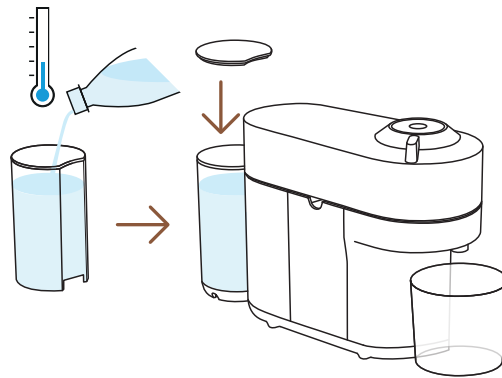

- 9** Une fois le détartrage terminé, vous devez rincer la machine. Rincez abondamment le réservoir d'eau et le bac d'égouttage.

Remplissez le réservoir avec de l'eau douce et potable, puis remettez-le en place. Videz le récipient et replacez-le sous la sortie café.

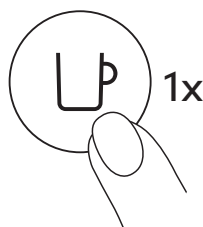

- 10** Appuyez sur la touche pour rincer la machine. Lorsque la touche s'arrête de clignoter rapidement et que le voyant devient fixe, le processus de détartrage est terminé.

- i** La machine s'arrête automatiquement lorsque le processus est terminé.



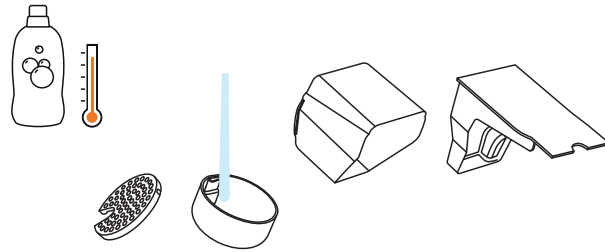

- 11** Lavez le bac à capsules usagées, le support de tasse et le bac d'égouttage avec de l'eau chaude et un détergent doux sans odeur.

**ATTENTION :** Ne nettoyez jamais votre machine avec des solvants ou des produits nettoyants puissants ou abrasifs. Ne placez pas la machine au lave-vaisselle. Ne plongez jamais la machine ou une partie de celle-ci dans l'eau.

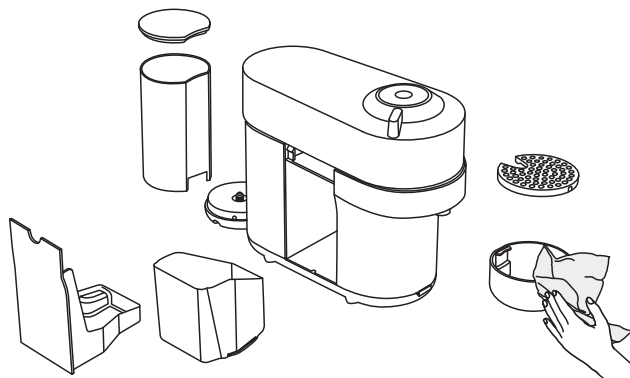

- 12** Séchez avec un linge propre et doux. Laissez sécher la machine pendant 10 minutes avant de l'utiliser.

**À NOTER :** Pendant le nettoyage, il se peut que de l'eau s'accumule à l'intérieur de la tête de la machine. Si c'est le cas, veillez à sécher les parties visibles avec un chiffon propre et sec.

**À NOTER :** La fonction de détartrage de la machine ne s'activera qu'à compter de la préparation de 30 cafés ou plus.

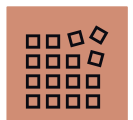

## VIDANGE DU SYSTÈME

La vidange du système est un processus que vous pouvez effectuer avant une période de non-utilisation, par mesure de protection contre le gel ou avant d'envoyer la machine en vue de sa réparation.

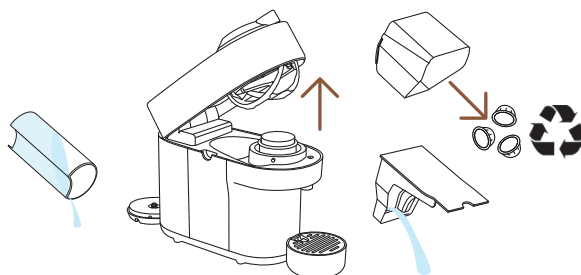

- 1** Videz le réservoir d'eau et ouvrez la tête de la machine pour éjecter automatiquement la capsule usagée. Videz le bac à capsules usagées et le bac d'égouttage. N'oubliez pas de recycler vos capsules **Nespresso**.\*

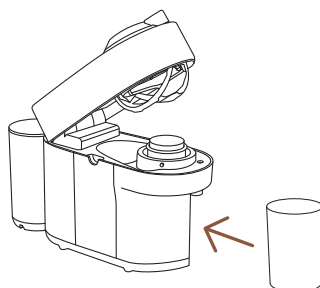

- 2** Remettez-les en place sur la machine, retirez le support de tasse et placez un récipient vide (0,5 L) sous la sortie café.

\* C'EST **NESPRESSO**. C'EST RECYCLABLE. Pour plus d'informations sur le recyclage de vos capsules **Nespresso**, visitez le site [FR : www.nespresso.com/agit](http://www.nespresso.com/agit) | [CH : www.nespresso.com](http://www.nespresso.com)



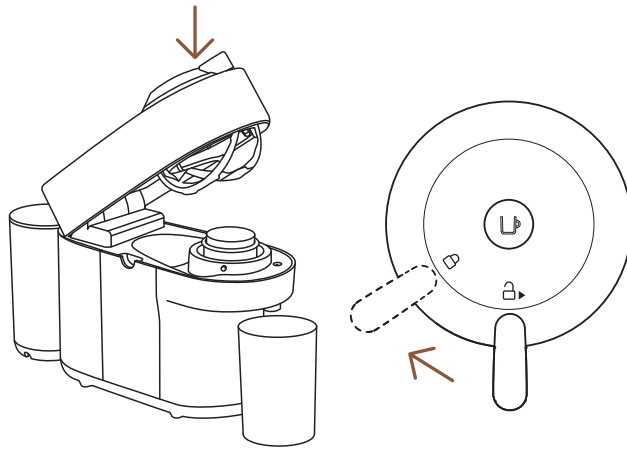

- 3** Lorsque la machine est branchée et allumée, tournez le levier en position de verrouillage.

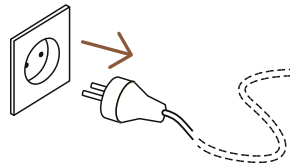

- 4** Débranchez la machine.

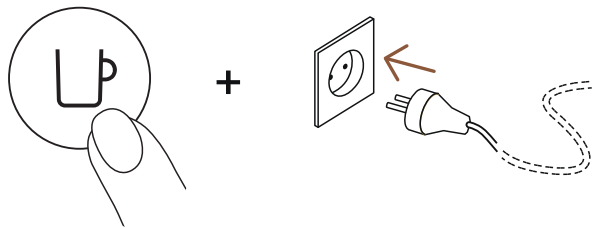

- 5** Appuyez longuement sur la touche café tout en branchant la machine.

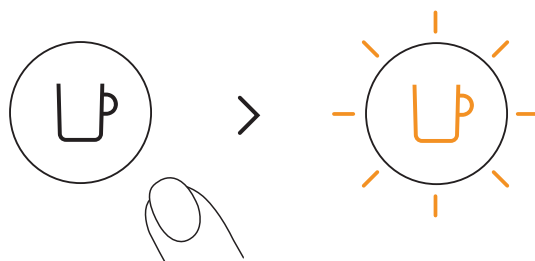

- 6** Relâchez la touche. Le voyant orange clignote et le processus de vidange démarre.

- i** Le processus complet de vidange de la machine dure environ 30 secondes. La machine s'éteint automatiquement lorsqu'elle est vidangée.

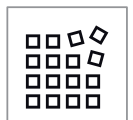

## RESTAUREZ LES RÉGLAGES D'USINE

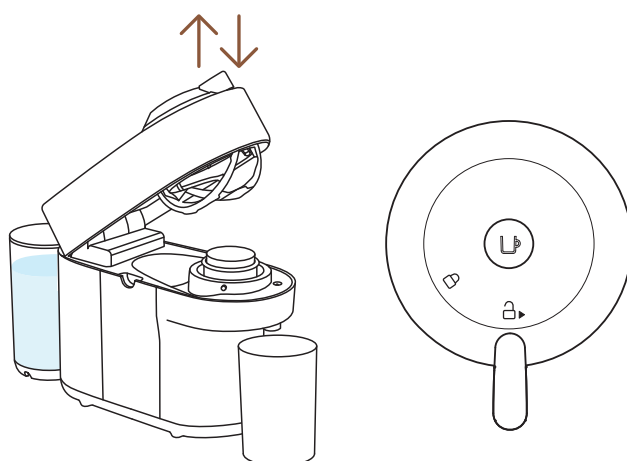

- 1 Lorsque la machine est branchée, ouvrez, puis fermez la tête de la machine avant de laisser le levier en **position de déverrouillage**.

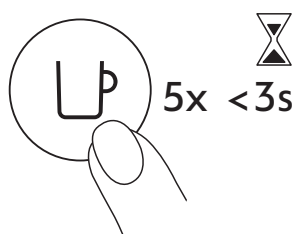

- 2 Appuyez sur la touche café à 5 reprises dans un intervalle de 3 secondes. La machine est maintenant programmée sur la base des réglages par défaut.

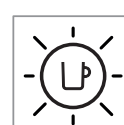
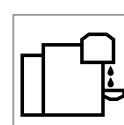
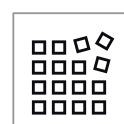
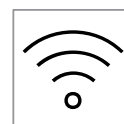

## IDENTIFICATION DES VOYANTS LUMINEUX

Vous voulez en savoir plus sur les voyants clignotants de la machine **Vertuo Pop** ? Consultez la vidéo suivante :



## PANNES

### La touche café ne s'allume pas.

- La machine s'est éteinte automatiquement ; appuyez sur la touche café ou déverrouillez la machine.
- Vérifiez l'alimentation secteur, la prise, la tension et le fusible.

### Le café et l'eau ne s'écoulent pas.

- Vérifiez que le réservoir d'eau est rempli.
- Vérifiez qu'une capsule neuve est correctement insérée et que le levier est bien verrouillé. Appuyez sur la touche café pour démarrer la préparation du café.
- Procédez au détartrage de la machine si nécessaire.
- Ouvrez la partie supérieure de la machine ; la capsule est éjectée automatiquement. Lancez ensuite la procédure de nettoyage conformément aux instructions figurant à la section « **ENTRETIEN** » du présent guide.

### Le café n'est pas assez chaud.

- Préchauffez la tasse avec de l'eau chaude du robinet.
- Procédez au détartrage de la machine si nécessaire.

### Il y a une fuite ou le café s'écoule de façon inhabituelle.

- Vérifiez que le réservoir d'eau est correctement positionné.
- Procédez au détartrage de la machine si nécessaire.

### La machine s'éteint.

- Dans un souci d'économie d'énergie, la machine s'éteint après 2 minutes de non-utilisation.
- Pour éteindre la machine manuellement à tout moment (lorsqu'elle n'est pas en cours de fonctionnement), appuyez sur la touche pendant 3 secondes.

### Il y a du marc de café dans la tasse.

- Lancez la procédure de nettoyage deux fois de suite.
- Consultez la section intitulée « **ENTRETIEN** ».



**La machine ne fonctionne pas et le voyant « ON » reste allumé. Si le voyant clignote, voir les points suivants.**

**La machine ne fonctionne pas et le voyant clignote de façon intermittente ; un clignotement, puis une pause.**

**Le voyant clignote pendant que la machine fonctionne.**

**Le voyant clignote alors que la machine ne fonctionne pas.**

- Vérifiez que le levier est correctement verrouillé.
- Si vous voulez préparer un café, vérifiez qu'une capsule neuve est correctement insérée et que le levier est bien verrouillé. Appuyez sur la touche pour démarrer la préparation du café.
- Si vous souhaitez lancer une procédure de nettoyage, de détartrage ou de vidange, vérifiez que le compartiment à capsules est vide, fermez et verrouillez la machine, puis appuyez sur la touche pour lancer l'une de ces procédures.
- Remplissez le réservoir d'eau et appuyez sur la touche.
- Vérifiez que le levier est correctement verrouillé.
- Si le café coule normalement, la machine fonctionne bien.
- Si la machine n'expulse que de l'eau, elle effectue un nettoyage, un détartrage ou une vidange, selon la demande de l'utilisateur. Reportez-vous à la section correspondante.
- Éteignez la machine en appuyant sur la touche pendant 3 secondes, puis appuyez de nouveau dessus pour remettre la machine sous tension. Après une utilisation prolongée, laissez la machine refroidir pendant environ 20 minutes.
- Un temps d'attente est nécessaire avant l'écoulement du café (en raison de la lecture du code-barres et du prémouillage du café).
- Vérifiez qu'une capsule neuve est correctement insérée et que le levier est bien verrouillé. Appuyez sur la touche pour démarrer la préparation du café.
- Remplissez le réservoir d'eau et appuyez sur la touche café.
- Éteignez la machine en appuyant sur la touche pendant 3 secondes, puis appuyez de nouveau dessus pour remettre la machine sous tension. Après une utilisation prolongée, laissez la machine refroidir pendant environ 20 minutes.

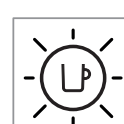
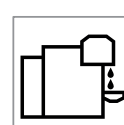
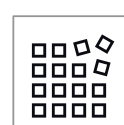
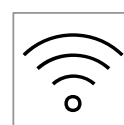



**Le voyant clignote de façon intermittente (deux clignotements suivis d'une pause, et ainsi de suite). La machine ne fonctionne pas.**

- Pendant la préparation d'un café :
  - 1) Déverrouillez le levier et ouvrez la partie supérieure de la machine afin de vérifier si une capsule neuve et non endommagée est correctement insérée.
  - 2) Vérifiez que le levier est correctement verrouillé.
  - 3) Vérifiez que le réservoir d'eau est rempli.
- Pendant la procédure de détartrage, de vidange ou de nettoyage :
  - 1) Vérifiez que la capsule a été éjectée.
  - 2) Vérifiez que le levier est correctement verrouillé.
- Pendant la programmation d'une longueur de tasse :
  - 1) Vérifiez qu'une capsule a bien été insérée.
  - 2) Reportez-vous à la section correspondante.
- Si le problème persiste :
  - 1) Déverrouillez le levier et ouvrez la partie supérieure de la machine.
  - 2) Remplacez la capsule (si nécessaire).
  - 3) Débranchez le câble d'alimentation, attendez 10 secondes, puis rebranchez-le.
  - 4) Fermez la machine et appuyez sur la touche pour la mettre sous tension, puis appuyez de nouveau pour lancer la préparation du café.

Si le problème persiste, appelez **Nespresso**.

**Le voyant clignote de façon intermittente à 3 reprises, puis reste allumé.**

- Détartrage requis : une fois que l'alerte apparaît, l'utilisateur peut encore préparer quelques cafés avant que le détartrage ne devienne obligatoire.

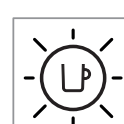
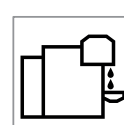
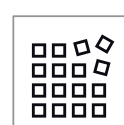
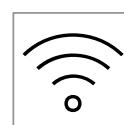

## CARACTÉRISTIQUES TECHNIQUES

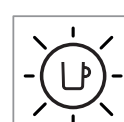
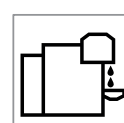
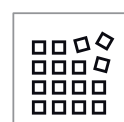
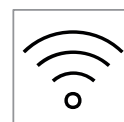

**Puissance** ~220–240 V, 50–60 Hz, 1300–1500 W  
**US, CA:** 120 V, 60 Hz, 1500 W  
**MX:** 127 V~, 60 Hz, 1380 W

**Fréquence** 2.402–2.480 GHz

**Puissance d'émission (EIRP)** Bluetooth 4 dBm max. (EIRP) et Wi-Fi < 20 dBm max. (EIRP)

**Mode veille** 0,39 W/h

**Mode économie d'énergie** Arrêt automatique : 2 min

**Temps de préchauffage** 30 secondes (tête fermée et verrouillée)

**Support de tasse amovible pour les recettes plus longues** Position unique amovible

**Longueur du câble en fonction de la provenance de la machine** 75 cm / 30 in

**Dimensions (L x P x H)** 13,6 x 42,6 x 25 cm / 5.3 x 16.7 x 9.8 in

**Poids** 3,5 kg / 7.72 lbs

**Capacité du réservoir d'eau** 0,6 L / 20 fl oz

**Capacité du bac à capsules usagées** 8 capsules espresso ou 5 capsules mug

## CODES DES MACHINES

**Nespresso**

**Breville**

**Delonghi**

GCV2, GDV2

BNV120, BNV150

ENV90

**Krups**

**Magimix**

XN9201, XN9204,  
 XN9205, XN9211

M800

# KLICKEN UND SPRACHE AUSWÄHLEN

DE



**SICHERHEITSHINWEISE**



**ÜBERSICHT**



**KONNEKTIVITÄT**



**ERSTE SCHRITTE**



**KAFFEEZUBEREITUNG**



**TASSENFÜLLMENGE ANPASSEN**



**REINIGUNG**



**ENTKALKUNG**



**ENTLEERUNG**



**AUF WERKSEINSTELLUNGEN  
ZURÜCKSETZEN**



**BEDEUTUNG DER BLINKENDEN LED**



**FEHLERBEHEBUNG**



**SPEZIFIKATIONEN**

## SICHERHEITSHINWEISE

**ACHTUNG:** Bevor Sie Ihre Kaffeemaschine in Betrieb nehmen, lesen Sie bitte sorgfältig die beigelegte Sicherheitsbroschüre, um Verletzungen oder Schäden zu vermeiden.

### ENTSORGUNG UND UMWELTSCHUTZ

Dieses Gerät entspricht der EU Richtlinie 2012/19/EG. Sowohl die Verpackung als auch das Gerät selbst enthalten wertvolle Materialien, welche recycelt und wiedergewonnen werden können. Durch die Trennung der Abfallstoffe in verschiedene Arten, wird das Recycling der wertvollen Rohstoffe erleichtert. Geben Sie das Gerät in einer entsprechenden Sammelstelle ab. Weitere Informationen zu den Sammelstellen erhalten Sie bei den örtlichen Behörden.

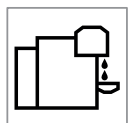

# ÜBERSICHT

## MASCHINENÜBERSICHT

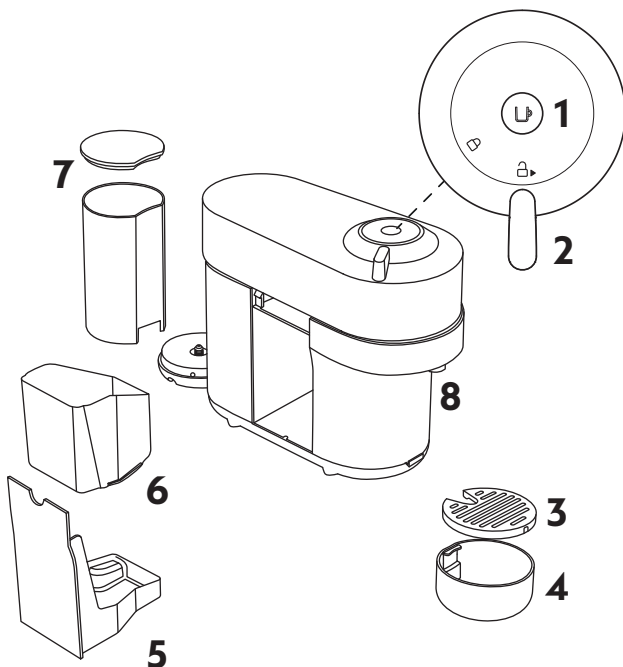

- 1 AN/AUS und Kaffee-Knopf
- 2 Verriegeln/Entriegeln des Hebels
- 3 Abtropfgitter
- 4 Verstellbare Tassenhalterung
- 5 Abtropfschale
- 6 Kapselbehälter für gebrauchte Kapseln
- 7 Wassertank und Deckel
- 8 Kaffee-Auslauf

## VERPACKUNGSINHALT



- 1 Kaffeemaschine
- 2 **Nespresso** Kapselbox
- 3 **Nespresso** Willkommensbroschüre
- 4 Sicherheitshinweise
- 5 Schnellstartanleitung
- 6 Gewährleistung

4 + 5 + 6

**i Auspacken:** Beim Auspacken könnte sich aufgrund der für die Verpackung verwendeten recycelten Materialien ein wenig Staub auf der Maschine befinden. Dieser ist nicht gefährlich, entfernen Sie ihn einfach mit einem sauberen, weichen Tuch.

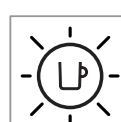
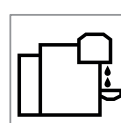
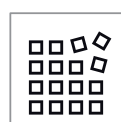
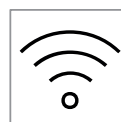

## ÖFFNEN/SCHLIESSEN

### ÖFFNEN

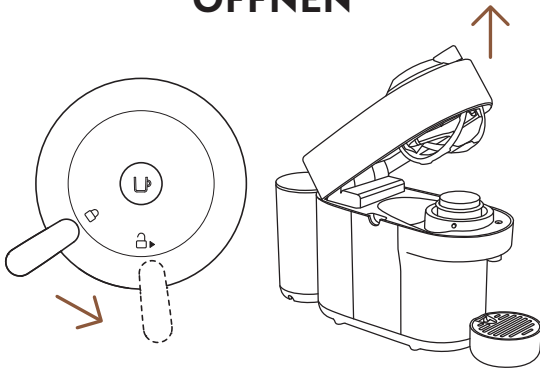

### SCHLIESSEN

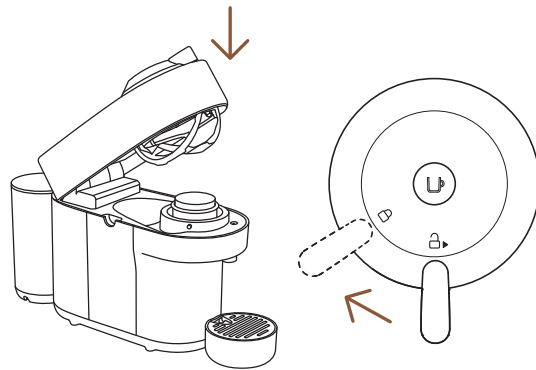

**ACHTUNG:** Für das ordnungsgemäße Funktionieren der Maschine ist es wichtig, dass Sie den Maschinenkopf während des Brühvorgangs nicht öffnen, sondern warten, bis die Kaffeetaste wieder konstant weiss leuchtet. Wenn Sie den Brühvorgang vorher abbrechen möchten, drücken Sie den Kaffeeknopf einmal und warten Sie, bis die Maschine stoppt, bevor Sie den Maschinenkopf öffnen.

## DAS VERTUO SYSTEM

### KOMPATIBILITÄT DER KAPSELN



**S**

**Ristretto**

(25 ml)

**Espresso**

(40 ml)



**M**

**Double Espresso**

(80 ml)

**Gran Lungo**

(150 ml)



**L**

**Mug**

(230 ml)

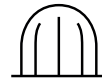

**XL**

**Alto, Cold Brew Style**

(355 ml)

**Carafe**

(535 ml)

### KOMPATIBILITÄT DER ACCESSOIRES



Kompati-  
bilität der  
Accessoires



**Ristretto**



**Espresso**



**Double  
Espresso**



**Gran  
Lungo**



**Mug (S)**



**Mug (M)**



**Reveal  
Glas**



Nicht  
geeignete  
Accessoires



**Mug (L)**



**Carafe**

Entdecken Sie alle unsere Accessoires auf [www.nespresso.com](http://www.nespresso.com)

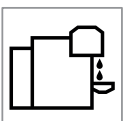
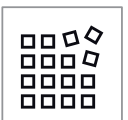

## AN/AUS

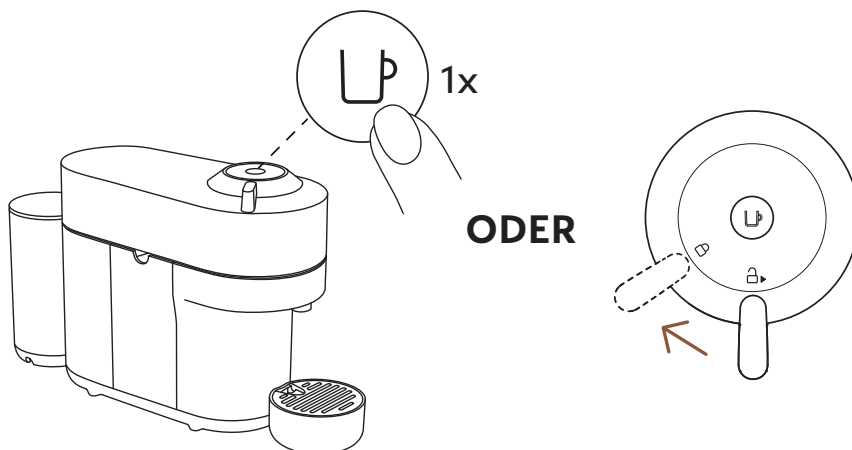
**AN**

Sobald die Maschine angeschlossen ist, schalten Sie sie ein, indem Sie den Knopf einmal drücken oder den Hebel in der Verriegelungsposition (bei geschlossenem Maschinenkopf) schliessen.

- i** Während die Maschine aufheizt, blinkt das Licht ca. 30 Sekunden lang. Sobald das Licht konstant leuchtet, ist die Maschine einsatzbereit.

**AUS**

Die Maschine schaltet sich nach 2 Minuten der Nichtnutzung aus, um Energie zu sparen.

- i** Sie können die Maschine (wenn sie nicht benutzt wird) jederzeit manuell ausschalten, indem Sie den Knopf 3 Sekunden lang gedrückt halten.

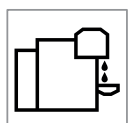

## KONNEKTIVITÄT

### WARUM SIE IHRE VERTUO POP VERBINDEN SOLLTEN?

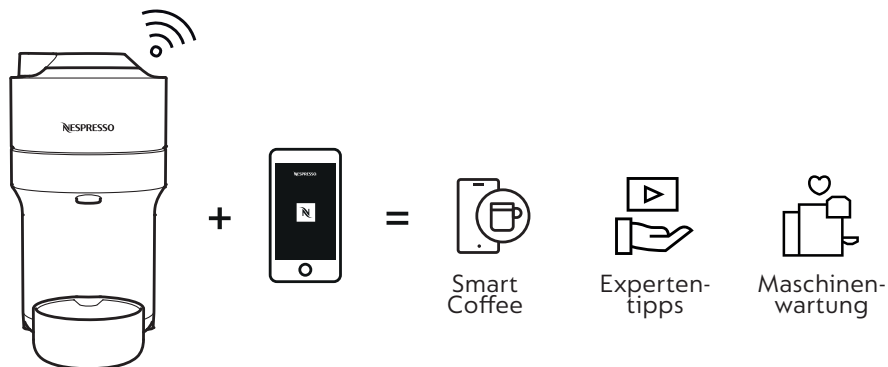

### VORTEILE, WENN IHRE VERTUO POP VERBUNDEN IST

- **Smart Coffee:** Wenn Sie Ihre Maschine stets auf dem neuesten Stand halten, werden Sie als Erste über Neuheiten und Kaffee-Innovationen von **Nespresso** informiert
- **Expertentipps:** Sie bekommen Hilfe und einfache Anleitungsvideos dazu, wie Sie Ihre Kaffeereise mit Ihrem Smartphone begleiten können
- **Maschinenwartung:** Sie erhalten eine Benachrichtigung, sobald Ihre Maschine eine Wartung erfordert, mit einer einfachen Schritt-für-Schritt-Anleitung für das Entkalken, Spülen, Reinigen etc.

### WIE SIE IHRE VERTUO POP VERBINDEN

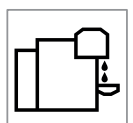





**1** Laden Sie die **Nespresso** App oder das neueste App-Update auf Ihr Smartphone oder Tablet herunter. Starten Sie die App und drücken Sie im Bildschirm rechts oben auf das Maschinensymbol.

**HINWEIS:** Für ein optimales Nutzungserlebnis empfehlen wir, dass Sie Ihre Maschine mit einem WLAN-Router und nicht per Smartphone-Hotspot verbinden.

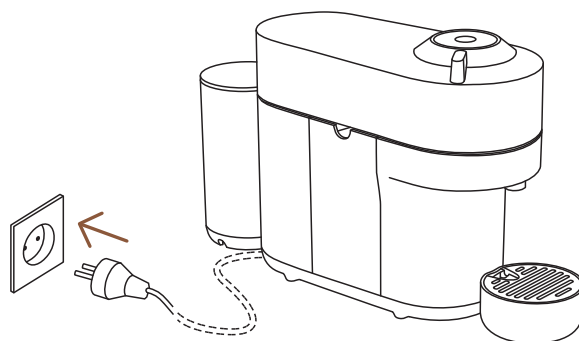

**2** Stecken Sie den Netzstecker ein.



**3** Folgen Sie den Anleitungen in der **Nespresso** App.

**ACHTUNG:** Lesen Sie zuerst die Sicherheitshinweise, um die Gefahr eines tödlichen Stromschlags oder Feuer zu vermeiden. Stellen Sie sicher, dass die verwendete Steckdose geerdet ist.

\* App Store® ist eine eingetragene Marke von Apple Inc., die in den USA und anderen Ländern registriert ist.  
 \*\* Google Play und das Google Play-Logo sind eingetragene Marken von Google LLC.



## DEAKTIVIERUNG VON BLUETOOTH UND WLAN

Die Maschine hat ein Konnektivitäts-Modul, das standardmässig aktiviert ist. Dieses ermöglicht den Zugriff auf zusätzliche Funktionen für ein noch besseres Kaffee-Erlebnis. Um das Konnektivitätsmodul zu deaktivieren, gehen Sie folgendermassen vor:

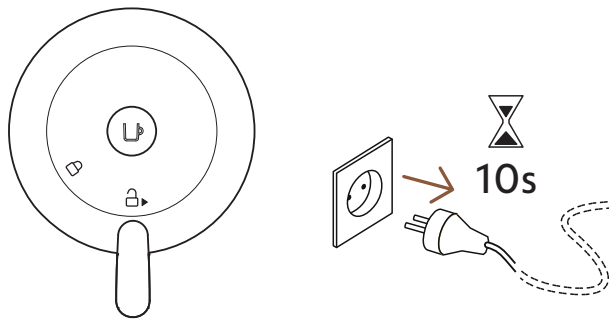

- 1** Ziehen Sie bei geschlossenem Gerät und **entriegeltem** Hebel für mindestens 10 Sekunden den Netzstecker.

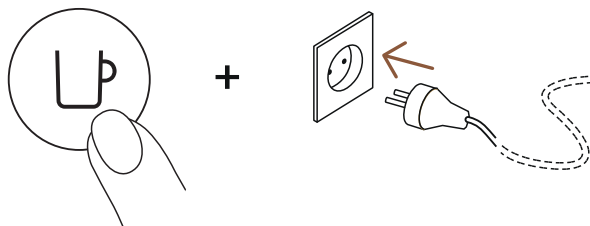

- 2** Drücken und halten Sie den Knopf, während Sie den Stecker wieder einstecken. Der Knopf blinkt orange zur Bestätigung, dass das Konnektivitätsmodul deaktiviert wurde.

- i** Führen Sie die gleichen Schritte aus, um das Konnektivitätsmodul wieder zu aktivieren. Der Knopf blinkt weiss zur Bestätigung, dass das Modul wieder aktiviert wurde.

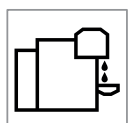

# ERSTE SCHRITTE

## ERSTE SPÜLUNG

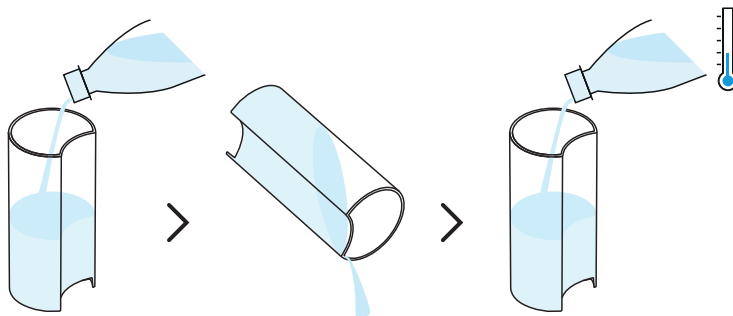

- 1** Spülen und reinigen Sie den Wassertank und Deckel, bevor Sie ihn mit frischem Trinkwasser füllen.

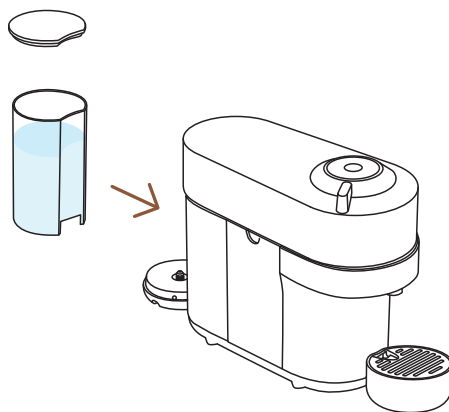

- 2** Verschiessen Sie den Wassertank mit dem Deckel und setzen Sie den Wassertank wieder an der Maschine ein. Vergewissern Sie sich, dass er richtig fixiert ist.



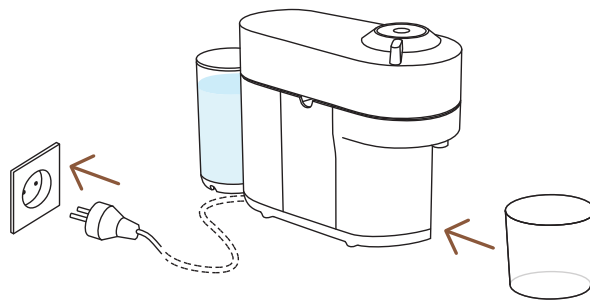

- 3** Wenn die Maschine angesteckt ist, entfernen Sie die Tassenhalterung und stellen Sie einen leeren (mindestens 1 l grossen) Behälter unter den Kaffee-Auslauf.

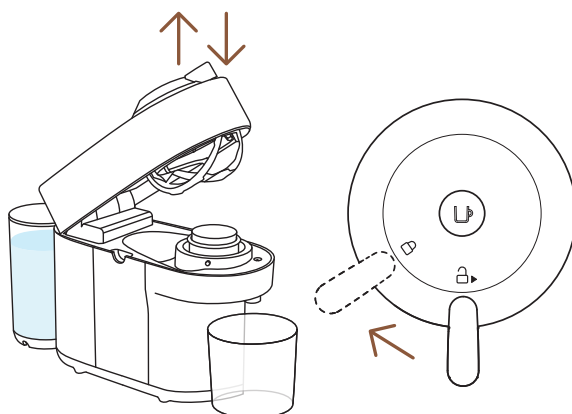

- 4** Öffnen und schliessen Sie die Maschine. Vergewissern Sie sich, dass der Hebel verriegelt ist.

- i** Das Licht blinkt, während die Maschine aufheizt. Dies dauert ca. 30 Sekunden. Wenn das Licht konstant leuchtet, ist die Maschine einsatzbereit. Achten Sie darauf, dass keine Kapsel eingelegt ist.

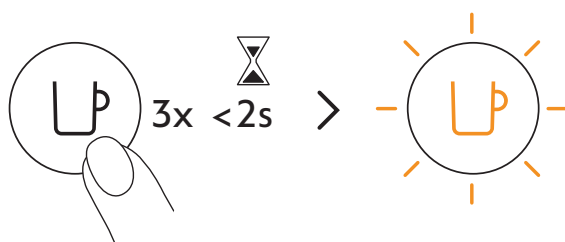

- 5** Drücken Sie den Knopf 3 Mal innerhalb von 2 Sekunden, um den Spülvorgang zu starten. Wenn die Taste orange blinkt, lassen Sie den Spülvorgang automatisch durchlaufen, bis er fertig ist. Wenn das Licht konstant weiss leuchtet, ist der Vorgang abgeschlossen.

- i** Innerhalb von weniger als 2 Minuten sollte der Spülvorgang starten und das Wasser zu fließen beginnen. Dieser Vorgang dauert bis zu 7 Minuten.

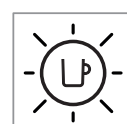
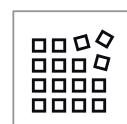
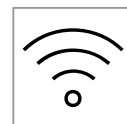

# KAFFEEZUBEREITUNG

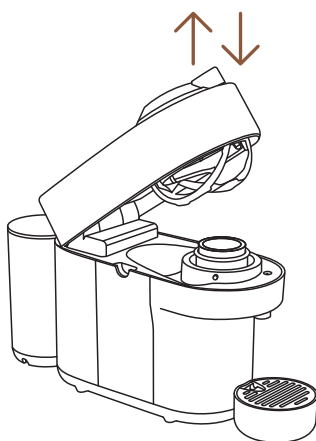

**1** Öffnen und schliessen Sie die Maschine.

**i** Der Kaffeeknopf blinkt, während die Maschine aufheizt. Wenn das Licht konstant leuchtet, ist die Maschine einsatzbereit.

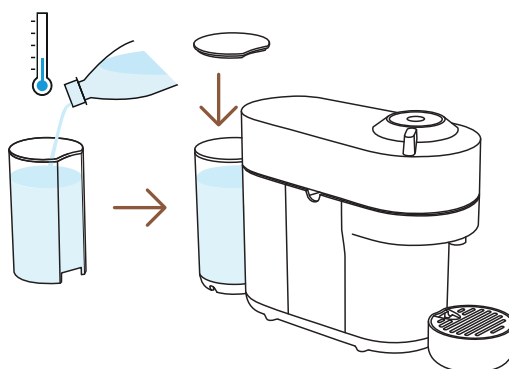

**2** Füllen Sie den Wassertank mit frischem Trinkwasser auf und setzen Sie ihn wieder in die Maschine ein.

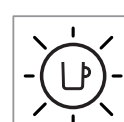
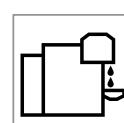
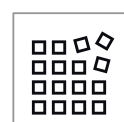
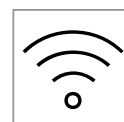

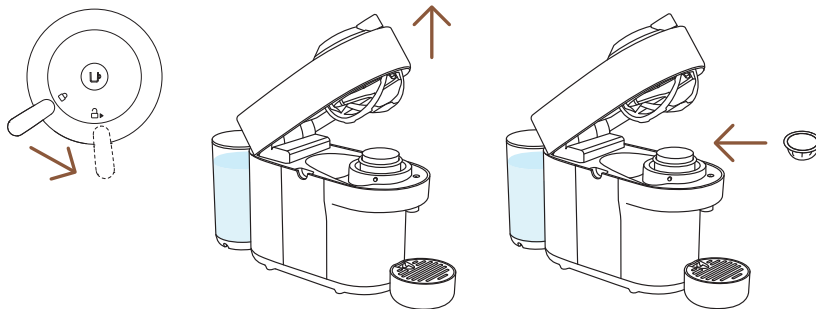

- 3** Entriegeln und öffnen Sie den Maschinenkopf vollständig und legen Sie eine **VERTUO** Kapsel mit der Kuppel nach unten ein.

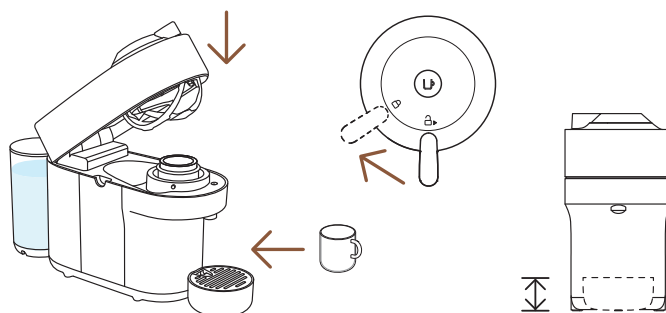

- 4** Schliessen Sie den Maschinenkopf und verriegeln Sie ihn, indem Sie den Hebel nach links bis zur Verriegelungsposition drehen, und stellen Sie eine Tasse unter. Die Tassenhalterung kann an die Tassengrösse angepasst werden.

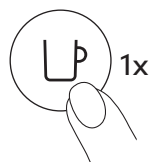

- 5** Starten Sie den Brühvorgang, indem Sie den Knopf einmal drücken.

**ACHTUNG:** Für das ordnungsgemässe Funktionieren der Maschine ist es wichtig, dass Sie den Maschinenkopf während des Brühvorgangs nicht öffnen, sondern warten, bis die Kaffeetaste wieder konstant weiss leuchtet. Wenn Sie den Brühvorgang vorher abbrechen möchten, drücken Sie den Kaffeeknopf einmal und warten Sie, bis die Maschine stoppt, bevor Sie den Maschinenkopf öffnen.

- i** Da erst der Code eingelesen und der Kaffee vorbefeuchtet wird, dauert es einen Moment, bis der Kaffee zu fließen beginnt. Die Maschine erkennt automatisch, welche Kapsel eingelegt wurde, und wählt die Zubereitungsparameter und Kaffeelänge, die von den **Nespresso** Experten für die optimale Extraktion des jeweiligen Kaffees empfohlen werden.

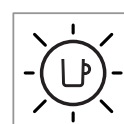
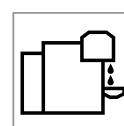
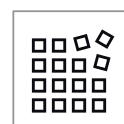
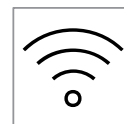

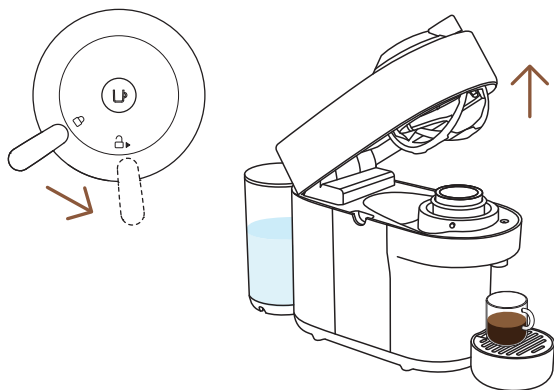

- 6** Wenn der Brühvorgang fertig ist, öffnen Sie den Maschinenkopf, indem Sie den Hebel nach rechts in die Entriegelungsposition drehen. Die Kapsel wird automatisch ausgeworfen. Geniessen Sie Ihren Kaffee!



- 7** Vergessen Sie nicht, Ihre **Nespresso** Kapseln zu recyceln.\*

\*DAS IST **NESPRESSO**. DAS IST RECYCELBAR. Weitere Informationen über das Recycling von **Nespresso** Kapseln finden Sie unter: [www.nespresso.com](http://www.nespresso.com)

**ENTDECKEN SIE UNSEREN COFFEE CREATIONS MODUS**



Diese Maschine **bietet** Ihnen eine spezielle Funktion, mit der Sie die Extraktionen konzentrieren und Ihre eigenen Rezepte kreieren können.



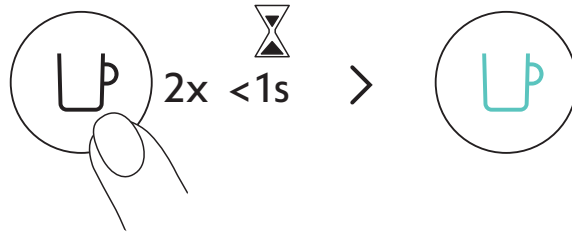

Drücken Sie bei eingeschalteter Maschine den Kaffeeknopf zweimal rasch hintereinander. Die Taste blinkt türkis und Ihr Kaffee wird konzentriert gebrüht, um den Kaffeegeschmack für Rezepte mit Zusätzen (Milch, Milchschaum, Eiswürfel...) zu optimieren. Für ein unvergleichliches Kaffee-Erlebnis.

40 ml	80 ml	150 ml	230 ml	355 ml	535 ml
✓	✓	✓	✓	✗	✗
25 ml	40 ml	40 ml	80 ml		

Um in den vollen Genuss der Vorteile zu kommen, empfehlen wir, unser Coffee+ Sortiment nur in den offiziellen Fassengrößen zuzubereiten. Um die besten Ergebnisse in der Tasse zu erzielen, empfehlen wir nicht, unsere XL Kaffees (Alto Ambrato, Alto Onice), Cold Brew Style & Carafe Pour-Over Style mit diesem Modus zuzubereiten.

**HINWEIS:** Um diesen Modus zu aktivieren, kann ein Update Ihrer Maschine über die **Nespresso** App erforderlich sein.



Entdecken Sie, wie Sie Ihre Maschine mit unserem Aeroccino Sortiment erweitern können: [www.nespresso.com](http://www.nespresso.com)

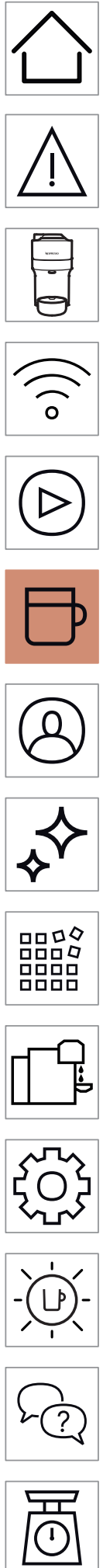



## TASSENFÜLLMENGE ANPASSEN

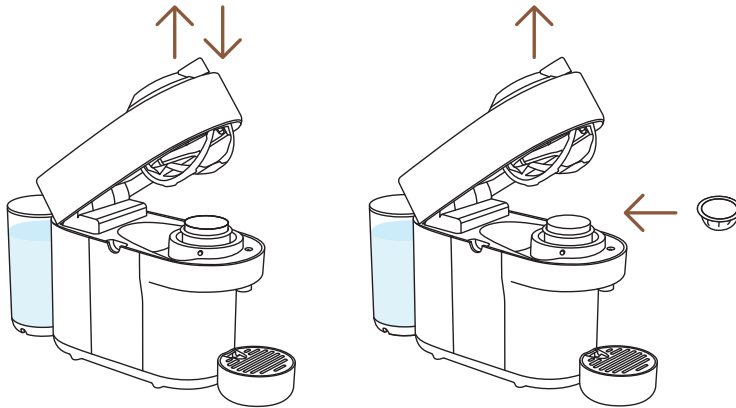

- 1** Öffnen und schliessen Sie die Maschine. Wenn die Maschine aufgedreht ist, öffnen Sie den Maschinenkopf und legen Sie die Kapsel ein, die Sie programmieren möchten.

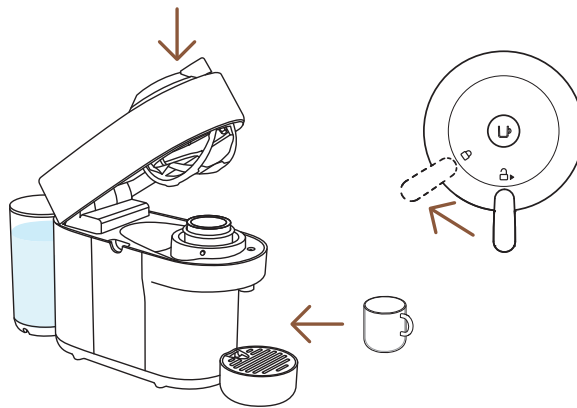

- 2** Schliessen Sie den Maschinenkopf, drehen Sie den Hebel nach links in die Verriegelungsposition und stellen Sie eine Tasse unter.

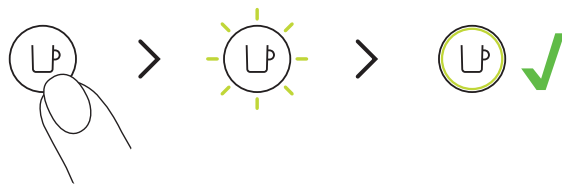

- 3** Drücken und halten Sie den Knopf, warten Sie einige Sekunden bis die gewünschte Füllmenge erreicht ist. Die neue Wassermenge ist nun für den in diesem Fall verwendeten Kapseltyp programmiert.

- i** Die Programmierung bezieht sich auf die jeweiligen Kapseltypen. Die Füllmengen können jeweils zwischen 20 ml und 535 ml programmiert werden.

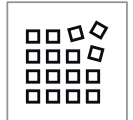

**ACHTUNG:** Für das ordnungsgemäße Funktionieren der Maschine ist es wichtig, dass Sie den Maschinenkopf während des Brühvorgangs nicht öffnen, sondern warten, bis die Kaffeetaste wieder konstant weiss leuchtet. Wenn Sie den Brühvorgang vorher abbrechen möchten, drücken Sie den Kaffeeknopf einmal und warten Sie, bis die Maschine stoppt, bevor Sie den Maschinenkopf öffnen.

**HINWEIS:** Wenn Sie die Füllmenge für einen Kapseltyp umprogrammiert haben, stoppt die Zubereitung jedes Mal, wenn dieser Kapseltyp in die Maschine einlegt wird, bei der von Ihnen programmierten Füllmenge. Wenn Sie zu den Standardparametern zurückkehren möchten, folgen Sie den Schritten im Abschnitt "Auf Werkseinstellungen zurücksetzen".

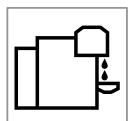

## REINIGUNG

Reinigen Sie Ihre Maschine monatlich bzw. wenn Sie Kaffeerückstände im Maschinenkopf feststellen sowie nach längerem Nichtgebrauch.

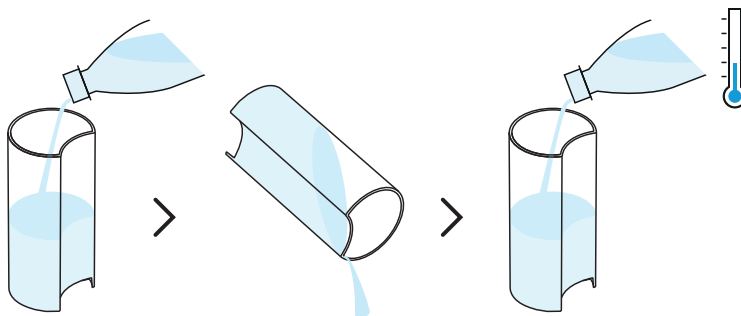

- 1** Spülen und reinigen Sie Wassertank und Deckel, bevor Sie ihn mit frischem Trinkwasser auffüllen.

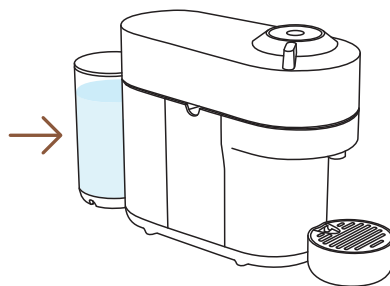

- 2** Setzen Sie den Wassertank wieder in die richtige Position an der Maschine ein.

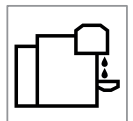
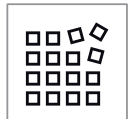

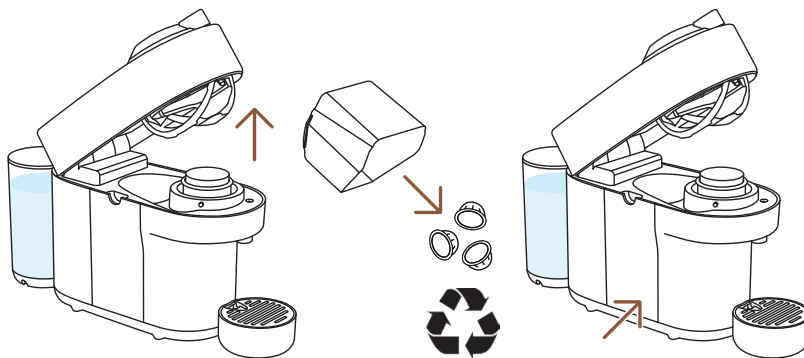

- 3** Wenn die Maschine aufgedreht ist, entriegeln und öffnen Sie den Maschinenkopf, um die gebrauchte Kapsel auszuwerfen. Leeren und spülen Sie den Kapselbehälter sowie die Abtropfschale aus und setzen Sie beide wieder ein. Vergessen Sie nicht, Ihre **Nespresso** Kapseln zu recyceln.\*

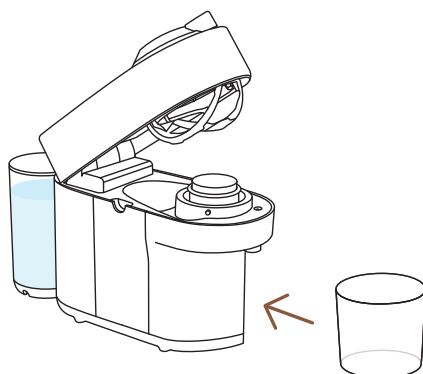

- 4** Entfernen Sie die Tassenhalterung und stellen Sie einen leeren (mindestens 1 l grossen) Behälter unter den Kaffeeauslauf.

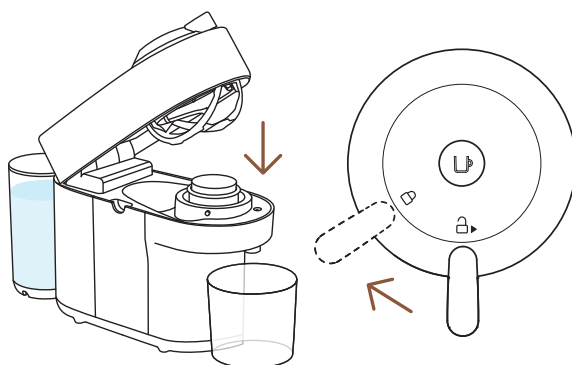

- 5** Schliessen Sie den Maschinenkopf und drehen Sie den Hebel nach links in die Verriegelungsposition. Vergewissern Sie sich, dass sich keine Kapseln in der Maschine befinden, bevor Sie den Reinigungsvorgang starten.

\*DAS IST **NESPRESSO**. DAS IST RECYCELBAR. Weitere Informationen über das Recycling von **Nespresso** Kapseln finden Sie unter: [www.nespresso.com](http://www.nespresso.com)

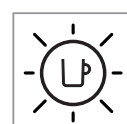
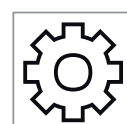
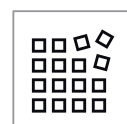
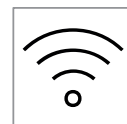

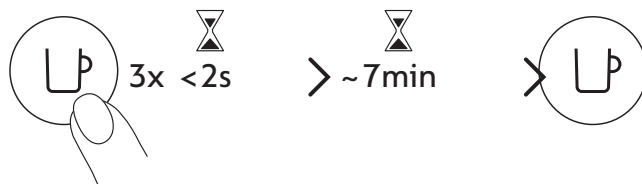

**6** Drücken Sie den Knopf 3 Mal innerhalb von 2 Sekunden, um den Spülvorgang zu starten. Wenn das orangefarbene Licht blinkt, lassen Sie den Reinigungsvorgang automatisch durchlaufen, bis er fertig ist.

**i** Innerhalb von weniger als 2 Minuten sollte der Reinigungsvorgang starten und das Wasser zu fließen beginnen. Dieser Vorgang kann bis zu 7 Minuten dauern und schaltet sich automatisch aus, sobald er abgeschlossen ist. Der Vorgang kann jederzeit durch Drücken des Knopfes unterbrochen werden

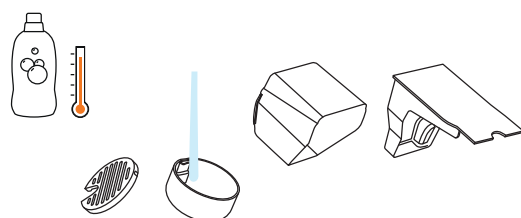

**7** Reinigen Sie den Kapselbehälter, die Tassenhalterung und die Tropfschale mit heissem Wasser und einem milden, geruchlosen Reinigungsmittel.

**ACHTUNG:** Verwenden Sie keine starken oder scheuernden Reiniger oder Lösungsmittel. Geben Sie die Maschine nicht in die Spülmaschine. Tauchen Sie die Maschine oder Teile davon niemals in Wasser ein.

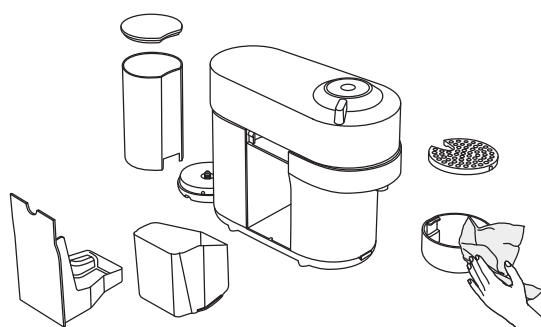

**8** Trocknen Sie die Maschine mit einem sauberen, frischen Tuch ab.

**ACHTUNG:** Reinigen Sie den Kaffeeauslauf regelmässig mit einem sauberen, feuchten Tuch. Verwenden Sie zur Reinigung der Maschine stets weiche Tücher.

**HINWEIS:** Innerhalb des Maschinenkopfes kann sich Wasser ansammeln. Bitte trocknen Sie alle sichtbaren Teile mit einem sauberen, trockenen Tuch ab.

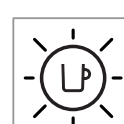
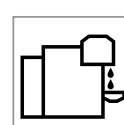
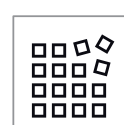
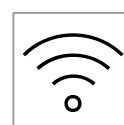

## ENTKALKUNG

Mit der regelmässigen Entkalkung Ihrer Maschine sorgen Sie dafür, dass sie über ihre gesamte Lebensdauer ordnungsgemäss funktioniert und Ihr Kaffeegenuss so unvergleichlich ist wie am ersten Tag. Ihre Maschine zeigt an, wenn eine Entkalkung erforderlich ist, indem sie 3 Mal orange blinkt und dann konstant weiss leuchtet.



**i** Der Entkalkungsvorgang dauert ca. 20 Minuten und **kann nicht unterbrochen werden.**

**HINWEIS:** Bitte lesen Sie die Entkalkungsanleitung sorgfältig durch, bevor Sie beginnen.

### Sie benötigen:

- Ein Entkalkungsset, erhältlich auf [www.nespresso.com](http://www.nespresso.com)
- Einen leeren (1 l grossen) Behälter

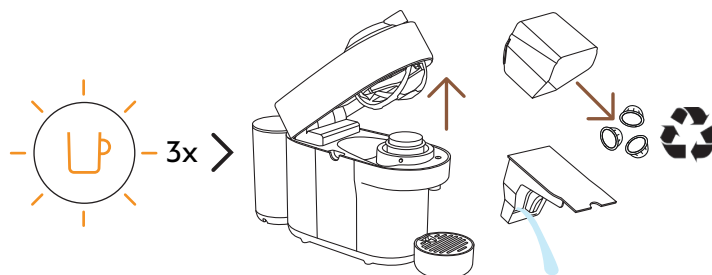

- 1** Wenn der Knopf 3 Mal orange blinkt: Entriegeln und öffnen Sie den Maschinenkopf, um die gebrauchte Kapsel auszuwerfen. Entleeren Sie den Kapselbehälter und die Tropfschale und setzen Sie sie wieder an der Maschine ein. Vergessen Sie nicht, Ihre **Nespresso** Kapseln zu recyceln.\*

\*DAS IST **NESPRESSO**. DAS IST RECYCELBAR. Weitere Informationen über das Recycling von **Nespresso** Kapseln finden Sie unter: [www.nespresso.com](http://www.nespresso.com)

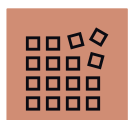

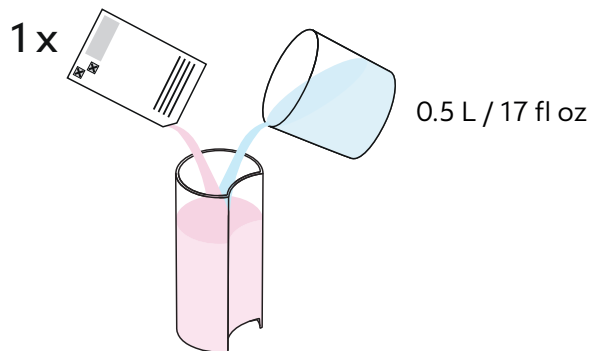

- 2** Füllen Sie 0,5 l Wasser in den Wassertank und geben Sie 1 Einheit **Nespresso** Entkalkungsflüssigkeit hinein.

**ACHTUNG:** Die Entkalkungslösung kann Reizungen und Schädigungen verursachen. Vermeiden Sie den Kontakt mit Augen, Haut und Oberflächen.

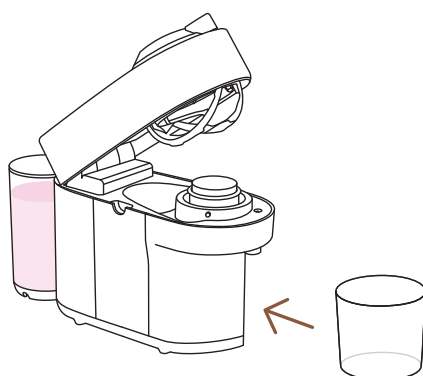

- 3** Entfernen Sie die Tassenhalterung und stellen Sie einen leeren (mindestens 1 l grossen) Behälter unter den Kaffeeauslauf.

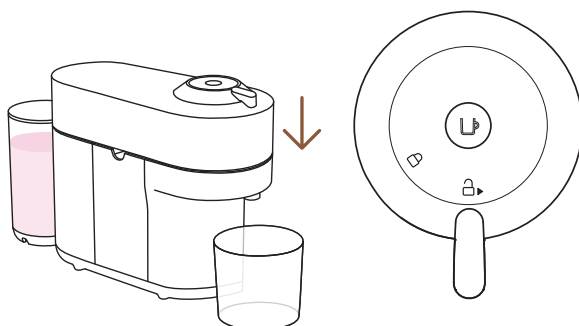

- 4** Schliessen Sie bei eingeschalteter Maschine den Maschinenkopf und lassen Sie den Hebel in der Entriegelungsposition.

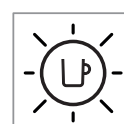
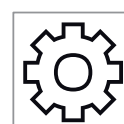
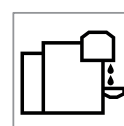
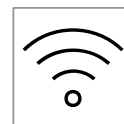

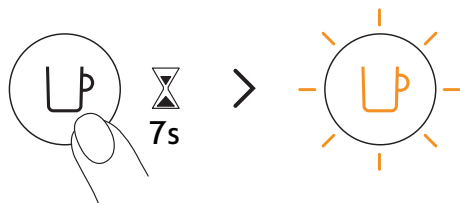

- 5** Halten Sie den Knopf mindestens 7 Sekunden lang gedrückt bzw. so lange, bis das Licht erlischt. Der Knopf beginnt in rascher Folge orange zu blinken.

**ACHTUNG:** Sie haben nun 45 Sekunden Zeit, um den Entkalkungsmodus zu starten, ansonsten kehrt die Maschine in den Brühmodus zurück.

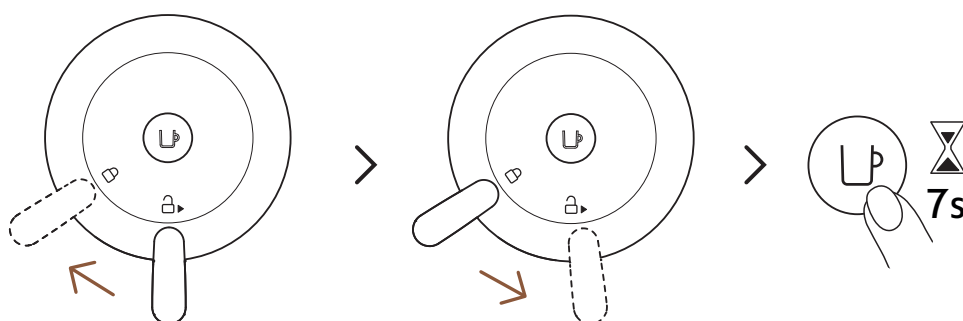

- 6** Verriegeln Sie den Maschinenkopf, indem Sie den Hebel nach links bis zum Verriegelungssymbol drehen, und entriegeln Sie dann den Hebel, indem Sie ihn nach rechts in die Entriegelungsposition drehen. Drücken Sie den Knopf erneut und halten Sie ihn ca. 7 Sekunden lang gedrückt bzw. bis das Licht erlischt. Der Knopf beginnt nun in schneller Folge orange zu blinken.

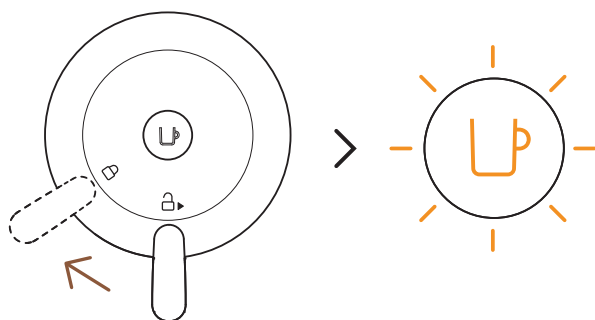

- 7** Um den Entkalkungsmodus zu starten, verriegeln Sie die Maschine, indem Sie den Hebel nach links in die Verriegelungsposition drehen. Das Licht sollte immer noch schnell orange blinken. Dies zeigt an, dass Sie den Entkalkungsmodus gestartet haben.

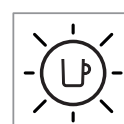
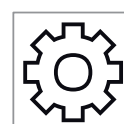
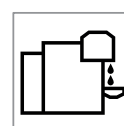
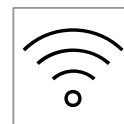



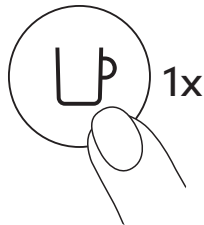

- 8** Drücken Sie die Kaffeetaste einmal, um den Entkalkungsvorgang zu starten. Diese blinkt während des Vorgangs kontinuierlich orange.

- i** Die Maschine stoppt automatisch, sobald die erste Entkalkungsphase abgeschlossen ist.

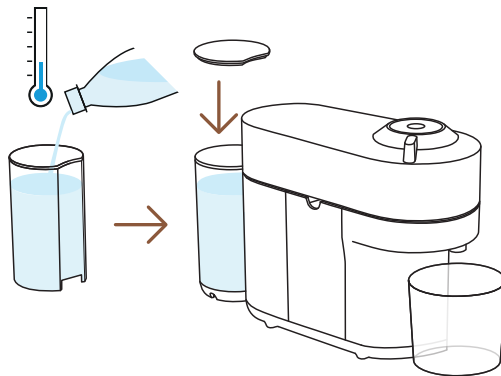

- 9** Am Ende des Entkalkungsvorgangs ist es erforderlich, die Maschine zu spülen. Spülen Sie den Wassertank und die Tropfschale gründlich aus.

Füllen Sie den Wassertank mit frischem Trinkwasser auf und setzen Sie ihn wieder an der Maschine ein. Entleeren Sie den Behälter und stellen Sie ihn wieder unter den Kaffeeauslauf.

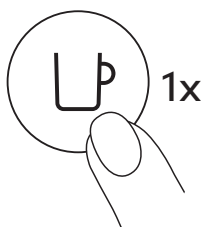

- 10** Drücken Sie den Knopf, um den Spülvorgang zu starten. Wenn der Knopf nicht mehr schnell blinkt, sondern konstant leuchtet, ist der Entkalkungsvorgang abgeschlossen.

- i** Die Maschine stoppt automatisch, sobald der Vorgang abgeschlossen ist.

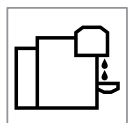
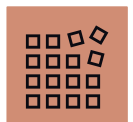

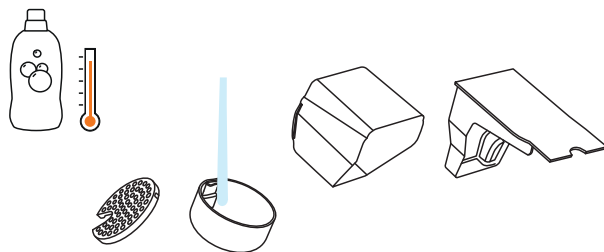

- 11** Reinigen Sie den Kapselbehälter, die Tassenhalterung und die Tropfschale mit heißem Wasser und einem milden, geruchlosen Reinigungsmittel.

**ACHTUNG:** Verwenden Sie keine starken oder scheuernden Reiniger oder Lösungsmittel. Geben Sie die Maschine nicht in die Spülmaschine. Tauchen Sie die Maschine oder Teile davon niemals in Wasser ein.

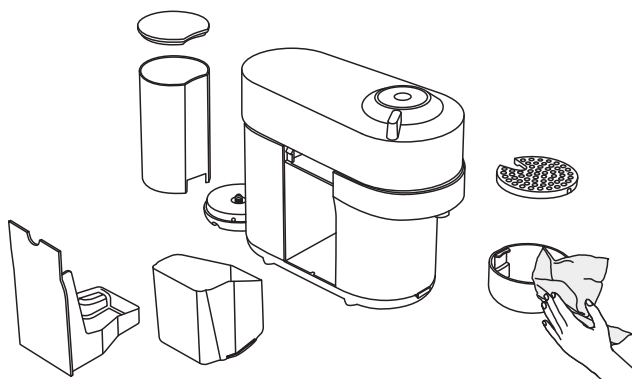

- 12** Trocknen Sie die Maschine mit einem sauberen und trockenen Tuch ab. Lassen Sie die Maschine 10 Minuten trocknen, bevor Sie sie wieder in Betrieb nehmen.

**HINWEIS:** Während des Reinigungsvorgangs kann sich Wasser im Maschinenkopf ansammeln. Wenn dies der Fall ist, trocknen Sie die sichtbaren Teile mit einem sauberen, trockenen Tuch ab.

**HINWEIS:** Die Maschine kann erst nach der Zubereitung von 30 oder mehr Kaffees in den Entkalkungsmodus wechseln.

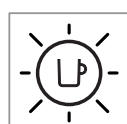
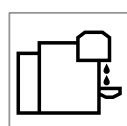
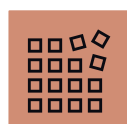
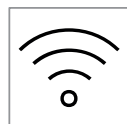

## ENTLEERUNG

Das System sollte vor längerem Nichtgebrauch, zum Schutz vor Frost oder vor dem Einsenden der Maschine zur Reparatur entleert werden.

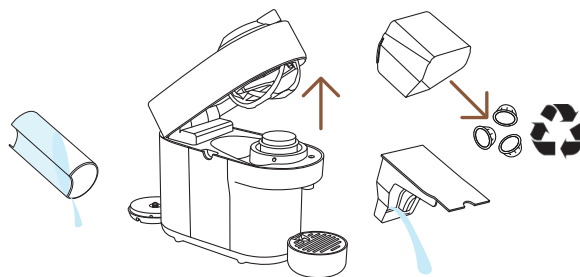

- 1 Entleeren Sie den Wassertank und öffnen Sie den Maschinenkopf, um die gebrauchte Kapsel auszuwerfen. Entleeren Sie den Kapselbehälter und die Tropfschale. Vergessen Sie nicht, Ihre **Nespresso** Kapseln zu recyceln.\*

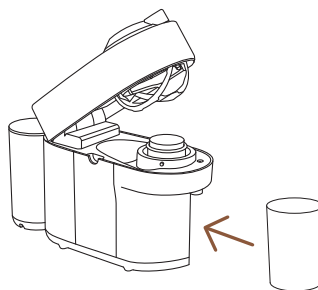

- 2 Setzen Sie sie wieder an der Maschine ein, entfernen Sie die Tassenhalterung und stellen Sie einen leeren Behälter (0,5 l) unter den Kaffeeauslauf.

\*DAS IST **NESPRESSO**. DAS IST RECYCELBAR. Weitere Informationen über das Recycling von **Nespresso** Kapseln finden Sie unter: [www.nespresso.com](http://www.nespresso.com)

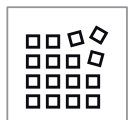

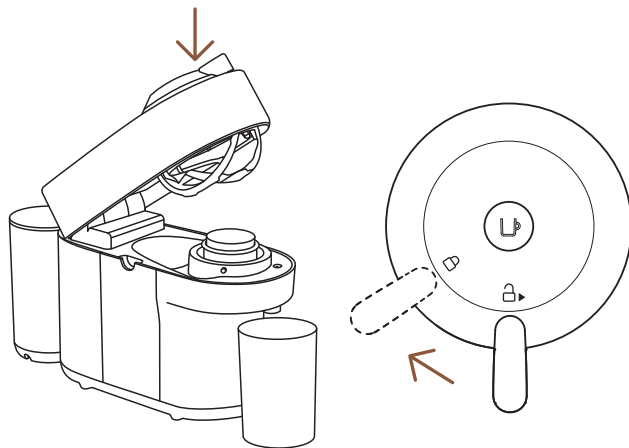

- 3** Drehen Sie bei angeschlossener und eingeschalteter Maschine den Hebel in die Verriegelungsposition.

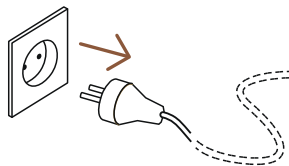

- 4** Ziehen Sie den Stecker aus der Steckdose.

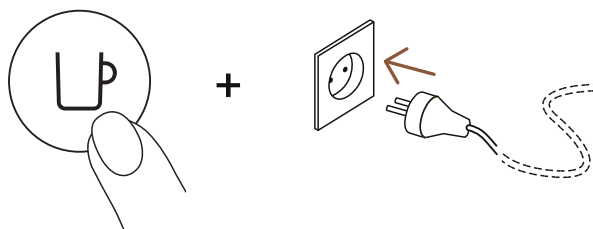

- 5** Drücken und halten Sie den Knopf gedrückt, während Sie den Stecker wieder einstecken.

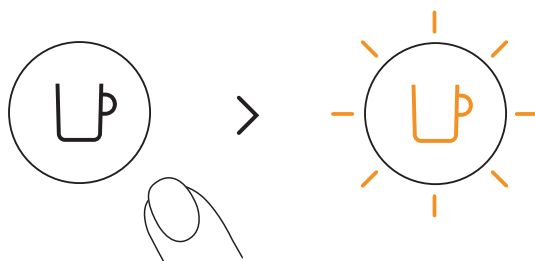

- 6** Lassen Sie den Knopf los. Er blinkt orange und die Entleerung wird gestartet.

- i** Es dauert ca. 30 Sekunden, bis der Entleerungsvorgang abgeschlossen ist. Die Maschine schaltet sich automatisch aus, wenn sie leer ist.

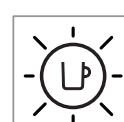
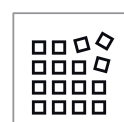
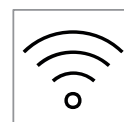

## AUF WERKSEINSTELLUNGEN ZURÜCKSETZEN

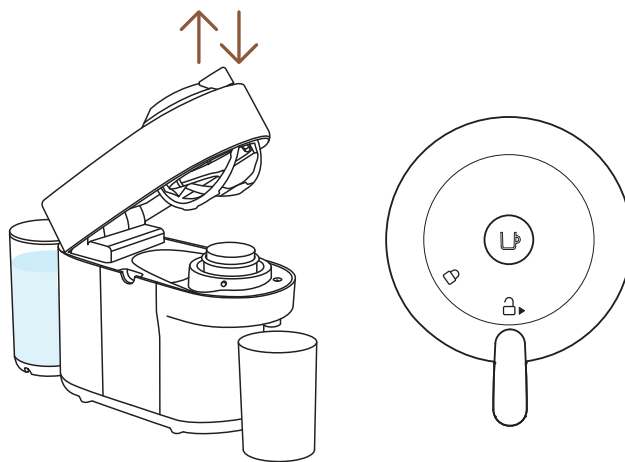

- 1 Öffnen und schliessen Sie den Maschinenkopf bei eingesteckter Maschine und belassen Sie den Hebel in der **Entriegelungsposition**.

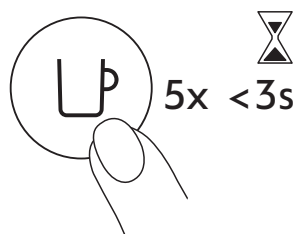

- 2 Drücken Sie den Knopf 5 Mal innerhalb von 3 Sekunden. Die Maschine ist nun mit den Werkseinstellungen programmiert.

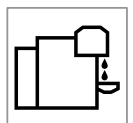
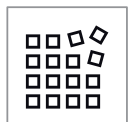

## BEDEUTUNG DER BLINKENDEN LED

Sie möchten mehr über die blinkende LED der **Vertuo Pop** erfahren? Sehen Sie sich das folgende Video an:



## FEHLERBEHEBUNG

### Der Knopf leuchtet nicht.

- Die Maschine hat sich automatisch ausgeschaltet; drücken Sie den Knopf oder “ENTRIEGELN” Sie die Maschine.
- Prüfen Sie das Stromnetz, den Stromstecker, die Spannung und die Sicherung.

### Kein Kaffee, kein Wasser.

- Prüfen Sie, ob der Wassertank gefüllt ist.
- Stellen Sie sicher, dass eine unbenutzte Kapsel in der richtigen Position eingelegt und der Hebel korrekt geschlossen ist, und drücken Sie den Knopf, um zu beginnen.
- Entkalken Sie wenn nötig.
- Öffnen Sie den Maschinenkopf und lassen Sie die Kapsel auswerfen. Führen Sie dann eine Reinigung gemäss dem Abschnitt “Reinigung” durch.

### Der Kaffee ist nicht heiss genug.

- Wärmen Sie die Tasse mit heissem Leitungswasser vor.
- Entkalken Sie wenn nötig.

### Undichtigkeit oder ungewöhnlicher Kaffeefluss.

- Stellen Sie sicher, dass der Wassertank richtig positioniert ist.
- Entkalken Sie wenn nötig.

### Maschine schaltet sich AUS.

- Die Maschine schaltet sich nach 2 Minuten der Nichtnutzung aus, um Energie zu sparen.
- Sie können die Maschine jederzeit manuell ausschalten (wenn sie nicht benutzt wird), indem Sie den Knopf 3 Sekunden lang gedrückt halten.

### Kaffeersatz in der Tasse.

- Führen Sie zwei Mal den Reinigungsvorgang durch.
- Folgen Sie dazu den Schritten im Abschnitt “Reinigung”.

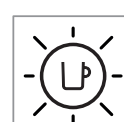
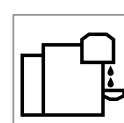
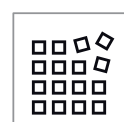
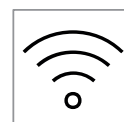

**Die Maschine startet nicht und das Licht ist konstant an. Wenn es blinkt, schauen Sie sich die folgenden Punkte an.**

**Die Maschine startet nicht und das Licht blinkt abwechselnd; 1x Blinken und 1x Pause.**

**Licht blinkt, während die Maschine läuft.**

**Licht blinkt und die Maschine läuft nicht.**

- Stellen Sie sicher, dass der Hebel korrekt verriegelt ist.
- Wenn Sie einen Kaffee oder Espresso zubereiten möchten, achten Sie darauf, dass eine unbenutzte Kapsel richtig eingelegt wurde und der Hebel richtig verriegelt ist. Drücken Sie dann den Knopf, um die Zubereitung zu beginnen.
- Bevor Sie das System reinigen, entkalken oder entleeren, stellen Sie sicher, dass keine Kapsel eingelegt ist, schliessen und verriegeln Sie dann die Maschine und drücken Sie den Knopf, um die gewünschte Aktion zu starten.
- Füllen Sie den Wassertank und drücken Sie den Knopf, um zu starten.
- Stellen Sie sicher, dass der Hebel korrekt verriegelt ist.
- Wenn der Kaffee normal fließt, bedeutet dies, dass die Maschine korrekt funktioniert.
- Wenn nur Wasser fließt, bedeutet dies, dass die Maschine gerade eine vom Benutzer gestartete Aktion (Reinigung, Entkalkung oder Entleerung) durchführt. Schauen Sie sich das entsprechende Kapitel an.
- Schalten Sie die Maschine AUS, indem Sie den Knopf für 3 Sekunden gedrückt halten, drücken Sie ihn dann erneut, um die Maschine AN zu schalten. Warten Sie nun etwa 20 Minuten, damit die Maschine nach intensiver Nutzung abkühlen kann.
- Es wird einige Zeit dauern, bevor der Kaffee fließt (bedingt durch das Lesen des Barcodes und das Anfeuchten des Kaffees).
- Stellen Sie sicher, dass eine unbenutzte Kapsel in der richtigen Position eingelegt und der Hebel korrekt geschlossen ist und drücken Sie den Knopf, um zu beginnen.
- Füllen Sie den Wassertank und drücken Sie den Knopf, um zu starten.
- Schalten Sie die Maschine AUS, indem Sie den Knopf für 3 Sekunden gedrückt halten, drücken Sie ihn dann erneut, um die Maschine AN zu schalten. Warten Sie nun etwa 20 Minuten, damit die Maschine nach intensiver Nutzung abkühlen kann.

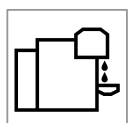



**Licht blinkt  
abwechselnd 2x Blinken  
und 1x Pause. Maschine  
läuft nicht.**

- Bei gewöhnlicher Zubereitung von Kaffee/ Espresso:
  - 1) Entriegeln Sie den Hebel und öffnen Sie den Maschinenkopf, um zu prüfen, ob eine unbenutzte, unbeschädigte Kapsel in richtiger Position eingelegt ist.
  - 2) Prüfen Sie, ob der Hebel in der “VERRIEGELT” Position steht.
  - 3) Prüfen Sie, ob der Wassertank gefüllt ist.
- Während der Entkalkung, Entleerung oder Reinigung:
  - 1) Stellen Sie sicher, dass die Kapsel ausgeworfen ist.
  - 2) Prüfen Sie, ob der Hebel in der “VERRIEGELT” Position steht.
- Während der Füllmengen-Programmierung:
  - 1) Stellen Sie sicher, dass die Kapsel richtig eingelegt ist.
  - 2) Schauen Sie sich das entsprechende Kapitel **“Tassenfüllmenge anpassen”** an.
- Wenn das Problem weiterhin besteht:
  - 1) Entriegeln Sie den Hebel und öffnen Sie den Maschinenkopf.
  - 2) Ersetzen Sie die Kapsel (sofern nötig).
  - 3) Ziehen Sie den Stromstecker aus der Steckdose und stecken Sie ihn nach 10 Sekunden erneut ein.
  - 4) Schliessen Sie den Maschinenkopf und drücken Sie den Knopf, um die Maschine einzuschalten und erneut, um den Brühvorgang zu starten. Wenn das Problem weiterhin besteht, kontaktieren Sie **Nespresso**.

**Licht blinkt  
abwechselnd 3x und  
bleibt dann konstant  
an.**

- Entkalkung erforderlich: Die Maschine kann nach diesem Alarm nur noch einige Male benutzt werden, bis die Entkalkung zwingend erforderlich ist.

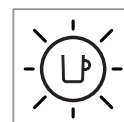
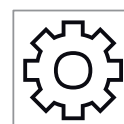
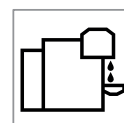
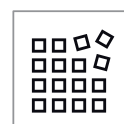
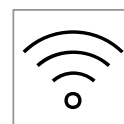

## SPEZIFIKATIONEN

<b>Leistung</b>	<b>~220–240 V, 50–60 Hz, 1300–1500 W</b> <b>US, CA:</b> 120 V, 60 Hz, 1500 W <b>MX:</b> 127 V~, 60 Hz, 1380 W
<b>Frequenz</b>	2.402–2.480 GHz
<b>RF-Ausgangsleistung (EIRP)</b>	Bluetooth 4 dBm max. EIRP und WLAN <20 dMm max. EIRP
<b>Standby</b>	0,39 W/h
<b>Energiesparmodus</b>	Automatische Abschaltung: 2 min
<b>Aufheizdauer</b>	30 Sekunden (bei geschlossenem und verriegeltem Maschinenkopf)
<b>Bewegliche Tassenhalterung für grosse Rezepte</b>	Abnehmbare Einzelposition
<b>Kabellänge ab Maschine</b>	75 cm
<b>Masse (B x T x H)</b>	13,6 x 42,6 x 25 cm
<b>Gewicht</b>	3,5 kg
<b>Fassungsvermögen Wassertank</b>	0,6 l
<b>Fassungsvermögen Kapselbehälter</b>	8 Espresso-Kapseln oder 5 Mug-Kapseln

## MASCHINEN-CODES

Nespresso	Breville	Delonghi
GCV2, GDV2	BNV120, BNV150	ENV90
Krups	Magimix	
XN9201, XN9204, XN9205, XN9211	M800	

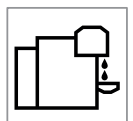
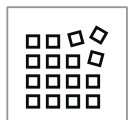

# CLICCA E SELEZIONA LA TUA LINGUA

IT



**SICUREZZA**



**INFORMAZIONI GENERALI**



**CONNETTIVITÀ**



**PRIMO UTILIZZO**



**PREPARAZIONE DEL CAFFÈ**



**ADATTA LA LUNGHEZZA DEL TUO CAFFÈ**



**PULIZIA**



**DECALCIFICAZIONE**



**SVUOTAMENTO DEL SISTEMA**



**RIPRISTINA LE IMPOSTAZIONI DI FABBRICA**



**PANORAMICA DELLE SPIE LUMINOSE**



**RISOLUZIONE DEI PROBLEMI**



**SPECIFICHE TECNICHE**

## SICUREZZA

**ATTENZIONE:** prima di utilizzare la macchina da caffè, leggere le precauzioni di sicurezza per evitare eventuali danni.

### SMALTIMENTO E PROTEZIONE AMBIENTALE

Questa macchina è conforme alla direttiva 2012/19/UE. I materiali dell'imballaggio e il contenuto dell'apparecchio sono materiali riciclabili. La macchina contiene materiali di valore che possono essere recuperati o riciclati. La separazione dei rifiuti rimanenti nei diversi materiali facilita il riciclo delle materie prime preziose. Lasciare l'apparecchio in un'isola ecologica. È possibile ottenere maggiori informazioni contattando le autorità locali.

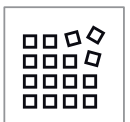

## INFORMAZIONI GENERALI

### PANORAMICA SULLA MACCHINA

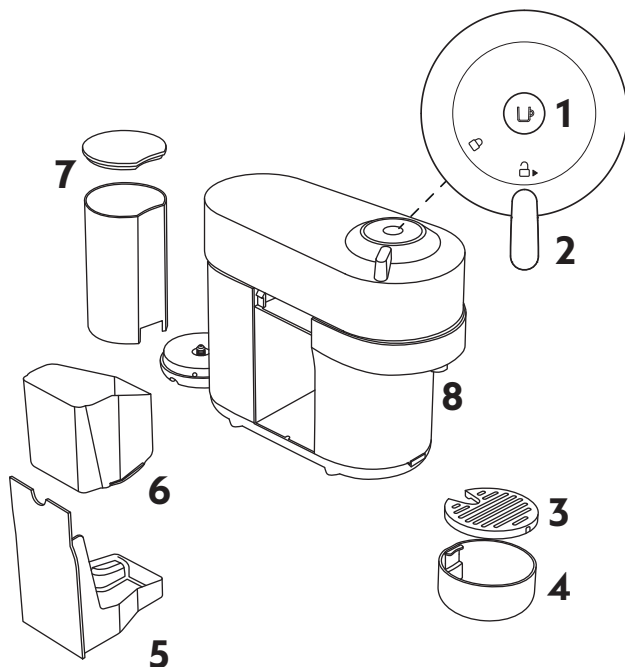

- 1 Tasto ON/OFF e tasto caffè
- 2 Bloccare/Sbloccare la leva
- 3 Griglia raccogliocce
- 4 Supporto per tazze regolabile
- 5 Vaschetta raccogliocce
- 6 Contenitore per capsule usate
- 7 Serbatoio dell'acqua e coperchio
- 8 Erogatore di caffè

### CONTENUTO DELLA CONFEZIONE



- 1 Macchina da caffè
- 2 Set di degustazione capsule **Nespresso**
- 3 Brochure di benvenuto **Nespresso**
- 4 Istruzioni per la sicurezza
- 5 Guida rapida
- 6 Garanzia

**i Apertura della scatola:** potrebbe essere presente della polvere sulla superficie della macchina per via dei materiali riciclati utilizzati nella confezione. Non è dannoso, è sufficiente pulire con un panno morbido.

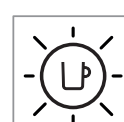
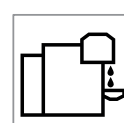
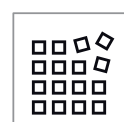
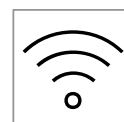

## APRI/CHIUDI

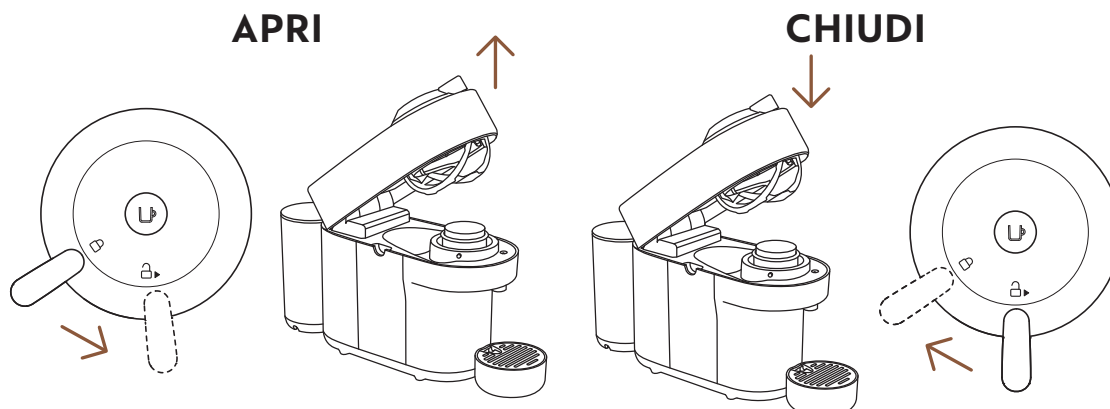

**ATTENZIONE:** Per un corretto utilizzo della macchina, non aprire la testa della macchina durante l'erogazione del caffè, ma attendere che il tasto del caffè torni a essere bianco fisso. Se si desidera interrompere prima l'erogazione, premere una volta il tasto del caffè e attendere che la macchina si arresti prima di aprire la testa.

## IL SISTEMA VERTUO

### COMPATIBILITÀ DELLE CAPSULE



**S**

**Ristretto**  
(25 ml)

**Espresso**  
(40 ml)



**M**

**Double espresso**  
(80 ml)

**Gran Lungo**  
(150 ml)



**L**

**Mug**  
(230 ml)



**XL**

**Alto, Cold Brew Style**  
(355 ml)

**Carafe**  
(535 ml)

### COMPATIBILITÀ DEGLI ACCESSORI



Compatibilità degli accessori



**Ristretto**



**Espresso**



**Double Espresso**



**Gran Lungo**



**Mug (S)**



**Mug (M)**



**Bicchieri Reveal**



Accessori non compatibili



**Mug (L)**



**Caraffa**

Scopri la collezione di accessori completa sul sito

[www.nespresso.com](http://www.nespresso.com)

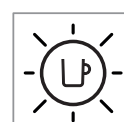
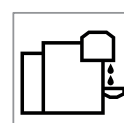
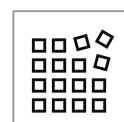
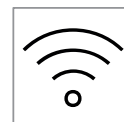

## ON/OFF

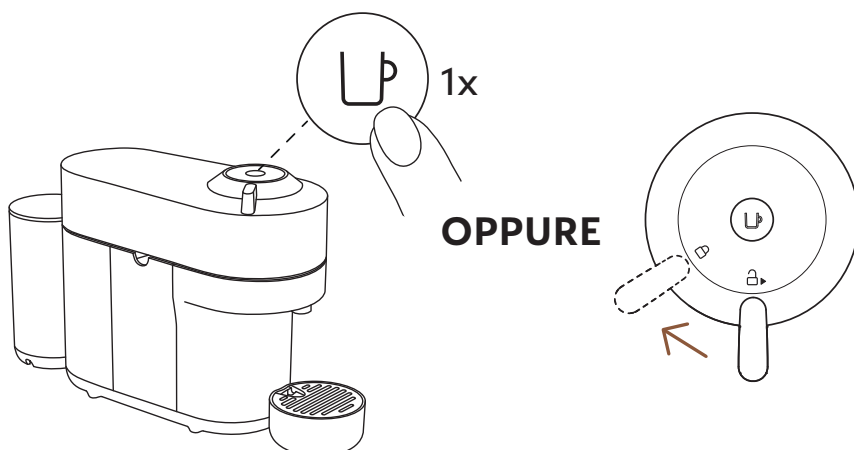
**ON**

Una volta che la spina è inserita, accendi la macchina premendo il tasto una volta o chiudendo la leva in posizione di blocco (con la testa della macchina chiusa).

- i** La luce lampeggerà per 30 secondi mentre la macchina si scalda. Una volta che la luce è ferma, la macchina è pronta per essere usata.

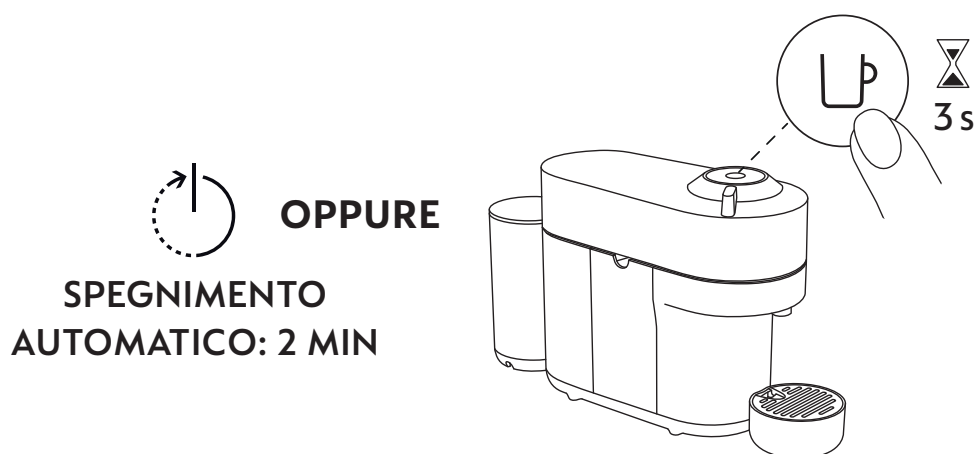

**SPEGNIMENTO  
AUTOMATICO: 2 MIN**

**OFF**

Per risparmiare energia la macchina entrerà automaticamente in modalità spegnimento automatico dopo 2 minuti di inutilizzo.

- i** La macchina può essere spenta manualmente in ogni momento (quando non in uso) tenendo premuto il tasto per 3 secondi.

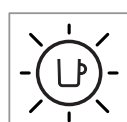
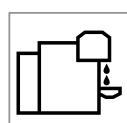
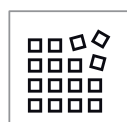
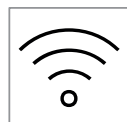

## CONNETTIVITÀ

### PERCHÉ DOVRESTI SINCRONIZZARE LA TUA VERTUO POP?

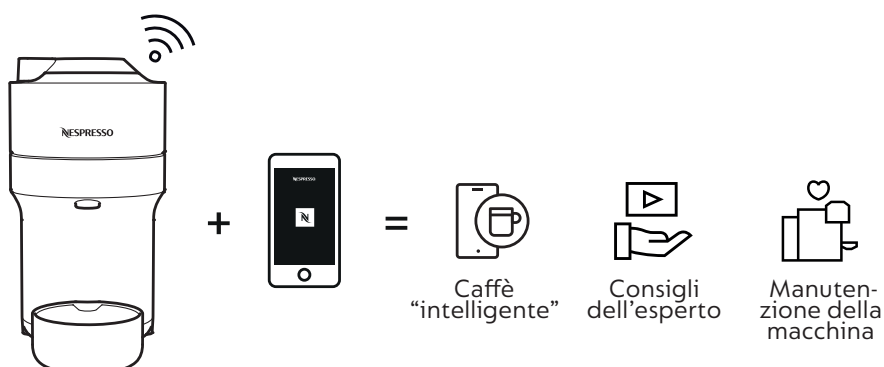

### I BENEFICI DI CONNETTERE LA TUA MACCHINA VERTUO POP

- **Caffè "intelligente":** Rimani sempre un passo avanti per ottenere le ultime innovazioni sul caffè di **Nespresso**, mantenendo la tua macchina in condizioni ottimali e aggiornata.
- **Consigli dell'esperto:** Ricevi assistenza e semplici video tutorial per accompagnare il tuo viaggio nel caffè tramite il tuo smartphone.
- **Manutenzione della macchina:** Ricevi una notifica immediata su come e quando effettuare la manutenzione della macchina con una guida semplice su decalcificazione, risciacquo, pulizia, ecc.

### COME CONNETTERE LA TUA MACCHINA VERTUO POP?

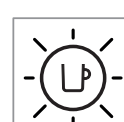
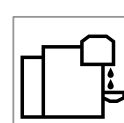
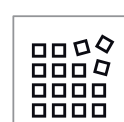



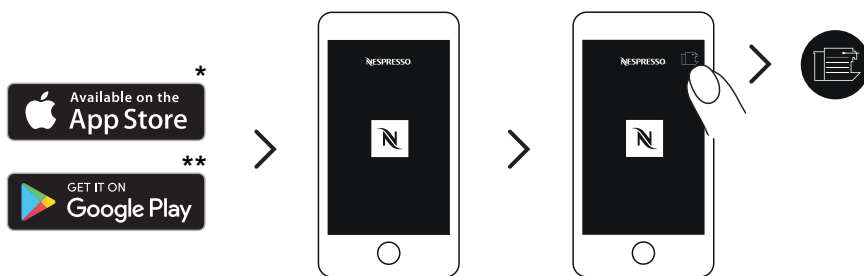

**1** Scarica o aggiorna l'app **Nespresso**. Avvia l'app **Nespresso** sullo smartphone o sul tablet. Premi l'icona della macchina in alto a destra sullo schermo.

**NOTA:** Per ottenere prestazioni ottimali e un'esperienza senza interruzioni, si consiglia di collegare la macchina ad un router Wi-Fi piuttosto che utilizzare un hotspot dello smartphone.

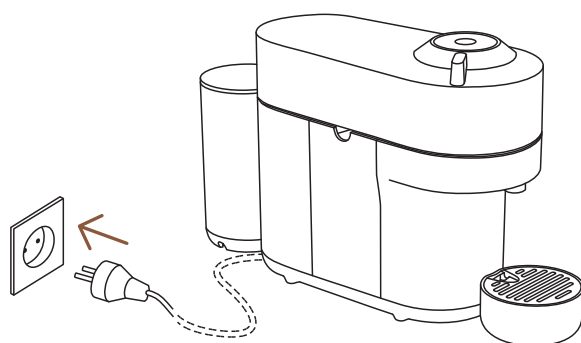

**2** Inserisci la presa di alimentazione.



**3** Segui le istruzioni tramite l'app **Nespresso**.

**ATTENZIONE:** Leggere prima le istruzioni di sicurezza per evitare rischi fatali di shock elettrico e incendio. Assicurati della continuità della messa a terra quando colleghi la macchina alla presa di corrente.

\*App Store® è un marchio di Apple Inc., registrato negli Stati Uniti ed in altri paesi.

\*\*Google Play ed il logo Google Play sono marchi registrati di Google LLC.

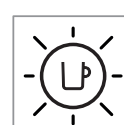
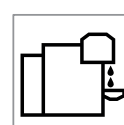
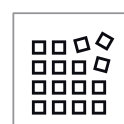

## DISABILITA IL BLUETOOTH E IL WI-FI

La macchina è equipaggiata con un modulo di connettività, attivato di default. Dà accesso a delle funzioni aggiuntive, migliorando l'esperienza caffè. Per disattivare il modulo di connettività, segui i seguenti passaggi:

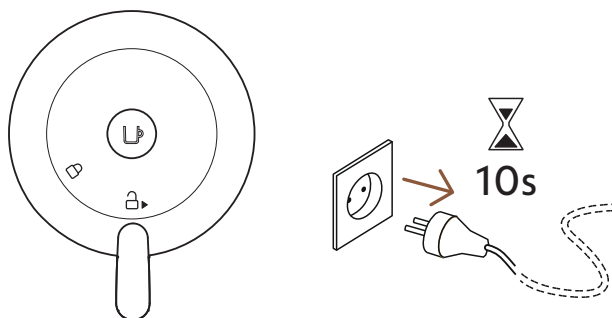

- 1 Con la macchina chiusa e la leva in **posizione di sblocco**, stacca la macchina per almeno 10 secondi.

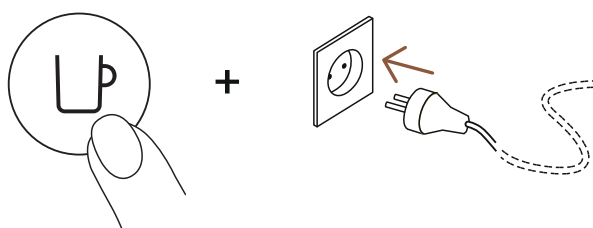

- 2 Schiaccia e premi il tasto mentre inserisci la spina. Il tasto lampeggerà in arancione per confermare che il modulo per la connettività sia stato disabilitato.
- i** Segui i medesimi passaggi per configurare di nuovo il modulo di connettività. Il tasto lampeggerà in bianco per confermare che il modulo si è riattivato.

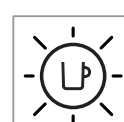
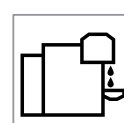
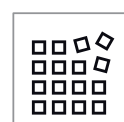

## PRIMO UTILIZZO

### PRIMO RISCIACQUO

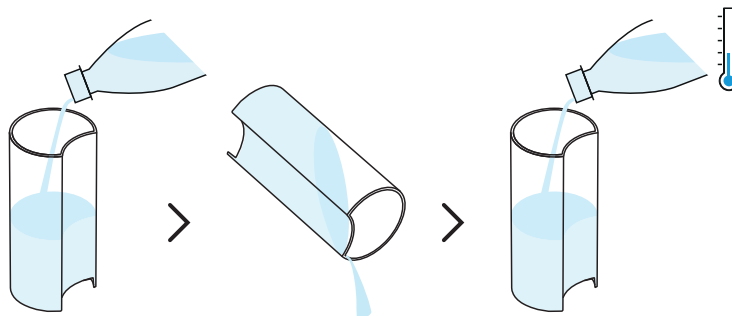

- 1** Sciacqua e pulisci il serbatoio dell'acqua e il coperchio prima di riempirlo con acqua potabile fresca.

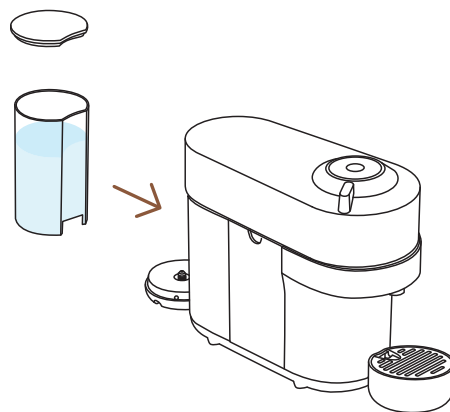

- 2** Chiudi il serbatoio dell'acqua con il coperchio e posiziona il serbatoio dell'acqua, accertandoti che sia fissato correttamente.

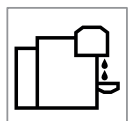
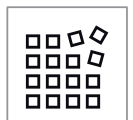

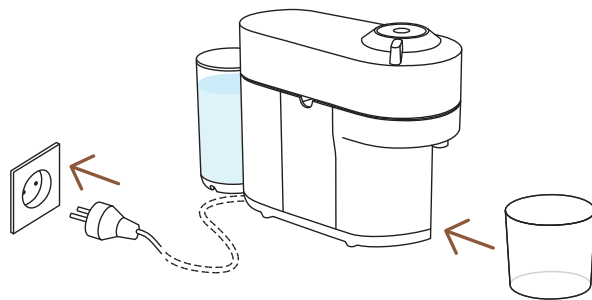

- 3** Con la macchina inserita, rimuovi il supporto per tazze e posiziona un contenitore vuoto (di almeno 1 l) sotto l'erogatore del caffè.

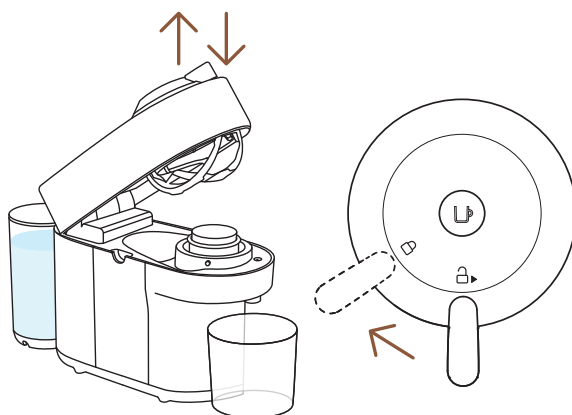

- 4** Apri e chiudi la macchina. Assicurati che la leva sia nella posizione di blocco.
- i** La luce lampeggerà mentre la macchina si scalda. Ci vorranno circa 30 secondi. Quando la luce diventerà fissa la macchina sarà pronta. Assicurati che non ci siano capsule inserite.

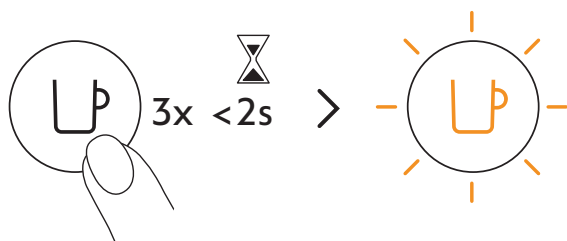

- 5** Premi il tasto 3 volte entro 2 secondi per iniziare il risciacquo. Mentre la luce lampeggia in arancione, lascia che la procedura di risciacquo si concluda automaticamente. Quando la luce diventa bianca ferma, il ciclo è completo.
- i** La procedura dovrebbe impiegare meno di 2 minuti prima che il processo di risciacquo inizi e l'acqua cominci a scendere. La procedura potrebbe durare fino a 7 minuti.

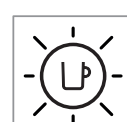
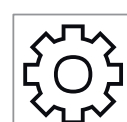
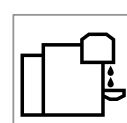
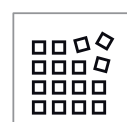
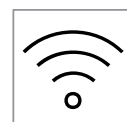

# PREPARAZIONE DEL CAFFÈ

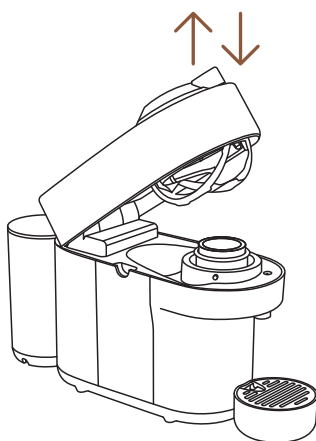

**1** Apri e chiudi la macchina.

**i** Il tasto del caffè inizierà a lampeggiare mentre la macchina si sta riscaldando. Quando la luce diventa fissa, la macchina è pronta all'uso.

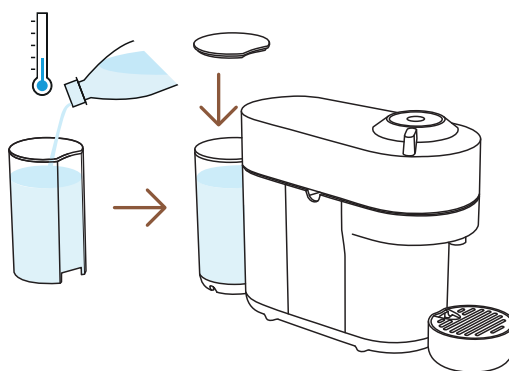

**2** Riempi il serbatoio con acqua fresca potabile e rimettilo in posizione.

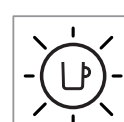
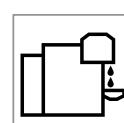
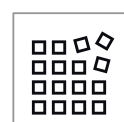
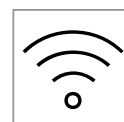

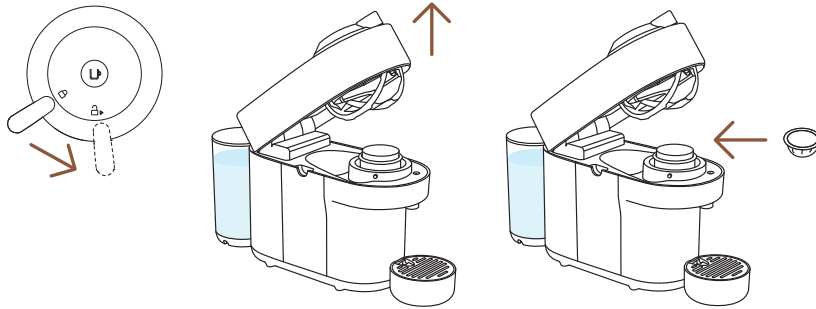

- 3** Sblocca e apri completamente la testa della macchina e inserisci una capsula **Vertuo** con la forma a cupola rivolta verso il basso.

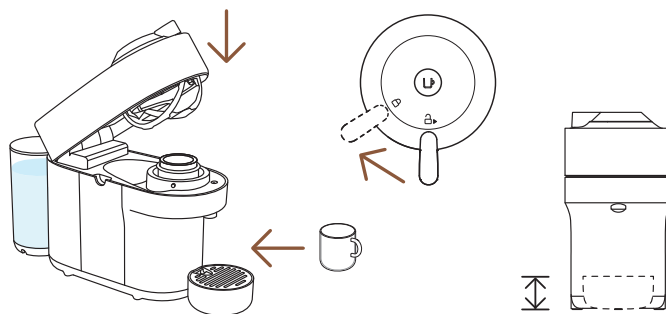

- 4** Chiudi la testa della macchina con la leva a sinistra fino alla posizione di blocco e metti una tazza. Il supporto per tazze può essere regolato a seconda della dimensione della tua tazza.

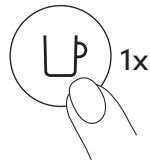

- 5** Inizia l'erogazione premendo il tasto una volta.

**ATTENZIONE:** Per un corretto utilizzo della macchina, non aprire la testa della macchina durante l'erogazione del caffè, ma attendere che il tasto del caffè torni a essere bianco fisso. Se desideri interrompere prima l'erogazione, premi una volta il tasto del caffè e attendi che la macchina si arresti prima di aprire la testa.

- i** A causa della lettura del codice, della preumidificazione del caffè e del tempo di infusione, ci vorrà qualche secondo prima che il caffè inizi a scorrere. La macchina riconosce automaticamente la capsula inserita e seleziona i parametri di preparazione del caffè e la lunghezza della tazza definiti dagli esperti di caffè **Nespresso** per estrarre in maniera ottimale la miscela di caffè.

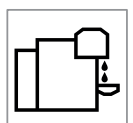

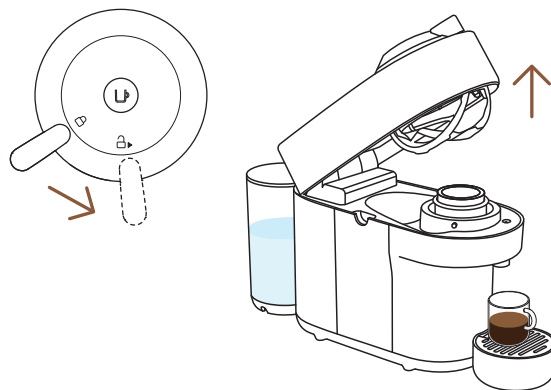

- 6** Quando l'erogazione del caffè termina, apri la testa della macchina ruotando la leva a destra verso la posizione di sblocco per espellere automaticamente la capsula e gusta il tuo caffè.



- 7** Non dimenticarti di riciclare la tue capsule **Nespresso**.\*

\*È **NESPRESSO**. È RICICLABILE. Per ulteriori informazioni, visita [www.nespresso.com](http://www.nespresso.com)

## SCOPRI LA MODALITÀ CREAZIONI DI CAFFÈ



Con questa macchina, **Nespresso** offre una funzione specifica per concentrare le estrazioni di caffè e creare le tue ricette.

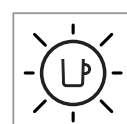
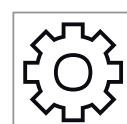
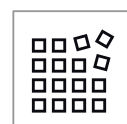
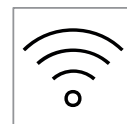

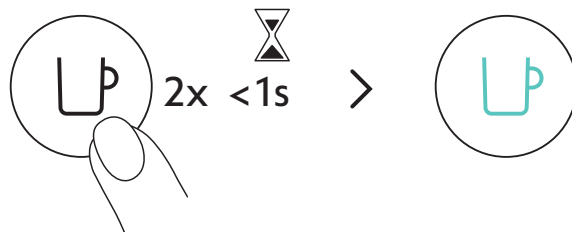

Con la macchina accesa, premi 2 volte il tasto del caffè.  
Lampeggerà di colore turchese e l'erogazione del caffè sarà concentrata, ottimizzando il gusto del caffè nelle ricette con aggiunte (latte, panna, ghiaccio...). Per un'esperienza caffè incomparabile.

40 ml	80 ml	150 ml	230 ml	355 ml	535 ml
✓	✓	✓	✓	✗	✗
25 ml	40 ml	40 ml	80 ml		

Per godere appieno dei benefici, si consiglia di preparare la gamma Coffee+ utilizzando solo i formati ufficiali delle tazze. Per ottenere i migliori risultati in tazza, si sconsiglia di utilizzare questa modalità per l'erogazione di caffè XL (Alto Ambrato, Alto Onice), Cold Brew Style e Carafe Pour-Over Style.

**NOTA:** Per abilitare questa modalità potrebbe essere necessario un aggiornamento della macchina tramite l'app **Nespresso**.

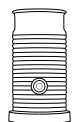

Scopri come aggiornare la tua macchina con la gamma Aeroccino su [www.nespresso.com](http://www.nespresso.com)

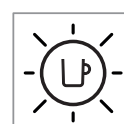
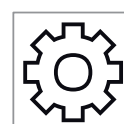
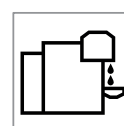
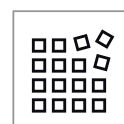
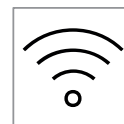



## ADATTA LA LUNGHEZZA DEL TUO CAFFÈ

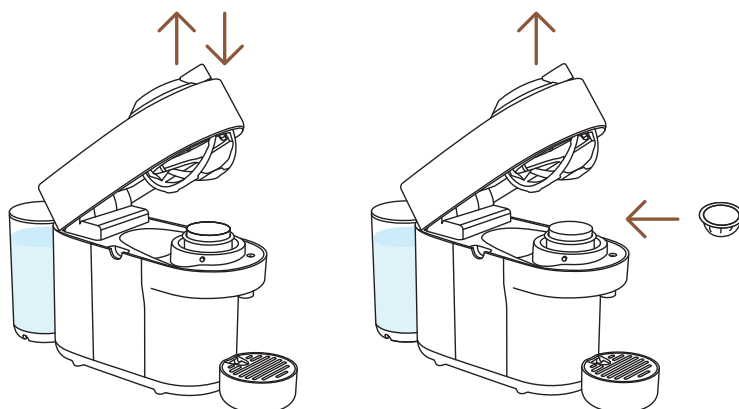

- 1** A macchina accesa, apri la macchina e inserisci la capsula che desideri programmare.

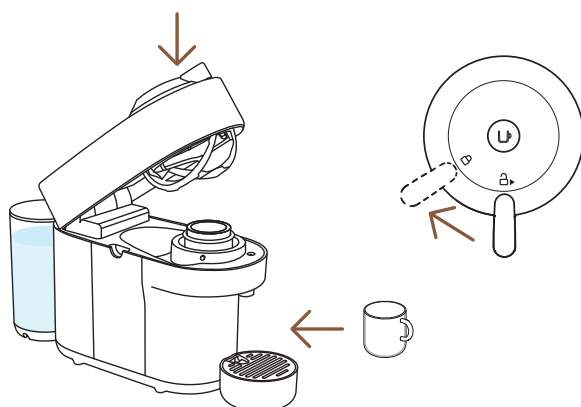

- 2** Chiudi la testa della macchina, ruota la leva a sinistra verso la posizione di blocco e posiziona una tazza.

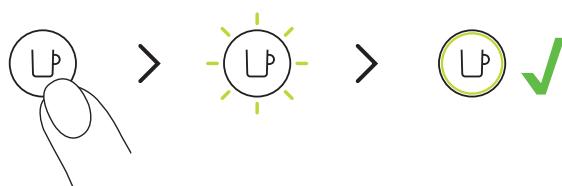

- 3** Tieni premuto il tasto, lascialo qualche secondo prima di raggiungere la quantità desiderata. Il nuovo volume dell'acqua è ora impostato per la tipologia di capsula usata durante il settaggio.

- i** L'erogazione è specifica per ogni tipo di capsula. Le quantità in tazza possono essere programmate da 20 ml a 535 ml.

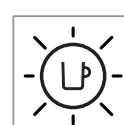
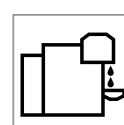
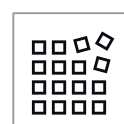
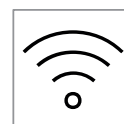

**ATTENZIONE:** Per un corretto utilizzo della macchina, non aprire la testa della macchina durante l'erogazione del caffè, ma attendere che il tasto del caffè torni a essere bianco fisso. Se desideri interrompere prima l'erogazione, premi una volta il tasto del caffè e attendi che la macchina si arresti prima di aprire la testa.

**NOTA:** Una volta che l'utente ha programmato un volume specifico, ogni volta che il tipo di capsula viene inserito nella macchina, la preparazione si fermerà alla lunghezza della tazza programmata dall'utente. Se desideri tornare ai parametri predefiniti, guarda il paragrafo **“Ripristino delle impostazioni di fabbrica”**.

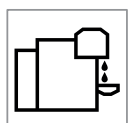

## PULIZIA

Pulisci la tua macchina mensilmente, quando si formano residui di caffè all'interno della testa o dopo un lungo periodo di inutilizzo.

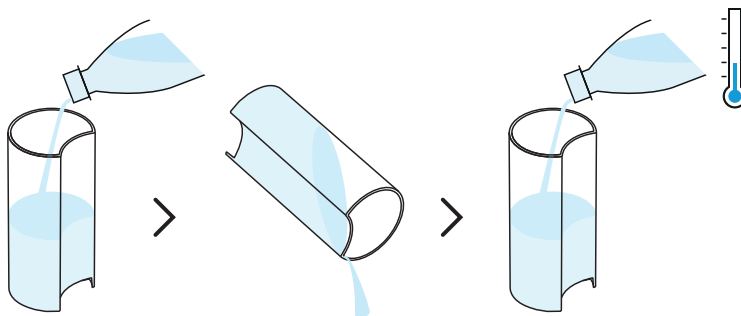

- 1** Sciacqua e pulisci il serbatoio dell'acqua e il coperchio prima di riempirlo con acqua potabile fresca.

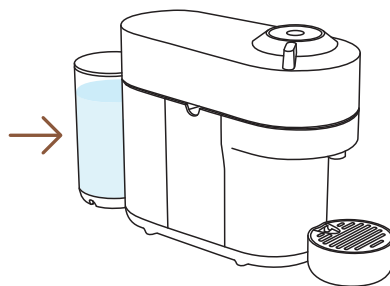

- 2** Rimetti il serbatoio dell'acqua in posizione sulla macchina.

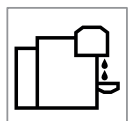
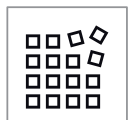

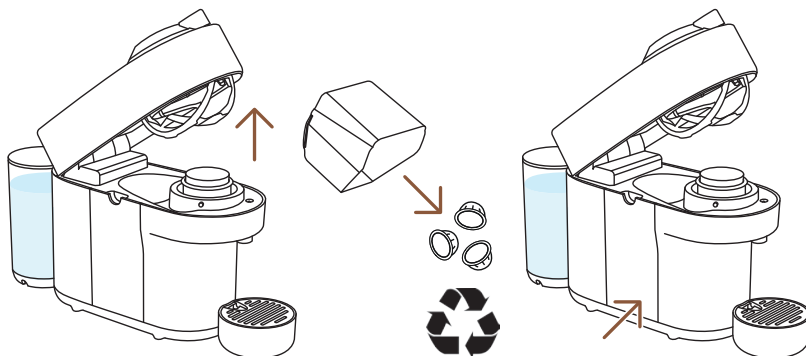

- 3** Con la macchina accesa, sblocca e apri la macchina e lascia che la capsula usata venga espulsa. Svuota e sciacqua il contenitore delle capsule e la vaschetta raccogliogocce e rimettili in posizione. Non dimenticarti di riciclare le tue capsule **Nespresso**.\*

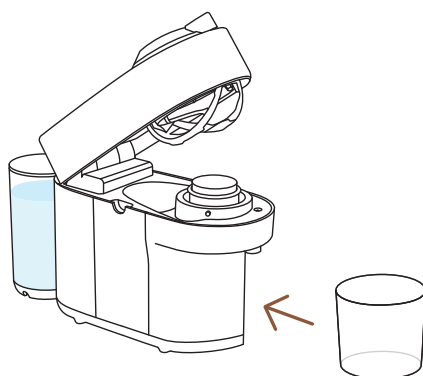

- 4** Rimuovi il supporto per tazze e posiziona un contenitore vuoto (di almeno 1 l) sotto l'erogatore del caffè.

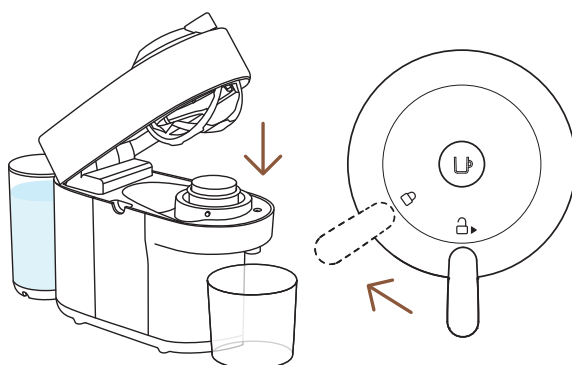

- 5** Chiudi la testa della macchina e ruota la leva a sinistra verso la posizione di blocco. Prima di iniziare la procedura di risciacquo, accertati che nella macchina non siano presenti capsule.

\*È **NESPRESSO**. È RICICLABILE. Per ulteriori informazioni, visita [www.nespresso.com](http://www.nespresso.com)

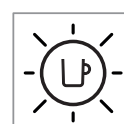
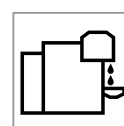
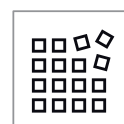
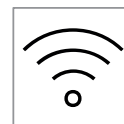

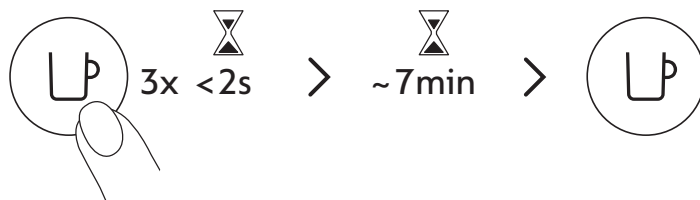

- 6** Premi il tasto 3 volte entro 2 secondi per iniziare il risciacquo. Con la spia arancione lampeggiante, lascia che la procedura di risciacquo si completi automaticamente.

- i** La procedura dovrebbe impiegare meno di 2 minuti prima che inizi il processo di risciacquo e l'acqua cominci a scendere. Questa operazione potrebbe impiegare fino a 7 minuti e si fermerà in automatico quando il ciclo è completo. La procedura può essere interrotta in qualsiasi momento premendo il tasto.

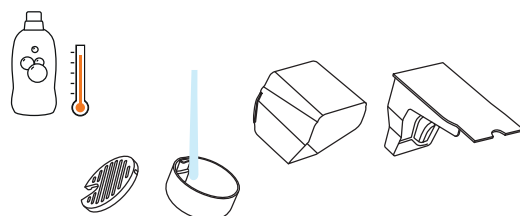

- 7** Lava il contenitore delle capsule, il supporto per tazze e la vaschetta raccogli gocce con acqua calda ed un sapone neutro inodore.

**ATTENZIONE:** Non usare detergenti o solventi forti o abrasivi. Non mettere la macchina nella lavastoviglie. Non immergere l'apparecchio o parte dell'apparecchio in acqua.

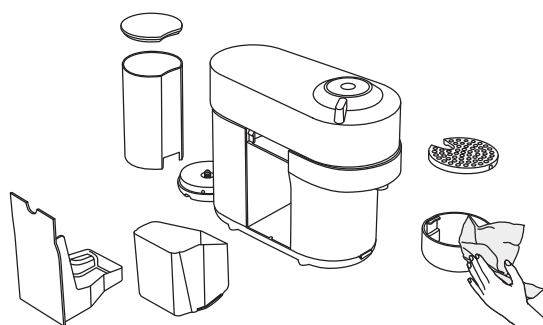

- 8** Asciugare con un panno asciutto e pulito.

**ATTENZIONE:** Pulisci l'erogatore del caffè regolarmente e con un panno umido. Usa sempre panni morbidi per pulire la macchina.

**NOTA:** Durante il risciacquo può accumularsi dell'acqua all'interno della testa; nel caso dovesse accadere si consiglia di asciugare le parti visibili con un panno morbido pulito e asciutto.

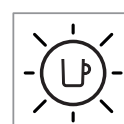
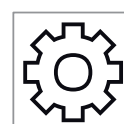
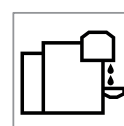
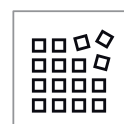
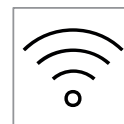

## DECALCIFICAZIONE

Decalcificare la tua macchina assicurerà che funzioni perfettamente durante il suo ciclo di vita e renderà la tua esperienza incomparabile come il primo giorno. La macchina indica quando è necessario effettuare la decalcificazione lampeggiando in arancione per 3 volte prima di diventare bianco fisso.



**i** La procedura di decalcificazione dura circa 20 minuti e **non può essere interrotta**.

**NOTA:** Prima di iniziare, leggere attentamente le istruzioni per la decalcificazione.

### Ti servirà:

- Un kit per la decalcificazione disponibile su [www.nespresso.com](http://www.nespresso.com)
- Un recipiente vuoto (da 1 l)

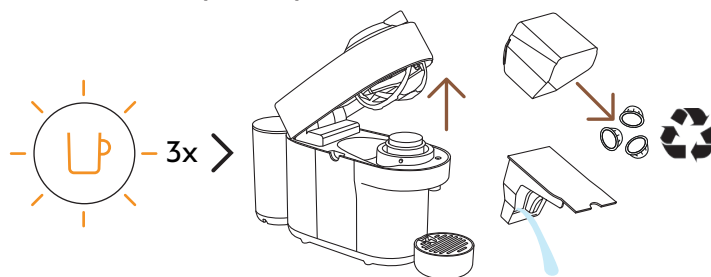

- 1** Quando il tasto lampeggia in arancione 3 volte, sblocca ed apri la testa della macchina e lascia che la capsula usata venga espulsa. Svuota il contenitore delle capsule e la vaschetta raccogliogocce e rimettili in posizione. Non dimenticarti di riciclare la tue capsule **Nespresso**.\*

\*È **NESPRESSO**. È RICICLABILE. Per ulteriori informazioni, visita [www.nespresso.com](http://www.nespresso.com)

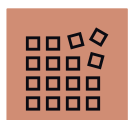

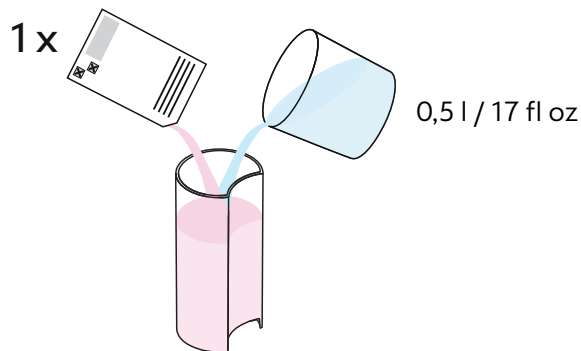

- 2** Riempi il contenitore dell'acqua con 0,5 l di acqua ed aggiungi un'unità di liquido per decalcificazione.

**ATTENZIONE:** Tieni presente che la soluzione decalcificante può essere dannosa. Evita qualsiasi contatto con occhi, pelle e superfici.

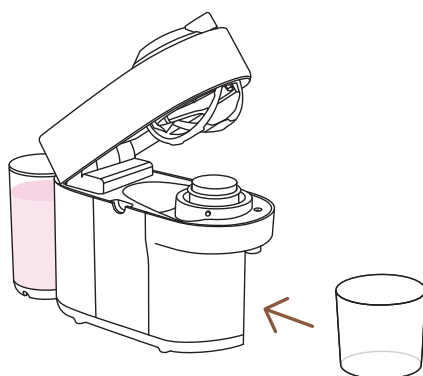

- 3** Rimuovi il supporto per tazze e colloca un recipiente vuoto (di almeno 1 l) sotto l'erogatore del caffè.

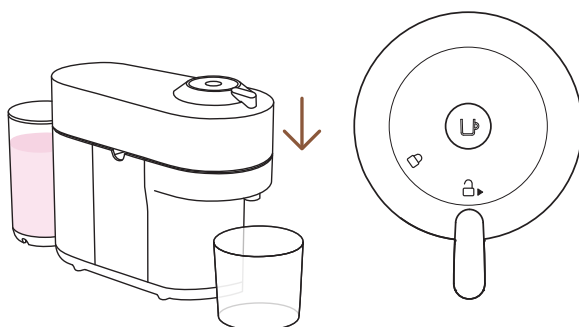

- 4** Con la macchina accesa, chiudi la testa della macchina e lascia la leva in posizione di sblocco.

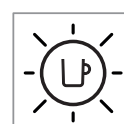
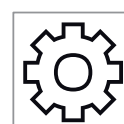
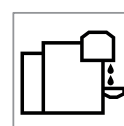
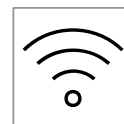

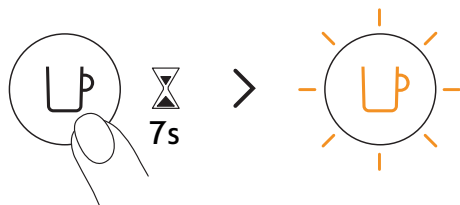

- 5** Tieni premuto il tasto per almeno 7 secondi o fino a quando la luce si accende. Il tasto inizierà a lampeggiare in arancione.

**ATTENZIONE:** Adesso hai 45 secondi per entrare nella modalità decalcificazione, altrimenti la macchina tornerà in modalità erogazione.

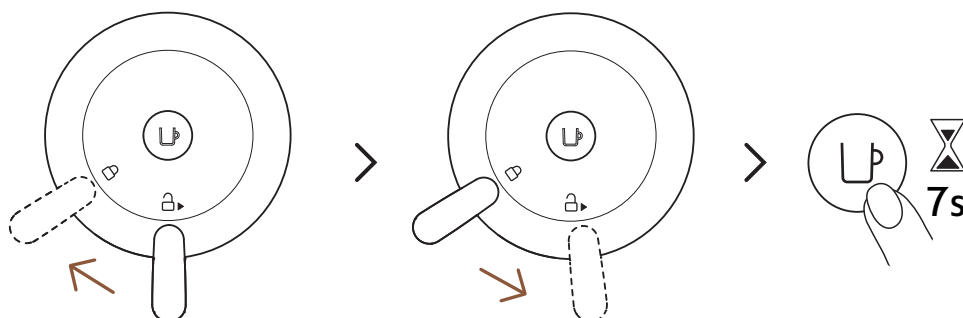

- 6** Blocca la testa della macchina girando la leva verso sinistra fino al simbolo di blocco e dopo sblocca la leva girandola verso destra fino al simbolo di sblocco. Tieni premuto il tasto ancora per circa 7 secondi oppure finché le luci non si spengono. Il tasto inizierà a lampeggiare rapidamente in arancione.

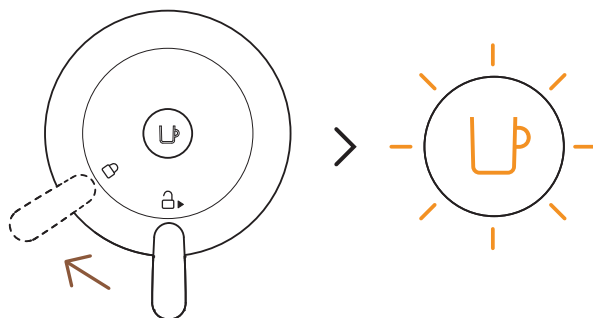

- 7** Per entrare nella modalità decalcificazione, blocca la macchina girando la leva verso sinistra nella posizione di blocco. La luce dovrebbe continuare a lampeggiare in arancione. Questo indica che sei nella modalità decalcificazione.

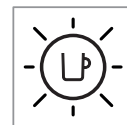
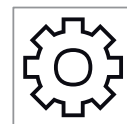
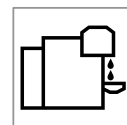
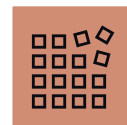
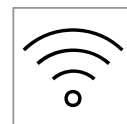



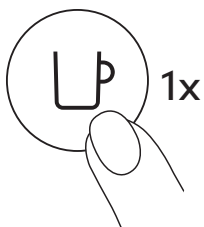

- 8** Premi il tasto del caffè una volta per iniziare il processo di decalcificazione. La luce continuerà a lampeggiare in arancione per tutta la durata del processo.

- i** La macchina si fermerà automaticamente quando la prima fase di decalcificazione sarà completata.

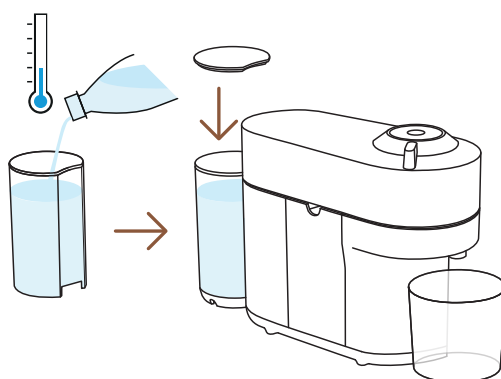

- 9** Alla fine del processo di decalcificazione, è tempo di risciacquare la macchina. Risciacqua adeguatamente il serbatoio dell'acqua e la vaschetta raccogli gocce. Riempi il serbatoio con acqua potabile fresca e rimettilo in posizione. Svuota il contenitore e riposizionalo sotto l'erogatore del caffè.

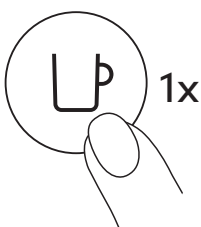

- 10** Premi il tasto del caffè e risciacqua la macchina. Quando il tasto smette di lampeggiare rapidamente e diventa fisso, la procedura di decalcificazione è completata.

- i** La macchina si fermerà automaticamente quando la procedura sarà completata.

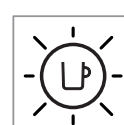
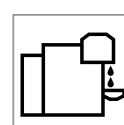
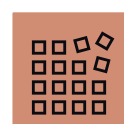
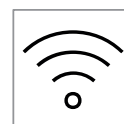

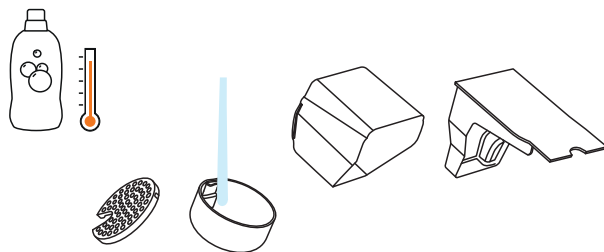

- 11** Lava il contenitore delle capsule, il supporto per tazze e la vaschetta raccogliogocce con acqua calda ed un detergente neutro ed inodore.

**ATTENZIONE:** Non usare nessun tipo di agente per pulizie forte, abrasivo o solvente. Non mettere la macchina in lavastoviglie. Non immergere la macchina o parti di essa in acqua.

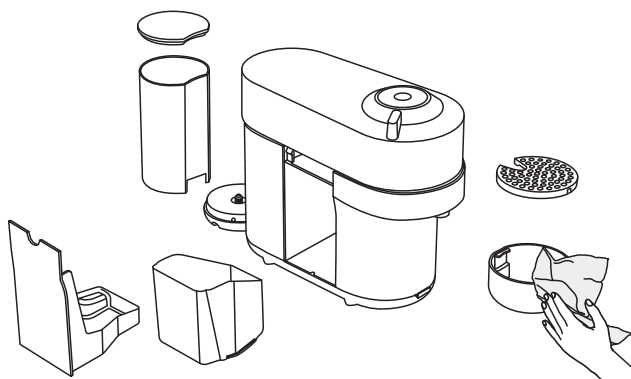

- 12** Asciuga la macchina con un panno pulito e fresco. Lascia asciugare la macchina per 10 minuti prima di usarla.

**NOTA:** L'acqua potrebbe accumularsi nella testa della macchina durante il ciclo di pulizia. Se questo dovesse succedere, asciuga le parti visibili con un panno pulito e secco.

**NOTA:** La macchina può entrare in modalità decalcificazione solo dopo 30 o più caffè erogati.

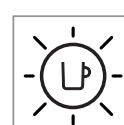
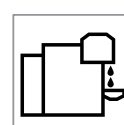
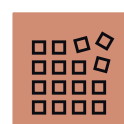
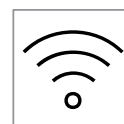

## SVUOTARE IL SISTEMA

Si consiglia di svuotare il sistema prima di un periodo di inutilizzo, come protezione contro il congelamento o prima di mandare in riparazione la macchina.

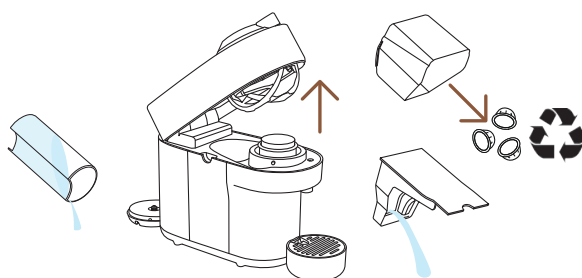

- 1 Svuota il contenitore dell'acqua, apri la testa della macchina e lascia che le capsule usate vengano espulse. Svuota il contenitore delle capsule e la vaschetta raccogliogocce. Non dimenticarti di riciclare la tue capsule **Nespresso**.\*

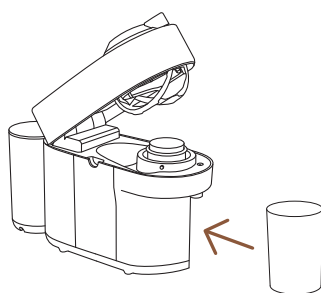

- 2 Riposiziona le parti nella macchina, rimuovi il supporto per tazze e posiziona un contenitore (0,5 l) sotto l'erogatore del caffè.

\*È **NESPRESSO**. È RICICLABILE. Per ulteriori informazioni, visita [www.nespresso.com](http://www.nespresso.com)

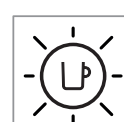
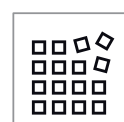
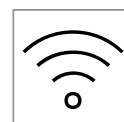

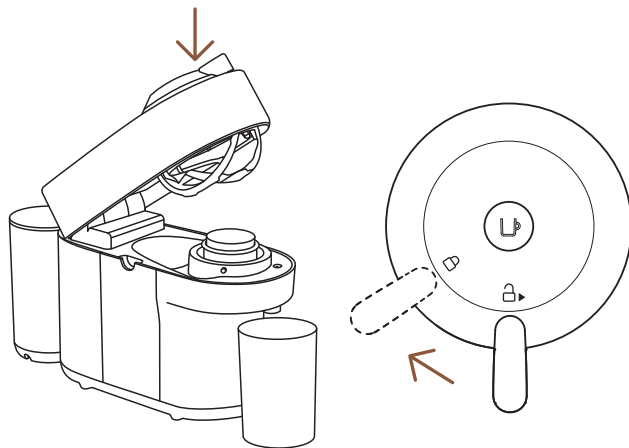

- 3** Con la macchina attaccata alla presa ed accesa, gira la leva verso la posizione di blocco.

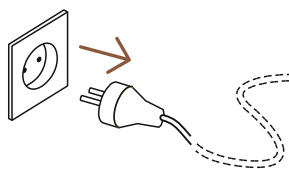

- 4** Scollega la macchina.

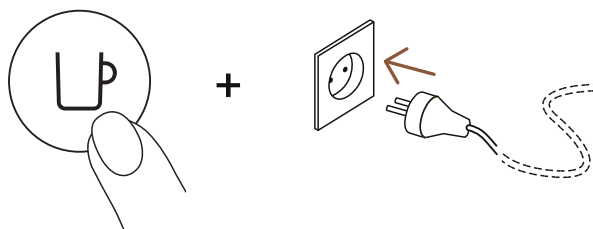

- 5** Schiaccia e premi il tasto mentre inserisci la presa nella spina.

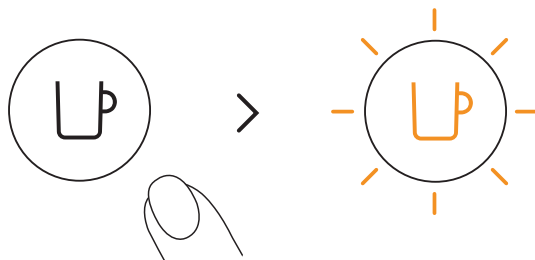

- 6** Rilascia il tasto. Esso lampeggerà in arancione ed il processo di svuotamento avrà inizio.

- i** La macchina ci metterà circa 30 secondi a completare il processo di svuotamento. La macchina si spegnerà automaticamente una volta svuotata.

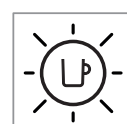
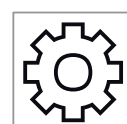
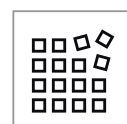
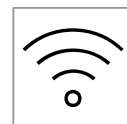

## RIPRISTINARE LE IMPOSTAZIONI DI FABBRICA

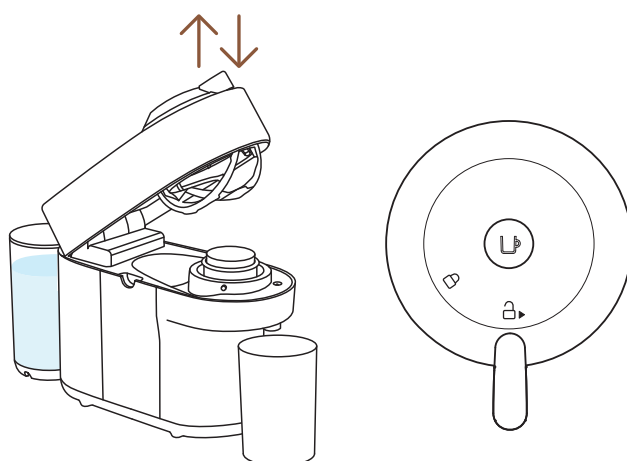

- 1 Con la macchina attaccata alla presa, apri e chiudi la testa della macchina prima di lasciare la leva in **posizione di sblocco**.

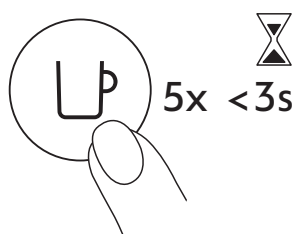

- 2 Premi il tasto 5 volte entro 3 secondi. La macchina ora è ripristinata alle impostazioni di fabbrica.

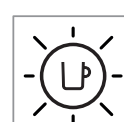
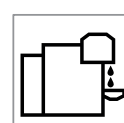
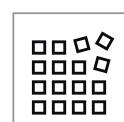
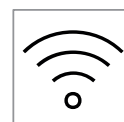

## PANORAMICA DELLE SPIE LUMINOSE

Vuoi sapere di più sulle spie luminose di **Vertuo Pop**?  
Allora guarda il seguente video:

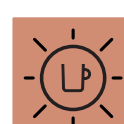
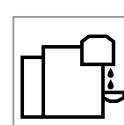
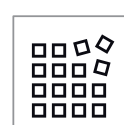
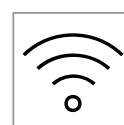

## RISOLUZIONE DEI PROBLEMI

- Nessuna luce sul tasto.**
- La macchina si è spenta automaticamente; premere il tasto o sbloccare la macchina.
  - Controllare il collegamento alla presa elettrica, la spina, la tensione.
- Nessuna erogazione di caffè o acqua.**
- Controllare che il serbatoio dell'acqua non sia vuoto.
  - Controllare che la nuova capsula sia inserita nella posizione corretta, che la maniglia sia completamente bloccata e premere il tasto di erogazione.
  - Se necessario, eseguire la decalcificazione.
  - Aprire la leva e lasciar cadere la capsula. Poi avviare la pulizia come indicato nell'apposita sezione del manuale.
- Il caffè non è abbastanza caldo.**
- Preriscaldare la tazza con acqua calda potabile dal rubinetto.
  - Se necessario, eseguire la decalcificazione.
- Perdita o flusso del caffè inusuale.**
- Controllare che il serbatoio dell'acqua sia posizionato correttamente.
  - Se necessario, eseguire la decalcificazione.
- La macchina si spegne.**
- Per risparmiare energia la macchina entrerà automaticamente in modalità spegnimento automatico dopo 2 minuti di inutilizzo.
  - La macchina può essere spenta manualmente in ogni momento (quando non in uso) premendo il tasto per 3 secondi.
- Polvere di caffè nella tazza.**
- Effettuare 2 volte la procedura di pulizia.
  - Consultare la sezione **"Pulizia"**.

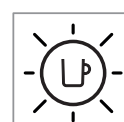
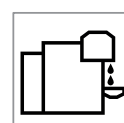
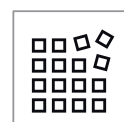
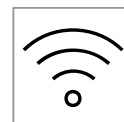

**La macchina non si avvia e le luci sono accese e fisse. Se le luci sono lampeggianti, vedere il paragrafo successivo.**

**La macchina non si avvia e le luci sono accese e lampeggiano alternativamente; 1 lampeggio, 1 pausa.**

**Le luci lampeggiano mentre la macchina è in funzione.**

**La luce lampeggia e la macchina non funziona.**

- Controllare che la leva sia correttamente bloccata.
- Se si desidera erogare un caffè o un espresso, controllare che una nuova capsula sia inserita nella posizione corretta, che la leva sia correttamente bloccata e premere il tasto per avviare l'erogazione.
- Se si sta effettuando la pulizia, la decalcificazione o lo svuotamento del sistema, controllare che non sia inserita nessuna capsula, quindi bloccare la macchina e premere il tasto per avviare una di queste operazioni.

- Riempire il serbatoio dell'acqua e premere il tasto di erogazione.
- Controllare che la leva sia correttamente bloccata.

- Se la macchina eroga normalmente il caffè, questo indica che la macchina sta lavorando correttamente.
- Se eroga solo acqua, la macchina sta eseguendo la procedura di pulizia, la decalcificazione o lo svuotamento del sistema, richiesti dall'utente. Fare riferimento al capitolo corrispondente.
- Spegnerla la macchina premendo il tasto per 3 secondi, quindi premerlo di nuovo per accendere la macchina. Ora attendere circa 20 minuti per consentire alla macchina di raffreddarsi dopo un uso prolungato.

- È necessario attendere qualche secondo prima dell'erogazione del caffè (a causa della lettura del codice a barre e della prebagnatura del caffè).
- Controllare che la nuova capsula sia inserita nella posizione corretta, che la maniglia sia completamente bloccata e premere il tasto di erogazione.
- Riempire il serbatoio dell'acqua e premere il tasto di erogazione.
- Spegnerla la macchina premendo il tasto per 3 secondi, quindi premerlo di nuovo per accendere la macchina. Ora attendere circa 20 minuti per consentire alla macchina di raffreddarsi dopo un uso prolungato.

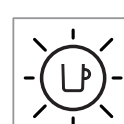
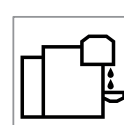
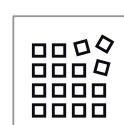
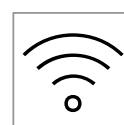



**La luce lampeggia alternativamente; 2 lampeggi e 1 pausa in maniera continuativa. La macchina non funziona.**

- Durante la normale preparazione di caffè:
  - 1) Sbloccare la leva e aprire la testa della macchina per verificare che la capsula nuova non sia danneggiata e sia inserita nella posizione corretta.
  - 2) Verificare che la leva sia in posizione di blocco.
  - 3) Controllare che il serbatoio dell'acqua non sia vuoto.
- Durante la decalcificazione, lo svuotamento e la pulizia:
  - 1) Controllare che la capsula sia stata espulsa.
  - 2) Verificare che la leva sia in posizione di blocco.
- Durante la programmazione del volume:
  - 1) Controllare che la capsula sia stata inserita correttamente.
  - 2) Fare riferimento al capitolo corrispondente.
- Se il problema persiste:
  - 1) Sbloccare la leva e aprire la testa della macchina.
  - 2) Sostituire la capsula (se necessario).
  - 3) Scollegare il cavo di alimentazione dalla presa e ricollegare la macchina alla presa dopo 10 secondi.
  - 4) Chiudere la testa della macchina e premere il tasto di accensione; premere di nuovo il tasto per avviare l'erogazione.

Se il problema persiste, contattare **Nespresso**.

**La luce lampeggia alternativamente 3 volte e poi resta fissa.**

- Decalcificazione necessaria: la macchina può essere utilizzata ancora per qualche tempo quando compare questo allarme ma successivamente diventa necessario decalcificare.

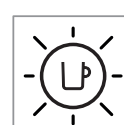
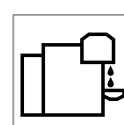
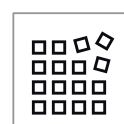
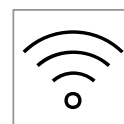

## SPECIFICHE TECNICHE

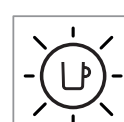
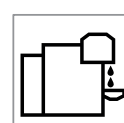
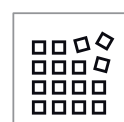
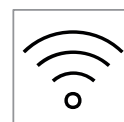

### Potenza

~220-240 V, 50-60 Hz, 1300-1500 W

US, CA: 120 V, 60 Hz, 1500 W

MX: 127 V~, 60 Hz, 1380 W

### Frequenza

2.402-2.480 GHz

### Potenza di uscita RF (EIRP)

Bluetooth 4 dBm Max. (EIRP) and Wi-Fi <20 dMm max. (EIRP)

### Pausa

0,39 W/h

### Modalità risparmio energetico

Spegnimento automatico: 2 min

### Tempo di riscaldamento

30 secondi (testa della macchina chiusa e bloccata)

### Supporto per tazze rimovibile per ricette in tazze grandi

Posizione singola rimovibile

### Lunghezza cavo del dispositivo

75 cm / 30 in

### Dimensioni (L x P x A)

13,6 x 42,6 x 25 cm / 5.3 x 16.7 x 9.8 in

### Peso

3,5 kg / 7.72 lbs

### Capacità serbatoio acqua

0,6 l / 20 fl oz

### Capacità contenitore capsule

8 capsule da espresso o 5 capsule da mug

## CODICE MACCHINA

### Nespresso

GCV2, GDV2

### Breville

BNV120, BNV150

### Delonghi

ENV90

### Krups

XN9201, XN9204,  
XN9205, XN9211

### Magimix

M800

# HAZ CLIC Y ELIGE TU IDIOMA

**ES**



**SEGURIDAD**



**VISIÓN GENERAL**



**CONECTIVIDAD**



**PRIMEROS PASOS**



**PREPARACIÓN DEL CAFÉ**



**ADAPTA EL VOLUMEN DE TU CAFÉ**



**LIMPIEZA**



**DESCALCIFICACIÓN**



**VACIADO DEL SISTEMA**



**RESTABLECER A LA CONFIGURACIÓN  
DE FÁBRICA**



**RESUMEN DE ALERTAS LUMINOSAS**



**RESOLUCIÓN DE PROBLEMAS**



**ESPECIFICACIONES**

## SEGURIDAD

**ADVERTENCIA:** Antes de utilizar la máquina de café, consulta el folleto de instrucciones de seguridad para evitar daños y lesiones.

### ELIMINACIÓN Y PROTECCIÓN MEDIOAMBIENTAL

Este aparato cumple la Directiva de la UE 2012/19/CE. Los materiales de embalaje y el aparato contienen materiales reciclables. Este aparato contiene materiales valiosos que se pueden recuperar o reciclar. La clasificación de los materiales de desecho restantes facilita el reciclaje de materias primas valiosas. Deje el aparato en un punto de reciclaje. Puede obtener información sobre la eliminación de las autoridades de su localidad.

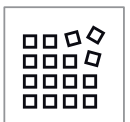

# VISIÓN GENERAL

## VISTA GENERAL DE LA MÁQUINA

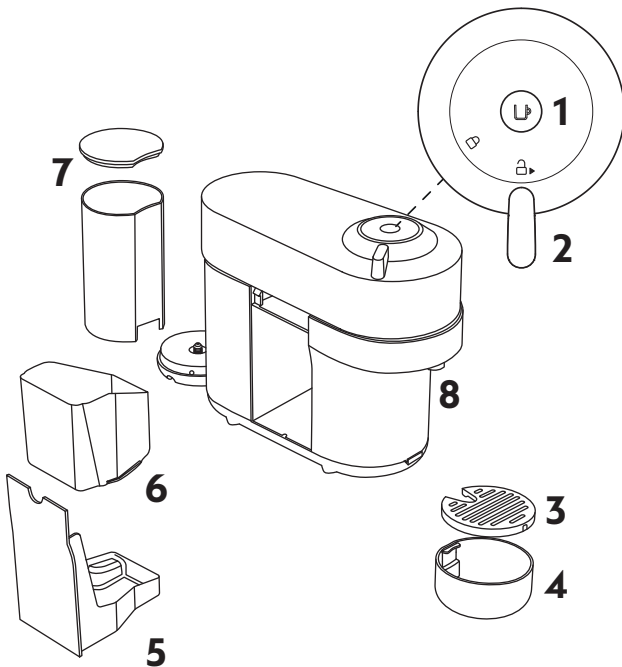

- 1 Botón de ENCENDIDO/ APAGADO y de café
- 2 Palanca de bloqueo/ desbloqueo
- 3 Rejilla antigoteo
- 4 Soporte de taza ajustable
- 5 Bandeja antigoteo
- 6 Contenedor de cápsulas usadas
- 7 Depósito de agua y tapa
- 8 Salida del café

## CONTENIDO DEL PAQUETE



- 1 Máquina de café
- 2 Caja de cápsulas **Nespresso**
- 3 Material de bienvenida **Nespresso**
- 4 Instrucciones de seguridad
- 5 Guía de Inicio Rápido
- 6 Garantía

**i** Al desembalar la máquina es posible que encuentres algo de polvo en su superficie. Este polvo procede de los materiales reciclados que se han utilizado en el embalaje. No es peligroso. Solo tienes que limpiarlo con un paño suave.

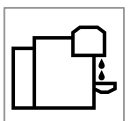
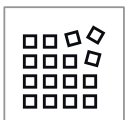



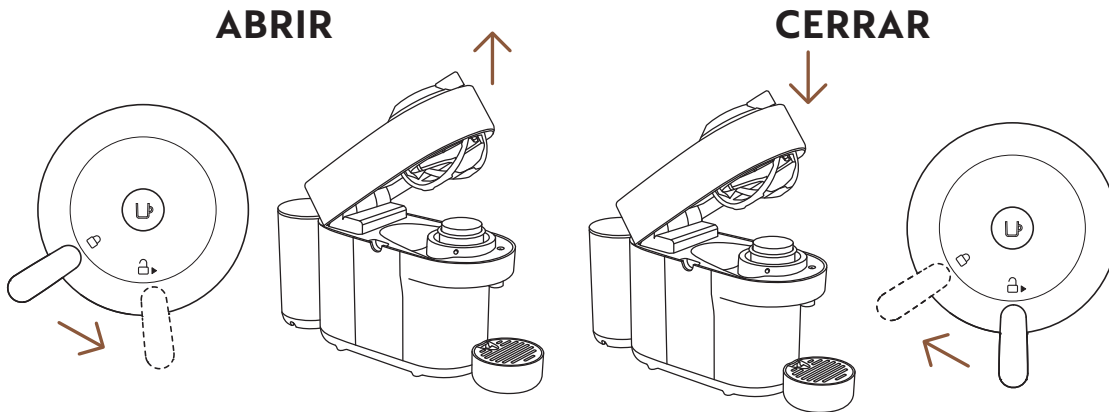

## ABRIR/CERRAR



**ADVERTENCIA:** para un correcto uso de la máquina, no abras el cabezal de la máquina mientras se prepara el café, espera hasta que la máquina se haya detenido y el botón de café esté fijo y de color blanco. Si deseas detener la preparación antes, presiona el botón de café una vez y espera hasta que el botón de café vuelva a estar en blanco fijo.

## EL SISTEMA VERTUO

### COMPATIBILIDAD DE CÁPSULAS

			
<b>S</b>	<b>M</b>	<b>L</b>	<b>XL</b>
<b>Ristretto</b> (25 ml)	<b>Espresso doble</b> (80 ml)	<b>Mug</b> (230 ml)	<b>Alto, Cold Brew Style</b> 355 ml
<b>Espresso</b> (40 ml)	<b>Gran Lungo</b> (150 ml)		<b>Carafe</b> (535 ml)

### COMPATIBILIDAD DE ACCESORIOS



Compatibilidad de accesorios



Accesorios no compatibles



Descubre nuestra colección completa de accesorios en [www.nespresso.com](http://www.nespresso.com)

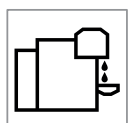

## ENCENDIDO/APAGADO

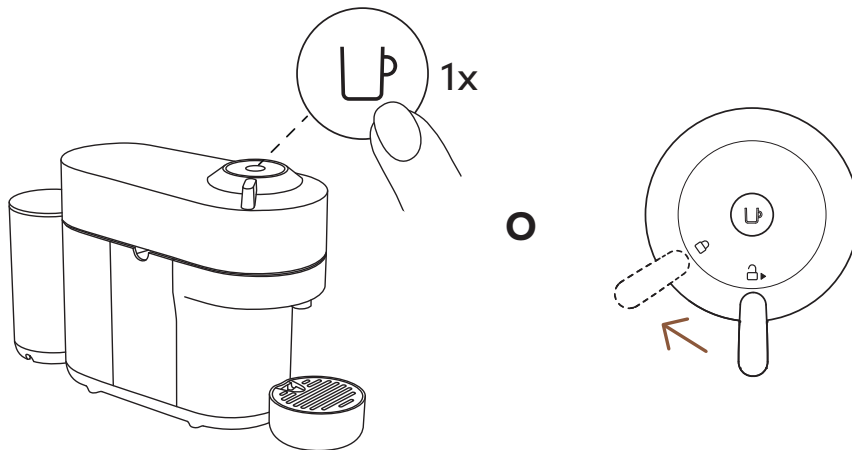
**ENCENDIDO**

Una vez enchufada la máquina, enciéndela presionando una vez el botón o cerrando la palanca en la posición de bloqueo (con el cabezal cerrado).

- i** La luz parpadeará durante aproximadamente 30 segundos mientras la máquina se calienta. Una vez que la luz está fija, la máquina está lista para usarse.

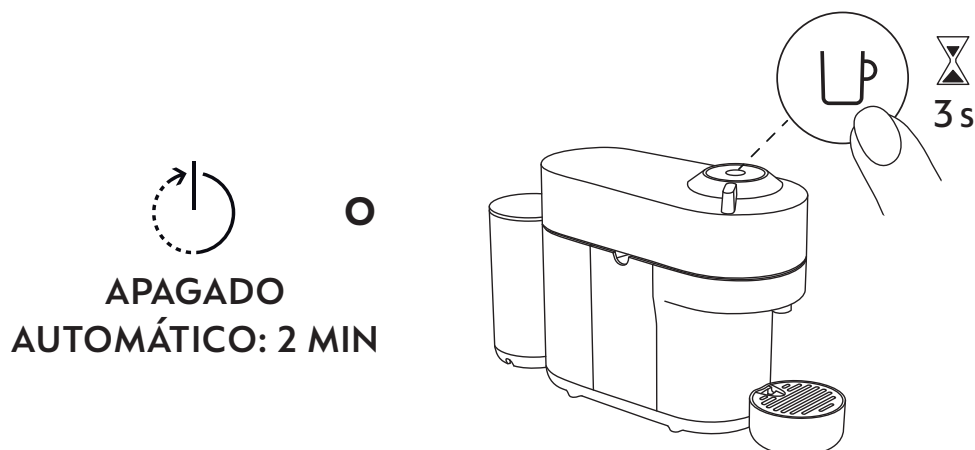
**APAGADO**

Para ahorrar energía, la máquina se apagará después de 2 minutos sin utilizarla.

- i** La máquina se puede apagar manualmente en cualquier momento (cuando no esté en uso) manteniendo presionado el botón durante 3 segundos.

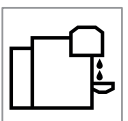
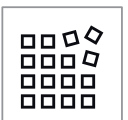

## CONECTIVIDAD

### ¿POR QUÉ DEBES CONECTAR TU MÁQUINA VERTUO POP?



### BENEFICIOS DE CONECTAR TU MÁQUINA VERTUO POP

- **Café inteligente:** Esté siempre al día con las últimas innovaciones y noticias de café de **Nespresso**, manteniendo su máquina actualizada.
- **Asesoramiento de expertos:** Obtén soporte y videos tutoriales simples para acompañar tu viaje de café a través de tu teléfono inteligente.
- **Cuidado de la máquina:** Recibe notificaciones instantáneas sobre cómo y cuándo realizar el mantenimiento de tu máquina con una guía paso a paso sobre descalcificación, enjuague, limpieza, etc.

### ¿CÓMO CONECTAR TU MÁQUINA VERTUO POP?

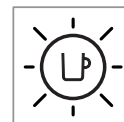
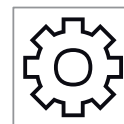
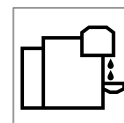
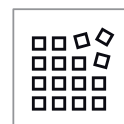





**1** Descarga o actualiza la aplicación **Nespresso**. Inicia la aplicación **Nespresso** en tu teléfono inteligente o tableta. Presiona el icono de la máquina en la parte superior derecha de tu pantalla.

**NOTA:** para un rendimiento óptimo y una experiencia perfecta, recomendamos conectar tu máquina a un enrutador Wi-Fi en lugar de usar un punto de acceso de teléfono inteligente.

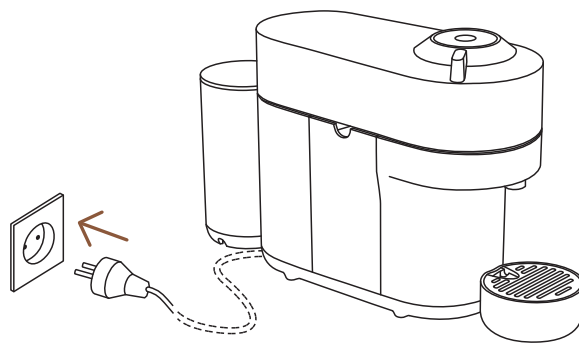

**2** Enchufa el cable de alimentación.



**3** Sigue las instrucciones a través de la App **Nespresso**.

**ADVERTENCIA:** Lee primero las precauciones de seguridad para evitar riesgos de descargas eléctricas fatales e incendios. Asegúrate de que haya continuidad a tierra cuando conectas la máquina a la toma de corriente.

\* App Store® es una marca registrada de Apple Inc., registrada en los Estados Unidos y otros países.

\*\* Google Play y el logo de Google Play son marcas registradas de Google LLC.



## DESACTIVACIÓN DEL BLUETOOTH Y WI-FI DE LA MÁQUINA

La máquina viene con un módulo de conectividad, habilitado por defecto. Da acceso a funciones adicionales, mejorando tu experiencia de café. Para deshabilitar el módulo de conectividad, sigue estos pasos:

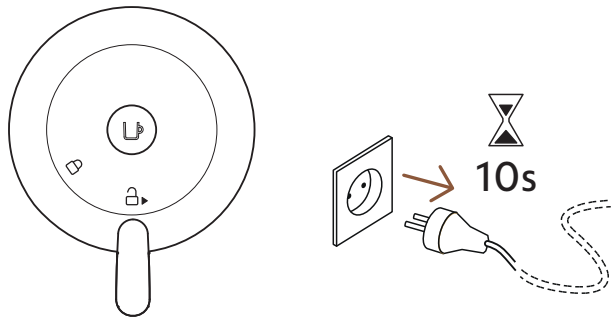

- 1 Con la máquina cerrada y la palanca en **posición desbloqueada**, desenchufa la máquina durante al menos 10 segundos.

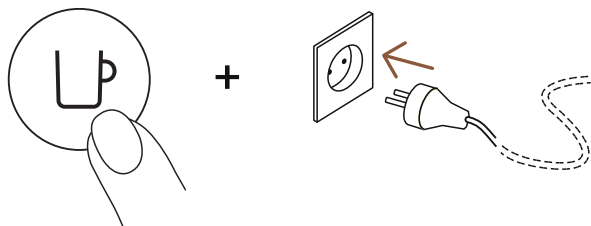

- 2 Mantén pulsado el botón mientras se conecta. El botón parpadeará en naranja para confirmar que el módulo de conectividad ahora se ha desactivado.
- i** Sigue los mismos pasos para volver a configurar el módulo de conectividad. El botón parpadeará en blanco para confirmar que el módulo se ha reactivado.

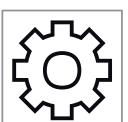
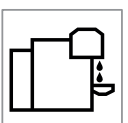

# PRIMEROS PASOS

## PRIMER ENJUAGUE

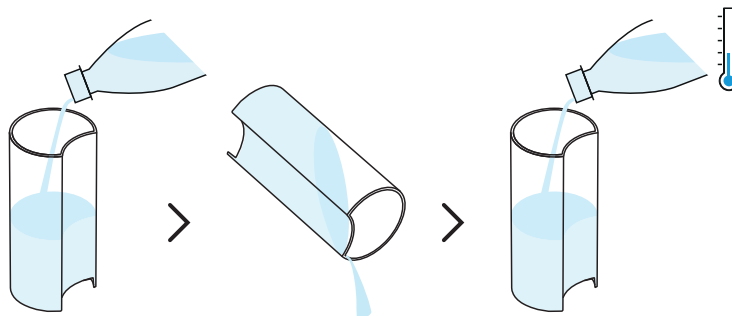

- 1** Primero enjuaga y limpia el tanque de agua y la tapa antes de llenarlo con agua potable fresca.

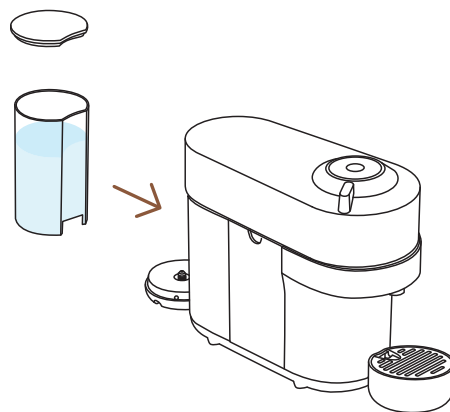

- 2** Cierra el tanque de agua con la tapa y coloca el tanque de agua en su lugar y asegúrate de que esté bien sujeto.

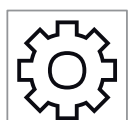

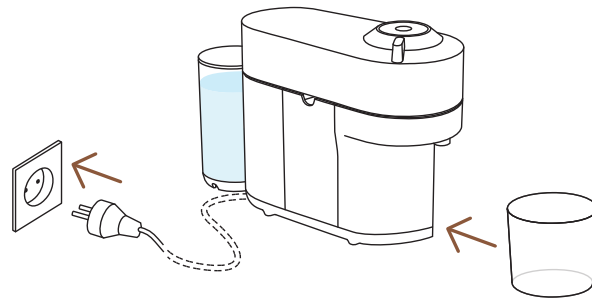

- 3** Con la máquina enchufada, retira el soporte de tazas y coloca un recipiente vacío (de al menos 1 L) debajo de la salida de café.

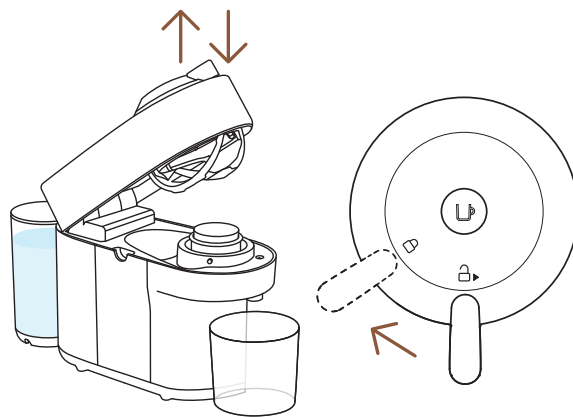

- 4** Abre y cierra la máquina. Asegúrate de que la palanca está en la posición de bloqueo.

- i** La luz parpadeará mientras la máquina se esté calentando. Tardará aproximadamente 30 segundos. Cuando la luz se vuelve fija, la máquina está lista. Asegúrate de que no haya ninguna cápsula en el interior de la máquina.

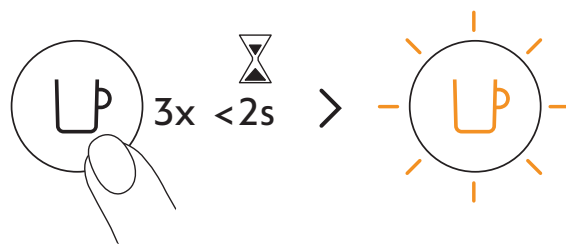

- 5** Presiona el botón 3 veces en 2 segundos para comenzar a enjuagar. Con la luz naranja parpadeando, deja que el procedimiento de enjuague se complete automáticamente. Cuando la luz se vuelve blanca constante, el ciclo está completo.

- i** Debería tardar menos de 2 minutos antes de que comience el proceso de enjuague y el agua comience a fluir. Este proceso puede durar hasta 7 minutos.

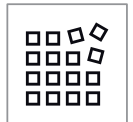

# PREPARACIÓN DEL CAFÉ

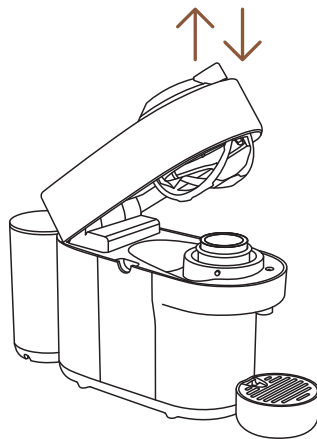

**1** Abre y cierra la máquina.

**i** La luz del botón de café parpadeará mientras la máquina se está calentando. Cuando la luz se vuelve fija, la máquina está lista para usar.

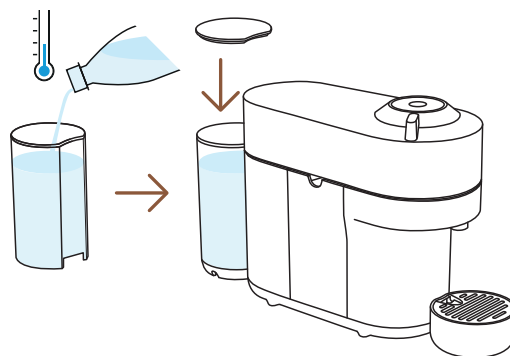

**2** Llena el depósito de agua con agua potable fresca y vuelve a colocarlo en su sitio.

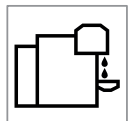
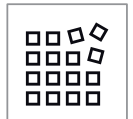

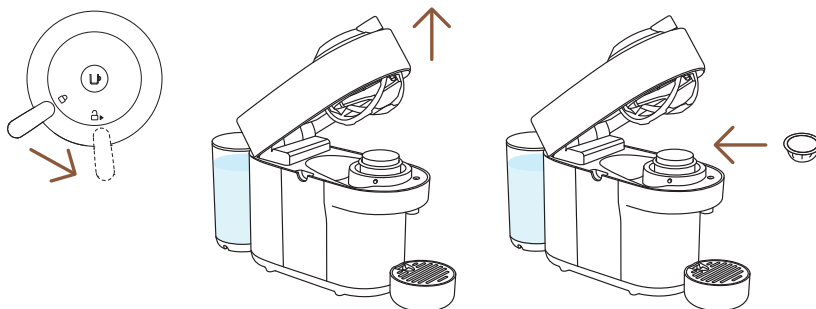

- 3** Desbloquea y abre completamente el cabezal de la máquina e inserta una cápsula Vertuo con el código de barras hacia abajo.

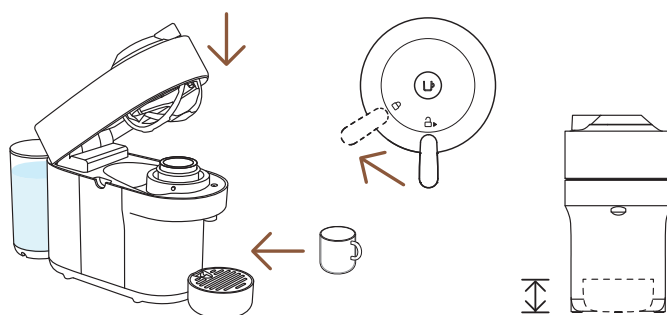

- 4** Cierra el cabezal de la máquina y bloquéalo girando la palanca hacia la izquierda hasta la posición de bloqueo y coloca una taza. El soporte de la taza se puede ajustar para adaptarse al tamaño de la taza.

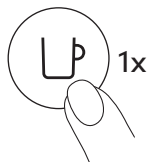

- 5** Comienza a preparar presionando el botón una sola vez.

**ADVERTENCIA:** para un uso correcto de la máquina, no abras el cabezal de la máquina mientras se prepara el café, espera hasta que la máquina se haya detenido y el botón de café esté fijo y de color blanco. Si deseas detener la preparación antes, presionea el botón de café una vez y espera hasta que el botón de café vuelva a estar en blanco fijo.

- i** Debido a la lectura del código, el prehumedecimiento del café y el tiempo de infusión, pasará un momento antes de que el café comience a fluir. La máquina reconocerá automáticamente la cápsula insertada y seleccionará los parámetros de preparación del café y la longitud de la taza definidos por los expertos en café de **Nespresso** para extraer las mejores mezclas de café.

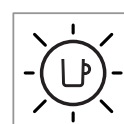
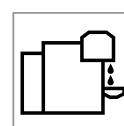
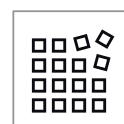
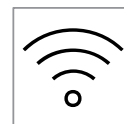

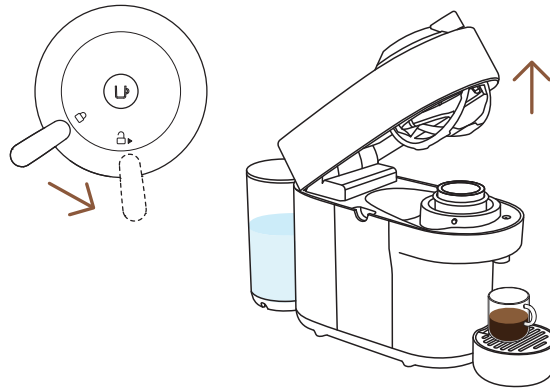

- 6** Cuando el café deje de salir, abre el cabezal de la máquina girando la palanca hacia la derecha hacia la posición de desbloqueo para expulsar automáticamente la cápsula y disfrutar de tu café.



- 7** Recicla la cápsula de café.\*

\* ES **NESPRESSO**, ES RECICLABLE. Para más información sobre nuestro programa de reciclaje, visita [www.nespresso.com](http://www.nespresso.com)

**DESCUBRE NUESTRO MODO COFFEE CREATIONS**



Con esta máquina, **Nespresso** te ofrece una función específica para concentrar tus extracciones de café para crear tus propias recetas.

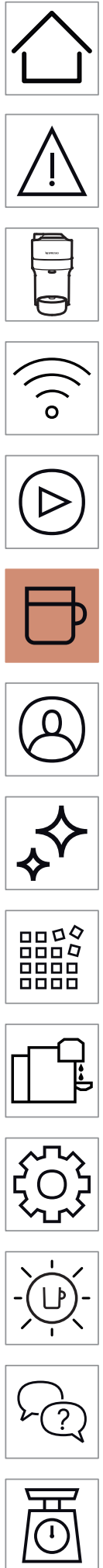

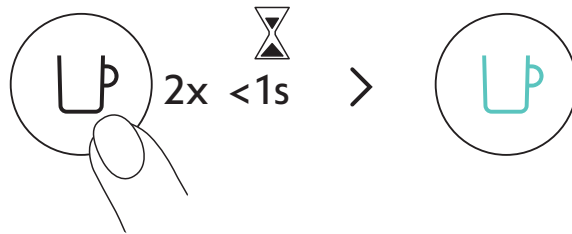

Con tu máquina encendida, haz doble clic en el botón de café. Parpadeará en color turquesa y tu preparación de café se concentrará, optimizando el sabor del café en recetas con complementos (leche, crema, con hielo...). Para una experiencia de café incomparable.

40 ml	80 ml	150 ml	230 ml	355 ml	535 ml
✓	✓	✓	✓	✗	✗
25 ml	40 ml	40 ml	80 ml		

Para disfrutar plenamente de los beneficios de la gama Coffee+, recomendamos utilizar solo los tamaños de taza oficiales. Para obtener los mejores resultados en taza, no recomendamos preparar nuestro XL (Alto Ambrato, Alto Onice), Cold Brew Style y Jarra Pour Over Style con este modo.

**NOTA:** Es posible que sea necesaria una actualización de tu máquina a través de la aplicación **Nespresso** para habilitar este modo.



Descubre cómo actualizar tu máquina con nuestra gama Aeroccino en [www.nespresso.com](http://www.nespresso.com)

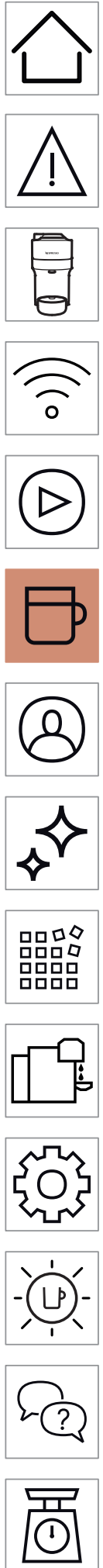



## AJUSTA EL TAMAÑO DE TUS CAFÉS

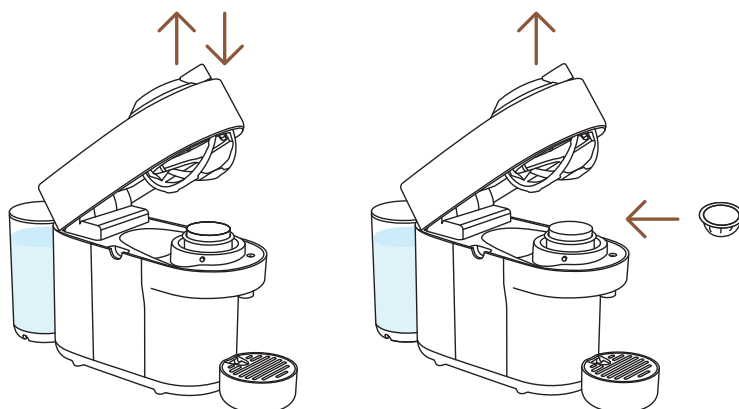

- 1** Abre y cierra la máquina. Con la máquina encendida, abre la máquina e inserta la cápsula que deseas programar.

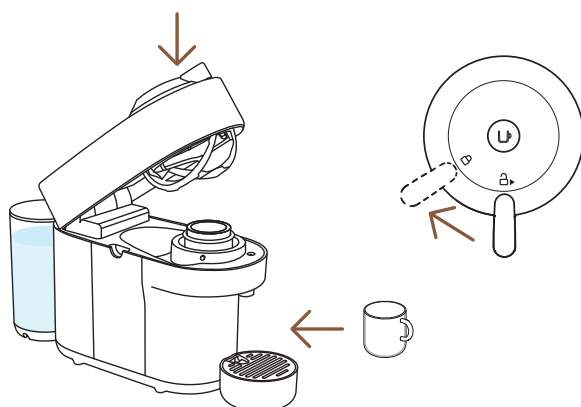

- 2** Cierra el cabezal de la máquina, gira la palanca hacia la izquierda hacia la posición de bloqueo y coloca una taza.

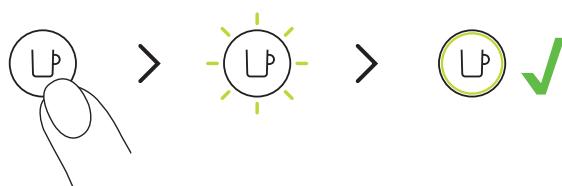

- 3** Mantén pulsado el botón, soltándolo unos segundos antes de alcanzar el volumen deseado. El nuevo volumen de agua ahora está programado para el tipo de cápsula utilizada durante el ajuste.

- i** La programación es específica para cada tipo de cápsula. Los tamaños de taza se pueden programar entre 20 ml y 535 ml.

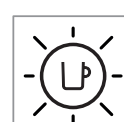
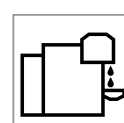
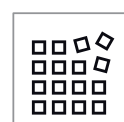
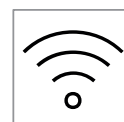

**ADVERTENCIA:** para un uso correcto de la máquina, no abras el cabezal de la máquina mientras se prepara el café, espera hasta que la máquina se haya detenido y el botón de café esté fijo y de color blanco. Si deseas detener la preparación antes, presiona el botón de café una vez y espera hasta que el botón de café vuelva a estar en blanco fijo.

**NOTA:** Una vez que el usuario programa un tamaño específico, cada vez que se inserta ese tipo de cápsula en la máquina, la preparación se detendrá en el tamaño de taza programado por el usuario. Si deseas volver a los parámetros predeterminados, consulta el párrafo **“Restablecimiento de la configuración de fábrica”**.

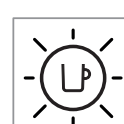
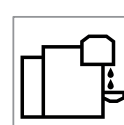
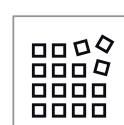
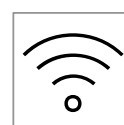

## LIMPIEZA

Limpia tu máquina mensualmente, cuando comience a tener residuos de café dentro del cabezal de la máquina o después de un largo período de inactividad.

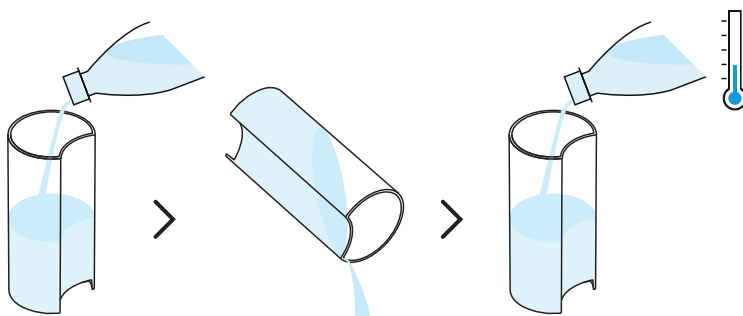

- 1** Enjuaga y limpia el depósito de agua y la tapa antes de llenarlo con agua potable fresca.

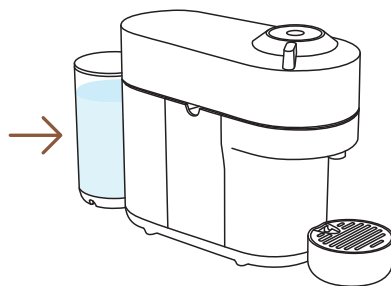

- 2** Vuelve a colocar el depósito de agua en su posición en la máquina.

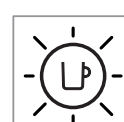
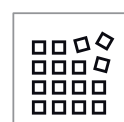
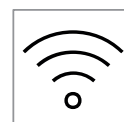

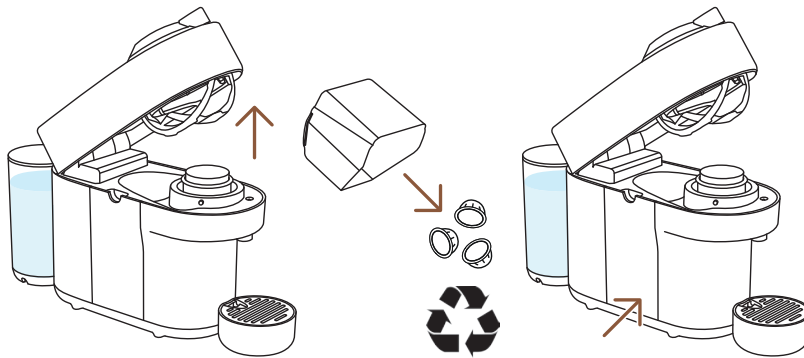

- 3** Con la máquina encendida, desbloquea y abre la máquina y deja que se expulse la cápsula usada. Vacía y enjuaga el contenedor de cápsulas y la bandeja de goteo y vuelve a colocarlos. Recicla la cápsula de café.\*

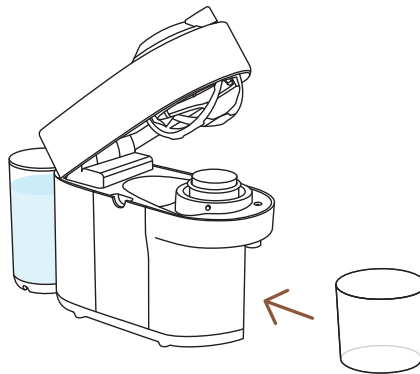

- 4** Retira el soporte para tazas y coloca un recipiente vacío (de al menos 1 L / 34 fl oz) debajo de la salida de café.

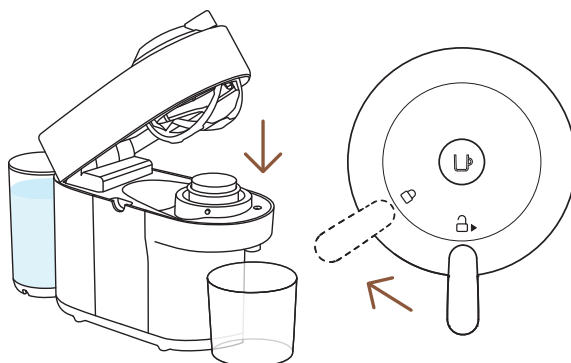

- 5** Cierra el cabezal de la máquina y gira la palanca hacia la izquierda hacia la posición de bloqueo. Asegúrate de que no haya cápsulas en la máquina antes de iniciar el procedimiento de enjuague.

\* ES **NESPRESSO**, ES RECICLABLE. Para más información sobre nuestro programa de reciclaje, visita [www.nespresso.com](http://www.nespresso.com)

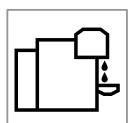

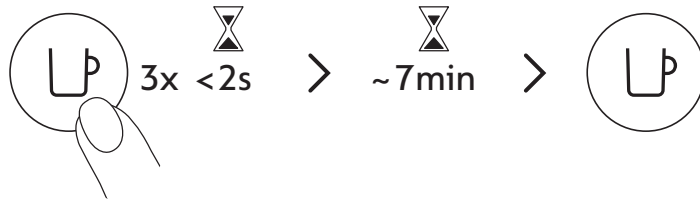

- 6** Presiona el botón 3 veces en 2 segundos para comenzar a enjuagar. Con la luz naranja parpadeando, deja que el procedimiento de enjuague se complete automáticamente.
- i** Debería tomar menos de 2 minutos antes de que comience el proceso de enjuague y el agua comience a fluir. Esta operación puede tardar hasta 7 minutos y se detendrá automáticamente cuando se complete el ciclo. Este proceso puede cancelarse en cualquier momento pulsando el botón.

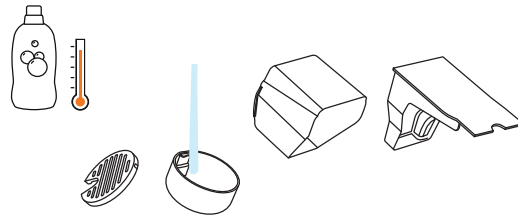

- 7** Lava el contenedor de cápsulas, el soporte de la taza y la bandeja de goteo con agua caliente y un detergente suave e inodoro.

**ADVERTENCIA:** No utilices ningún agente de limpieza fuerte o abrasivo o limpiador solvente. No pongas la máquina en un lavavajillas. Nunca sumerjas el aparato o parte de él en agua.

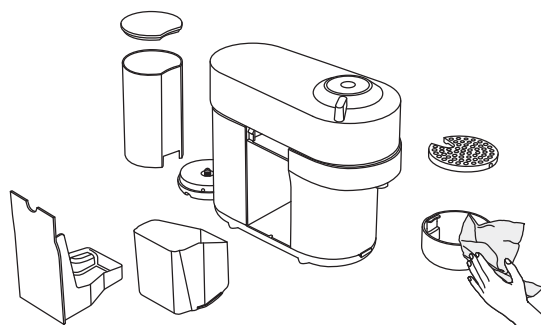

- 8** Seca con un paño limpio

**ADVERTENCIA:** Limpia la salida de café periódicamente con un paño limpio y húmedo. Utiliza siempre paños suaves para limpiar la máquina.

**NOTA:** Es posible que el agua se acumule en el interior el cabezal de la máquina. Por favor, seca las partes visibles con un paño limpio y seco.

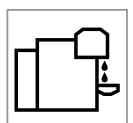

## DESCALCIFICACIÓN

Descalcificar tu máquina asegurará que funcione correctamente durante toda su vida útil y hará que tu experiencia con el café sea tan incomparable como lo fue el primer día. Tu máquina te indicará cuándo es necesario descalcificar parpadeando en naranja 3 veces antes de permanecer en blanco.



**i** El proceso de descalcificación dura unos 20 minutos y **no se puede interrumpir**.

**NOTA:** Lee atentamente las instrucciones de descalcificación antes de comenzar.

### Necesitarás:

- Un kit de descalcificación disponible en [www.nespresso.com](http://www.nespresso.com)
- Un recipiente vacío (de 1 L)

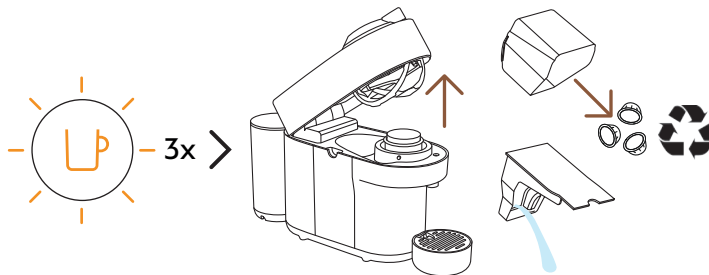

**1** Con el botón parpadeando en naranja 3 veces: Desbloquea y abre el cabezal de la máquina y deja que se expulse la cápsula usada. Vacía el contenedor de cápsulas y la bandeja de goteo y vuelve a colocarlos en su lugar en la máquina. Recicla la cápsula de café.\*

\* ES **NESPRESSO**, ES RECICLABLE. Para más información sobre nuestro programa de reciclaje, visita [www.nespresso.com](http://www.nespresso.com)

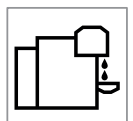

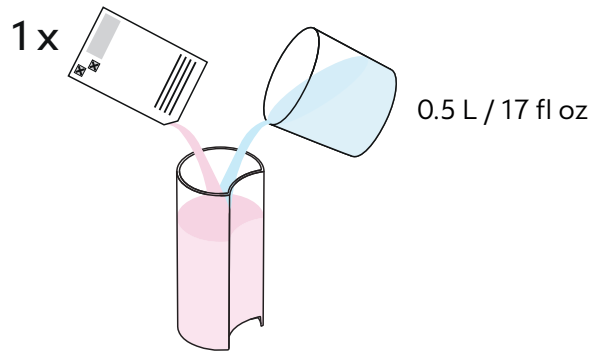

- 2** Llena el depósito de agua con 0,5 L de agua y añade 1 unidad de líquido descalcificador **Nespresso**.

**ATENCIÓN:** Ten en cuenta que la solución descalcificadora puede ser dañina. Evita el contacto con los ojos, la piel y las superficies.

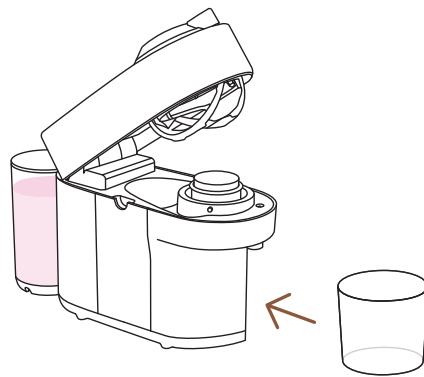

- 3** Retira el soporte para tazas y coloca un recipiente vacío (de al menos 1 L) debajo de la salida de café.

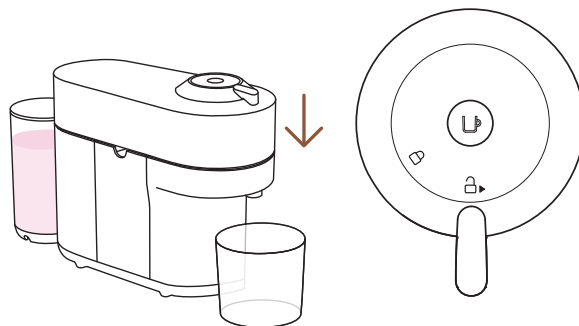

- 4** Con la máquina encendida, cierra el cabezal de la máquina y deja la palanca en la posición de desbloqueo.

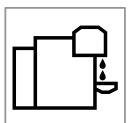

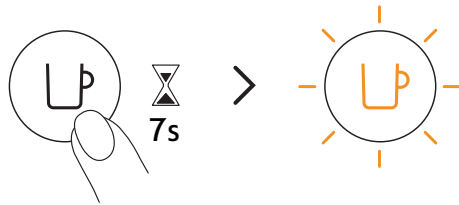

- 5** Mantén presionado el botón durante al menos 7 segundos o hasta que vea que la luz se apaga. El botón comenzará a parpadear en naranja rápidamente.

**ADVERTENCIA:** Ahora tienes 45 segundos para entrar en el modo de descalcificación; de lo contrario, la máquina volverá al modo de preparación.

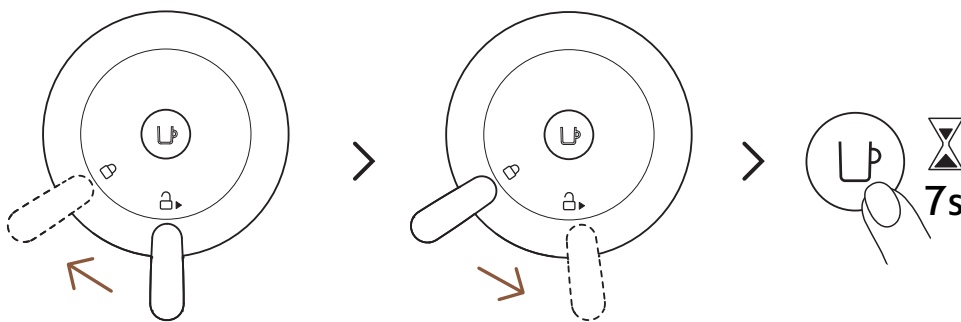

- 6** Bloquea el cabezal de la máquina girando la palanca hacia la izquierda hasta el símbolo de bloqueo y luego desbloquea la palanca girando hacia la derecha hasta la posición de desbloqueo. Mantén presionado el botón nuevamente durante aproximadamente 7 segundos o hasta que la luz se apague. El botón comenzará a parpadear en naranja rápidamente.

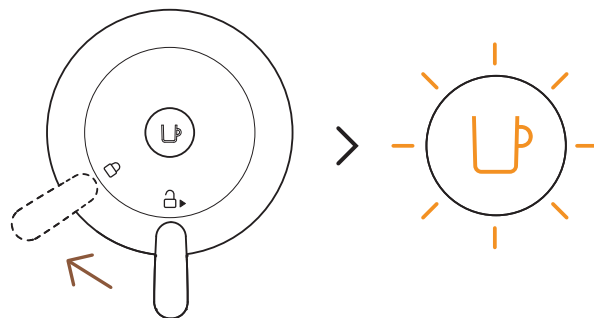

- 7** Para ingresar al modo de descalcificación, bloquea la máquina girando la palanca hacia la izquierda hacia la posición de bloqueo. La luz debería seguir parpadearo en naranja rápidamente. Esto es una indicación de que ha entrado en el modo de descalcificación.

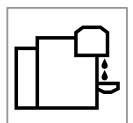
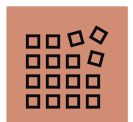



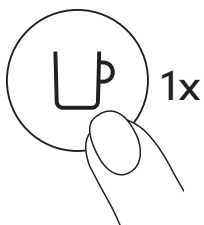

- 8** Pulsa el botón de café una vez para comenzar el proceso de descalcificación. La luz parpadeará continuamente en naranja durante todo el proceso.
- i** La máquina se detendrá automáticamente cuando se complete la primera fase de descalcificación.

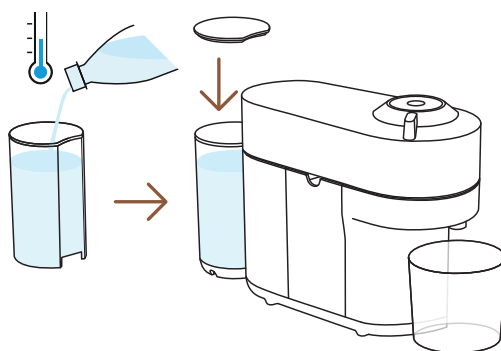

- 9** Al final del proceso de descalcificación, es hora de enjuagar la máquina. Enjuaga bien el tanque de agua y la bandeja de goteo. Llena el depósito de agua con agua potable fresca y vuelve a colocarlo. Vacía el recipiente y vuelve a colocarlo debajo de la salida de café.

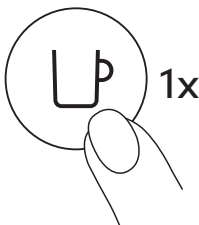

- 10** Presiona el botón para enjuagar la máquina. Cuando el botón deje de parpadear rápidamente y se quede fijo, el procedimiento de descalcificación habrá finalizado.
- i** La máquina se detendrá automáticamente cuando se complete el procedimiento.

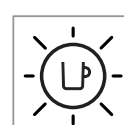
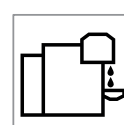
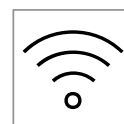

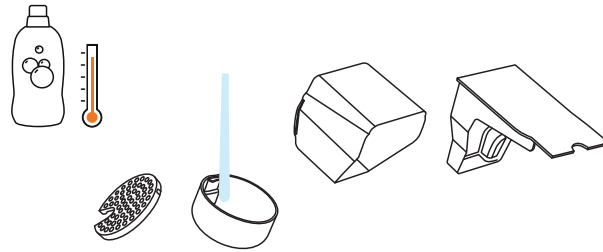

- 11** Lava el contenedor de cápsulas, el soporte de la taza y la bandeja de goteo con agua caliente y un detergente suave e inodoro.

**ADVERTENCIA:** No utilices ningún agente de limpieza fuerte o abrasivo o limpiador solvente. No pongas la máquina en un lavavajillas. Nunca sumerjas el aparato o parte de él en agua.

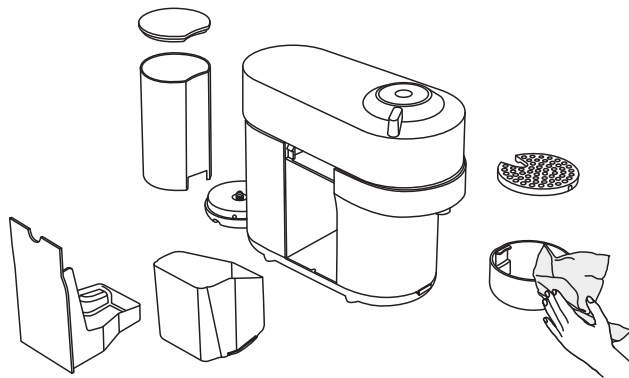

- 12** Seca la máquina con una toalla limpia y fresca. Deja que la máquina se seque durante 10 minutos antes de usarla.

**NOTA:** El agua puede acumularse dentro del cabezal de la máquina durante la limpieza. Si esto sucede, seca las partes visibles con un paño limpio y seco.

**NOTA:** la máquina solo puede entrar en modo descalcificación después de haber preparado 30 o más cafés.

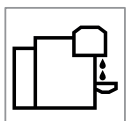
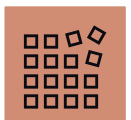

## VACIAR EL SISTEMA

El vaciado del sistema es un proceso que puede realizarse antes de un período de inactividad, para protección contra heladas o antes de enviar la máquina a reparar.

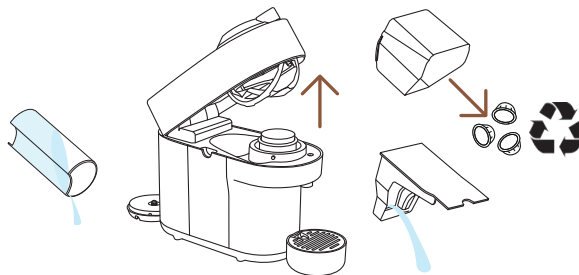

- 1** Vacía el tanque de agua, abre el cabezal de la máquina y deja que se expulse la cápsula usada. Vacía el contenedor de cápsulas y la bandeja de goteo. Recicla la cápsula de café.\*

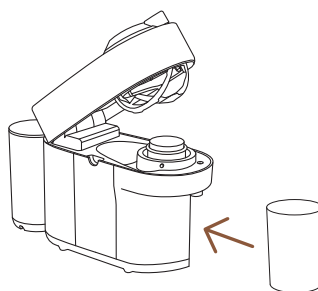

- 2** Vuelve a colocarlos en su posición en la máquina, retira el soporte de tazas y coloca un recipiente vacío (0,5 L) debajo de la salida de café.

\* ES **NESPRESSO**, ES RECICLABLE. Para más información sobre nuestro programa de reciclaje, visita [www.nespresso.com](http://www.nespresso.com)

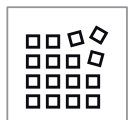

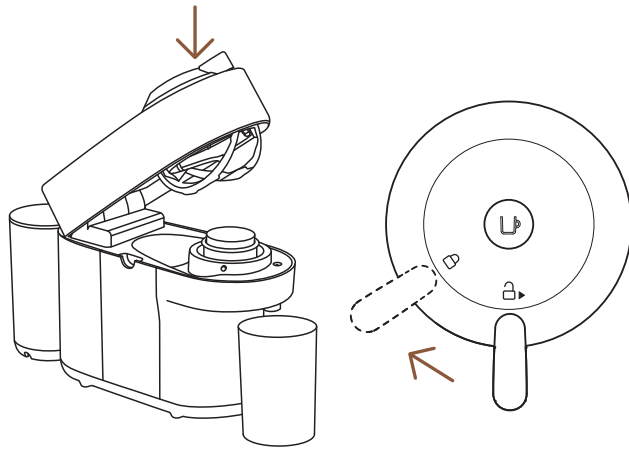

**3** Con la máquina enchufada y encendida, gira la palanca hacia la posición de bloqueo.

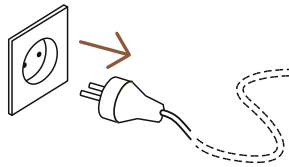

**4** Desconecta la máquina

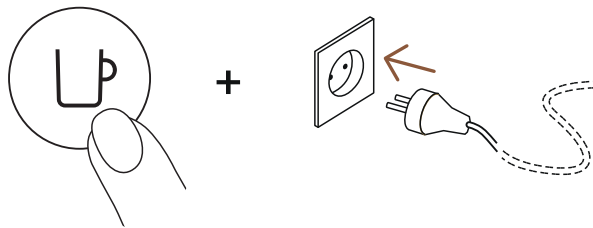

**5** Mantén pulsado el botón mientras se conecta



**6** Suelta el botón. Parpadeará en naranja y comenzará el proceso de vaciado.

**i** La máquina tardará aproximadamente 30 segundos en completar el proceso de vaciado. La máquina se apaga automáticamente cuando está vacía.



## RESTABLECE LOS AJUSTES DE FÁBRICA

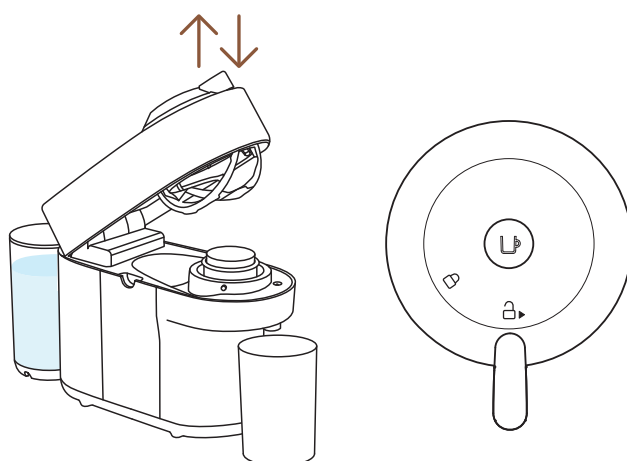

- 1 Con la máquina enchufada, abre y luego cierra el cabezal de la máquina antes de dejar la palanca en la **posición de desbloqueo**.

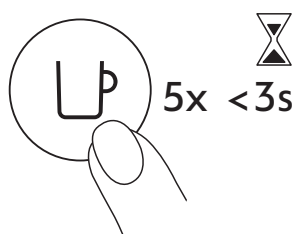

- 2 Pulsa el botón 5 veces durante 3 segundos. La máquina ahora está programada con la configuración de fábrica.

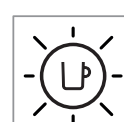
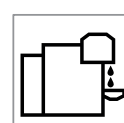
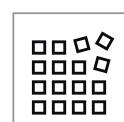
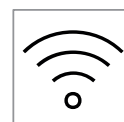

## RESUMEN DE LUCES

¿Quieres saber más sobre el parpadeo de Vertuo Pop?  
Por favor, mira el siguiente video:



## RESOLUCIÓN DE PROBLEMAS

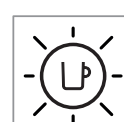
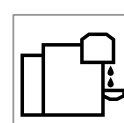
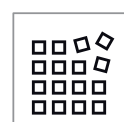
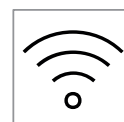

### El botón no está iluminado

- La máquina se ha apagado automáticamente. Pulsa el botón o desbloquea la máquina.
- Comprueba la red eléctrica, el enchufe, el voltaje y el fusible.

### No sale ni café ni agua.

- Comprueba que el depósito de agua está lleno.
- Comprueba que la cápsula se ha insertado correctamente y que la palanca está bloqueada y pulsa el botón de inicio.
- Descalcifica la máquina si es necesario.
- Abre el cabezal de la máquina y deja que expulse la cápsula. A continuación, realiza una limpieza siguiendo los pasos del apartado de limpieza.

### El café no está lo suficientemente caliente.

- Precalienta la taza con agua caliente del grifo.
- Descalcifica la máquina si es necesario.

### Hay una fuga o el flujo de café no es el habitual.

- Comprueba que el depósito de agua está bien colocado.
- Descalcifica la máquina si es necesario.

### La máquina pasa al modo de apagado.

- Para ahorrar energía, la máquina se apagará después de 2 minutos sin utilizarla.
- La máquina se puede apagar manualmente en cualquier momento (cuando no esté en uso) manteniendo presionado el botón durante 3 segundos.

### Posos de café en la taza.

- Ejecuta dos veces el proceso de limpieza
- Consulta el apartado “Limpieza”.

**La máquina no funciona y tiene una luz encendida. Si parpadea, consulta los puntos siguientes.**

**La máquina no funciona y la luz parpadea alternativamente (parpadea una vez y hace una pausa).**

**La luz parpadea mientras la máquina está funcionando.**

**La máquina no funciona y la luz parpadea alternativamente (parpadea una vez y hace una pausa).**

- Comprueba que la palanca está bloqueada correctamente
- Si quieres preparar un café o un Espresso, comprueba que la cápsula se ha insertado correctamente y que la palanca está bloqueada y pulsa el botón de inicio.
- Si estás limpiando, descalcificando o vaciando el sistema, comprueba que no se haya introducido ninguna cápsula y a continuación cierra y bloquea la máquina y pulsa el botón para iniciar una de las acciones anteriores.

- Llena el depósito de agua y pulsa el botón para comenzar.
- Comprueba que la palanca está bloqueada correctamente

- Si el café fluye normalmente, esto indica que la máquina está funcionando de forma correcta
- Si solo sale agua, la máquina está ejecutando una función solicitada por el usuario como la limpieza, la descalcificación o el vaciado del sistema. Comprueba el capítulo correspondiente.
- Apaga la máquina manteniendo pulsado el botón durante 3 segundos y después vuelve a pulsarlo para encender la máquina. Ahora espera 20 minutos aproximadamente para dejar que la máquina se enfríe después de un uso intenso.

- El café puede tardar un tiempo en salir debido a la lectura del código de barras y al humedecido previo del café.
- Comprueba que la cápsula se ha insertado correctamente y que la palanca está bloqueada y pulsa el botón de inicio.
- Llena el depósito de agua y pulsa el botón para comenzar.
- Apaga la máquina manteniendo pulsado el botón durante 3 segundos y después vuelve a pulsarlo para encender la máquina. Ahora espera 20 minutos aproximadamente para dejar que la máquina se enfríe después de un uso intenso.

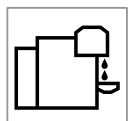
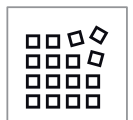



**La luz parpadea alternativamente (parpadea dos veces y hace una pausa continuamente). La máquina no funciona.**

- Preparación de café/Espresso:
  - 1) Desbloquea la palanca y abre el cabezal de la máquina para comprobar que se ha insertado una cápsula nueva en la posición correcta.
  - 2) Comprueba que la palanca está bloqueada.
  - 3) Comprueba que el depósito de agua está lleno.
- Descalcificación, vaciado y limpieza:
  - 1) Comprueba que la cápsula ha sido expulsada.
  - 2) Comprueba que la palanca está bloqueada.
- Programación del volumen:
  - 1) Comprueba que se ha insertado una cápsula correctamente.
  - 2) Comprueba el capítulo correspondiente **“Ajusta el volumen de tu café”**.
- Si el problema continúa:
  - 1) Desbloquea la palanca y abre el cabezal de la máquina.
  - 2) Sustituye la cápsula (si es necesario).
  - 3) Desconecta el cable de alimentación de la toma de corriente y vuelve a enchufar la máquina después de 10 segundos.
  - 4) Cierra el cabezal y pulsa el botón de encendido. Vuelve a pulsar para iniciar la preparación.

Si el problema continúa, llama a **Nespresso**.

**La luz parpadea alternativamente 3 veces y después se queda encendida**

- Es necesario descalcificar la máquina. Después de que aparezca este aviso, solo se podrá utilizar la máquina unas pocas veces antes de que se haga necesario descalcificarla.

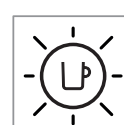
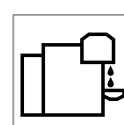
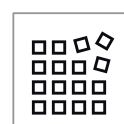
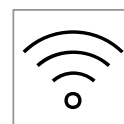

## ESPECIFICACIONES

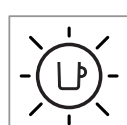
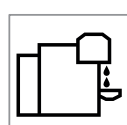
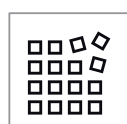
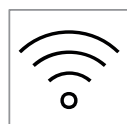

### Energía

~220-240 V, 50-60 Hz, 1300-1500 W

US, CA: 120 V, 60 Hz, 1500 W

MX: 127 V~, 60 Hz, 1380 W

### Frecuencia

2.402-2.480 GHz

### Potencia de salida RF (EIRP)

Bluetooth 4 dBm Max. p.i.r.e. y Wi-Fi <20 dMm máx. p.i.r.e

### Modo de espera

0.39 W/h

### Modo ahorro de energía

Apagado automático: 2 min

### Tiempo de calentamiento

30 segundos (cabeza cerrada y bloqueada)

### Soporte móvil para vasos de recetas grandes

Posición independiente ajustable

### Longitud del cable del dispositivo.

75 cm

### Dimensiones (W x D x H)

13.6 x 42.6 x 25 cm / 5.3 x 16.7 x 9.8 in

### Peso

3.5 kg / 7.72 lbs

### Capacidad del tanque de agua

0.6 l / 20 fl oz

### Capacidad del contenedor de cápsulas

8 cápsulas espresso o 5 cápsulas mug

## CÓDIGOS DE MÁQUINA

### Nespresso

GCV2, GDV2

### Breville

BNV120, BNV150

### Delonghi

ENV90

### Krups

XN9201, XN9204,  
XN9205, XN9211

### Magimix

M800

## CLIQUE E SELECIONE O SEU IDIOMA

**PT**



**SEGURANÇA**



**VISÃO GERAL**



**CONETIVIDADE**



**PRIMEIROS PASSOS**



**PREPARAÇÃO DE CAFÉ**



**ADAPTE O VOLUME DO SEU CAFÉ**



**LIMPEZA**



**DESCALCIFICAÇÃO**



**ESVAZIAR O SISTEMA**



**REPOR DEFINIÇÕES DE FÁBRICA**



**SUMÁRIO DE ALERTAS LUMINOSOS**



**RESOLUÇÃO DE PROBLEMAS**



**ESPECIFICAÇÕES**

## SEGURANÇA

**ATENÇÃO:** Antes da utilização da sua máquina, por favor consulte as instruções de segurança, para evitar danos e lesões.

## ELIMINAÇÃO E PROTEÇÃO AMBIENTAL

Este aparelho cumpre com as Diretiva da EU 2012/19/EC. O material de embalagem e o equipamento contêm materiais recicláveis. O seu aparelho contém materiais valiosos que podem ser recuperados ou reciclados. A separação dos restantes materiais residuais por tipo facilita a reciclagem de matérias-primas valiosas. Deixe o aparelho num ponto de recolha. Pode obter informações sobre a eliminação junto das autoridades locais.

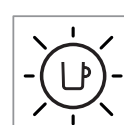
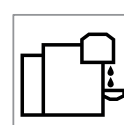
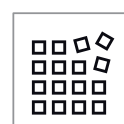
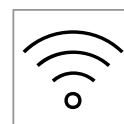

## VISÃO GERAL

### VISÃO GERAL DA MÁQUINA

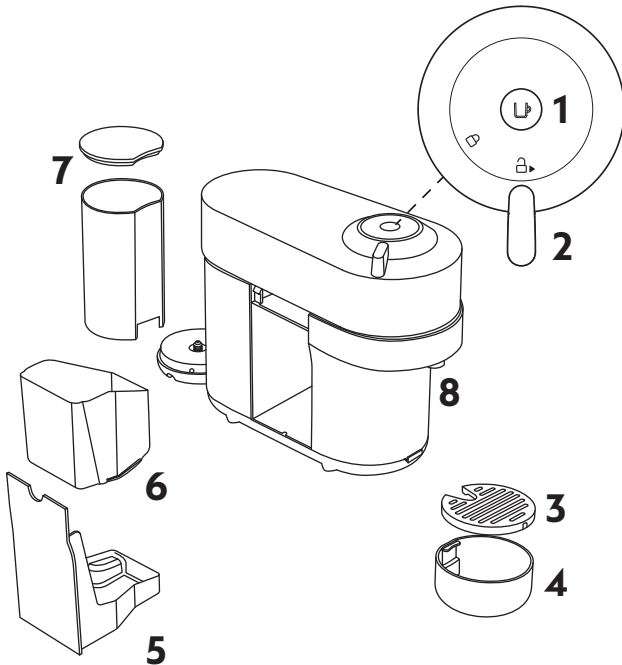

- 1 Botão ON/OFF e de café
- 2 Manípulo de bloqueio e desbloqueio
- 3 Grelha da bandeja de gotas
- 4 Suporte de chávenas ajustável
- 5 Base do recipiente de cápsulas usadas
- 6 Depósito de cápsulas usadas
- 7 Depósito de água e tampa
- 8 Saída de café

### CONTEÚDO DA EMBALAGEM



- 1 Máquina de café
- 2 Kit de Cápsulas Nespresso
- 3 Material de boas-vindas Nespresso
- 4 Instruções de segurança
- 5 Guia de início rápido
- 6 Garantia

**i Ao desembalar:** poderá encontrar alguma poeira na superfície da máquina devido ao material reciclado utilizado na embalagem. Não é perigoso e poderá limpá-lo com um pano suave.

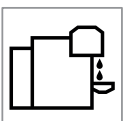

## ABRIR/FECHAR

## ABRIR

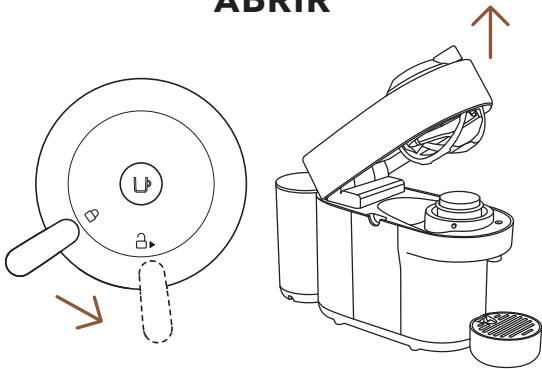

## FECHAR

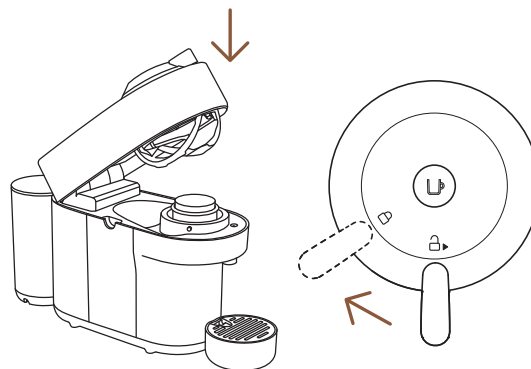

**ATENÇÃO:** para uma correta utilização do equipamento, não abra a máquina durante a preparação de café. Espere até o botão de café parar de piscar. Se desejar parar a preparação de café mais cedo, por favor pressione o botão de café uma vez e espere até que a máquina pare a extração antes de a abrir.

## O SISTEMA VERTUO

## COMPATIBILIDADE DE CÁPSULAS

**S**

**Ristretto**  
(25 ml)

**Espresso**  
(40 ml)

**M**

**Double Espresso**  
(80 ml)

**Gran Lungo**  
(150 ml)

**L**

**Mug**  
(230 ml)

**XL**

**Alto, Cold Brew Style**  
(355 ml)

**Carafe**  
(535 ml)

## COMPATIBILIDADE DE ACESSÓRIOS



Compati-  
bilidade de  
acessórios

**Ristretto****Espresso****Double Espresso****Gran Lungo****Mug (S)****Mug (M)****Copo Reveal**

Acessórios  
não compati-  
veis

**Mug (L)****Carafe**

Descubra a nossa coleção completa de acessórios em

[www.nespresso.com](http://www.nespresso.com)

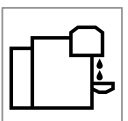

## ON/OFF

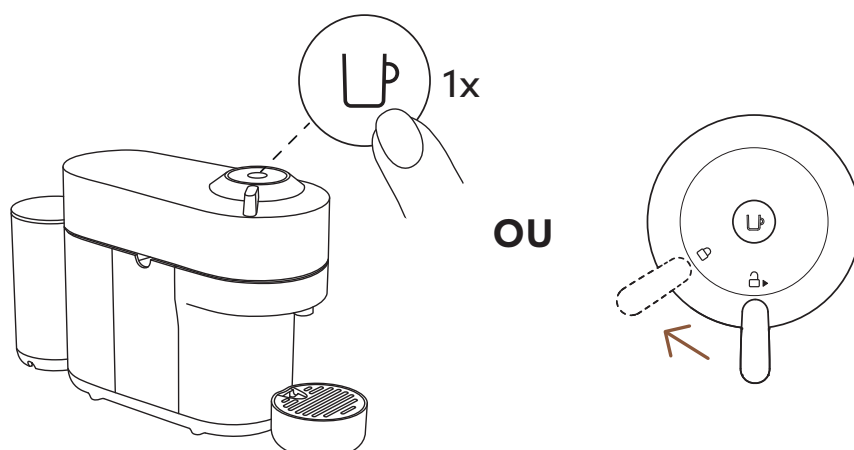
**ON**

Assim que a máquina estiver ligada à tomada, ligue-a pressionando o botão uma vez ou fechando o manípulo na posição de bloqueio (com a máquina fechada).

- i** A luz vai piscar durante aproximadamente 30 segundos, enquanto a máquina estiver a aquecer. Quando a luz parar de piscar, a máquina está preparada para ser utilizada.

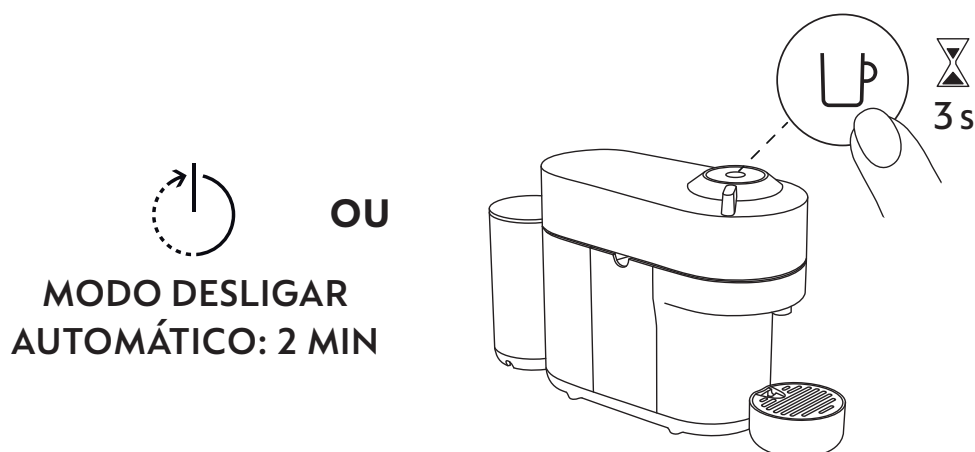
**OFF**

Para economizar energia a máquina desliga-se após 2 minutos de inatividade.

- i** A máquina pode ser desligada manualmente a qualquer momento (quando não estiver a ser utilizada) mantendo o botão pressionado durante 3 segundos.

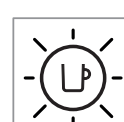
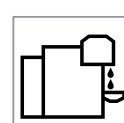
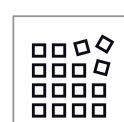
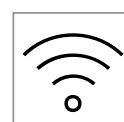

## CONETIVIDADE

### PORQUE DEVERÁ EMPARELHAR A SUA MÁQUINA VERTUO POP?



### BENEFÍCIOS DE EMPARELHAR A SUA MÁQUINA VERTUO POP

- **Preparação inteligente:** Esteja sempre a par das últimas inovações e novidades de café da **Nespresso**, mantendo a sua máquina atualizada
- **Conselho de especialistas:** Obtenha ajuda e vídeos com tutoriais simples para o acompanhar nas suas aventuras de café, através do seu smartphone
- **Cuidado da máquina:** Receba notificações instantâneas de como e quando deve fazer a manutenção da sua máquina, como descalcificação, lavagem, limpeza, ect.

### COMO EMPARELHAR A SUA MÁQUINA VERTUO POP?

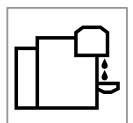





**1** Faça o download ou atualização da App **Nespresso**. Abra a App **Nespresso** no seu smartphone ou tablet. Toque no ícone da máquina, no canto superior direito do seu ecrã.

**NOTA:** para uma melhor experiência, recomendamos que conecte a sua máquina a um router Wi-Fi em vez de um hotspot.

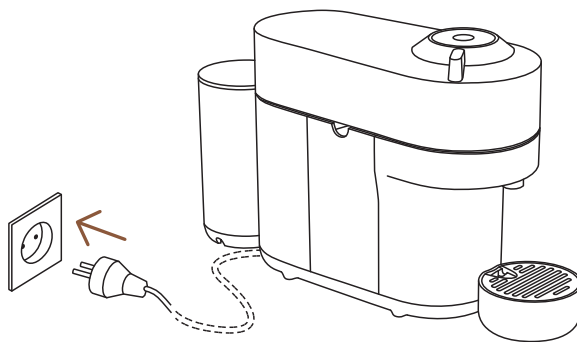

**2** Ligue o cabo de alimentação.



**3** Siga as instruções através da App **Nespresso**.

**ATENÇÃO:** Primeiro, leia as precauções de segurança para evitar riscos de incêndios ou choques elétricos fatais. Quando ligar a máquina de café a uma tomada elétrica, certifique-se por favor de que esta está ligada à terra.

\* Apple Store® é uma marca comercial da Apple Inc., registada nos EUA e outros países.

\*\* Google Play e o logótipo do Google Play são marcas comerciais da Google LLC.

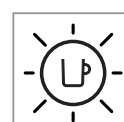
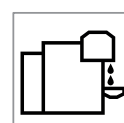
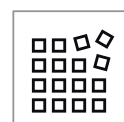

## DESATIVAR O BLUETOOTH E WI-FI DA MÁQUINA

A máquina tem um módulo de conectividade, ativado por defeito, que lhe dá acesso a funcionalidades adicionais, melhorando a sua experiência de café. Para desativar o módulo de conectividade, siga os seguintes passos:

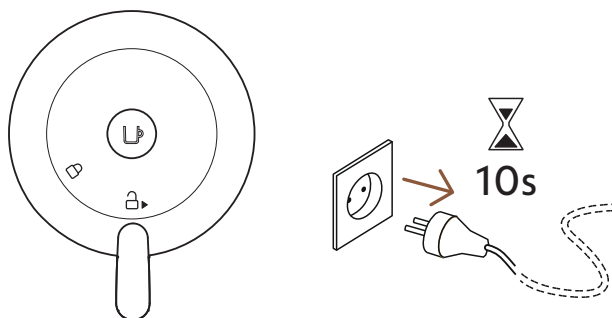

- 1 Com a máquina fechada e o manípulo na posição de **bloqueio**, desligue a máquina da tomada durante pelo menos 10 segundos.

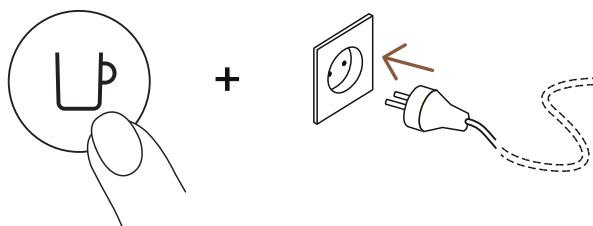

- 2 O botão vai piscar com uma luz branca para indicar que o módulo foi reativado. O botão vai piscar com uma luz laranja para confirmar que o módulo de conectividade foi desativado.

- i** Siga os mesmos passos para ativar novamente o módulo de conectividade. O botão vai piscar com uma luz branca para indicar que o módulo foi reativado.

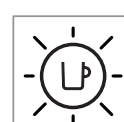
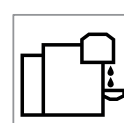
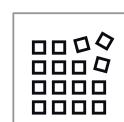

# PRIMEIROS PASSOS

## PRIMEIRA LAVAGEM

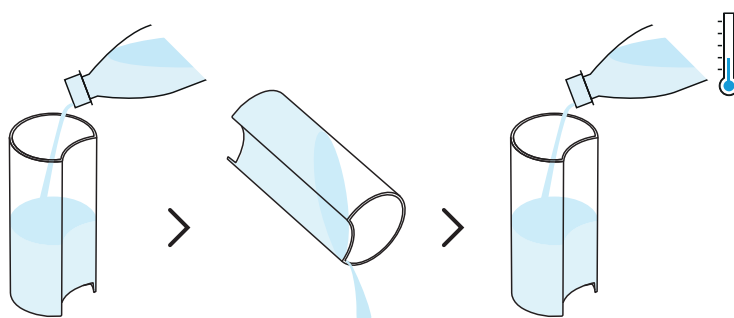

- 1** Primeiro, lave e limpe o depósito de água e a tampa antes de o encher com água fresca potável.

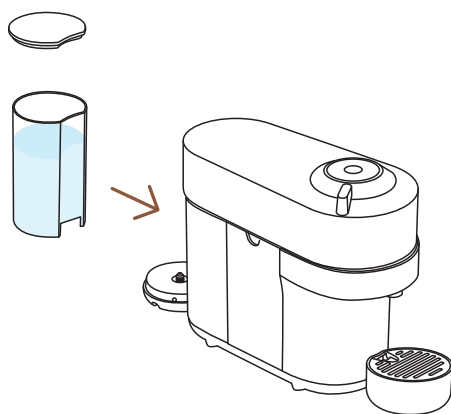

- 2** Feche o depósito de água e coloque-o no seu sítio, garantido que se encontra devidamente encaixado.

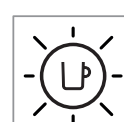
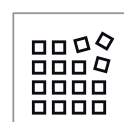
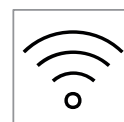

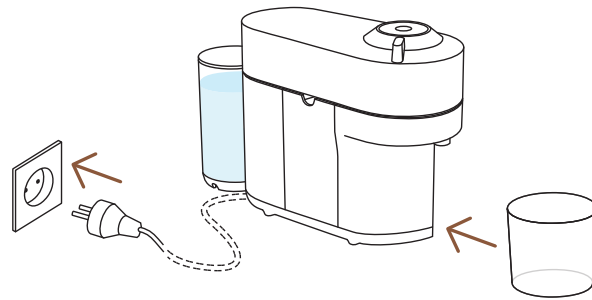

- 3** Com o cabo de alimentação ligado à tomada, remova o suporte de chávenas e coloque um recipiente (com pelo menos 1L) sob o bico de extração de café.

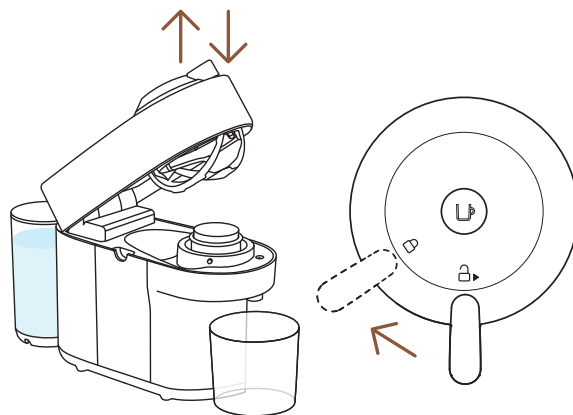

- 4** Abra e feche a máquina. Certifique-se que o manípulo está na posição de bloqueio.

- i** A luz vai piscar enquanto a máquina estiver a aquecer. Demorará aproximadamente 30 segundos. Quando a luz parar de piscar, a máquina está pronta para ser utilizada. Certifique-se que não está nenhuma cápsula inserida na máquina.

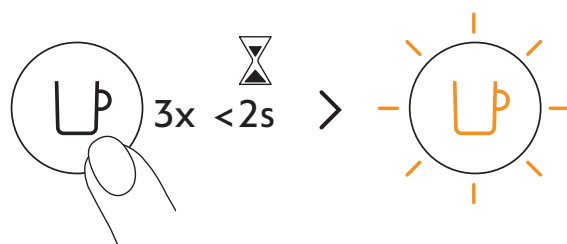

- 5** Pressione o botão 3 vezes durante 2 segundos, para começar a lavar. Com a luz laranja a piscar, deixe o processo de lavagem terminar automaticamente. Quando a luz parar de piscar e ficar branca, o ciclo foi completado.

- i** Deverá demorar menos de 2 minutos até o processo de lavagem iniciar e a água começar a fluir. Este procedimento pode demorar até 7 minutos.

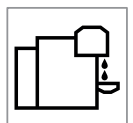

# PREPARAÇÃO DE CAFÉ

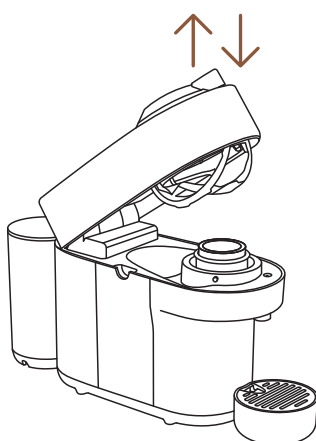

**1** Abra e feche a máquina.

**i** A luz do botão de café vai piscar enquanto a máquina estiver a aquecer. Quando a luz parar de piscar, a máquina está preparada para ser utilizada.

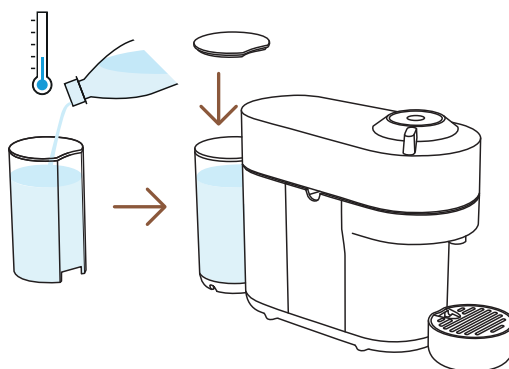

**2** Encha o depósito de água com água fresca potável e coloque-o no seu sítio.

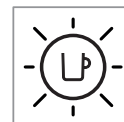
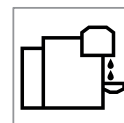
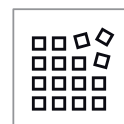
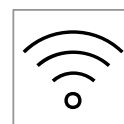

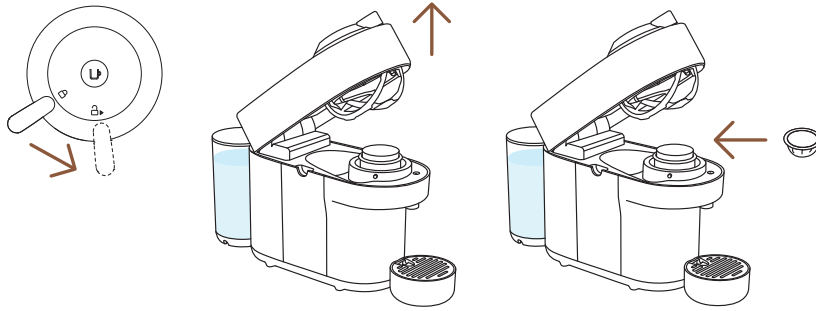

- 3** Desbloqueie o manípulo, abra a máquina completamente e insira uma cápsula Vertuo com o código de barras virado para baixo.

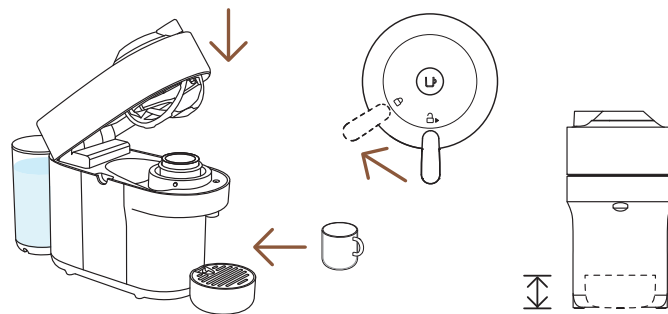

- 4** Feche a máquina, bloqueie-a rodando o manípulo para a esquerda até à posição de bloqueio e coloque uma chávena. O suporte de chávenas pode ser ajustado para se adaptar ao tamanho da sua chávena.

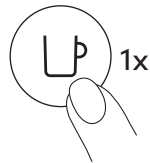

- 5** Inicie a extração pressionando o botão uma vez.

**ATENÇÃO:** para uma correta utilização do equipamento, não abra a máquina durante a preparação de café. Espere até o botão de café parar de piscar. Se desejar parar a preparação de café mais cedo, por favor pressione no botão de café uma vez e espere até que a máquina pare a extração antes de a abrir.

- i** Levará algum tempo até ao fluxo de café iniciar, devido à leitura do código de barras, ao pré-humedecimento e tempo de infusão. A máquina reconhecerá automaticamente a cápsula inserida e seleciona os parâmetros de preparação do café e tamanho de chávena, definidos pelos especialistas **Nespresso**, para extrair o melhor de cada café.



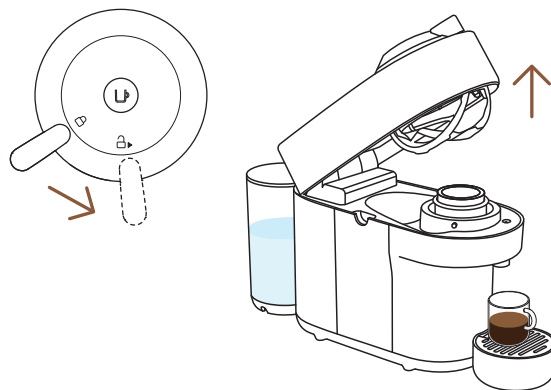

- 6** Quando o fluxo de café parar, abra a máquina rodando o manípulo para a direita até à posição de desbloqueio, para ejetar a cápsula de café automaticamente.



- 7** Recicle a sua cápsula.\*

\* SE É **NESPRESSO**, É RECICLÁVEL. Para mais informações sobre o nosso programa de reciclagem, visite [www.nespresso.com](http://www.nespresso.com)

## DESCUBRA O NOSSO MODO COFFEE CREATIONS



Com esta máquina, a **Nespresso** oferece-lhe uma funcionalidade única para concentrar as suas extrações de café e criar as suas próprias receitas.

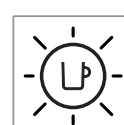
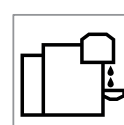
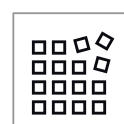
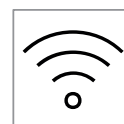

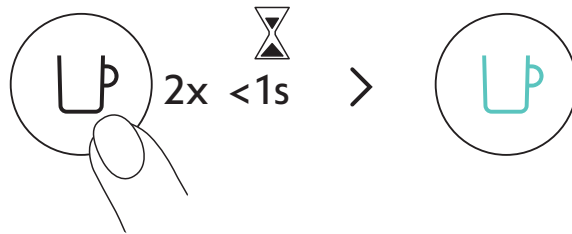

Com a máquina ligada, pressione duas vezes no botão de café. O botão vai piscar com uma luz turquesa e a extração de café será concentrada, otimizando o sabor do café nas suas receitas com outros complementos (como leite e gelo, por exemplo). Para uma experiência de café incomparável.

40 ml	80 ml	150 ml	230 ml	355 ml	535 ml
✓	✓	✓	✓	✗	✗
25 ml	40 ml	40 ml	80 ml		

Para usufruir dos seus benefícios ao máximo, recomendamos que extraia os cafés da nossa gama Coffee+ com a medida original. Para melhores resultados em chávena, não recomendamos que extraia as gamas de cápsulas Alto, Cold Brew Style e Carafe com este modo.

**NOTA:** Poderá ser necessária uma atualização à sua máquina, através da app **Nespresso**, para ativar este modo.

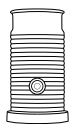

Descubra como melhorar a sua experiência com a nossa gama de Aeroccinos em [www.nespresso.com](http://www.nespresso.com)

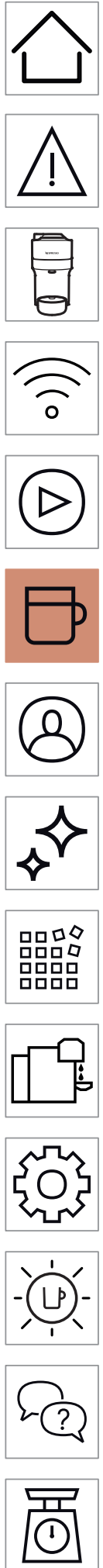



## AJUSTAR O VOLUME DOS SEUS CAFÉS

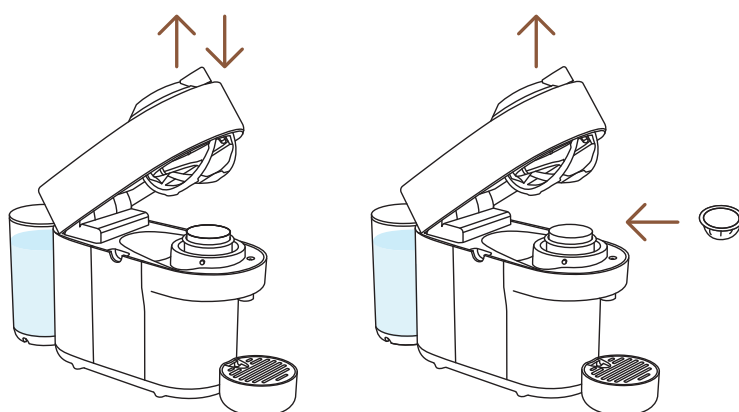

- 1** Abra e feche a máquina. Com a máquina ligada, abra-a e insira a cápsula que pretende programar.

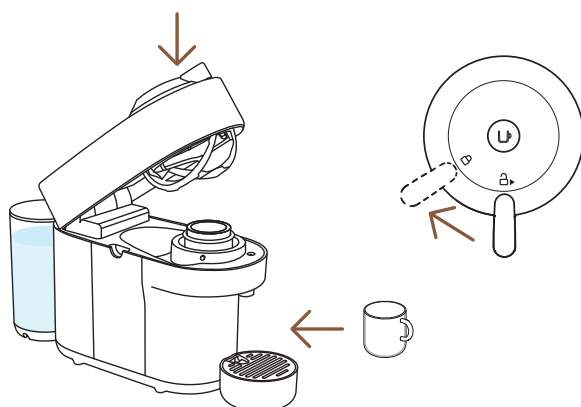

- 2** Feche a máquina, rode o manípulo para esquerda até à posição de bloqueio e coloque uma chávena.

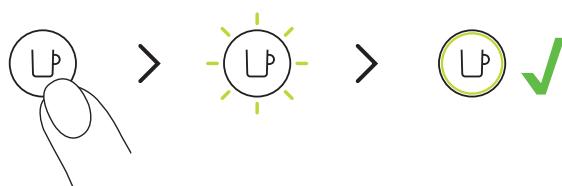

- 3** Pressione e mantenha pressionado o botão até a quantidade desejada ser alcançada. O novo volume de extração encontra-se agora atualizado para o tamanho de cápsula usado durante a programação.

- i** O programa é específico para cada tipo de cápsula. Os tamanhos das chávenas podem ser programados desde 20 ml até 535 ml.

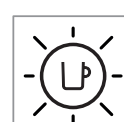
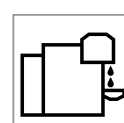
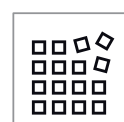
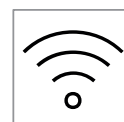

**ATENÇÃO:** para uma correta utilização do equipamento, não abra a máquina durante a preparação de café. Espere até o botão de café parar de piscar. Se desejar parar a preparação de café mais cedo, por favor pressione no botão de café uma vez e espere até que a máquina pare a extração antes de a abrir.

**NOTA:** Depois de um utilizador programar um volume específico, sempre que uma cápsula do mesmo tamanho for inserida na máquina, o fluxo vai parar na quantidade programada. Se desejar repor o volume inicial, consulte o capítulo “Repor definições de fábrica”.

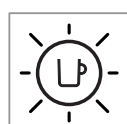
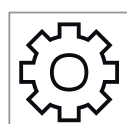
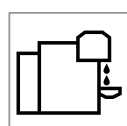
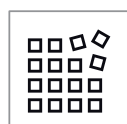
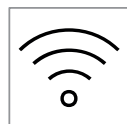

## LIMPEZA

Limpe a sua máquina mensalmente, quando começar a verificar resíduos de café no interior ou após um período longo de inatividade.

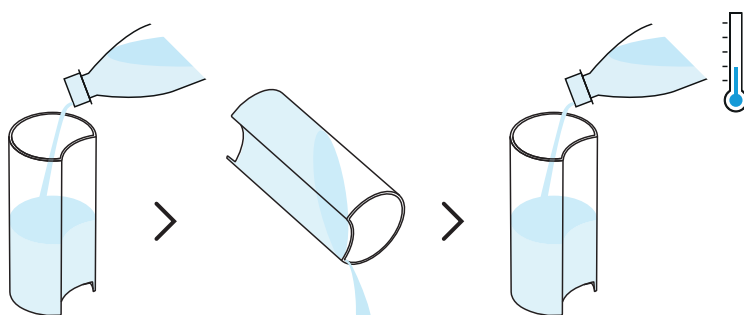

- 1** Lave e limpe o depósito de água e a tampa antes do encher com água fresca potável.

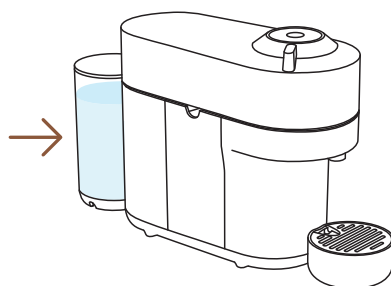

- 2** Encaixe o depósito de água no seu sítio.

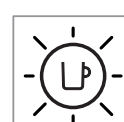
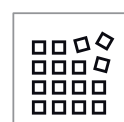
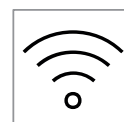

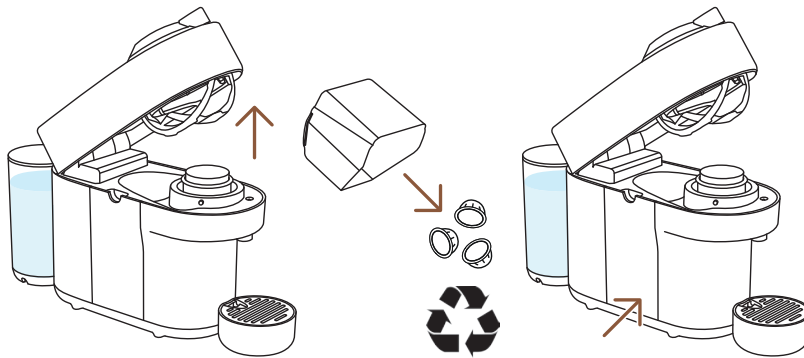

- 3** Desbloqueie e abra a máquina para que a cápsula seja ejetada. Esvazie e lave o depósito de cápsulas e a bandeja de gotas e coloque-nos no seu sítio. Recicle a sua cápsula.\*

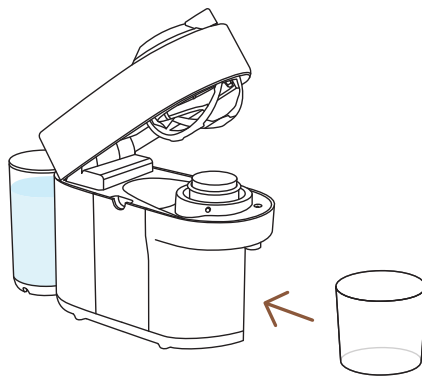

- 4** Remova o suporte de chávenas e coloque um recipiente vazio (com pelo menos 1L) sob o bico de extração de café.

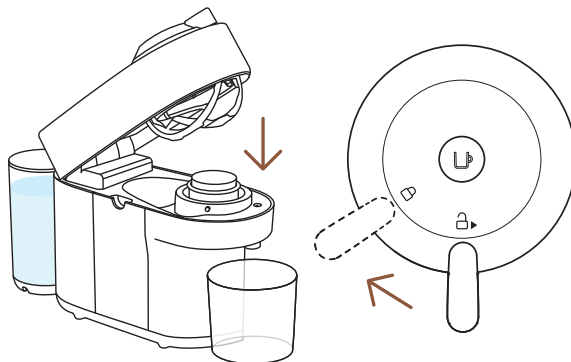

- 5** Feche a máquina e rode o manípulo para a esquerda, até à posição de bloqueio. Certifique-se que não está nenhuma cápsula inserida na máquina antes de começar o processo de limpeza.

\* SE É **NESPRESSO**, É RECICLÁVEL. Para mais informações sobre o nosso programa de reciclagem, visite [www.nespresso.com](http://www.nespresso.com)

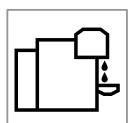

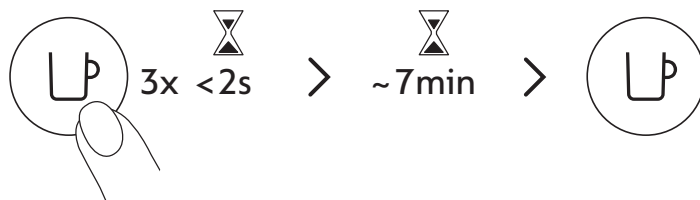

- 6** Pressione o botão 3 vezes durante 2 segundos, para começar a lavar. Deixe o processo de limpeza completar automaticamente.

- i** Deverá demorar menos de 2 minutos até o processo de limpeza iniciar e a água começar a fluir. Este processo poderá demorar até 7 minutos e vai parar automaticamente quando o ciclo terminar. O procedimento pode ser parado em qualquer altura, premindo o botão.

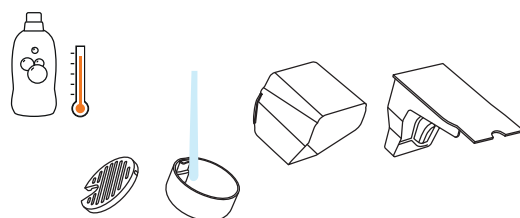

- 7** Lave o depósito de cápsulas, o suporte de chávenas e a bandeja de gotas com água quente e um detergente sem fragrância.

**ATENÇÃO:** Não deverá usar escovas e objetos abrasivos, assim como produtos de limpeza fortes ou solventes. Não coloque a máquina na máquina de lavar. Nunca mergulhe a máquina ou qualquer parte em água.

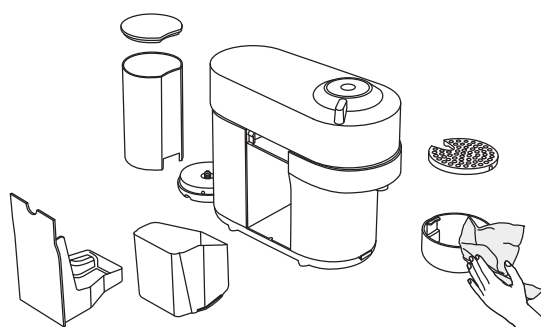

- 8** Seque com um pano limpo.

**ATENÇÃO:** Limpe o bico de extração de café regularmente com um pano limpo e húmido. Utilize sempre panos suaves para limpar a máquina.

**NOTA:** É possível que a água se acumule no interior da unidade de extração. Por favor, seque as partes visíveis com um pano limpo e seco.

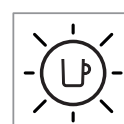
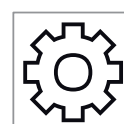
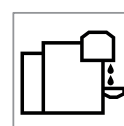
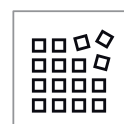
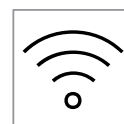

## DESCALCIFICAÇÃO

A descalcificação da sua máquina garante um bom funcionamento e uma experiência de café tão incomparável como o primeiro dia de utilização. A sua máquina vai indicar-lhe quando a descalcificação é necessária, ao piscar com uma luz laranja 3 vezes antes de se tornar numa luz branca e fixa.



**i** A descalcificação demora aproximadamente 20 minutos e **não poderá ser interrompida**.

**NOTA:** Por favor, leia atentamente as instruções de descalcificação antes de começar.

### Precisará de:

- Um kit de descalcificação disponível em [www.nespresso.com](http://www.nespresso.com)
- Um recipiente vazio (com 1L)

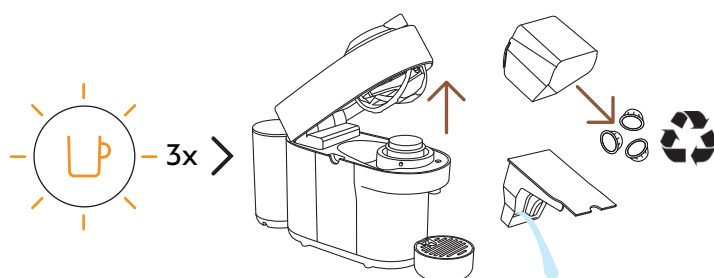

**1** Com o botão laranja a piscar 3 vezes: Desbloqueie e abra a máquina para que a cápsula seja ejetada. Esvazie o depósito de cápsulas e a bandeja de gotas e coloque-os no seu sítio. Recicle a sua cápsula.\*

\* SE É **NESPRESSO**, É RECICLÁVEL. Para mais informações sobre o nosso programa de reciclagem, visite [www.nespresso.com](http://www.nespresso.com)

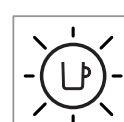
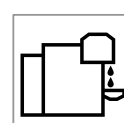
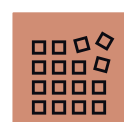
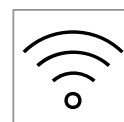

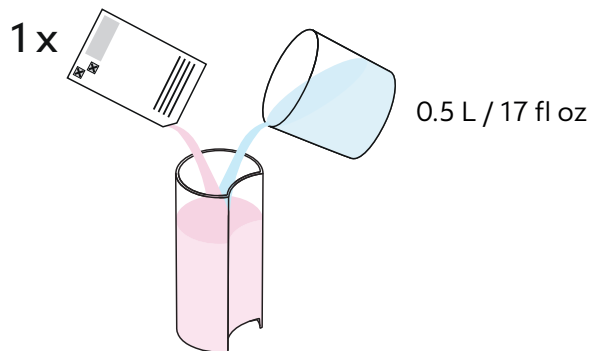

- 2** Encha o depósito de água com 0,5 L de água e adicione uma saqueta do líquido de descalcificação **Nespresso**.

**ATENÇÃO:** O agente descalcificador pode ser prejudicial. Evitar o contacto com os olhos, pele e superfícies.

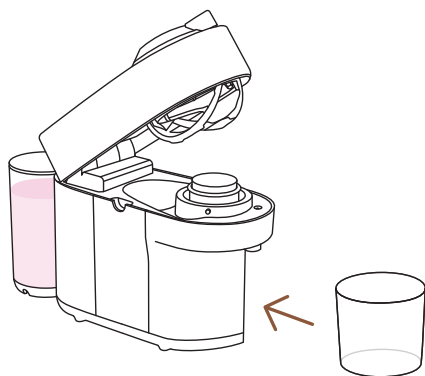

- 3** Remova o suporte de chávenas e coloque um recipiente vazio (com pelo menos 1L) sob o bico de extração de café.

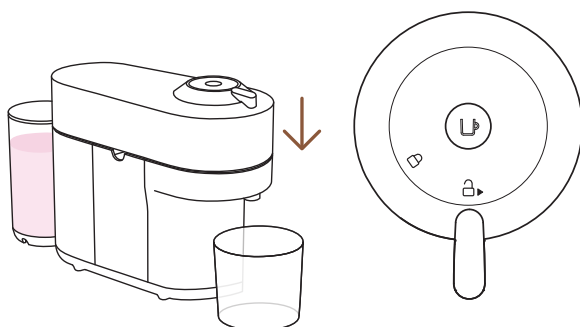

- 4** Com a máquina ligada, baixe alavanca para fechar e deixe o manípulo na posição de desbloqueio.

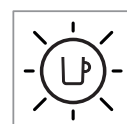
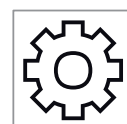
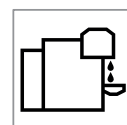
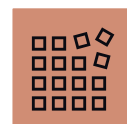
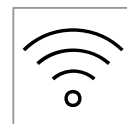
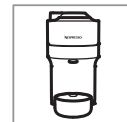

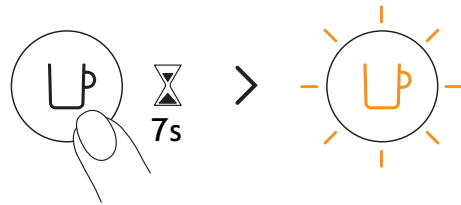

- 5** Mantenha pressionado o botão por pelo menos 7 segundos até a luz apagar. O botão vai piscar com uma luz laranja rapidamente.

**ATENÇÃO:** Tem 45 segundos para entrar no modo de descalcificação, caso contrário a máquina regressará ao modo de preparação de café.

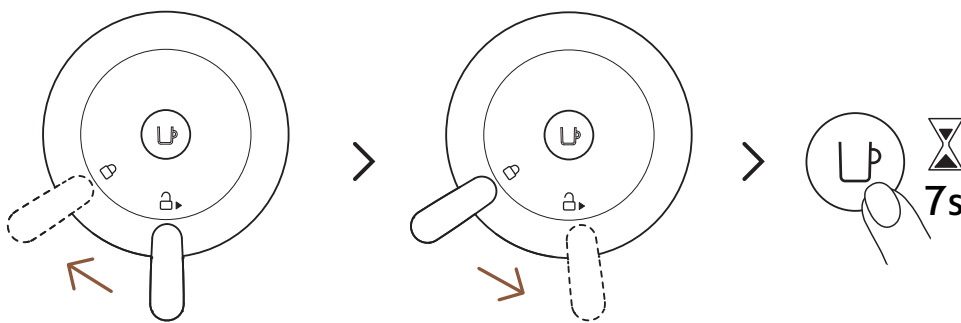

- 6** Bloqueie a máquina rodando o manípulo para a esquerda até ao símbolo de bloqueio e depois desbloqueie o manípulo rodando para a direita até à posição de desbloqueio. Mantenha pressionado o botão novamente por aproximadamente 7 segundos ou até a luz se apagar. O botão vai começar a piscar com uma luz laranja rapidamente.

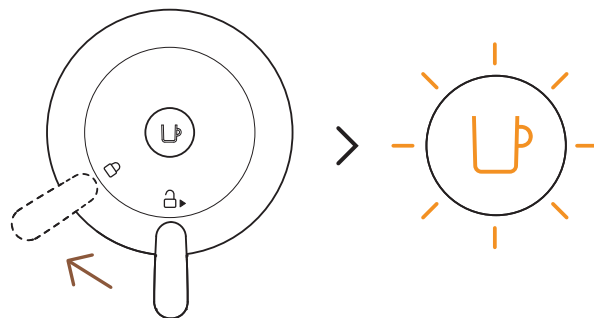

- 7** Para entrar no modo de descalcificação, bloqueie a máquina rodando o manípulo para a esquerda até à posição de bloqueio. A luz laranja deverá continuar a piscar rapidamente. Isto significa que entrou no modo de descalcificação.

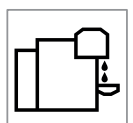
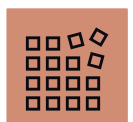



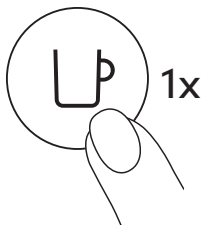

- 8** Pressione o botão de café uma vez para iniciar o processo de descalcificação. A luz laranja vai piscar continuamente durante o processo.

- i** A máquina vai parar automaticamente quando a primeira fase da descalcificação estiver concluída.

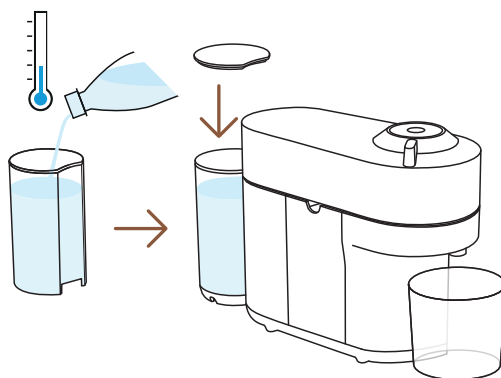

- 9** Quando o processo de descalcificação terminar, deverá limpar a máquina. Lave bem o depósito de água e a bandeja de gotas.

Encha o depósito de água com água fresca potável e coloque-o de volta. Esvazie o recipiente e coloque-o novamente sob o bico de extração de café.

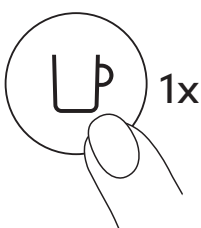

- 10** Pressione o botão para lavar a máquina. Quando o botão parar de piscar rapidamente e a luz se tornar fixa, o processo de descalcificação foi completado.

- i** A máquina vai parar automaticamente quando o procedimento for completado.

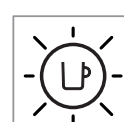
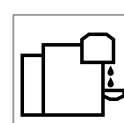
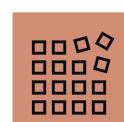
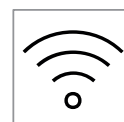

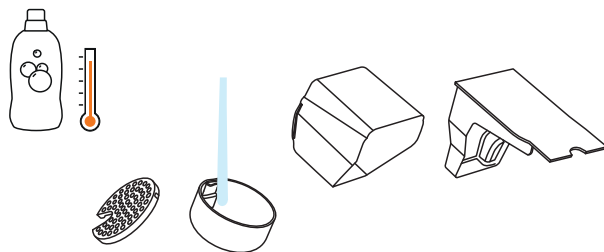

- 11** Lave o depósito de cápsulas, o suporte de chávenas e a bandeja de gotas com água quente e um detergente sem fragrância.

**ATENÇÃO:** Não deverá usar escovas e objetos abrasivos, assim como produtos de limpeza fortes ou solventes. Não coloque a máquina na máquina de lavar. Nunca mergulhe a máquina ou qualquer parte em água.

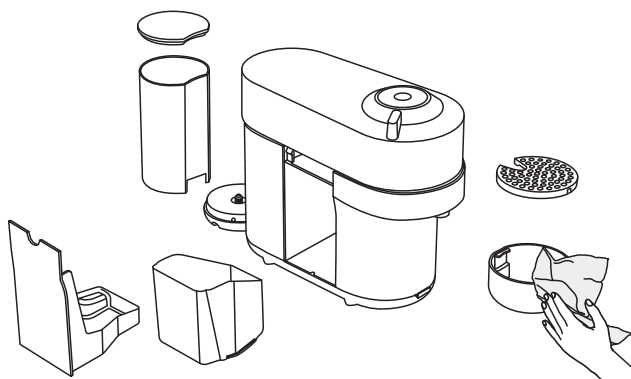

- 12** Seque com um pano limpo. Deixe a máquina secar durante 10 minutos, antes de a utilizar.

**NOTA:** Durante a limpeza, poderá acumular-se água no sistema de extração da máquina. Caso aconteça, por favor seque as partes visíveis com um pano limpo e seco.

**NOTA:** A máquina só poderá entrar em modo de descalcificação após 30 ou mais extrações de café.

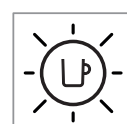
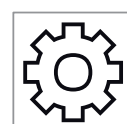
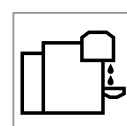
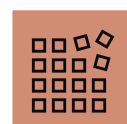
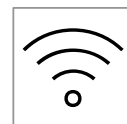

## ESVAZIAMENTO DO SISTEMA

O esvaziamento do sistema é um processo que pode ser efetuado antes de um período longo de inatividade, para proteção anti-congelamento, ou antes de enviar a máquina para reparação.

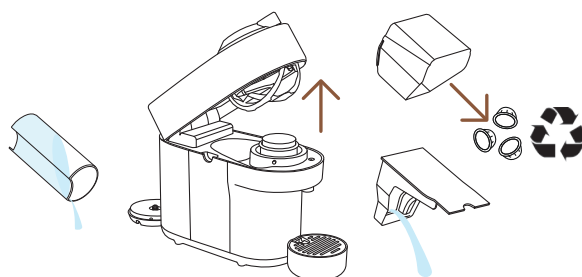

- 1** Esvazie o depósito de água e abra a máquina para que a cápsula seja ejetada. Esvazie o depósito de cápsulas e a bandeja de gotas. Recicle a sua cápsula.\*

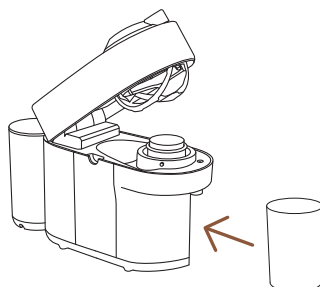

- 2** Coloque os novamente na máquina, retire o suporte de chávenas e coloque um recipiente vazio (0,5L) sob o bico de extração de café.

\* SE É **NESPRESSO**, É RECICLÁVEL. Para mais informações sobre o nosso programa de reciclagem, visite [www.nespresso.com](http://www.nespresso.com)



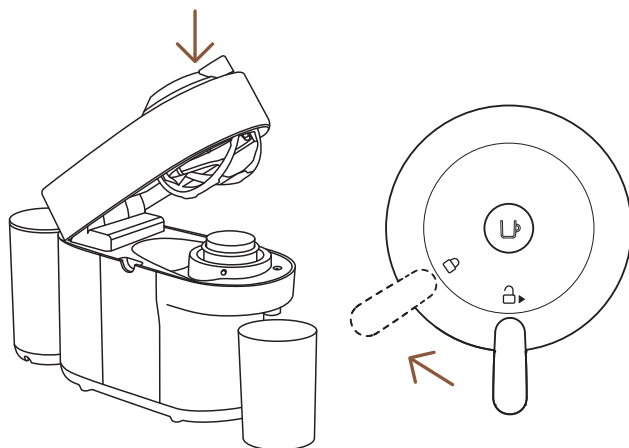

- 3** Com a máquina ligada, rode o manípulo até à posição de bloqueio.

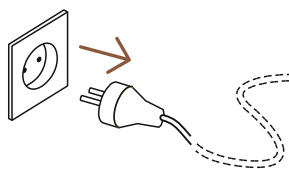

- 4** Desligue a máquina da tomada

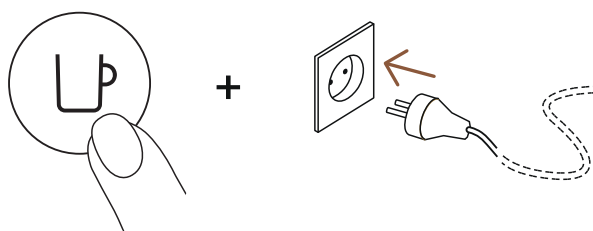

- 5** Mantenha o botão pressionado enquanto liga a máquina à tomada.

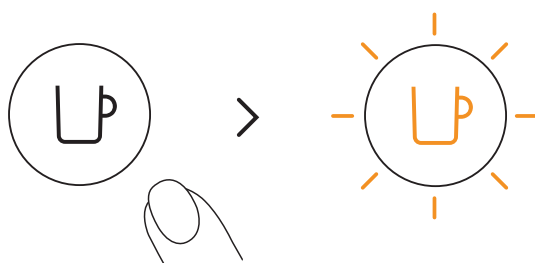

- 6** Solte o botão. O botão vai piscar com uma luz laranja e o processo de esvaziamento será iniciado.

- i** Demorará aproximadamente 30 segundos até à máquina completar o processo de esvaziamento. A máquina desligará automaticamente quando estiver vazia.

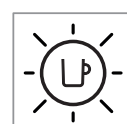
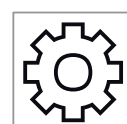
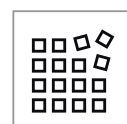
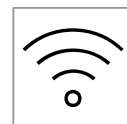

## REPOSIÇÃO DE DEFINIÇÕES DE FÁBRICA

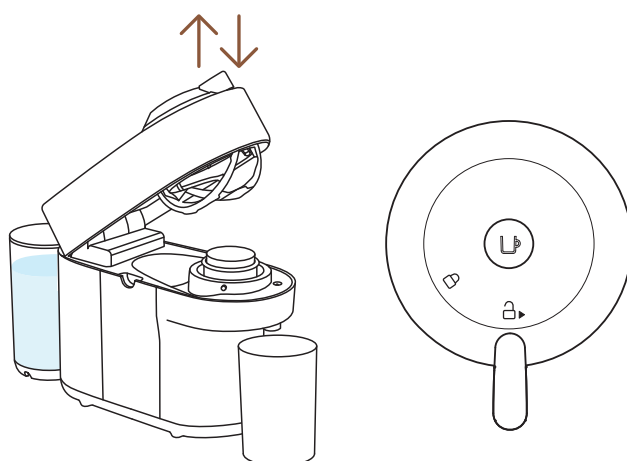

- 1 Com a máquina ligada, abra-a e feche-a antes de deixar o manípulo na posição de **bloqueio**.

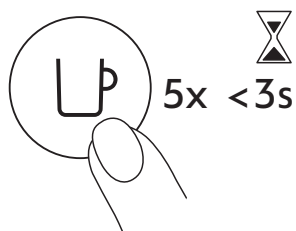

- 2 Pressione o botão 5 vezes durante 3 segundos. A máquina está agora programada com as definições de fábrica.

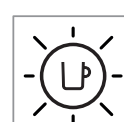
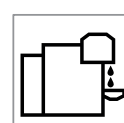
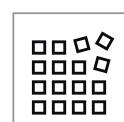
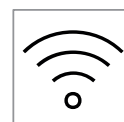

## SUMÁRIO DE ALERTAS LUMINOSOS

Gostaria de saber mais sobre os alertas luminosos da Vertuo Pop?  
Por favor, assista ao seguinte vídeo:

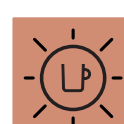
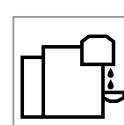
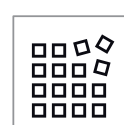
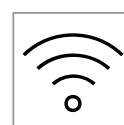

## RESOLUÇÃO DE PROBLEMAS

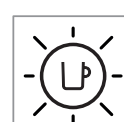
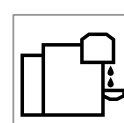
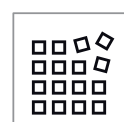
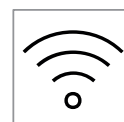

### Botão sem luz

- A máquina desligou-se automaticamente; pressione o botão ou desbloqueie a máquina.
- Verifique a rede elétrica, a tomada, tensão e o fusível.

### Sem fluxo de café ou água.

- Verifique se o depósito de água está cheio.
- Verifique se a cápsula nova está colocada na posição correta, se o manípulo está corretamente bloqueado e pressione o botão para iniciar.
- Descalcifique se necessário.
- Abra a máquina para que a cápsula seja ejetada. Depois, limpe-a de acordo com as instruções do capítulo de limpeza.

### Café pouco quente.

- Aqueça previamente a chávena com água quente da torneira.
- Descalcifique se necessário.

### Fuga ou fluxo anormal de café.

- Verifique se o depósito de água está bem colocado.
- Descalcifique se necessário

### A máquina desliga-se.

- Para economizar energia a máquina desliga-se após 2 minutos de inatividade.
- A máquina pode ser desligada manualmente a qualquer momento (quando não estiver a ser utilizada) mantendo pressionado o botão por 3 segundos.

### Borra de café na chávena.

- Faça o procedimento de limpeza 2 vezes.
- Consulte o capítulo **“Limpeza”**.

### A máquina não inicia e tem a luz fixa. Se piscar, consulte os pontos seguintes.

- Verifique se o manípulo está bloqueado corretamente.
- Se quiser preparar um café, verifique se a cápsula nova está colocada na posição correta, se o manípulo está na posição de bloqueio e pressione o botão para iniciar.
- Se estiver a limpar, descalcificar ou a esvaziar o sistema, não coloque nenhuma cápsula na máquina, depois feche-a, bloqueie o manípulo e pressione o botão para iniciar uma destas operações.

**A máquina não inicia e tem as luzes a piscar alternadamente; pisca 1 vez e pausa 1 vez.**

**A luz pisca enquanto a máquina está a funcionar.**

**A máquina não inicia e tem as luzes a piscar alternadamente; pisca 1 vez e pausa 1 vez.**

- Encha o depósito de água e pressione o botão para iniciar.
- Verifique se o manípulo está bloqueado corretamente.
- Se o café flui normalmente, significa que a máquina está a funcionar corretamente.
- Se sair apenas água, a máquina está a executar uma ação solicitada pelo utilizador, como limpeza, descalcificação ou esvaziamento do sistema. Por favor, verifique o capítulo correspondente.
- Desligue a máquina, pressionando o botão por 3 segundos e depois pressione novamente para ligar a máquina. Agora aguarde aproximadamente 20 minutos para permitir que a máquina arrefeça, após uma utilização intensa.
- Levará algum tempo até que o café comece a fluir (devido à leitura do código de barras e ao pré-humedecimento do café).
- Verifique se a cápsula nova está colocada na posição correta, se o manípulo está corretamente bloqueado e pressione o botão para iniciar.
- Encha o depósito de água e pressione o botão para iniciar.
- Desligue a máquina, pressionando o botão por 3 segundos e depois pressione novamente para ligar a máquina. Agora aguarde aproximadamente 20 minutos para permitir que a máquina arrefeça, após utilização intensa.

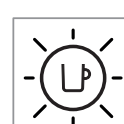
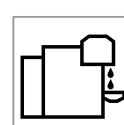
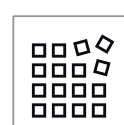
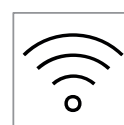



**A luz pisca alternadamente (pisca 2 vezes e faz uma pausa contínua). A máquina não está a funcionar.**

- Durante a preparação regular de café/ Espresso:
  - 1) Desbloqueie o manípulo e abra a máquina para verificar se a cápsula nova está colocada na posição correta.
  - 2) Verifique se o manípulo está na posição de bloqueio.
  - 3) Verifique se o depósito de água está cheio.
- Durante a descalcificação, esvaziamento e limpeza:
  - 1) Verifique se a cápsula foi ejetada.
  - 2) Verifique se o manípulo está na posição de bloqueio.
- Durante a programação do volume de chávena:
  - 1) Verifique se a cápsula está bem inserida.
  - 2) Por favor, verifique o capítulo correspondente **“Ajustar o volume dos seus cafés”**
- Se o problema persistir:
  - 1) Desbloqueie o manípulo e abra a máquina.
  - 2) Substitua a cápsula (se necessário).
  - 3) Desligue a máquina da tomada e passados 10 segundos, volte a ligar.
  - 4) Feche a máquina, pressione o botão para ligar a máquina e pressione novamente para começar a extração.

Se o problema persistir, por favor contacte a **Nespresso**.

**A luz pisca alternadamente (pisca 3 vezes e depois fixa).**

- É necessário descalcificar a máquina. Após aparecer o alerta luminoso, a máquina apenas poderá ser utilizada algumas vezes, antes da descalcificação se tornar necessária.

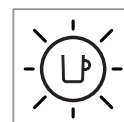
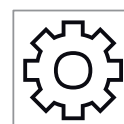
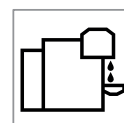
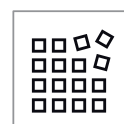
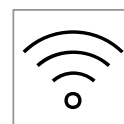

## ESPECIFICAÇÕES

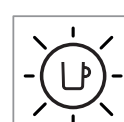
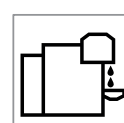
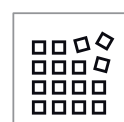
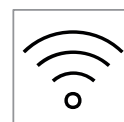

### Energia

**~220–240 V, 50–60 Hz, 1300–1500 W**  
**US, CA:** 120 V, 60 Hz, 1500 W  
**MX:** 127 V~, 60 Hz, 1380 W

### Frequência

2.402–2.480 GHz

### Potência de saída RF (EIRP)

Bluetooth 4 dBm Max. e.i.r.p. e Wi-Fi  
 <20 dMm max. e.i.r.p.

### Modo Standby

0.39 W/h

### Modo de poupança energética

Modo desligar automático: 2 min

### Tempo de aquecimento

30 segundos (máquina fechada e bloqueada)

### Suporte de chávenas ajustável para receitas maiores

Posição única ajustável

### Comprimento do cabo de alimentação

75 cm

### Dimensões (L x P x A)

13.6 x 42.6 x 25 cm / 5.3 x 16.7 x 9.8 in

### Peso

3.5 kg / 7.72 lbs

### Capacidade do depósito de água

0.6 l / 20 fl oz

### Capacidade do depósito de cápsulas usadas

8 cápsulas espresso ou 5 cápsulas mug

## CÓDIGOS DE MÁQUINA

### Nespresso

GCV2, GDV2

### Breville

BNV120, BNV150

### Delonghi

ENV90

### Krups

XN9201, XN9204,  
 XN9205, XN9211

### Magimix

M800

# KLIKNĚTE A ZVOLTE JAZYK

CS



**BEZPEČNOST**



**PŘEHLED**



**KONEKTIVITA**



**ZAČÍNÁME**



**PŘÍPRAVA KÁVY**



**PŘIZPŮSOBTE SI OBJEM KÁVY**



**ČIŠTĚNÍ**



**ODVÁPNĚNÍ**



**VYPRÁZDNĚNÍ KÁVOVARU**



**OBNOVENÍ TOVÁRNÍCH NASTAVENÍ**



**VÝZNAM SVĚTELNÝCH SIGNÁLŮ**



**ŘEŠENÍ PROBLÉMŮ**



**TECHNICKÉ ÚDAJE**

## BEZPEČNOST

**UPOZORNĚNÍ:** Než začnete kávovar používat, prostudujte si bezpečnostní pokyny. Předejdete tak újmě na zdraví a majetku nebo poškození přístroje.

### LIKVIDACE ODPADU A OCHRANA ŽIVOTNÍHO PROSTŘEDÍ

Tento přístroj vyhovuje směrnici EU 2012/19/EC. Váš přístroj obsahuje cenný materiál, který může být obnoven nebo recyklován. Třídění ostatního odpadu na jednotlivé druhy zjednodušuje recyklaci cenných surovin. Odložte přístroj ve sběrném místě. Informace o likvidaci můžete získat od místních správních orgánů.

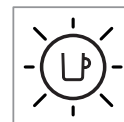
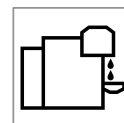
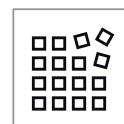
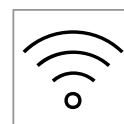

# PŘEHLED

## POPIS KÁVOVARU

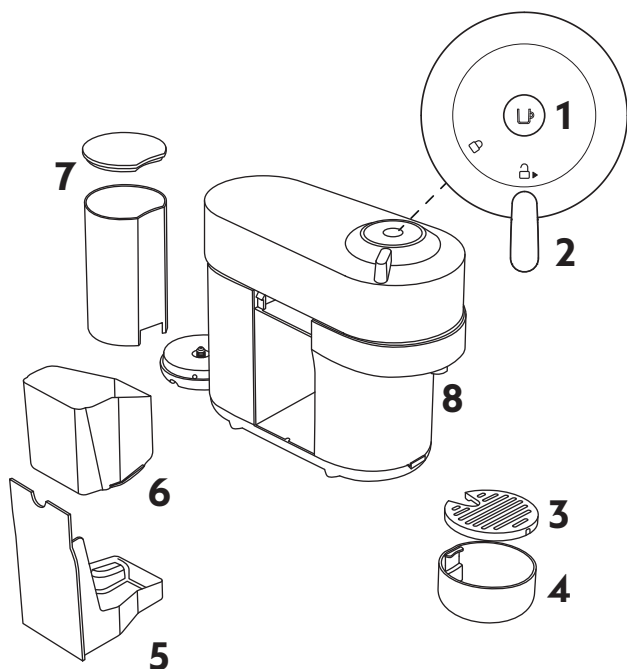

- 1 Tlačítko ZAPNOUT/  
VYPNOUT a pro  
přípravu kávy
- 2 Páka k uzamknutí/  
odemknutí
- 3 Odkapávací mřížka
- 4 Nastavitelný podstavec  
pod šálek
- 5 Odkapávací miska
- 6 Kontejner na použité  
kapsle
- 7 Nádoba na vodu s víkem
- 8 Výpusť kávy

## OBSAH BALENÍ



- 1 Kávovar
- 2 Degustační sada kapslí  
**Nespresso**
- 3 Bezpečnostní pokyny
- 4 Návod na rychlý start
- 5 Záruka

**i Vybalení:** na povrchu přístroje může být usazen prach z důvodu použití recyklovaných materiálů na obaly. Tento prach není nebezpečný. Stačí jej otřít jemným ubrouskem. Při vybalování odstraňte z kávovaru ochrannou fólii.

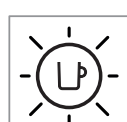
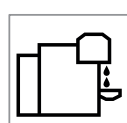
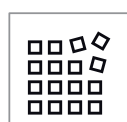
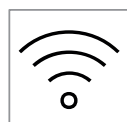

## OTEVŘÍT/ZAVŘÍT

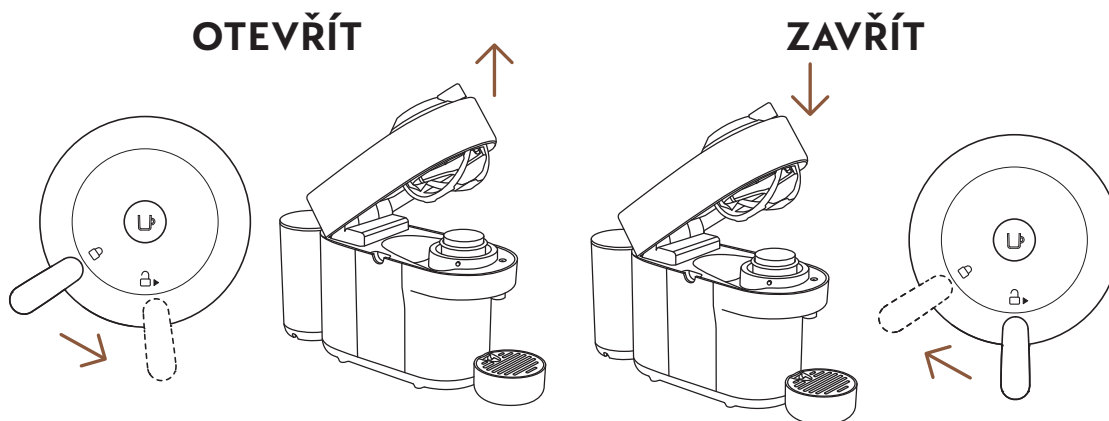

**UPOZORNĚNÍ:** v rámci správného používání kávovaru neotvírejte během přípravy kávy hlavu kávovaru, počkejte, až tlačítko pro přípravu kávy bude opět svítit bíle. Pokud chcete přípravu kávy předčasně ukončit, stiskněte jednou tlačítko pro přípravu kávy a počkejte, dokud tlačítko pro přípravu kávy nezačne znovu svítit bíle.

## VERTUO SYSTÉM

## KOMPATIBILNÍ KAPSLE

**S****Ristretto**

(25 ml)

**Espresso**

(40 ml)

**M****Double Espresso**

(80 ml)

**Gran Lungo**

(150 ml)

**L****Mug**

(230 ml)

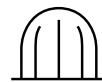
**XL****Alto, Cold Brew Style**

(355 ml)

**Carafe**

(535 ml)

## KOMPATIBILNÍ DOPLŇKY

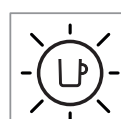
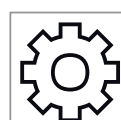
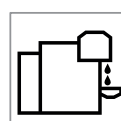
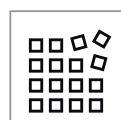
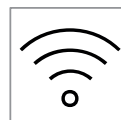
Kompatibilní  
doplňky**Ristretto****Espresso****Double  
Espresso****Gran  
Lungo****Mug (S)****Mug (M)****Reveal  
Glass**Nevhodné  
doplňky**Mug (L)****Carafe**Kompletní kolekci doplňků naleznete na [www.nespresso.com](http://www.nespresso.com).

## ZAPNUTÍ/VYPNUTÍ

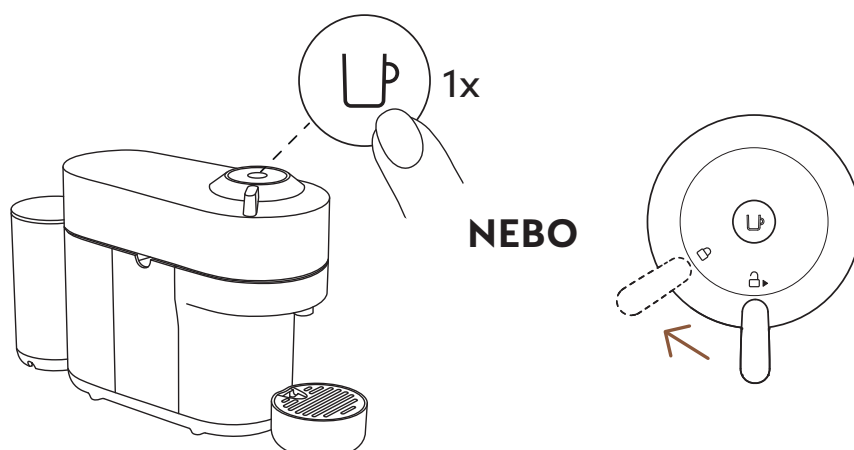

### ZAPNUTÍ

Když je kávovar zapojen v síti, zapněte ho stisknutím tlačítka nebo zatažením páky do uzamčené polohy (hlava kávovaru je zavřená).

- i** Kontrolka bude blikat přibližně 30 vteřin, probíhá proces nahřívání kávovaru. Když kontrolka přestane blikat, kávovar je připraven k použití.



### VYPNOUT

Kávovar se kvůli úspoře energie po 2 minutách nepoužívání automaticky vypne.

- i** Kávovar můžete kdykoliv VYPNOUT i manuálně (pokud ho právě nepoužíváte), a to stisknutím a podržením tlačítka po dobu 3 vteřin.

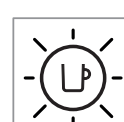
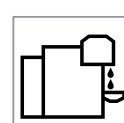
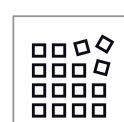
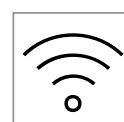

## KONEKTIVITA

### PROČ BYSTE MĚLI SPÁROVAT SVŮJ KÁVOVAR VERTUO POP?



### VÝHODY PŘIHOJENÍ VAŠEHO KÁVOVARU VERTUO POP

- **chytrá příprava kávy:** Buďte vždy o krok napřed a získejte nejnovější informace o kávových inovacích společnosti **Nespresso** tím, že budete svůj kávovar aktualizovat a udržovat ve špičkovém stavu.
- **odborné poradenství:** Získejte podporu a stáhněte si instruktážní videa do svého chytrého telefonu, která vás budou provázet na vaší cestě za kávou.
- **péče o kávovar:** Dostávejte upozornění jak a kdy provádět údržbu kávovaru s jednoduchými pokyny pro odvápnění, proplachování, čištění a další.

### JAK PŘIHOJIT VÁŠ KÁVOVAR VERTUO POP?

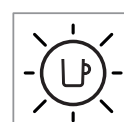
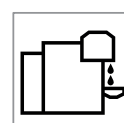
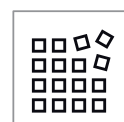



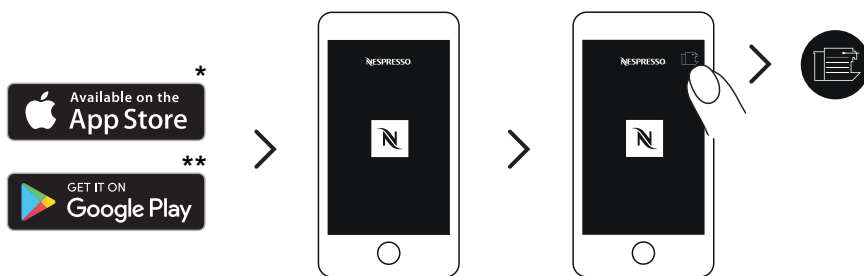

- 1** Stáhněte si nebo aktualizujte aplikaci **Nespresso**. Použijte aplikaci **Nespresso** ve svém chytrém telefonu nebo tabletu. Klikněte na ikonu kávovaru v pravém horním rohu obrazovky.

**POZNÁMKA:** pro optimální výkon a bezproblémový zážitek doporučujeme připojit váš kávovar k routeru Wi-Fi a nepoužívat hotspot chytrého telefonu.

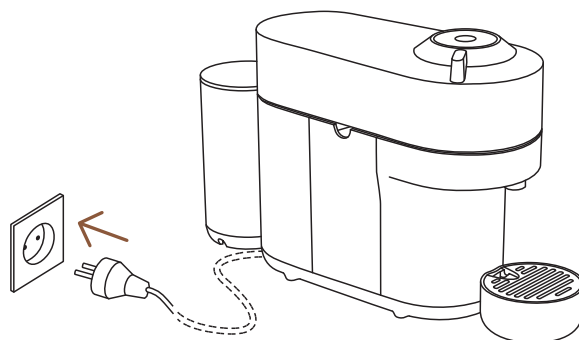

- 2** Zapojte napájecí kabel do sítě.



- 3** Postupujte podle instrukcí v aplikaci **Nespresso**.

**UPOZORNĚNÍ:** Nejdřív si prostudujte bezpečnostní upozornění, abyste předešli smrtelnému zásahu elektrickým proudem a požáru. Při zapojování kávovaru do elektrické zásuvky se ujistěte, že je uzemněn.

\* App Store® je ochranná známka společnosti Apple Inc., registrovaná v USA a dalších zemích.

\*\* Google Play a logo Google Play jsou ochranné známky společnosti Google LLC.

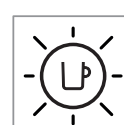
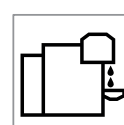
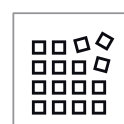

## DEAKTIVACE FUNKCÍ BLUETOOTH A WIFI NA KÁVOVARU

Kávovar je dodáván s přednastaveným modulem připojení. Umožňuje přístup k dalším funkcím, které vylepšují váš zážitek z kávy. Chcete-li deaktivovat modul připojení, postupujte podle následujících kroků:

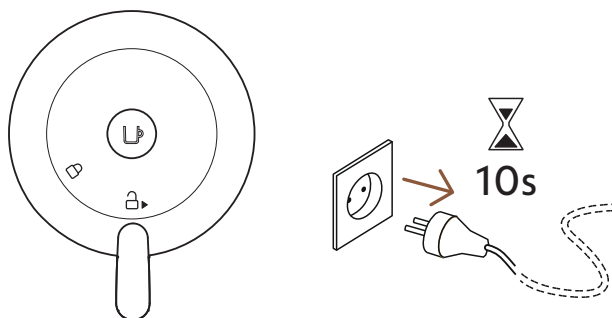

- 1** Když je kávovar zavřený a páka je v **odemčené** poloze, odpojte kávovar od elektrické sítě.

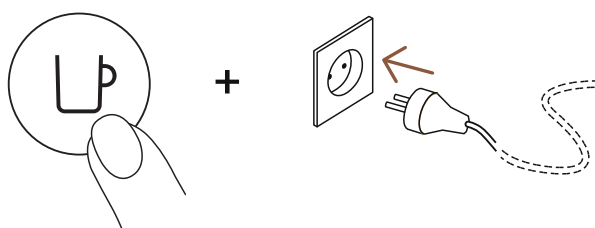

- 2** Při zapojování kávovaru do sítě stiskněte a podržte tlačítko. Tlačítko zabliká oranžově, čímž potvrdí, že modul připojení byl deaktivován.

- i** Pro opětovnou aktivaci modulu připojení postupujte stejným způsobem. Tlačítko zabliká bíle, čímž potvrdí, že modul připojení byl znovu aktivován.

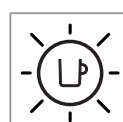
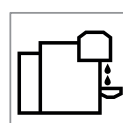
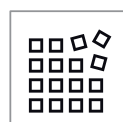

# ZAČÍNÁME

## PRVNÍ PROPLÁCHNUTÍ

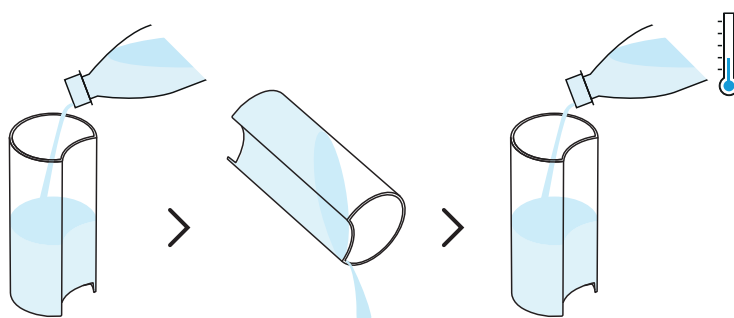

- 1** Nejprve opláchněte a umyjte nádobu na vodu a víko a poté ji naplňte čerstvou pitnou vodou.

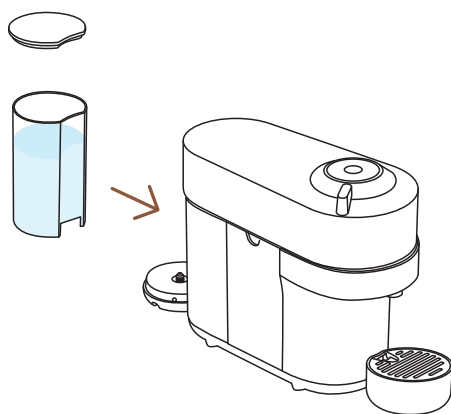

- 2** Uzavřete nádobu na vodu víkem, vložte ji na místo a zkontrolujte, zda je správně nasazena.

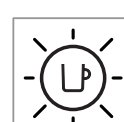
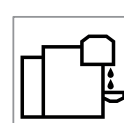
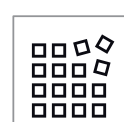
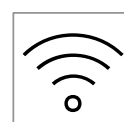

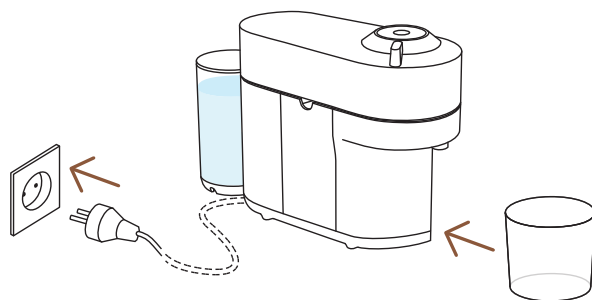

- 3** Když je kávovar zapojen do sítě, odejměte podstavec pod šálek a pod výpusť kávy položte prázdnou nádobu (o objemu nejméně 1 litr).

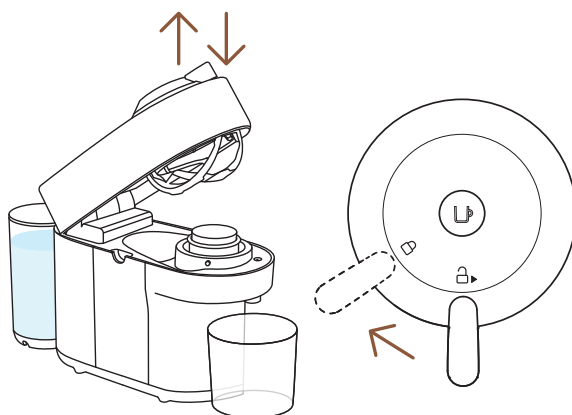

- 4** Otevřete a zavřete kávovar. Zkontrolujte, zda je páka v uzamčené poloze.
- i** Během zahřívání bude blikat kontrolka. Nahřívání bude trvat přibližně 30 vteřin. Když kontrolka zůstane svítit, kávovar je připraven k použití. Zkontrolujte, zda není vložena žádná kapsle.

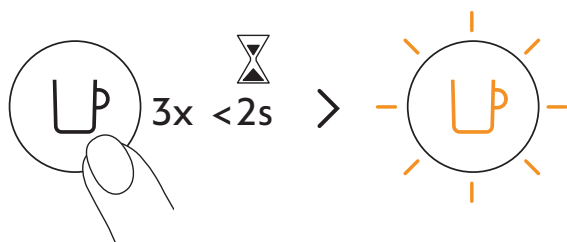

- 5** Proplachování spustíte stisknutím tlačítka třikrát po sobě během 2 sekund. Když kontrolka bliká oranžově, nechte proplachování automaticky dokončit. Když kontrolka zůstane svítit bíle, cyklus je dokončen.
- i** Proplachovací cyklus a průtok vody by se měl spustit do 2 minut. Tento cyklus může trvat až 7 minut.

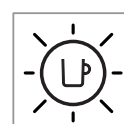
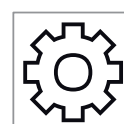
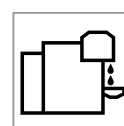
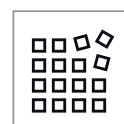
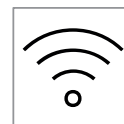

# PŘÍPRAVA KÁVY

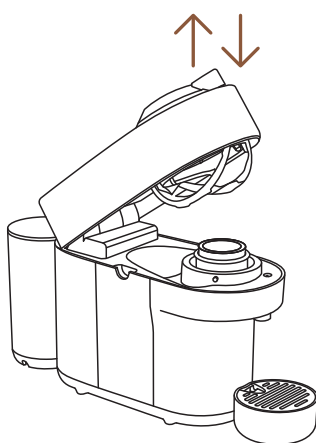

**1** Otevřete a zavřete kávovar.

**i** Během zahřívání bude blikat kontrolka. Když kontrolka zůstane svítit, kávovar je připraven k použití.

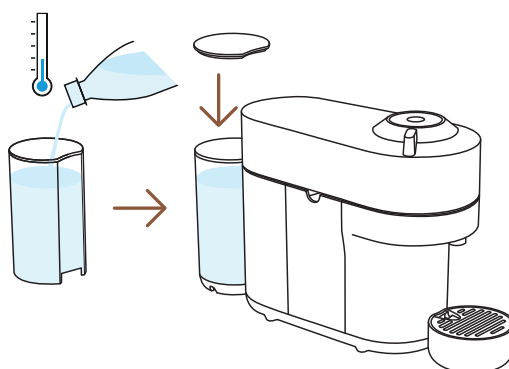

**2** Naplňte nádobu na vodu čerstvou pitnou vodou a vložte ji na místo.

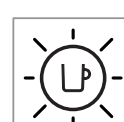
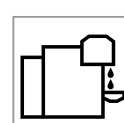
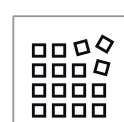
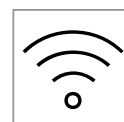

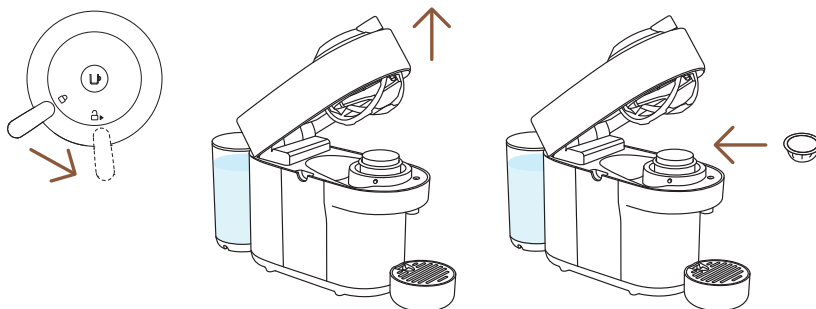

- 3** Odemkněte a zcela otevřete hlavu kávovaru a vložte kapsli Vertuo kopulovitým tvarem směrem dolů.

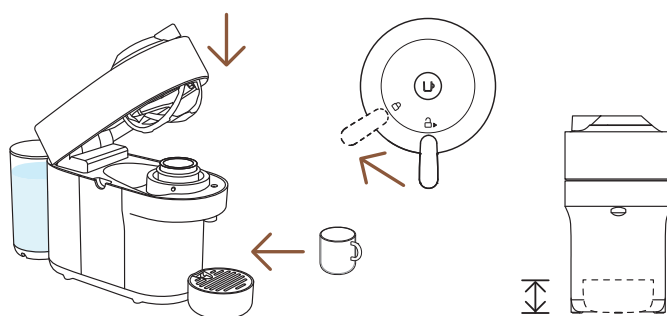

- 4** Zavřete hlavu kávovaru a zamkněte ji otočením páky doleva do uzamčené polohy a pod výpusť kávy položte šálek. Podstavec pod šálek lze přizpůsobit velikosti vašeho šálku.

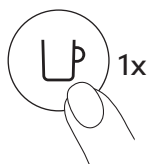

- 5** Stisknutím tlačítka pro přípravu kávy spustíte přípravu kávy.

**UPOZORNĚNÍ:** v rámci správného používání kávovaru neotvírejte během přípravy kávy hlavu kávovaru, počkejte, až tlačítko pro přípravu kávy bude opět svítit bíle. Pokud chcete přípravu kávy předčasně ukončit, stiskněte jednou tlačítko pro přípravu kávy a před otevřením hlavy kávovaru a počkejte, dokud tlačítko pro přípravu kávy nezačne znovu svítit bíle.

- i** Káva začne vytékat, jakmile je načten čárový kód a káva je předmáčená a spařená. Kávovar automaticky rozpozná vloženou kapsli a přizpůsobí parametry přípravy kávy a velikost šálku předdefinované odborníky na kávu společnosti **Nespresso**, aby byla vaše káva extrahována co nejlépe.

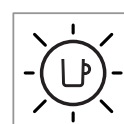
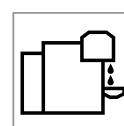
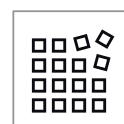
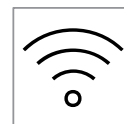

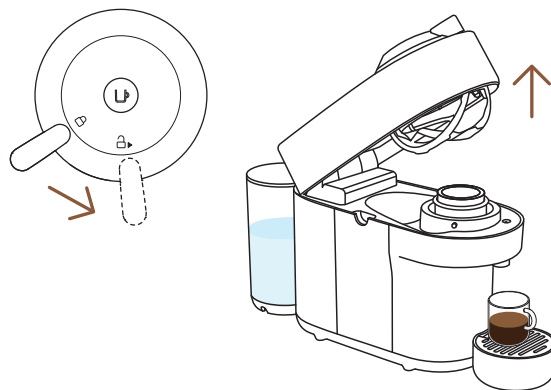

- 6** Když je káva připravena, otevřete hlavu kávovaru otočením páky doprava do odemčené polohy, kapsle se automaticky vysune a vy si můžete vychutnat svou kávu.



- 7** Nezapomeňte recyklovat kapsle **Nespresso**.\*

\* JE TO **NESPRESSO**. JE RECYKLOVATELNÉ. Pro více informací, jak recyklovat vaše kapsle **Nespresso**, navštivte stránku [www.nespresso.com](http://www.nespresso.com).

## OBJEVTE FUNKCI COFFEE CREATIONS MODE



Tento kávovar **Nespresso** vám nabízí funkci koncentrace jednotlivých kávových příprav, abyste si mohli vytvářet vlastní receptury.

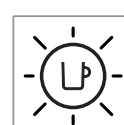
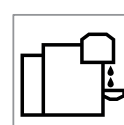
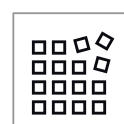
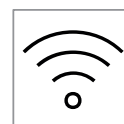

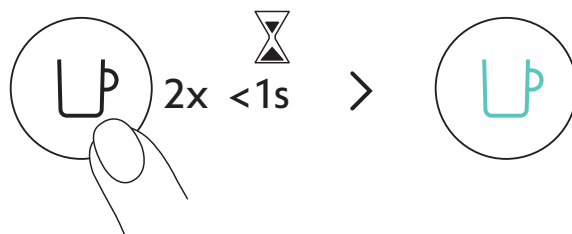

Zapněte kávovar a dvakrát klikněte na tlačítko pro přípravu kávy. Kontrolka zabliká tyrkysově a vaše káva bude koncentrovaná, což optimalizuje chuť kávy v recepturách s přísadami.

40 ml	80 ml	150 ml	230 ml	355 ml	535 ml
✓	✓	✓	✓	✗	✗
25 ml	40 ml	40 ml	80 ml		

Chcete-li využívat všechny výhody, doporučujeme připravovat kávu z naší řady Coffee+ pouze v uvedených velikostech šálek. Pro dosažení nejlepších výsledků v šálcích nedoporučujeme v daném režimu připravovat naše kávy XL (Alto Ambrato, Alto Onice), Cold Brew Style a Carafe Pour Over Style.

**POZNÁMKA:** před aktivací tohoto **režimu** může být vyžadována aktualizace kávovaru prostřednictvím aplikace **Nespresso**.



Zjistěte, jak můžete svůj kávovar vylepšit pomocí naší řady napěňovačů mléka Aeroccino. Více informací naleznete na [www.nespresso.com](http://www.nespresso.com).

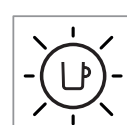
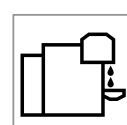
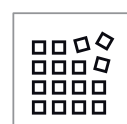
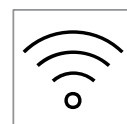



## NASTAVENÍ OBJEMU KÁVY

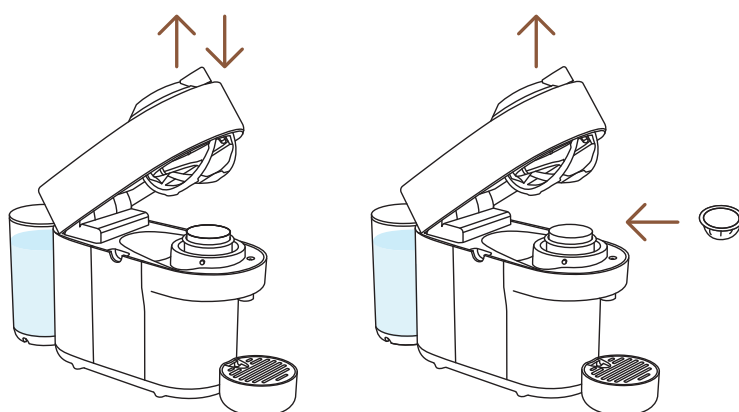

- 1** Když je kávovar zapnutý, otevřete hlavu kávovaru a vložte kapsli, kterou chcete naprogramovat.

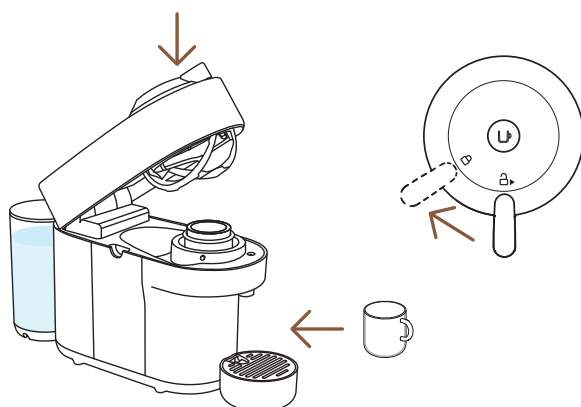

- 2** Zavřete hlavu kávovaru, otočte páku doleva do uzamčené polohy a pod výpusť kávy položte šálek.

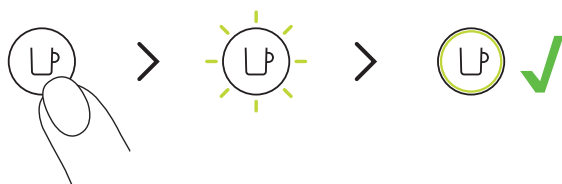

- 3** Stiskněte a podržte tlačítko pro přípravu kávy. Uvolněte jej několik sekund před dosažením požadovaného objemu. Nový objem vody je nyní naprogramován pro typ kapslí, které byly použity při nastavení.

- i** Nastavení je specifické pro každý typ kapslí. Velikosti šálek lze naprogramovat od 20 ml do 535 ml.

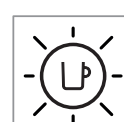
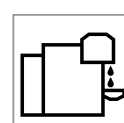
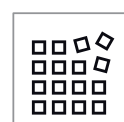
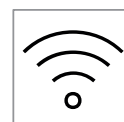

**UPOZORNĚNÍ:** v rámci správného používání kávovaru neotvírejte během přípravy kávy hlavu kávovaru, počkejte, až tlačítko pro přípravu kávy bude opět svítit bíle. Pokud chcete přípravu kávy předčasně ukončit, stiskněte jednou tlačítko pro přípravu kávy a počkejte, dokud tlačítko pro přípravu kávy nezačne znovu svítit bíle.

**UPOZORNĚNÍ:** Jakmile uživatel naprogramuje specifický objem, pokaždé, když je do kávovaru vložen daný typ kapsle, příprava kávy se zastaví na velikosti objemu naprogramované uživatelem. Pokud se chcete vrátit k továrnímu nastavení objemu, viz odstavec **“Návrat k továrnímu nastavení“**.

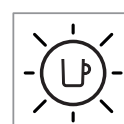
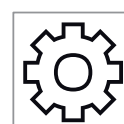
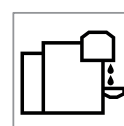
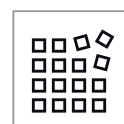
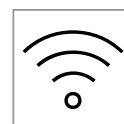

## ČIŠTĚNÍ

Kávovar čistěte každý měsíc, když se v hlavě kávovaru začnou tvořit kávové usazeniny nebo po delší době nepoužívání kávovaru.

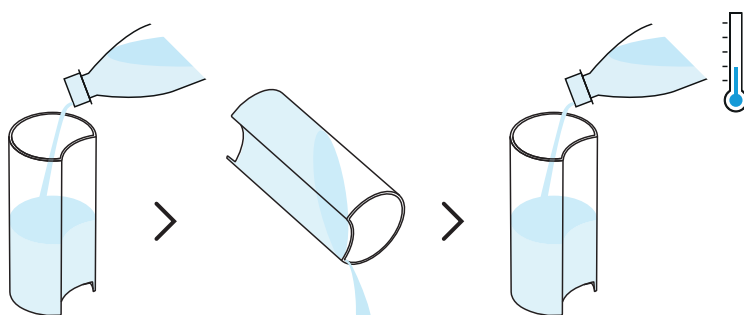

- 1** Před naplněním nádoby na vodu čerstvou pitnou vodou ji opláchněte a umyjte.

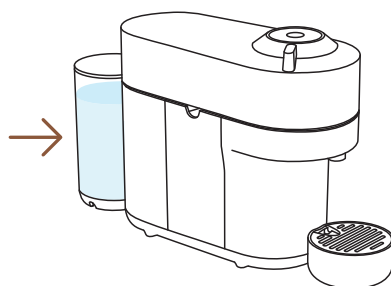

- 2** Vložte nádobu zpět na místo do kávovaru.

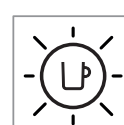
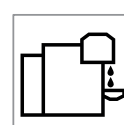
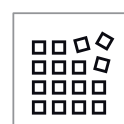
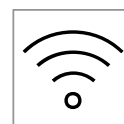

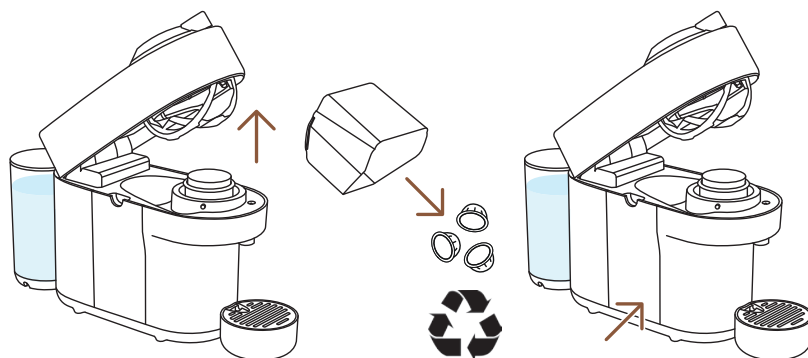

- 3** Když je kávovar zapnutý, odemkněte a otevřete hlavu, aby se použitá kapsle vysunula. Vyprázdněte a vypláchněte nádobu na použité kapsle a odkapávací misku, potom je vraťte na místo. Nezapomeňte recyklovat kapsle **Nespresso**.\*

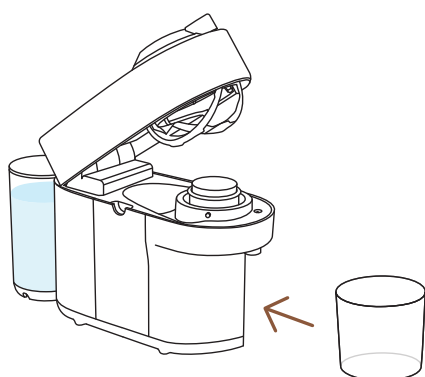

- 4** Vyměňte podstavec pod šálek a pod výpusť kávy umístěte prázdnou nádobu (o objemu alespoň 1 l).

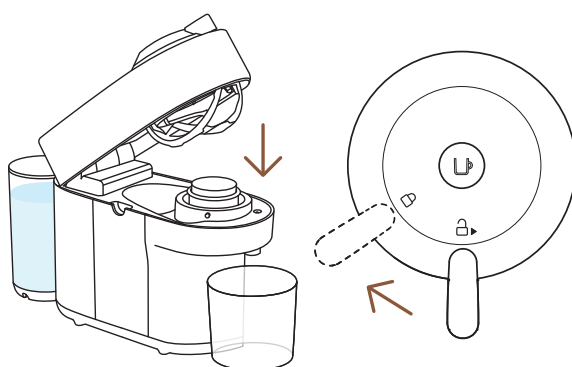

- 5** Zavřete hlavu kávovaru a otočte páku doleva do uzamčené polohy. Před spuštěním proplachování se ujistěte, že v kávovaru není vložena žádná kapsle.

\* JE TO **NESPRESSO**. JE RECYKLOVATELNÉ. Pro více informací, jak recyklovat vaše kapsle **Nespresso**, navštivte stránku [www.nespresso.com](http://www.nespresso.com).

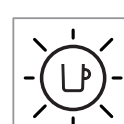
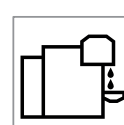
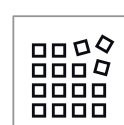
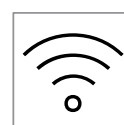

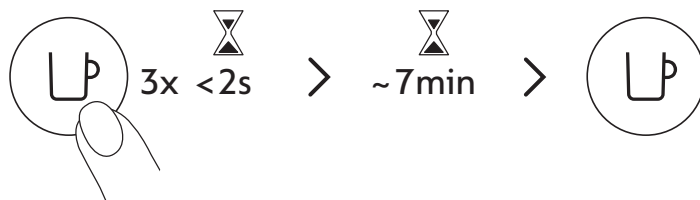

- 6** Proplachování spustíte stisknutím tlačítka třikrát po sobě během 2 sekund. Když kontrolka bliká oranžově, nechte proplachování automaticky dokončit.

- i** Proces proplachování by se měl spustit a voda by měla začít téct nejpozději do 2 minut. Tento cyklus může trvat až 7 minut a po dokončení se automaticky zastaví. Cyklus čištění lze kdykoli zastavit stisknutím tlačítka.

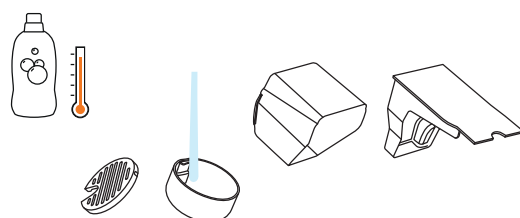

- 7** Vyčistěte kontejner na použité kapsle, podstavec pod šálek a odkapávací misku teplou mýdlovou vodou.

**UPOZORNĚNÍ:** Nepoužívejte silné nebo abrazivní čisticí prostředky nebo rozpouštědla. Nečistěte kávovar v myčce nádobí. Příklad ani jeho součásti nikdy neponořujte do vody.

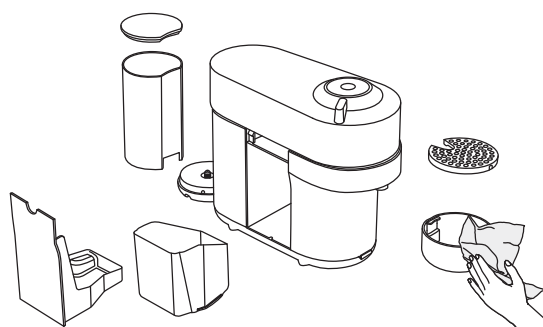

- 8** Osušte čistou nepoužitou utěrkou.

**UPOZORNĚNÍ:** Výpusť kávy pravidelně otírejte čistým vlhkým hadříkem. K čištění kávovaru vždy používejte jemný hadřík.

**UPOZORNĚNÍ:** Uvnitř hlavy kávovaru se během čištění může objevit voda – pokud k tomu dojde, utřete mokré části čistým suchým hadříkem.

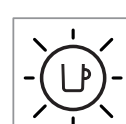
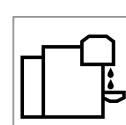
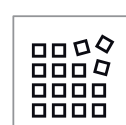
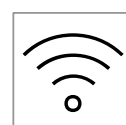

## ODVÁPŇNĚNÍ

Odvápňením kávovaru zajistíte, že bude správně fungovat po celou dobu své životnosti a že vám poskytne nezapomenutelný zážitek z kávy jako první den používání. V případě potřeby odvápňení kontrolka třikrát oranžově zabliká a poté zůstane svítit bíle.



**i** Odvápňovací cyklus trvá ~20 minut a **nesmí být přerušen**.

**POZNÁMKA:** před zahájením procesu odstranění vodního kamene si pečlivě přečtěte návod na odvápňení.

### Budete potřebovat:

- Odvápňovací sadu, kterou lze objednat na [www.nespresso.com](http://www.nespresso.com)
- prázdnou nádobu o objemu 1 l

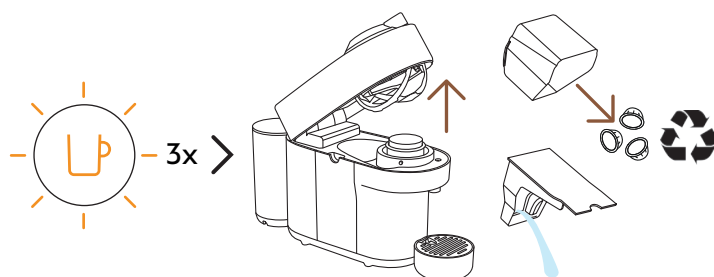

- 1** Tlačítko třikrát oranžově zabliká: Odemkněte a otevřete hlavu kávovaru, použitá kapsle se vysune. Vyprázdněte nádobu na použité kapsle a odkapávací misku a poté je vložte zpět na místo. Nezapomeňte recyklovat kapsle **Nespresso**.\*

\* JE TO **NESPRESSO**. JE RECYKLOVATELNÉ. Pro více informací, jak recyklovat vaše kapsle **Nespresso**, navštivte stránku [www.nespresso.com](http://www.nespresso.com).

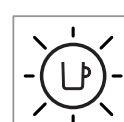
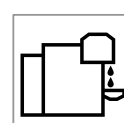
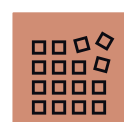
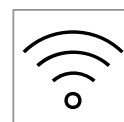

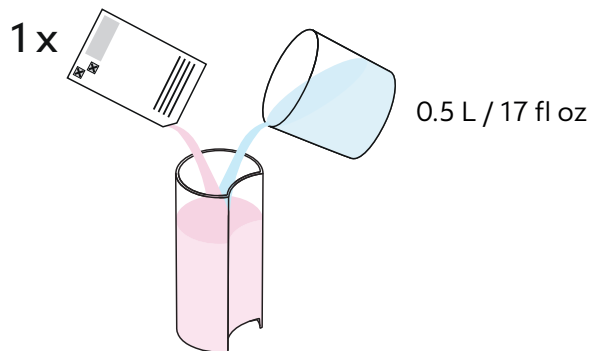

- 2** Naplňte nádržku na vodu 0,5 l vody a 1 dílem odvápňovacího přípravku **Nespresso**.

**UPOZORNĚNÍ:** Odvápňovací prostředek může být zdraví škodlivý. Zabraňte kontaktu s očima, kůží a povrchy.

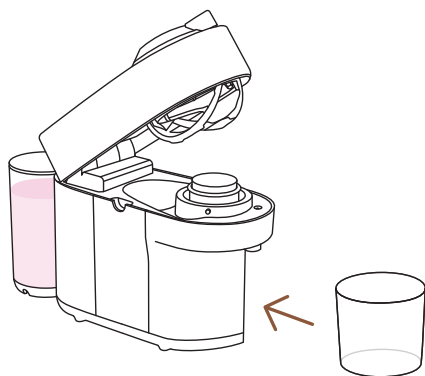

- 3** Vyjměte podstavec pod šálek a pod výpust kávy položte prázdnou nádobu (o objemu alespoň 1 l).

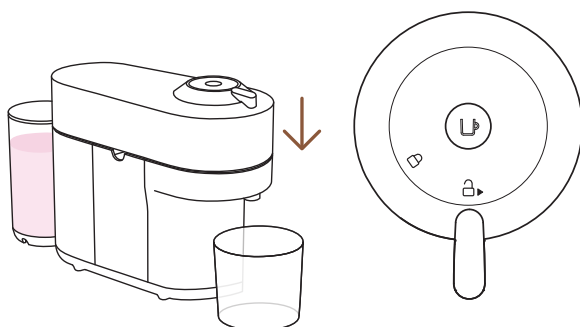

- 4** Nechte kávovar zapnutý, zavřete hlavu kávovaru a nechte páku v odemčené poloze.

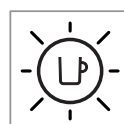
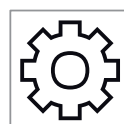
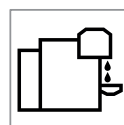
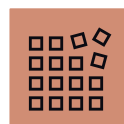
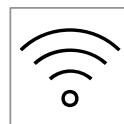

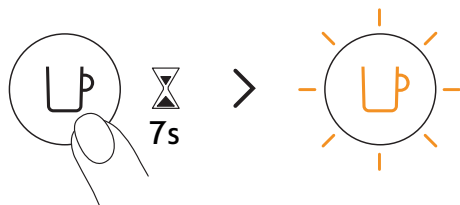

- 5** Podržte tlačítko po dobu nejméně 7 vteřin nebo dokud kontrolka nezhasne. Kontrolka začne rychle oranžově blikat.

**UPOZORNĚNÍ:** Na přepnutí kávovaru do režimu odvápňování máte 45 vteřin. V opačném případě se kávovar přepne zpět do režimu přípravy kávy.

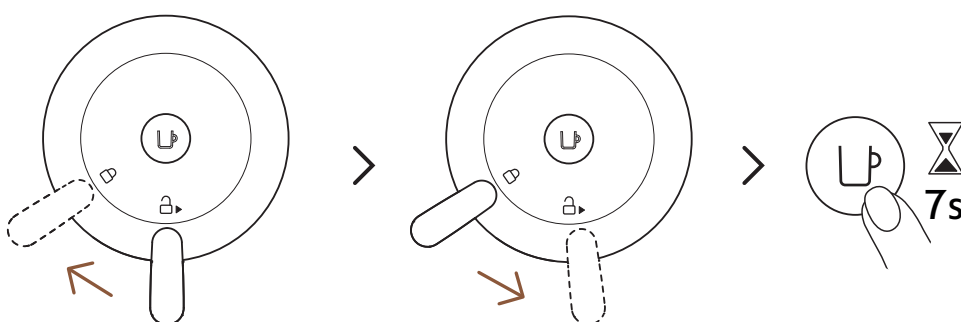

- 6** Zavřete hlavu kávovaru a zatáhněte páku doleva do uzamčené polohy, poté ji zatáhněte doprava do odemčené polohy. Znovu stiskněte a podržte tlačítko pro přípravu kávy po dobu přibližně 7 vteřin, nebo dokud kontrolka nezhasne. Tlačítko bude rychle oranžově blikat.

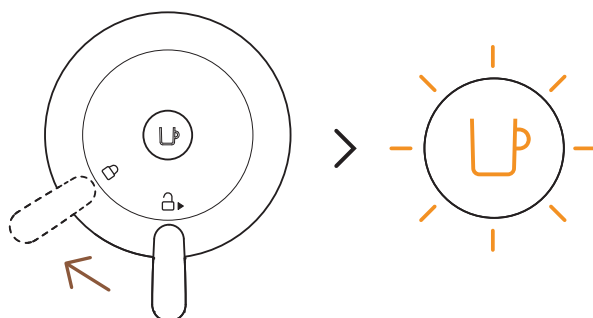

- 7** Pro vstup do režimu odvápňování zavřete kávovar zatáhnutím páky doleva do uzamčené polohy. Tlačítko by mělo stále rychle blikat oranžově, což signalizuje, že jste vstoupili do režimu odvápňování.

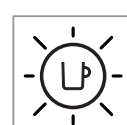
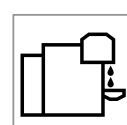
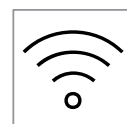



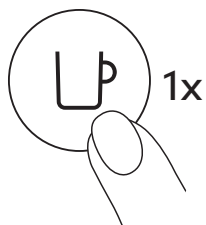

- 8** Proces odvápňení spustíte stisknutím tlačítka pro přípravu kávy. Kontrolka bude během celého procesu odvápňování blikat oranžově.

- i** Cyklus se automaticky zastaví po dokončení první fáze odvápňení.

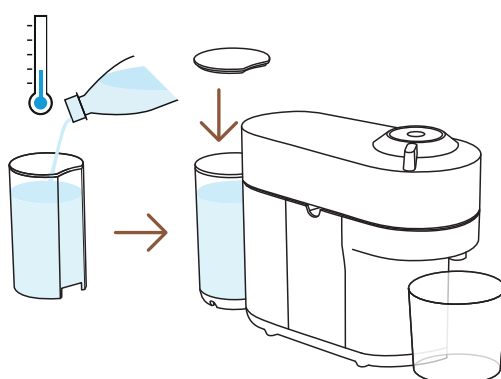

- 9** Po dokončení cyklu odvápňení je potřeba kávovar propláchnout. Nádržku na vodu a odkapávací misku důkladně vypláchněte.

Naplňte nádržku na vodu čerstvou pitnou vodou a vložte ji na místo. Vyprázdněte misku a vraťte ji zpět pod výpusť kávy.

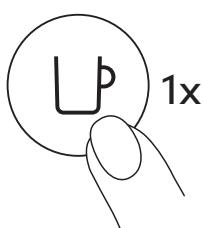

- 10** Stisknutím tlačítka pro přípravu kávy zahájíte proplachování. Když tlačítko přestane blikat a zůstane svítit, cyklus odvápňení je dokončen.

- i** Kávovar cyklus odvápňení po dokončení automaticky zastaví.

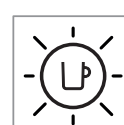
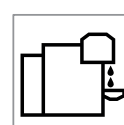
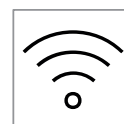

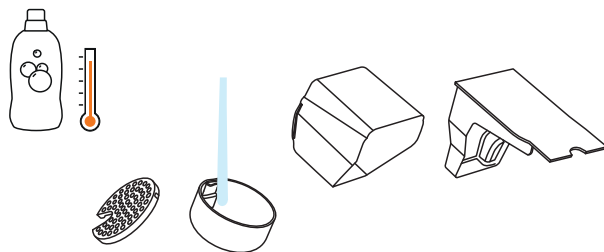

- 11** Umyjte kontejner na použité kapsle, podstavec pod šálek a odkapávací misku teplou mýdlovou vodou.

**UPOZORNĚNÍ:** Nepoužívejte silné nebo abrazivní čisticí prostředky nebo rozpouštědla. Nečistěte kávovar v myčce nádobí. Přístroj ani jeho součásti nikdy neponořujte do vody.

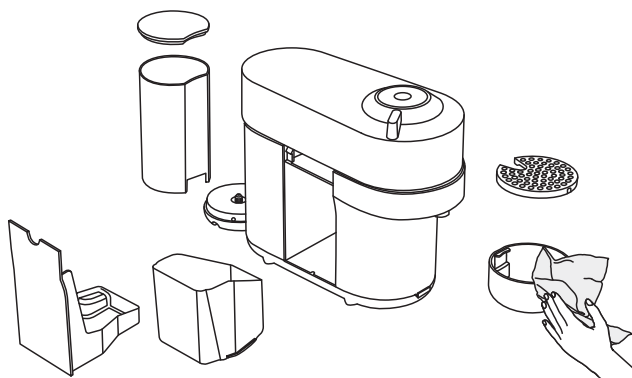

- 12** Kávovar osušte čistou utěrkou. Před použitím nechte kávovar 10 minut vyschnout.

**UPOZORNĚNÍ:** Uvnitř hlavy kávovaru se během čištění může objevit voda. Pokud k tomu dojde, utřete mokré části čistým suchým hadříkem.

**UPOZORNĚNÍ:** kávovar může spustit režim odvápňení až po přípravě minimálně 30 káv.

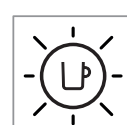
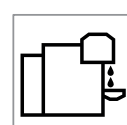
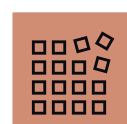
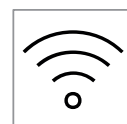

## VYPRAZDŇOVÁNÍ SYSTÉMU

Před obdobím nepoužívání kávovaru, jako prevence proti mrazu nebo před odesláním do opravy se doporučuje vyprázdnit systém.

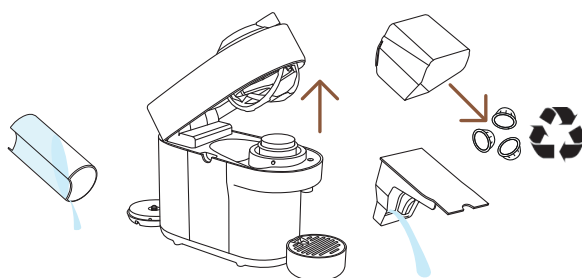

- 1 Vyprázdněte nádržku na vodu a otevřete hlavu kávovaru, použitá kapsle se vysune. Vyprázdněte kontejner na použité kapsle a odkapávací misku. Nezapomeňte recyklovat kapsle **Nespresso**.\*

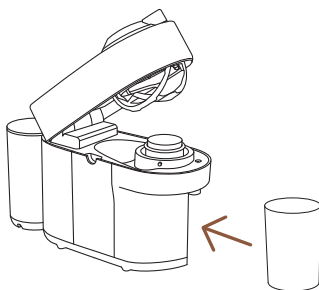

- 2 Vložte je na místo do kávovaru, vyjměte podstavec pod šálek a pod výpusť kávy položte prázdnou misku (o objemu 0,5 l).

\* JE TO **NESPRESSO**. JE RECYKLOVATELNÉ. Pro více informací, jak recyklovat vaše kapsle **Nespresso**, navštivte stránku [www.nespresso.com](http://www.nespresso.com).

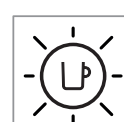
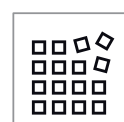
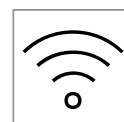

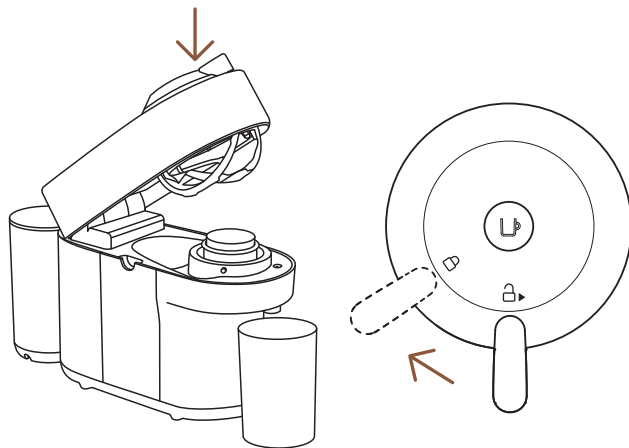

- 3** Když je kávovar zapojen do sítě a zapnut, otočte páku do uzamčené polohy.

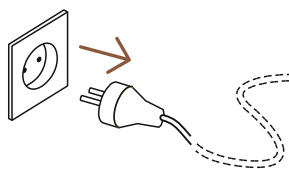

- 4** Odpojte kávovar ze zásuvky.

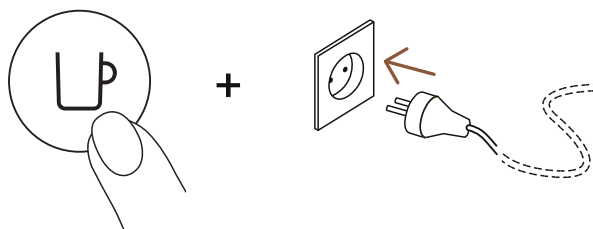

- 5** Při zapojování kávovaru do sítě stiskněte a podržte tlačítko.

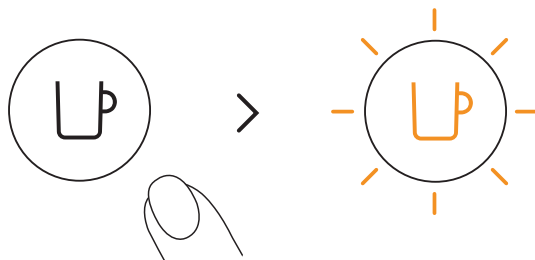

- 6** Uvolněte tlačítko. Bude oranžově blikat a zahájí se cyklus vyprazdňování.

- i** Cyklus vyprazdňování trvá přibližně 30 vteřin. Po dokončení vyprazdňování se kávovar automaticky vypne.

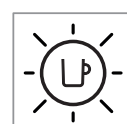
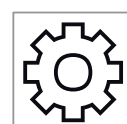
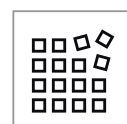
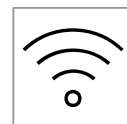

## OBNOVENÍ TOVÁRNÍCH NASTAVENÍ

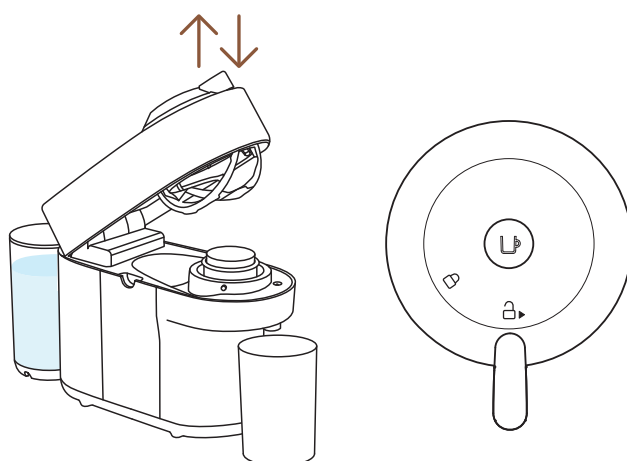

- 1** Nechte kávovar zapojený do sítě, otevřete a zavřete hlavu kávovaru a poté nechte páku v odemčené poloze.

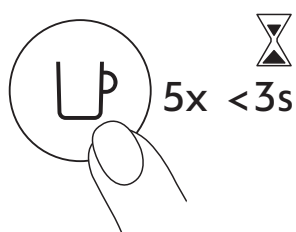

- 2** Stiskněte tlačítko pětkrát během 3 vteřin. Kávovar je nyní naprogramován na tovární nastavení.

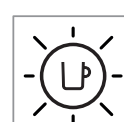
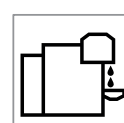
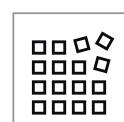
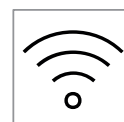

## VÝZNAM SVĚTELNÝCH SIGNÁLŮ

Chcete se dozvědět více o světelných signálech kávovaru Vertuo Pop? Podívejte se na následující video:

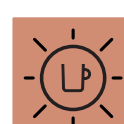
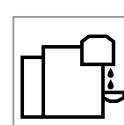
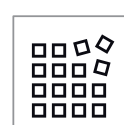
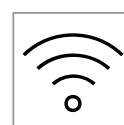

## ŘEŠENÍ PROBLÉMŮ

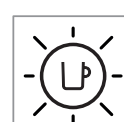
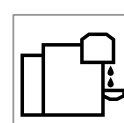
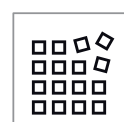
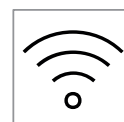

### Tlačítko nesvítí

- Kávovar se automaticky vypnul; stiskněte tlačítko pro přípravu kávy nebo odemkněte kávovar.
- Zkontrolujte přívodní kabel, zásuvku, elektrické napětí, a pojistky.

### Z kávovaru nevytéká káva ani voda.

- Zkontrolujte, zda je v nádobě na vodu voda.
- Zkontrolujte, zda je kapsle vložena ve správné pozici a zda je páka v uzamčené poloze. Pak stiskněte tlačítko pro přípravu kávy.
- V případě potřeby kávovar odvápněte.
- Otevřete hlavu kávovaru a vyjměte kapsli. Pak kávovar vyčistěte podle návodu.

### Káva není dost horká.

- Předehřejte šálek horkou vodou z kohoutku.
- V případě potřeby kávovar odvápněte.

### Přístroj netěsní nebo káva vytéká jinak než obvykle.

- Zkontrolujte, zda je nádoba na vodu ve správné pozici.
- V případě potřeby kávovar odvápněte.

### Kávovar se sám vypíná.

- Kávovar se kvůli úspoře energie po 2 minutách nepoužívání vypne.
- Kávovar můžete kdykoliv VYPNOUT i manuálně (pokud ho právě nepoužíváte), a to stisknutím a podržením tlačítka po dobu 3 vteřin.

### V šálku je kávová sedlina.

- Proveďte čistící cyklus dvakrát za sebou.
- Viz odstavec **“Čištění”**.

### Kávovar se nechce spustit a tlačítko trvale svítí. (Pokud bliká, viz dále.)

- Zkontrolujte, zda je páka v uzamčené poloze.
- Pokud si chcete připravit kávu, zkontrolujte, zda je kapsle v kávovaru vložena ve správné pozici a zda je páka v uzamčené poloze. Pak stiskněte tlačítko pro přípravu kávy.
- Pokud přístroj čistíte, odvápnujete nebo vyprazdňujete, nejdříve zkontrolujte, zda v kávovaru není vložena žádná kapsle, uzamkněte ho a pak zahajte proces, který jste plánovali.

**Kávovar se nechce spustit a tlačítko bliká v režimu 1 bliknutí a 1 pauza.**

**Když kávovar pracuje, tlačítko bliká.**

**Kávovar nefunguje a tlačítko bliká v režimu 1 bliknutí a 1 pauza.**

- Naplňte nádobu na vodu a stiskněte tlačítko pro přípravu kávy.
- Zkontrolujte, zda je páka v uzamčené poloze.
- Pokud z kávovaru vytéká káva jako obvykle, vše je v pořádku.
- Pokud z kávovaru vytéká pouze voda, znamená to, že probíhá čištění, odvápnění nebo vyprazdňování. Postupujte podle pokynů v příslušné části návodu.
- Stisknutím tlačítka na 3 sekundy přístroj vypnete a opětovným stisknutím tlačítka jej znovu zapnete. Pak vyčkejte přibližně 20 minut, než kávovar po intenzivním používání vychladne.
- Je normální, že káva začne vytékat až po chvíli (kávovar musí nejdřív přečíst čárový kód a zpracovat kávu).
- Zkontrolujte, zda je kapsle vložena ve správné pozici a zda je páka v uzamčené poloze. Pak stiskněte tlačítko pro přípravu kávy.
- Naplňte nádobu na vodu a stiskněte tlačítko pro přípravu kávy.
- Stisknutím tlačítka na 3 sekundy kávovar vypnete a opětovným stisknutím tlačítka jej znovu zapnete. Pak vyčkejte přibližně 20 minut, než kávovar po intenzivním používání vychladne.

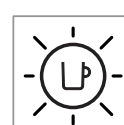
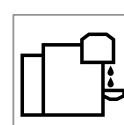
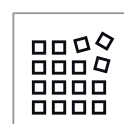
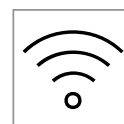



**Tlačítko trvale bliká v režimu 2 bliknutí a 1 pauza. Kávovar nepracuje.**

- Stalo se během běžné přípravy kávy:
  - 1) Odemkněte páku a otevřete hlavu kávovaru, abyste zkontrolovali, zda je nová neporušená kapsle umístěna ve správné pozici.
  - 2) Zkontrolujte, zda je páka je v uzamčené poloze.
  - 3) Zkontrolujte, zda je v nádobě na vodu voda.
- Stalo se během odvápnování, vyprazdňování nebo čištění:
  - 1) Zkontrolujte, zda byla kapsle vysunuta.
  - 2) Zkontrolujte, zda je páka v pozici zamčeno.
- Stalo se během nastavování objemu nápoje:
  - 1) Zkontrolujte, zda je nová kapsle správně vložená.
  - 2) Poskupujte podle pokynů v části návodu **“Nastavení objemu kávy“**.
- Pokud problém přetrvává:
  - 1) Odemkněte páku a otevřete hlavu kávovaru.
  - 2) Upravte polohu kapsle (je-li to třeba).
  - 3) Vytáhněte přívodní kabel ze zásuvky, počkejte 10 vteřin a zapojte ho zpět.
  - 4) Zavřete hlavu kávovaru, stiskněte tlačítko, aby se kávovar zapnul, a pak jej stiskněte znovu, aby se spustila příprava kávy. Pokud problém přetrvává, kontaktujte společnost **Nespresso**.
- Potřeba odvápnění. Poté, co se toto upozornění objeví, je možné kávovar ještě chvíli používat. Následně je však nezbytně nutné kávovar odvápnit.

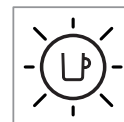
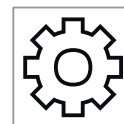
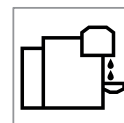
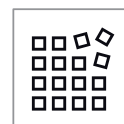
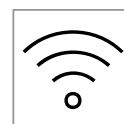

**Kontrolka střídavě třikrát bliká a poté trvale svítí.**

## TECHNICKÉ ÚDAJE

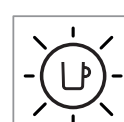
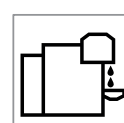
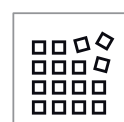
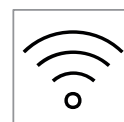

### Napájení

~220–240 V, 50–60 Hz, 1300–1500 W

US, CA: 120 V, 60 Hz, 1500 W

MX: 127 V~, 60 Hz, 1380 W

### Kmitočet

2.402–2.480 GHz

### Ekvivalentní izotropně vyzářený výkon (EIRP)

Bluetooth 4 dBm max. EIRP a WiFi

<20 dMm max. EIRP

### Pohotovostní režim

0.39 W/h

### Režim úspory energie

Automatické vypnutí: po 2 min.

### Doba nahřátí

30 vteřin (hlava kávovaru zavřená a uzamčená)

### Odnímatelný podstavec pod šálky pro větší receptury

Nastavitelná samostatná pozice

### Délka kabelu z kávovaru

75 cm

### Rozměry (š x h x v)

13.6 x 42.6 x 25 cm / 5.3 x 16.7 x 9.8 in

### Hmotnost

3.5 kg / 7.72 lbs

### Objem nádoby na vodu

0.6 l / 20 fl oz

### Kapacita zásobníku na kapsle

8 kapslí velikosti Espresso nebo 5 kapslí velikosti Mug

## KÓDY KÁVOVARŮ

### Nespresso

GCV2, GDV2

### Breville

BNV120, BNV150

### Delonghi

ENV90

### Krups

XN9201, XN9204,  
XN9205, XN9211

### Magimix

M800

# KLIKNITE A ZVOĽTE JAZYK

SK



**BEZPEČNOSŤ**



**PREHĽAD**



**KONEKTIVITA**



**ZAČÍNAME**



**PRÍPRAVA KÁVY**



**PRISPÔSOBTE SI OBJEM KÁVY**



**ČISTENIE**



**ODVÁPNEIE**



**VYPRÁZDNEIE KÁVOVARU**



**OBNOVENIE TOVÁRENSKÝCH  
NASTAVENÍ**



**VÝZNAM SVETELNÝCH SIGNÁLOV**



**RIEŠENIE PROBLÉMOV**



**TECHNICKÉ ÚDAJE**

## BEZPEČNOSŤ

**UPOZORNENIE:** Pred použitím kávovaru si preštudujte bezpečnostné pokyny. Predídete tak ujme na zdraví a majetku alebo poškodeniu kávovaru.

## LIKVIDÁCIA ODPADU A OCHRANA ŽIVOTNÉHO PROSTREDIA

Tento prístroj vyhovuje smernici EU 2012/19/EC. Váš prístroj obsahuje cenný materiál, ktorý môže byť obnovený alebo recyklovaný. Triedenie ostatného odpadu na jednotlivé druhy zjednodušuje recykláciu cenných surovín. Odložte prístroj v zbernom mieste. Informácie o likvidácii môžete získať od miestnych správnych orgánov.

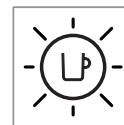
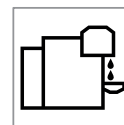
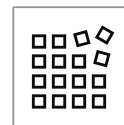
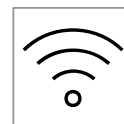

## PREHLAD

## POPIS KÁVOVARU

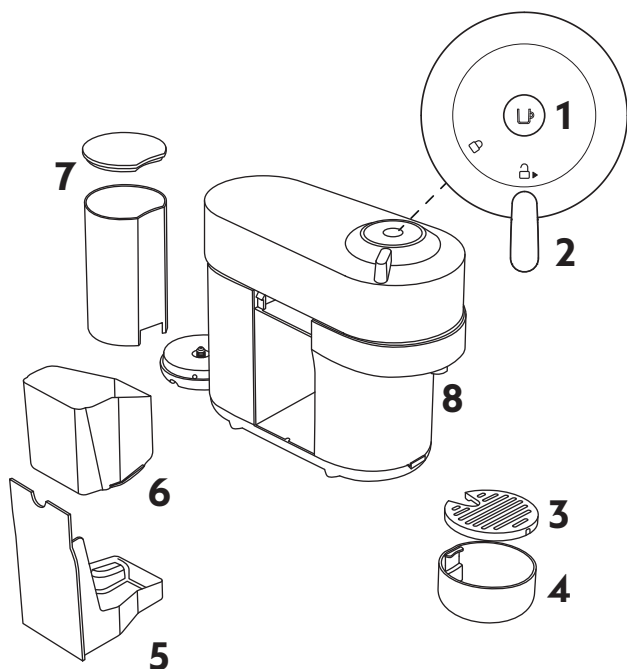

- 1 Tlačidlo ZAPNÚŤ/  
VYPNÚŤ a na prípravu  
kávy
- 2 Páka na zamknutie/  
odomyknutie
- 3 Odkvapkávacia mriežka
- 4 Nastaviteľný podstavec  
pod šálku
- 5 Odkvapkávacia miska
- 6 Kontajner na použité  
kapsuly
- 7 Nádržka na vodu s  
vekom
- 8 Výpust kávy

## OBSAH BALENIA



- 1 Kávovar
- 2 Degustačná sada  
kapsúl **Nespresso**
- 3 Bezpečnostné pokyny
- 4 Návod na rýchly štart
- 5 Záruka

3 + 4 + 5

**i Vybalenie:** na povrchu prístroja môže byť usadený prach z dôvodu použitia recyklovaných materiálov na obaly. Tento prach nie je nebezpečný. Stačí ho utrieť jemným obrúskom. Pri vybalovaní odstráňte z kávovaru ochrannú fóliu.

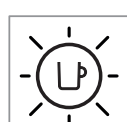
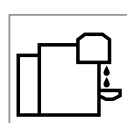
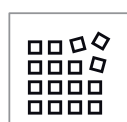
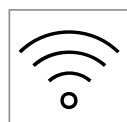

## OTVORIŤ/ZATVORIŤ

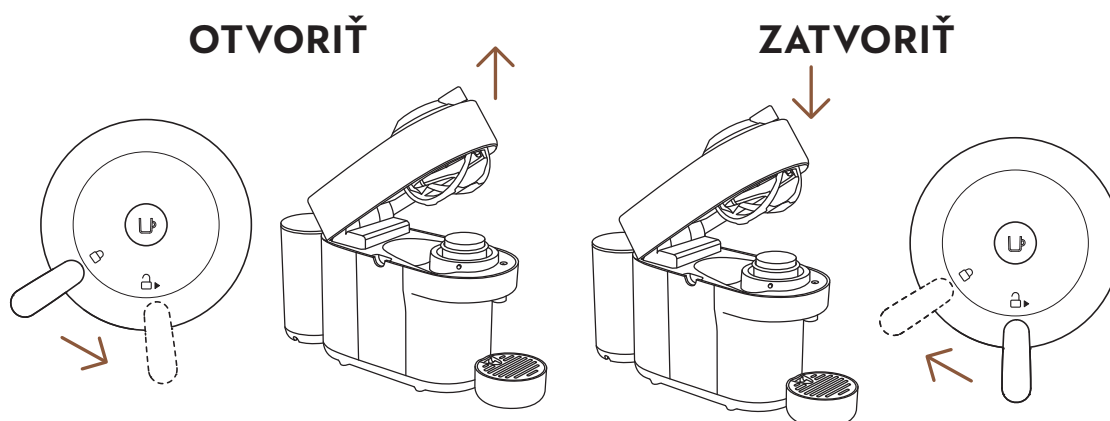

**UPOZORNENIE:** v rámci správneho používania kávovaru neotvárajte hlavu kávovaru počas prípravy kávy, počkajte, kým tlačidlo na prípravu kávy bude opäť svietiť bielo. Ak chcete zastaviť prípravu kávy predčasne, stlačte jedenkrát tlačidlo na prípravu kávy a pred otvorením hlavy a počkajte, kým tlačidlo na prípravu kávy nezačne opäť svietiť na bielo.

## VERTUO SYSTÉM

## KOMPATIBILNÉ KAPSULY

**S****Ristretto**

(25 ml)

**Espresso**

(40 ml)

**M****Double Espresso**

(80 ml)

**Gran Lungo**

(150 ml)

**L****Mug**

(230 ml)

**XL****Alto, Cold Brew Style**

(355 ml)

**Carafe**

(535 ml)

## KOMPATIBILNÉ DOPLNKY

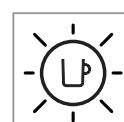
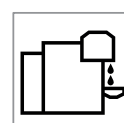
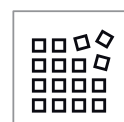
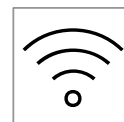
Kompatibilné  
doplňky**Ristretto****Espresso****Double  
Espresso****Gran  
Lungo****Mug (S)****Mug (M)****Reveal  
Glass**Nevhodné  
doplňky**Mug (L)****Carafe**Kompletnú kolekciu doplnkov nájdete na [www.nespresso.com](http://www.nespresso.com).

## ZAPNUTIE/VYPNUTIE

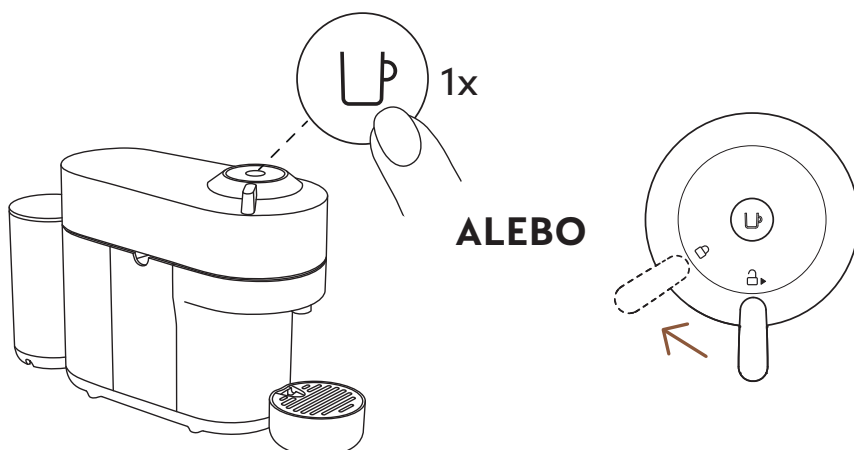

## ZAPNUTIE

Keď je kávovar zapojený do siete, zapnite ho stlačením tlačidla alebo zatiahnutím páky do uzamknutej polohy (hlava kávovaru je zatvorená).

- i** Kontrolka bude blikať približne 30 sekúnd, prebieha proces nahrievania kávovaru. Keď kontrolka prestane blikať, kávovar je pripravený na použitie.



## VYPNUTIE

Kávovar sa kvôli úspore energie po 2 minútach nepoužívania automaticky vypne.

- i** Kávovar môžete kedykoľvek VYPNÚŤ aj manuálne (ak ho nepoužívate), a to stlačením a podržaním tlačidla počas 3 sekúnd.

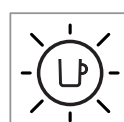
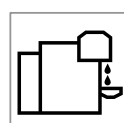
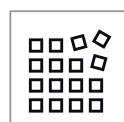
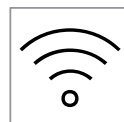

## KONEKTIVITA

### PREČO BY STE MALI SPÁROVAŤ SVOJ KÁVOVAR VERTUO POP?



### VÝHODY PRIPOJENIA VÁŠHO KÁVOVARU VERTUO POP

- **inteligentná príprava kávy:** Buďte vždy o krok vpred a získajte najnovšie kávové inovácie **Nespresso** tým, že budete svoj kávovar aktualizovať a udržiavať v špičkovom stave.
- **odborné poradenstvo:** Získajte podporu a stiahnite si inštruktážne videá do svojho inteligentného telefónu, ktoré vás budú sprevádzať na vašej ceste za kávou.
- **starostlivosť o kávovar:** Dostávajúte upozornenia ako a kedy vykonať údržbu vášho kávovaru pomocou jednoduchého návodu na odvápnenie, prepláchnutie, vyčistenie a podobne.

### AKO PRIPOJIŤ VÁŠ KÁVOVAR VERTUO POP?

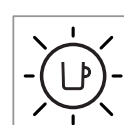
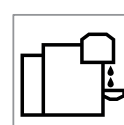
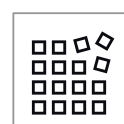





- 1** Stiahnite si alebo aktualizujte aplikáciu **Nespresso**. Používajte aplikáciu **Nespresso** na svojom inteligentnom telefóne alebo na tablete. Kliknite na ikonu kávovaru v pravom hornom rohu obrazovky.

**POZNÁMKA:** pre optimálny výkon a bezproblémový zážitok odporúčame pripojiť váš kávovar k routeru Wi-Fi a nepoužívať hotspot inteligentného telefónu.

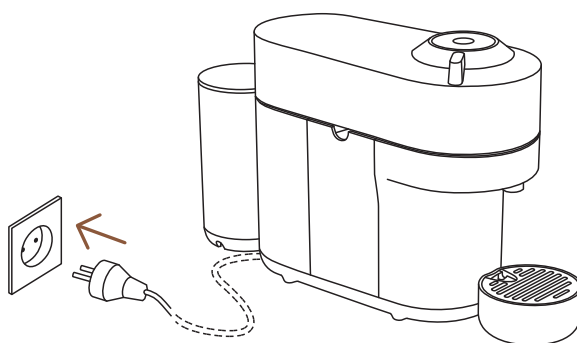

- 2** Zapojte napájací kábel do siete.



- 3** Postupujte podľa inštrukcií v aplikácii **Nespresso**.

**UPOZORNENIE:** Najskôr si prečítajte bezpečnostné upozornenia, aby ste predišli smrteľnému zásahu elektrickým prúdom a požiaru. Pri zapojovaní kávovaru do elektrickej zásuvky sa uistite, že je uzemnený.

- \* App Store® je ochranná známka spoločnosti Apple Inc., registrovaná v USA a ďalších krajinách.
- \*\* Google Play a logo Google Play sú ochranné známky spoločnosti Google LLC.

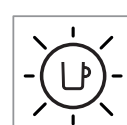
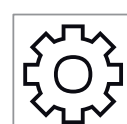
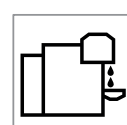
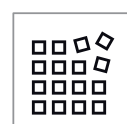

## DEAKTIVÁCIA FUNKCIÍ BLUETOOTH A WI-FI NA KÁVOVARE

Kávovar je dodávaný s prednastaveným modulom pripojenia. Umožňuje prístup k ďalším funkciám, ktoré vylepšujú váš zážitok z kávy. Ak chcete modul pripojenia deaktivovať, postupujte podľa nasledujúcich krokov:

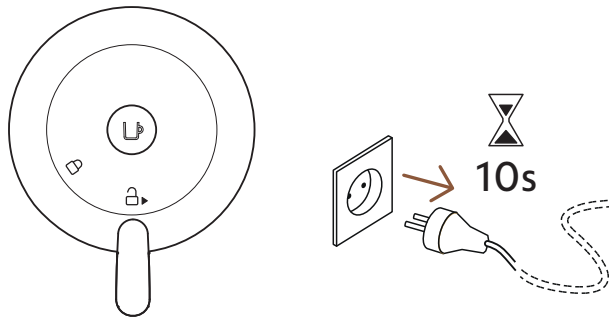

- 1 Nechajte kávovar zatvorený a páku v **odomknutej** pozícii a odpojte kávovar zo siete.

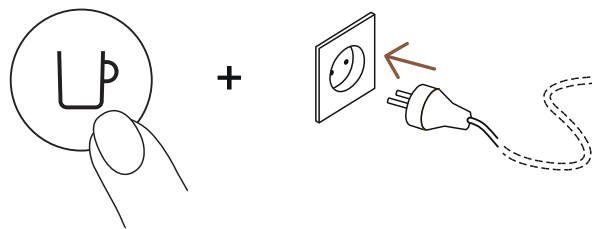

- 2 Pri zapájaní kávovaru do siete stlačte a podržte tlačidlo. Tlačidlo zabliká oranžovo, čím potvrdí, že modul pripojenia bol deaktivovaný.

- i** Pre opätovnú aktiváciu modulu pripojenia postupujte rovnako. Tlačidlo zabliká bielo, čím potvrdí, že modul pripojenia bol znovu aktivovaný.

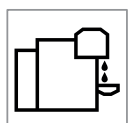

# ZAČÍNAME

## PRVÉ PREPLÁCHNUTIE

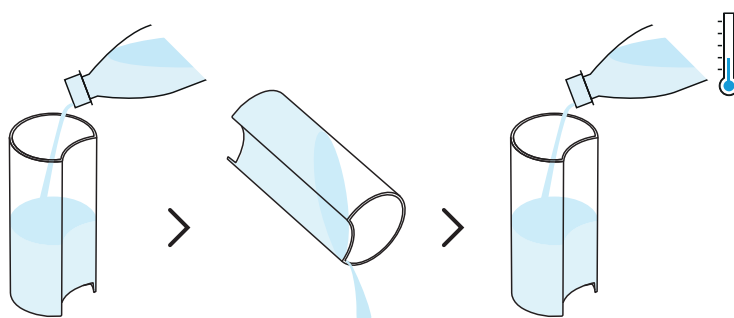

- 1** Najprv opláchnite a umyte nádržku na vodu a veko a potom ju naplňte čerstvou pitnou vodou.

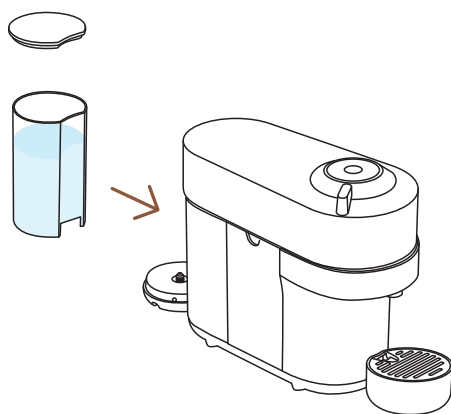

- 2** Zatvorte nádržku na vodu vekom, vložte ju na miesto a skontrolujte, či je správne nasadená.

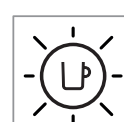
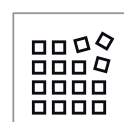
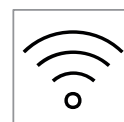

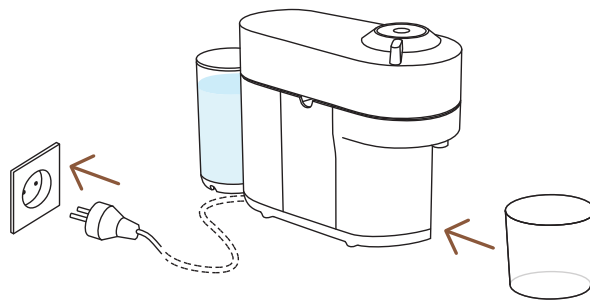

- 3** Keď je kávovar zapojený do siete, odstráňte podstavec pod šálku a pod výpusť kávy položte prázdnu nádobu (s objemom aspoň 1 l).

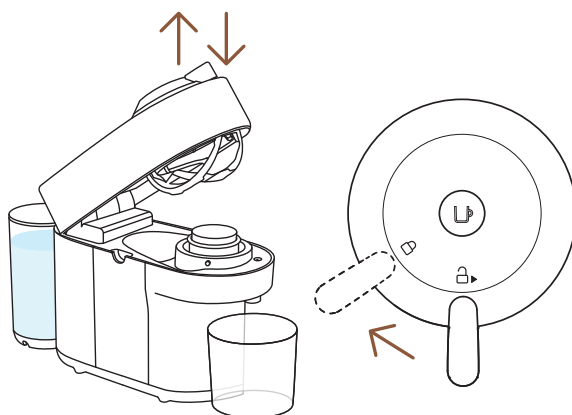

- 4** Otvorte a zatvorte kávovar. Skontrolujte, či je páka v uzamknutej pozícii.

- i** Počas nahrievania bude blikať kontrolka. Nahrievanie bude trvať približne 30 sekúnd. Keď kontrolka zostane svietiť, kávovar je pripravený na použitie. Skontrolujte, či nie je vložená žiadna kapsula.

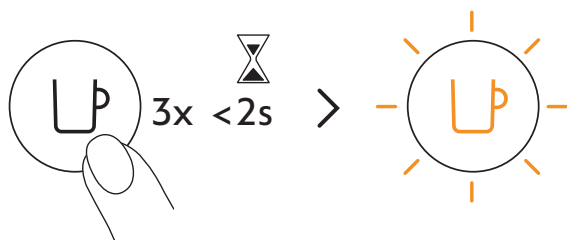

- 5** Preplachovanie spustíte stlačením tlačidla trikrát za sebou v priebehu 2 sekúnd. Keď kontrolka bliká oranžovo, nechajte preplachovanie automaticky dokončiť. Keď kontrolka zostane svietiť na bielo, cyklus je dokončený.

- i** Preplachovací cyklus a prietok vody by sa mal spustiť do 2 minút. Tento cyklus môže trvať až 7 minút.

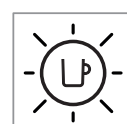
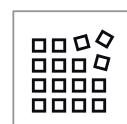
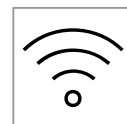

# PRÍPRAVA KÁVY

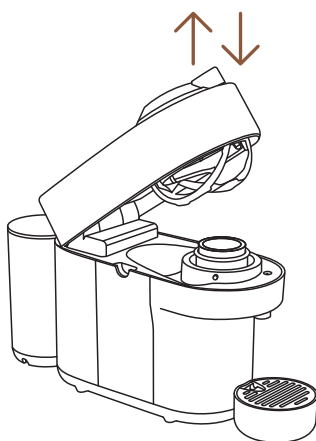

**1** Otvorte a zatvorte kávovar.

**i** Počas nahrievania bude blikať kontrolka. Keď kontrolka zostane svietiť, kávovar je pripravený na použitie.

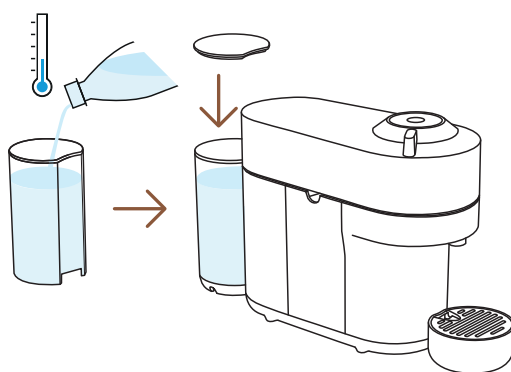

**2** Naplňte nádržku na vodu čerstvou pitnou vodou a vložte ju na miesto.

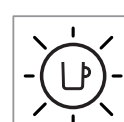
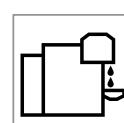
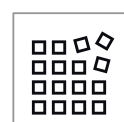
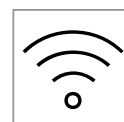

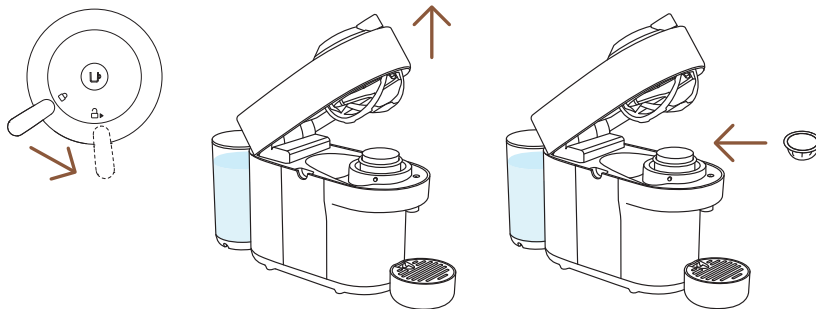

- 3** Odomknite a úplne otvorte hlavu kávovaru a vložte kapsulu Vertuo kupolovitým tvarom smerom dolu.

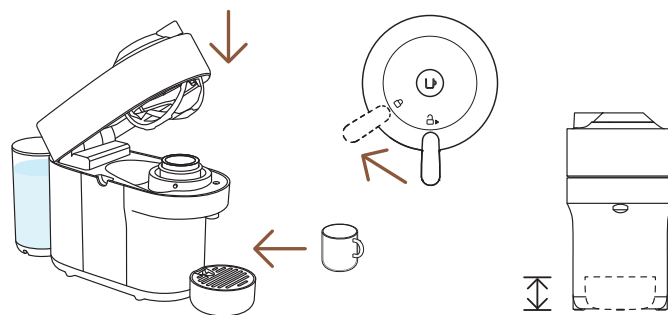

- 4** Zatvorte hlavu kávovaru a zamknite ju otočením páky doľava do uzamknutej polohy a pod výpusť kávy položte šálku. Podstavec pod šálku je možné prispôbiť veľkosti vašej šálky.

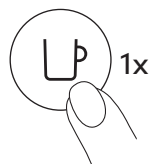

- 5** Spustite prípravu kávy stlačením tlačidla na prípravu kávy.

**UPOZORNENIE:** v rámci správneho používania kávovaru neotvárajte hlavu kávovaru počas prípravy kávy, počkajte, kým tlačidlo na prípravu kávy bude opäť svietiť bielo. Ak chcete zastaviť prípravu kávy predčasne, stlačte jedenkrát tlačidlo na prípravu kávy a pred otvorením hlavy a počkajte, kým tlačidlo na prípravu kávy nezačne opäť svietiť na bielo.

- i** Káva začne vytekať, hneď ako je načítaný čiarový kód a káva je predmáčaná a sparená. Kávovar automaticky rozpozná vloženú kapsulu a prispôbí parametre prípravy kávy a veľkosť šálky predefinovanú odborníkmi na kávu spoločnosti **Nespresso** tak, aby bola vaša káva extrahovaná čo najlepšie.

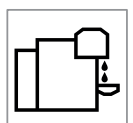

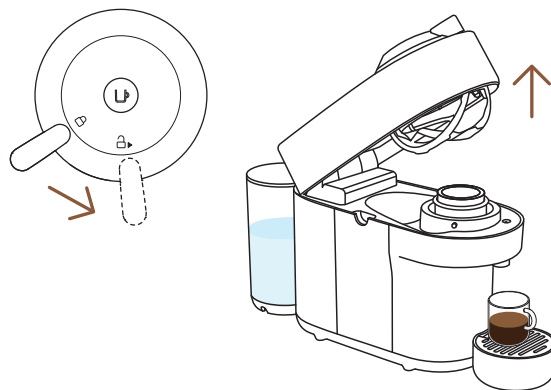

- 6** Keď je príprava kávy hotová, otvorte hlavu kávovaru otočením páky doprava do odomknutej polohy, kapsula sa automaticky vysunie a vy si môžete vychutnať svoju kávu.



- 7** Nezabudnite recyklovať kapsuly **Nespresso**.\*

\* JE TO **NESPRESSO**. JE RECYKLOVATEĽNÉ. Pre viac informácií, ako recyklovať vaše kapsuly **Nespresso**, navštívte stránku [www.nespresso.com](http://www.nespresso.com).

## OBJAVTE FUNKCIU COFFEE CREATIONS MODE



Spoločnosť **Nespresso** vám prostredníctvom tohto kávovaru ponúka funkciu koncentrácie jednotlivých príprav kávy, aby ste si mohli vytvoriť vlastné receptúry.

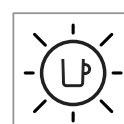
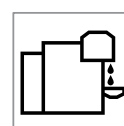
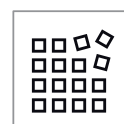
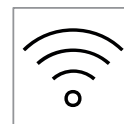

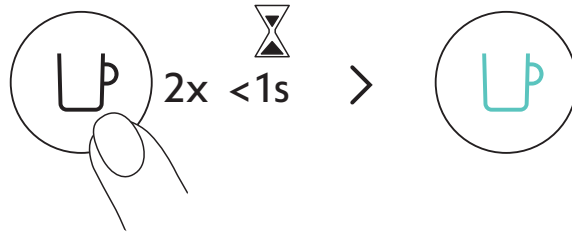

Zapnite kávovar a dvakrát kliknite na tlačidlo na prípravu kávy. Kontrolka zabliká tyrkysovo a vaše káva bude koncentrovanejšia, čo optimalizuje chuť kávy v receptúrach s prísadami (mlieko, smotana, over ice...). Pre nezabudnuteľnú chuť kávy.

40 ml	80 ml	150 ml	230 ml	355 ml	535 ml
✓	✓	✓	✓	✗	✗
25 ml	40 ml	40 ml	80 ml		

Ak chcete naplno využívať výhody, odporúčame pripravovať kávu z nášho radu Coffee+ len v určených veľkostiach šálok. Pre dosiahnutie najlepších výsledkov v šálke neodporúčame v danom režime pripravovať naše kávy XL (Alto Ambrato, Alto Onice), Cold Brew Style a Carafe Pour Over Style.

**POZNÁMKA:** pred aktiváciou tohto režimu môže byť vyžadovaná aktualizácia kávovaru prostredníctvom aplikácie **Nespresso**.



Zistite, ako môžete vylepšiť svoj kávovar pomocou našej rady šľahačov na mlieko Aeroccino. Viac informácií nájdete na [www.nespresso.com](http://www.nespresso.com).

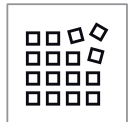



## NASTAVENIE OBJEMU KÁVY

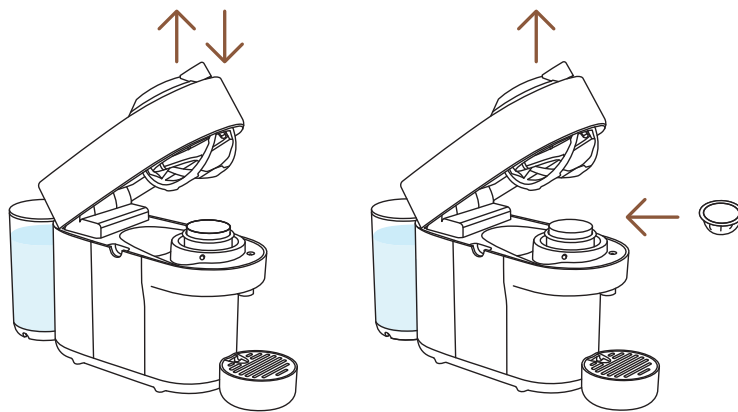

- 1** Keď je kávovar zapnutý, otvorte hlavu kávovaru a vložte kapsulu, ktorú chcete naprogramovať.

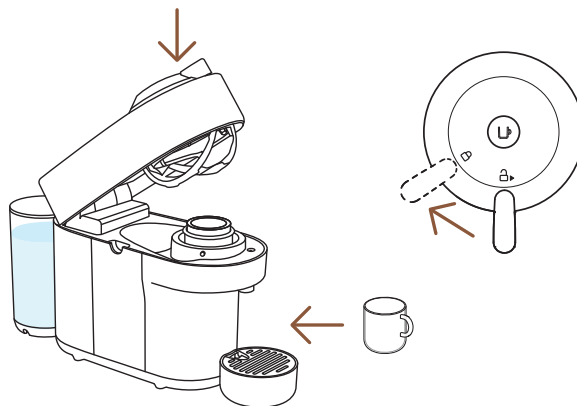

- 2** Zatvorte hlavu kávovaru, otočte páku doľava smerom do uzamknutej polohy a pod výpusť kávy položte šálku.

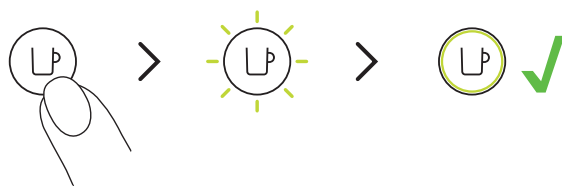

- 3** Stlačte a podržte tlačidlo na prípravu kávy. Pustite ho niekoľko sekúnd pred dosiahnutím požadovaného objemu. Nový objem vody je teraz naprogramovaný pre typ kapsuly, ktorá bola použitá pri nastavení.

- i** Nastavenie je špecifické pre každý typ kapsuly. Veľkosti šálok je možné naprogramovať od 20 ml do 535 ml.

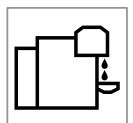
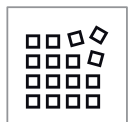

**UPOZORNENIE:** v rámci správneho používania kávovaru neotvárajte hlavu kávovaru počas prípravy kávy, počkajte, kým tlačidlo na prípravu kávy bude opäť svietiť bielo. Ak chcete zastaviť prípravu kávy predčasne, stlačte jedenkrát tlačidlo na prípravu kávy a pred otvorením hlavy a počkajte, kým tlačidlo na prípravu kávy nezačne opäť svietiť na bielo.

**UPOZORNENIE:** Keď používateľ naprogramuje špecifický objem, tak vždy, keď je v kávovare vložený daný typ kapsuly, príprava kávy sa zastaví na veľkosti objemu naprogramovanej používateľom. Ak si želáte vrátiť sa k továrenskému nastaveniu objemu, pozrite odstavec "Návrat do továrenského nastavenia".

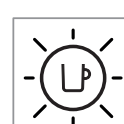
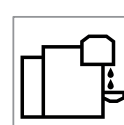
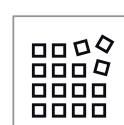
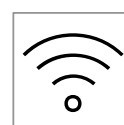

## ČISTENIE

Kávovar čistite každý mesiac, keď sa v hlave kávovaru začnú tvoriť kávové usadeniny alebo po dlhšom období nepoužívania kávovaru.

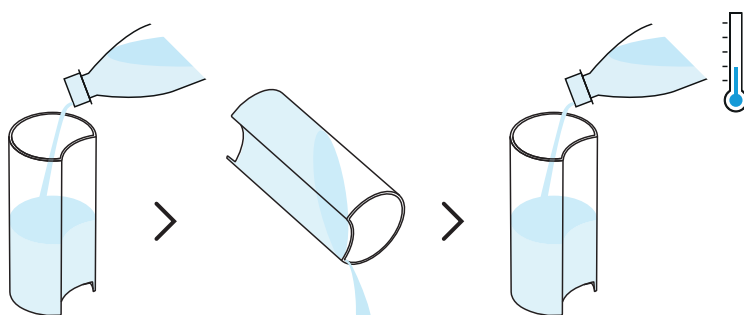

- 1** Pred naplnením nádržky na vodu čerstvou pitnou vodou ju vypláchnite a umyte.

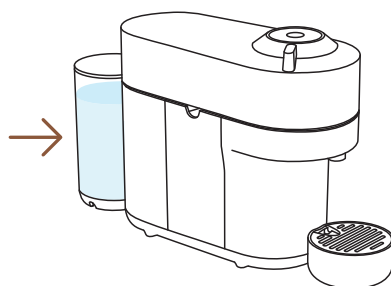

- 2** Vložte nádržku späť na miesto do kávovaru.

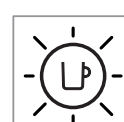
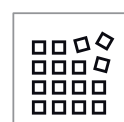
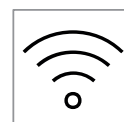

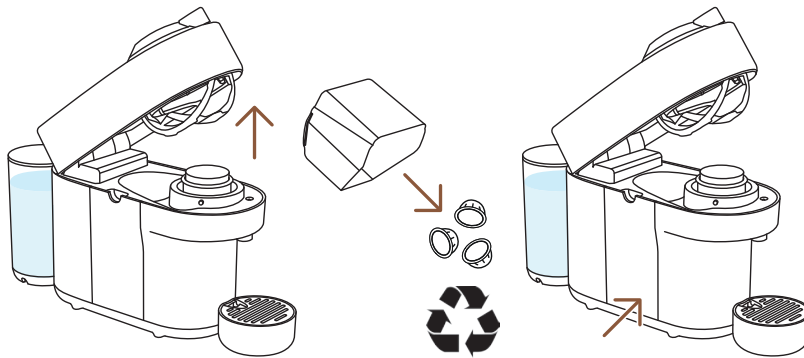

- 3** Keď je kávovar zapnutý, odomknite a otvorte hlavu, aby sa použitá kapsula vysunula. Vyprázdňte a vypláchnite kontajner na použité kapsuly a odkvapkávaciu misku, vložte ich späť na miesto. Nezabudnite recyklovať kapsuly **Nespresso**.\*

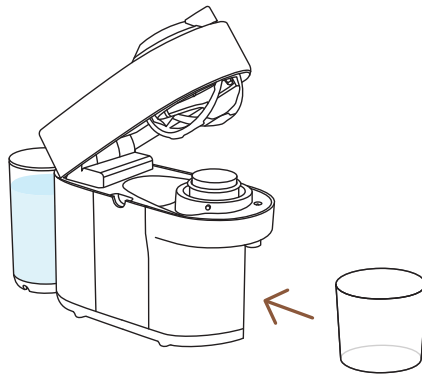

- 4** Odstráňte podstavec pod šálku a pod výpusť kávy položte prázdnu nádobu (s objemom aspoň 1 l).

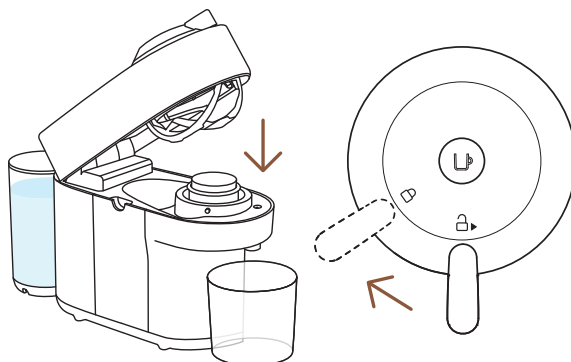

- 5** Zatvorte hlavu kávovaru a otočte páku doľava do zamknutej polohy. Pred spustením preplachovania sa uistite, že v kávovare nie je vložená žiadna kapsula.

\* JE TO **NESPRESSO**. JE RECYKLOVATEĽNÉ. Pre viac informácií, ako recyklovať vaše kapsuly **Nespresso**, navštívte stránku [www.nespresso.com](http://www.nespresso.com).

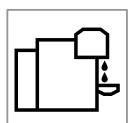

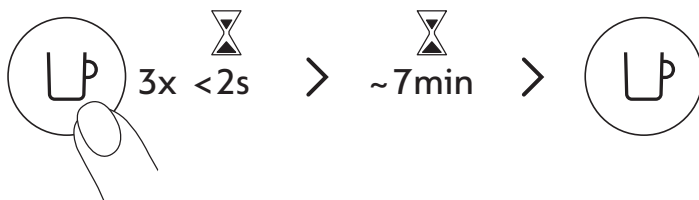

**6** Preplachovanie spustíte stlačením tlačidla trikrát za sebou v priebehu 2 sekúnd. Keď kontrolka bliká oranžovo, nechajte preplachovanie automaticky dokončiť.

**i** Proces preplachovania by sa mal spustiť a voda by mala začať tečť najneskôr do 2 minút. Tento cyklus môže trvať až 7 minút a po dokončení sa automaticky zastaví. Čistiaci cyklus je možné kedykoľvek zastaviť stlačením tlačidla.

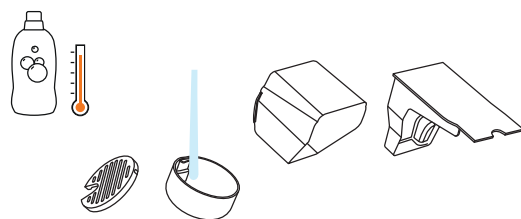

**7** Vyčistite kontajner na použité kapsuly, podstavec pod šálku a odkvapkávaciú misku teplou mydlovou vodou.

**UPOZORNENIE:** Nepoužívajte silné alebo abrazívne čistiace prostriedky alebo rozpúšťadlá. Nečistite kávovar v umývačke riadku. Nikdy neponárajte kávovar ani jeho súčasti do vody.

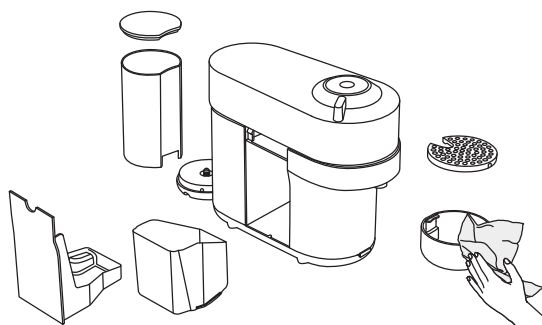

**8** Osušte ho čistou nepoužitou utierkou.

**UPOZORNENIE:** Výpusť kávy pravidelne otrite čistou vlhkou utierkou. Na čistenie kávovaru vždy používajte jemné textílie.

**UPOZORNENIE:** Vnútri hlavy kávovaru sa počas čistenia môže objaviť voda – ak to nastane, utrite mokré časti čistou suchou utierkou.

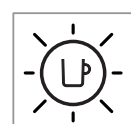
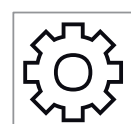
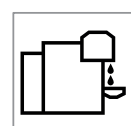
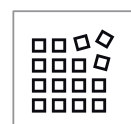
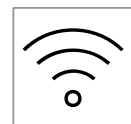

## ODVÁPŇENIE

Odvápňením kávovaru zaistíte, že váš kávovar bude fungovať správne počas celej svojej životnosti a že vám bude poskytovať nezabudnuteľné zážitky z kávy ako v prvý deň použitia. V prípade potreby odvápnenia kontrolka trikrát oranžovo zabliká a potom zostane svietiť nabiele.



**i** Odvápnovací cyklus trvá ~20 minút a **nesmie byť prerušený**.

**POZNÁMKA:** pred spustením procesu odvápnenia si pozorne prečítajte návod na odvápnenie.

### Budete potrebovať:

- Odvápnovaciu sadu, ktorú je možné objednať na [www.nespresso.com](http://www.nespresso.com)
- prázdnu nádobu s objemom 1 l

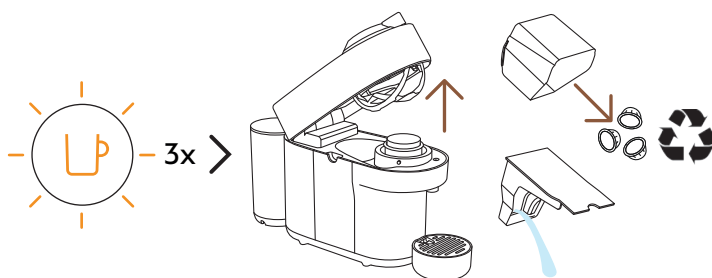

- 1** Tlačidlo trikrát oranžovo zabliká: Odomknite a otvorte hlavu kávovaru, použitá kapsula sa vysunie. Vyprázdňte kontajner na použité kapsuly a odkvapkávacu misku, potom ich vložte naspäť na miesto. Nezabudnite recyklovať kapsuly **Nespresso**.\*

\* JE TO **NESPRESSO**. JE RECYKLOVATEĽNÉ. Pre viac informácií, ako recyklovať vaše kapsuly **Nespresso**, navštívte stránku [www.nespresso.com](http://www.nespresso.com).

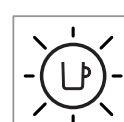
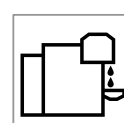
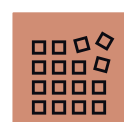
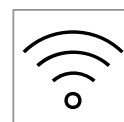

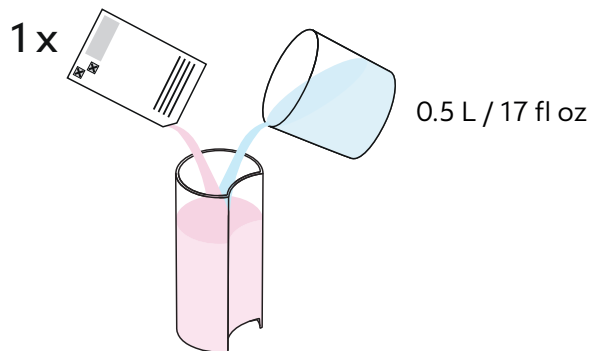

- 2** Naplňte nádržku na vodu 0,5 l vody a 1 dielom odvápňovacieho prípravku **Nespresso**.

**UPOZORNENIE:** Odvápňovací prípravok môže byť zdraviu škodlivý. Zabráňte kontaktu s očami, pokožkou a povrchmi.

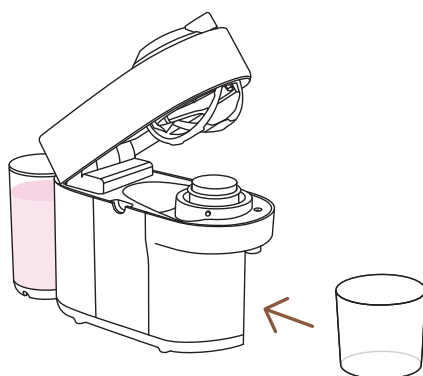

- 3** Odstráňte podstavec pod šálku a pod výpust kávy položte prázdnu nádobu (s objemom aspoň 1 l)

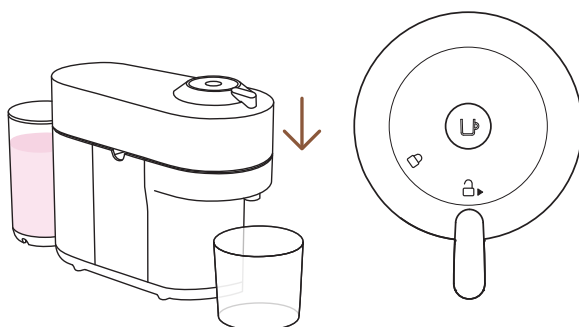

- 4** Nechajte kávovar zapnutý, zatvorte hlavu kávovaru a páku dajte do odomknutej polohy.

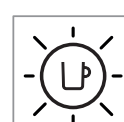
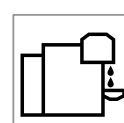
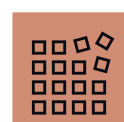
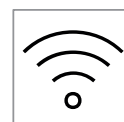

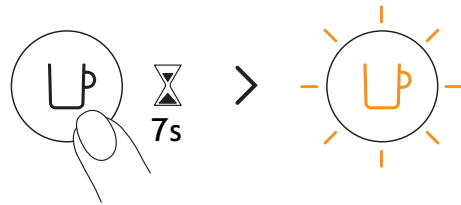

- 5** Podržte tlačidlo aspoň 7 sekúnd alebo až pokým kontrolka nezhasne. Kontrolka začne rýchlo oranžovo blikať.

**UPOZORNENIE:** Na prepnutie kávovaru do režimu odvápnovania máte 45 sekúnd. V opačnom prípade sa kávovar prepne späť do režimu prípravy kávy.

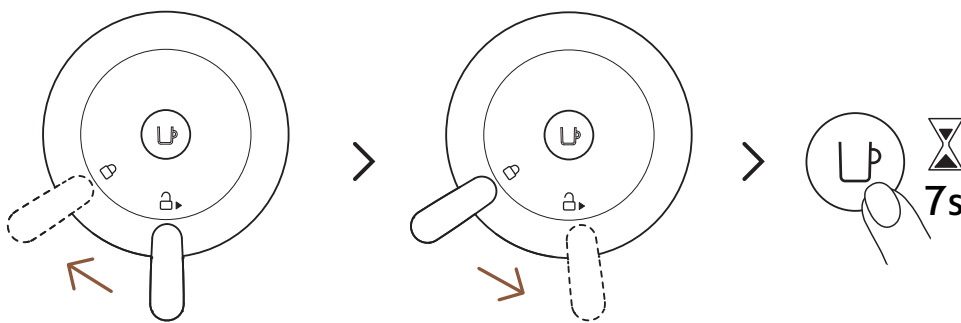

- 6** Zatvorte hlavu kávovaru a páku zatiahnite doľava do uzamknutej polohy a potom ju zatiahnite doprava do odomknutej polohy. Znovu stlačte a podržte tlačidlo na prípravu kávy približne na 7 sekúnd, alebo až pokým kontrolka nezhasne. Tlačidlo začne rýchlo oranžovo blikať.

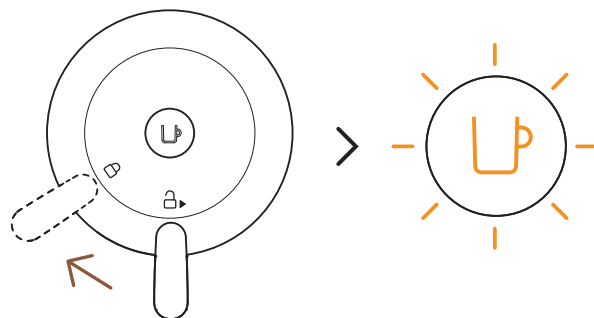

- 7** Pre vstup do odvápnovacieho režimu zatvorte kávovar zatiahnutím páky doľava do uzamknutej polohy. Kontrolka by mala stále rýchlo oranžovo blikať, čo signalizuje, že ste vstúpili do odvápnovacieho režimu.

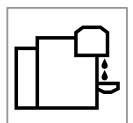
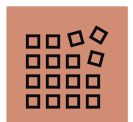



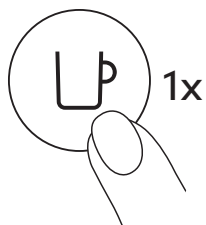

- 8** Proces odvápnenie spustíte stlačením tlačidla na prípravu kávy. Kontrolka bude počas celého procesu odvápnenia blikať na oranžovo.

- i** Cyklus sa automaticky zastaví po dokončení prvej fázy odvápnenia.

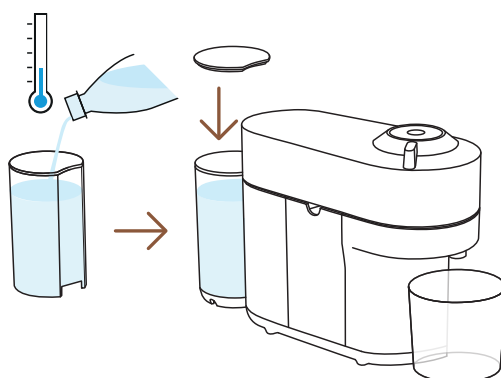

- 9** Po dokončení cyklu odvápnenia je potrebné kávovar prepláchnuť. Nádržku na vodu a odkvapkávaciu misku dôkladne vypláchnite.

Naplňte nádržku na vodu čerstvou pitnou vodou a vložte ju na miesto. Vyprázdňte nádobu a vráťte ju späť pod výpusť kávy.

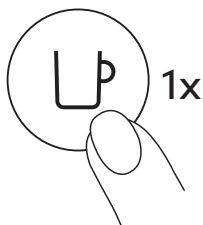

- 10** Preplachovanie spustíte stlačením tlačidla na prípravu kávy. Keď tlačidlo prestane rýchlo blikať a zostane svietiť, cyklus odvápnenia je dokončený.

- i** Kávovar automaticky zastaví cyklus odvápňovania po jeho dokončení.

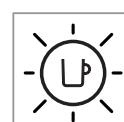
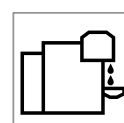
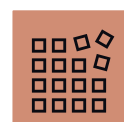
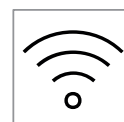

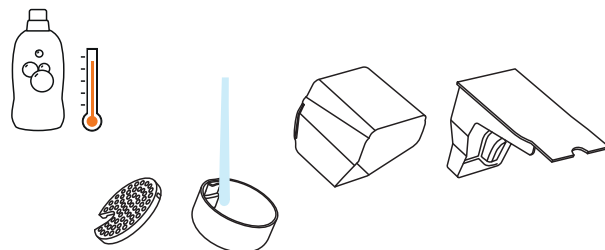

- 11** Umyte kontajner na použité kapsuly, podstavec pod šálku a odkvapkávaciú misku teplou mydlovou vodou.

**UPOZORNENIE:** Nepoužívajte silné alebo abrazívne čistiace prostriedky alebo rozpúšťadlá. Nečistite kávovar v umývačke riadu. Prístroj ani jeho súčasti nikdy neponárajte do vody.

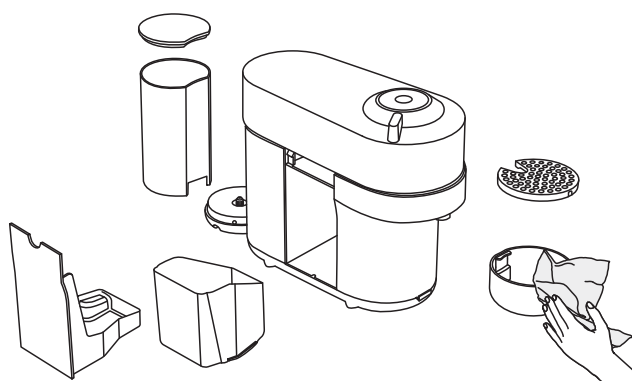

- 12** Kávovar osušte čistou utierkou. Pred použitím nechajte kávovar 10 minút vyschnúť.

**UPOZORNENIE:** Vnútri hlavy kávovaru sa počas čistenia môže objaviť voda. Ak to nastane, utrite mokré časti čistou suchou utierkou.

**UPOZORNENIE:** kávovar môže spustiť režim odvápnenia až po príprave minimálne 30 káv.

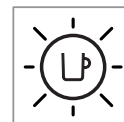
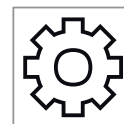
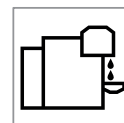
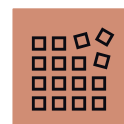
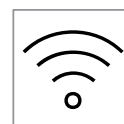

## VYPRÁZDŇOVANIE SYSTÉMU

Odporúča sa vyprázdniť systém pred obdobím nepoužívania kávovaru, ako prevencia pred mrazom alebo pred odoslaním na opravu.

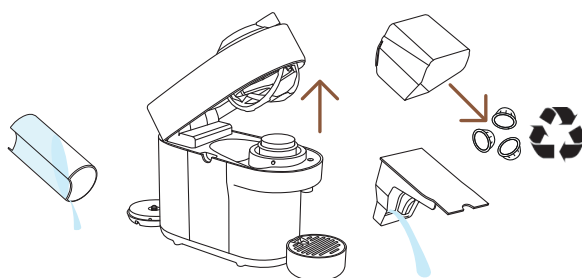

- 1 Vyprázdňte nádržku na vodu a otvorte hlavu kávovaru, použitá kapsula sa vysunie. Vyprázdňte kontajner na použité kapsuly a odkvapkávaciu misku. Nezapudnite recyklovať kapsuly **Nespresso**.\*

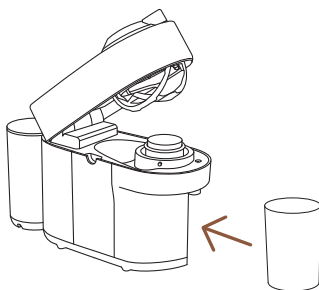

- 2 Vložte ich na miesto do kávovaru, odstráňte podstavec pod šálku a pod výpusť kávy položte prázdnu nádobu (s objemom 0,5 l).

\* JE TO **NESPRESSO**. JE RECYKLOVATEĽNÉ. Pre viac informácií, ako recyklovať vaše kapsuly **Nespresso**, navštívte stránku [www.nespresso.com](http://www.nespresso.com).

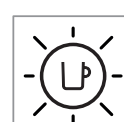
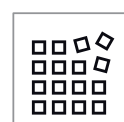
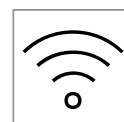

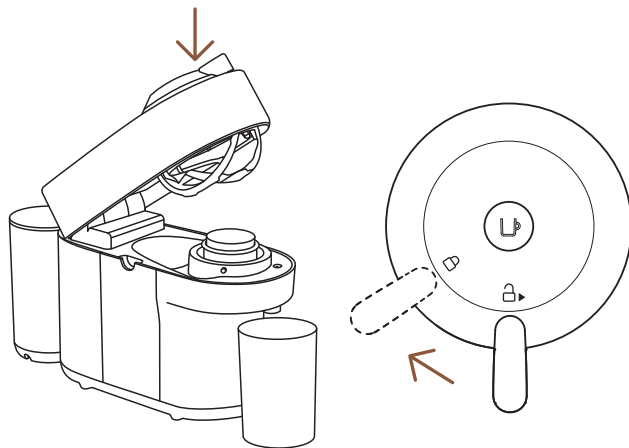

- 3** Keď je kávovar zapojený do siete a zapnutý, otočte páku do uzamknutej polohy.

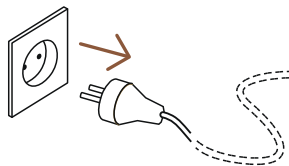

- 4** Odpojte kávovar zo zásuvky.

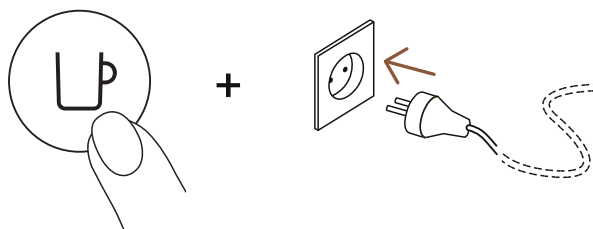

- 5** Pri zapájaní kávovaru do siete stlačte a podržte tlačidlo.

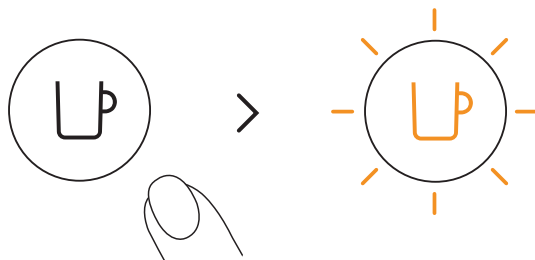

- 6** Uvoľnite tlačidlo. Bude blikať oranžovo a spustí sa cyklus vyprázdňovania.

- i** Cyklus vyprázdňovania trvá približne 30 sekúnd. Po dokončení vyprázdňovania sa kávovar automaticky vypne.

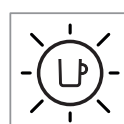
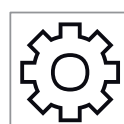
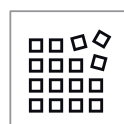
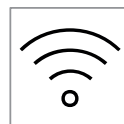
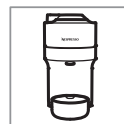

## OBNOVENIE TOVÁRENSKÝCH NASTAVENÍ

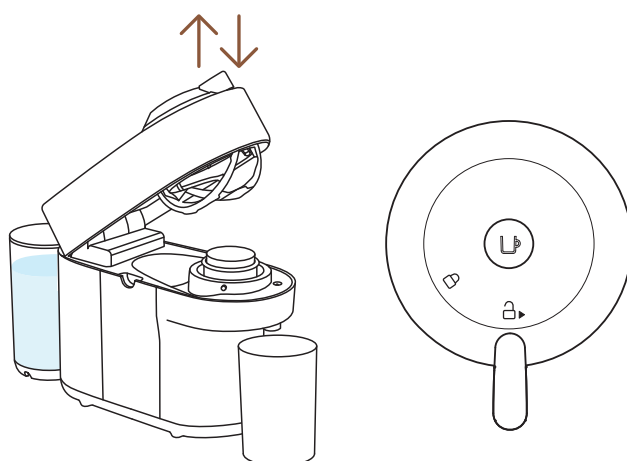

- 1** Nechajte kávovar zapojený do siete, otvorte a zatvorte kávovar a potom nechajte páku v odomknutej polohe.

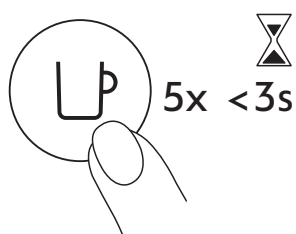

- 2** Stlačte tlačidlo päťkrát počas 3 sekúnd. Kávovar je teraz naprogramovaný na továrenské nastavenia.

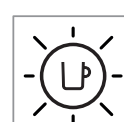
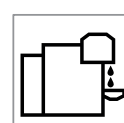
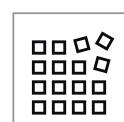
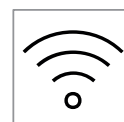

## VÝZNAM SVETELNÝCH SIGNÁLOV

Chcete sa dozvedieť viac o svetelných signáloch kávovaru Vertuo Pop? Pozrite sa na nasledujúce video:

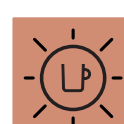
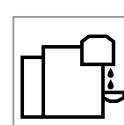
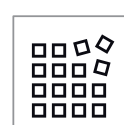
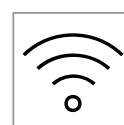

## RIEŠENIE PROBLÉMOV

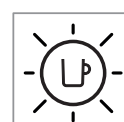
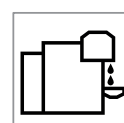
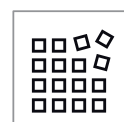
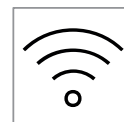

### Tlačidlo nesvieti

- Kávovar sa automaticky vypol; stlačte tlačidlo na prípravu kávy alebo odomknite kávovar.
- Skontrolujte prívodný kábel, zásuvku, elektrické napätie a poistky.

### Z kávovaru nevyteká káva ani voda.

- Skontrolujte, či je v nádržke na vodu voda.
- Skontrolujte, či je kapsula vložená v správnej pozícii a či je páka v zamknutej polohe. Potom stlačte tlačidlo na prípravu kávy.
- V prípade potreby kávovar odvápnite.
- Otvorte hlavu kávovaru, použitá kapsula sa vysunie. Potom kávovar vyčistíte podľa návodu.

### Káva nie je dosť teplá.

- Predhrejte šálku teplou vodou z kohútika.
- V prípade potreby kávovar odvápnite.

### Prístroj netesní alebo káva vyteká inak než obvykle.

- Skontrolujte, či je nádržka na vodu v správnej pozícii.
- V prípade potreby kávovar odvápnite.

### Kávovar sa sám vypína.

- Kávovar sa kvôli úspore energie po 2 minútach nepoužívania vypne.
- Kávovar môžete kedykoľvek VYPNÚŤ aj manuálne (ak ho nepoužívate), a to stlačením a podržaním tlačidla počas 3 sekúnd.

### V šálke je kávová usadenina.

- Vykonajte čistiaci cyklus dvakrát za sebou.
- Pozri odstavec „Čistenie“.

### Kávovar sa nechce spustiť a tlačidlo trvalo svieti. (Ak bliká, pozri ďalej.)

- Skontrolujte, či je páka v uzamknutej polohe.
- Ak si chcete pripraviť kávu, skontrolujte, či je kapsula v kávovare vložená v správnej pozícii a či je páka uzamknutej polohe. Potom stlačte tlačidlo na prípravu kávy.
- Ak prístroj čistíte, odvápnujete alebo vyprázdňujete, najskôr skontrolujte, či v kávovare nie je vložená žiadna kapsula, zamknite ho a potom zahájte proces, ktorý ste plánovali.

**Kávovar sa nechce spustiť a tlačidlo bliká v režime 1 bliknutie a 1 pauza.**

**Keď kávovar pracuje, tlačidlo bliká.**

**Kávovar nefunguje a tlačidlo bliká v režime 1 bliknutie a 1 pauza.**

- Naplňte nádržku na vodu a stlačte tlačidlo na prípravu kávy.
- Skontrolujte, či je páka v uzamknutej polohe.
- Ak z kávovaru vyteká káva ako obvykle, všetko je v poriadku.
- Ak z kávovaru vyteká iba voda, znamená to, že prebieha čistenie, odvápnovanie alebo vyprázdňovanie. Postupujte podľa pokynov v príslušnej časti návodu.
- Stlačte tlačidlo na 3 sekundy, aby sa kávovar vypol a opätovným stlačením tlačidla ho znovu zapnite. Následne počkajte približne 20 minút, kým kávovar po intenzívnom používaní vychladne.
- Je normálne, že káva začne vytekať až po chvíli (kávovar musí najskôr prečítať čiarový kód a spracovať kávu).
- Skontrolujte, či je kapsula vložená v správnej pozícii a či je páka v zamknutej pozícii. Potom stlačte tlačidlo na prípravu kávy.
- Naplňte nádržku na vodu a stlačte tlačidlo na prípravu kávy.
- Stlačte tlačidlo na 3 sekundy, aby sa kávovar vypol a opätovným stlačením tlačidla ho znovu zapnite. Následne počkajte približne 20 minút, kým kávovar po intenzívnom používaní vychladne.

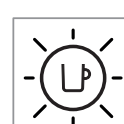
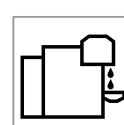
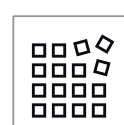
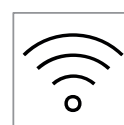



**Tlačidlo trvalo bliká v režime 2 bliknutia a 1 pauza. Kávovar nepracuje.**

- Stalo sa počas bežnej prípravy kávy:
  - 1) Odomknite páku a otvorte hlavu kávovaru, aby ste skontrolovali, či je nová neporušená kapsula vložená v správnej pozícii.
  - 2) Skontrolujte, či je páka v uzamknutej polohe.
  - 3) Skontrolujte, či je v nádržke na vodu voda.
- Stalo sa počas odvápnovania, vyprázdňovania alebo čistenia:
  - 1) Skontrolujte, či bola kapsula vysunutá.
  - 2) Skontrolujte, či je páka v uzamknutej polohe.
- Stalo sa počas nastavovania objemu nápoja:
  - 1) Skontrolujte, či je nová kapsula správne vložená.
  - 2) Poskupujte podľa pokynov v časti návodu **“Nastavenie objemu kávy”**.
- Ak problém pretrváva:
  - 1) Odomknite páku a otvorte hlavu kávovaru.
  - 2) Upravte polohu kapsuly (ak je to potrebné).
  - 3) Vytiahnite prírodný kábel zo zásuvky, počkajte 10 sekúnd a zapojte ho späť.
  - 4) Zatvorte hlavu kávovaru, stlačte tlačidlo, aby sa kávovar zapol, a potom ho stlačte znovu, aby sa spustila príprava kávy. Ak problém pretrváva, kontaktujte spoločnosť **Nespresso**.
- Potreba odvápnenia. Potom, čo sa toto upozornenie objaví, je možné kávovar ešte chvíľu používať. Následne je však nevyhnutné kávovar odvápnit.

**Kontrolka striedavo trikrát bliká a potom trvalo svieti.**

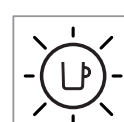
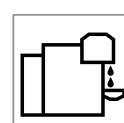
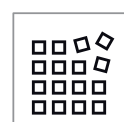
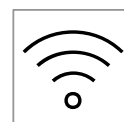

## TECHNICKÉ ÚDAJE

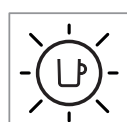
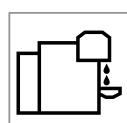
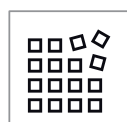
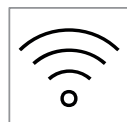

**Napájanie** ~220–240 V, 50–60 Hz, 1300–1500 W  
**US, CA:** 120 V, 60 Hz, 1500 W  
**MX:** 127 V~, 60 Hz, 1380 W

**Kmitočet** 2.402–2.480 GHz

**Ekvivalentný izotropne vyžiarený výkon (EIRP)** Bluetooth 4 dBm max. EIRP a WiFi <20 dMm max. EIRP

**Pohotovostný režim** 0.39 W/h

**Režim úspory energie** Automatické vypnutie: po 2 min.

**Doba nahrievania** 30 sekúnd (hlava kávovaru zatvorená a uzamknutá)

**Odnímateľný podstavec pod šálky na väčšie receptúry** Nastaviteľná samostatná pozícia

**Dĺžka kábla z kávovaru** 75 cm

**Rozmery (š x h x v)** 13.6 x 42.6 x 25 cm / 5.3 x 16.7 x 9.8 in

**Hmotnosť** 3.5 kg / 7.72 lbs

**Objem nádržky na vodu** 0.6 l / 20 fl oz

**Kapacita zásobníka na kapsuly** 8 kapsúl veľkosti Espresso alebo 5 kapsúl veľkosti Mug

## KÓDY KÁVOVAROV

### Nespresso

GCV2, GDV2

### Breville

BNV120, BNV150

### Delonghi

ENV90

### Krups

XN9201, XN9204,  
 XN9205, XN9211

### Magimix

M800

# KATTINTSON, ÉS VÁLASSZA KI A NYELVET

**HU**



**BIZTONSÁG**



**ÁTTEKINTÉS**



**KAPCSOLÓDÁS**



**ELSŐ LÉPÉSEK**



**KÁVÉKÉSZÍTÉS**



**ÁLLÍTSA BE SAJÁT KÁVÉMENNYISÉGÉT**



**TISZTÍTÁS**



**VÍZKŐMENTESÍTÉS**



**A RENDSZER ÜRÍTÉSE**



**GYÁRI ÉRTÉKEK VISSZAÁLLÍTÁSA**



**ÁLLAPOTJELZÉSEK**



**HIBAELHÁRÍTÁS**



**MŰSZAKI ADATOK**

## BIZTONSÁG

**VIGYÁZAT:** A készülék használata előtt kérjük, olvassa el a biztonsági előírásokat tartalmazó tájékoztatót az esetleges sérülések és károk megelőzése érdekében.

### MEGSEMMISÍTÉS ÉS KÖRNYEZETVÉDELEM

Ez a készülék megfelel a 2012/19/EC direktíva irányelveinek. A csomagolás és a készülék újrahasznosítható anyagokat tartalmaz. A készülékben értékes, összegyűjthető vagy újrahasznosítható anyagok találhatók. A szelektív hulladékgyűjtés lehetővé teszi az értékes nyersanyagoknak az újrahasznosítását. Adja le a készüléket egy gyűjtőhelyen. Az ártalmatlanítás módjáról a helyi hatóságoktól kaphat információkat.

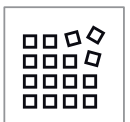

# ÁTTEKINTÉS

## A KÉSZÜLÉK ÁTTEKINTÉSE

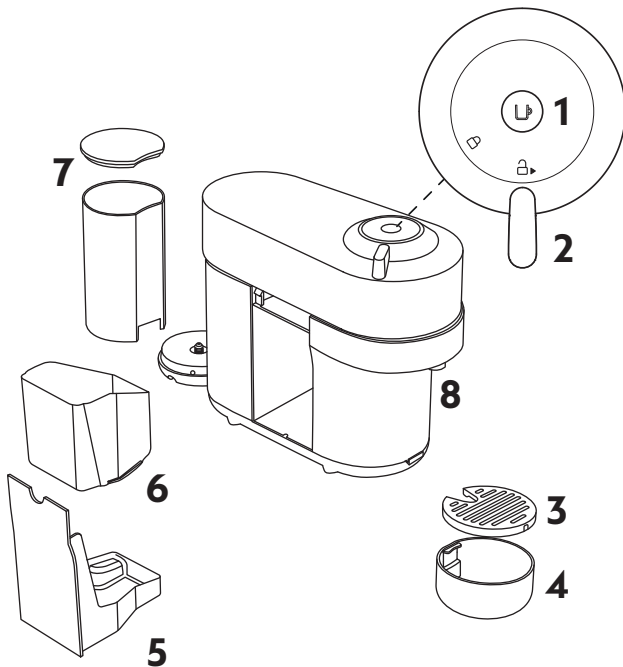

- 1 BE/KI és kávé gomb
- 2 Záró/Nyitó kar
- 3 Cseprács
- 4 Állítható csészetartó
- 5 Csepptálca
- 6 Használtkapszula-tároló
- 7 Víztartály és fedő
- 8 Kávékifolyó

## A CSOMAG TARTALMA



- 1 Kávégép
- 2 **Nespresso** kapszulákat tartalmazó doboz
- 3 **Nespresso** üdvözlőanyagok
- 4 Biztonsági előírások
- 5 Gyors üzembehelyezési útmutató
- 6 Garancia

**i Kicsomagolás:** A csomagolás újrahasznosított anyagokból készült, így előfordulhat, hogy por kerül a készülékre. Ez nem jelent veszélyt, csupán törölje le egy puha kendő használatával. Amikor kicsomagolja a készüléket, távolítsa el a műanyag fóliát.

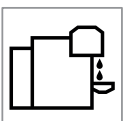

## NYIT/ZÁR

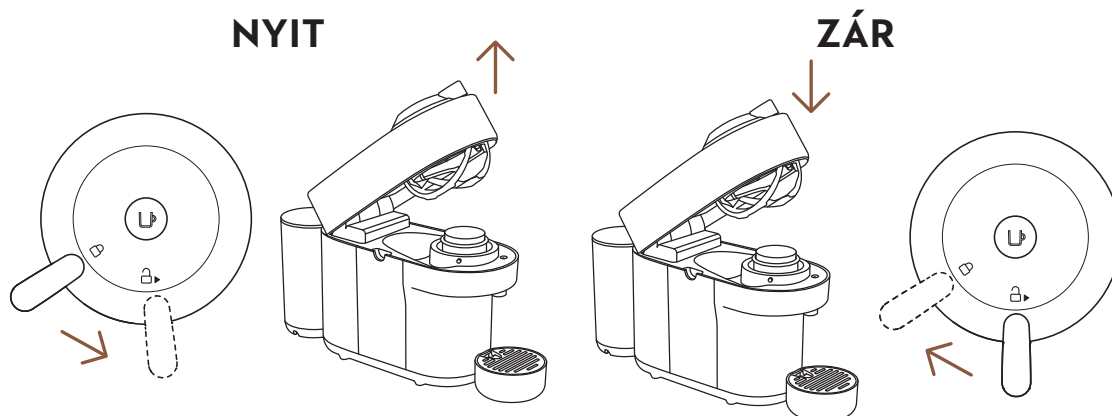

**FIGYELEM:** A készülék megfelelő használata érdekében ne nyissa fel a fejet, amíg fő a kávé, várjon amíg a kávégomb folyamatos fehér fényre vált. Ha hamarabb szeretné megállítani a főzést, nyomja meg egyszer a gombot, és várjon amíg a készülék megáll, mielőtt kinyitná a fejet.

## A VERTUO RENDSZER

### KAPSZULAKOMPATIBILITÁS



**S**

**Ristretto**  
(25 ml)

**Espresso**  
(40 ml)



**M**

**Double Espresso**  
(80 ml)

**Gran Lungo**  
(150 ml)



**L**

**Mug**  
(230 ml)

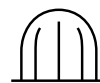

**XL**

**Alto, Cold Brew Style**  
355 ml

**Carafe**  
(535 ml)

### KIEGÉSZÍTŐK KOMPATIBILITÁSA



Kiegészítők  
kompatibili-  
tása



**Ristretto**



**Espresso**



**Double Espresso**



**Gran Lungo**



**Mug (S)**



**Mug (M)**



**Reveal pohár**



Nem használ-  
ható kiegészí-  
tők



**Mug (L)**



**Carafe**

Fedezze fel kiegészítő-kínálatunkat a [www.nespresso.com](http://www.nespresso.com) oldalon.

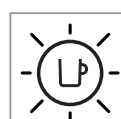
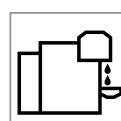
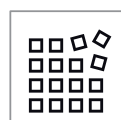
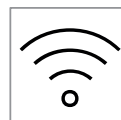

KI/BE

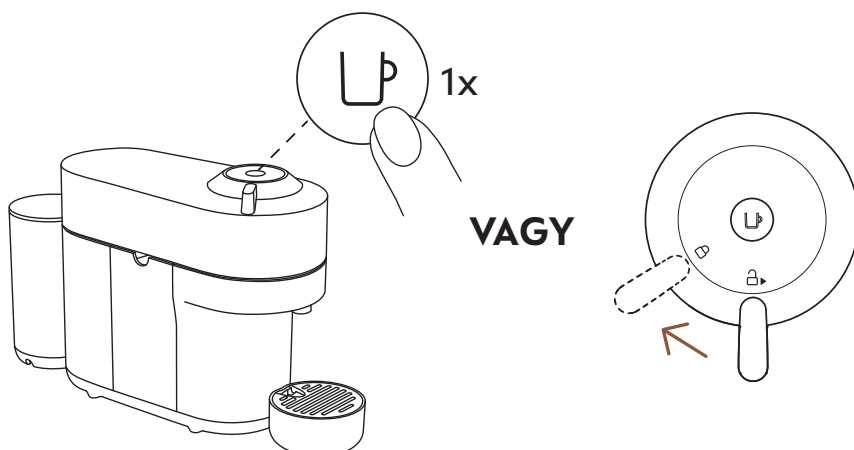

**KI**

Amint a készüléket csatlakoztatta, kapcsolja be a gomb egyszeri megnyomásával, vagy a kar lezárásával (csukott fej mellett).

- i** A led villogni fog körülbelül 30 másodpercig, amíg a készülék felfűt. Amint a led folyamatosan világít, a gép kész a használatra.

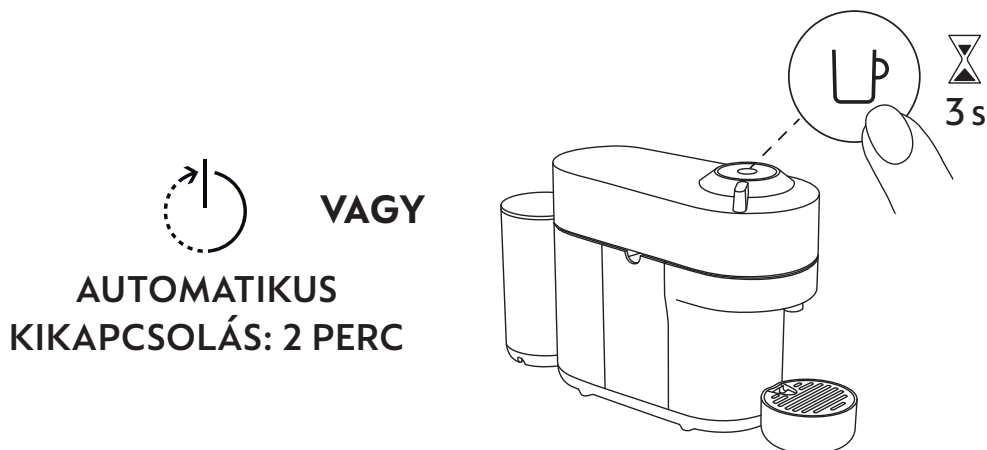

**BE**

Azért hogy energiát takarítson meg, a készülék kikapcsol 2 perc használatonkívülség után.

- i** A készüléket ki lehet kapcsolni bármikor használaton kívül, a gomb 3 másodpercig tartó nyomvatartásával.

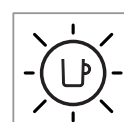
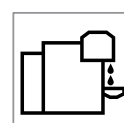
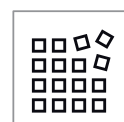
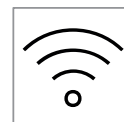

## KAPCSOLÓDÁS

### MIÉRT ÉRDEMES CSATLAKOZTATNI AZ APPLIKÁCIÓHOZ A VERTUO POP KÉSZÜLÉKEKET?

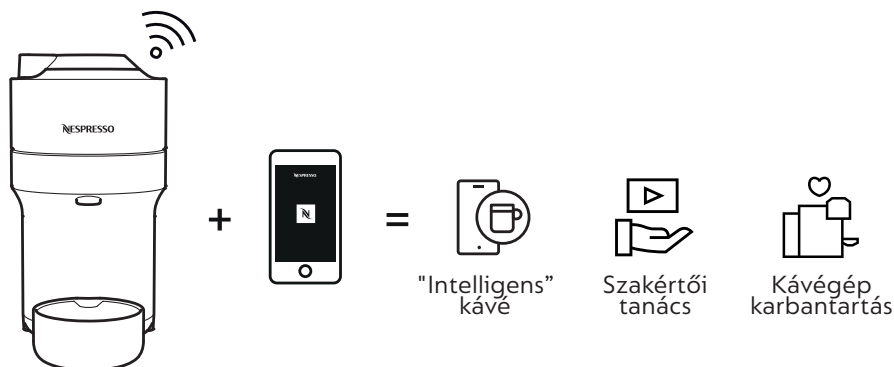

### A VERTUO POP GÉP CSATLAKOZTATÁSÁNAK ELŐNYEI

- **"Intelligens" kávé:** Járjon egy lépéssel előrébb a legújabb kávé-újdonságokról szóló információkkal, készülékének tökéletes állapotban és naprakészen tartásával.
- **Szakértői tanács:** Kapjon támogatást, és férjen hozzá egyszerű bemutató videóinkhoz okostelefonján kávé utazása során.
- **Kávégép-karbantartás:** Kapjon egyszerű leírásokat a vízkőmentesítésről, öblítésről, tisztításról, valamint azonnali emlékeztetőket arról, hogyan és hol lehet szervizelni készülékét.

### HOGYAN CSATLAKOZTATHATJA VERTUO POP KÉSZÜLÉKÉT.

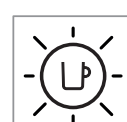
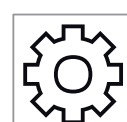
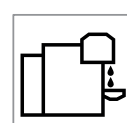
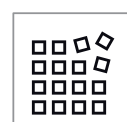



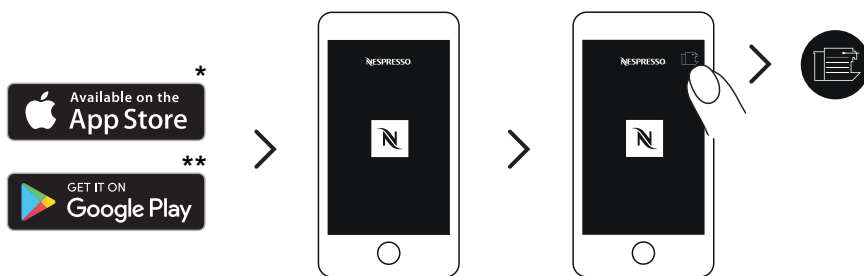

- 1** Töltse le, vagy frissítse a **Nespresso** applikációt. Indítsa el a **Nespresso** applikációt okostelefonján vagy tabletjén. Nyomja meg a készülék ikont a képernyő jobb felső sarkában.

**MEGJEGYZÉS:** Az optimális működés és a zavartalan élmény érdekében javasoljuk, hogy egy wi-fi router-hez csatlakoztassa készülékét, okostelefon hotspot helyett.

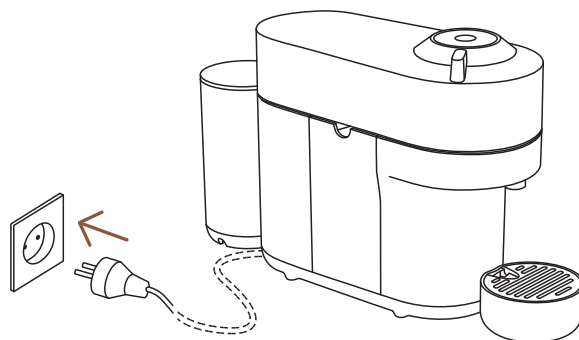

- 2** Dugja be a tápkábelt.



- 3** Kövesse a **Nespresso** applikációban megjelenő utasításokat.

**VIGYÁZAT:** Először olvassa el a biztonsági utasításokat a halálos áramütések illetve tűz elkerüléséhez. Kérjük, biztosítsa a folytonos földelést, amikor csatlakoztatja a készüléket az áramforráshoz.

\* Az App Store® az Apple Inc. bejegyzett védjegye, regisztrált az Amerikai Egyesült Államokban és más országokban.

\*\* A Google Play és a Google Play logó a Google LLC. bejegyzett védjegyei.

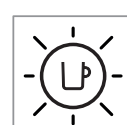
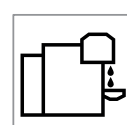
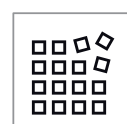

## A BLUETOOTH ÉS A WI-FI KIKAPCSOLÁSA

A gépben található egy összekapcsolhatósági modul, amely gyárilag engedélyezve van. Ennek segítségével plusz funkciókhoz férhet hozzá, tovább emelve a kávézási élményt. Az összekapcsolhatósági modul letiltásához kövesse a következő lépéseket:

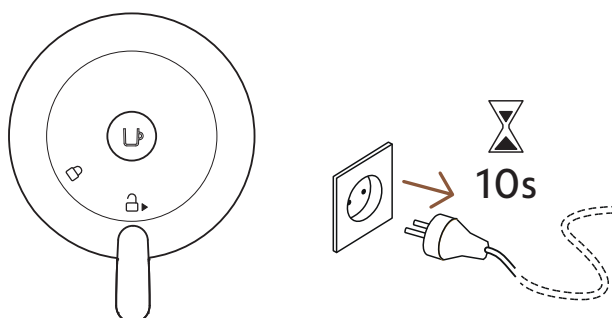

- 1** Miközben a gép be van csukva és a kar **"unlock"** állásban van, húzza ki a készüléket legalább 10 másodpercre.

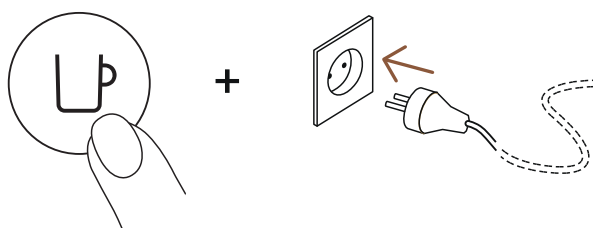

- 2** Tartsa lenyomva a gombot, amíg áram alá helyezi a készüléket.  
A gomb narancs színnel felvillan, mutatva, hogy az összekapcsolhatósági modul tiltása megtörtént.

- i** Kövesse ugyanezeket a lépéseket az összekapcsolhatósági modul újbóli engedélyezéséhez. A gomb fehér színnel felvillan, mutatva hogy az összekapcsolhatósági modul engedélyezése megtörtént.

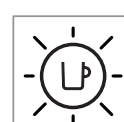
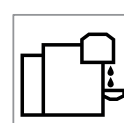
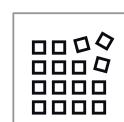

# ELSŐ LÉPÉSEK

## ELSŐ ÁTÖBLÍTÉS

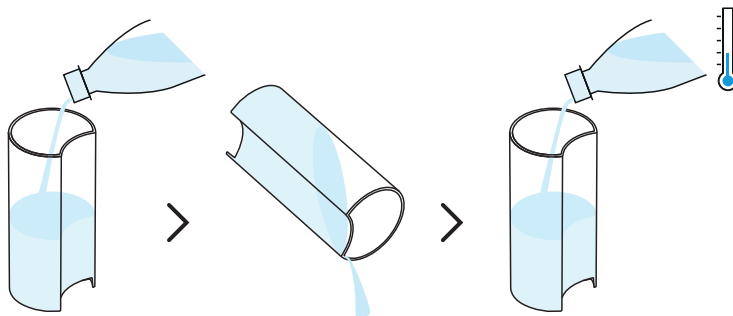

- 1** Öblítse el tiszta vízzel a víztartályt és a víztartály-fedőt, mielőtt először megtöltené ivóvízzel.

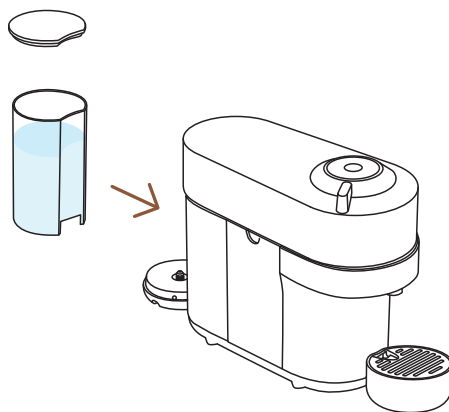

- 2** Tegye rá a fedőt a víztartályra, azt pedig helyezze a helyére, és ellenőrizze hogy megfelelően csatlakozik-e.



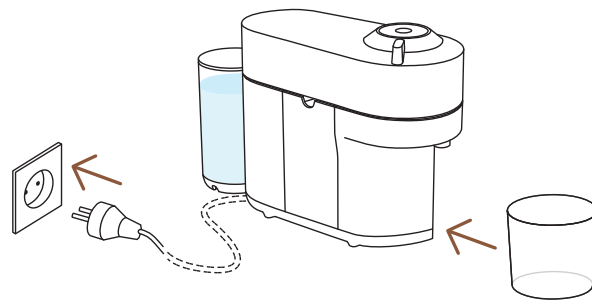

- 3** Bedugott tápkábel mellett, távolítsa el a csészetartót és helyezzen egy üres edényt (legalább 1 literest) a kávékifolyó alá.

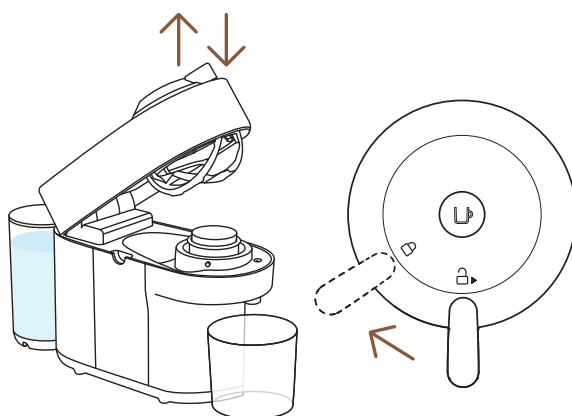

- 4** Nyissa fel, majd csukja le a készüléket. Ellenőrizze, hogy a kar zárt állásban van-e.

- i** A fény villogni fog, amíg a készülék felfűt. Ez körülbelül 30 másodpercig tart. Amint a fény folyamatosan világít, a gép készen áll. Bizonyosodjon meg róla, hogy nincs behelyezve kapszula.

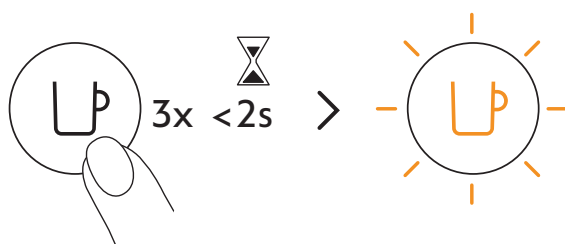

- 5** Nyomja meg a gombot 3-szor 2 másodpercen belül, hogy meginduljon az öblítés. Hagyja, hogy az öblítés automatikusan lefusson, miközben a fény narancs színnel villog. Amint a fény folyamatosan fehérre változik, a folyamat lezárult.

- i** Kevesebb mint 2 perc, mielőtt az öblítési folyamat elkezdődik, és a víz elkezd folyni. A folyamat akár 7 percet is igénybe vehet.

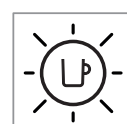
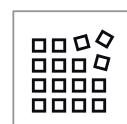
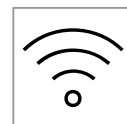
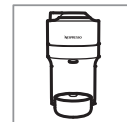

# KÁVÉKÉSZÍTÉS

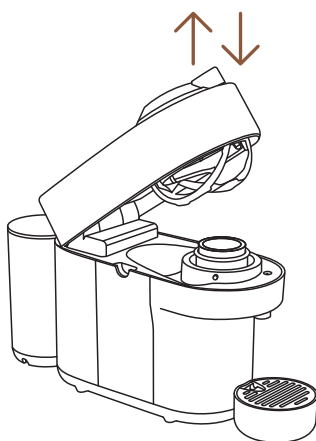

**1** Nyissa ki majd zárja be a készüléket.

**i** A kávégomb fénye villog, amíg a készülék felfűt. Amint a fény folyamatosan világít, a gép készen áll.

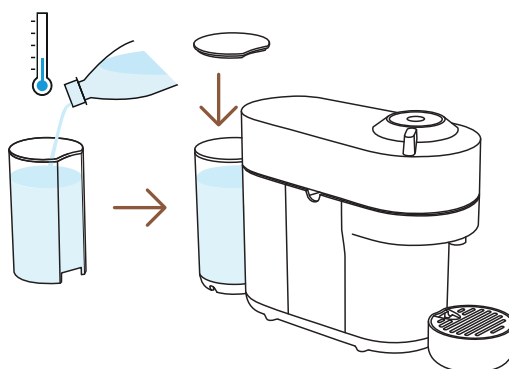

**2** Töltse meg a víztartályt friss ivóvízzel, és tegye vissza a helyére.

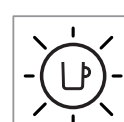
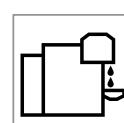
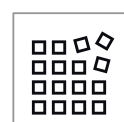
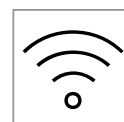

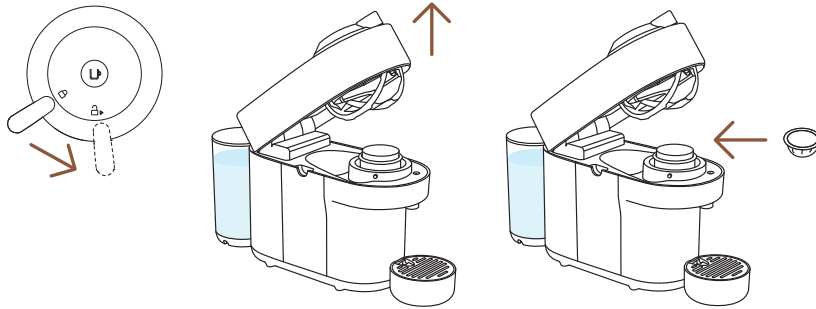

- 3** Nyissa ki, majd nyissa fel a készülék fejét teljesen, és helyezzen be egy Vertuo kapszulát a domború felével lefelé.

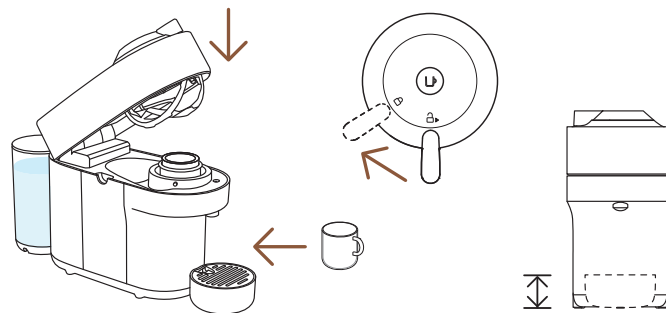

- 4** Csukja be a készülék fejét, majd a kart balra, a "lock" állásba fordítva zárja be, és helyezzen alá egy csészét. A csészetartó állítható a csészeméretnek megfelelően.

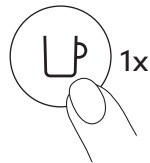

- 5** Indítsa el a gomb egyszeri megnyomásával.

**FIGYELEM:** A készülék megfelelő használata érdekében ne nyissa fel a fejet, amíg fő a kávé, várjon amíg a kávégomb folyamatos fehér fényre vált. Ha hamarabb szeretné megállítani a főzést, nyomja meg egyszer a gombot, és várjon amíg a készülék megáll, mielőtt kinyitná a fejet.

- i** A kódbeolvasás, valamint a kávé előnedvesítése és áztatás miatt kis időbe telik, mire a kávé el kezd folyni. A készülék automatikusan felismeri a behelyezett kapszulát, és kiválasztja a **Nespresso** szakértői által meghatározott kávéfőzési paramétereket és csészeméretet annak érdekében, hogy a kávékeverékhez illeszkedő, legjobb kivonás valósuljon meg.



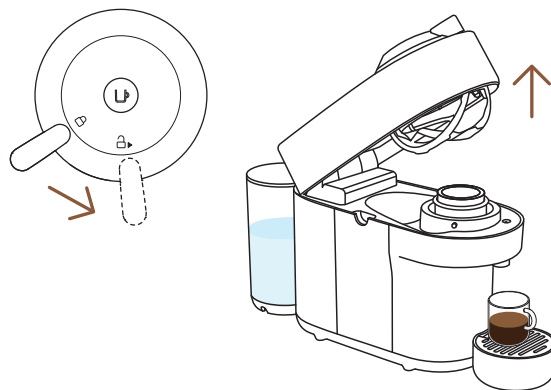

- 6** Amikor a kávéfőzés megállt, nyissa ki a készülék fejét a kar jobbra, az "unlock" állásig történő elfordításával, hogy a kapszula automatikusan kilökődjön, majd élvezze a kávézást.



- 7** Ne felejtse el újrahasznosítani **Nespresso** kapszuláit.\*

\* EZ **NESPRESSO**. ÚJRAHASZNOSÍTHATÓ. A **Nespresso** kapszulák újrahasznosításával kapcsolatos információkért látogasson el a [www.nespresso.com](http://www.nespresso.com) oldalra.

## FEDEZZE FEL A KÁVÉKREÁCIÓK ÜZEMMÓDOT.



Ennek a készüléknek a speciális funkciójával a **Nespresso** lehetőséget nyújt Önnek a kávékivonások koncentrálására, hogy létrehozhasa az Ön saját receptjeit.

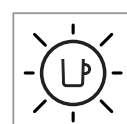
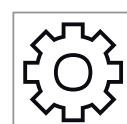
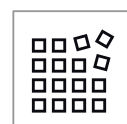
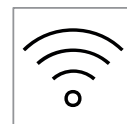

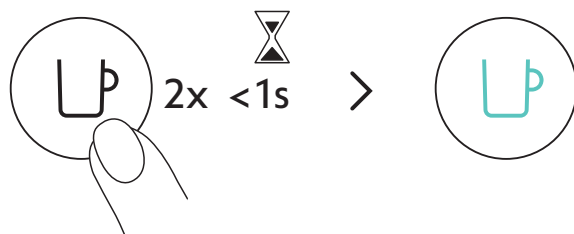

A gép bekapcsolt állapotában duplán nyomja meg a kávégombot. Türkiz színnel fog villogni, és a lefőtt kávé koncentrált lesz, receptekhez illetve hozzáadott kiegészítőkhöz (tej, tejszín, jég) optimalizálva a kávé ízét a kivételes ízélményért.

40 ml	80 ml	150 ml	230 ml	355 ml	535 ml
✓	✓	✓	✓	✗	✗
25 ml	40 ml	40 ml	80 ml		

Az előnyök tökéletes kihasználásához javasoljuk, hogy a Coffee+ kínálatunkat csak a javasolt csészeméretben főzze le. A legjobb eredményért a csészében, nem javasoljuk az XL (Alto Ambrato, Alto Onice), Cold Brew Style és Carafe Pour Over Style kínálatunk főzését ebben a módban.

**MEGJEGYZÉS:** Készülékének frissítése a **Nespresso** applikáción keresztül szükséges lehet ennek a módnak az eléréséhez.

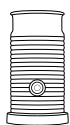

Fedezze fel a [www.nespresso.com](http://www.nespresso.com) oldalon, hogyan egészítheti ki készülékét az Aeroccino kínálatunk segítségével.

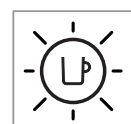
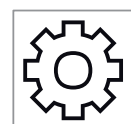
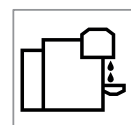
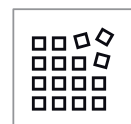
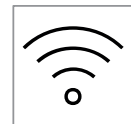



## ÁLLÍTSA BE A KÁVÉMENNYISÉGEKET

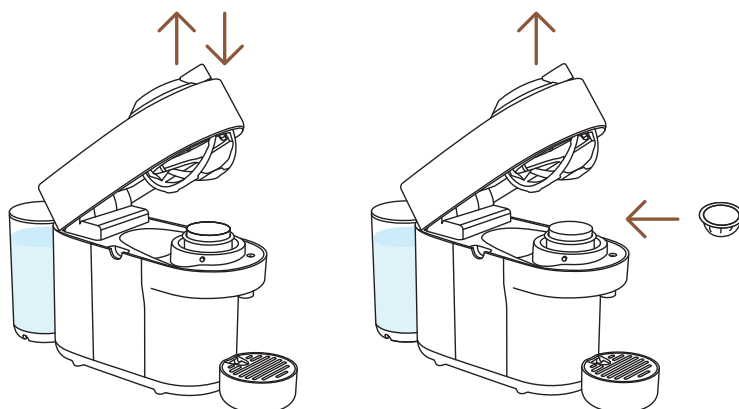

- 1** A készülék bekapcsolt állapotában nyissa ki a gépet, majd helyezze be a programozni kívánt kapszulát.

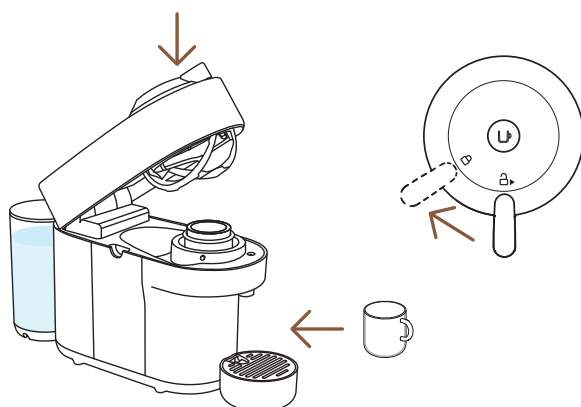

- 2** Csukja be a készülék fejét, majd a kart balra, a "lock" állásba fordítva zárja be, és helyezzen alá egy csészét.

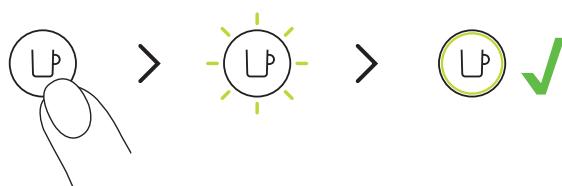

- 3** Nyomja meg, és tartsa lenyomva a gombot, majd engedje el pár másodperccel azelőtt, hogy elérné a kívánt mennyiséget. Az új vízmennyiség most be van állítva a programozás során használt kapszulatípushoz.

- i** A programozás egyedi minden kapszula típushoz. A mennyiség 20 és 535 ml között változtatható meg.

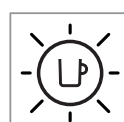
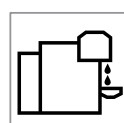
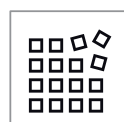
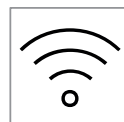

**FIGYELEM:** A készülék megfelelő használata érdekében ne nyissa fel a fejet, amíg fő a kávé, várjon amíg a kávégomb folyamatos fehér fényre vált. Ha hamarabb szeretné megállítani a főzést, nyomja meg egyszer a gombot, és várjon amíg a készülék megáll, mielőtt kinyitná a fejet.

**MEGJEGYZÉS:** Amint egy specifikus mennyiséget beprogramozott a felhasználó, minden alkalommal amikor azt a típusú kapszulát helyezik a gépbe, a főzés meg fog állni a beprogramozott mennyiségnél. Ha vissza kíván térni a gyári értékekhez, lásd: a “Gyári értékek visszaállítása” fejezetet.

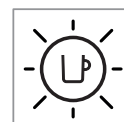
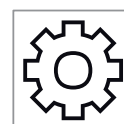
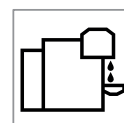
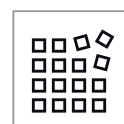
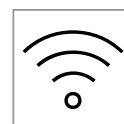

## TISZTÍTÁS

Tisztítsa meg készülékét havonta; ha kávémaradék jelenik meg a gép fejében; vagy hosszabb használaton kívüli időszak után.

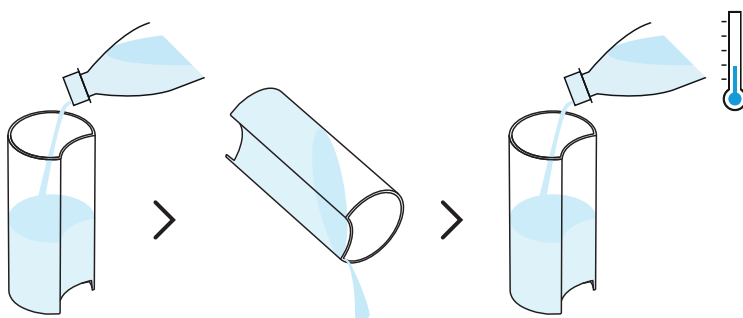

- 1** Öblítse el és tisztítsa meg a víztartályt és a tetejét, mielőtt friss ivóvízzel megtöltené.

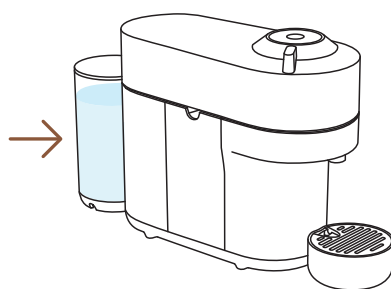

- 2** Tegye vissza a víztartályt a gépen a helyére.

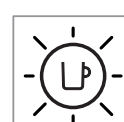
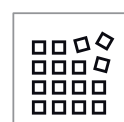
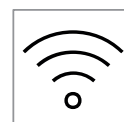

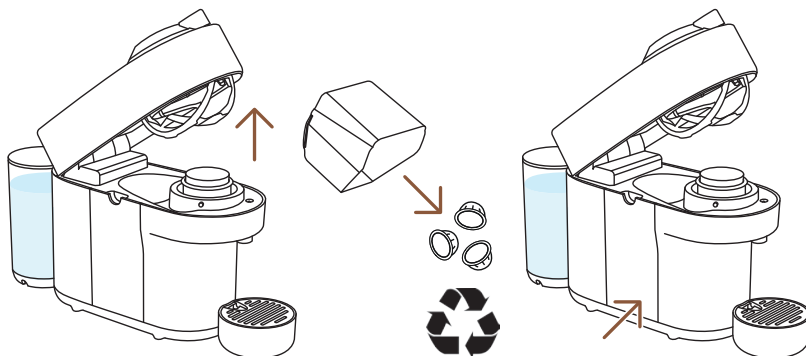

- 3** A gép bekapcsolt állapotában nyissa ki, majd fel a készüléket, és engedje, hogy a használt kapszula kilökődjön. Ürítse ki és öblítse el a kapszulatartót meg a csepptálcát, majd helyezze vissza őket a helyükre. Ne felejtse el újrahasznosítani **Nespresso** kapszuláit.\*

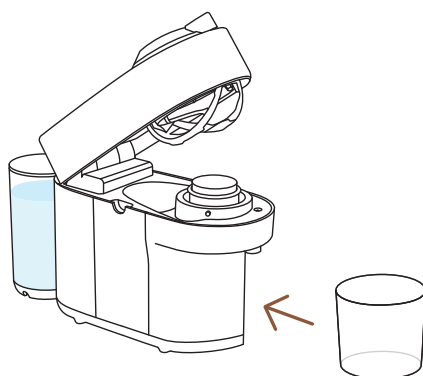

- 4** Vegye ki a csészetartót és tegyen egy üres edényt (legalább 1 L) a kávékifolyó alá.

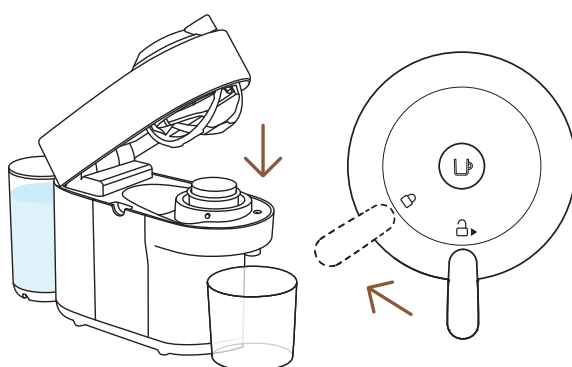

- 5** Csukja be a készülék fejét, majd fordítsa a kart balra, a "lock" állásba. Ellenőrizze, hogy ne legyen kapszula a készülékben, mielőtt elkezdené az öblítési folyamatot.

\* EZ **NESPRESSO**. ÚJRAHASZNOSÍTHATÓ. A **Nespresso** kapszulák újrahasznosításával kapcsolatos információkért látogasson el a [www.nespresso.com](http://www.nespresso.com) oldalra.

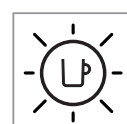
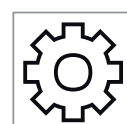
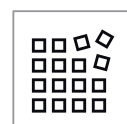
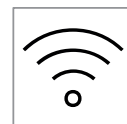

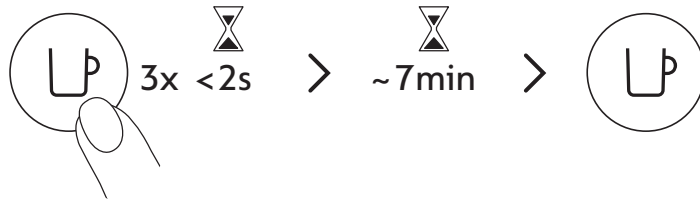

**6** Nyomja meg a gombot 3-szor 2 másodpercen belül, hogy meginduljon az öblítés. Amíg a fény narancs színnel villog, hagyja az öblítési folyamatot automatikusan lefutni.

**i** Kevesebb, mint 2 percen belül az öblítési folyamat el kell induljon, és a víz folyni kezd. A folyamat akár 7 percig is tarthat, és automatikusan megáll, amint a ciklus végetért. A folyamat bármikor leállítható a gomb ismételt lenyomásával.

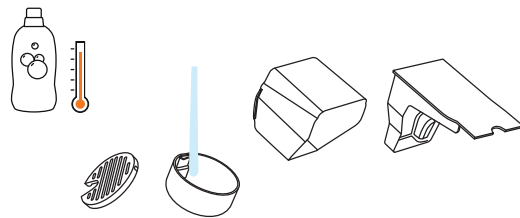

**7** Mossa el meleg vízzel és kímélő, szagtalan mosogatószerrel a kapszulakukát, a csészetartót és a csepptálcát.

**VIGYÁZAT:** Ne használjon erős vagy dörzsölő hatású tisztítószerrel vagy oldószert. Ne tegye a készüléket mosogatógépbe. Ne merítse a gépet vagy egy részét vízbe.

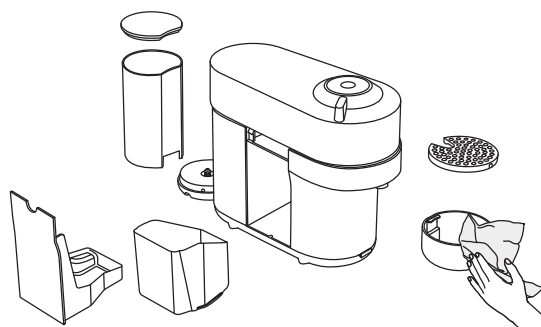

**8** Törölje meg egy tiszta, friss papírtörülkövel.

**VIGYÁZAT:** Rendszeresen törölje meg a kávékifolyót egy tiszta, nedves ruhával. A készülék tisztításhoz mindig puha ruhát használjon.

**MEGJEGYZÉS:** A készülék fejében víz gyűlhet össze. Szárítsa meg a látható részeket egy tiszta, száraz ruhával.

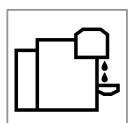

## VÍZKÖMENTESÍTÉS

Készülékének vízkömentesítése biztosítja annak megfelelő működését egész élettartama alatt azért, hogy kávézási élménye mindig épp olyan különleges legyen, mint az első alkalommal. Készüléke jelzi, ha a vízkömentesítés szükséges a gomb 3-szori narancs színű felvillanásával, mielőtt folyamatos fehérre váltana.



**i** A vízkömentesítési folyamat körülbelül 20 percet vesz igénybe, és **nem lehet megszakítani**.

**MEGJEGYZÉS:** Kérjük, olvassa el figyelmesen a vízkömentesítési utasításokat a kezdés előtt.

### A következőkre lesz szüksége:

- Egy vízkömentesítő szett, amely beszerezhető a [www.nespresso.com](http://www.nespresso.com) oldalon.
- Egy üres edényre (1 L)

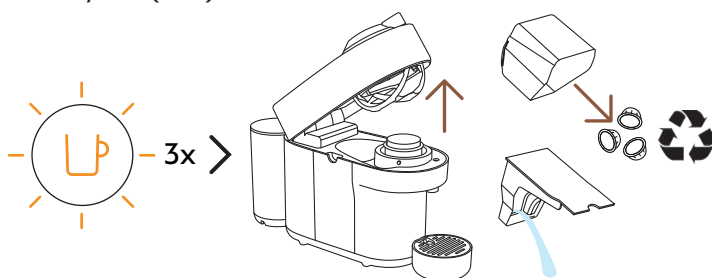

**1** Amikor a gomb 3-szor narancs színnel villog. Nyissa ki, majd fel a gép fejét, és engedje leesni a használt kapszulát. Ürítse ki a kapszulatartót és a csepptálcát, majd helyezze vissza őket a helyükre. Ne felejtse el újrahasznosítani **Nespresso** kapszuláit.\*

\* EZ **NESPRESSO**. ÚJRAHASZNOSÍTHATÓ. A **Nespresso** kapszulák újrahasznosításával kapcsolatos információkért látogasson el a [www.nespresso.com](http://www.nespresso.com) oldalra.

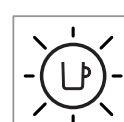
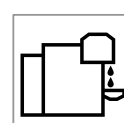
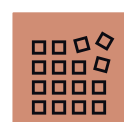
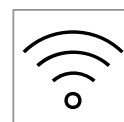

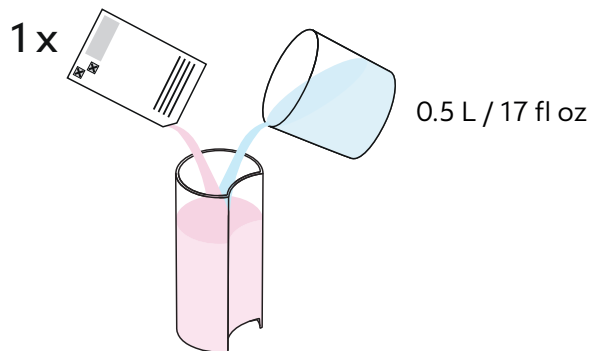

- 2** Töltse meg a víztartályt 0,5 liter vízzel, és adjon hozzá 1 adag **Nespresso** vízkőmentesítő folyadékot.

**VIGYÁZAT:** Figyeljen, mert a vízkőmentesítő folyadék ártalmas lehet. Kerülje a szembe, bőrre vagy felületekre kerülését.

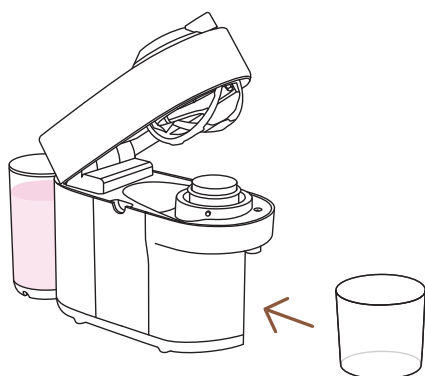

- 3** Vegye ki a csészetartót, és tegyen egy üres edényt (legalább 1 L) a kávékifolyó alá.

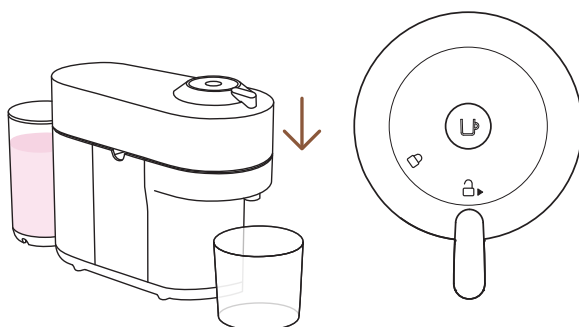

- 4** A gép bekapcsolt állapotában csukja be a készülék fejét, és hagyja a kart az "unlock" pozícióban.

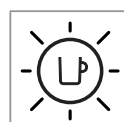
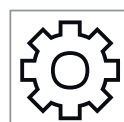
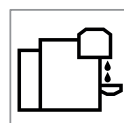
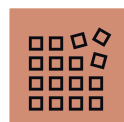
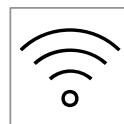

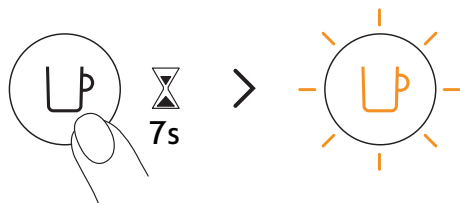

- 5** Tartsa lenyomva a gombot 7 másodpercig, vagy amíg azt nem látja, hogy a fény kikapcsol. A gomb narancs színnel elkezd gyorsan villogni.

**VIGYÁZAT:** Most 45 másodperce van, hogy belépjen a vízkőmentesítő üzemmódba, ellenkező esetben a gép visszatér a kávéfőző üzemmódba.

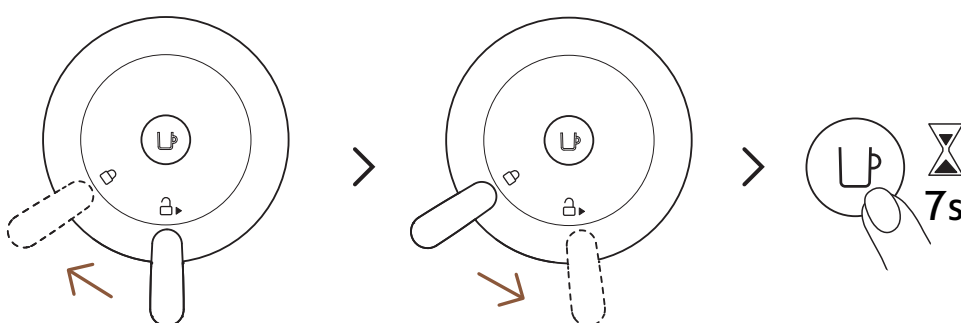

- 6** Zárja be a gép fejét a kar balra, a "lock" jelig történő elfordításával, majd nyissa ki a kart jobbra, az "unlock" állásig fordítva azt. Nyomja le a gombot megint körülbelül 7 másodpercig, vagy amíg a fény kikapcsol. A gomb elkezd gyorsan, narancs színnel villogni.

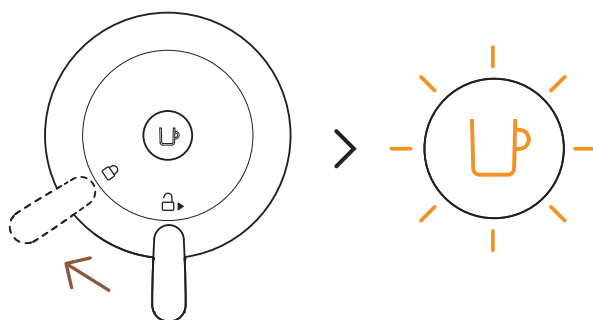

- 7** A vízkőmentesítő módba való belépéshez zárja be a gépet a kar balra, a "lock" állásig történő elfordításával. A fénynek még gyorsan, narancs színnel kell villognia. Ez mutatja, hogy belépett a vízkőmentesítő üzemmódba.

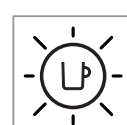
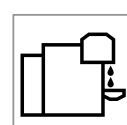
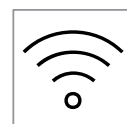



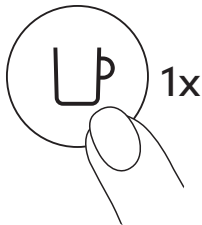

- 8** Nyomja meg a kávégombot egyszer a vízkőmentesítő folyamat elkezdéséhez. A fény folyamatosan, narancs színnel fog villogni a folyamat alatt.

- i** A gép automatikusan megáll, amint a vízkőmentesítés első fázisa befejeződött.

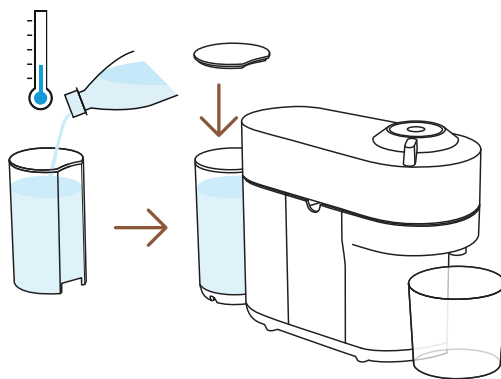

- 9** A vízkőmentesítési folyamat végén szükséges a gép öblítése. Alaposan öblítse el a víztartályt és a csepptálcát. Töltse meg a víztartályt friss ivóvízzel, és tegye vissza a helyére. Ürítse ki az edényt, majd tegye vissza a kávékifolyó alá.

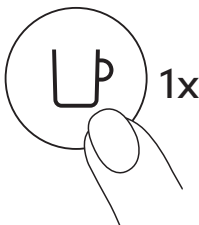

- 10** Nyomja meg a gombot a gép öblítéséhez. Amikor a gomb már nem villog gyorsan, hanem folyamatosan világít, a vízkőmentesítő folyamat készen van.

- i** A készülék automatikusan megáll, amint a folyamat kész.

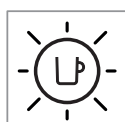
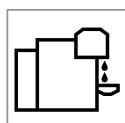
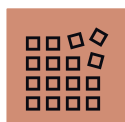
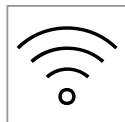

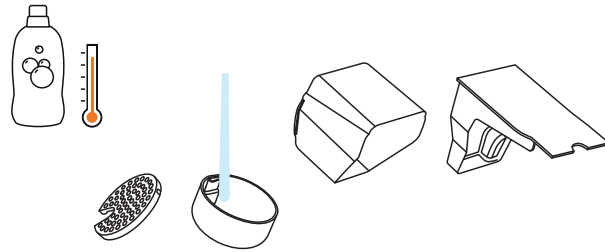

- 11** Mossa el forró vízzel és kímélő, szagtalan mosogatószerrel a kapszulakukát, a csészetartót és a csepptálcát.

**VIGYÁZAT:** Ne használjon erős vagy dörzsölő hatású tisztítószer vagy oldószert. Ne tegye a készüléket mosogatógépbe. Ne merítse a gépet vagy egy részét vízbe.

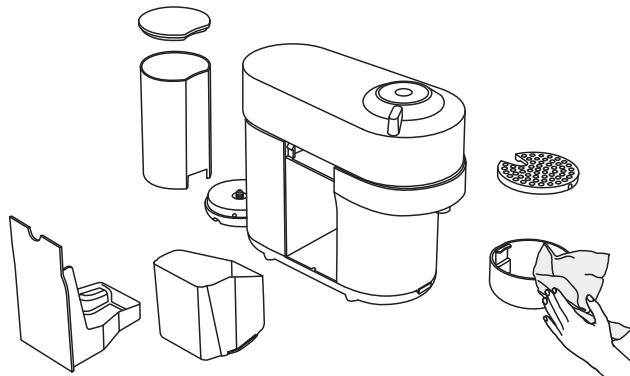

- 12** Szárítsa meg a készüléket egy tiszta papírtörülővel. Hagyja a készüléket száradni 10 percig, mielőtt újra használná.

**MEGJEGYZÉS:** A tisztítás során víz gyűlhet fel a gép fejében. Ha ez történik, szárítsa meg a látható részeket egy tiszta, száraz ruhával.

**MEGJEGYZÉS:** a készülék csak akkor tud vízkőmentesítő üzemmódba lépni, ha már legalább 30 kávét lefőztek rajta.

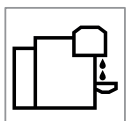
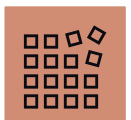

## A RENDSZER ÜRÍTÉSE

A rendszer ürítését egy hosszabb használaton-kívüli időszak előtt, fagyásvédelemhez, vagy szervizbe küldés előtt kell elvégezni.

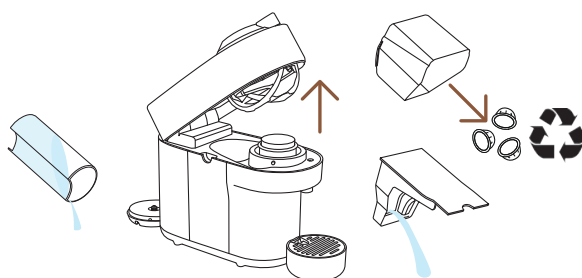

- 1 Ürítse ki a víztartályt, nyissa ki a gép fejét, és hagyja, hogy a használt kapszula kilökődjön. Ürítse ki a kapszulakukát és a csepptálcát. Ne felejtse el újrahasznosítani **Nespresso** kapszuláit.\*

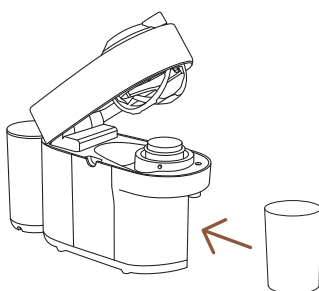

- 2 Tegye vissza őket a helyükre a készülékre, vegye ki a csészetartót, és tegyen egy üres edényt (0.5 L) a kávékifolyó alá.

\* EZ **NESPRESSO**. ÚJRAHASZNOSÍTHATÓ. A **Nespresso** kapszulák újrahasznosításával kapcsolatos információkért látogasson el a [www.nespresso.com](http://www.nespresso.com) oldalra.

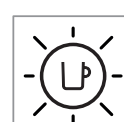
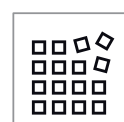
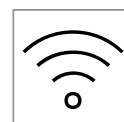

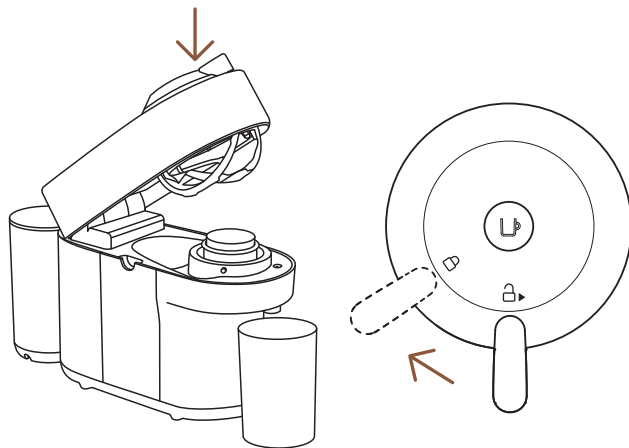

- 3** Miközben a gép be van dugva, és be van kapcsolva, fordítsa a kart a "lock" állás felé.

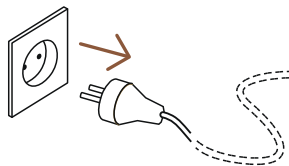

- 4** Húzza ki a gépet.

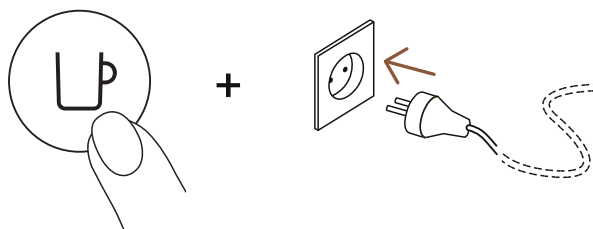

- 5** Tartsa lenyomva a gombot, amíg áram alá helyezi a készüléket.

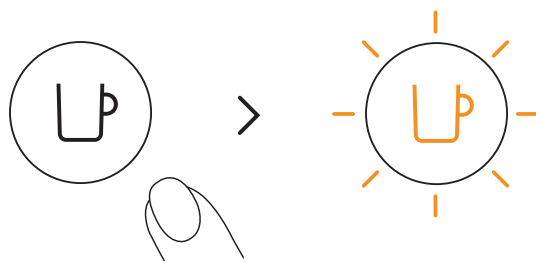

- 6** Engedje el a gombot. Narancs színnel fog villogni, és az ürítési folyamat elkezdődik.

- i** Körülbelül 30 másodpercig tart a gépnek, hogy befejezze az ürítési folyamatot. A gép automatikusan kikapcsol, amint kiürült.

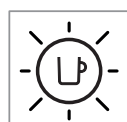
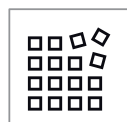
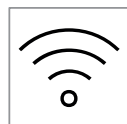

## A GYÁRI ÉRTÉKEK VISSZAÁLLÍTÁSA

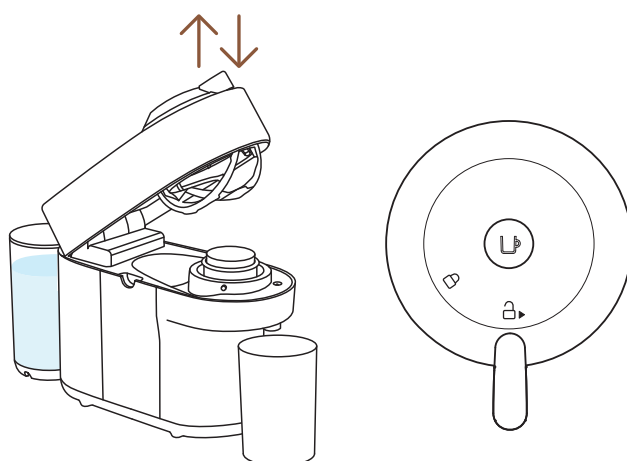

- 1** Miközben a gép be van dugva, nyissa ki, majd csukja be a gép fejét, majd hagyja a kart az "**unlock**" állásban.

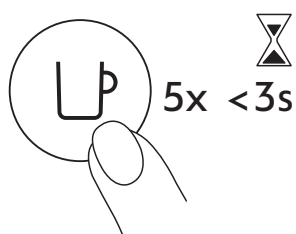

- 2** Nyomja meg a gombot 3 másodperc alatt 5-ször. A készülék most a gyári alapbeállításokra van programozva.

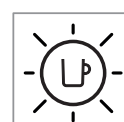
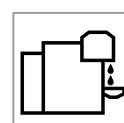
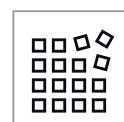
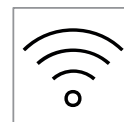

## ÁLLAPOTJELZÉSEK

Szeretne többet megtudni a Vertuo Pop fényjelzéseiről?  
Kérjük, nézze meg a következő videót:

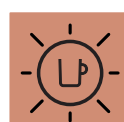
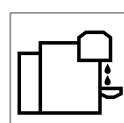
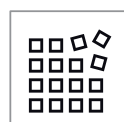
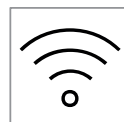

## HIBAELHÁRÍTÁS

- A gomb nem világít**
- A készülék automatikusan kikapcsolt; nyomja meg a gombot, vagy “nyissa ki” a készüléket
  - Ellenőrizze a tápellátást, csatlakozót, feszültséget és a biztosítékot.
- Nincs kávé, nincs víz.**
- Ellenőrizze, hogy a víztartály fel van-e töltve.
  - Ellenőrizze, hogy van-e új kapszula a megfelelő helyen, és hogy a kar le van-e zárva, majd nyomja meg a gombot az indításhoz.
  - Vízkőmentesítsen, ha szükséges
  - Nyissa ki a készüléket, és engedje leesni a kapszulát. Végezze el a tisztítást a “tisztítás” fejezet alapján.
- A kávé nem elég meleg.**
- Melegítse elő a csészét forró ivóvízzel.
  - Vízkőmentesítsen, ha szükséges
- Szivárgás vagy szokatlan kávéfolyás.**
- Ellenőrizze, hogy a víztartály pontosan a helyén van-e.
  - Vízkőmentesítsen, ha szükséges
- A készülék kikapcsolt.**
- Azért, hogy energiát takarítson meg, a használatonkívüliség.
  - A készüléket ki lehet kapcsolni manuálisan bármikor (amikor épp nem főz) a gomb 3 másodpercig történő nyomvatartásával.
- Zacc a csészében**
- Végezze el a tisztítási procedúrát kétszer.
  - Lásd a **“tisztítás”** bekezdésben.
- A készülék nem indul el, és folyamatosan világít a gomb. Ha villog, lásd a következő pontokban.**
- Ellenőrizze, hogy a kar megfelelően le van-e zárva.
  - Ha Coffee-t vagy Espresso-t főzne, ellenőrizze, hogy van-e új kapszula a megfelelő helyen, és hogy a kar le van-e zárva, majd nyomja meg a gombot az indításhoz.
  - Ha tisztítaná, vízkőmentesítené vagy ürítené a rendszert, ellenőrizze, hogy nincs-e kapszula behelyezve, majd csukja és zárja le a gépet, és nyomja meg a gombot a funkció elindításához.



**A készülék nem indul el, és a gomb váltakozva villog; egy villogás, egy szünet.**

**A gomb villog, miközben a készülék működik.**

**A készülék nem indul el, és a gomb váltakozva villog; egy villogás, egy szünet.**

- Töltse fel a víztartályt, és nyomja meg a gombot az elindításhoz.
- Ellenőrizze, hogy a kar megfelelően le van-e zárva.
- Ha a kávé a megszokott módon jön, akkor ez azt mutatja, hogy a gép jól működik.
- Ha csak víz folyik ki, akkor a készülék egy felhasználói utasítást hajt végre (tisztítás, vízkőmentesítés vagy a rendszer ürítése). Olvassa el az idevonatkozó fejezetet.
- Kapcsolja ki a gépet a gomb 3 másodpercig tartó nyomva tartásával, majd nyomja meg újból, hogy a gép visszakapcsoljon. Várjon körülbelül 20 másodpercet, hogy a gép lehűlhessen az intenzívebb használat után.
- Némi időbe telhet, amíg a kávé elkezd kifolyni (a vonalkódbeolvasás és a kávé előnedvesítése miatt).
- Ellenőrizze, hogy van-e új kapszula a megfelelő helyen és hogy a kar le van-e zárva, majd nyomja meg a gombot az indításhoz.
- Töltse fel a víztartályt, és nyomja meg a gombot az elindításhoz.
- Kapcsolja ki a gépet a gomb 3 másodpercig tartó nyomva tartásával, majd nyomja meg újból, hogy a gép visszakapcsoljon. Várjon körülbelül 20 másodpercet, hogy a gép lehűlhessen az intenzívebb használat után.

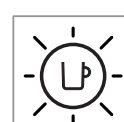
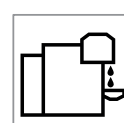
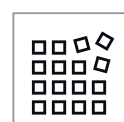
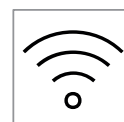



**A gomb folyamatosan felváltva villog (2 villogás, egy szünet), és a gép nem működik.**

- Normál kávéfőzés közben:
  - 1) Nyissa fel a kart, és nyissa ki a gépet, hogy ellenőrizze, új, sértetlen kapszula van-e a megfelelő helyen.
  - 2) Ellenőrizze, hogy a kar a lezárt pozícióban van-e.
  - 3) Ellenőrizze, hogy a víztartály fel van-e töltve.
- Vízkőmentesítés, ürítés vagy tisztítás közben:
  - 1) Ellenőrizze, nincs-e bent kapszula.
  - 2) Ellenőrizze, hogy a kar a lezárt pozícióban van-e.
- A mennyiségek programozása közben:
  - 1) Ellenőrizze, hogy a kapszula a helyén van-e.
  - 2) Olvassa el az idevonatkozó fejezetet.
- Ha a probléma továbbra is fennáll:
  - 1) Nyissa ki a kart és a készülék főzőfejét.
  - 2) Cserélje ki a kapszulát, ha szükséges.
  - 3) Válassza le a gépet a hálózatról, majd dugja vissza 10 másodperc múlva.
  - 4) Csukja be a főzőfejét, majd nyomja meg a gombot a bekapcsoláshoz, majd nyomja meg még egyszer az elindításhoz.

Ha a probléma továbbra is fennáll, hívja a **Nespresso-t**.

**A gomb felváltva villog háromszor, majd folyamatos fény.**

- Vízkőmentesítés szükséges: a jelzés megjelenése után a készülékkel még pár kávé főzhető, mielőtt a vízkőmentesítés szükségessé válna.

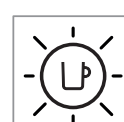
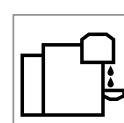
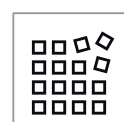
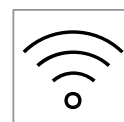

## MŰSZAKI ADATOK

<b>Teljesítmény</b>	<b>~220–240 V, 50–60 Hz, 1300–1500 W</b> <b>US, CA:</b> 120 V, 60 Hz, 1500 W <b>MX:</b> 127 V~, 60 Hz, 1380 W
<b>Frekvencia</b>	2.402–2.480 GHz
<b>RF kimeneti teljesítmény (EIRP)</b>	Bluetooth 4 dBm Max. e.i.r.p. és Wi-Fi <20 dMm max. e.i.r.p.
<b>Készenléti idő</b>	0.39 W/h
<b>Energiatakarékos mód</b>	Automatikus kikapcsolás: 2 perc
<b>Felfűtési idő</b>	30 másodperc (csukott és zárt fej)
<b>Mozgatható csészetartó a nagyobb receptekhez</b>	Eltávolítható egyes állás
<b>Készülék kimenetétől számított kábelhossz</b>	75 cm / 30 in
<b>Méretek (sz x mé x ma)</b>	13.6 x 42.6 x 25 cm / 5.3 x 16.7 x 9.8 in
<b>Tömeg</b>	3.5 kg / 7.72 lbs
<b>Víztartály úrtartalma</b>	0.6 l / 20 fl oz
<b>Kapszulakuka kapacitása</b>	8 espresso vagy 5 mug kapszula

## TÍPUSKÓDOK

<b>Nespresso</b>	<b>Breville</b>	<b>Delonghi</b>
GCV2, GDV2	BNV120, BNV150	ENV90
<b>Krups</b>	<b>Magimix</b>	
XN9201, XN9204, XN9205, XN9211	M800	

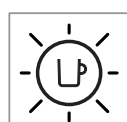
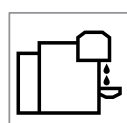
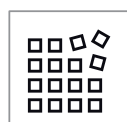
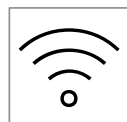

# ΠΑΤΗΣΤΕ ΚΑΙ ΕΠΙΛΕΞΤΕ ΓΛΩΣΣΑ

EL



**ΑΣΦΑΛΕΙΑ**



**ΣΥΝΟΨΗ**



**ΣΥΝΔΕΣΙΜΟΤΗΤΑ**



**ΠΡΩΤΑ ΒΗΜΑΤΑ**



**ΠΑΡΑΣΚΕΥΗ ΚΑΦΕ**



**ΠΡΟΣΑΡΜΟΣΤΕ ΤΗΝ ΠΟΣΟΤΗΤΑ ΤΟΥ  
ΚΑΦΕ ΣΑΣ**



**ΚΑΘΑΡΙΣΜΟΣ**



**ΑΦΑΛΑΤΩΣΗ**



**ΕΚΚΕΝΩΣΗ ΣΥΣΤΗΜΑΤΟΣ**



**ΕΠΑΝΑΦΟΡΑ ΕΡΓΟΣΤΑΣΙΑΚΩΝ  
ΡΥΘΜΙΣΕΩΝ**



**ΣΥΝΟΨΗ ΦΩΤΕΙΝΩΝ ΕΝΔΕΙΞΕΩΝ**



**ΑΝΤΙΜΕΤΩΠΙΣΗ ΠΡΟΒΛΗΜΑΤΩΝ**



**ΤΕΧΝΙΚΑ ΧΑΡΑΚΤΗΡΙΣΤΙΚΑ**

## ΑΣΦΑΛΕΙΑ

**ΠΡΟΣΟΧΗ:** Πριν χρησιμοποιήσετε τη μηχανή, διαβάστε το φυλλάδιο με τις οδηγίες ασφαλείας για να αποφύγετε τον κίνδυνο τραυματισμού ή βλάβης.

### ΔΙΑΘΕΣΗ ΑΠΟΡΡΙΜΜΑΤΩΝ ΚΑΙ ΠΡΟΣΤΑΣΙΑ ΤΟΥ ΠΕΡΙΒΑΛΛΟΝΤΟΣ

Αυτή η συσκευή συμμορφώνεται με την ευρωπαϊκή Οδηγία 2012/19/ΕΚ. Η συσκευή και η συσκευασία της περιέχουν ανακυκλώσιμα υλικά. Η συσκευή περιέχει πολύτιμα υλικά που μπορούν να ανακτηθούν ή να ανακυκλωθούν. Ο διαχωρισμός των υπόλοιπων άχρηστων υλικών σε διαφορετικούς τύπους διευκολύνει την ανακύκλωση των πολύτιμων πρώτων υλών. Παραδώστε τη συσκευή σε ένα σημείο συλλογής. Μπορείτε να βρείτε πληροφορίες για τη διάθεση των απορριμμάτων από τους τοπικούς φορείς.

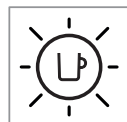
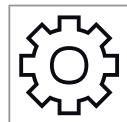
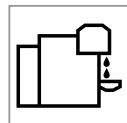
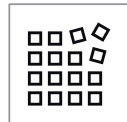
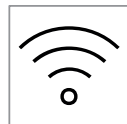

## ΣΥΝΟΨΗ

## ΕΠΙΣΚΟΠΗΣΗ ΜΗΧΑΝΗΣ

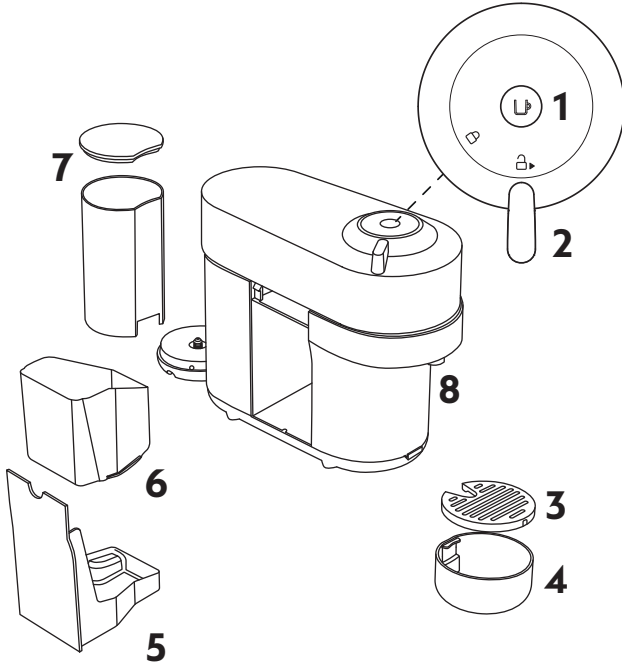

- 1 Κουμπί ενεργοποίησης/ απενεργοποίησης και καφέ
- 2 Μοχλός ασφάλισης/ απασφάλισης
- 3 Σχάρα αποστράγγισης
- 4 Ρυθμιζόμενη υποστήριξη κούπας
- 5 Δίσκος αποστράγγισης
- 6 Δοχείο χρησιμοποιημένων καψουλών
- 7 Δοχείο νερού και καπάκι
- 8 Στόμιο εκροής καφέ

## ΠΕΡΙΧΟΜΕΝΑ ΣΥΣΚΕΥΑΣΙΑΣ



- 1 Μηχανή
- 2 Συσκευασία με κάψουλες **Nespresso**
- 3 Υλικό καλωσορίσματος **Nespresso**
- 4 Οδηγίες ασφαλείας
- 5 Εγχειρίδιο χρήστη
- 6 Εγγύηση

**i Αποσύνδεση:** ενδέχεται να υπάρχει σκόνη στην επιφάνεια της μηχανής λόγω των ανακυκλωμένων υλικών που χρησιμοποιούνται για τη συσκευασία. Αυτό δεν είναι επικίνδυνο, απλά καθαρίστε τη με ένα μαλακό πανί

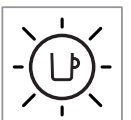
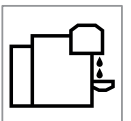
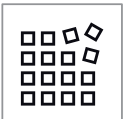
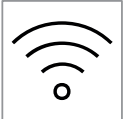

## ΑΝΟΙΓΜΑ/ΚΛΕΙΣΙΜΟ

## ΑΝΟΙΓΜΑ

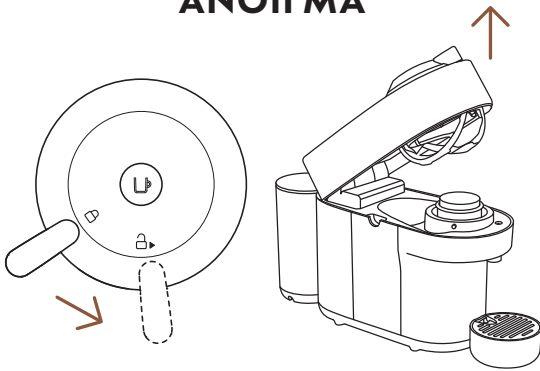

## ΚΛΕΙΣΙΜΟ

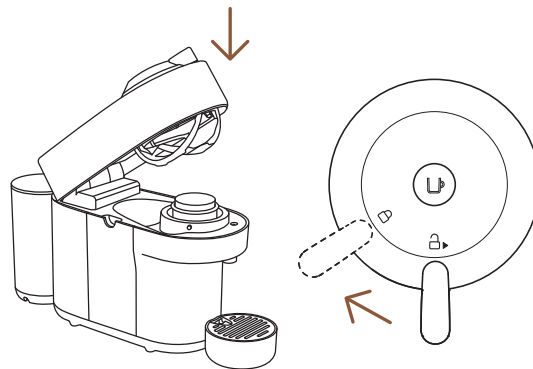

**ΠΡΟΣΟΧΗ:** για να χρησιμοποιήσετε τη μηχανή σωστά, μην ανοίξετε την κεφαλή της μηχανής κατά την παρασκευή καφέ, περιμένετε μέχρι να ανάψει συνεχόμενα λευκό το κουμπί του καφέ. Εάν θέλετε να σταματήσετε την παρασκευή καφέ νωρίτερα, πατήστε το κουμπί καφέ μία φορά και περιμένετε μέχρι να σταματήσει η μηχανή πριν ανοίξετε την κεφαλή.

## ΤΟ ΣΥΣΤΗΜΑ VERTUO

## ΣΥΜΒΑΤΟΤΗΤΑ ΚΑΨΟΥΛΑΣ



S

**Ristretto**  
(25 ml)

**Espresso**  
(40 ml)



M

**Διπλός Espresso**  
(80 ml)

**Gran Lungo**  
(150 ml)



L

**Mug**  
(230 ml)

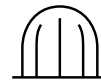

XL

**Alto, Cold Brew Style**  
(355 ml)

**Carafe**  
(535 ml)

## ΣΥΜΒΑΤΟΤΗΤΑ ΑΞΕΣΟΥΑΡ



Συμβατότητα  
αξεσουάρ



Ristretto



Espresso



Διπλός  
Espresso



Gran  
Lungo



Mug (S)



Mug (M)



Reveal  
Glass



Μη συμβατά  
αξεσουάρ



Mug (L)



Carafe

Ανακαλύψτε την πλήρη γκάμα των αξεσουάρ μας στο  
[www.nespresso.com](http://www.nespresso.com)

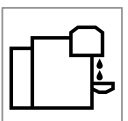

## ΕΝΕΡΓΟΠΟΙΗΣΗ/ΑΠΕΝΕΡΓΟΠΟΙΗΣΗ

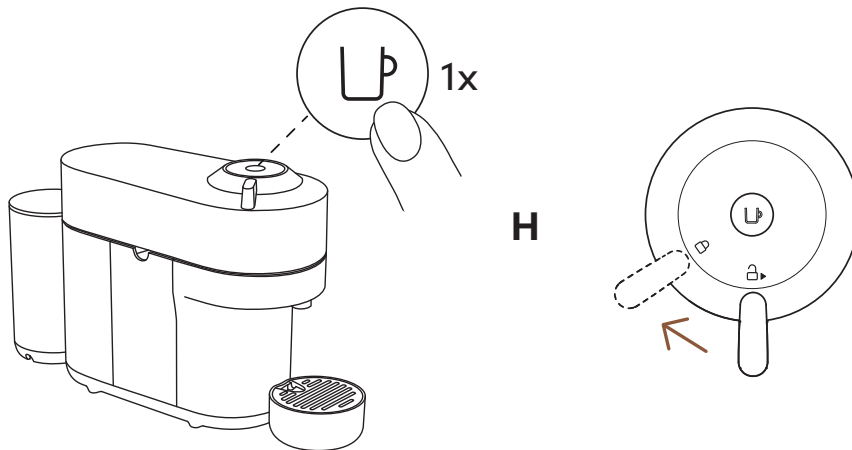

### ΕΝΕΡΓΟΠΟΙΗΣΗ

Μόλις συνδεθεί η συσκευή στο ρεύμα, ενεργοποιήστε την πατώντας το κουμπί μία φορά ή κλειδώνοντας το μοχλό (με την κεφαλή κλειστή).

- i** Η ένδειξη led θα αναβοσβήσει για περίπου 30 δευτερόλεπτα ενώ η μηχανή προθερμαίνεται. Όταν η ένδειξη παραμείνει σταθερή, η μηχανή είναι έτοιμη για χρήση.

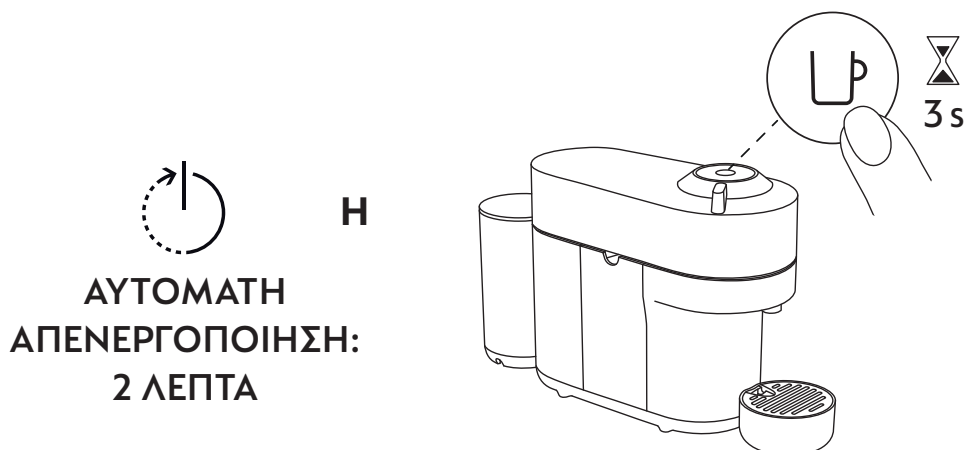

**ΑΥΤΟΜΑΤΗ  
ΑΠΕΝΕΡΓΟΠΟΙΗΣΗ:  
2 ΛΕΠΤΑ**

### ΑΠΕΝΕΡΓΟΠΟΙΗΣΗ

Για λόγους εξοικονόμησης ενέργειας, η μηχανή απενεργοποιείται αυτόματα αν δεν χρησιμοποιηθεί για 2 λεπτά.

- i** Η μηχανή μπορεί να απενεργοποιηθεί χειροκίνητα ανά πάσα στιγμή (όταν δεν χρησιμοποιείται), πατώντας παρατεταμένα το κουμπί για 3 δευτερόλεπτα.



## ΣΥΝΔΕΣΙΜΟΤΗΤΑ

### ΓΙΑΤΙ ΠΡΕΠΕΙ ΝΑ ΣΥΝΔΕΣΕΤΕ ΤΗ VERTUO POP ΜΗΧΑΝΗ ΣΑΣ



### ΟΦΕΛΗ ΣΥΝΔΕΣΙΜΟΤΗΤΑΣ ΤΗΣ VERTUO POP ΜΗΧΑΝΗΣ ΣΑΣ

- **"Εξυπνος" καφές:** Να είστε πάντα ένα βήμα μπροστά και να λαμβάνετε τις τελευταίες καινοτομίες καφέ **Nespresso** ενημερώνοντας και διατηρώντας την μηχανή σας σε άριστη κατάσταση.
- **συμβουλή ειδικού:** Λάβετε υποστήριξη και κατεβάστε εκπαιδευτικά βίντεο στο smartphone σας για να σας συνοδεύσουν στο ταξίδι του καφέ σας.
- **φροντίδα μηχανής:** Λάβετε άμεση ειδοποίηση για το πώς και πότε χρειάζεται συντήρηση η μηχανή σας με έναν εύκολο οδηγό για αφαλάτωση, ξέπλυμα, καθαρισμό κ.λπ.

### ΠΩΣ ΝΑ ΣΥΝΔΕΣΕΤΕ ΤΗΝ ΚΑΦΕΤΙΕΡΑ VERTUO POP;

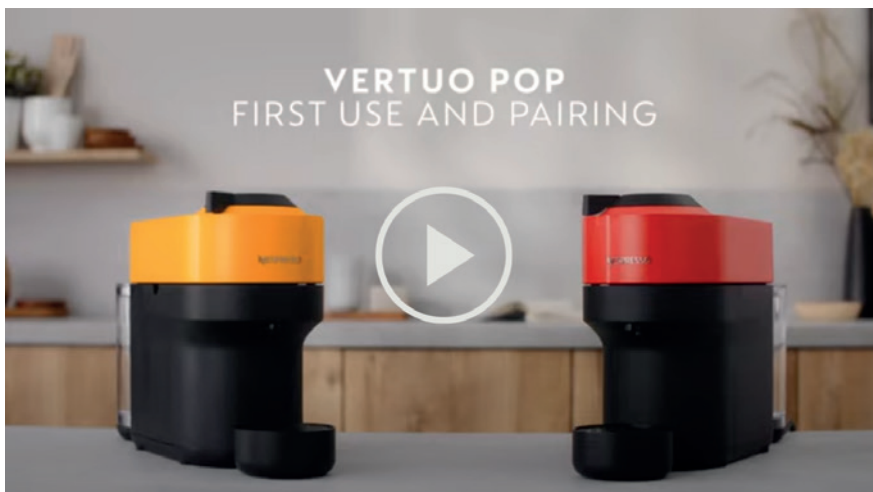



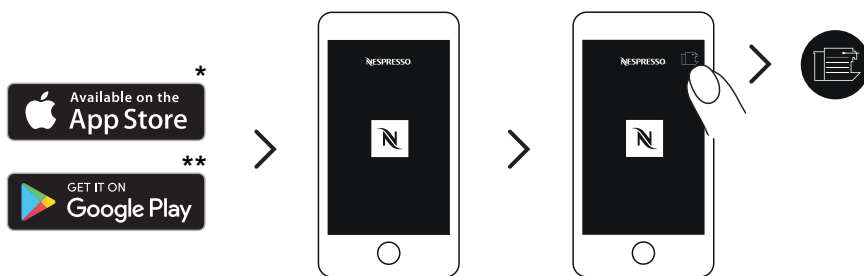

- 1** Κατεβάστε ή ενημερώστε την εφαρμογή **Nespresso**. Εκκινήστε την εφαρμογή **Nespresso** στο smartphone ή το tablet σας. Πατήστε το εικονίδιο της μηχανής στην επάνω δεξιά γωνία της οθόνης.

**ΣΗΜΕΙΩΣΗ:** Για βέλτιστη απόδοση και απρόσκοπτη εμπειρία, συνιστούμε να συνδέσετε τη μηχανή σε δίκτυο Wi-Fi αντί να χρησιμοποιήσετε ένα hotspot smartphone.

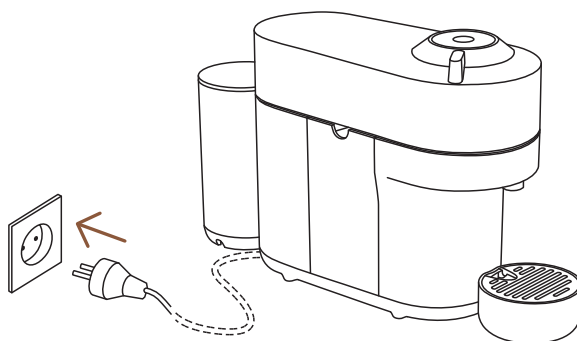

- 2** Συνδέστε το καλώδιο ρεύματος.



- 3** Ακολουθήστε τις οδηγίες που εμφανίζονται στην εφαρμογή **Nespresso**.

**ΠΡΟΣΟΧΗ:** Διαβάστε πρώτα τις οδηγίες ασφαλείας για να αποφύγετε κίνδυνο ηλεκτροπληξίας και πυρκαγιάς. Βεβαιωθείτε ότι η πρίζα είναι γειωμένη.

- \* Το App Store® είναι εμπορικό σήμα της Apple Inc., κατοχυρωμένο στις ΗΠΑ και σε άλλες χώρες.  
 \*\* Το Google Play και το Google Play logo είναι εμπορικά σήματα της Google LLC.

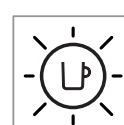
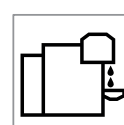
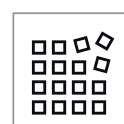

## ΑΠΕΝΕΡΓΟΠΟΙΩΝΤΑΣ ΤΗ ΜΟΝΑΔΑ ΣΥΝΔΕΣΙΜΟΤΗΤΑΣ ΤΗΣ ΜΗΧΑΝΗΣ

Η μηχανή διαθέτει μια μονάδα συνδεσιμότητας, ενεργοποιημένη από προεπιλογή. Δίνει πρόσβαση σε επιπλέον λειτουργίες, βελτιώνοντας περαιτέρω την εμπειρία του καφέ. Για να απενεργοποιήσετε τη μονάδα συνδεσιμότητας, ακολουθήστε τα εξής βήματα:

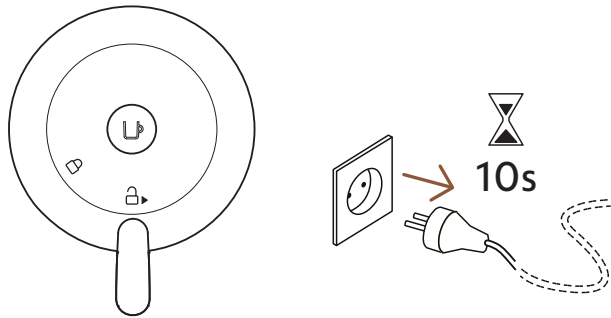

- 1 Με τη μηχανή κλειστή και το μοχλό σε **θέση** ξεκλειδώματος, αποσυνδέστε τη μηχανή από την πρίζα για τουλάχιστον 10 δευτερόλεπτα.

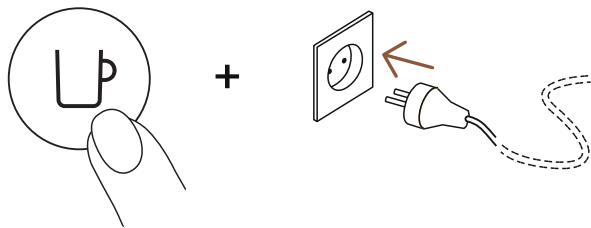

- 2 Πατήστε και κρατήστε πατημένο το κουμπί ενώ συνδέεστε. Το κουμπί θα αναβοσβήσει πορτοκαλί για να επιβεβαιώσει ότι η μονάδα συνδεσιμότητας έχει απενεργοποιηθεί.
- i** Ακολουθήστε τα ίδια βήματα για να ενεργοποιήσετε ξανά τη μονάδα συνδεσιμότητας. Το κουμπί θα αρχίσει να αναβοσβήνει λευκό, επιβεβαιώνοντας την επανενεργοποίηση της μονάδας.

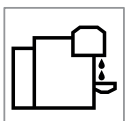
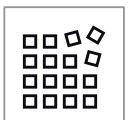

## ΠΡΩΤΑ ΒΗΜΑΤΑ

### ΠΡΩΤΟ ΞΕΠΛΥΜΑ

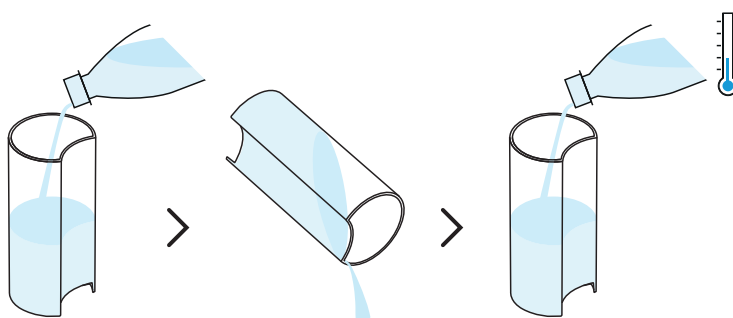

- 1** Ξεπλύνετε το δοχείο νερού και το καπάκι του δοχείου νερού με καθαρό νερό πριν το γεμίσετε με πόσιμο νερό για πρώτη φορά.

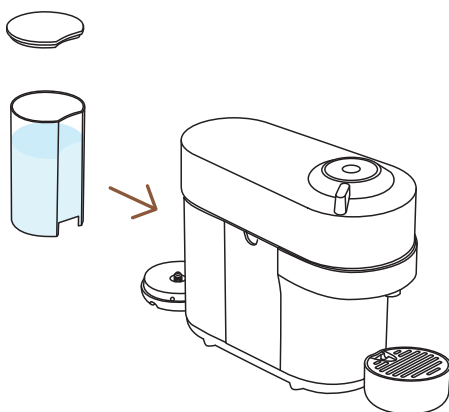

- 2** Κλείστε το δοχείο νερού με το καπάκι και τοποθετήστε το ξανά στη θέση του, φροντίζοντας να είναι καλά στερεωμένο.

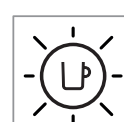
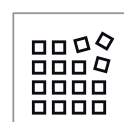
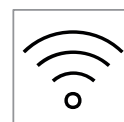

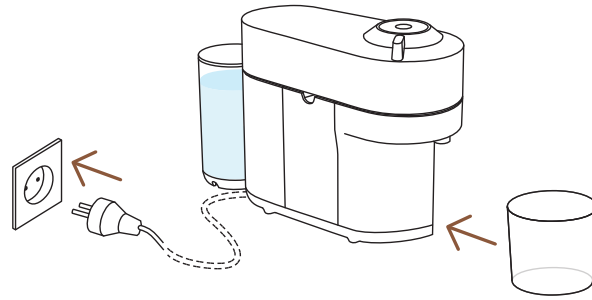

- 3** Με το καλώδιο τροφοδοσίας συνδεδεμένο στην πρίζα, αφαιρέστε τη βάση υποστήριξης της κούπας και τοποθετήστε ένα άδειο δοχείο (τουλάχιστον 1 λίτρο) κάτω από το στόμιο εκροής καφέ.

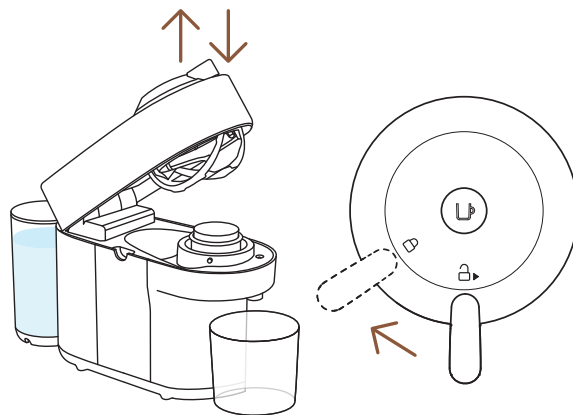

- 4** Ανοίξτε και κλείστε τη συσκευή. Βεβαιωθείτε ότι ο μοχλός βρίσκεται στην κλειστή θέση.

- i** Το φως θα αναβοσβήνει ενώ η συσκευή θερμαίνεται. Θα χρειαστούν περίπου 30 δευτερόλεπτα. Όταν το φως ανάψει σταθερά, η συσκευή είναι έτοιμη για λειτουργία. Βεβαιωθείτε ότι δεν έχει τοποθετηθεί κάψουλα.

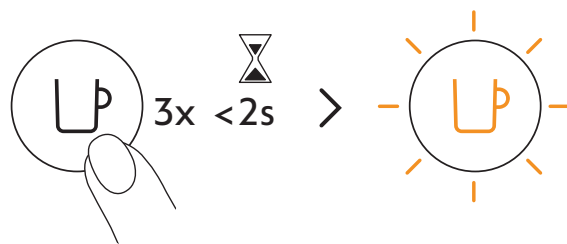

- 5** Πατήστε το κουμπί 3 φορές μέσα σε 2 δευτερόλεπτα για να ξεκινήσει το ξέπλυμα. Με την ενδεικτική λυχνία να αναβοσβήνει πορτοκαλί, αφήστε τη διαδικασία ξεβγάλματος να ολοκληρωθεί αυτόματα. Μόλις το φως γίνει σταθερό λευκό, η διαδικασία έχει ολοκληρωθεί.

- i** Θα χρειαστούν λιγότερο από 2 λεπτά για να ξεκινήσει η διαδικασία ξεβγάλματος και να αρχίσει να ρέει το νερό. Αυτή η διαδικασία μπορεί να διαρκέσει έως και 7 λεπτά.

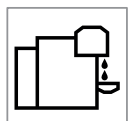

## ΠΑΡΑΣΚΕΥΗ ΚΑΦΕ

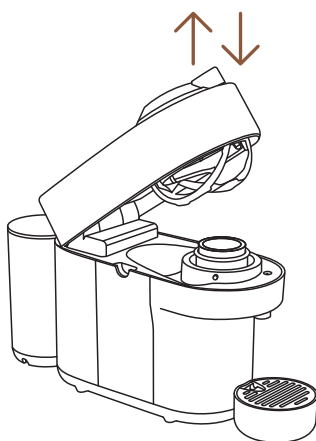

**1** Ανοίξτε και κλείστε τη συσκευή.

**i** Η λυχνία στο κουμπί καφέ αναβοσβήνει ενώ η συσκευή θερμαίνεται. Όταν το φως παραμείνει σταθερό, η μηχανή είναι έτοιμη για χρήση.

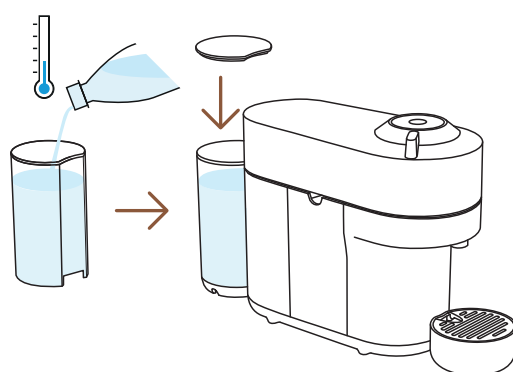

**2** Γεμίστε τη δεξαμενή νερού με φρέσκο πόσιμο νερό και τοποθετήστε την ξανά στη θέση της.

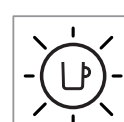
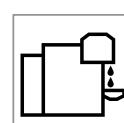
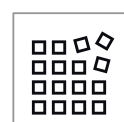
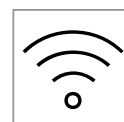

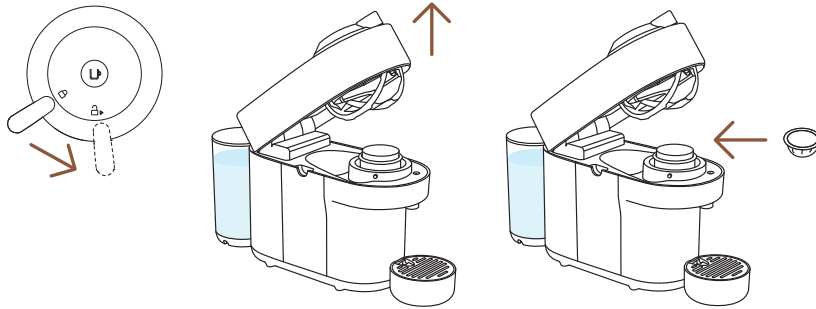

- 3** Ξεκλειδώστε και ανοίξτε τελείως την κεφαλή της μηχανής και τοποθετήστε μια κάψουλα Vertuo με την κυρτή πλευρά προς τα κάτω.

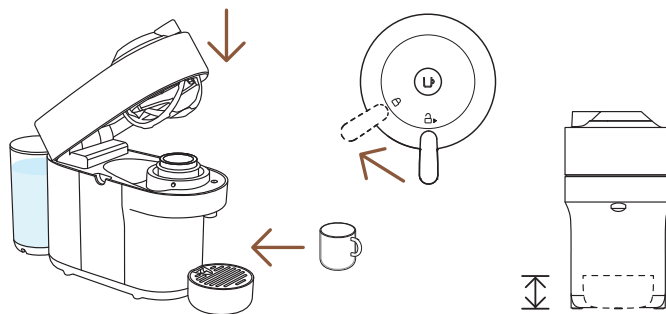

- 4** Κλείστε την κεφαλή της μηχανής και κλειδώστε γυρίζοντας το μοχλό αριστερά μέχρι τη θέση κλειδώματος και τοποθετήστε μια κούπα. Η βάση υποστήριξης κούπας μπορεί να ρυθμιστεί ώστε να προσαρμόζεται στο μέγεθος της κούπας σας.

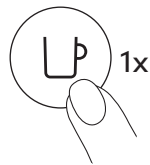

- 5** Ξεκινήστε την παρασκευή καφέ πιέζοντας το κουμπί μία φορά.

**ΠΡΟΣΟΧΗ:** για να χρησιμοποιήσετε τη μηχανή σωστά, μην ανοίγετε την κεφαλή της μηχανής κατά την παρασκευή καφέ, περιμένετε μέχρι να ανάψει συνεχόμενα λευκό το κουμπί του καφέ. Εάν θέλετε να σταματήσετε την παρασκευή καφέ νωρίτερα, πατήστε το κουμπί καφέ μία φορά και περιμένετε μέχρι να σταματήσει η μηχανή πριν ανοίξετε την κεφαλή.

- i** Λόγω της σάρωσης του κώδικα, του χρόνου προδιαβροχής και έγχυσης του καφέ, θα χρειαστεί λίγος χρόνος μέχρι να αρχίσει να ρέει ο καφές. Η μηχανή θα αναγνωρίσει αυτόματα την τοποθετημένη κάψουλα και θα επιλέξει τις παραμέτρους παρασκευής καφέ και το μέγεθος του φλιτζανιού που έχουν οριστεί από τους ειδικούς του καφέ **Nespresso** για να επιτευχθεί η καλύτερη εκχύλιση που ταιριάζει με το μείγμα καφέ.



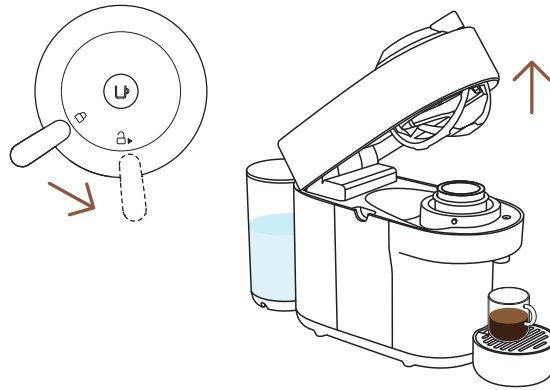

- 6** Όταν σταματήσει η παρασκευή του καφέ, ανοίξτε την κεφαλή της συσκευής στρέφοντας το μοχλό προς τα δεξιά στη θέση «ξεκλειδώματος», ώστε η κάψουλα να αφαιρεθεί αυτόματα και να απολαύσετε τον καφέ σας.



- 7** Μην ξεχάσετε να ανακυκλώσετε τις **Nespresso** κάψουλες σας.\*

\* ΕΙΝΑΙ **NESPRESSO**. ΕΙΝΑΙ ΑΝΑΚΥΚΛΩΣΙΜΟ. Για περισσότερες πληροφορίες σχετικά με το που μπορείτε να ανακυκλώσετε τις κάψουλες, επισκεφτείτε το [www.nespresso.com](http://www.nespresso.com)

## ΑΝΑΚΑΛΥΨΤΕ ΤΗ ΛΕΙΤΟΥΡΓΙΑ COFFEE CREATIONS



Με αυτή τη μηχανή, η **Nespresso** σας προσφέρει μια συγκεκριμένη λειτουργία για να συγκεντρώσετε τις εκχυλίσσεις καφέ και να δημιουργήσετε τις δικές σας συνταγές.

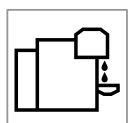

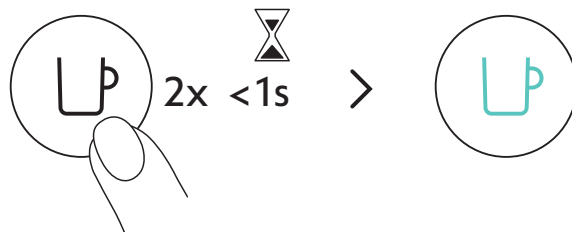

Με την μηχανή ενεργοποιημένη, πατήστε δύο φορές το κουμπί καφέ. Θα αναβοσβήσει τirkουάζ και η παρασκευή του καφέ σας θα συμπυκνωθεί, βελτιστοποιώντας τη γεύση του καφέ σε συνταγές με πρόσθετα υλικά (γάλα, κρέμα, πάγο...). Για Ασύγκριτη Εμπειρία Καφέ.

40 ml	80 ml	150 ml	230 ml	355 ml	535 ml
✓	✓	✓	✓	✗	✗
25 ml	40 ml	40 ml	80 ml		

Για να απολαύσετε πλήρως τα οφέλη, σας συνιστούμε να παρασκευάζετε τη σειρά Coffee+ χρησιμοποιώντας μόνο τα προτεινόμενα μεγέθη φλιτζανιών. Για τα καλύτερα αποτελέσματα στο φλιτζάνι, δεν συνιστούμε να παρασκευάζετε τη σειρά XL (Alto Ambrato, Alto Onice), Cold Brew Style & Carafe Pour Over Style με αυτήν τη λειτουργία.

**ΣΗΜΕΙΩΣΗ:** Ενδέχεται να απαιτείται ενημέρωση της μηχανής σας μέσω της εφαρμογής **Nespresso** για την ενεργοποίηση αυτής της λειτουργίας.



Ανακαλύψτε πώς να αναβαθμίσετε τη μηχανή σας με τη σειρά Aeroccino στη διεύθυνση [www.nespresso.com](http://www.nespresso.com)

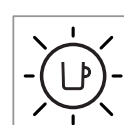
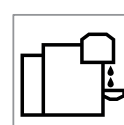
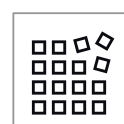
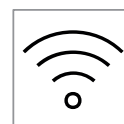



## ΠΡΟΣΑΡΜΟΣΤΕ ΤΙΣ ΠΟΣΟΤΗΤΕΣ ΚΑΦΕ

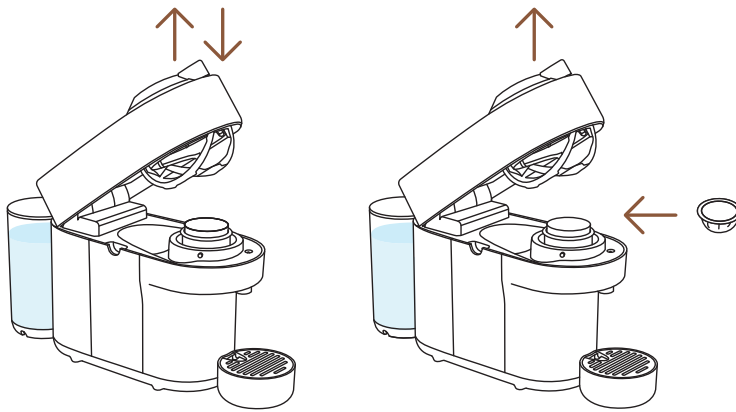

- 1** Ανοίξτε και κλείστε τη συσκευή. Με την μηχανή ενεργοποιημένη, ανοίξτε την και τοποθετήστε την κάψουλα που θέλετε να προγραμματίσετε.

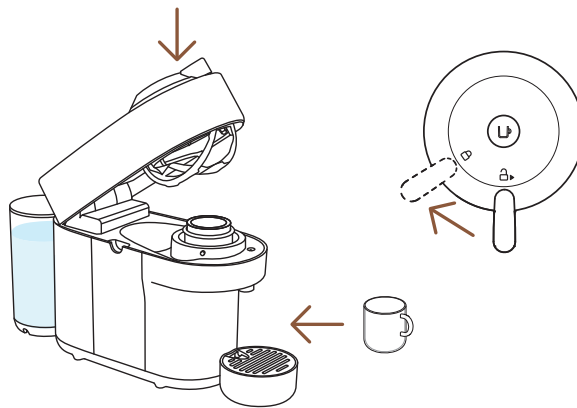

- 2** Κλείστε την κεφαλή της μηχανής, γυρίστε το μοχλό προς τα αριστερά στην θέση κλειδώματος και τοποθετήστε μια κούπα.

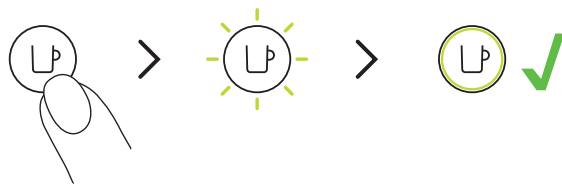

- 3** Πατήστε και κρατήστε πατημένο το κουμπί μέχρι να ορίσετε την ποσότητα που θέλετε. Ο νέος όγκος νερού έχει πλέον προγραμματιστεί για τον τύπο της κάψουλας που χρησιμοποιήθηκε κατά τη ρύθμιση.

- i** Ο προγραμματισμός είναι συγκεκριμένος για κάθε τύπο κάψουλας. Τα μεγέθη κούπας μπορούν να προγραμματιστούν από 20 ml έως 535 ml.

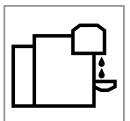

**ΠΡΟΣΟΧΗ:** για να χρησιμοποιήσετε τη μηχανή σωστά, μην ανοίγετε την κεφαλή της μηχανής κατά την παρασκευή καφέ, περιμένετε μέχρι να ανάψει συνεχόμενα λευκό το κουμπί του καφέ. Εάν θέλετε να σταματήσετε την παρασκευή καφέ νωρίτερα, πατήστε το κουμπί καφέ μία φορά και περιμένετε μέχρι να σταματήσει η μηχανή πριν ανοίξετε την κεφαλή.

**ΣΗΜΕΙΩΣΗ:** Μόλις προγραμματιστεί μια συγκεκριμένη ποσότητα από τον χρήστη, κάθε φορά που μια κάψουλα αυτού του τύπου θα εισάγεται στη μηχανή, η εκχύλιση θα σταματάει στην προγραμματισμένη ποσότητα. Εάν επιθυμείτε να επαναφέρετε τις εργοστασιακές ρυθμίσεις, ανατρέξτε στο κεφάλαιο “Επαναφορά εργοστασιακών ρυθμίσεων”.

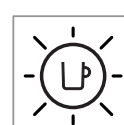
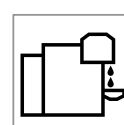
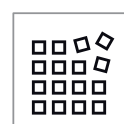
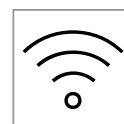

## ΚΑΘΑΡΙΣΜΟΣ

Καθαρίζετε τη μηχανή σας σε μηνιαία βάση, όταν αρχίσετε να έχετε υπολείμματα καφέ μέσα στην κεφαλή της μηχανής ή μετά από μια μακρά περίοδο μη χρήσης.

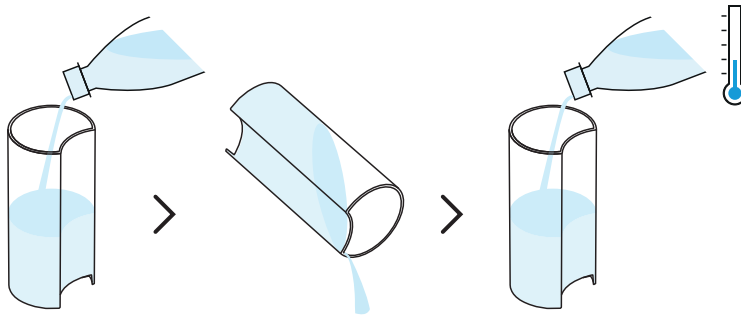

- 1** Ξεπλύνετε και καθαρίστε το δοχείο νερού και το καπάκι πριν το γεμίσετε με φρέσκο πόσιμο νερό.

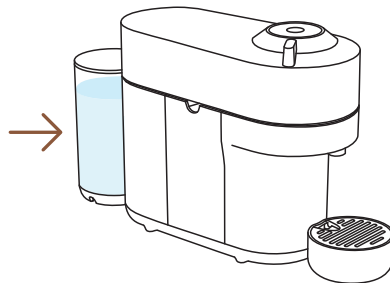

- 2** Τοποθετήστε ξανά τη δεξαμενή νερού στη μηχανή.

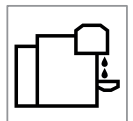
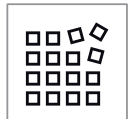

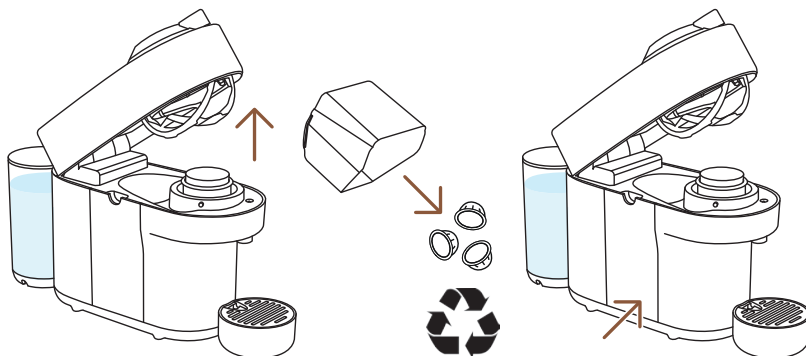

- 3** Με τη μηχανή ενεργοποιημένη, ξεκλειδώστε και ανοίξτε τη μηχανή για να αφαιρεθεί η χρησιμοποιημένη κάψουλα. Αδειάστε και ξεπλύνετε το δοχείο χρησιμοποιημένων καψουλών και το δίσκο συλλογής σταγόνων και τοποθετήστε τα ξανά στη θέση τους. Μην ξεχάσετε να ανακυκλώσετε τις **Nespresso** κάψουλες σας.\*

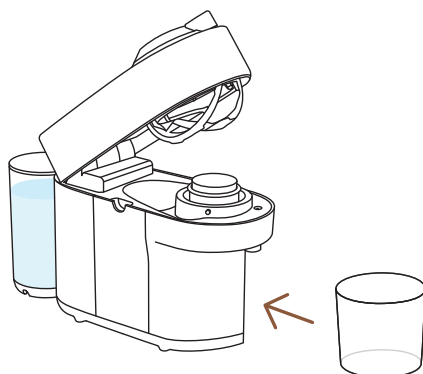

- 4** Αφαιρέστε τη βάση υποστήριξης κούπας και τοποθετήστε ένα άδειο δοχείο (τουλάχιστον 1 L / 34 fl oz) κάτω από το στόμιο εκροής καφέ.

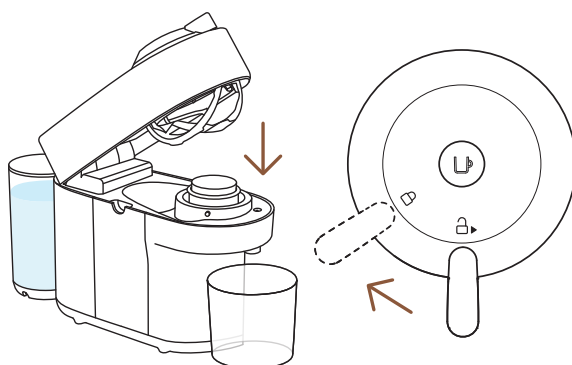

- 5** Κλείστε την κεφαλή της μηχανής και γυρίστε το μοχλό αριστερά προς τη θέση κλειδώματος. Βεβαιωθείτε ότι δεν υπάρχουν κάψουλες στη μηχανή πριν ξεκινήσετε τη διαδικασία έκπλυσης.

\* ΕΙΝΑΙ **NESPRESSO**. ΕΙΝΑΙ ΑΝΑΚΥΚΛΩΣΙΜΟ. Για περισσότερες πληροφορίες σχετικά με το που μπορείτε να ανακυκλώσετε τις κάψουλες, επισκεφτείτε το [www.nespresso.com](http://www.nespresso.com)

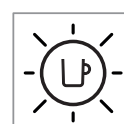
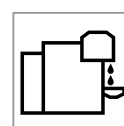
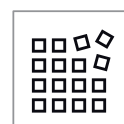
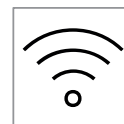

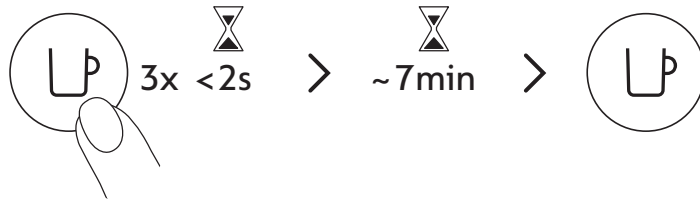

- 6** Πατήστε το κουμπί 3 φορές μέσα σε 2 δευτερόλεπτα για να ξεκινήσει το ξέπλυμα. Με το φως να αναβοσβήνει πορτοκαλί, αφήστε τη διαδικασία ξεπλύματος να ολοκληρωθεί αυτόματα.

- i** Θα πρέπει να περάσουν λιγότερο από 2 λεπτά πριν ξεκινήσει η διαδικασία ξεπλύματος και το νερό αρχίσει να ρέει. Αυτή η λειτουργία μπορεί να διαρκέσει έως και 7 λεπτά και θα σταματήσει αυτόματα όταν ολοκληρωθεί ο κύκλος. Η διαδικασία μπορεί να διακοπεί ανά πάσα στιγμή πατώντας το κουμπί

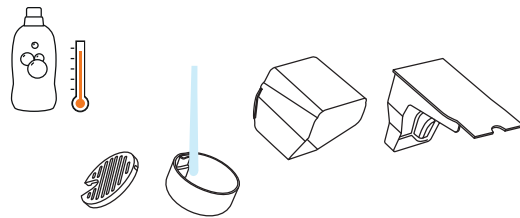

- 7** Πλύνετε το δοχείο χρησιμοποιημένων καψουλών, τη βάση υποστήριξης κούπας και το δίσκο αποστράγγισης σταγόνων με ζεστό νερό και ήπιο άοσμο απορρυπαντικό.

**ΠΡΟΣΟΧΗ:** Μη χρησιμοποιείτε ισχυρό ή λειαντικό καθαριστικό ή διαλυτικό καθαριστικό. Μην βάζετε τη μηχανή σε πλυντήριο πιάτων. Ποτέ μην βυθίζετε τη συσκευή ή μέρος της σε νερό.

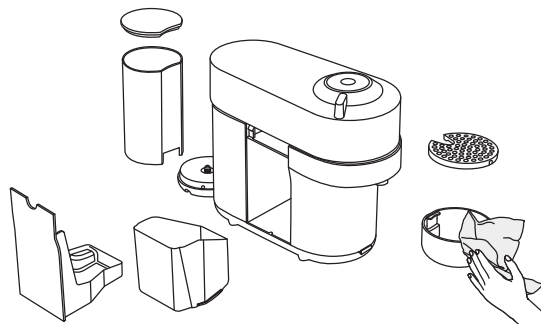

- 8** Σκουπίστε με μια καθαρή πετσέτα

**ΠΡΟΣΟΧΗ:** Καθαρίζετε τακτικά το στόμιο εκροής του καφέ με ένα καθαρό υγρό πανί. Να χρησιμοποιείτε πάντα μαλακά πανιά για να καθαρίζετε τη μηχανή.

**ΣΗΜΕΙΩΣΗ:** Ενδέχεται να συσσωρευτεί νερό στο επάνω τμήμα της μηχανής. Σκουπίστε τα εμφανή εξαρτήματα με ένα καθαρό, στεγνό πανί.

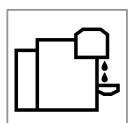

## ΑΦΑΛΑΤΩΣΗ

Η αφαλάτωση της μηχανής σας εξασφαλίζει την άψογη λειτουργία της καθ' όλη τη διάρκεια ζωής της, ώστε η εμπειρία του καφέ σας να είναι πάντα τόσο ξεχωριστή όσο την πρώτη φορά. Η συσκευή σας υποδεικνύει πότε είναι απαραίτητη η αφαλάτωση, με το κουμπί να αναβοσβήνει πορτοκαλί 3 φορές πριν αλλάξει σε συνεχές λευκό.



**i** Η διαδικασία αφαλάτωσης διαρκεί περίπου 20 λεπτά και **δεν μπορεί να διακοπεί.**

**ΣΗΜΕΙΩΣΗ:** Διαβάστε προσεκτικά τις οδηγίες αφαλάτωσης πριν ξεκινήσετε.

### Θα χρειαστείτε:

- Ένα κιτ αφαλάτωσης διατίθεται στο [www.nespresso.com](http://www.nespresso.com).
- Ένα άδειο δοχείο (1 L / 34 fl oz)

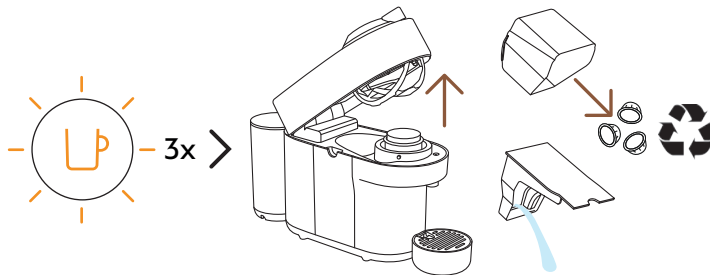

- 1** Με το κουμπί να αναβοσβήνει πορτοκαλί 3 φορές: Ξεκλειδώστε και ανοίξτε την κεφαλή της μηχανής και αφήστε τη χρησιμοποιημένη κάψουλα να αφαιρεθεί. Αδειάστε το δοχείο χρησιμοποιημένων καψουλών και το δίσκο αποστράγγισης σταγόνων και τοποθετήστε τα ξανά στη μηχανή. Μην ξεχάσετε να ανακυκλώσετε τις **Nespresso** κάψουλες σας.\*

\* ΕΙΝΑΙ **NESPRESSO**. ΕΙΝΑΙ ΑΝΑΚΥΚΛΩΣΙΜΟ. Για περισσότερες πληροφορίες σχετικά με το που μπορείτε να ανακυκλώσετε τις κάψουλες, επισκεφτείτε το [www.nespresso.com](http://www.nespresso.com)

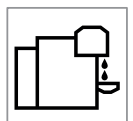

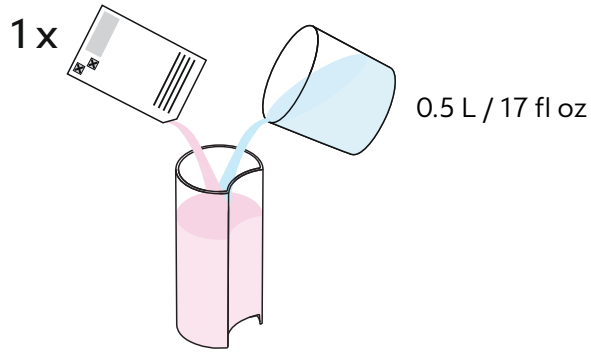

- 2** Γεμίστε τη δεξαμενή νερού με 0,5 L / 17 fl oz νερό και προσθέστε 1 μονάδα υγρού αφαλάτωσης **Nespresso**.

**ΠΡΟΣΟΧΗ:** Λάβετε υπόψη ότι το διάλυμα αφαλάτωσης μπορεί να είναι επιβλαβές. Αποφύγετε την επαφή με τα μάτια, το δέρμα και τις επιφάνειες.

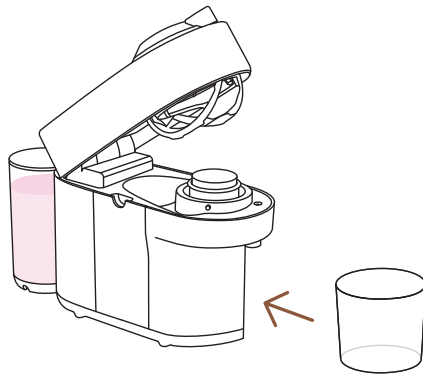

- 3** Αφαιρέστε τη βάση υποστήριξης κούπας και τοποθετήστε ένα άδειο δοχείο (τουλάχιστον 1 L / fl 34 oz) κάτω από το στόμιο εκροής καφέ.

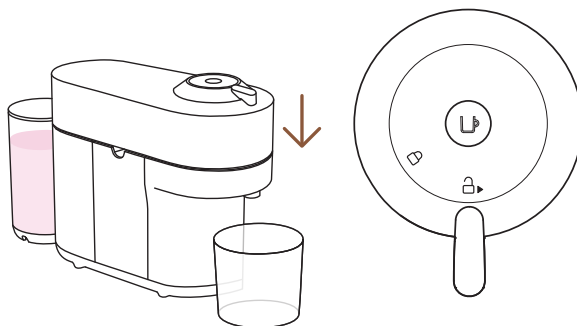

- 4** Με τη μηχανή ενεργοποιημένη, κλείστε την κεφαλή και αφήστε το μοχλό στη θέση ξεκλειδώματος.

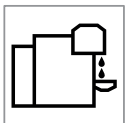

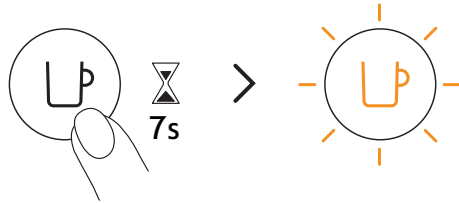

- 5** Πατήστε και κρατήστε πατημένο το κουμπί για 7 δευτερόλεπτα ή μέχρι να δείτε το φως να σβήνει. Το κουμπί αρχίζει να αναβοσβήνει γρήγορα με πορτοκαλί χρώμα.

**ΠΡΟΣΟΧΗ:** Έχετε πλέον 45 δευτερόλεπτα για να μπει η μηχανή στη λειτουργία αφαλάτωσης, διαφορετικά θα επανέλθει στη λειτουργία παρασκευής καφέ.

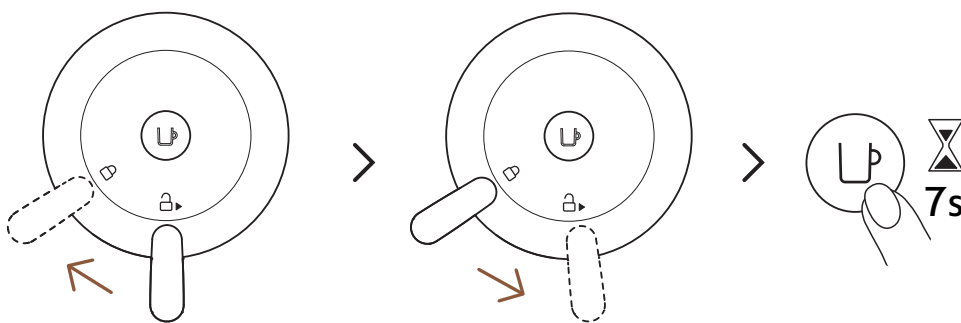

- 6** Κλειδώστε την κεφαλή της μηχανής περιστρέφοντας το μοχλό αριστερά μέχρι την ένδειξη κλειδώματος και στη συνέχεια ξεκλειδώστε στρίβοντας τον μοχλό δεξιά στη θέση ξεκλειδώματος. Πατήστε και κρατήστε πατημένο το κουμπί ξανά για περίπου 7 δευτερόλεπτα ή μέχρι να σβήσει το φως. Το κουμπί θα αρχίσει να αναβοσβήνει γρήγορα με πορτοκαλί χρώμα.

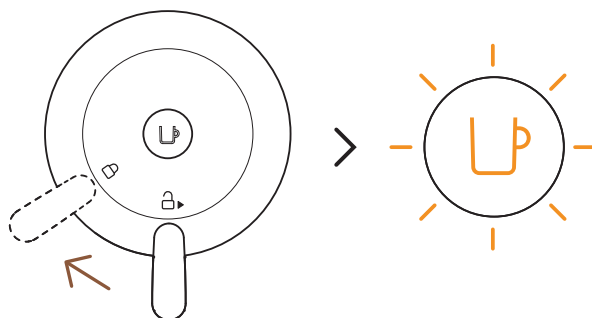

- 7** Για να μπείτε στη λειτουργία αφαλάτωσης, κλείδωσε τη μηχανή στρέφοντας το μοχλό προς τα αριστερά στη θέση κλειδώματος. Το φως πρέπει να αναβοσβήνει γρήγορα με πορτοκαλί χρώμα. Αυτό υποδηλώνει ότι έχετε μπει σε λειτουργία αφαλάτωσης.

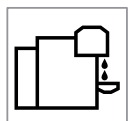
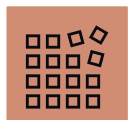



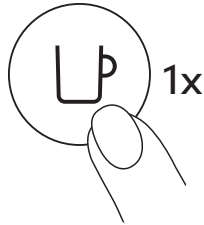

- 8** Πατήστε το κουμπί καφέ μία φορά για να ξεκινήσει η διαδικασία αφαλάτωσης. Η ενδεικτική λυχνία θα αναβοσβήνει πορτοκαλί καθ' όλη τη διάρκεια της διαδικασίας.
- i** Η μηχανή θα σταματήσει αυτόματα όταν ολοκληρωθεί η πρώτη φάση της αφαλάτωσης.

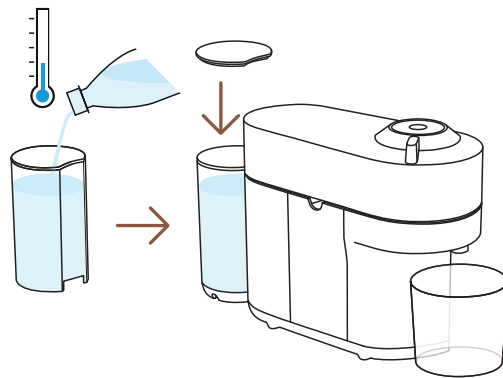

- 9** Στο τέλος της διαδικασίας αφαλάτωσης, είναι ώρα να ξεπλύνετε το μηχάνημα. Ξεπλύνετε σχολαστικά τη δεξαμενή νερού και το δίσκο συλλογής σταγόνων. Γεμίστε το δοχείο νερού με φρέσκο πόσιμο νερό και τοποθετήστε το ξανά στη θέση του. Αδειάστε το δοχείο και τοποθετήστε το ξανά κάτω από το στόμιο εκροής καφέ.

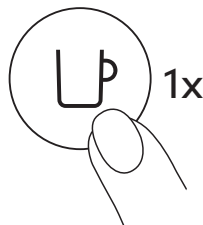

- 10** Πατήστε το κουμπί για να ξεπλύνετε τη μηχανή. Όταν το κουμπί σταματήσει να αναβοσβήνει γρήγορα και παραμείνει σταθερό, η διαδικασία αφαλάτωσης έχει ολοκληρωθεί.
- i** Η μηχανή θα σταματήσει αυτόματα όταν ολοκληρωθεί η διαδικασία.

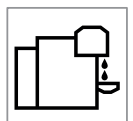
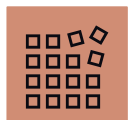

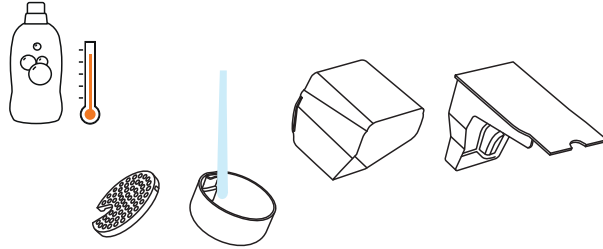

- 11** Πλύνετε το δοχείο χρησιμοποιημένων καψουλών, τη βάση υποστήριξης κούπας και το δίσκο αποστράγγισης σταγόνων με ζεστό νερό και ήπιο άοσμο απορρυπαντικό.

**ΠΡΟΣΟΧΗ:** Μη χρησιμοποιείτε ισχυρό ή λειαντικό καθαριστικό ή διαλυτικό καθαριστικό. Μην βάζετε τη μηχανή σε πλυντήριο πιάτων. Ποτέ μην βυθίζετε τη συσκευή ή μέρος της σε νερό.

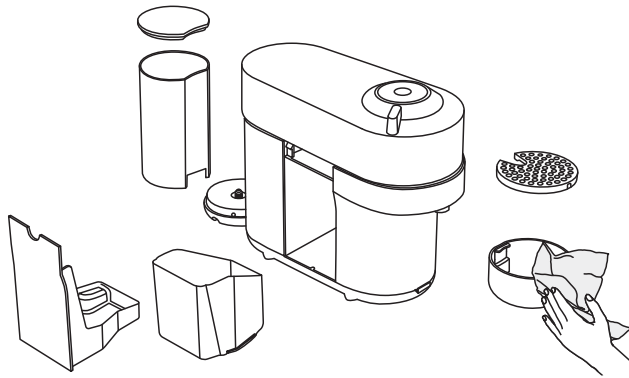

- 12** Στεγνώστε τη μηχανή με μια καθαρή και φρέσκια πετσέτα. Αφήστε τη μηχανή να στεγνώσει για 10 λεπτά πριν τη χρησιμοποιήσετε.

**ΣΗΜΕΙΩΣΗ:** Κατά τον καθαρισμό μπορεί να συσσωρευτεί νερό στο εσωτερικό της κεφαλής της μηχανής. Εάν συμβεί αυτό, στεγνώστε τα ορατά μέρη με ένα καθαρό στεγνό πανί.

**ΣΗΜΕΙΩΣΗ:** η μηχανή μπορεί να μπει σε διαδικασία αφαλάτωσης μετά την παρασκευή τουλάχιστον 30 καφέδων.



## ΑΔΕΙΑΣΜΑ ΤΟΥ ΣΥΣΤΗΜΑΤΟΣ

Το άδειασμα του συστήματος είναι μια διαδικασία που μπορεί να γίνει πριν από μια περίοδο μη χρήσης, για προστασία από παγετό ή πριν από την αποστολή της μηχανής για επισκευή.

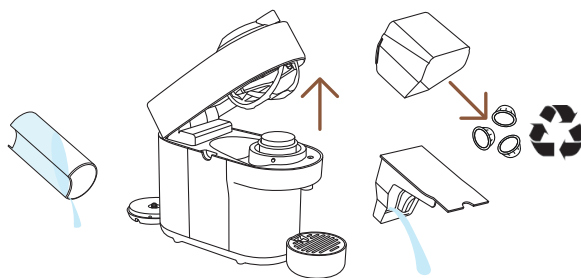

- 1** Αδειάστε το δοχείο νερού, ανοίξτε την κεφαλή της μηχανής και αφήστε τη χρησιμοποιημένη κάψουλα να αφαιρεθεί. Αδειάστε το δοχείο χρησιμοποιημένων καψουλών και το δίσκο αποστράγγισης σταγόνων. Μην ξεχάσετε να ανακυκλώσετε τις **Nespresso** κάψουλες σας.\*

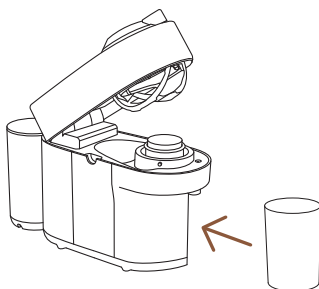

- 2** Τοποθετήστε τα ξανά στη μηχανή, αφαιρέστε τη βάση υποστήριξης κούπας και τοποθετήστε ένα άδειο δοχείο (0,5 L / 17 fl oz) κάτω από το στόμιο εκροής καφέ.

\* ΕΙΝΑΙ **NESPRESSO**. ΕΙΝΑΙ ΑΝΑΚΥΚΛΩΣΙΜΟ. Για περισσότερες πληροφορίες σχετικά με το που μπορείτε να ανακυκλώσετε τις κάψουλες, επισκεφτείτε το [www.nespresso.com](http://www.nespresso.com)

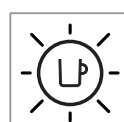
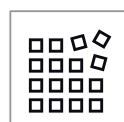
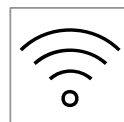

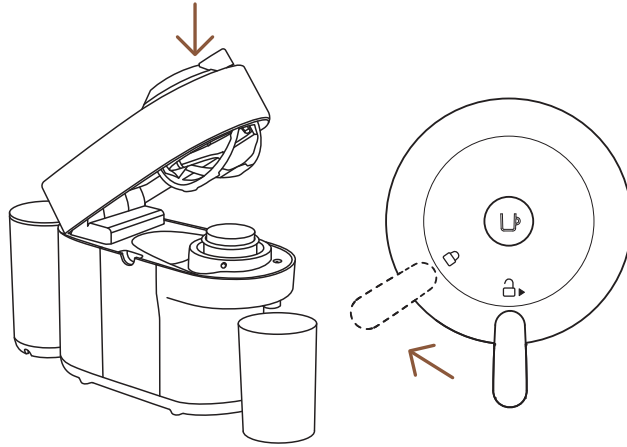

- 3** Με τη μηχανή συνδεδεμένη και ενεργοποιημένη, γυρίστε το μοχλό προς τη θέση κλειδώματος.

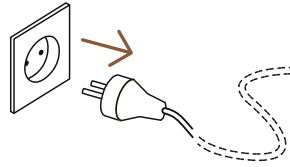

- 4** Αποσυνδέστε τη μηχανή από την πρίζα

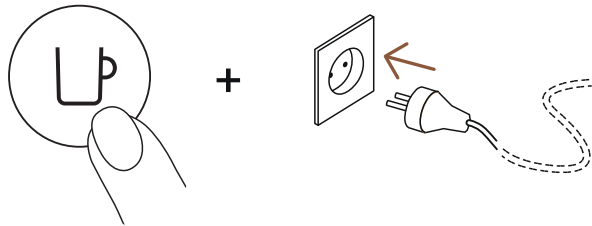

- 5** Πατήστε και κρατήστε πατημένο το κουμπί ενώ συνδέεστε

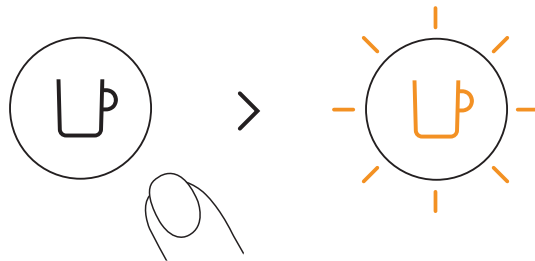

- 6** Αφήστε το κουμπί. Θα αναβοσβήσει πορτοκαλί και θα ξεκινήσει η διαδικασία αδειάσματος του συστήματος.

- i** Θα χρειαστούν περίπου 30 δευτερόλεπτα για να ολοκληρωθεί η διαδικασία αδειάσματος του συστήματος. Η μηχανή απενεργοποιείται αυτόματα όταν είναι άδεια.



## ΕΠΑΝΑΦΟΡΑ ΕΡΓΟΣΤΑΣΙΑΚΩΝ ΡΥΘΜΙΣΕΩΝ

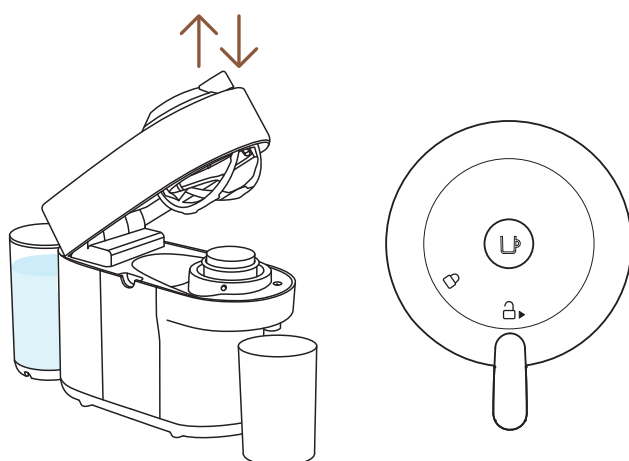

- 1 Με τη μηχανή συνδεδεμένη στην πρίζα, ανοίξτε και στην συνέχεια κλείστε την κεφαλή της μηχανής προτού αφήσετε το **μοχλό** στη θέση ξεκλειδώματος.

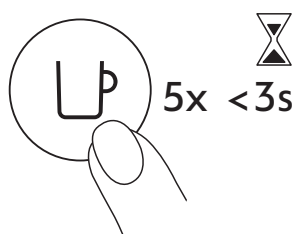

- 2 Πατήστε το κουμπί 5 φορές μέσα σε 3 δευτερόλεπτα. Η μηχανή έχει πλέον προγραμματιστεί με τις εργοστασιακές ρυθμίσεις.

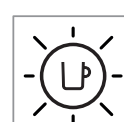
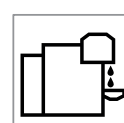
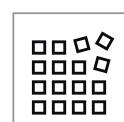
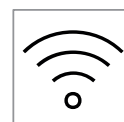

## ΣΥΝΟΨΗ ΦΩΤΕΙΝΩΝ ΕΝΔΕΙΞΕΩΝ

Θα θέλατε να μάθετε περισσότερα για τις φωτεινές ενδείξεις της Vertuo Pop; Παρακαλούμε δείτε το παρακάτω βίντεο:

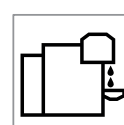
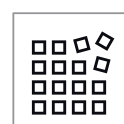
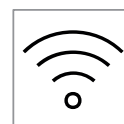

## ΑΝΤΙΜΕΤΩΠΙΣΗ ΠΡΟΒΛΗΜΑΤΩΝ

### Η φωτεινή ένδειξη είναι σβηστή

- Η μηχανή απενεργοποιήθηκε αυτόματα. Πατήστε το κουμπί ή απασφαλίστε τη μηχανή.
- Ελέγξτε την πρίζα, το φως, την τάση και την ασφάλεια.

### Δεν βγαίνει ούτε καφές ούτε νερό.

- Ελέγξτε αν το δοχείο νερού είναι γεμάτο.
- Βεβαιωθείτε ότι υπάρχει καινούργια κάψουλα, η οποία έχει τοποθετηθεί σωστά, και ότι η λαβή είναι σωστά ασφαλισμένη, και έπειτα πατήστε το κουμπί.
- Κάντε αφαλάτωση, αν είναι απαραίτητο
- Ανοίξτε το επάνω μέρος της μηχανής για να εξαχθεί η κάψουλα. Έπειτα, καθαρίστε τη μηχανή όπως περιγράφεται στην ενότητα για τον καθαρισμό.

### Ο καφές δεν είναι αρκετά ζεστός.

- Προθερμάνετε το φλιτζάνι με ζεστό νερό βρύσης.
- Κάντε αφαλάτωση, αν είναι απαραίτητο

### Διαρροή ή ασυνήθιστη ροή καφέ

- Ελέγξτε αν το δοχείο νερού είναι σωστά τοποθετημένο.
- Κάντε αφαλάτωση, αν είναι απαραίτητο

### Η μηχανή απενεργοποιείται.

- Για λόγους εξοικονόμησης ενέργειας, η μηχανή απενεργοποιείται αυτόματα αν δεν χρησιμοποιηθεί για 2 λεπτά.
- Η μηχανή μπορεί να απενεργοποιηθεί χειροκίνητα ανά πάσα στιγμή (όταν δεν χρησιμοποιείται) πατώντας παρατεταμένα το κουμπί για 3 δευτερόλεπτα.

### Υπάρχουν κόκκοι καφέ στο φλιτζάνι.

- Εκτελέστε δύο φορές τη διαδικασία καθαρισμού.
- Ανατρέξτε στην ενότητα **για τον καθαρισμό**.

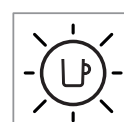
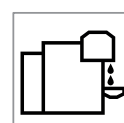
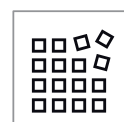
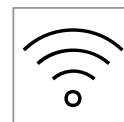

**Η μηχανή δεν τίθεται σε λειτουργία και η φωτεινή ένδειξη είναι σταθερά αναμμένη. Αν αναβοσβήνει η φωτεινή ένδειξη, ανατρέξτε στα παρακάτω σημεία.**

**Η μηχανή δεν τίθεται σε λειτουργία και η φωτεινή ένδειξη αναβοσβήνει εναλλάξ (1 φορά αναβοσβήνει και 1 σταματάει).**

**Η φωτεινή ένδειξη αναβοσβήνει ενώ η μηχανή λειτουργεί.**

**Η μηχανή δεν τίθεται σε λειτουργία και η φωτεινή ένδειξη αναβοσβήνει εναλλάξ (1 φορά αναβοσβήνει και 1 σταματάει).**

- Βεβαιωθείτε ότι η λαβή έχει ασφαλίσει σωστά.
- Αν θέλετε να φτιάξετε Καφέ ή Espresso, βεβαιωθείτε ότι υπάρχει καινούργια κάψουλα, η οποία έχει τοποθετηθεί σωστά, και ότι η λαβή είναι σωστά ασφαλισμένη, και έπειτα πατήστε το κουμπί.
- Αν θέλετε να καθαρίσετε, να αφαιρέσετε ή να εκκενώσετε το σύστημα, βεβαιωθείτε ότι δεν υπάρχει τοποθετημένη κάψουλα, κλείστε και ασφαλίστε τη μηχανή, και έπειτα πατήστε το κουμπί για να ξεκινήσετε τη σχετική διαδικασία.
- Γεμίστε το δοχείο νερού και πατήστε το κουμπί για να θέσετε σε λειτουργία τη μηχανή.
- Βεβαιωθείτε ότι η λαβή έχει ασφαλίσει σωστά.
- Αν η ροή του καφέ είναι φυσιολογική, αυτό σημαίνει ότι η μηχανή λειτουργεί σωστά.
- Αν ρέει μόνο νερό, η μηχανή εκτελεί τη διαδικασία καθαρισμού, αφαιρέσεως ή εκκένωσης του συστήματος, κατόπιν εντολής του χρήστη. Ανατρέξτε στην αντίστοιχη ενότητα.
- Απενεργοποιήστε τη μηχανή κρατώντας πατημένο το κουμπί για 3 δευτερόλεπτα και έπειτα πατήστε ξανά το κουμπί για να ενεργοποιήσετε τη μηχανή. Περιμένετε περίπου 20 λεπτά για να κρυώσει η μηχανή μετά την παρατεταμένη χρήση.
- Απαιτείται λίγος χρόνος μέχρι να ξεκινήσει η εκροή του καφέ. (Η καθυστέρηση αυτή οφείλεται στην ανάγνωση του γραμμωτού κώδικα και την προετοιμασία του καφέ.)
- Βεβαιωθείτε ότι υπάρχει καινούργια κάψουλα, η οποία έχει τοποθετηθεί σωστά, και ότι η λαβή είναι σωστά ασφαλισμένη, και έπειτα πατήστε το κουμπί.
- Γεμίστε το δοχείο νερού και πατήστε το κουμπί για να θέσετε σε λειτουργία τη μηχανή.
- Απενεργοποιήστε τη μηχανή κρατώντας πατημένο το κουμπί για 3 δευτερόλεπτα και έπειτα πατήστε ξανά το κουμπί για να ενεργοποιήσετε τη μηχανή. Περιμένετε περίπου 20 λεπτά για να κρυώσει η μηχανή μετά την παρατεταμένη χρήση.

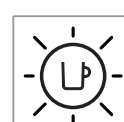
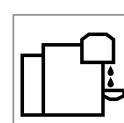
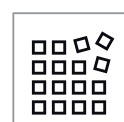
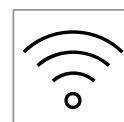



**Η φωτεινή ένδειξη αναβοσβήνει 2 φορές και μετά κάνει 1 παύση, επαναλαμβάνοντας το ίδιο μοτίβο συνεχόμενα. Η μηχανή δεν λειτουργεί.**

- Κατά την παρασκευή σκέτου καφέ/ Espresso:
  - 1) Απασφαλίστε τη λαβή και ανοίξτε το επάνω μέρος της μηχανής για να ελέγξετε ότι υπάρχει καινούργια κάψουλα και ότι η κάψουλα αυτή έχει τοποθετηθεί σωστά.
  - 2) Βεβαιωθείτε ότι η λαβή βρίσκεται στη θέση ασφάλισης.
  - 3) Ελέγξτε αν το δοχείο νερού είναι γεμάτο.
- Κατά την αφαλάτωση, την εκκένωση και τον καθαρισμό:
  - 1) Βεβαιωθείτε ότι έχει εξαχθεί η κάψουλα.
  - 2) Βεβαιωθείτε ότι η λαβή βρίσκεται στη θέση ασφάλισης.
- Κατά τη ρύθμιση μεγέθους:
  - 1) Βεβαιωθείτε ότι υπάρχει σωστά τοποθετημένη κάψουλα.
  - 2) Ανατρέξτε στην αντίστοιχη ενότητα
- Αν δεν λυθεί το πρόβλημα:
  - 1) Απασφαλίστε τη λαβή και ανοίξτε το επάνω μέρος της μηχανής.
  - 2) Αντικαταστήστε την κάψουλα (αν είναι απαραίτητο).
  - 3) Αποσυνδέστε το καλώδιο ρεύματος από την πρίζα, περιμένετε 10 δευτερόλεπτα και έπειτα συνδέστε ξανά τη μηχανή στην πρίζα
  - 4) Κλείστε το επάνω μέρος της μηχανής, πατήστε το κουμπί για να την ενεργοποιήσετε και, έπειτα, πατήστε ξανά το κουμπί για να ξεκινήσει η παρασκευή του καφέ.

Αν δεν λυθεί το πρόβλημα, καλέστε την **Nespresso**.

**Η φωτεινή ένδειξη αναβοσβήνει 3 φορές και μετά παραμένει σταθερά αναμμένη.**

- Απαιτείται αφαλάτωση. Από τη στιγμή που θα εμφανιστεί αυτή η ειδοποίηση, θα έχετε περιθώριο να χρησιμοποιήσετε τη μηχανή λίγες φορές ακόμα. Μετά, θα πρέπει υποχρεωτικά να κάνετε αφαλάτωση.

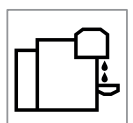

## ΤΕΧΝΙΚΑ ΧΑΡΑΚΤΗΡΙΣΤΙΚΑ

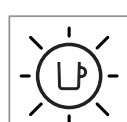
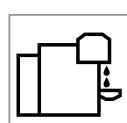
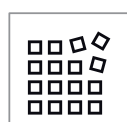
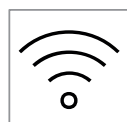

<b>Ισχύς</b>	<b>~220–240 V, 50–60 Hz, 1300–1500 W</b> <b>US, CA:</b> 120 V, 60 Hz, 1500 W <b>MX:</b> 127 V~, 60 Hz, 1380 W
<b>Συχνότητα</b>	2.402–2.480 GHz
<b>RF Ισχύς εξόδου (EIRP)</b>	Bluetooth 4 dBm Max. e.i.r.p. και Wi-Fi <20 dMm max. e.i.r.p.
<b>Αναμονή</b>	0.39 W/h
<b>Λειτουργία εξοικονόμησης ενέργειας</b>	Αυτόματη απενεργοποίηση: 2 λεπτά
<b>Χρόνος προθέρμανσης</b>	30 δευτερόλεπτα (κεφαλή κλειστή και κλειδωμένη)
<b>Κινητή βάση υποστήριξης κούπας για μεγάλες συνταγές</b>	Αφαιρούμενη μονή θέση
<b>Μήκος καλωδίου από την έξοδο της συσκευής</b>	75 cm / 30 in
<b>Διαστάσεις ( Β x Π x Υ )</b>	13.6 x 42.6 x 25 cm / 5.3 x 16.7 x 9.8 in
<b>Βάρος</b>	3.5 kg / 7.72 lbs
<b>Χωρητικότητα δεξαμενής νερού</b>	0.6 l / 20 fl oz
<b>Χωρητικότητα δοχείου καψουλών</b>	8 espresso or 5 mug κάψουλες

## ΚΩΔΙΚΟΙ ΜΗΧΑΝΩΝ

<b>Nespresso</b>	<b>Breville</b>	<b>Delonghi</b>
GCV2, GDV2	BNV120, BNV150	ENV90
<b>Krups</b>	<b>Magimix</b>	
XN9201, XN9204, XN9205, XN9211	M800	

# KLIKNIJ I WYBIERZ SWÓJ JĘZYK

PL



**ZASADY BEZPIECZEŃSTWA**



**PRZEGLĄD**



**ŁĄCZNOŚĆ**



**PIERWSZE KROKI**



**PRZYGOTOWYWANIE KAWY**



**DOSTOSUJ WIELKOŚĆ TWOJEJ KAWY**



**CZYSZCZENIE**



**ODKAMIENIANIE**



**OPRÓŻNIANIE SYSTEMU WODNEGO**



**PRZYWRÓCENIE USTAWIEŃ  
FABRYCZNYCH**



**OBJAŚNIENIE PODŚWIETLANIA  
PRZYCISKU**



**ROZWIĄZYWANIE PROBLEMÓW**



**SPECYFIKACJE**

## ZASADY BEZPIECZEŃSTWA

**UWAGA:** Przed uruchomieniem ekspresu do kawy, w celu uniknięcia ewentualnych obrażeń i szkód, należy zapoznać się z instrukcjami bezpieczeństwa w tym regulaminie.

### UTYLIZACJA I OCHRONA ŚRODOWISKA

Urządzenie wyprodukowano zgodnie z Dyrektywą 2002/96/WE. Podział materiałów odpadowych na różne rodzaje umożliwia odzyskanie cennych surowców. Nie wolno wyrzucać zużytego sprzętu łącznie z innymi odpadami. Zużyty sprzęt należy oddać do punktu zbiórki takich urządzeń.

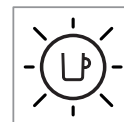
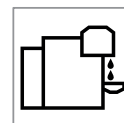
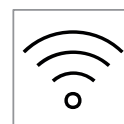

## INFORMACJE OGÓLNE

### OPIS URZĄDZENIA

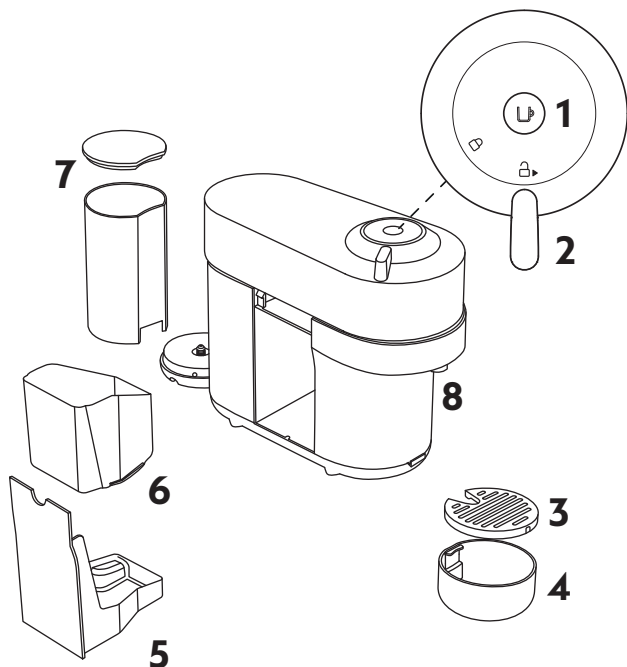

- 1 WŁ./WYŁ. i przycisk parzenia kawy
- 2 Blokowanie/Odblokowanie dźwigni
- 3 Kratka ociekowa
- 4 Regulowana podstawka pod filiżankę
- 5 Korytko ociekowe
- 6 Pojemnik na zużyte kapsułki
- 7 Zbiornik na wodę i pokrywa
- 8 Wylot kawy

### ZAWARTOŚĆ OPAKOWANIA



- 1 Ekspres do kawy
- 2 Pudełko kapsułek **Nespresso**
- 3 Materiały powitalne **Nespresso**
- 4 Instrukcje dotyczące bezpieczeństwa
- 5 Instrukcja szybkiego startu
- 6 Gwarancja

**i Rozpakowanie:** na powierzchni urządzenia może znajdować się trochę kurzu z powodu materiałów pochodzących z recyklingu użytych w opakowaniu. Nie jest to niebezpieczne, wystarczy wyczyścić miękką ściereczką.

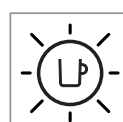
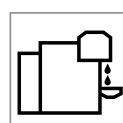
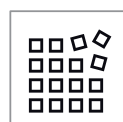
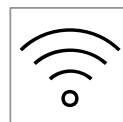

## OTWÓRZ/ ZAMKNIJ

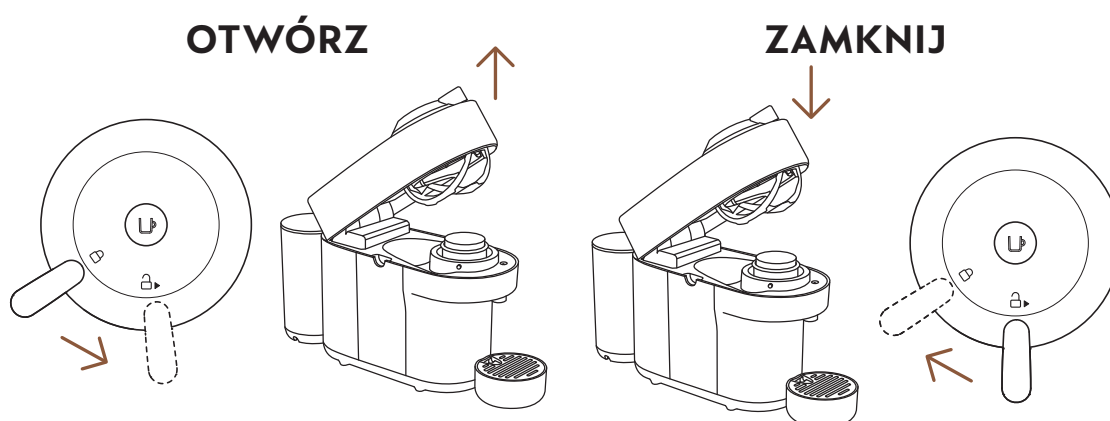

**UWAGA:** Aby prawidłowo korzystać z urządzenia, nie należy otwierać głowicy urządzenia podczas parzenia kawy; należy poczekać, aż przycisk kawy zacznie świecić na biało. Jeśli chcesz zatrzymać parzenie kawy wcześniej, naciśnij jeden raz przycisk kawy i poczekaj z otwarciem głowicy, aż urządzenie się zatrzyma.

## SYSTEM VERTUO

## KOMPATYBILNOŚĆ KAPSULEK

**S****Ristretto**

(25 ml)

**Espresso**

(40 ml)

**M****Double Espresso**

(80 ml)

**Gran Lungo**

(150 ml)

**L****Mug**

(230 ml)

**XL****Alto, Cold Brew**

(355 ml)

**Karafka**

(535 ml)

## KOMPATYBILNOŚĆ AKCESORIÓW



Kompatybilność akcesoriów

**Ristretto****Espresso****Double Espresso****Gran Lungo****Mug (S)****Mug (M)****Szkló degustacyjne**

Niepasujące akcesoria

**Mug (L)****Karafka**

Sprawdź pełną ofertę naszych akcesoriów na [www.nespresso.com](http://www.nespresso.com)

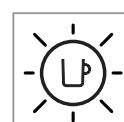
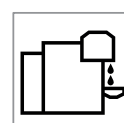
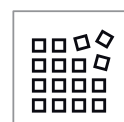
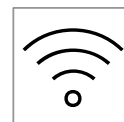

## WŁ./WYŁ.

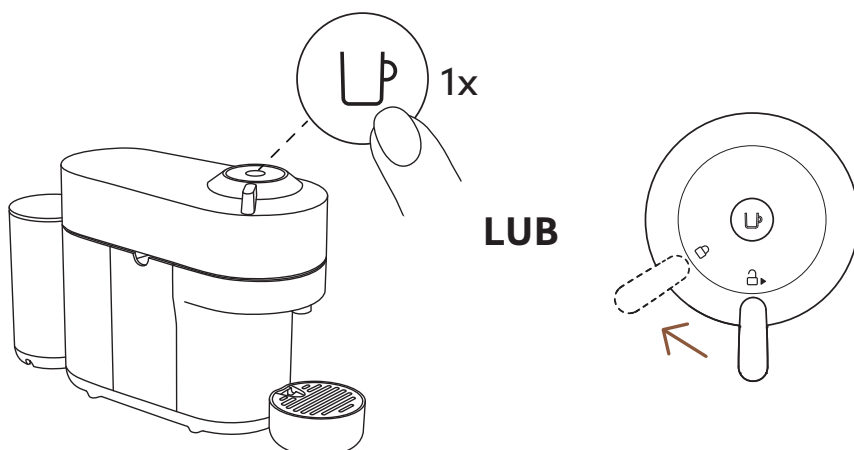
**WŁ.**

Kiedy urządzenie jest podłączone do prądu, włącz je, naciskając przycisk jeden raz lub zamykając dźwignię do pozycji zamkniętej (przy zamkniętej głowicy).

- i** Kontrolka będzie migać przez około 30 sekund podczas nagrzewania urządzenia. Kiedy kontrolka zaświeci się światłem ciągłym, urządzenie jest gotowe do pracy.

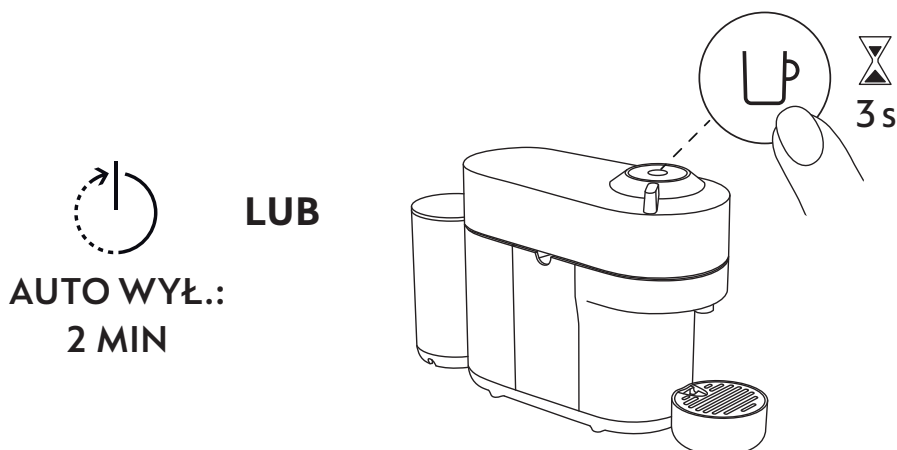
**WYŁ.**

Aby zaoszczędzić energię, ekspres wyłącza się automatycznie po 2 minutach nieużywania.

- i** Urządzenie można wyłączyć ręcznie w dowolnym momencie (gdy nie jest używane), naciskając i przytrzymując przycisk przez 3 sekundy.

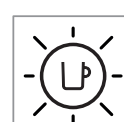
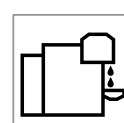
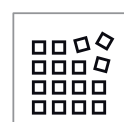
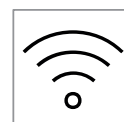

# ŁĄCZNOŚĆ

## DLACZEGO POWINIENIEŚ SPAROWAĆ SWOJE URZĄDZENIE VERTUO POP?

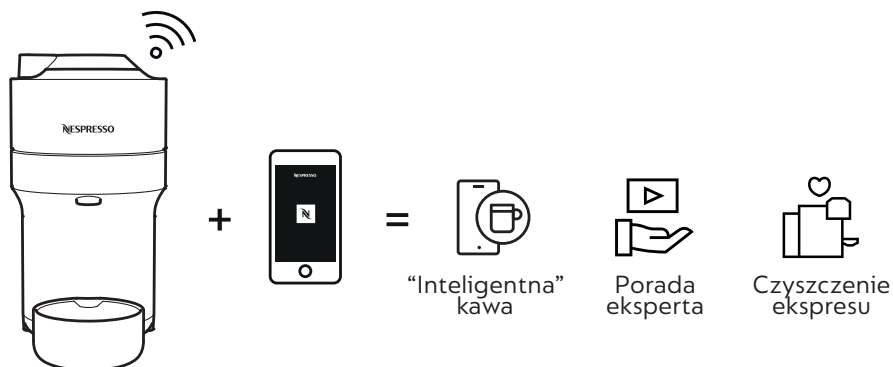

## BENEFITY PODŁĄCZENIA TWOJEGO EKSPRESU VERTUO POP

- **“Inteligentna” kawa:** Bądź zawsze o krok do przodu i otrzymuj najnowsze innowacje kawowe od **Nespresso**, utrzymując swoje urządzenie na najwyższym poziomie i aktualizując je.
- **Porada eksperta:** Uzyskaj wsparcie i proste filmy instruktażowe, które będą towarzyszyć ci podczas kawowej podróży, za pośrednictwem smartfona.
- **Czyszczenie ekspresu:** Otrzymuj natychmiastowe powiadomienia o tym, jak i kiedy należy serwisować urządzenie, z łatwym przewodnikiem po odkamienianiu, płukaniu, czyszczeniu itp.

## JAK POŁĄCZYĆ TWÓJ EKSPRES VERTUO POP?

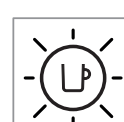
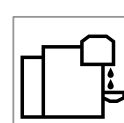
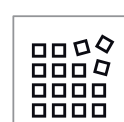



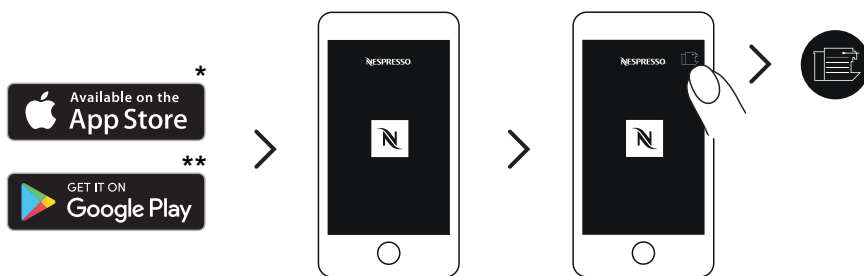

- 1** Pobierz lub zaktualizuj aplikację **Nespresso**. Uruchom aplikację **Nespresso** na smartfonie lub tablecie. Naciśnij ikonę ekspresu w prawym górnym rogu ekranu.

**UWAGA:** Aby uzyskać optymalną wydajność i płynne działanie, zalecamy podłączenie urządzenia do routera Wi-Fi zamiast korzystania z internetu udostępnionego z np. telefonu.

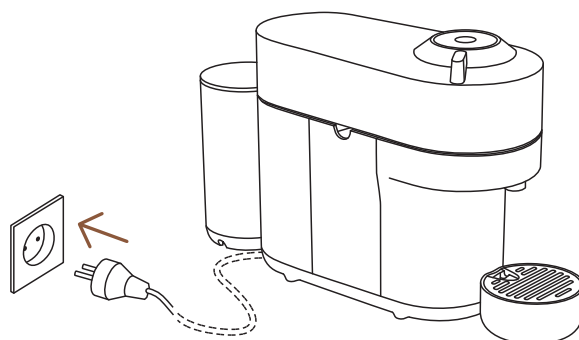

- 2** Podłącz kabel zasilający.



- 3** Śledź instrukcje wyświetlane w aplikacji **Nespresso**.

**UWAGA:** Aby uniknąć ryzyka śmiertelnego porażenia prądem elektrycznym i pożaru, należy najpierw zapoznać się ze środkami ostrożności. Upewnij się proszę, że gniazdko jest wyposażone w uziemienie.

- \* App Store® jest znakiem towarowym należącym do Apple Inc, zarejestrowanym w USA i w innych krajach.  
 \*\* Google Play i Google Play logo są znakami towarowymi Google LLC.

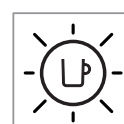
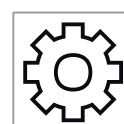
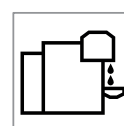
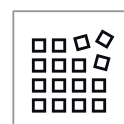

## WYŁĄCZANIE ŁĄCZNOŚCI EKSPRESU Z BLUETOOTH I WI-FI

Urządzenie jest domyślnie wyposażone w moduł łączności. Zapewnia dostęp do dodatkowych funkcji, zwiększając doznania związane z piciem kawy. Aby wyłączyć moduł łączności, wykonaj następujące kroki:

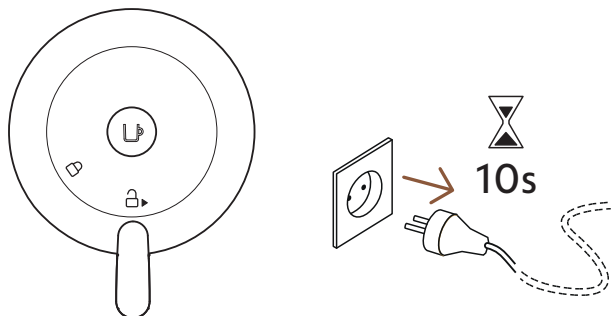

- 1 Przy zamkniętym urządzeniu i dźwigni w pozycji **odblokowanej** odłącz urządzenie od zasilania na co najmniej 10 sekund.

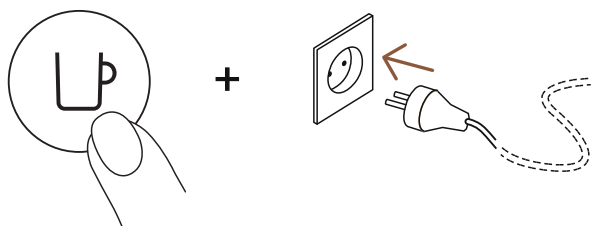

- 2 Naciśnij i przytrzymaj przycisk podczas podłączania. Przycisk zacznie migać na pomarańczowo, potwierdzając wyłączenie modułu łączności.
- i** Wykonaj te same kroki, aby ponownie włączyć moduł łączności. Przycisk zacznie migać na biało, potwierdzając ponowną aktywację modułu.

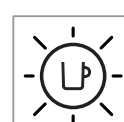
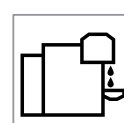
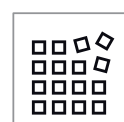

# PIERWSZE KROKI

## PIERWSZE PŁUKANIE

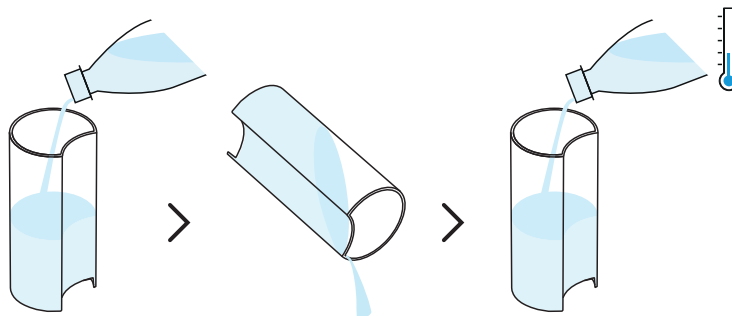

- 1** Najpierw przepłucz i umyj zbiornik na wodę i pokrywą przed napełnieniem go świeżą wodą pitną.

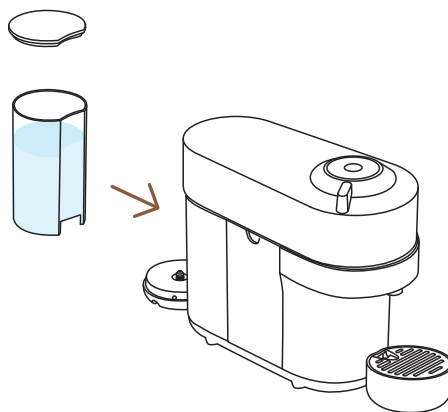

- 2** Zamknij zbiornik na wodę pokrywą i umieść go na miejscu, upewniając się, że jest prawidłowo zamocowany.

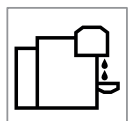
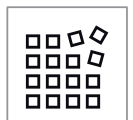

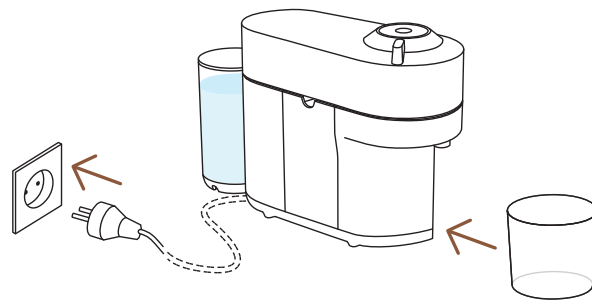

- 3** Podłącz kabel zasilający do gniazdka, zdejmij podstawkę pod filiżankę i umieść pusty pojemnik (o pojemności co najmniej 1 l / 34 fl oz) pod wylotem kawy.

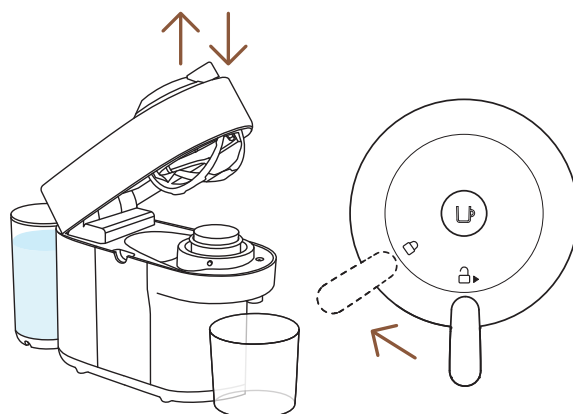

- 4** Otwórz i zamknij urządzenie. Upewnij się, że dźwignia znajduje się w pozycji zamkniętej.

- i** Kontrolka będzie migać podczas nagrzewania urządzenia. Zajmie to około 30 sekund. Gdy kontrolka zacznie świecić światłem ciągłym, urządzenie jest gotowe do pracy. Upewnij się, że żadna kapsułka nie jest włożona.

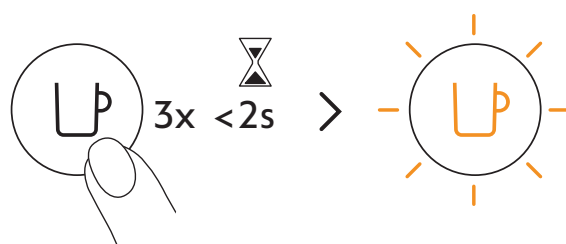

- 5** Naciśnij przycisk 3 razy w ciągu 2 sekund, aby rozpocząć płukanie. Gdy kontrolka świeci się na pomarańczowo, pozwól, aby procedura płukania zakończyła się automatycznie. Gdy kontrolka zaświeci się na biało, cykl jest zakończony.

- i** Powinno to zająć mniej niż 2 minuty, zanim rozpocznie się proces płukania i woda zacznie wypływać. Procedura ta może potrwać do 7 minut.

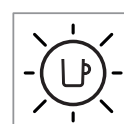
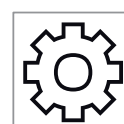
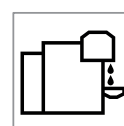
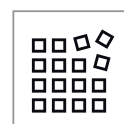
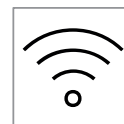

# PRZYGOTOWANIE KAWY

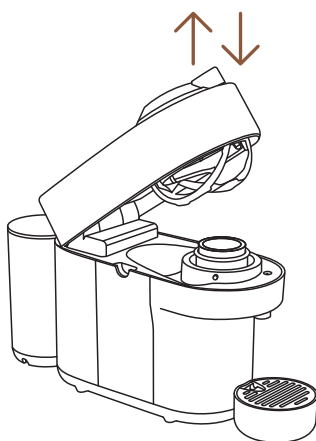

**1** Otwórz i zamknij urządzenie.

**i** Kontrolka przycisku kawy będzie migać podczas nagrzewania urządzenia. Gdy kontrolka zacznie świecić światłem ciągłym, urządzenie jest gotowe do użycia.

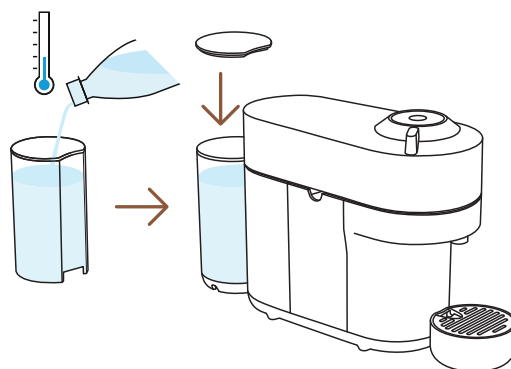

**2** Napełnij zbiornik świeżą wodą pitną i umieść go z powrotem na miejscu.

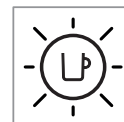
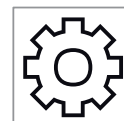
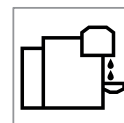
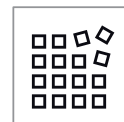
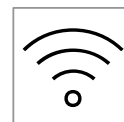

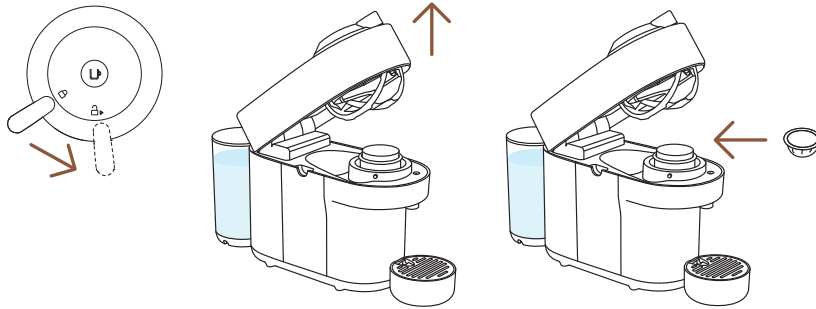

- 3** Odblokuj i otwórz całkowicie głowicę ekspresu, a następnie włóż kapsułkę Vertuo częścią wypukłą do dołu.

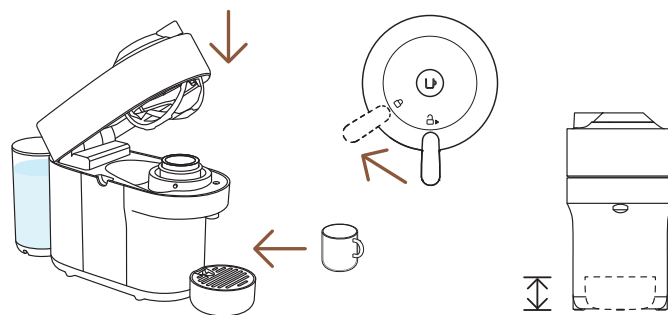

- 4** Zamknij pokrywę urządzenia i zablokuj, obracając dźwignię w lewo do pozycji zamkniętej, a następnie umieść filiżankę. Wysokość podstawki można dostosować do rozmiaru filiżanki.

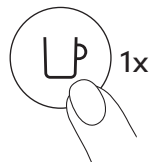

- 5** Rozpocznij parzenie kawy, naciskając przycisk jeden raz.

**UWAGA:** Aby prawidłowo korzystać z urządzenia, nie należy otwierać głowicy urządzenia podczas parzenia kawy; należy poczekać, aż przycisk kawy zacznie świecić na biało. Jeśli chcesz zatrzymać parzenie kawy wcześniej, naciśnij jeden raz przycisk kawy i poczekaj z otwarciem głowicy, aż urządzenie się zatrzyma.

- i** Ze względu na odczyt kodu, wstępne zwilżenie kawy i czas infuzji, minie chwila, zanim kawa zacznie wypływać. Ekspres automatycznie rozpozna włożoną kapsułkę i dobierze parametry przygotowania kawy oraz wielkość filiżanki, określone przez ekspertów **Nespresso**, aby wydobyć z mieszanki kawy to, co najlepsze.

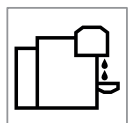

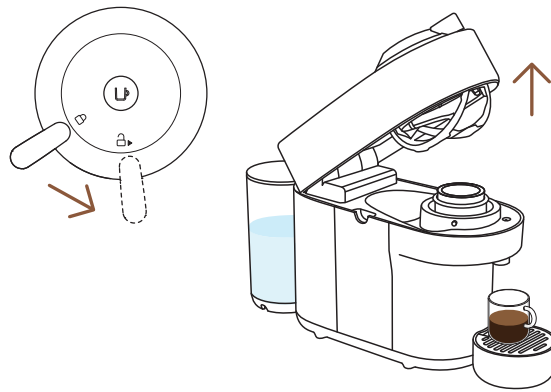

- 6** Gdy kawa będzie gotowa, otwórz głowicę ekspresu, obracając dźwignię w prawo do pozycji otwartej, aby automatycznie usunąć kapsułkę i ciesz się kawą.



- 7** Nie zapomnij poddać recyklingowi kapsułki **Nespresso**.\*

\* POZNAJ **NESPRESSO**. POZNAJ RECYKLING. Aby uzyskać więcej informacji na temat recyklingu kapsułek **Nespresso**, wejdź na [www.nespresso.com](http://www.nespresso.com)

## ODKRYJ NASZ TRYB COFFEE CREATIONS



Dzięki temu urządzeniu **Nespresso** oferuje specjalną funkcję koncentracji ekstraktów kawy w celu tworzenia własnych przepisów.

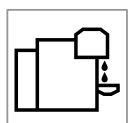





## DOSTOSUJ WIELKOŚĆ SWOJEJ KAWY

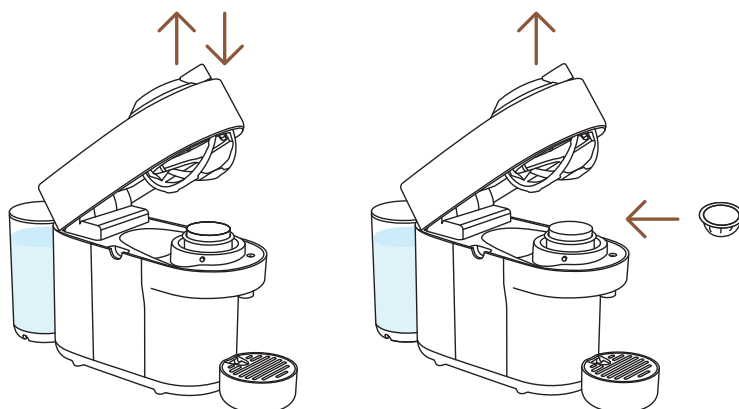

- 1** Otwórz i zamknij urządzenie. Przy włączonym urządzeniu, otwórz urządzenie i włóż kapsułkę, którą chcesz zaprogramować.

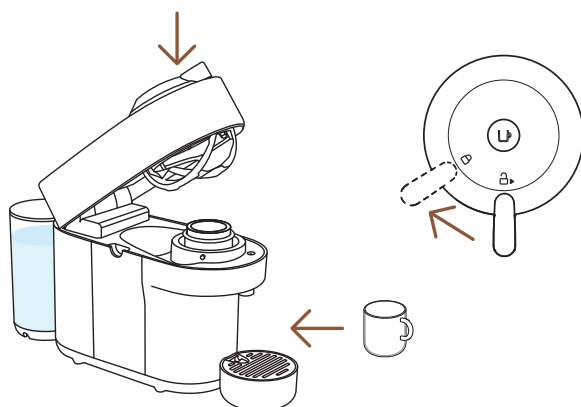

- 2** Zamknij głowicę urządzenia, obróć dźwignię w lewo do pozycji zamkniętej i umieść filiżankę.

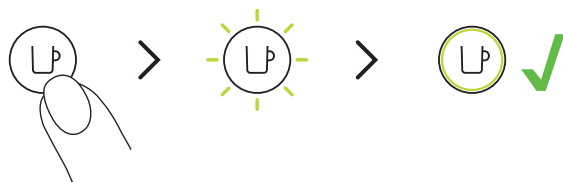

- 3** Naciśnij i przytrzymaj przycisk, puszczając go na kilka sekund przed osiągnięciem żądanej ilości. Nowa objętość wody jest teraz zaprogramowana dla typu kapsułki używanego podczas ustawiania.

- i** Programowanie jest indywidualne dla każdego rodzaju kapsułki. Wielkość filiżanek można zaprogramować od 20 ml do 535 ml.

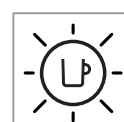
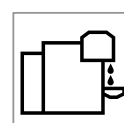
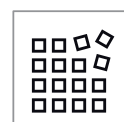
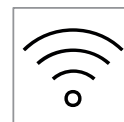

**UWAGA:** Aby prawidłowo korzystać z urządzenia, nie należy otwierać głowicy urządzenia podczas parzenia kawy; należy poczekać, aż przycisk kawy zacznie świecić na biało. Jeśli chcesz zatrzymać parzenie kawy wcześniej, naciśnij jeden raz przycisk kawy i poczekaj z otwarciem głowicy, aż urządzenie się zatrzyma.

**UWAGA:** Po zaprogramowaniu przez użytkownika objętości dla danego typu kapsułki, za każdym razem, gdy zostanie ona włożona do ekspresu, przygotowana zostanie według objętości zaprogramowanej przez użytkownika. Jeśli chcesz powrócić do domyślnych parametrów, zapoznaj się z paragrafem **“Przywracanie ustawień fabrycznych”**.

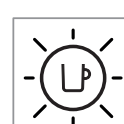
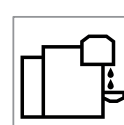
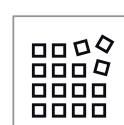
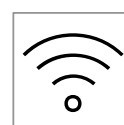

## CZYSZCZENIE

Ekspres należy czyścić co miesiąc, gdy wewnątrz głowicy urządzenia zaczną gromadzić się resztki kawy lub po długim okresie nieużywania.

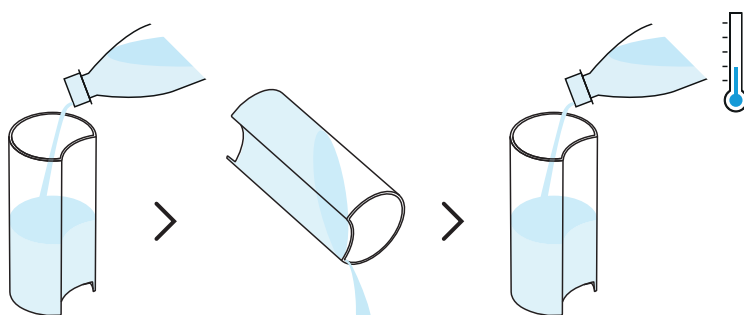

- 1** Opłucz i umyj zbiornik na wodę oraz pokrywę przed napełnieniem go świeżą wodą pitną.

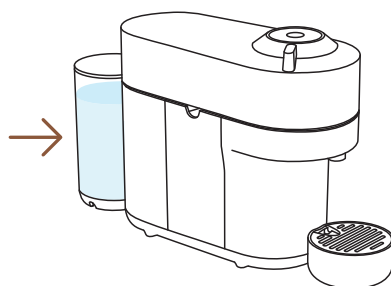

- 2** Umieść zbiornik wody z powrotem w urządzeniu.

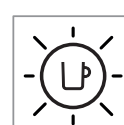
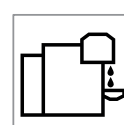
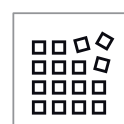
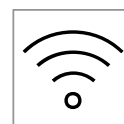

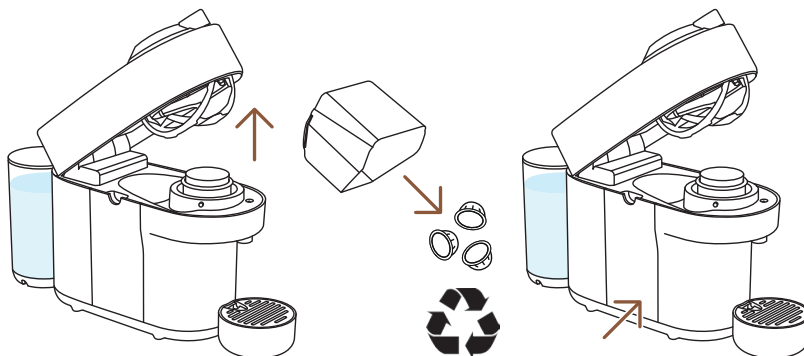

- 3** Przy włączonym urządzeniu, odblokuj i otwórz urządzenie, a następnie pozwól na usunięcie zużytej kapsułki. Opróżnij i wypłucz pojemnik na kapsułki oraz tackę ociekową, a następnie włóż je z powrotem na miejsce. Nie zapomnij poddać recyklingowi kapsułki **Nespresso**.\*

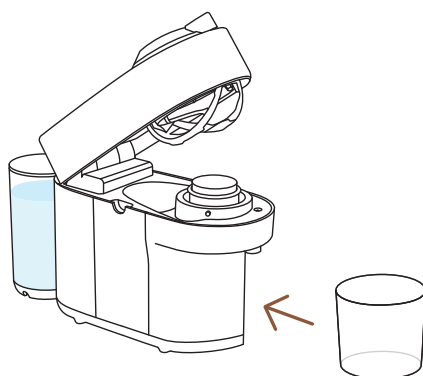

- 4** Zdejmij podstawkę pod filiżankę i umieść pusty pojemnik (o pojemności co najmniej 1 l) pod wylotem kawy.

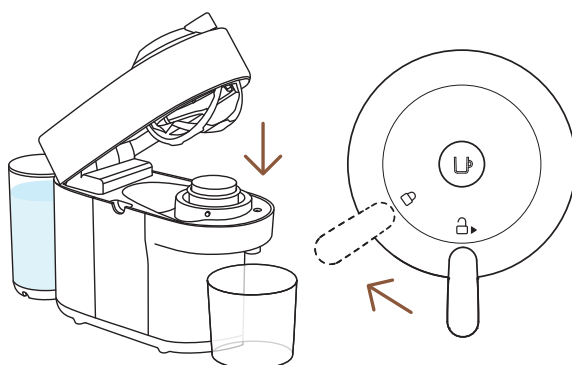

- 5** Zamknij głowicę urządzenia i obróć dźwignię w lewo do pozycji zamkniętej. Przed rozpoczęciem procedury płukania należy upewnić się, że w urządzeniu nie znajdują się żadne kapsułki.

\* POZNAJ **NESPRESSO**. POZNAJ RECYKLING. Aby uzyskać więcej informacji na temat recyklingu kapsułek **Nespresso**, wejdź na [www.nespresso.com](http://www.nespresso.com)

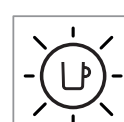
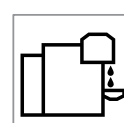
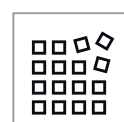
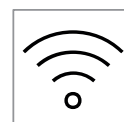

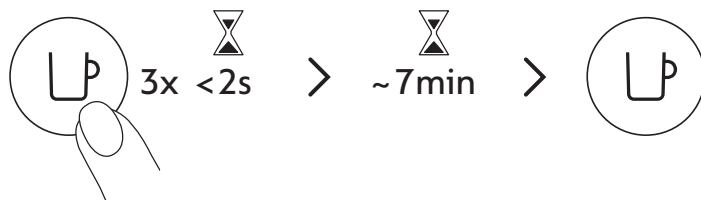

**6** Naciśnij przycisk 3 razy w ciągu 2 sekund, aby rozpocząć płukanie. Gdy kontrolka miga na pomarańczowo, pozwól, aby procedura płukania zakończyła się automatycznie.

**i** Powinno to zająć mniej niż 2 minuty, zanim rozpocznie się proces płukania i zacznie płynąć woda. Operacja ta może potrwać do 7 minut i zatrzyma się automatycznie po zakończeniu cyklu. Procedura może zostać zatrzymana w dowolnym momencie poprzez naciśnięcie przycisku.

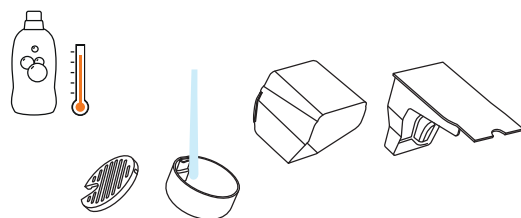

**7** Umyj pojemnik na kapsułki, podstawkę pod filiżankę i tackę ociekową pod gorącą wodą z dodatkiem łagodnego, bezzapachowego detergentu.

**UWAGA:** Nie używaj silnych lub ściernych środków czyszczących ani rozpuszczalników. Nie wkładaj urządzenia do zmywarki. Nigdy nie zanurzaj urządzenia lub jego części w wodzie.

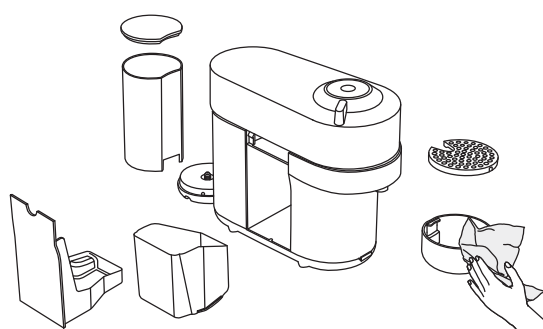

**8** Osusz świeżym, czystym ręcznikiem.

**UWAGA:** Regularnie czyść wylot kawy czystą, wilgotną ściereczką. Do czyszczenia urządzenia należy zawsze używać miękkich ściereczek.

**UWAGA:** Woda może zbierać się wewnątrz głowicy urządzenia. W takim przypadku należy osuszyć widoczne części czystą, suchą ściereczką.

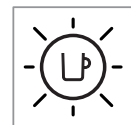
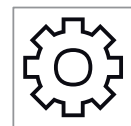
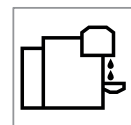
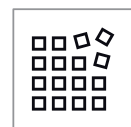
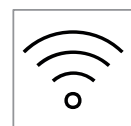

## ODKAMIENIANIE

Odkamienianie ekspresu zapewni jego prawidłowe działanie przez cały okres eksploatacji i sprawi, że doznania z picia kawy będą tak samo nieporównywalne, jak pierwszego dnia. Urządzenie zasygnalizuje konieczność usunięcia kamienia, migając 3 razy na pomarańczowo, a następnie na biało.



**i** Procedura odkamieniania trwa około 20 minut i nie **może być przerwana**.

**UWAGA:** Przed rozpoczęciem należy uważnie przeczytać instrukcje dotyczące odkamieniania.

### Potrzebne będą:

- Zestaw do odkamieniania dostępny na [www.nespresso.com](http://www.nespresso.com)
- Pusty pojemnik (o pojemności 1 l)

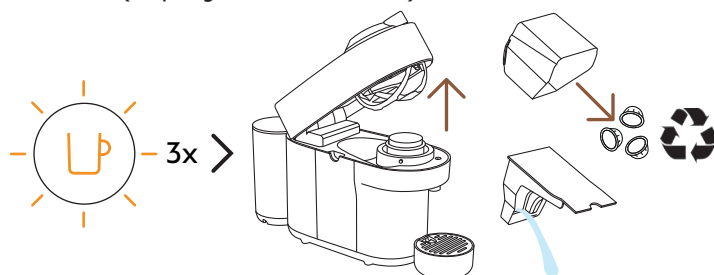

**1** Przycisk miga na pomarańczowo 3 razy: Odblokuj i otwórz głowicę urządzenia i pozwól na usunięcie zużytej kapsułki. Opróżnij pojemnik na kapsułki i tackę ociekową i umieść je z powrotem w urządzeniu. Nie zapomnij poddać recyklingowi kapsułki **Nespresso**.\*

\* POZNAJ **NESPRESSO**. POZNAJ RECYKLING. Aby uzyskać więcej informacji na temat recyklingu kapsułek **Nespresso**, wejdź na [www.nespresso.com](http://www.nespresso.com)

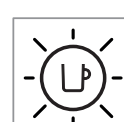
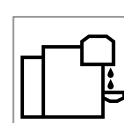
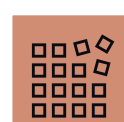
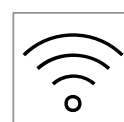

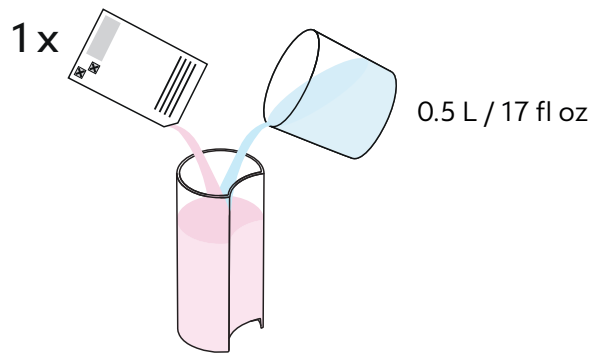

- 2** Napełnij zbiornik na wodę 0,5 l wody i dodaj 1 saszetkę środka do odkamieniania **Nespresso**.

**UWAGA:** Należy pamiętać, że roztwór odkamieniający może być szkodliwy. Unikać kontaktu z oczami, skórą i powierzchniami.

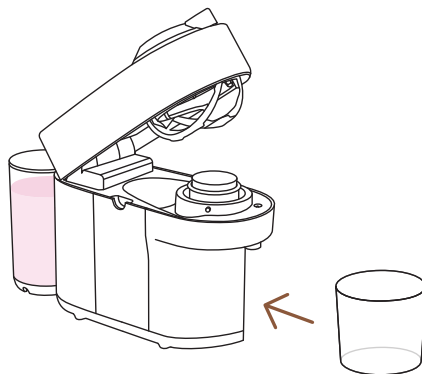

- 3** Zdejmij podstawkę pod filiżankę i umieść pusty pojemnik (o pojemności co najmniej 1 l) pod wylotem kawy.

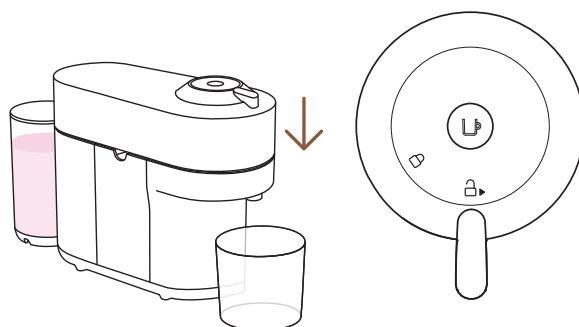

- 4** Przy włączonym urządzeniu zamknij głowicę urządzenia i ustaw dźwignię w pozycji blokady.

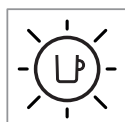
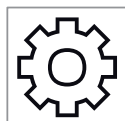
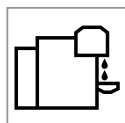
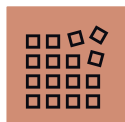
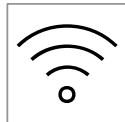

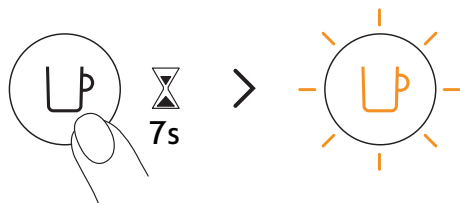

- 5** Przytrzymaj przycisk przez co najmniej 7 sekund lub do momentu zgaśnięcia kontrolki. Przycisk zacznie szybko migać na pomarańczowo.

**UWAGA:** Masz teraz 45 sekund na przejście do trybu odkamieniania, w przeciwnym razie urządzenie powróci do trybu przygotowania kawy.

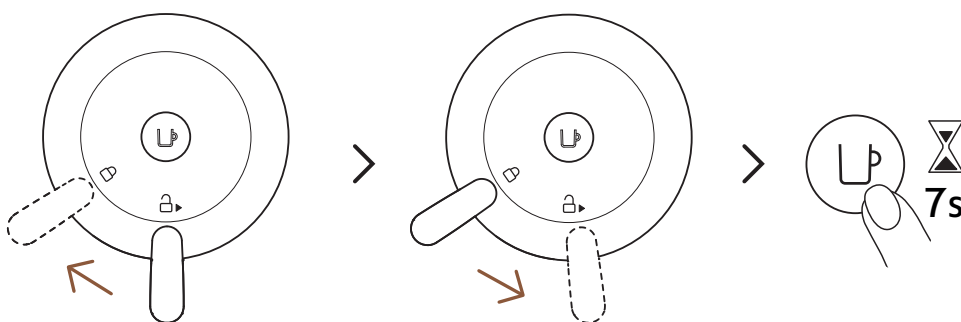

- 6** Zablokuj głowicę maszyny, obracając dźwignię w lewo do symbolu zamkniętej, a następnie odblokuj dźwignię, obracając ją w prawo do pozycji otwartej. Ponownie naciśnij i przytrzymaj przycisk przez około 7 sekund lub do momentu zgaśnięcia kontrolki. Przycisk zacznie szybko migać na pomarańczowo.

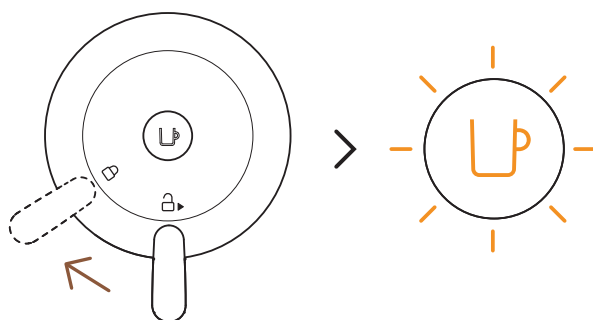

- 7** Aby przejść do trybu odkamieniania, zablokuj urządzenie, obracając dźwignię w lewo do pozycji blokady. Kontrolka powinna nadal szybko migać na pomarańczowo. Oznacza to, że urządzenie weszło w tryb odkamieniania.

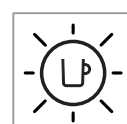
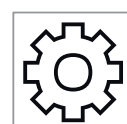
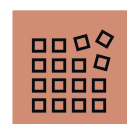
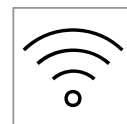



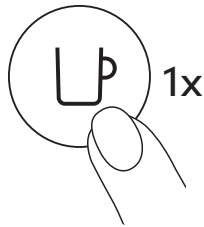

- 8** Naciśnij przycisk kawy jeden raz, aby rozpocząć proces odkamieniania. Kontrolka będzie migać na pomarańczowo przez cały czas trwania procesu.
- i** Urządzenie zatrzyma się automatycznie po zakończeniu pierwszej fazy odkamieniania.

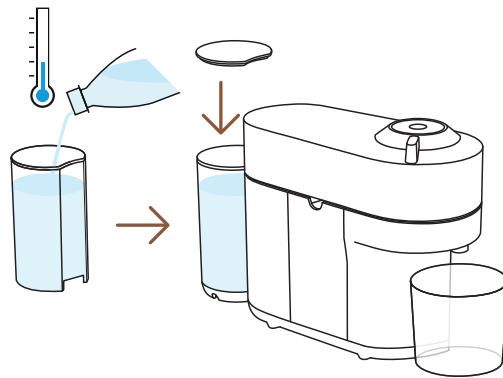

- 9** Po zakończeniu procesu odkamieniania należy przepłukać urządzenie. Dokładnie wypłucz zbiornik na wodę i tackę ociekową. Napełnij zbiornik świeżą wodą pitną i umieść go z powrotem na miejscu. Opróżnij pojemnik i umieść go z powrotem pod wylotem kawy.

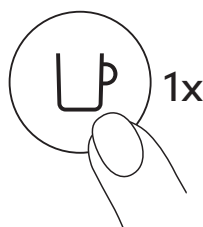

- 10** Naciśnij przycisk, aby przepłukać urządzenie. Gdy przycisk przestanie szybko migać i zacznie świecić światłem ciągłym, procedura odkamieniania zostanie zakończona.
- i** Urządzenie zatrzyma się automatycznie po zakończeniu procedury.

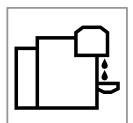
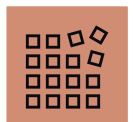

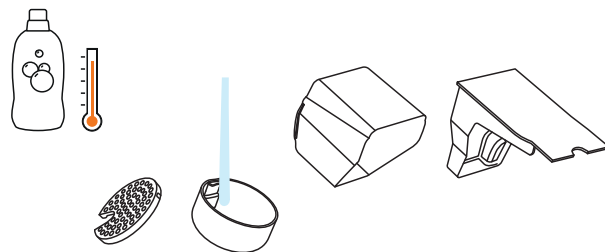

- 11** Umyj pojemnik na kapsułki, podstawkę pod filiżankę i tackę ociekową gorącą wodą z dodatkiem łagodnego, bezzapachowego detergentu.

**UWAGA:** Nie używaj silnych lub ściernych środków czyszczących ani rozpuszczalników. Nie wkładaj urządzenia do zmywarki. Nigdy nie zanurzaj urządzenia lub jego części w wodzie.

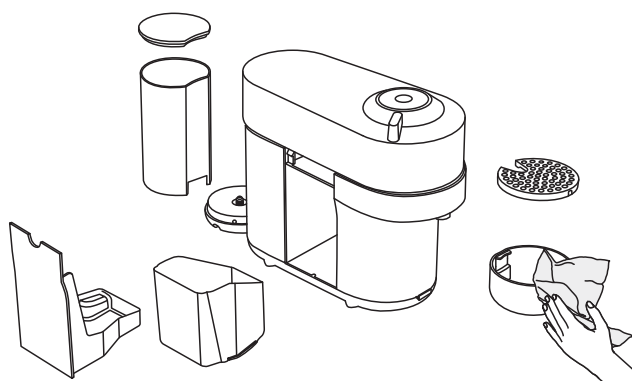

- 12** Osusz urządzenie czystym i świeżym ręcznikiem. Przed użyciem pozostaw urządzenie do wyschnięcia na 10 minut.

**UWAGA:** Podczas czyszczenia, wewnątrz głowicy urządzenia może gromadzić się woda. Jeśli tak się stanie, należy osuszyć widoczne części czystą, suchą ściereczką.

**UWAGA:** Urządzenie może przejść do trybu odkamieniania dopiero po zaparzeniu 30 lub więcej kaw.

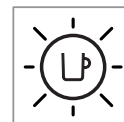
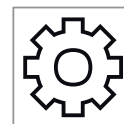
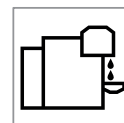
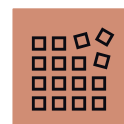
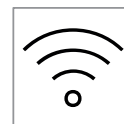

## OPRÓŻNIANIE EKSPRESU

Opróżnianie ekspresu jest procesem, który można wykonać przed okresem nieużywania, w celu ochrony przed mrozem lub przed wysłaniem urządzenia do naprawy.

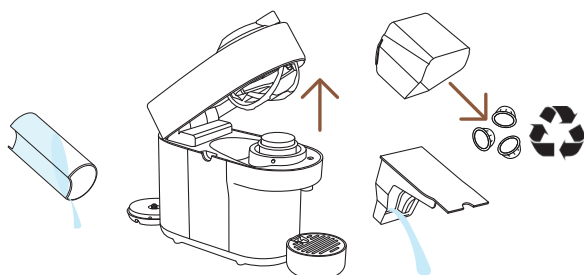

- 1** Opróżnij zbiornik wody, otwórz głowicę urządzenia i pozwól na usunięcie zużytej kapsułki. Opróżnij pojemnik na kapsułki i tackę ociekową. Nie zapomnij poddać recyklingowi kapsułki **Nespresso**.\*

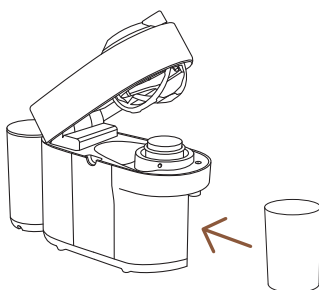

- 2** Umieść je z powrotem w urządzeniu, odłącz podstawkę pod filiżankę i umieść pusty pojemnik (0,5 l / 17 fl oz) pod wylotem kawy.

\* POZNAJ **NESPRESSO**. POZNAJ RECYKLING. Aby uzyskać więcej informacji na temat recyklingu kapsułek **Nespresso**, wejdź na [www.nespresso.com](http://www.nespresso.com)

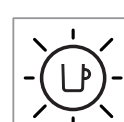
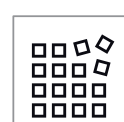
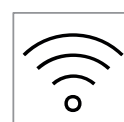

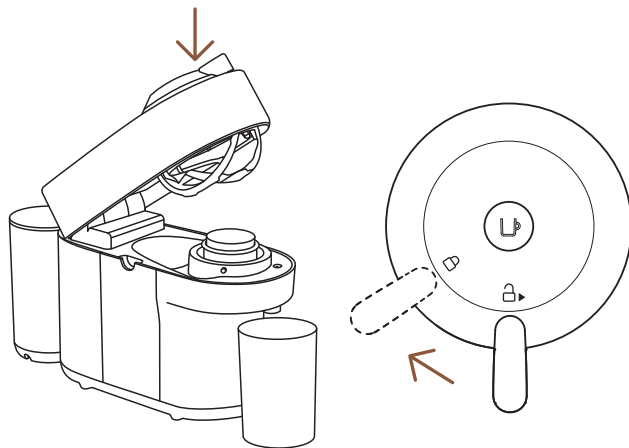

- 3** Przy podłączonym i włączonym urządzeniu otwórz i zamknij głowicę urządzenia i obróć dźwignię do pozycji zamkniętej.

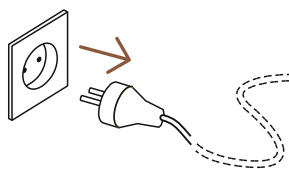

- 4** Odłącz ekspres od zasilania.

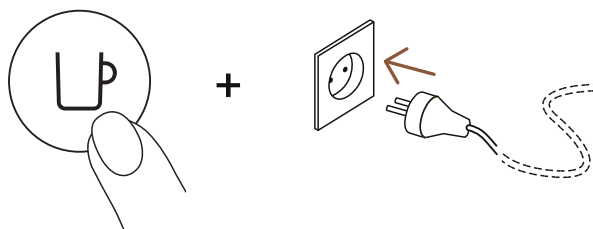

- 5** Naciśnij i przytrzymaj przycisk podczas podłączania.

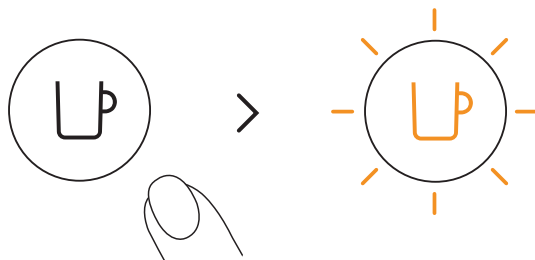

- 6** Puść przycisk. Wskaźnik zacznie migać na pomarańczowo i rozpocznie się proces opróżniania.

- i** Zakończenie procesu opróżniania zajmie urządzeniu około 30 sekund. Urządzenie wyłączy się automatycznie, gdy jest opróżnione z wody.

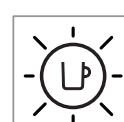
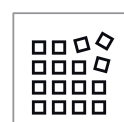
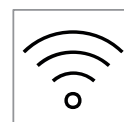

## PRZYWRACANIE USTAWIEŃ FABRYCZNYCH

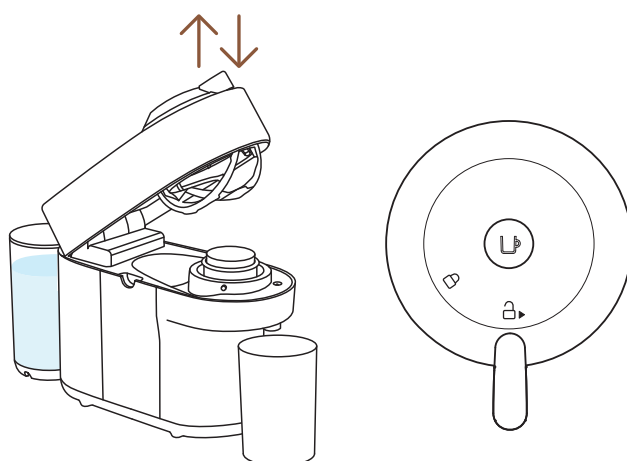

- 1 Po podłączeniu urządzenia do zasilania otwórz, a następnie zamknij głowicę urządzenia przed pozostawieniem dźwigni w pozycji **odblokowania**.

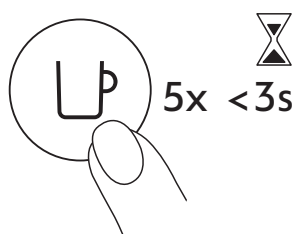

- 2 Naciśnij przycisk 5 razy w ciągu 3 sekund. Urządzenie jest teraz zaprogramowane zgodnie z ustawieniami fabrycznymi.

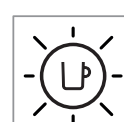
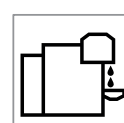
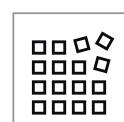
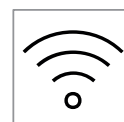

## OBJAŚNIENIE PODŚWIETLANIA PRZYCISKU

Chcesz dowiedzieć się więcej o migającym Vertuo Pop?  
Zapraszamy do obejrzenia poniższego filmu:

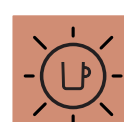
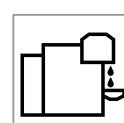
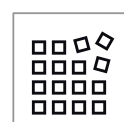
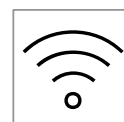

## ROZWIĄZYWANIE PROBLEMÓW

### Brak podświetlenia przycisku.

- Ekspres wyłączył się automatycznie; naciśnij przycisk lub „ODBLOKUJ” urządzenie.
- Sprawdź zasilanie, wtyczkę, napięcie i bezpiecznik.

### Ekspres nie nalewa kawy ani wody.

- Sprawdź, czy zbiornik na wodę jest napełniony.
- Sprawdź, czy nowa kapsułka jest włożona w prawidłowej pozycji, czy uchwyt jest prawidłowo zablokowany i naciśnij przycisk, aby rozpocząć.
- W razie konieczności przeprowadź odkamienianie ekspresu.
- Otwórz górną część ekspresu, aby kapsułka mogła zostać usunięta. Następnie przeprowadź czyszczenie zgodnie z instrukcją czyszczenia.

### Kawa nie jest wystarczająco gorąca.

- Ogrzej wstępnie filiżankę gorącą wodą pitną z kranu.
- W razie konieczności przeprowadź odkamienianie ekspresu.

### Wyciek lub nietypowy wpływ kawy.

- Sprawdź, czy zbiornik na wodę jest prawidłowo umieszczony.
- W razie konieczności przeprowadź odkamienianie ekspresu.

### Ekspres się wyłącza.

- Aby zaoszczędzić energię, ekspres wyłącza się automatycznie po 2 minutach nieużywania.
- Urządzenie można wyłączyć ręcznie w dowolnym momencie (gdy nie jest używane), naciskając i przytrzymując przycisk przez 3 sekundy.

### W filiżance znajdują się fusy z kawy.

- Przeprowadź dwukrotnie procedurę czyszczenia.
- Zob. punkt „Czyszczenie”.

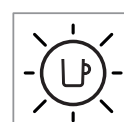
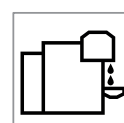
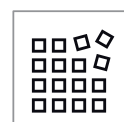
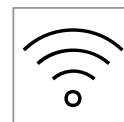

**Ekspres nie uruchamia się i przycisk jest podświetlony na stałe. Jeżeli podświetlenie miga, zobacz następane punkty.**

**Ekspres nie uruchamia się i podświetlenie przycisku miga na przemian – 1 mignięcie i 1 pauza.**

**Światło miga, a ekspres działa.**

**Ekspres nie uruchamia się i podświetlenie przycisku miga na przemian – 1 mignięcie i 1 pauza.**

- Upewnij się, że uchwyt jest prawidłowo zablokowany.
- Jeżeli chcesz zaparzyć kawę lub Espresso, sprawdź, czy nowa kapsułka jest włożona w prawidłowej pozycji, czy uchwyt jest prawidłowo zablokowany i naciśnij przycisk, aby rozpocząć.
- W przypadku czyszczenia, odkamieniania lub opróżniania układu sprawdź, czy nie jest włożona żadna kapsułka, a następnie zamknij i zablokuj urządzenie i naciśnij przycisk, aby rozpocząć jedną z tych operacji.

- Napełnij zbiornik na wodę i naciśnij przycisk, aby rozpocząć.
- Upewnij się, że uchwyt jest prawidłowo zablokowany.

- Jeśli kawa płynie normalnie, oznacza to, że ekspres działa prawidłowo.
- Jeśli płynie tylko woda, ekspres informuje użytkownika o konieczności przeprowadzenia czyszczenia, odkamieniania lub opróżniania układu. Zapoznaj się z odpowiednim rozdziałem.
- Wyłącz ekspres, naciskając przycisk przez 3 sekundy, a następnie naciśnij go jeszcze raz, aby ponownie uruchomić ekspres. Odczekaj około 20 minut, aby urządzenie mogło ostygnąć po intensywnym użytkowaniu.

- Potrzeba trochę czasu, zanim wypłynie kawa (z powodu odczytu kodu kreskowego i wstępnego zwilżenia kawy).
- Sprawdź, czy nowa kapsułka jest włożona w prawidłowej pozycji, czy uchwyt jest prawidłowo zablokowany i naciśnij przycisk, aby rozpocząć.
- Napełnij zbiornik na wodę i naciśnij przycisk, aby rozpocząć.
- Wyłącz ekspres, naciskając przycisk przez 3 sekundy, a następnie naciśnij go jeszcze raz, aby ponownie uruchomić ekspres. Odczekaj około 20 minut, aby urządzenie mogło ostygnąć po intensywnym użytkowaniu.

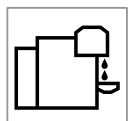
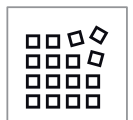



**Światło miga naprzemiennie – 2 mignięcia i 1 pauza w sposób ciągły. Ekspres nie działa.**

- Podczas normalnego przygotowywania kawy/Espreso:
  - 1) Odblokuj uchwyt i otwórz górną część urządzenia, aby sprawdzić, czy świeża, nieuszkodzona kapsułka jest włożona w prawidłowej pozycji.
  - 2) Upewnij się, że uchwyt jest w pozycji „ZABLOKOWANEJ”.
  - 3) Sprawdź, czy zbiornik na wodę jest napełniony.
- Podczas odkamieniania, opróżniania i czyszczenia:
  - 1) Upewnij się, czy kapsułka jest odrzucona.
  - 2) Upewnij się, że uchwyt jest w pozycji „ZABLOKOWANEJ”.
- Podczas programowania objętości:
  - 1) Sprawdź, czy kapsułka została dobrze włożona.
  - 2) Zapoznaj się z odpowiednim rozdziałem.
- Jeśli problem nie ustąpi:
  - 1) Odblokuj uchwyt i otwórz pokrywę.
  - 2) Wymień kapsułę (w razie potrzeby).
  - 3) Odłącz przewód zasilający od gniazdka i podłącz urządzenie z powrotem do gniazdka po 10 sekundach.
  - 4) Zamknij górną część ekspresu i naciśnij przycisk, aby go włączyć, a następnie naciśnij go ponownie, aby rozpocząć zaparzanie.

Jeżeli problem się powtarza, skontaktuj się z **Nespresso**.

**Światło miga na przemian 3 razy, a następnie zapala się na stałe.**

- Wymagane odkamienianie: gdy pojawia się informacja o konieczności przeprowadzenia odkamieniania ekspres może być użyty tylko kilka razy, zanim konieczne będzie odkamienianie.

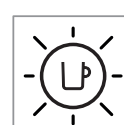
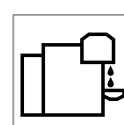
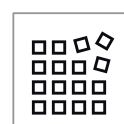
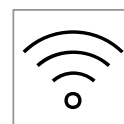

## SPECYFIKACJE

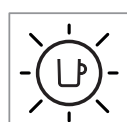
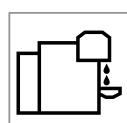
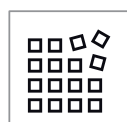
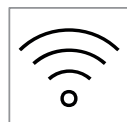

**Moc**

**~220–240 V, 50–60 Hz, 1300–1500 W**

**US, CA:** 120 V, 60 Hz, 1500 W

**MX:** 127 V~, 60 Hz, 1380 W

**Częstotliwość**

2.402–2.480 GHz

**Moc wyjściowa RF (EIRP)**

Bluetooth 4 dBm maks. e.i.r.p. i Wi-Fi  
<20 dMm maks. e.i.r.p.

**Tryb gotowości**

0.39 W/h

**Tryb oszczędzania energii**

Auto wył.: 2 min

**Czas nagrzewania**

30 sekund (głowica zamknięta i  
zablokowana)

**Regulowana podstawa  
pod filiżankę dla dużych  
kaw**

Pojedyncza pozycja do demontażu

**Długość kabla**

75 cm / 30 in

**Wymiary (szer. x gł. x  
wys.)**

13.6 x 42.6 x 25 cm / 5.3 x 16.7 x 9.8 in

**Waga**

3.5 kg / 7.72 lbs

**Pojemność zbiornika na  
wodę**

0.6 l / 20 fl oz

**Pojemność pojemnika na  
kapsułki**

8 kapsułek espresso lub 5 kapsułek do  
dużego kubka

## KOD URZĄDZENIA

**Nespresso**

**Breville**

**Delonghi**

GCV2, GDV2

BNV120, BNV150

ENV90

**Krups**

**Magimix**

XN9201, XN9204,  
XN9205, XN9211

M800

# НАЖМИТЕ И ВЫБЕРИТЕ НУЖНЫЙ ЯЗЫК

**RU**



**МЕРЫ ПРЕДОСТОРОЖНОСТИ**



**ОБЗОР**



**СОЕДИНЕНИЕ**



**ПЕРЕД ПЕРВЫМ ИСПОЛЬЗОВАНИЕМ**



**ПРИГОТОВЛЕНИЕ КОФЕ**



**НАСТРОЙКА ОБЪЕМОВ  
ПРИГОТОВЛЕНИЯ КОФЕ**



**ОЧИСТКА**



**ОЧИСТКА ОТ НАКИПИ**



**ОПУСТОШЕНИЕ СИСТЕМЫ**



**ВОССТАНОВЛЕНИЕ ЗАВОДСКИХ  
НАСТРОЕК**



**ЦВЕТОВЫЕ СИГНАЛЫ**



**УСТРАНЕНИЕ НЕИСПРАВНОСТЕЙ**



**ТЕХНИЧЕСКИЕ ХАРАКТЕРИСТИКИ**

## МЕРЫ ПРЕДОСТОРОЖНОСТИ

**ВНИМАНИЕ:** Внимательно изучите инструкцию с мерами предосторожности перед первым использованием кофемашины, чтобы избежать возможных повреждений и травм.

### УТИЛИЗАЦИЯ И ОХРАНА ОКРУЖАЮЩЕЙ СРЕДЫ

Данная кофемашина соответствует директиве ЕС 2012/19/ЕС. Упаковочные материалы и устройство содержат материалы, пригодные для переработки. Ваша кофемашина содержит ценные материалы, которые могут быть восстановлены или могут быть переработаны. Разделение утилизируемых отходов на различные типы облегчает переработку ценного сырья. Оставьте вашу кофемашину в пункте сбора. Вы можете получить информацию об утилизации у местных органов власти.

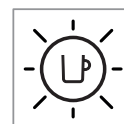
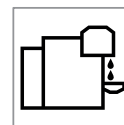
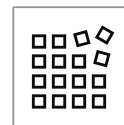
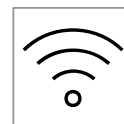

# ДЕТАЛИ И ЭЛЕМЕНТЫ УПРАВЛЕНИЯ

## ОБЗОР КОФЕМАШИНЫ

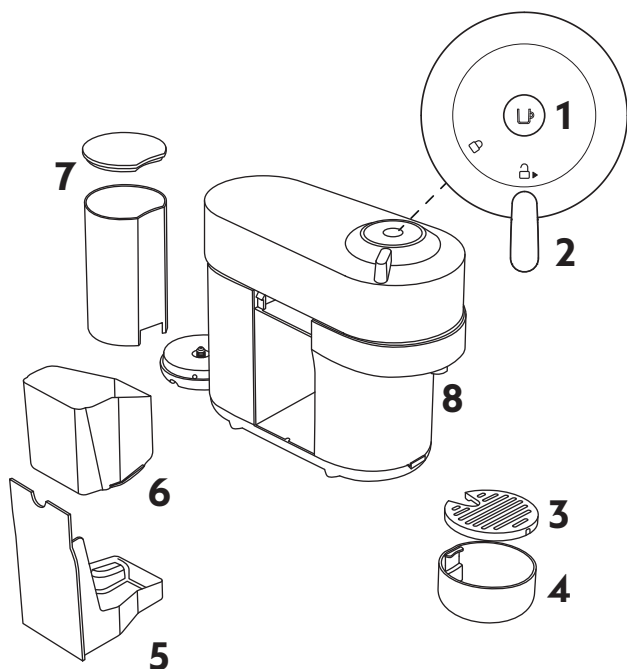

- 1 ВКЛ/ВЫКЛ и кнопка приготовления напитка
- 2 Рычаг блокировки/открытия варочного узла
- 3 Решетка подставки под чашку
- 4 Регулируемая подставка под чашку
- 5 Каплесборник
- 6 Контейнер для использованных кофе-капсул
- 7 Резервуар для воды с крышкой
- 8 Носик выдачи кофе

## СОДЕРЖИМОЕ УПАКОВКИ



- 1 Кофемашина
- 2 Приветственный набор капсул **Nespresso**
- 3 Приветственная брошюра **Nespresso**
- 4 Инструкция по безопасному использованию
- 5 Краткое руководство
- 6 Гарантийный талон

**i Распаковка:** на поверхности кофемашины может присутствовать пыль из-за переработанных материалов, используемых в упаковке. Это не опасно, просто протрите кофемашину мягкой тканью.

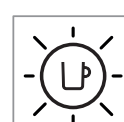
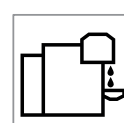
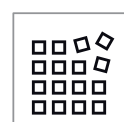
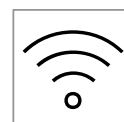

## ОТКРЫВАНИЕ/ЗАКРЫВАНИЕ

### ОТКРЫВАНИЕ

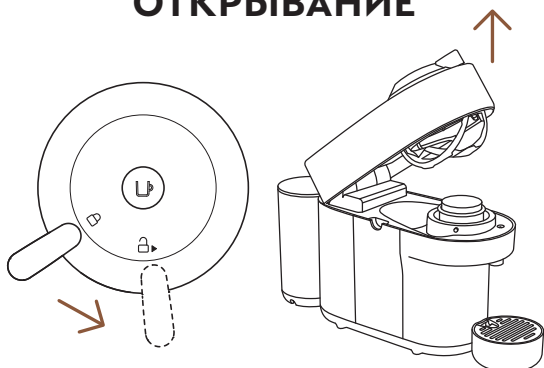

### ЗАКРЫВАНИЕ

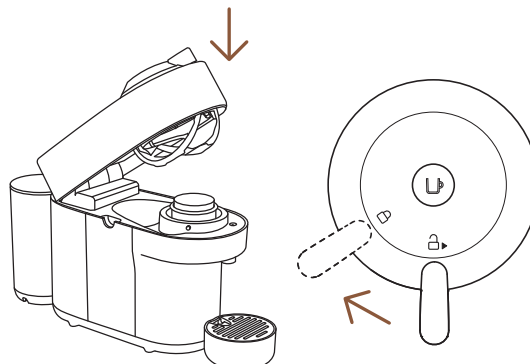

**ВНИМАНИЕ:** Никогда не открывайте варочный узел в процессе приготовления кофе, дождитесь, пока индикатор начнет постоянно гореть белым цветом. Если необходимо остановить процесс приготовления, нажмите один раз на кнопку приготовления кофе и дождитесь, пока процесс приготовления полностью не остановится. После этого можно открыть варочный узел.

## СИСТЕМА VERTUO

### СОВМЕСТИМОСТЬ КАПСУЛ



**S**

**Ristretto**

(25 мл)

**Espresso**

(40 мл)



**M**

**Double Espresso**

(80 мл)

**Gran Lungo**

(150 мл)



**L**

**Mug**

(230 мл)

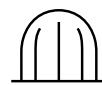

**XL**

**Alto, Cold Brew Style**

(335 мл)

**Carafe**

(535 мл)

### СОВМЕСТИМОСТЬ АКСЕССУАРОВ



Совместимость  
аксессуаров



**Ristretto**



**Espresso**



**Double Espresso**



**Gran Lungo**



**Mug (S)**



**Mug (M)**



**Reveal Glass**



Несовместимые аксессуары



**Mug (L)**



**Carafe**

Откройте для себя полную коллекцию аксессуаров на

[www.nespresso.com](http://www.nespresso.com)

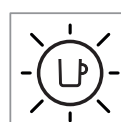
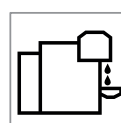
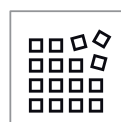
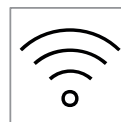

## ВКЛ/ВЫКЛ

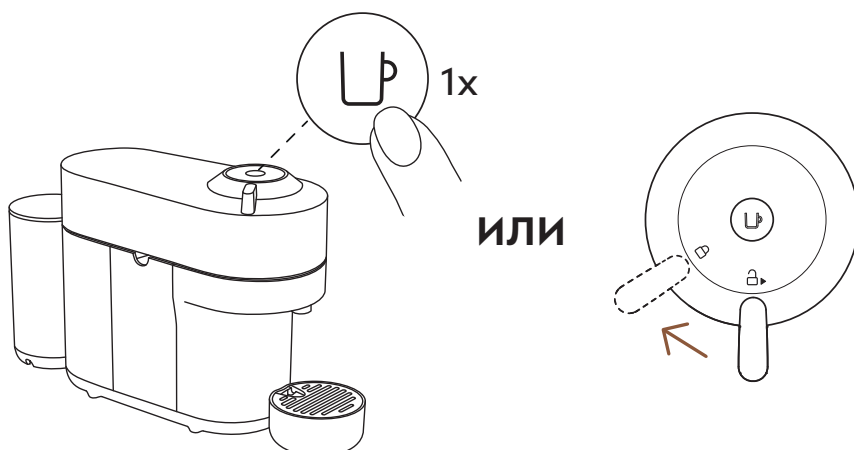
**ВКЛ**

После подключения кофемашины к розетке, включите ее, нажав один раз на кнопку, или повернув рычаг в положение "Заблокировано" (при закрытом варочном узле)

- i** В процессе разогрева кофемашины индикатор будет мигать примерно 30 секунд. Как только индикатор перестанет мигать, кофемашина готова к использованию.

 **или**  
**АВТОМАТИЧЕСКОЕ  
ВЫКЛЮЧЕНИЕ: 2 МИН**

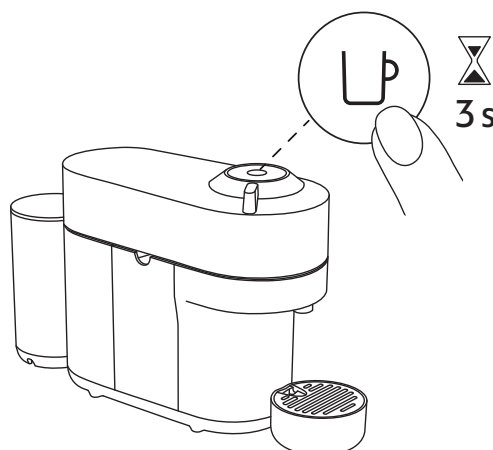
**ВЫКЛ**

Для энергосбережения кофемашина автоматически выключится через 2 минуты после последнего использования.

- i** Кофемашину можно отключить вручную в любой момент (но только не в момент приготовления кофе), нажав на кнопку и удерживая ее не менее 3-х секунд.

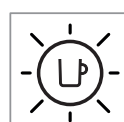
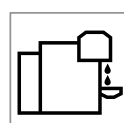
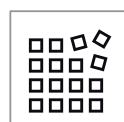
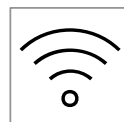

## СОЕДИНЕНИЕ

### ПОЧЕМУ ВАМ СЛЕДУЕТ ВЫПОЛНИТЬ СОЕДИНЕНИЕ ВАШЕЙ КОФЕМАШИНЫ VERTUO POP\*

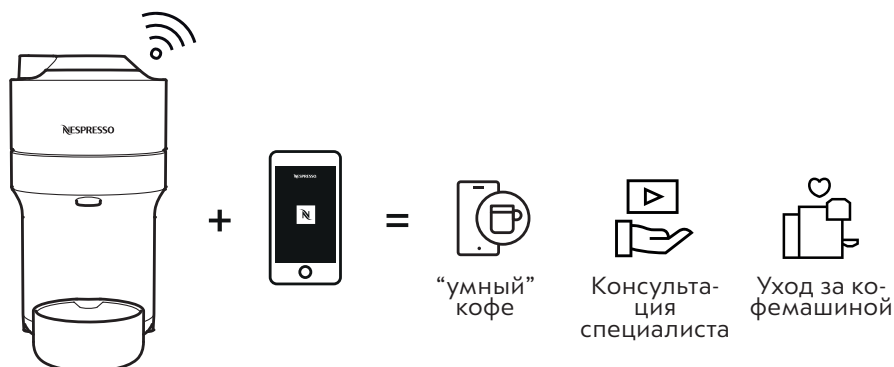

### ПРЕИМУЩЕСТВА, ПОЛУЧАЕМЫЕ ПРИ СОЕДИНЕНИИ КОФЕМАШИНЫ VERTUO POP

- **“умный” кофе:** Будьте всегда на шаг впереди, получая самую актуальную информацию о кофейных новинках **Nespresso**, а также ваша кофемашина всегда будет в актуальном состоянии.
- **Консультация специалиста:** Получить поддержку и простые информационные видео по миру кофе на вашем смартфоне.
- **Уход за кофемашиной:** Простое обслуживание благодаря пошаговым инструкциям по удалению накипи, промывке и очистке вашей кофемашины.

### КАК ПОДКЛЮЧИТЬ ВАШУ КОФЕМАШИНУ VERTUO POP?

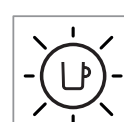
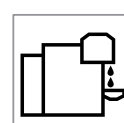
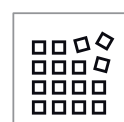





- 1** Загрузите или обновите приложение **Nespresso** App. После запустите его на вашем смартфоне или планшете. Далее, нажмите на иконку кофемашины в правом верхнем углу экрана.

**ИНФОРМАЦИЯ:** Для лучшего качества соединения и качества работы, рекомендуется подключать кофемашину напрямую к Wi-Fi роутеру, а не к точке доступа смартфона или планшета.

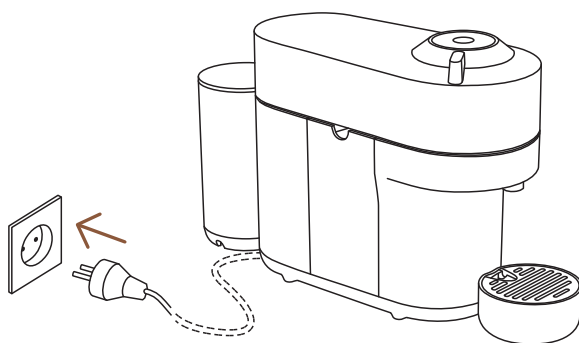

- 2** Подключите шнур питания в розетку.



- 3** Следуйте инструкциям приложения **Nespresso** App.

**ВНИМАНИЕ:** Сперва ознакомьтесь с инструкцией по безопасному использованию кофемашины во избежание поражения электрическим током. В розетке, куда подключается кофемашина, обязательно должен присутствовать контакт заземления.

- \* App Store® является товарным знаком Apple Inc., зарегистрированным в США и других странах.
- \*\* Google Play и логотип Google Play являются товарным знаком Google LLC.

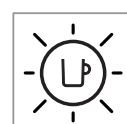
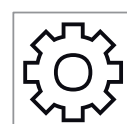
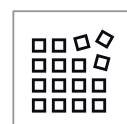

## ОТКЛЮЧЕНИЕ МОДУЛЯ BLUETOOTH И WI-FI

В кофемашине установлен модуль для подключения, который включен по умолчанию. С его помощью можно получить доступ к дополнительным функциям, расширяющим возможности кофемашины. Для отключения данного модуля, выполните следующее:

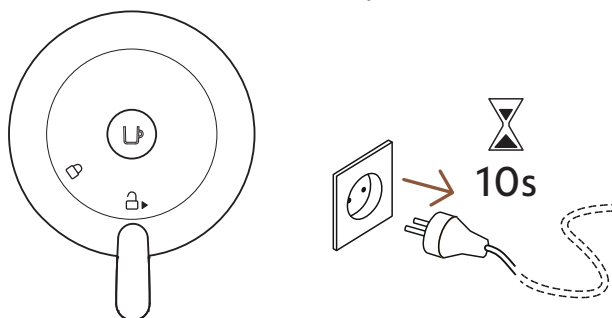

- 1 При закрытом варочном узле и рычаге варочного узла в позиции Разблокировано, отключите кофемашину от розетки не менее, чем на 10 секунд.

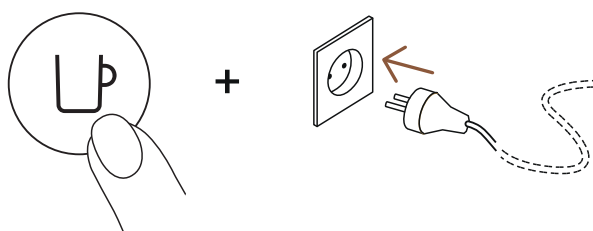

- 2 Нажмите и удерживайте кнопку, одновременно подключив кофемашину к сети. Индикатор кнопки мигнет оранжевым цветом, модуль подключений теперь отключен.
- i** Включение модуля осуществляется аналогичным образом. Индикатор кнопки мигнет белым цветом, что означает, модуль подключений теперь включен.

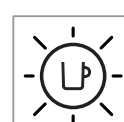
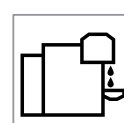
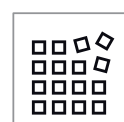

## ПЕРЕД ПЕРВЫМ ИСПОЛЬЗОВАНИЕМ

### ПЕРВАЯ ПРОМЫВКА

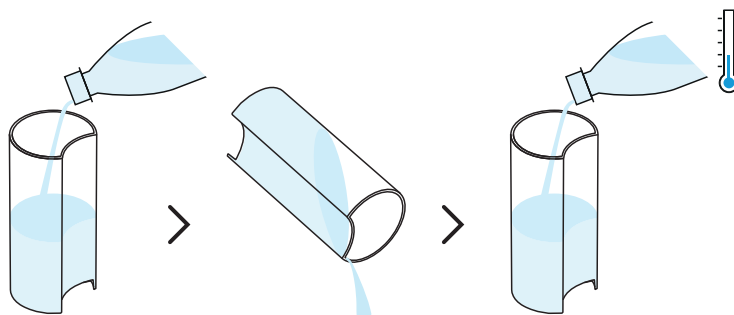

- 1** Промойте и протрите резервуар для воды и его крышку перед тем, как будете заливать свежую питьевую воду.

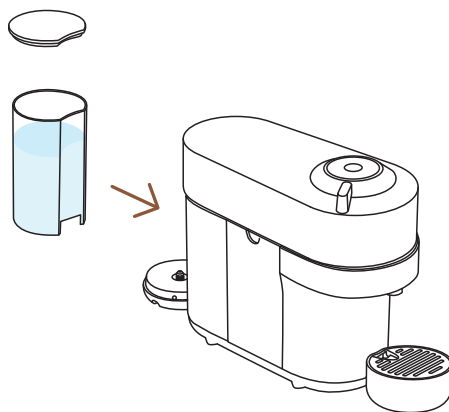

- 2** Закройте резервуар для воды крышкой и установите его на место, убедившись, что резервуар установлен корректно.

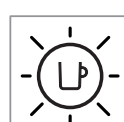
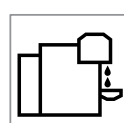
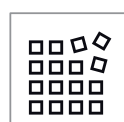
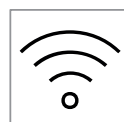

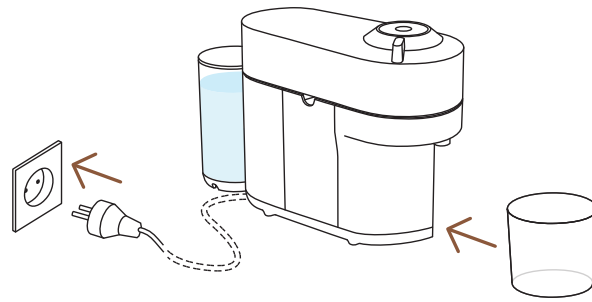

- 3** Подключите шнур электропитания в розетку, снимите подставку под чашку и установите пустой резервуар емкостью не менее 1 л под носик выдачи кофе.

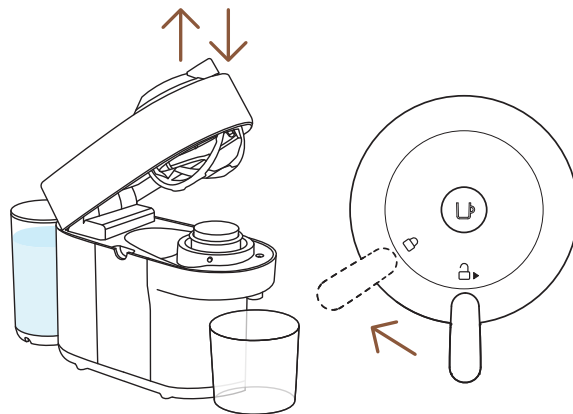

- 4** Откройте и закройте варочный узел. Убедитесь, что рычаг варочного узла полностью закрыт.

- i** Индикатор будет мигать, пока кофемашина будет разогреваться. Это займет примерно 30 секунд. Далее индикатор будет постоянно гореть белым цветом. Убедитесь, что в варочном узле нет капсулы.

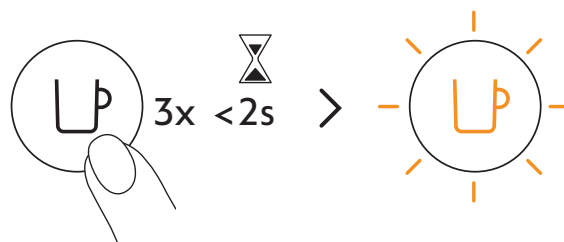

- 5** Для начала промывки нажмите кнопку 3 раза в течение 2х секунд Процедура промывки завершится автоматически, при этом в процессе промывки индикатор будет мигать оранжевым цветом. Когда индикатор перестанет мигать и будет гореть постоянно белым цветом, это будет означать, что процесс промывки завершен.

- i** Выход воды из носика должен начаться не более чем через 2 минуты с момента старта процесса промывки. Эта процедура может занять до 7 минут.



## ПРИГОТОВЛЕНИЕ КОФЕ

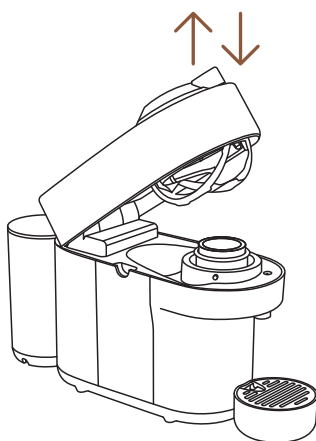

**1** Откройте и закройте варочный узел.

**i** Индикатор будет мигать, пока кофемашина будет разогреваться. Далее индикатор будет постоянно гореть, кофемашина готова к использованию.

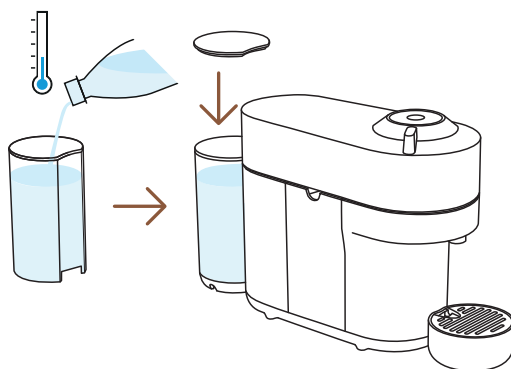

**2** Наполните резервуар свежей питьевой водой.

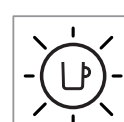
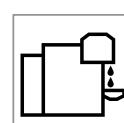
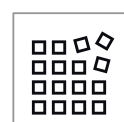
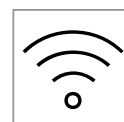

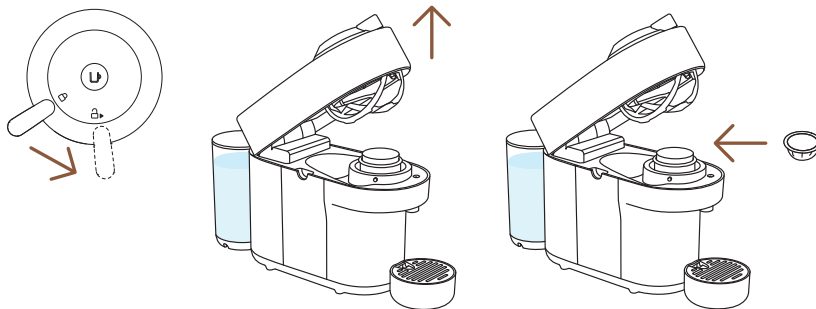

- 3** Разблокируйте и откройте полностью варочный узел и вставьте капсулу Vertuo выпуклой стороной вниз.

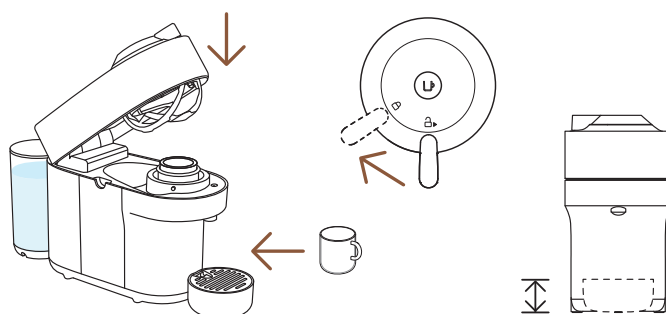

- 4** Закройте и заблокируйте варочный узел, повернув рычаг влево до упора и установите чашку под носик подачи кофе. Положение подставки под чашку можно отрегулировать по высоте в зависимости от объема чашки.

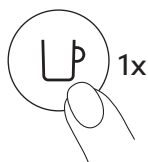

- 5** Запустите процесс приготовления кофе, нажав один раз на кнопку.

**ВНИМАНИЕ:** Никогда не открывайте варочный узел в процессе приготовления кофе, дождитесь, пока индикатор начнет постоянно гореть белым цветом. Если необходимо остановить процесс приготовления, нажмите один раз на кнопку приготовления кофе и дождитесь, пока процесс приготовления полностью не остановится. После этого можно открыть варочный узел.

- i** В связи с тем, что вначале происходит считывание штрих-кода капсулы, а затем процесс смачивания кофе, может пройти несколько секунд, прежде чем кофе пойдет из носика. Кофемашина автоматически распознает тип капсулы и выберет оптимальные параметры приготовления кофе и объем чашки, определенные экспертами **Nespresso** для каждого кофейного бленда.

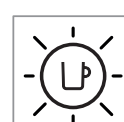
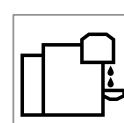
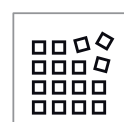
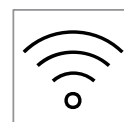

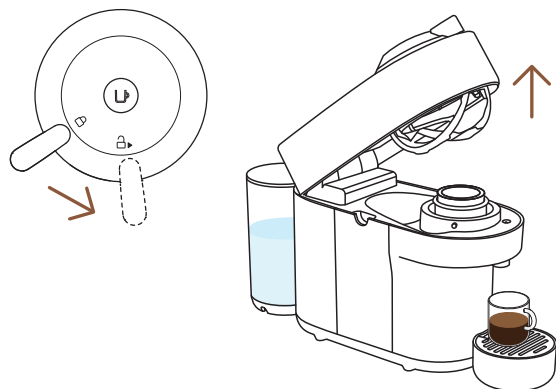

- 6** После окончания процесса приготовления кофе, откройте варочный узел, повернув рычаг против часовой стрелки. Кофе-капсула сбросится автоматически.

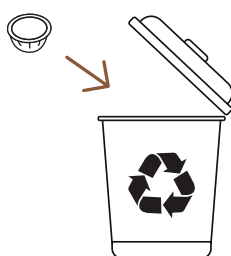

- 7** Не забудьте сдать использованные кофе-капсулы в переработку.\*

\* СДАВАЙТЕ КАПСУЛЫ **NESPRESSO** НА ПЕРЕРАБОТКУ. Для получения информации об утилизации использованных капсул **Nespresso** посетите сайт [www.nespresso.ru](http://www.nespresso.ru)

## ОТКРОЙТЕ ДЛЯ СЕБЯ РЕЖИМ COFFEE CREATIONS



С данной кофемашиной **Nespresso** предлагает вам набор дополнительных функций, чтобы вы могли создавать ваши индивидуальные кофейные рецепты.

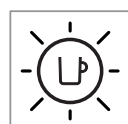
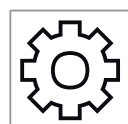
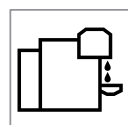
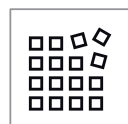
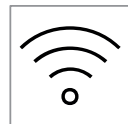

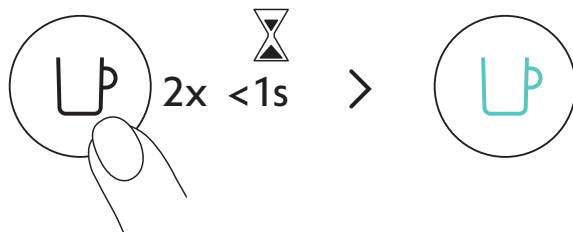

При включенной кофемашине, нажмите дважды на кнопку приготовления кофе. В процессе настройки и оптимизации выбранного рецепта с дополнительными ингредиентами (молоко, сливки, лед и т.д.) индикатор будет мигать бирюзовым цветом.

40 мл	80 мл	150 мл	230 мл	355 мл	535 мл
✓	✓	✓	✓	✗	✗
25 мл	40 мл	40 мл	80 мл		

Для получения наилучшего вкуса кофе, мы рекомендуем готовить рецепты Coffee+ только на объемах чашки по умолчанию. Для лучшего качества напитка, не рекомендуется использовать бленды формата XL (Alto Ambrato, Alto Onice), а также рецептуры Cold Brew Style & Carafe Pour Over Style.

**ИНФОРМАЦИЯ:** Для активации данного режима может понадобиться обновление программы вашей кофемашины через **Nespresso App**.



Более подробную информацию по процессу обновления программного обеспечения вашей кофемашины или капучинатора можно найти на [www.nespresso.com](http://www.nespresso.com)

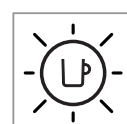
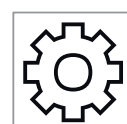
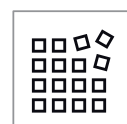
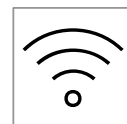



# НАСТРОЙКА ОБЪЕМОВ ПРИГОТОВЛЕНИЯ КОФЕ

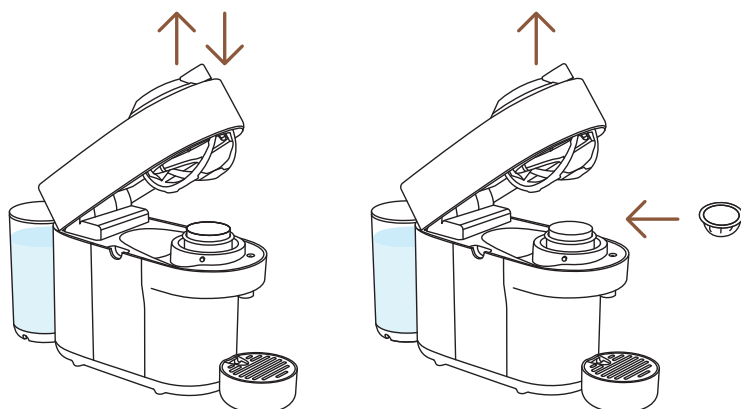

- 1** Откройте и закройте варочный узел. Включите кофемашину и вставьте капсулу того бленда, объем которого вы хотите настроить.

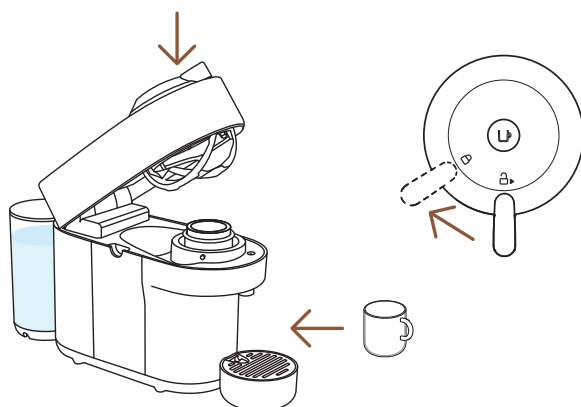

- 2** Закройте и заблокируйте варочный узел, повернув рычаг влево до упора и установите чашку под носик подачи кофе.

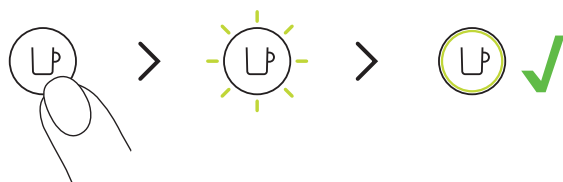

- 3** Нажмите и удерживайте кнопку до тех пор, пока желаемый объем не будет достигнут. Новый объем напитка теперь сохранен для конкретного бленда, для которого происходила настройка.

- i** Программирование специфично для каждого типа капсул. Объем может быть запрограммирован от 20 мл до 535 мл.

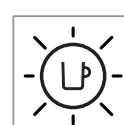
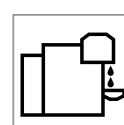
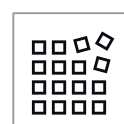
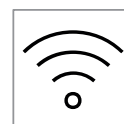

**ВНИМАНИЕ:** Никогда не открывайте варочный узел в процессе приготовления кофе, дождитесь, пока индикатор начнет постоянно гореть белым цветом. Если необходимо остановить процесс приготовления, нажмите один раз на кнопку приготовления кофе и дождитесь, пока процесс приготовления полностью не остановится. После этого можно открыть варочный узел.

**ВНИМАНИЕ:** После программирования объема кофе, при приготовлении конкретного бленда в дальнейшем будет осуществляться пролив запрограммированного ранее объема кофе. Если вы желаете сбросить ранее запрограммированные настройки объемов кофе, см. раздел **“Возврат к заводским настройкам”**.

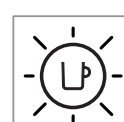
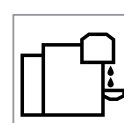
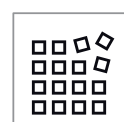
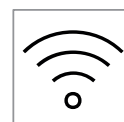

## ОЧИСТКА

Производите очистку вашей кофемашины ежемесячно; если в чашке начинает присутствовать кофейный жмых, либо после длительного периода без использования.

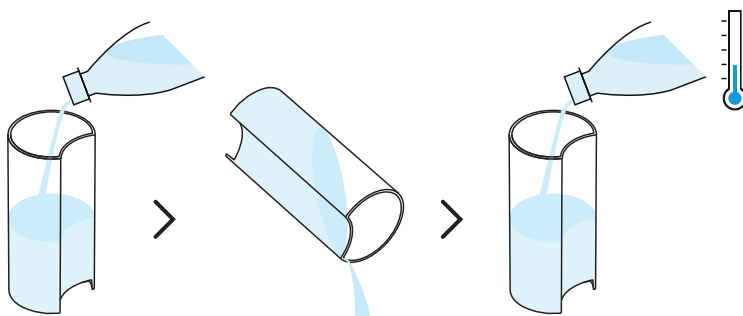

- 1** Промойте и протрите резервуар для воды и его крышку перед тем, как будете заливать свежую питьевую воду.

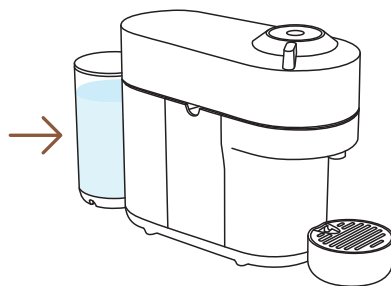

- 2** Установите резервуар на место, убедившись, что резервуар установлен корректно.

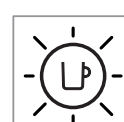
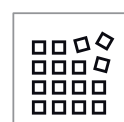
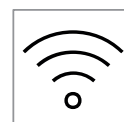

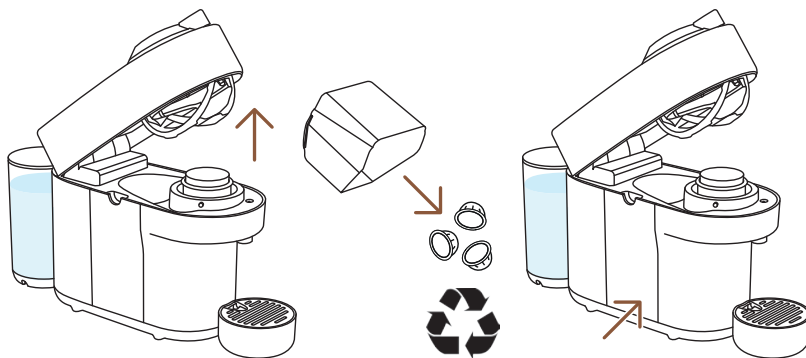

- 3** При включенной кофемашине, разблокируйте и откройте варочный узел, чтобы сбросить использованную кофе-капсулу. Опустошите и промойте контейнер для использованных капсул и каплесборник. Не забудьте сдать использованные кофе-капсулы в переработку.\*

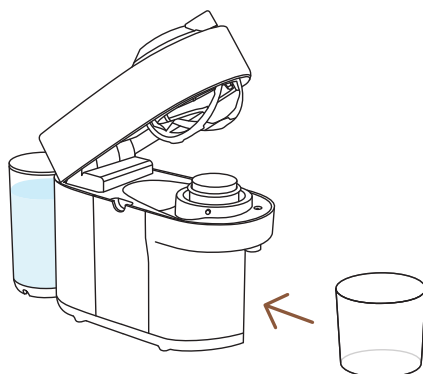

- 4** Снимите подставку под чашку и установите пустой резервуар емкостью не менее 1 л под носик выдачи кофе.

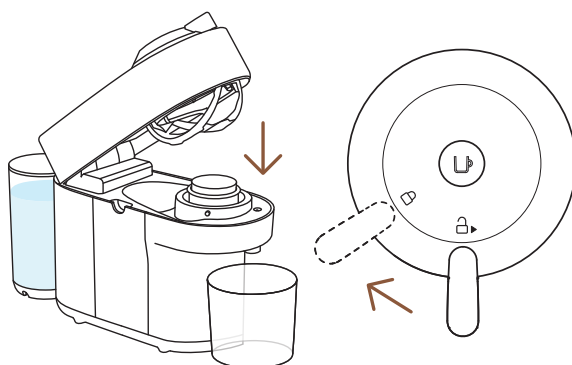

- 5** Закройте варочный узел и поверните рычаг влево до упора. Перед стартом процедуры очистки убедитесь, что в варочном узле нет капсулы.

\* СДАВАЙТЕ КАПСУЛЫ **NESPRESSO** НА ПЕРЕРАБОТКУ. Для получения информации об утилизации использованных капсул **Nespresso** посетите сайт [www.nespresso.ru](http://www.nespresso.ru)

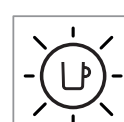
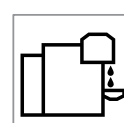
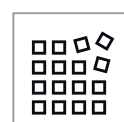
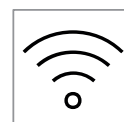

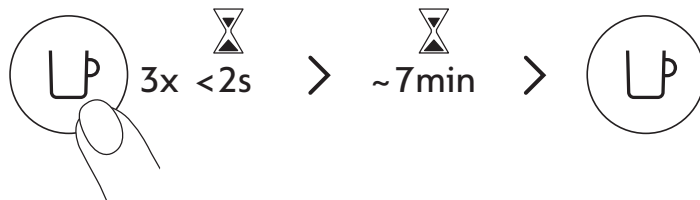

- 6** Для начала промывки нажмите кнопку 3 раза в течение 2х секунд Процедура промывки завершится автоматически, при этом в процессе промывки индикатор будет мигать оранжевым цветом.
- i** Выход воды из носика должен начаться не более чем через 2 минуты с момента старта процесса промывки. Эта процедура может занять до 7 минут и остановится автоматически по ее завершении. Процесс может быть прерван нажатием кнопки в любое время.

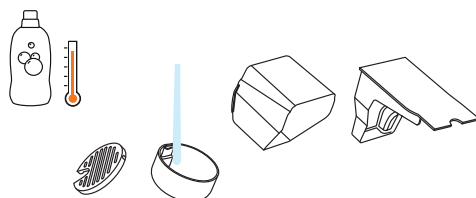

- 7** Промойте контейнер для капсул, подставку под чашку и каплесборник теплой водой с мягким моющим средством без запаха.

**ВНИМАНИЕ:** Не используйте сильное или абразивное моющее средство, а также растворители. Не допускается мыть кофемашину в посудомойке. Никогда не погружайте кофемашину полностью либо частично в воду.

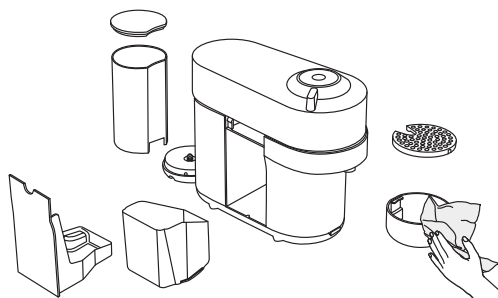

- 8** Насухо протрите все части при помощи чистого полотенца.

**ВНИМАНИЕ:** Регулярно очищайте носик выдачи кофе чистой влажной салфеткой. Для протирки кофемашины всегда используйте мягкие салфетки.

**ВНИМАНИЕ:** Внутри варочного узла может собираться некоторое количество воды, для ее удаления протрите внутренние части узла сухой салфеткой.

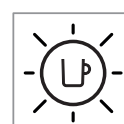
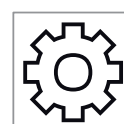
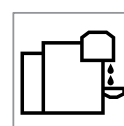
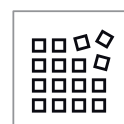
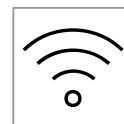

## ОЧИСТКА ОТ НАКИПИ

Очистка от накипи позволит кофемашине корректно работать весь срок, а также сохранить вкус кофе таким же, как и в первый день использования вашей кофемашины. При необходимости проведения очистки от накипи индикатор кофемашины будет три раза мигать оранжевым, а затем постоянно гореть белым цветом.



**i** Процесс очистки от накипи занимает приблизительно 20 минут и **не может быть остановлен.**

**ИНФОРМАЦИЯ:** Перед началом внимательно прочтите инструкцию по очистке от накипи.

### Вам понадобятся:

- Набор для очистки от накипи, доступен на [www.nespresso.com](http://www.nespresso.com)
- Пустой контейнер объемом не менее 1 л.

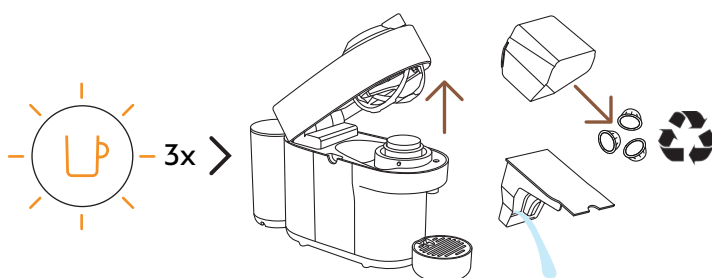

**1** При мигающем оранжевым цветом индикаторе (3 раза): Разблокируйте и откройте варочный узел, сбросьте использованную кофе-капсулу. Опустошите контейнер для использованных кофе-капсул и каплесборник и установите их обратно на место. Не забудьте сдать использованные кофе-капсулы в переработку.\*

\* СДАВАЙТЕ КАПСУЛЫ **NESPRESSO** НА ПЕРЕРАБОТКУ. Для получения информации об утилизации использованных капсул **Nespresso** посетите сайт [www.nespresso.ru](http://www.nespresso.ru)

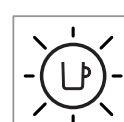
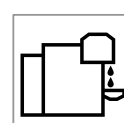
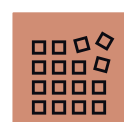
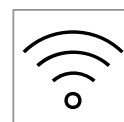

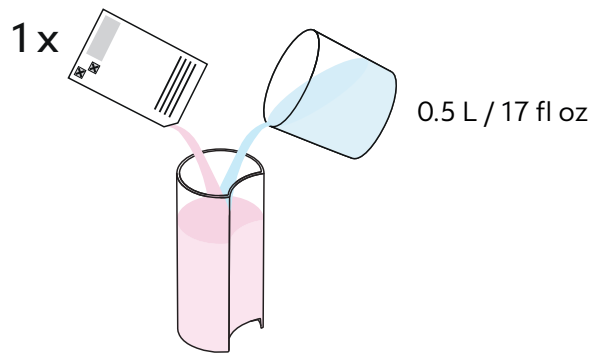

- 2** Наполните резервуар для воды 0,5 л воды и добавьте один пакетик средства для очистки от накипи **Nespresso**.

**ВНИМАНИЕ:** Средство для очистки от накипи может быть опасно. Не допускайте попадания средства в глаза, на кожу и другие поверхности.

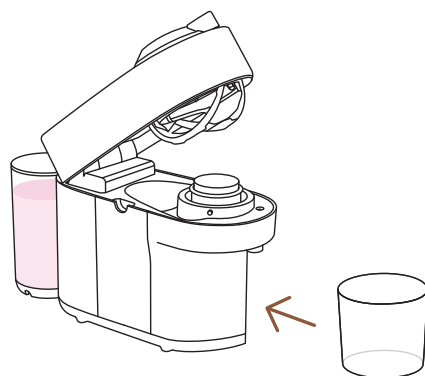

- 3** Снимите подставку под чашку и установите пустой резервуар емкостью не менее 1 л под носик выдачи кофе.

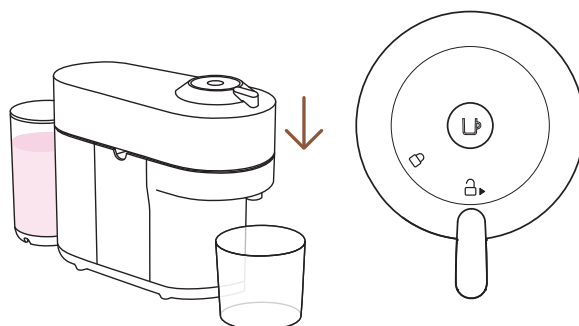

- 4** При включенной кофемашине, закройте варочный узел, но не блокируйте его рычагом, оставьте его в позиции Разблокировано.

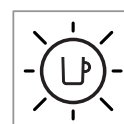
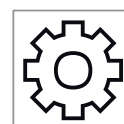
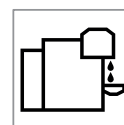
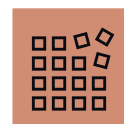
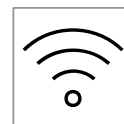

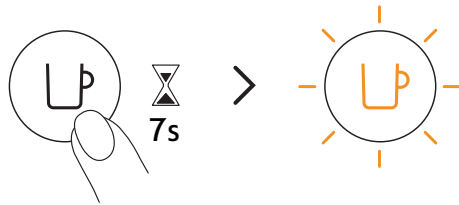

- 5** Удерживайте кнопку не менее 7 секунд или до момента, пока не погаснет индикатор. Индикатор кнопки начнет быстро мигать оранжевым цветом.

**ВНИМАНИЕ:** У вас есть 45 секунд, чтобы войти в режим очистки от накипи, иначе кофемашина вернется в режим приготовления кофе.

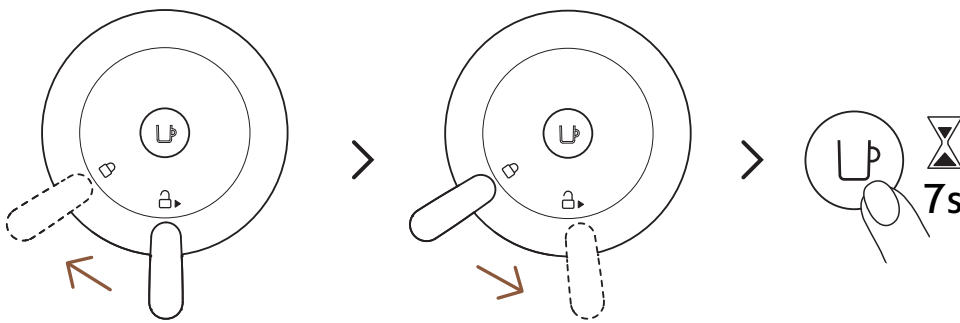

- 6** Заблокируйте варочный узел, повернув рычаг влево до упора в положение **Заблокировано**, а затем вправо в положение **Разблокировано**. Нажмите и снова удерживайте кнопку не менее 7 секунд, или пока не погаснет индикатор кнопки. Далее индикатор кнопки начнет быстро мигать оранжевым цветом.

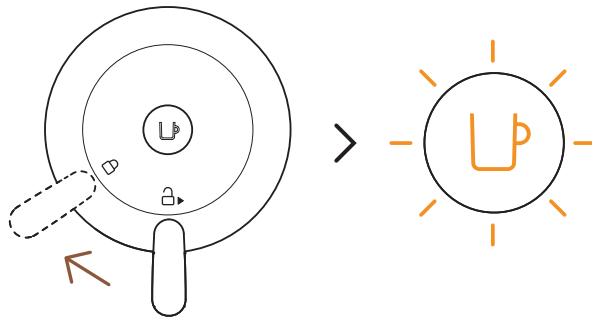

- 7** Для входа в режим очистки от накипи, заблокируйте варочный узел повернув рычаг влево до упора. Индикатор также должен продолжать быстро мигать оранжевым цветом. Это означает, что кофемашина вошла в режим очистки от накипи.

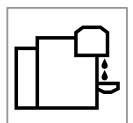
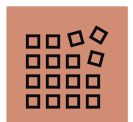



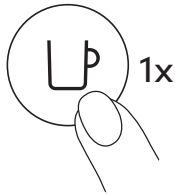

- 8** Нажмите один раз на кнопку приготовления кофе для запуска процесса очистки от накипи. Во время процесса очистки индикатор будет постоянно мигать оранжевым цветом.

- i** После завершения первого этапа очистки кофемашина остановится самостоятельно.

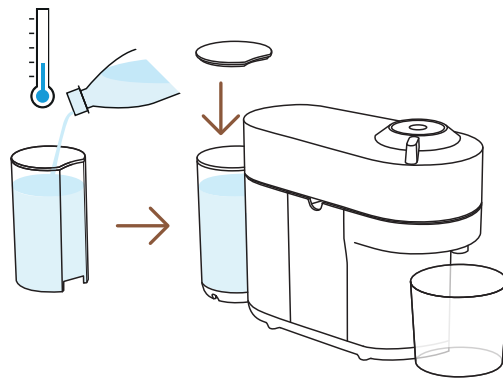

- 9** В завершение процесса очистки от накипи необходимо промыть кофемашину. Промойте резервуар для воды и каплесборник. Залейте в резервуар для воды свежую питьевую воду и установите его обратно на место. Опустошите контейнер и поставьте его обратно под носик выдачи кофе.

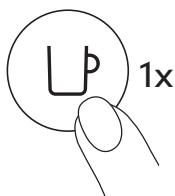

- 10** Нажмите на кнопку для запуска промывки кофемашины. Когда индикатор перестанет быстро мигать и станет гореть постоянно, процесс очистки от накипи завершен.

- i** Кофемашина автоматически остановится по завершении процесса очистки от накипи.

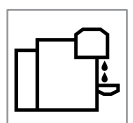
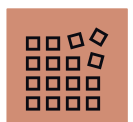

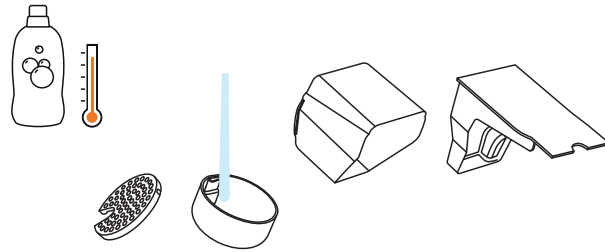

- 11** Промойте контейнер для капсул, подставку под чашку и каплесборник теплой водой с мягким моющим средством без запаха.

**ВНИМАНИЕ:** Не используйте сильное или абразивное моющее средство, а также растворители. Не допускается мыть кофемашину в посудомойке. Никогда не погружайте кофемашину полностью либо частично в воду.

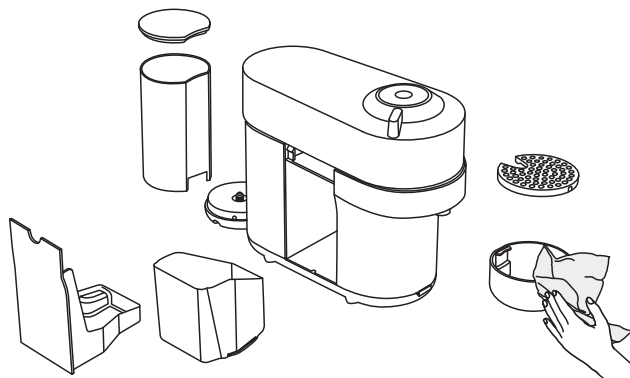

- 12** Протрите кофемашину чистым мягким полотенцем. После завершения процесса дайте кофемашине высохнуть не менее 10 минут перед последующим использованием.

**ВНИМАНИЕ:** В процессе очистки вода может скопиться в варочном узле. Для ее удаления протрите внутренние части узла сухой салфеткой.

**ИНФОРМАЦИЯ:** войти в режим очистки от накипи возможно только после приготовления 30 и более чашек кофе.

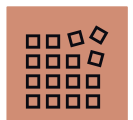

## ОПУСТОШЕНИЕ КОФЕМАШИНЫ

Опустошение кофемашины необходимо производить перед длительным периодом ее неиспользования, для защиты от замерзания или перед отправкой в сервисный центр на ремонт.

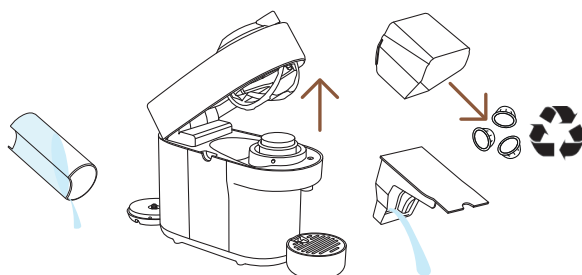

- 1** Опустошите резервуар для воды, откройте варочный узел для сброса использованной капсулы. Опустошите контейнер для использованных кофе-капсул и каплесборник. Не забудьте сдать использованные кофе-капсулы в переработку.\*

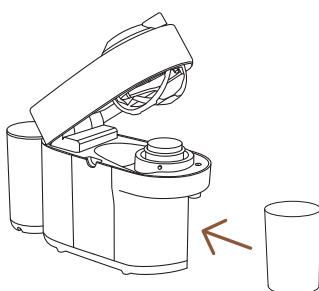

- 2** Установите их обратно на место, снимите подставку под чашку и поместите под носик выдачи кофе резервуар объемом не менее 1 л.

\* СДАВАЙТЕ КАПСУЛЫ **NESPRESSO** НА ПЕРЕРАБОТКУ. Для получения информации об утилизации использованных капсул **Nespresso** посетите сайт [www.nespresso.ru](http://www.nespresso.ru)

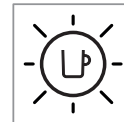
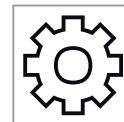
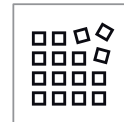
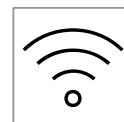

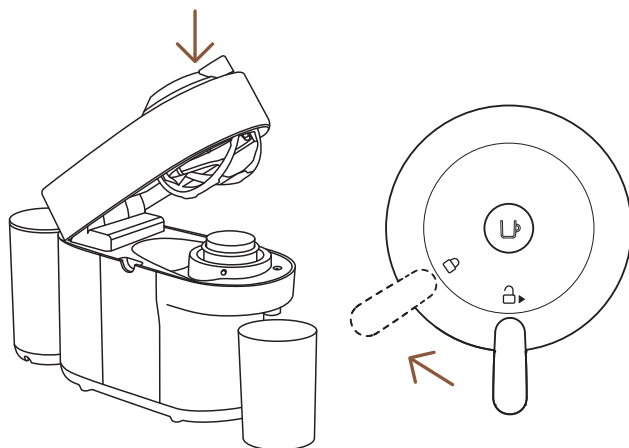

- 3** При подключенной к розетке и включенной кофемашине, поверните рычаг влево в положение **Заблокировано**.

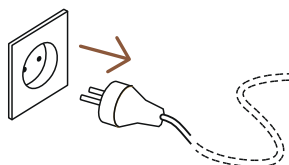

- 4** Отсоедините кофемашину от сети.

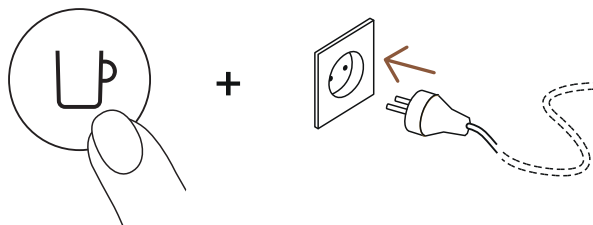

- 5** Нажмите и удерживайте кнопку во время подключения к сети.

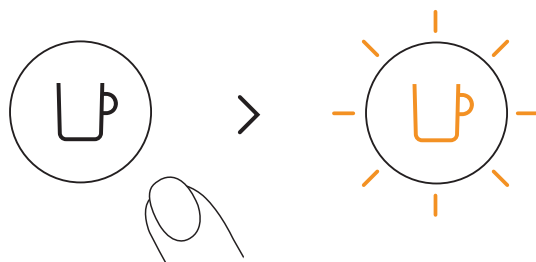

- 6** Отпустите кнопку. Индикатор мигнет оранжевым цветом и процесс запустится.

- i** Процесс опустошения занимает около 30 секунд. По завершении кофемашина отключится автоматически.

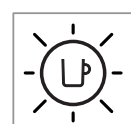
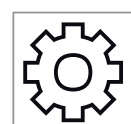
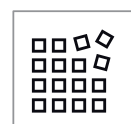
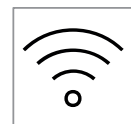

## ВОЗВРАТ К ЗАВОДСКИМ НАСТРОЙКАМ

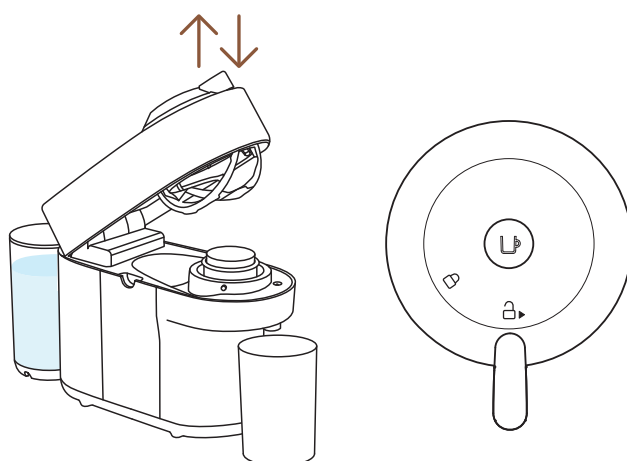

- 1 При подключенной к розетке кофемашине откройте и закройте варочный узел, при этом рычаг варочного узла должен **находиться** в положении Разблокировано.

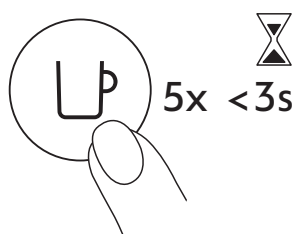

- 2 Нажмите на кнопку 5 раз в течение 3-х секунд. Настройки сброшены к заводским.

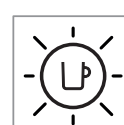
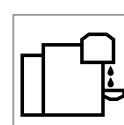
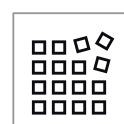
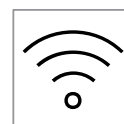

## ЦВЕТОВЫЕ СИГНАЛЫ

Хотите узнать больше про значения индикации Vertuo Pop?  
Посмотрите следующие видео:



## УСТРАНЕНИЕ НЕИСПРАВНОСТЕЙ

### Индикатор не горит

- Кофемашина выключилась автоматически; нажмите на кнопку или разблокируйте кофемашину.
- Проверьте наличие электропитания и предохранитель.

### Не течет кофе, не течет вода.

- Проверьте наличие воды в резервуаре.
- Убедитесь, что новая капсула вставлена корректно, варочный узел кофемашины закрыт и нажмите кнопку для приготовления напитка.
- Необходима очистка от накипи.
- Откройте варочный узел кофемашины, чтобы сбросить использованную капсулу, после чего очистите кофемашину (см раздел «ОЧИСТКА»).

### Кофе недостаточно горячий.

- Предварительно прогрейте чашку горячей водой.
- Необходима очистка от накипи.

### Необычный (слабый) ток кофе.

- Проверьте корректность установки резервуара для воды.
- Необходима очистка от накипи.

### Кофемашина выключается.

- Для энергосбережения кофемашина автоматически выключится через 2 минуты после последнего использования.
- Кофемашину можно отключить вручную в любой момент (но только не в момент приготовления кофе), нажав на кнопку и удерживая ее не менее 3-х секунд.

### Частицы кофе попадают в чашку с напитком.

- Проведите очистку кофемашины два раза.
- Ознакомьтесь с разделом «Очистка» настоящего руководства.

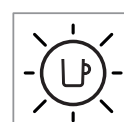
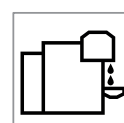
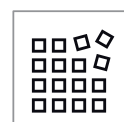
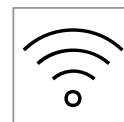

**Кофемашина не включается и индикатор горит постоянно. Если индикатор мигает - см. след. пункты.**

**Кофемашина не включается и индикатор мигает попеременно.**

**Индикатор мигает в процессе работы кофемашины.**

**Кофемашина не включается и индикатор мигает попеременно.**

- Проверьте, что варочный узел кофемашины закрыт корректно.
- При приготовлении напитка проверьте, что новая капсула вставлена корректно, варочный узел закрыт и нажмите кнопку приготовления напитка.
- Если вы чистите кофемашину, очищаете ее от накипи или опустошаете систему, убедитесь, что капсула не вставлена, затем закройте варочный узел, заблокируйте машину и нажмите кнопку, чтобы начать одну из операций.
- Залейте воду в резервуар и нажмите кнопку для приготовления напитка.
- Проверьте, что варочный узел кофемашины закрыт корректно.
- Если идет приготовление кофе, кофемашина работает нормально
- Если происходит только подача воды, машина выполняет одну из команд пользователя для очистки от накипи, опустошения системы или очистки. Обратитесь к соответствующему разделу инструкции.
- Выключите кофемашину, нажав на кнопку и удерживая ее в течение 3 секунд. Подождите 20 минут пока кофемашина остынет после интенсивного использования.
- Потребуется немного времени перед подачей кофе из-за считывания штрих-кода с кофе-капсулы.
- Убедитесь, что новая капсула вставлена корректно, варочный узел кофемашины закрыт и нажмите кнопку для приготовления напитка.
- Залейте воду в резервуар и нажмите кнопку для приготовления напитка.
- Выключите кофемашину, нажав на кнопку и удерживая ее в течение 3-х секунд. Подождите 20 минут пока кофемашина остынет после интенсивного использования.

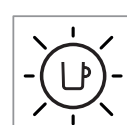
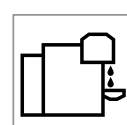
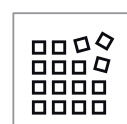
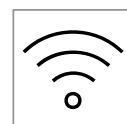



**Кнопка мигает 2 раза, затем пауза, машина не готовит кофе.**

- Во время стандартного приготовления кофе:
  - 1) Откройте варочный узел и убедитесь, что новая кофе-капсула вставлена корректно.
  - 2) Проверьте, что рычаг переведен в позицию **Заблокировано**.
  - 3) Проверьте наличие воды в резервуаре.
- Во время очистки от накипи, опустошения системы или очистки:
  - 1) Убедитесь, что использованная капсула была извлечена.
  - 2) Проверьте, что рычаг переведен в позицию **Заблокировано**.
- Во время перепрограммирования объема:
  - 1) Убедитесь, что капсула вставлена корректно.
  - 2) Обратитесь к соответствующему разделу инструкции.
- Если проблема сохраняется:
  - 1) Откройте варочный узел кофемашины.
  - 2) Замените кофе-капсулу (если необходимо).
  - 3) Отключите кофемашину от сети и вставьте вилку в розетку через 10 секунд.
  - 4) Закройте варочный узел, нажмите кнопку, чтобы включить кофемашину и нажмите повторно, чтобы начать приготовление кофе. Если проблема сохранилась, пожалуйста, обратитесь в Клуб **Nespresso**.

**Кнопка мигает 3 раза и затем горит постоянно.**

- Необходима очистка от накипи. После этого предупреждения возможно будет приготовить только несколько чашек, прежде чем очистку необходимо будет произвести в обязательном порядке.

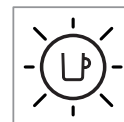
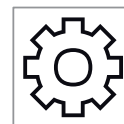
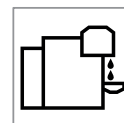
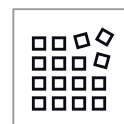
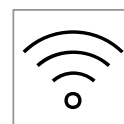

## ТЕХНИЧЕСКИЕ ХАРАКТЕРИСТИКИ

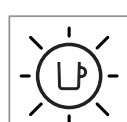
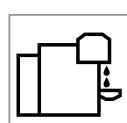
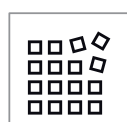
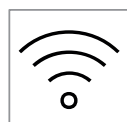

**Мощность**

**~220–240 V, 50–60 Hz, 1300–1500 W**  
**US, CA:** 120 V, 60 Hz, 1500 W  
**MX:** 127 V~, 60 Hz, 1380 W

**Частота**

2.402–2.480 GHz

**Выходная мощность РЧ (RF)**

Bluetooth 4 dBm макс. e.i.r.p. и Wi-Fi  
 <20 dMm макс. e.i.r.p.

**Режим ожидания**

0.39 W/h

**Режим энергосбережения**

Автоматическое выключение: 2 мин

**Время нагрева**

30 секунд (варочный узел закрыт и заблокирован)

**Регулируемая подставка под чашку для рецептов с большим объемом.**

Съемная, однопозиционная

**Длина кабеля**

75 cm / 30 in

**Габариты (Ш x Г x В)**

13.6 x 42.6 x 25 cm / 5.3 x 16.7 x 9.8 in

**Вес**

3.5 kg / 7.72 lbs

**Емкость резервуара для воды**

0.6 l / 20 fl oz

**Емкость капсулосборника**

8 Эспрессо, 5 Большая чашка

## КОД КОФЕМАШИНЫ

**Nespresso**

**Breville**

**Delonghi**

GCV2, GDV2

BNV120, BNV150

ENV90

**Krups**

**Magimix**

XN9201, XN9204,  
 XN9205, XN9211

M800

# KLIK EN KIES JE TAAL

NL

---



**VEILIGHEID**



**OVERZICHT**



**CONNECTIVITEIT**



**EERSTE STAPPEN**



**KOFFIE BEREIDEN**



**PAS JOUW KOFFIEVOLUME AAN**



**SCHOONMAKEN**



**ONTKALKEN**



**SYSTEEM LEGEN**



**HERSTEL FABRIEKSINSTELLINGEN**



**OVERZICHT VAN HET KNIPPEREN**



**PROBLEMEN OPLOSSEN**



**SPECIFICATIES**

## VEILIGHEID

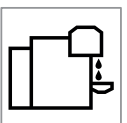

**LET OP:** Lees de veiligheidsinstructies goed door voordat je deze machine bedient om mogelijke schade en letsel te voorkomen.

## AFVAL EN BESCHERMING VAN HET MILIEU

Deze machine voldoet aan de EU-richtlijn 2012/19/EC. Verpakkingsmaterialen en machine bevatten recyclebare materialen. Jouw machine bevat waardevolle materialen die teruggewonnen of gerecycled kunnen worden. Door de resterende afvalstoffen te scheiden is recycling van waardevolle grondstoffen gemakkelijker. Laat de machine achter bij een verzamelpunt. Je kunt informatie over verwijdering krijgen bij jouw lokale autoriteiten.



# OVERZICHT

## OVERZICHT MACHINE

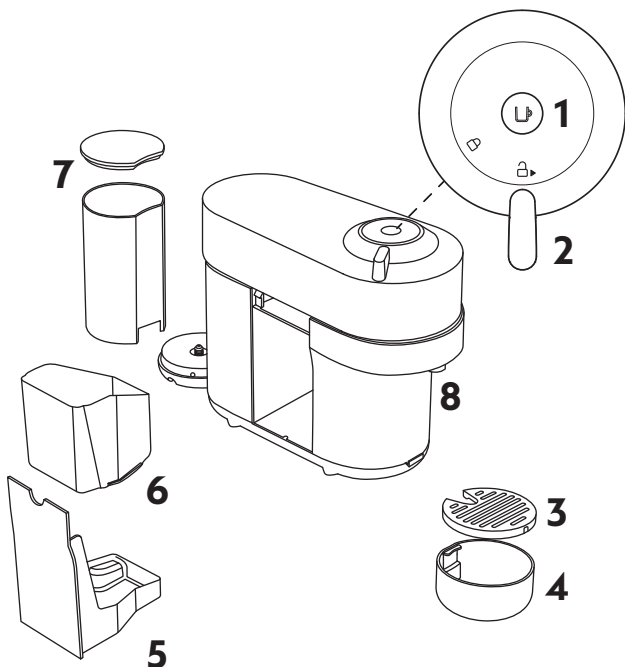

- 1 AAN/UIT en koffieknop
- 2 Vergrendel/ Ontgrendelhendel
- 3 Lekrooster
- 4 Verstelbare kophouder
- 5 Lekbakje
- 6 Bak voor gebruikte capsules
- 7 Waterreservoir en deksel
- 8 Koffie-uitloop

## INHOUD VAN DE VERPAKKING



- 1 Koffiemachine
  - 2 **Nespresso** capsuleset
  - 3 Welkom bij **Nespresso** brochure
  - 4 Veiligheidsinstructies
  - 5 Quick Start Guide
  - 6 Garantie
- 4 + 5 + 6**

**i Uitpakken:** door het gebruik van gerecyclede materialen in de verpakking kan er stof op de bovenkant van de machine liggen. Dit is niet gevaarlijk, verwijder het eenvoudig met een zachte doek.

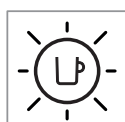
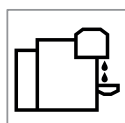
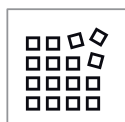
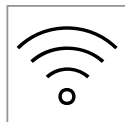

## OPENEN / SLUITEN

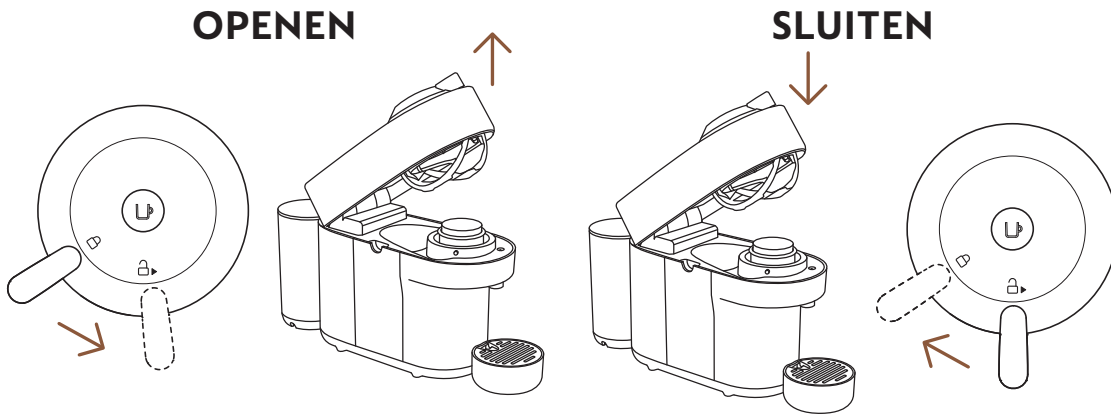

**LET OP:** voor een goed gebruik van de machine, open de machine niet terwijl de koffie aan het zetten is en wacht tot de koffieknop teruggaat naar constant wit licht. Als je het koffiezetten eerder wilt stoppen, druk dan eenmaal op de koffieknop en wacht tot de machine stopt voordat je de machine opent.

## HET VERTUO SYSTEEM

### CAPSULE COMPATIBILITEIT

			
<b>S</b>	<b>M</b>	<b>L</b>	<b>XL</b>
<b>Ristretto</b> (25 ml)	<b>Double Espresso</b> (80 ml)	<b>Mug</b> (230 ml)	<b>Alto, Cold Brew Style</b> (355 ml)
<b>Espresso</b> (40 ml)	<b>Gran Lungo</b> (150 ml)		<b>Carafe</b> (535 ml)

### ACCESSOIRES



Ontdek onze volledige accessoirecollectie op [www.nespresso.com](http://www.nespresso.com)

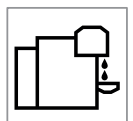
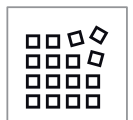

## AAN/UIT

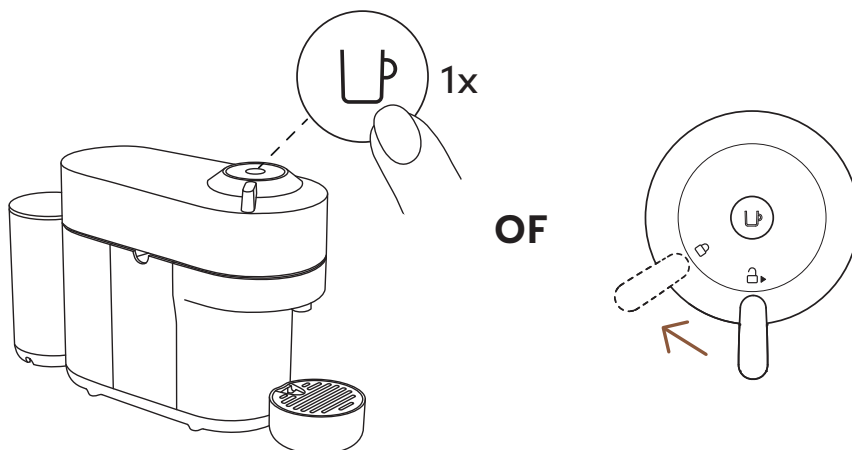
**AAN**

Zodra de machine is aangesloten, zet de machine aan door eenmaal op de koffieknop te drukken of door de hendel te sluiten (met de kop gesloten).

- i** Terwijl de machine opwarmt knippert de lamp voor ongeveer 30 seconden. Als de lamp constant brandt is de machine klaar.

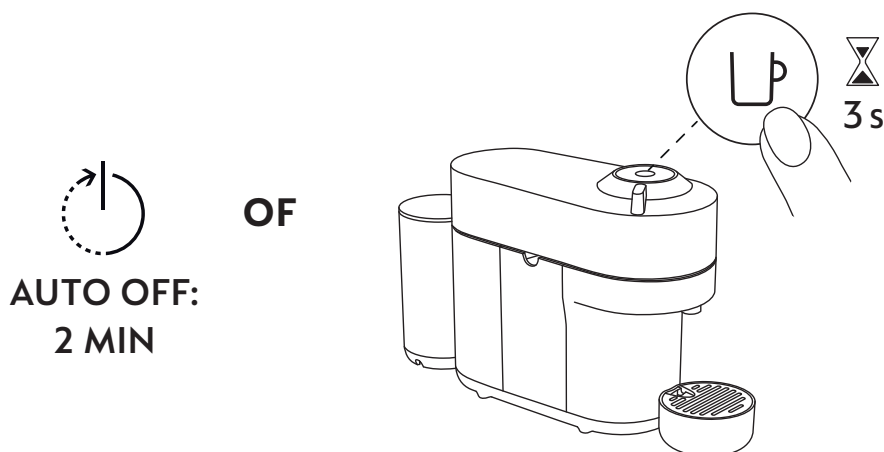
**UIT**

Om energie te besparen wordt de machine automatisch uitgeschakeld als de machine 2 minuten niet wordt gebruikt.

- i** De machine kan op ieder moment (wanneer niet in gebruik) worden uitgeschakeld door handmatig gedurende 3 seconden op de koffieknop te drukken.

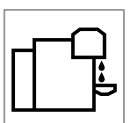
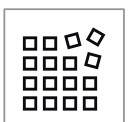

## CONNECTIVITEIT

### WAAROM JE DE VERTUO POP KOPPELT



### VOORDELEN VAN HET VERBINDEN VAN JOUW VERTUO POP

- **Slimme koffie:** blijf voorlopen op de nieuwste koffië-innovaties van **Nespresso** door jouw machine up-to-date te houden
- **Deskundig advies:** krijg ondersteuning en eenvoudige instructievideo's om je koffiereis te begeleiden via je smartphone.
- **Onderhoud machine:** ontvang notificaties over wanneer en hoe je de machine onderhoudt met gemakkelijke stapsgewijze uitleg over het ontkalken, spoelen, schoonmaken etc.

### HOE VERBIND JE DE VERTUO POP MACHINE?

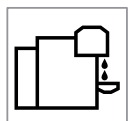
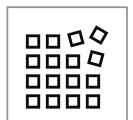
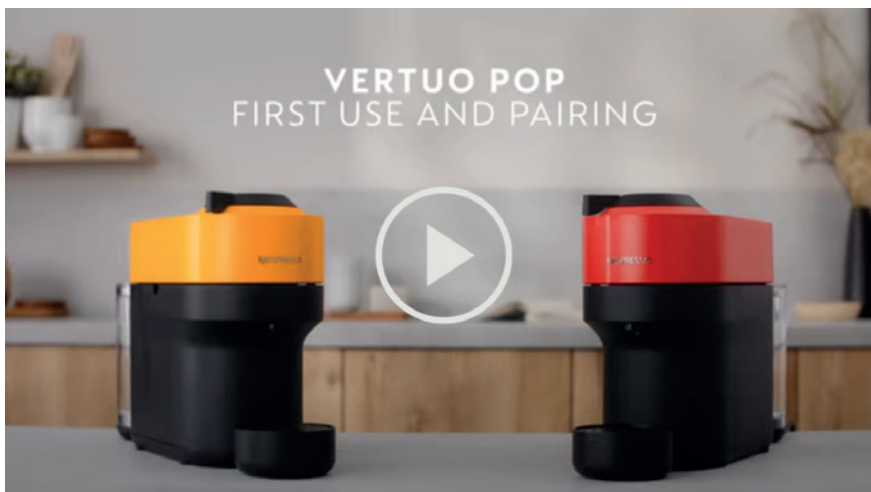





- 1** Download de **Nespresso** App. Lanceer de **Nespresso** App op jouw smartphone of tablet. Druk op het machine-icoon rechtsboven in het scherm.

**OPMERKING:** voor optimale prestaties en een naadloze ervaring raden we aan om je machine aan te sluiten op een wifi router in plaats van een hotspot op je smartphone te gebruiken.

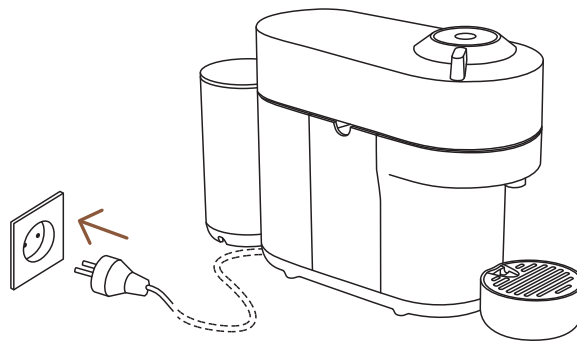

- 2** Steek de stekker in het stopcontact.



- 3** Volg de instructies via de **Nespresso** app.

**LET OP:** Lees eerst de veiligheidsvoorschriften om risico's op dodelijke elektrische schokken en brand te voorkomen. Zorg voor aarding wanneer je de machine in het stopcontact steekt.

- \* App Store® is een handelsmerk van Apple Inc., geregistreerd in de Verenigde Staten en andere landen.
- \*\* Google Play en het Google Play logo zijn handelsmerken van Google LLC.

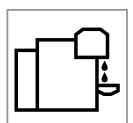
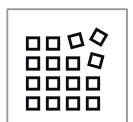

## ONTKOPPEL DE MACHINE VAN BLUETOOTH EN WIFI

De machine heeft een connectiviteitsmodule die standaard is ingeschakeld. Het geeft toegang tot extra functies die je koffie-ervaring verbeteren. Voer de volgende stappen uit om de connectiviteitsmodule uit te schakelen:

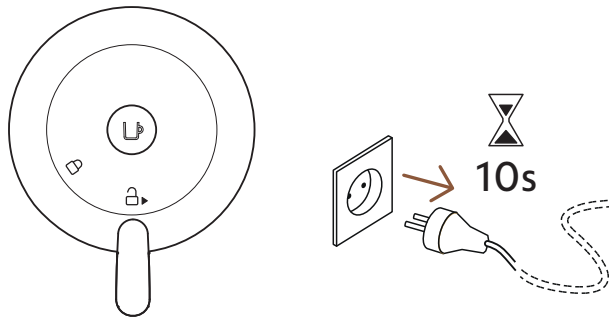

- 1 Haal de stekker van de machine minstens 10 seconden uit het stopcontact terwijl de machine gesloten is en de hendel in de **ontgrendelde** stand staat.

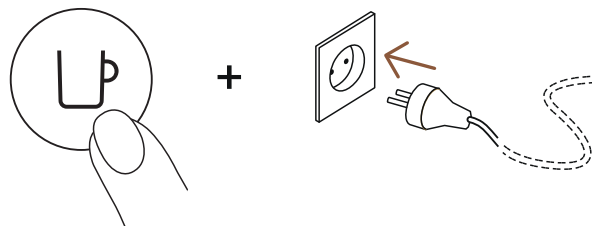

- 2 Houd de knop ingedrukt tijdens het aansluiten. De knop knippert oranje om te bevestigen dat de connectiviteitsmodule nu is uitgeschakeld.
- i** Volg dezelfde stappen om de connectiviteitsmodule weer in te schakelen. De knop knippert wit om te bevestigen dat de module opnieuw geactiveerd is.

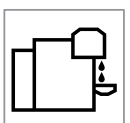

# EERSTE STAPPEN

## EERSTE SPOELING

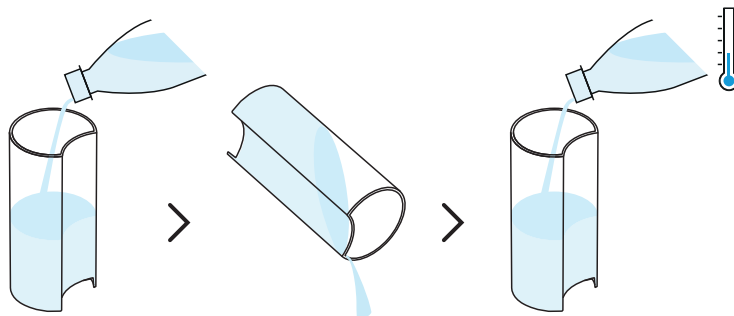

- 1** Spoel eerst het waterreservoir en de deksel voordat je deze vult met vers drinkwater.

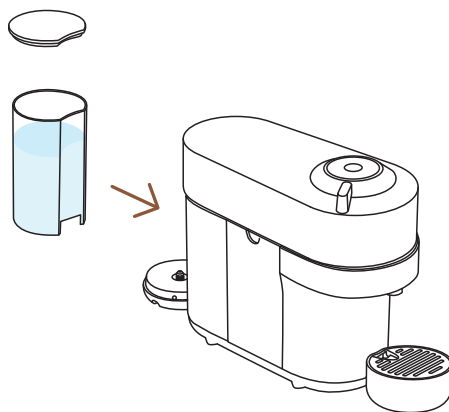

- 2** Bevestig het waterreservoir met de deksel op juiste wijze aan de machine.

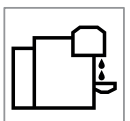

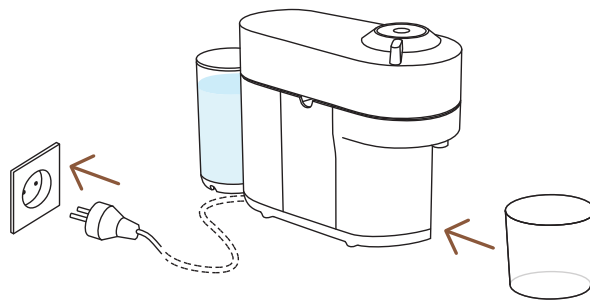

- 3** Met de machine aangesloten, verwijder de kophouder en plaats een lege bak (minimaal 1 liter) onder de koffie-uitloop.

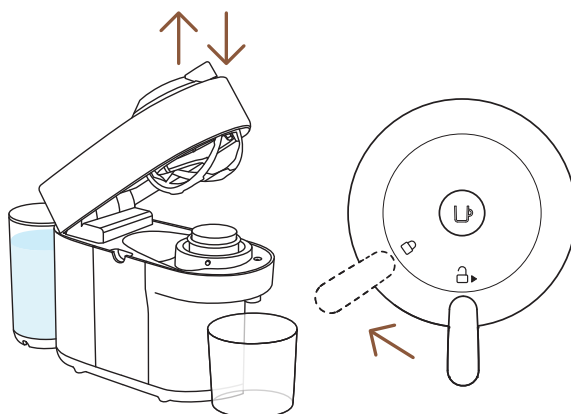

- 4** Open en sluit de machine. Controleer of de hendel gesloten is.

- i** Terwijl de machine opwarmt knippert de lamp van de koffieknop. Het duurt ongeveer 30 seconden. Als de lamp constant brandt, is de machine klaar. Zorg ervoor dat er geen capsule in de machine is geplaatst.

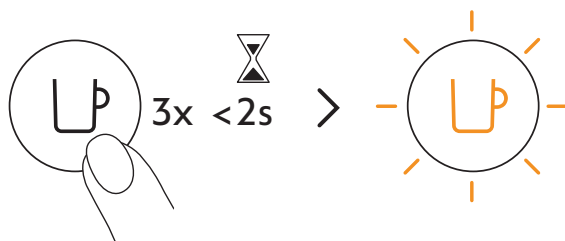

- 5** Druk binnen 2 seconden driemaal op de koffieknop om de spoelcyclus te starten. Terwijl het lampje oranje knippert, voltooit de spoelprocedure automatisch. Wanneer de lamp constant wit brandt is de cyclus voltooid.

- i** Het kan twee minuten duren voordat het reinigingsproces start en het water begint te stromen. Dit proces kan 7 minuten duren.

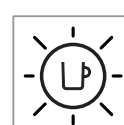
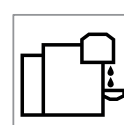
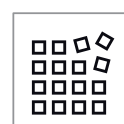
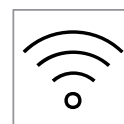

# KOFFIE BEREIDEN

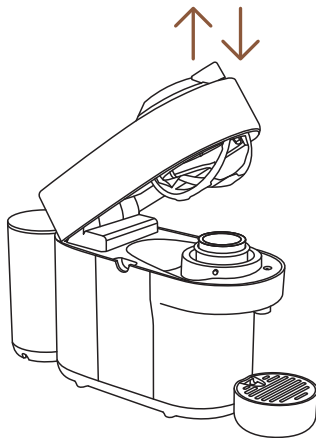

**1** Open en sluit de machine.

**i** Terwijl de machine opwarmt knippert de lamp van de koffieknop. Als de lamp constant brandt is de machine klaar voor gebruik.

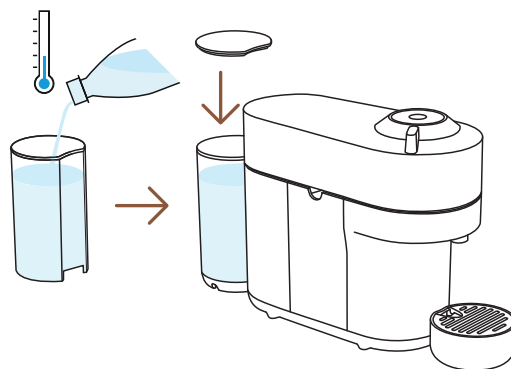

**2** Vul het waterreservoir met vers drinkwater.



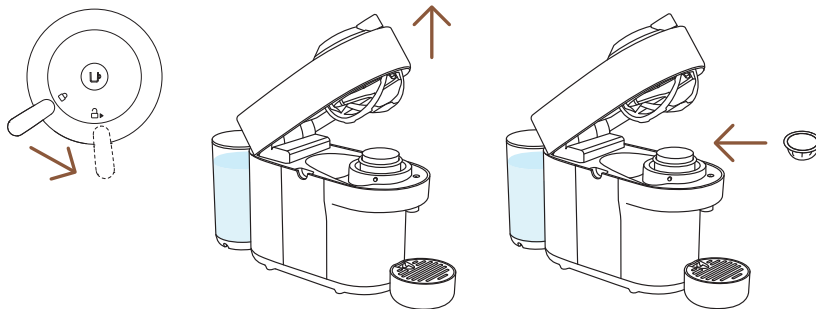

- 3** Ontgrendel en open de machine volledig en plaats een Vertuo capsule met de bolle kant naar beneden.

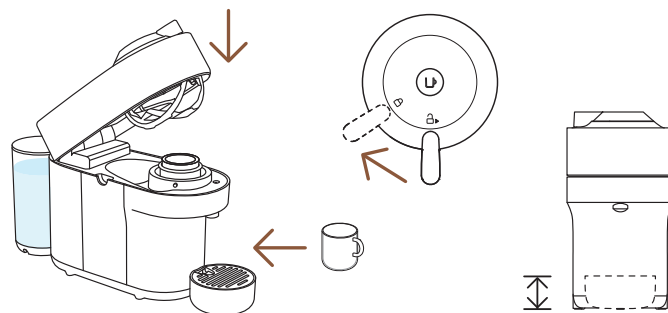

- 4** Sluit de machine en vergrendel de hendel door deze naar links te schuiven tot de vergrendelpositie. Plaats een kopje. De kophouder kan versteld worden afhankelijk van de kopgrootte.

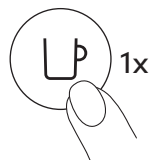

- 5** Start de bereiding door één keer op de knop te drukken.

**LET OP:** Open de machine niet terwijl de koffie aan het zetten is. Voor een goed gebruik van de machine wacht je tot de koffieknop teruggaat naar constant wit licht. Als je het koffiezetten eerder wilt stoppen, druk dan eenmaal op de koffieknop en wacht tot de machine stopt voordat je de machine opent.

- i** Vanwege het lezen van de code, de voorbevochtiging van de koffie en de infusietijd duurt het even voordat de koffie begint te stromen. De machine herkent automatisch de geplaatste capsule en selecteert de bijpassende parameters en kopgrootte geselecteerd door de koffie-experts van **Nespresso** om de beste extractie te realiseren van de koffiblend.

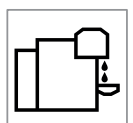

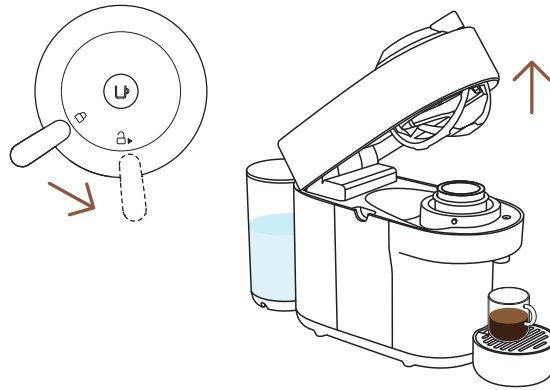

- 6** Wanneer de koffiebereiding stopt, open de machine door de hendel naar rechts te schuiven en de machine te ontgrendelen. De capsule wordt automatisch uitgeworpen. Geniet van je koffie!



- 7** Vergeet je **Nespresso** capsules niet te recyclen.\*

\* DIT IS **NESPRESSO**. DIT IS RECYCLEBAAR. Voor meer informatie over het recyclen van jouw **Nespresso** capsules, ga naar [www.nespresso.com](http://www.nespresso.com)

## ONTDEK ONZE COFFEE CREATIONS FUNCTIE



Met deze machine biedt **Nespresso** een extra functie om jouw koffie-extractie te concentreren om eigen recepten te maken.

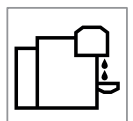
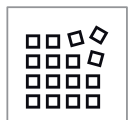

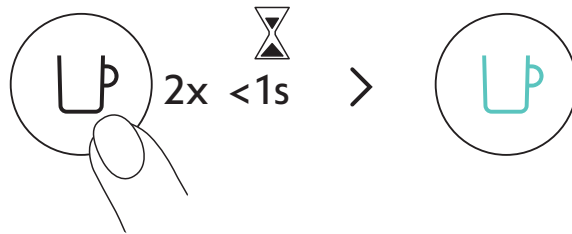

Zorg dat de machine aan staat. Druk twee keer op de koffieknop. De lamp zal turquoise knipperen en de koffiebereiding zal geconcentreerd zijn, zodat de koffiesmaak geoptimaliseerd wordt met extra's (melk, room, ijs...). Voor een onvergetelijke smaak.

40 ml	80 ml	150 ml	230 ml	355 ml	535 ml
✓	✓	✓	✓	✗	✗
25 ml	40 ml	40 ml	80 ml		

Om ten volle van de voordelen te genieten, raden we aan om onze Coffee+ koffies alleen met de officiële kopgroottes te zetten. Voor de beste resultaten raden we af om onze XL (Alto Ambrato, Alto Onice), Cold Brew Style & Carafe Pour Over Style op deze manier te zetten.

**OPMERKING:** Mogelijk is een update van jouw machine via de **Nespresso** App nodig om deze modus in te schakelen.



Ontdek hoe je jouw machine kan upgraden met een Aeroccino op [www.nespresso.com](http://www.nespresso.com)

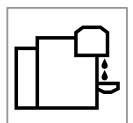



## PAS JOUW KOFFIEVOLUME AAN

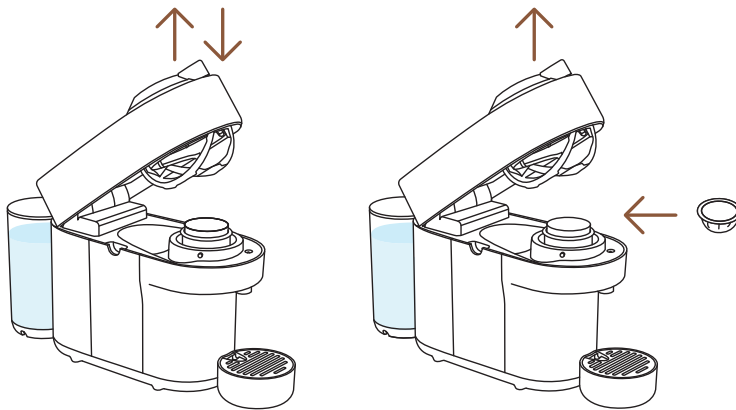

- 1** Open en sluit de machine. Met de machine aan, open de machine en plaats de capsule die je wilt programmeren.

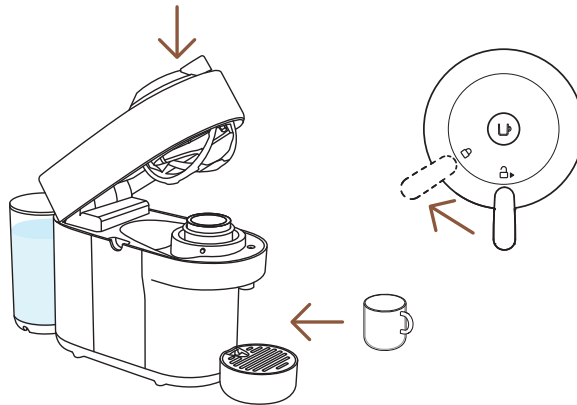

- 2** Sluit de machine en vergrendel de hendel door deze naar links te schuiven tot de vergrendelpositie. Plaats een kopje.

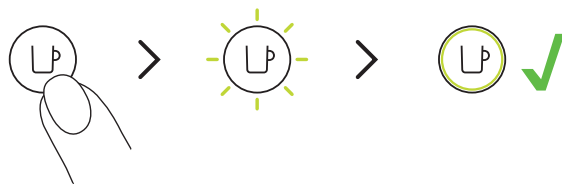

- 3** Houd de knop ingedrukt en laat hem een paar seconden los tot het gewenste volume is bereikt. Het nieuwe watervolume is ingesteld voor het type capsule dat je hebt gebruikt tijdens het instellen.

- i** Het programma is specifiek voor elk type capsule. Kopgroottes kunnen worden geprogrammeerd vanaf 20 ml tot 535 ml.

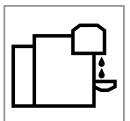

**LET OP:** Voor een goed gebruik van de machine, open de machine niet terwijl de koffie aan het zetten is. Wacht tot de koffieknop teruggaat naar constant wit licht. Als je het koffiezetten eerder wilt stoppen, druk dan eenmaal op de koffieknop en wacht tot de machine stopt voordat je de machine opent.

**OPMERKING:** Als de gebruiker het koffievolume van een type capsule aanpast, zal de bereiding van dat type capsule stoppen bij het door de gebruiker ingestelde koffievolume. Als je terug wilt naar de standaard parameters, zie de paragraaf 'Herstel fabrieksinstellingen'.

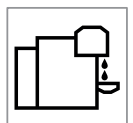

## SCHOONMAKEN

Reinig de machine maandelijks, wanneer je koffieresten in de machine aantreft of na een lange periode van niet-gebruik.

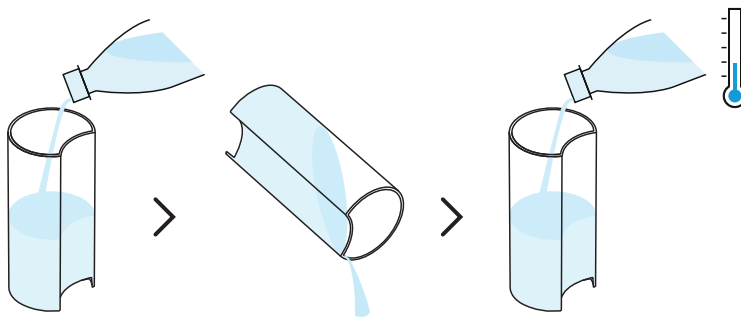

- 1** Spoel en reinig het waterreservoir en de deksel voordat je deze vult met vers drinkwater.

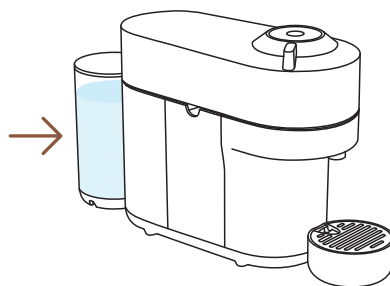

- 2** Plaats het waterreservoir terug op de machine.

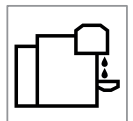
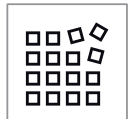

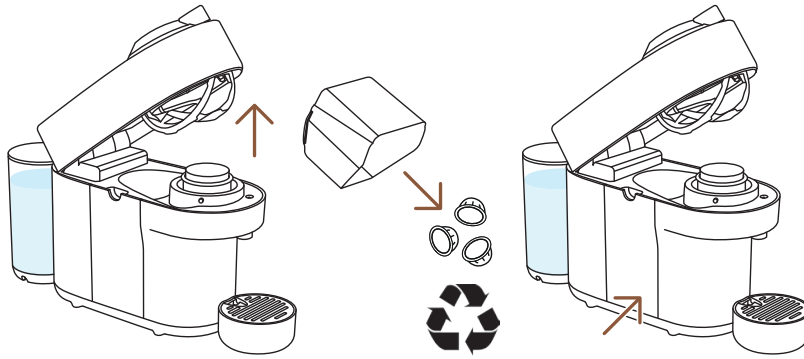

- 3** Met de machine aan, open de machine om de gebruikte capsule uit te werpen. Leeg en reinig de bak voor gebruikte capsules en de lekbak en plaats terug op de machine. Vergeet je **Nespresso** capsules niet te recyclen.\*

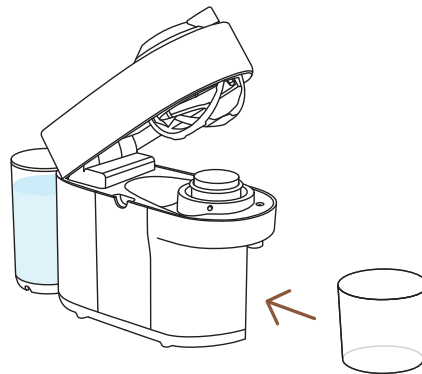

- 4** Verwijder de kophouder en plaats een lege bak (minimaal 1 L) onder de koffie-uitloop.

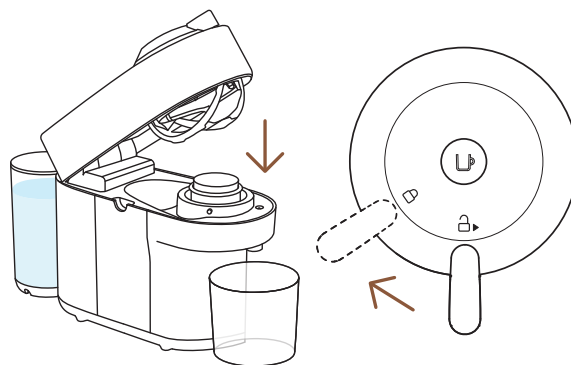

- 5** Sluit de machine en vergrendel de hendel door deze naar links te schuiven. Controleer of er geen capsules in de machine zitten voordat je de spoelingscyclus start.

\* DIT IS **NESPRESSO**. DIT IS RECYCLEBAAR. Voor meer informatie over het recyclen van jouw **Nespresso** capsules, ga naar [www.nespresso.com](http://www.nespresso.com)

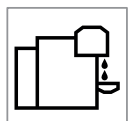
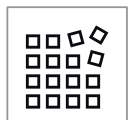

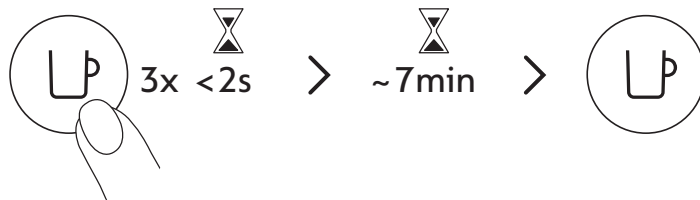

- 6** Druk binnen 2 seconden driemaal op de koffiekноп om de spoelcyclus te starten. Terwijl het oranje licht knippert, voltooit de spoelcyclus zich automatisch.

- i** Het kan 2 minuten duren voordat het spoelen start en het water begint te stromen. Dit proces kan 7 minuten duren en stopt automatisch wanneer de cyclus voltooid is. Het proces kan op elk moment worden beëindigd door op de knop te drukken.

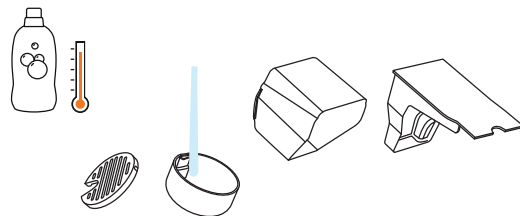

- 7** Reinig de bak voor gebruikte capsules, de kophouder en de lekbak met warm water en een mild geurloos reinigingsmiddel.

**LET OP:** Gebruik geen sterke of schurende reinigingsmiddelen of oplosmiddelen. Plaats de machine niet in de vaatwasser. Dompel de machine of onderdelen daarvan niet in water.

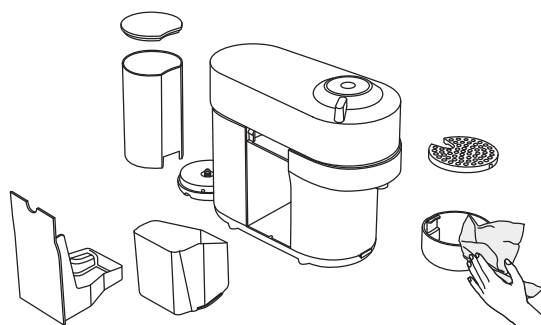

- 8** Droog de machine met een schone en droge theedoek.

**LET OP:** Reinig de koffie-uitloop regelmatig met een schone, vochtige doek. Gebruik altijd zachte doeken om de machine te reinigen.

**OPMERKING:** Water kan zich ophopen in de kop van de machine tijdens het schoonmaken. Als dit gebeurt, droog de zichtbare onderdelen dan af met een schone, droge doek.

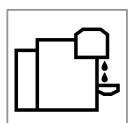

## ONTKALKEN

Het ontkalken van je machine zorgt ervoor dat de machine de gehele levensduur goed werkt en dat jouw koffiebeleving net zo perfect blijft als op de eerste dag. Jouw machine geeft aan wanneer ontkalking nodig is. De lamp knippert drie keer oranje voordat hij constant wit licht geeft.



**i** Het ontkalken duurt ongeveer 20 minuten en **kan niet worden onderbroken**.

**OPMERKING:** Lees de instructies voor het ontkalken zorgvuldig door voordat je begint.

### Benodigheden:

- Een ontkalkingsset, verkrijgbaar op [www.nespresso.com](http://www.nespresso.com)
- Een lege bak (van 1 L)

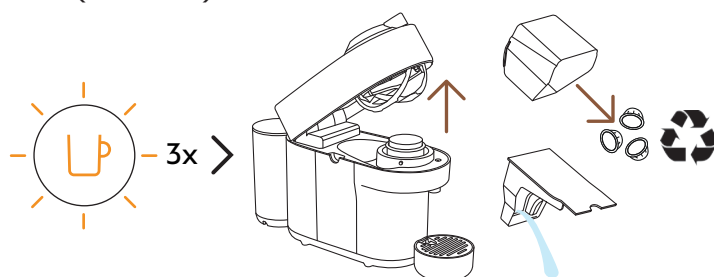

- 1** Wanneer de oranje lamp drie keer knippert: ontgrendel en open de machine om de gebruikte capsule uit te werpen. Leeg de bak voor gebruikte capsules en de lekbak en plaats terug op de machine. Vergeet je **Nespresso** capsules niet te recyclen.\*

\* DIT IS **NESPRESSO**. DIT IS RECYCLEBAAR. Voor meer informatie over het recyclen van jouw **Nespresso** capsules, ga naar [www.nespresso.com](http://www.nespresso.com)

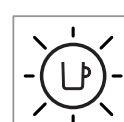
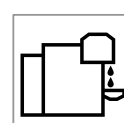
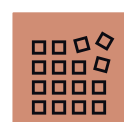
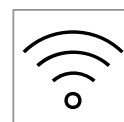

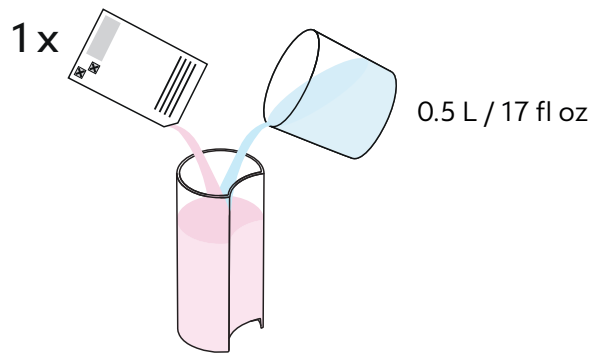

- 2** Vul het waterreservoir met 0.5 L water en 1 eenheid **Nespresso** ontkalkingsmiddel.

**LET OP:** Het ontkalkingsmiddel kan schadelijk zijn.  
Voorkom contact met de ogen, huid en oppervlaktes.

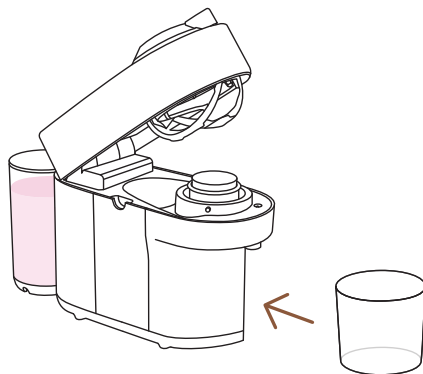

- 3** Verwijder de kophouder en plaats een lege bak (minimaal 1 L) onder de koffie-uitloop.

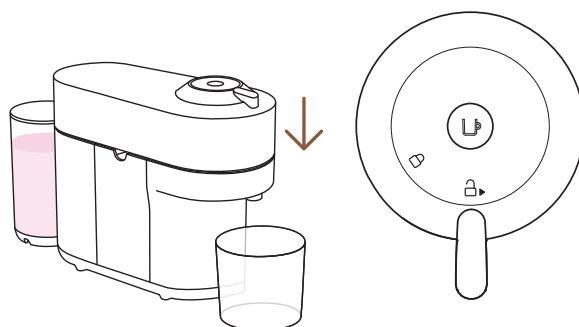

- 4** Terwijl de machine aan staat, sluit de machine, maar laat de machine ontgrendeld.

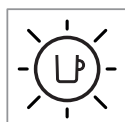
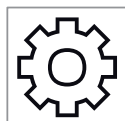
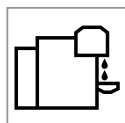
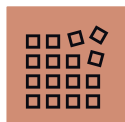
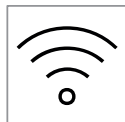

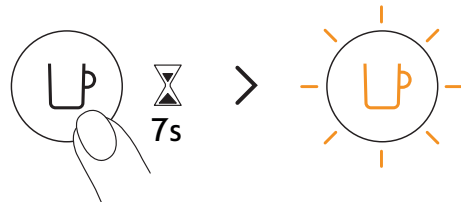

- 5** Houd de knop minstens 7 seconden ingedrukt of totdat je ziet dat het lampje uitgaat. De knop begint snel oranje te knipperen.

**LET OP:** Je hebt nu 45 seconden om de ontkalkingsmodus te starten, anders gaat de machine terug naar de reguliere bereidingsstand.

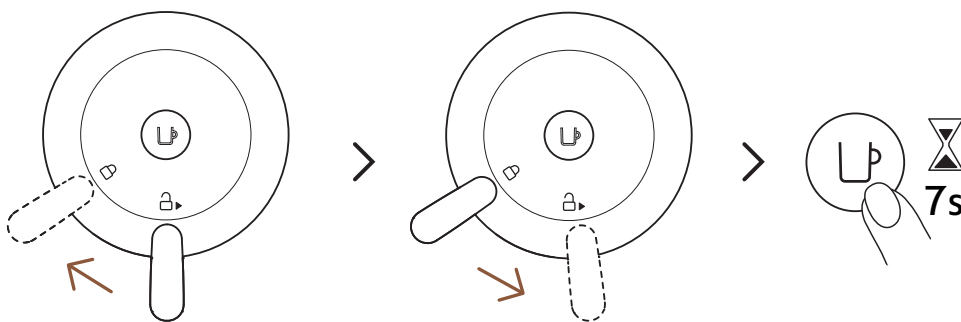

- 6** Sluit de machine door de hendel naar links te schuiven tot het vergrendelsymbool en ontgrendel daarna de machine door de hendel iets naar rechts te schuiven in de ontgrendelpositie. Houd de knop ingedrukt gedurende 7 seconden of tot de lamp uit gaat. De knop knippert snel oranje.

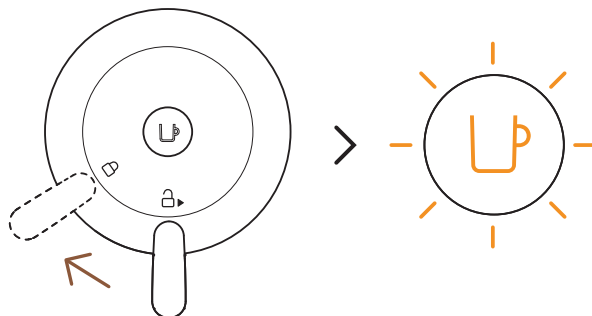

- 7** Om de ontkalkingsmodus te activeren, vergrendel de machine door de hendel naar links te schuiven tot het vergrendelsymbool. De lamp knippert snel oranje. Dit is een indicatie dat de ontkalkingsmodus is geactiveerd.

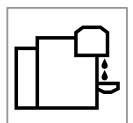
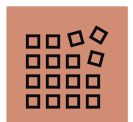



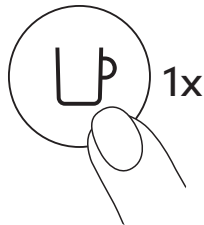

- 8** Druk één keer op de koffieknop om het ontkalkingsproces te starten. Het lampje blijft oranje knipperen tijdens het ontkalkingsproces.

**i** De machine stopt automatisch wanneer de eerste fase voltooid is.

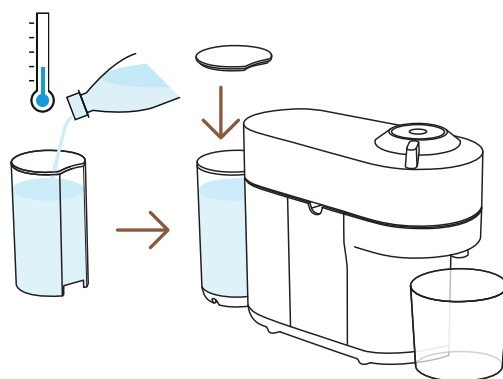

- 9** Na het ontkalken is het tijd om de machine door te spoelen. Reinig het waterreservoir en de lekbak grondig. Vul het waterreservoir met vers drinkwater en plaats deze terug op de machine. Leeg de bak en plaats deze terug onder de koffie-uitloop.

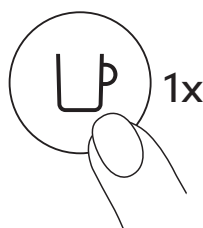

- 10** Druk op de knop om de reiniging te starten. Wanneer lamp stopt met knipperen en constant brandt, is de ontkalkingscyclus voltooid.

**i** De machine stopt automatisch wanneer het proces voltooid is.

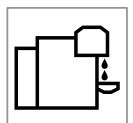
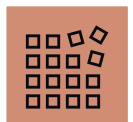

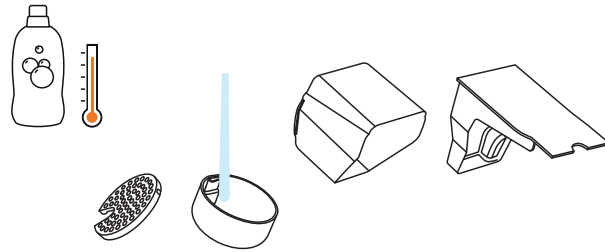

- 11** Reinig de bak voor gebruikte capsules, de kophouder en de lekbak met warm water en een mild geurloos reinigingsmiddel.

**LET OP:** Gebruik geen sterke of schurende reinigingsmiddelen of oplosmiddelen. Plaats de machine niet in de vaatwasser. Dompel de machine of onderdelen daarvan niet in water.

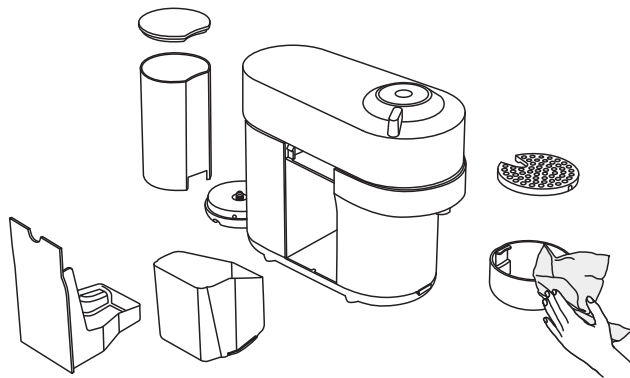

- 12** Droog de machine met een schone en droge theedoek. Laat de machine 10 minuten drogen voordat je hem gebruikt.

**OPMERKING:** Water kan zich ophopen in de kop van de machine tijdens het schoonmaken. Als dit gebeurt, droog de zichtbare onderdelen dan af met een schone, droge doek.

**OPMERKING:** De machine kan enkel in ontkalkingsmodus gaan nadat 30 of meer koffies zijn bereid.

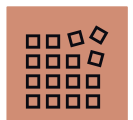

## HET SYSTEEM LEGEN

Leeg het systeem voor een periode van niet-gebruik, ter bescherming tegen vorst of een reparatie.

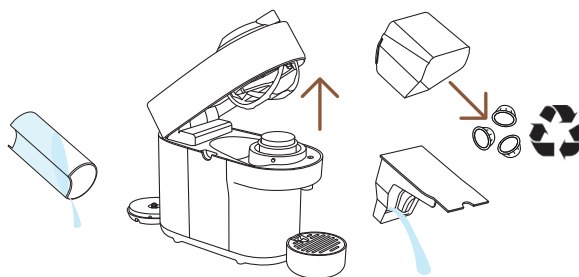

- 1 Leeg het waterreservoir en open de machine om de gebruikte capsule uit te werpen. Leeg en reinig de bak voor gebruikte capsules en de lekbak. Vergeet je **Nespresso** capsules niet te recyclen.\*

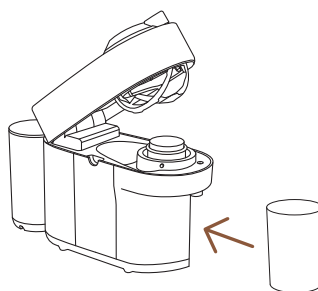

- 2 Plaats ze terug op de machine, verwijder de kophouder en plaats een lege bak (0.5 L) onder de koffie-uitloop.

\* DIT IS **NESPRESSO**. DIT IS RECYCLEBAAR. Voor meer informatie over het recyclen van jouw **Nespresso** capsules, ga naar [www.nespresso.com](http://www.nespresso.com)

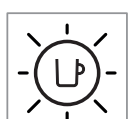
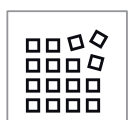

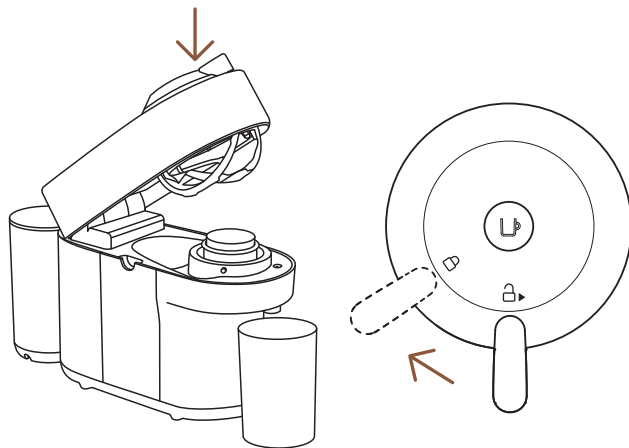

- 3** Met de machine aangesloten en aan, open en sluit de machine en schuif de hendel naar links naar de vergrendelpositie.

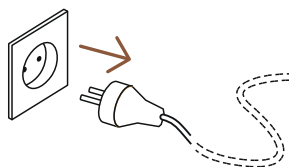

- 4** Haal de stekker uit het stopcontact.

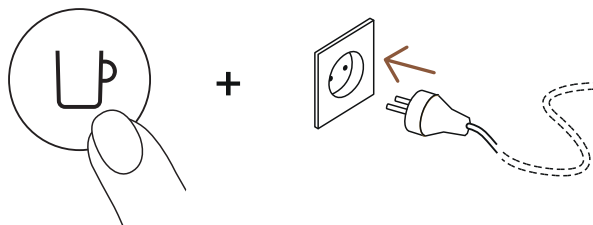

- 5** Houd de knop ingedrukt tijdens het aansluiten.

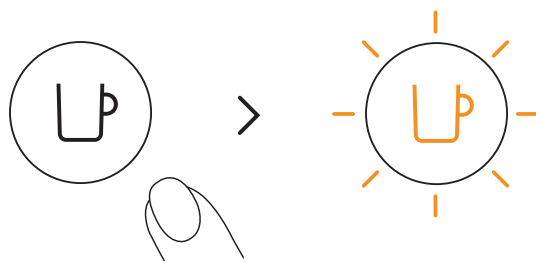

- 6** Laat de knop los. De lamp knippert oranje tijdens het proces.

- i** Het proces duurt ongeveer 30 seconden. De machine schakelt automatisch uit wanneer de machine leeg is.

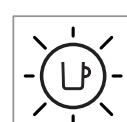
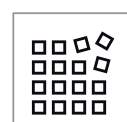
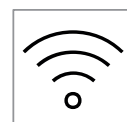

## DE FABRIEKSIINSTELLINGEN HERSTELLEN

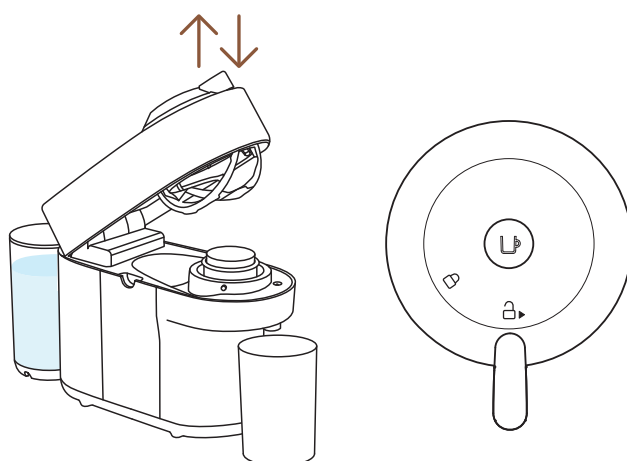

- 1 Met de machine aangesloten, open en sluit de machine en laat de hendel **ontgrendeld**.

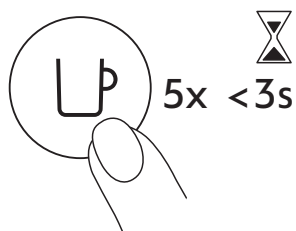

- 2 Druk 5 keer op de knop binnen 3 seconden. De fabrieksinstellingen zijn nu ingesteld.

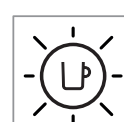
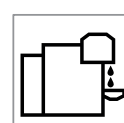
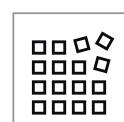
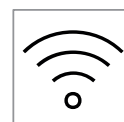

## OVERZICHT VAN HET KNIPPEREN

Wil je meer weten over het knippen van Vertuo Pop?  
Bekijk de volgende video:



## PROBLEMEN OPLOSSEN

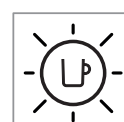
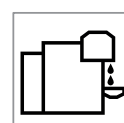
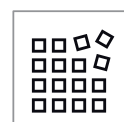
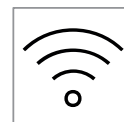

**Het lampje op de knop brandt niet.**

- De machine is automatisch uitgeschakeld; druk op de knop of ontgrendel de machine.
- Controleer het stroomnet, de stekker, de spanning en de zekering.

**Geen koffie, geen water.**

- Controleer of het waterreservoir gevuld is
- Controleer of de nieuwe capsule goed geplaatst is, dat de hendel volledig gesloten is en druk op de knop om te starten.
- Ontkalk de machine indien nodig.
- Open de machinekop om de gebruikte capsule te verwijderen. Start de reinigingsprocedure. Zie paragraaf 'Schoonmaken'.

**Koffie is niet warm genoeg.**

- Verwarm het kopje voor met warm kraanwater.
- Ontkalk de machine indien nodig.

**Lekkage of afwijkende doorstroming koffie.**

- Controleer of het waterreservoir correct geplaatst is.
- Ontkalk de machine indien nodig.

**Machine schakelt uit.**

- Om energie te besparen wordt de machine automatisch uitgeschakeld als de machine 2 minuten niet wordt gebruikt.
- De machine kan op elk moment (wanneer hij niet in gebruik is) handmatig uit worden gezet door de knop 3 seconden ingedrukt te houden.

**Koffiedik in de kopje.**

- Voer de reinigingsprocedure twee keer uit.
- Zie paragraaf 'Schoonmaken'.

**De machine start niet en het lampje brandt onafgebroken. Indien het lampje knippert, zie volgende punten.**

- Controleer of de hendel goed vergrendeld is.
- Als je een koffie wilt bereiden, controleer of de nieuwe capsule goed geplaatst is, of de hendel goed gesloten is en druk op de knop om te starten.
- Bij reinigen, ontkalken of leegmaken van het systeem, controleer of er geen capsule geplaatst is, vergrendel de machine en druk op de knop om te starten.

**De machine start niet en lampjes knipperen afwisselend: knippert een keer en dan weer een pauze.**

**Lampje knippert terwijl de machine bezig is.**

**De machine start niet en lampjes knipperen afwisselend: knippert een keer en dan weer een pauze.**

- Vul het waterreservoir en druk op de knop om te starten.
- Controleer of de hendel goed vergrendeld is.
- Als de koffie normaal stroomt, geeft dit aan dat de machine goed werkt.
- Als er slechts water doorstroomt, is de machine aan het reinigen, ontkalken of het systeem aan het leegmaken. Zie de bijbehorende sectie in deze handleiding.
- Druk gedurende 3 seconden op de knop om de machine uit te schakelen en druk een keer extra om de machine aan te zetten. Wacht ongeveer 20 minuten om de machine na langdurig gebruik af te laten koelen.
- Er is een korte vertraging voordat de koffie doorstroomt (vanwege barcodelezing en voorbevochtiging van de koffie).
- Controleer of de nieuwe capsule goed geplaatst is, dat de hendel volledig gesloten is en druk op de knop om te starten.
- Vul het waterreservoir en druk op de knop om te starten.
- Druk gedurende 3 seconden op de knop om de machine uit te schakelen en druk een keer extra om de machine aan te zetten. Wacht ongeveer 20 minuten om de machine na langdurig gebruik af te laten koelen.

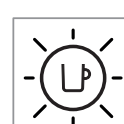
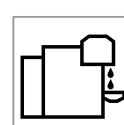
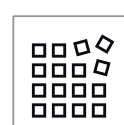
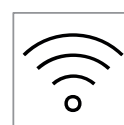



**Twee keer knippen en dan een onafgebroken lampje. De machine start niet.**

- Tijdens koffiebereiding:
  - 1) Ontgrendel de hendel en open de machine om te controleren of de nieuwe capsule correct geplaatst is
  - 2) Controleer of de hendel correct vergrendeld is.
  - 3) Controleer of het waterreservoir gevuld is.
- Tijdens ontkalken, leegmaken en reinigen:
  - 1) Controleer of de gebruikte capsule is uitgeworpen.
  - 2) Controleer of de hendel correct vergrendeld is.
- Tijdens volumeprogrammering:
  - 1) Controleer of de capsule correct geplaatst is.
  - 2) Raadpleeg het bijbehorende hoofdstuk **'Het koffievolume aanpassen'**.
- Als het probleem aanhoudt:
  - 1) Ontgrendel de hendel en open de machine.
  - 2) Plaats een nieuwe capsule (indien nodig).
  - 3) Haal de stekker uit het stopcontact. Wacht 10 seconden en steek opnieuw de stekker van de machine in het stopcontact.
  - 4) Sluit de machine en druk op de knop om koffiebereiding te starten.

Als het probleem aanhoudt, neem dan contact op met **Nespresso**.

**Lampje knippert drie keer en dan weer onafgebroken.**

- Ontkalkingsmelding: wanneer deze melding verschijnt, kan de machine nog enkele keren koffie bereiden. Daarna moet de machine ontkalkt worden.

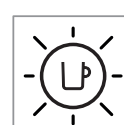
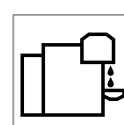
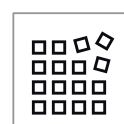
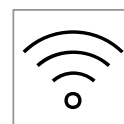

## SPECIFICATIES

<b>Stroom</b>	<b>~220-240 V, 50-60 Hz, 1300-1500 W</b> <b>US, CA:</b> 120 V, 60 Hz, 1500 W <b>MX:</b> 127 V~, 60 Hz, 1380 W
<b>Frequentie</b>	2.402-2.480 GHz
<b>RF Uitgangsvermogen (EIRP)</b>	Bluetooth 4 dBm Max. e.i.r.p. en Wi-Fi <20 dMm max. e.i.r.p.
<b>Stand-by</b>	0.39 W/h
<b>Energiebesparingsstand</b>	Automatisch uit na 2 minuten
<b>Opwarmtijd</b>	30 seconden (machine gesloten en vergrendeld)
<b>Aanpasbare kophouder voor grote recepten</b>	Verwijderbare enkele positie
<b>Kabellengte vanaf machine</b>	75 cm / 30 in
<b>Afmetingen (WxDxH)</b>	13.6 x 42.6 x 25 cm / 5.3 x 16.7 x 9.8 in
<b>Gewicht</b>	3.5 kg / 7.72 lbs
<b>Inhoud waterreservoir</b>	0.6 l / 20 fl oz
<b>Capaciteit bak voor gebruikte capsules</b>	8 espresso of 5 mug capsules

## MACHINECODES

<b>Nespresso</b>	<b>Breville</b>	<b>Delonghi</b>
GCV2, GDV2	BNV120, BNV150	ENV90
<b>Krups</b>	<b>Magimix</b>	
XN9201, XN9204, XN9205, XN9211	M800	



# KLIK OG VÆLG SPROG

DA



**SIKKEHED**



**OVERSIGT**



**TILSLUTNING**



**DE FØRSTE TRIN**



**KAFFETILBEREDNING**



**TILPAS DIN KAFFEMÆNGDE**



**RENGØRING**



**AFKALKNING**



**TØMNING AF SYSTEMET**



**NULSTIL TIL FABRIKSINDSTILLINGER**



**KORT BESKRIVELSE AF KNAPPERNES BLINK**



**FEJLFINDING**



**SPECIFIKATIONER**

## SIKKERHED

**ADVARSEL:** Læs venligst sikkerhedsanvisningerne før du bruger kaffemaskinen for at undgå potentielt farlige situationer og skader.

### BORTSKAFFELSE OG BESKYTTELSE AF MILJØ

Dette apparat overholder EU Direktiv 2012/19/EC. Emballage og apparat indeholder materialer, der kan genbruges. Dit apparat indeholder værdifulde materialer, der kan generhverves eller genbruges. Sortering af affaldsprodukter i forskellige typer, gør genbrug af værdifulde råvarer nemmere. Aflever apparatet på en genbrugsplads. Du kan finde oplysninger om bortskaffelse hos dine lokale myndigheder.

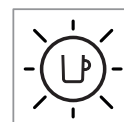
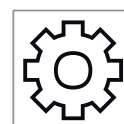
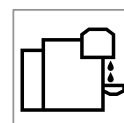
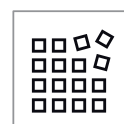
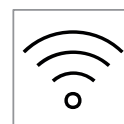

## OVERSIGT

## MASKINOVERSIGT

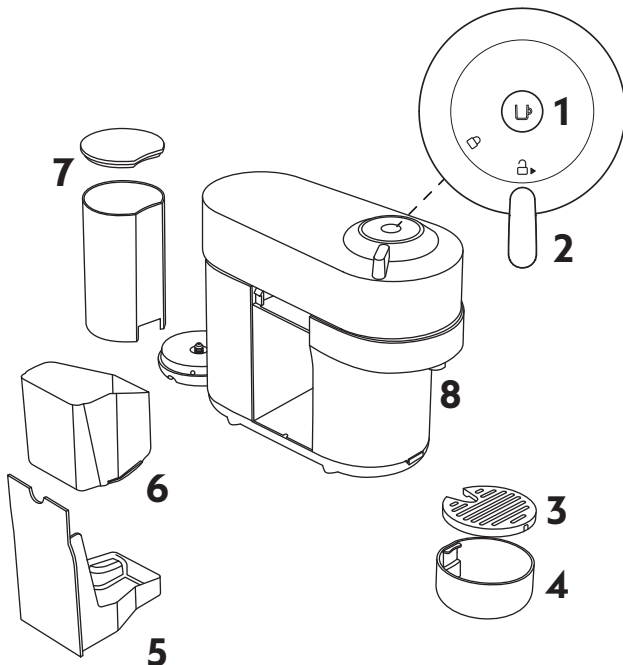

- 1 TÆND/SLUK og kaffeknap
- 2 Lås/aflys håndtag
- 3 Dryprist
- 4 Justerbar kopstøtte
- 5 Drypbakke
- 6 Kapselbeholder
- 7 Vandtank og låg
- 8 Kaffeudløb

## PAKKENS INDHOLD



- 1 Kaffemaskine
- 2 **Nespresso**-kapselboks
- 3 **Nespresso**-velkomstmateriale
- 4 Sikkerhedsanvisninger
- 5 Hurtigguide
- 6 Garanti

4 + 5 + 6

**i Udpakning:** Der kan være støv på maskinens overflade på grund af de genbrugsmaterialer, der anvendes i emballagen. Dette er ikke farligt, du kan blot rengøre med en blød klud. Fjern plastikfilmen når du pakker maskinen ud.

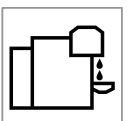

## ÅBEN/LUK

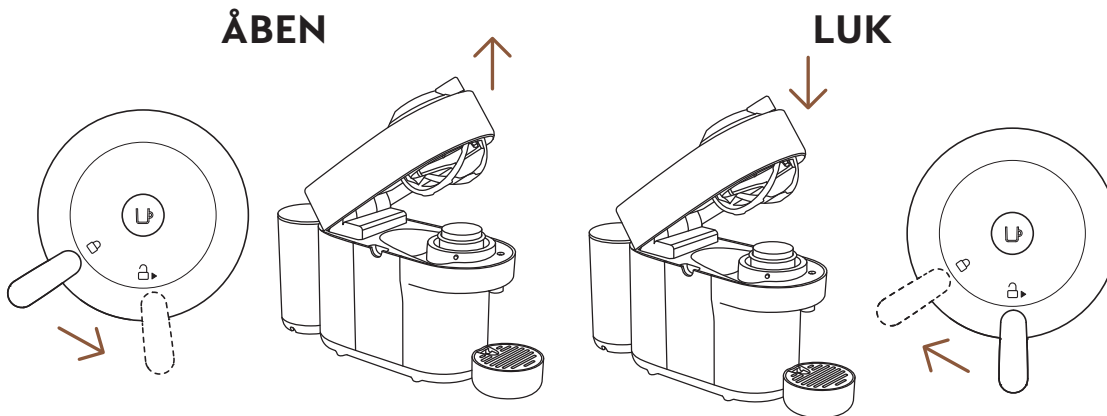

**FORSIGTIG:** For korrekt brug af maskinen skal du ikke åbne maskinhovedet mens kaffen brygger, vent indtil kaffeknappen bliver konstant hvid. Hvis du ønsker at stoppe brygningen tidligere, skal du trykke én gang på kaffeknappen og vente indtil maskinen stopper, før du åbner maskinhovedet.

## VERTUO-SYSTEMET

## KAPSELKOMPATIBILITET



S

**Ristretto**  
(25 ml)

**Espresso**  
(40 ml)



M

**Double Espresso**  
(80 ml)

**Gran Lungo**  
(150 ml)



L

**Mug**  
(230 ml)

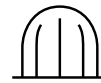

XL

**Alto, Cold Brew Style**  
(355 ml)

**Carafe**  
(535 ml)

## TILBEHØRSKOMPATIBILITET



Tilbehørs-  
kompatibi-  
litet



Ristretto



Espresso



Double  
Espresso



Gran  
Lungo



Mug (S)



Mug (M)



Reveal  
Glas



Ikke-egnet  
tilbehør



Mug (L)



Carafe

Opdag hele sortimentet af tilbehør på [www.nespresso.com](http://www.nespresso.com)

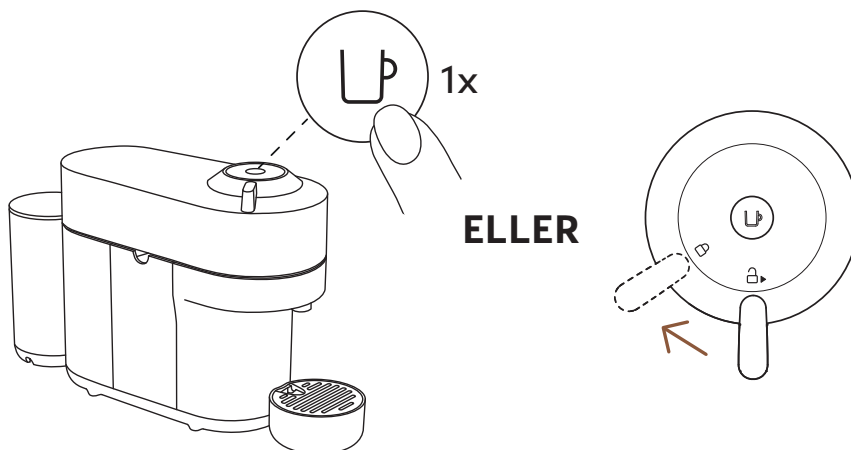

## TÆND/SLUK

**TÆND**

Når maskinen er tilkoblet, kan den tændes ved at trykke én gang på knappen, eller ved at lukke håndtaget i låst position (med hovedet lukket).

- i** Lampen vil blinke i cirka 30 sekunder mens maskinen opvarmer. Når lyset er konstant, er maskinen klar til brug.

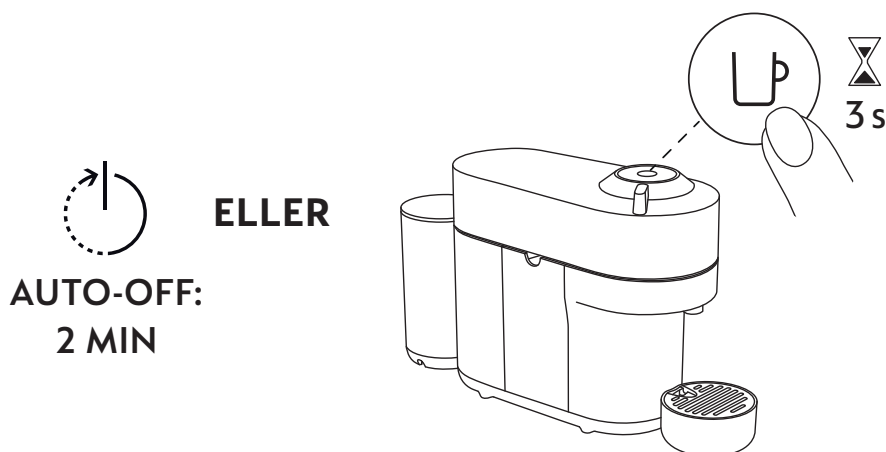
**SLUK**

For at spare på strøm vil maskinen slukke efter 2 minutter uden brug.

- i** Maskinen kan slås manuelt "FRA/OFF" når som helst (når den ikke er i brug) ved at trykke og holde knappen nede i 3 sekunder.



## TILSLUTNING

### HVORFOR SKAL DU PARRE DIN VERTUO POP-KAFFEMASKINE?

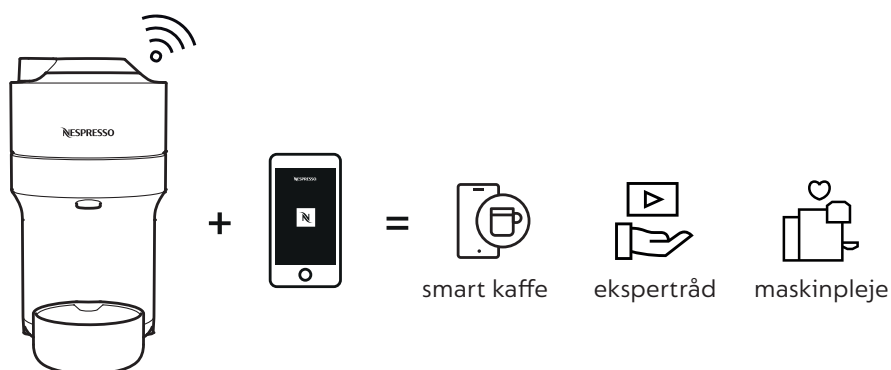

### FORDELE VED ATTILKOBLE DIN VERTUO POP-KAFFEMASKINE

- **Smart kaffe:** Hold dig altid opdateret på det sidste nye om vores kaffeinnovationer fra **Nespresso** ved at holde din maskine tip top og opdateret.
- **Eksperttråd:** Få support og simple oplæringsvideoer for at følge kafferejsen via din smartphone.
- **Maskinpleje:** Modtag de seneste notifikationer for hvordan og hvornår du skal servicere din maskine med en simpel guide for afkalkning, skylning, rengøring osv.

### HVORDAN TILKOBLER DU DIN VERTUO POP-KAFFEMASKINE?

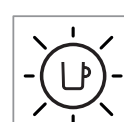
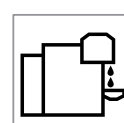
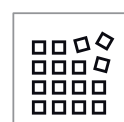



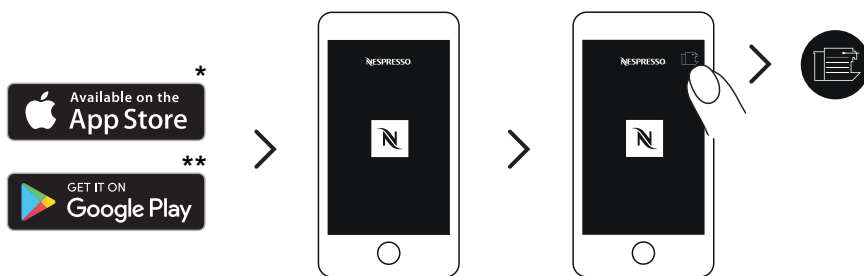

- 1** Download eller opdater **Nespresso**-appen. Start **Nespresso**-appen på din smartphone eller tablet. Tryk på maskinikonet øverst i højre hjørne af din skærm.

**BEMÆRK:** For optimal ydeevne og en problemfri oplevelse anbefaler vi at du tilslutter din maskine til en Wi-Fi router i stedet for at bruge et smartphone hotspot.

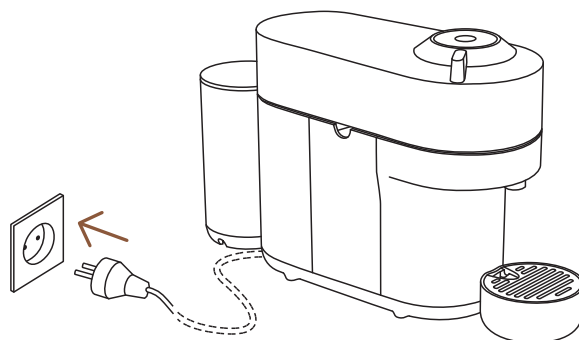

- 2** Sæt ledningen i.



- 3** Følg instruktionerne via **Nespresso**-appen.

**ADVARSEL:** Læs først sikkerhedsanvisningerne for at undgå faren for alvorligt elektrisk chok og brand. Sørg for at jordforbindelsen er korrekt, når du kobler maskinen til strømkontakten.

\* App Store® er et varemærke tilhørende Apple Inc., registreret i USA og andre lande.

\*\* Google Play og Google Play-logoet er varemærker tilhørende Google LLC.

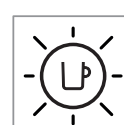
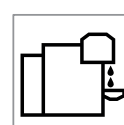
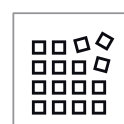

## FRAKOBLING AF MASKINENS BLUETOOTH OG WI-FI

Maskinen leveres med et tilslutningsmodul aktiveret som standard. Det giver adgang til yderligere funktioner for at forbedre din kaffeoplevelse. For at deaktivere tilslutningsmodulet skal du følge disse trin:

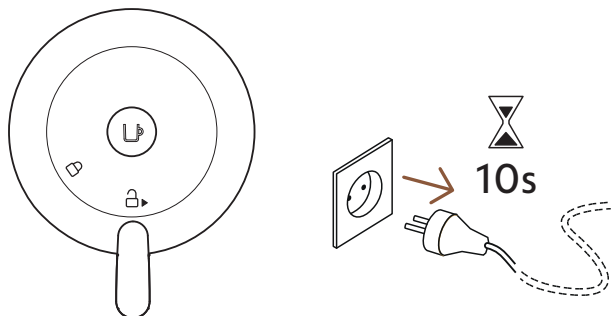

- 1 Med maskinen lukket og håndtaget i **ulåst** position, sørg for at frakoble maskinen i mindst 10 sekunder.

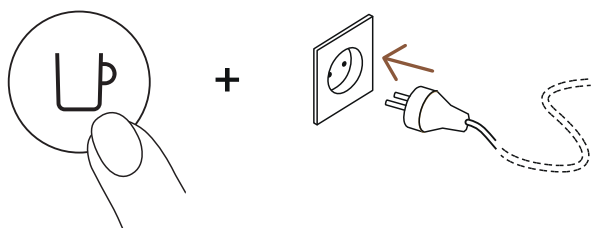

- 2 Tryk og hold knappen inde imens du sætter stikket i. Knappen vil blinke orange for at bekræfte at tilslutningsmodulet nu er blevet deaktiveret.
- i** Følg de samme trin for at aktivere tilslutningsmodulet igen. Knappen vil blinke hvidt for at bekræfte at tilslutningsmodulet er blevet reaktiveret.

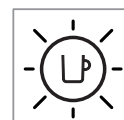
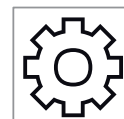
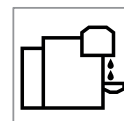
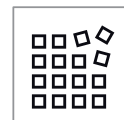

# FØRSTE TRIN

## FØRSTE RENGØRING

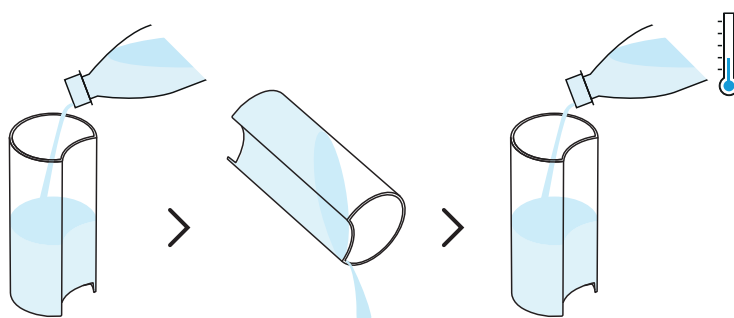

- 1** Skyl og rengør vandtanken og låget før du fylder den med frisk drikkevand.

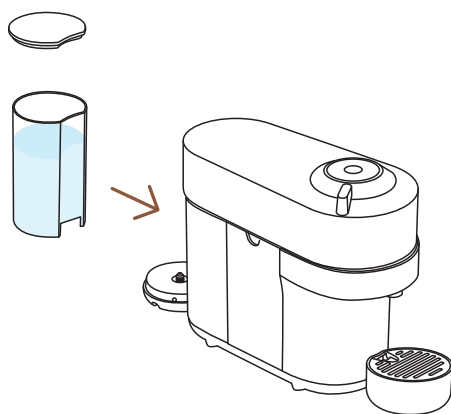

- 2** Sæt låg på vandtanken og sæt vandtanken tilbage, så den sidder ordentligt på plads.

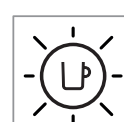
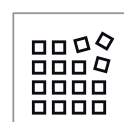
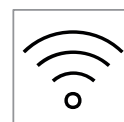

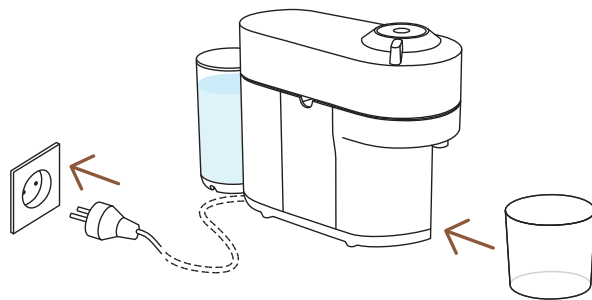

- 3** Med maskinen tilkoblet, fjern kopstøtten og placer en tom beholder (på mindst 1 L.) under kaffeudløbet.

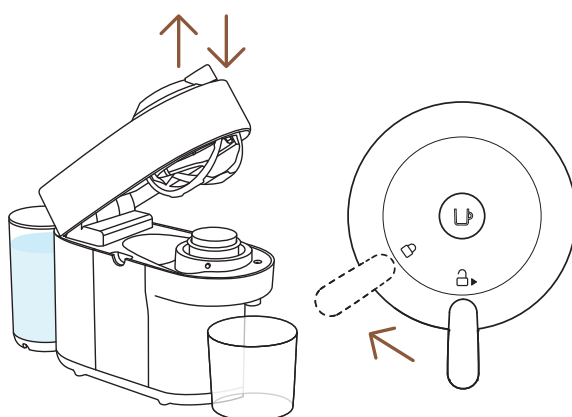

- 4** Åben og luk maskinen. Sørg for at håndtaget er låst

- i** Lampen vil blinke mens maskinen varmer op. Det vil tage cirka 30 sekunder. Når lyset er konstant er maskinen klar. Sørg for at der ikke er indsat en kapsel.

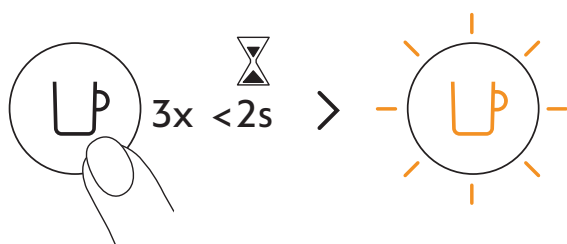

- 5** Tryk på knappen 3 gange inden for 2 sekunder for at starte skylningen. Med det orange blinklys, lad skylningsproceduren fuldføres automatisk. Når lyset er konstant hvidt, er proceduren fuldført.

- i** Det bør tage mindre end 2 minutter før skylningsprocessen starter og vandet begynder at strømme. Denne procedure vil tage op til 7 minutter.

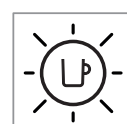
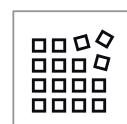
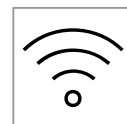

# KAFFETILBEREDNING

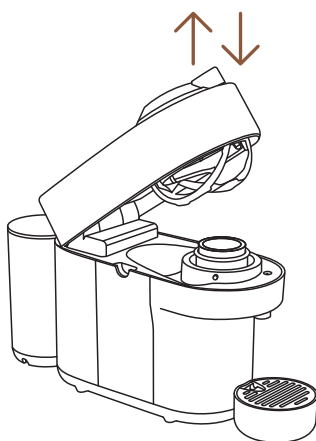

**1** Åben og luk maskinen.

**i** Kaffeknappens lys vil blinke mens maskinen varmer op. Når lyset bliver konstant, er maskinen klar til brug.

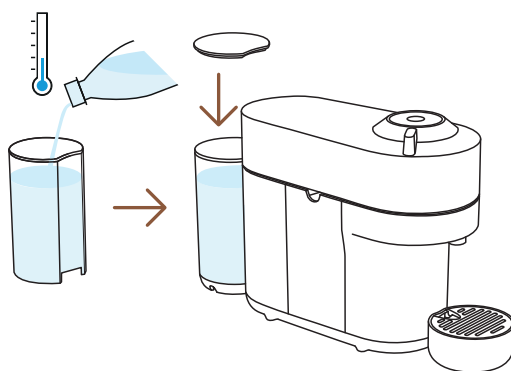

**2** Fyld vandtanken med frisk drikkevand og sæt den tilbage på plads.

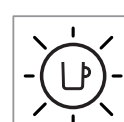
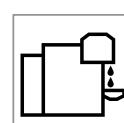
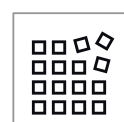
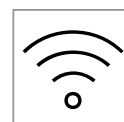

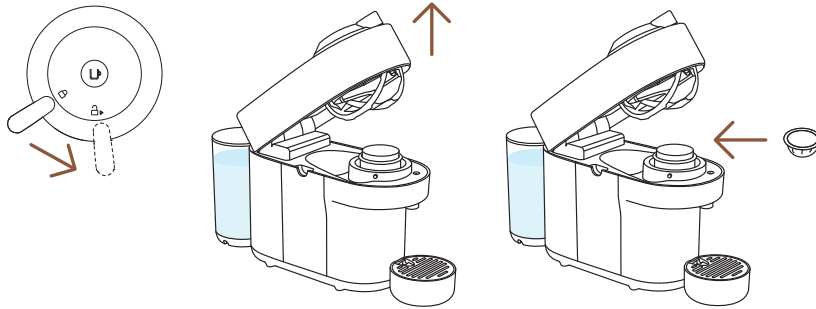

- 3** Lås op og åben maskinhovedet helt op og indsæt en Vertuo-kaffekapsel med kuppelformen vendt ned.

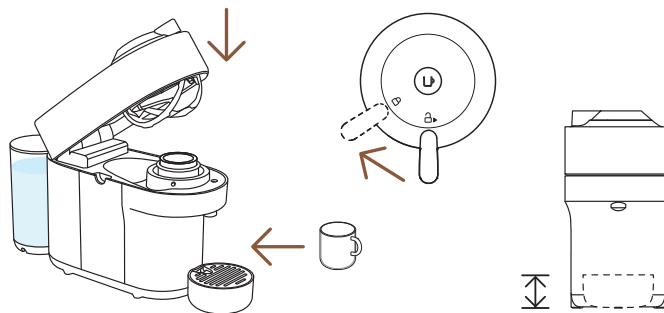

- 4** Luk maskinhovedet og lås ved at dreje håndtaget til venstre indtil det er låst, og placer en kop. Kopstøtten kan justeres så den passer til din kopstørrelse.

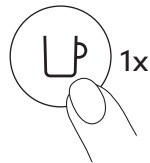

- 5** Start brygningen ved at trykke en enkelt gang på knappen

**FORSIGTIG:** For korrekt brug af maskinen skal du ikke åbne maskinhovedet mens kaffen brygger, vent indtil kaffeknappen bliver konstant hvid. Hvis du ønsker at stoppe brygningen tidligere, skal du trykke én gang på kaffeknappen og vente indtil maskinen stopper, før du åbner maskinhovedet.

- i** På grund af kodeaflysning, kaffe-forbefugtning og infusionstid vil det tage et øjeblik før kaffen begynder at strømme. Maskinen vil automatisk genkende den indsatte kaffekapsel og vælge de kaffeforbereelsesparametre og kopstørrelse defineret af **Nespresso**-kaffeekspertes for at ekstrahere kaffeblendingen på bedste vis.



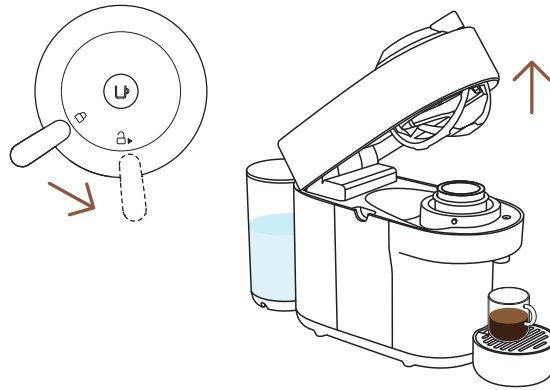

- 6** Når kaffen stopper med at brygge, åben maskinhovedet ved at dreje håndtaget til højre mod ulåst position for automatisk at lade kapslen falde ud, og nyd din kaffe.



- 7** Glem ikke at genanvende dine **Nespresso**-kaffekapsler\*.

\* DETTE ER **NESPRESSO**. DETTE ER GENANVENDELIGT. For mere information om genanvendelse af din **Nespresso**-kaffekapsel, besøg [www.nespresso.com](http://www.nespresso.com)

## UDFORSK VORES COFFEE CREATIONS-FUNKTION



Med denne maskine tilbyder **Nespresso** dig en specifik funktion til at koncentrere dine kaffebrygninger og skabe dine egne opskrifter.

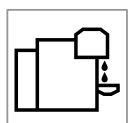

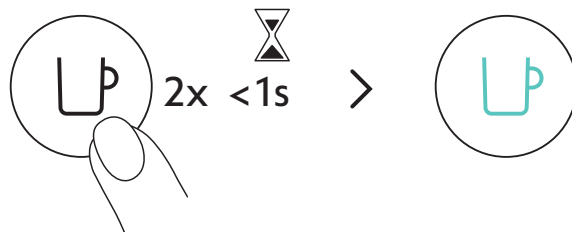

Med maskinen tændt, klik to gange på kaffeknappen. Den vil blinke turkis og din kaffebrygning vil blive koncentreret, hvilket optimerer kaffesmagen i opskrifter med tilføjelser (mælk, fløde, isterninger). For uovertrufne kaffeoplevelser.

40 ml	80 ml	150 ml	230 ml	355 ml	535 ml
✓	✓	✓	✓	✗	✗
25 ml	40 ml	40 ml	80 ml		

For at kunne nyde fordelene til fulde anbefaler vi at brygge vores Coffee+-sortiment i de officielle kopstørrelser. For at få det bedste resultat anbefaler vi at man ikke brygger vores XL (Alto Onice), Cold Brew Style & Carafe Pour Over Style med denne funktion.

**BEMÆRK:** En opdatering af din maskine via **Nespresso** Appen kan være nødvendig for at aktivere denne funktion.

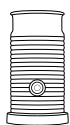

Opdag hvordan du opgraderer din maskine med vores Aeroccino-sortiment på [www.nespresso.com](http://www.nespresso.com)

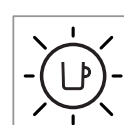
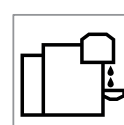
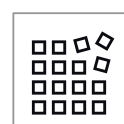
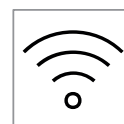



## TILPAS DINE KAFFESTØRRELSER

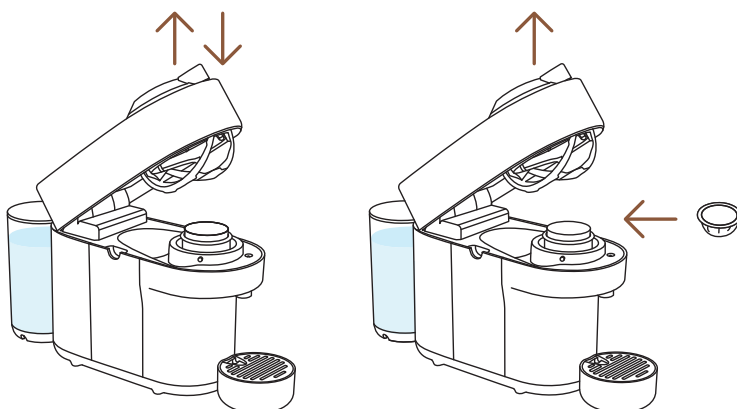

- 1** Åben og luk maskinen. Med maskinen tændt, åben maskinhovedet og indsæt den kaffekapsel du vil programmere.

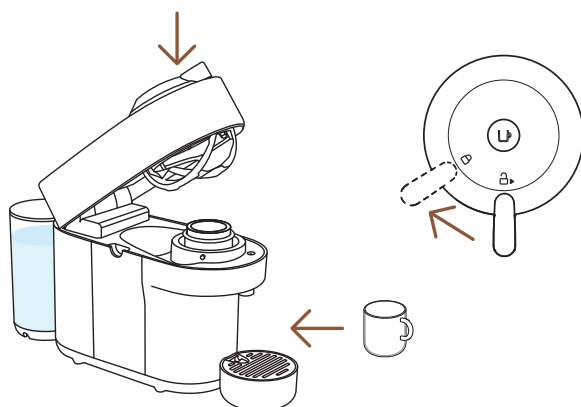

- 2** Luk maskinhovedet, drej håndtaget til venstre mod låsepositionen og placer en kop.

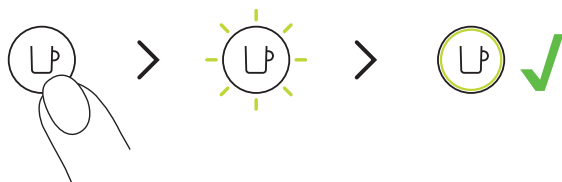

- 3** Tryk og hold knappen inde, og slip den et par sekunder inden den ønskede mængde er nået. Den nye vandmængde er nu programmeret til kapseltypen brugt under indstillingen.

- i** Programmeringen er specifik til hver kapseltype. Kopstørrelser kan programmeres fra 20 ml til 535 ml.

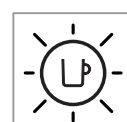
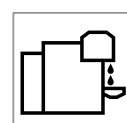
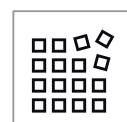
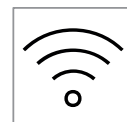
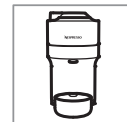

**FORSIGTIG:** For korrekt brug af maskinen skal du ikke åbne maskinhovedet mens kaffen brygger, vent indtil kaffeknappen bliver konstant hvid. Hvis du ønsker at stoppe brygningen tidligere, skal du trykke én gang på kaffeknappen og vente indtil maskinen stopper, før du åbner maskinhovedet.

**BEMÆRK:** Når en kundespecifik volumen er programmeret af brugeren vil tilberedningen stoppe ved den brugerprogrammerede kopstørrelse, hver gang den kapseltype indsættes i maskinen. Hvis du ønsker at vende tilbage til standardindstillingerne, se afsnittet **“Gendan til fabriksindstillinger”**

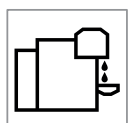

## RENGØRING

Rengør din maskine en gang om måneden, når du begynder at have kafferester i maskinhovedet, eller efter en lang periode uden brug.

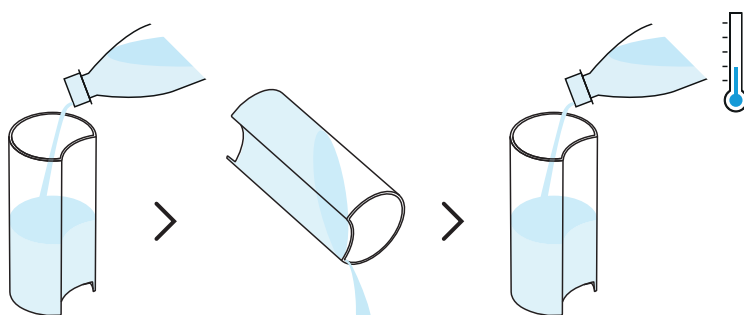

- 1** Skyl og rengør vandtanken og låget før du fylder den med frisk drikkevand.

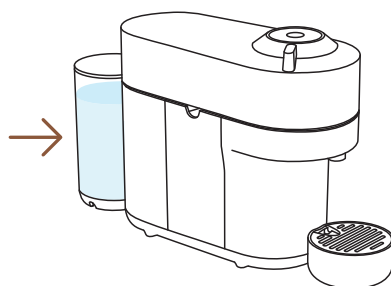

- 2** Sæt vandtanken tilbage på plads på maskinen.

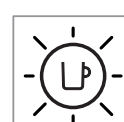
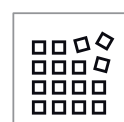
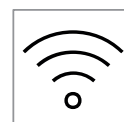

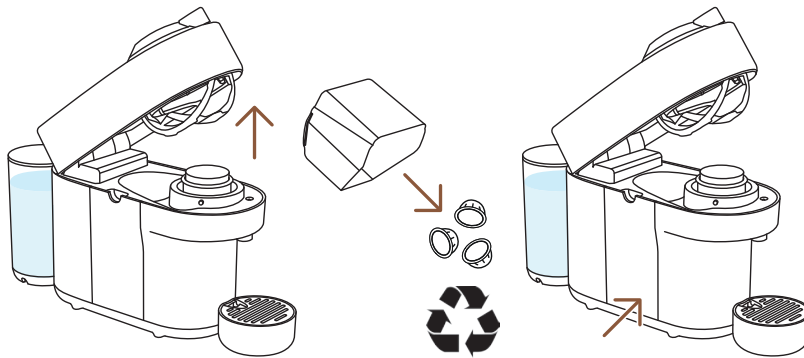

- 3** Med maskinen tændt, lås op og åben maskinen og lad den brugte kaffekapsel falde ud. Tøm og skyl kapselbeholderen og drypbakken og sæt dem tilbage på plads. Glem ikke at genanvende dine **Nespresso**-kaffekapsler\*.

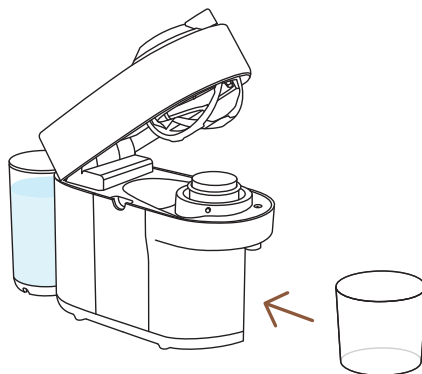

- 4** Fjern kopstøtten og placer en tom beholder (min. 1 L) under kaffeudløbet.

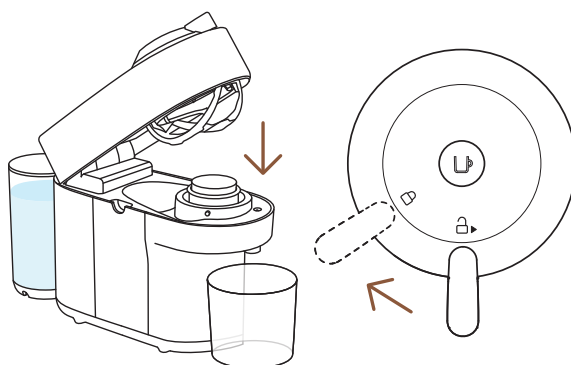

- 5** Luk maskinhovedet og drej håndtaget til venstre mod låst position. Sørg for at ingen kaffekapsler er tilbage i maskinen før du starter skylleproceduren.

\* DETTE ER **NESPRESSO**. DETTE ER GENANVENDELIGT. For mere information om genanvendelse af din **Nespresso**-kaffekapsel, besøg [www.nespresso.com](http://www.nespresso.com)

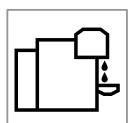

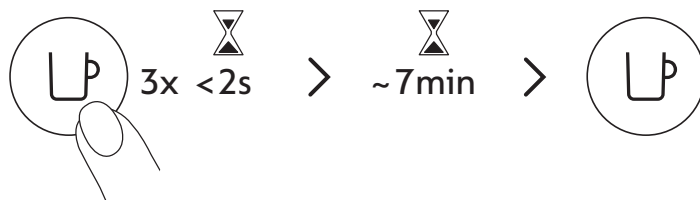

**6** Tryk på knappen 3 gange inden for 2 sekunder for at starte skylningen. Når lyset blinker orange, lad skylleproceduren udføres automatisk.

**i** Det bør tage mindre end to minutter før skylleprocessen starter, og vandet begynder at strømme. Denne proces kan tage op til 7 minutter og vil afsluttes automatisk når processen er fuldført. Denne procedure kan altid stoppes igen ved at trykke på knappen.

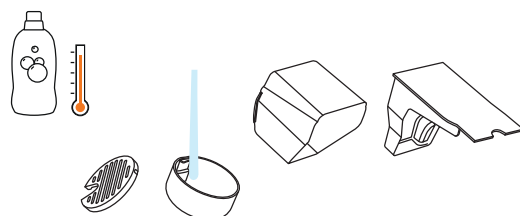

**7** Vask kapselbeholderen, kopstøtten og drypbakken med varmt vand og mild, uparfumeret rengøringsmiddel.

**ADVARSEL:** Brug ikke noget stærkt eller slibende rengørings- eller opløsningsmiddel. Må ikke komme i opvaskemaskinen. Sænk aldrig apparatet eller dele af det i vand.

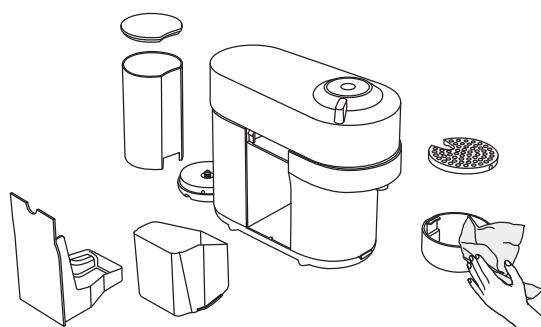

**8** Tør med et rent viskestykke.

**ADVARSEL:** Rengør kaffeudløbet regelmæssigt med en ren, fugtig klud. Brug altid bløde klude til at rengøre maskinen.

**BEMÆRK:** Vand kan samle sig i maskinens hoved. Skulle dette forekomme, tør dele af maskinen af med en ren og tør klud.

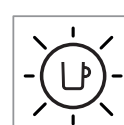
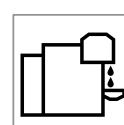
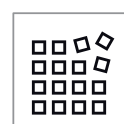
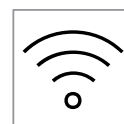

## AFKALKNING

Afkalkning af din maskine vil sikre at den fungerer korrekt under hele dens levetid, og vil gøre din kaffeoplevelse ligeså fantastisk som på den første dag. Din maskine vil indikere når afkalkning er nødvendig ved at blinke orange 3 gange.



**i** Afkalkningen tager ~20 minutter og **kan ikke afbrydes**.

**BEMÆRK:** Læs venligst anvisningerne for afkalkning før du starter.

### Du får brug for:

- Et afkalkningsæt tilgængeligt på [www.nespresso.com](http://www.nespresso.com)
- En tom beholder (på 1 L.)

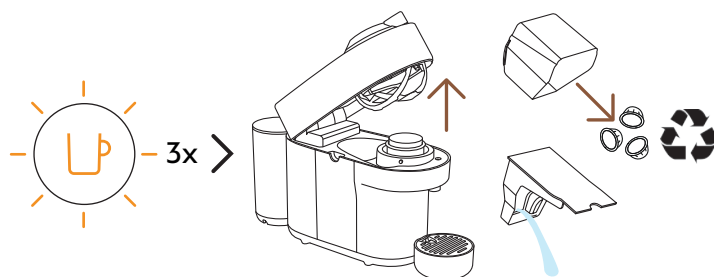

- 1** Når knappen blinker orange 3 gange: Lås op og åben maskinhovedet og lad den brugte kaffekapsel falde ud. Tøm kapselbeholderen og drypbakken og sæt dem tilbage på plads på maskinen. Glem ikke at genanvende dine **Nespresso**-kaffekapsler\*.

\* DETTE ER **NESPRESSO**. DETTE ER GENANVENDELIGT. For mere information om genanvendelse af din **Nespresso**-kaffekapsel, besøg [www.nespresso.com](http://www.nespresso.com)

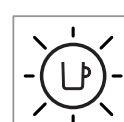
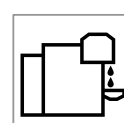
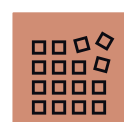
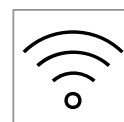

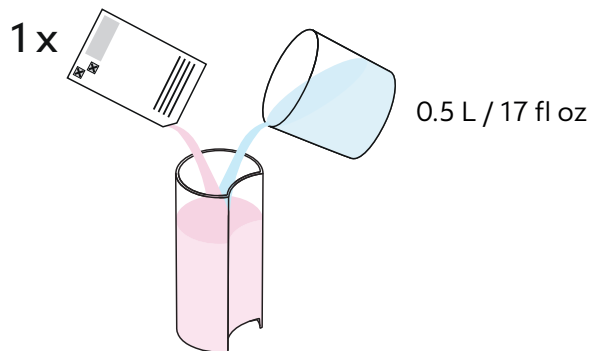

- 2** Fyld vandtanken med 0,5 L. vand og tilsæt 1 enhed af **Nespresso** afkalkningsvæske.

**ADVARSEL:** Bemærk venligst at afkalkningsopløsningen kan være skadelig. Undgå kontakt med øjne, hud og overflader.

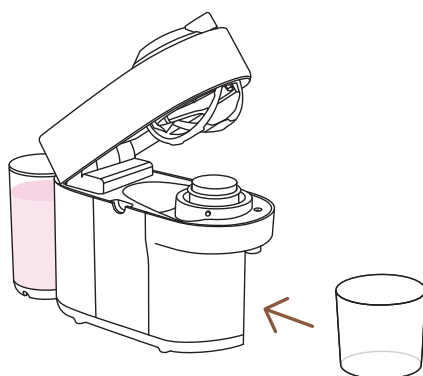

- 3** Fjern kopstøtten og placer en tom beholder (på min. 1 L.) under kaffeudløbet.

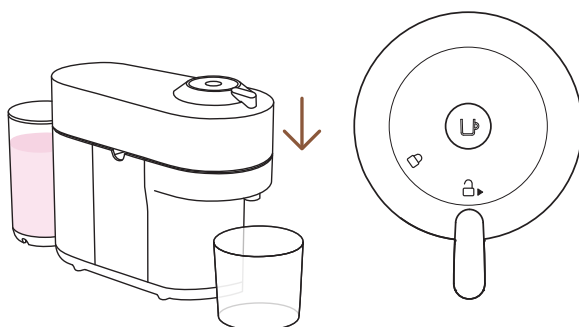

- 4** Med maskinen tændt, luk maskinhovedet og lad håndtaget forblive i ulåst position.

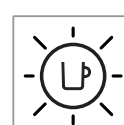
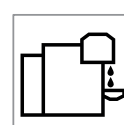
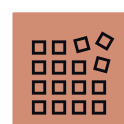
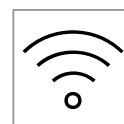

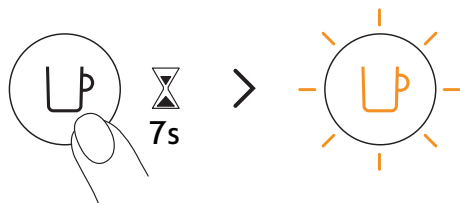

- 5** Hold knappen nede i mindst 7 sekunder eller indtil lyset slukker. Knappen vil begynde at blinke hurtigt orange.

**ADVARSEL:** Du har nu 45 sekunder til at starte afkalkningen, ellers vil maskinen gå tilbage til brygningen.

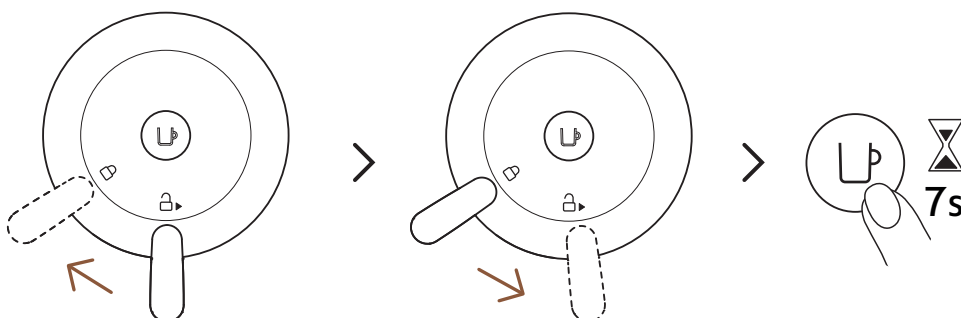

- 6** Lås maskinhovedet ved at dreje håndtaget til venstre mod låsesymbolet, og lås op med håndtaget ved at dreje det til højre i ulåst position. Tryk og hold knappen nede igen i cirka 7 sekunder eller indtil lysene slukker. Knappen vil begynde at blinke orange hurtigt.

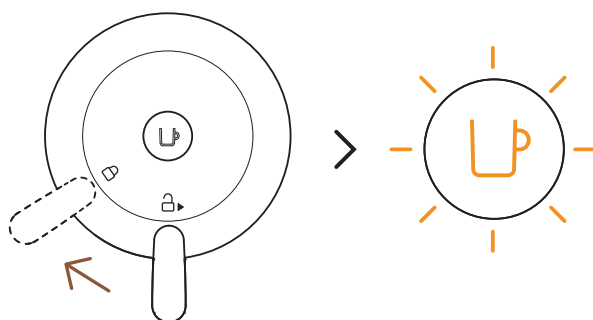

- 7** For at starte afkalkning, lås maskinen ved at dreje håndtaget til venstre mod låst position. Lysene bør stadig blinke hurtigt orange. Dette indikerer at du har startet afkalkning.

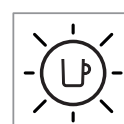
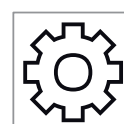
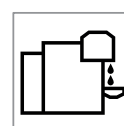
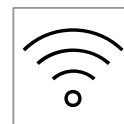



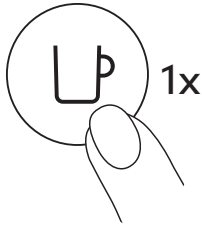

- 8** Tryk på kaffeknappen én gang for at påbegynde afkalkningsprocessen. Lysene vil blinke orange kontinuerligt under processen.

- i** Maskinen vil automatisk stoppe, når den første del af afkalkningen er fuldført.

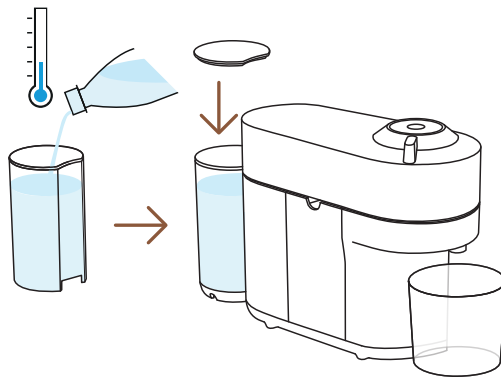

- 9** Når afkalkningsprocessen er ved at være slut, er det tid til at skylle maskinen. Skyl vandtanken og drypbakken grundigt. Fyld vandtanken med frisk drikkevand og sæt den tilbage på plads. Tøm beholderen og sæt den tilbage under kaffeudløbet.

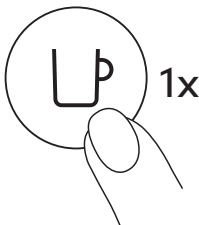

- 10** Tryk på knappen for at skylle maskinen. Når knappen stopper med at blinke hurtigt og bliver konstant, er afkalkningsproceduren fuldført.

- i** Maskinen vil automatisk stoppe når proceduren er fuldført.

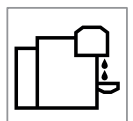

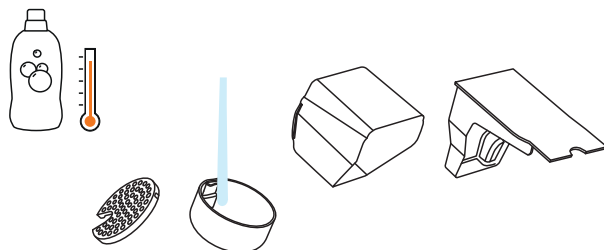

- 11** Vask kapselbeholderen, kopstøtten og drypbakken med varmt vand og mild, uparfumeret rengøringsmiddel.

**ADVARSEL:** Brug ikke noget stærkt eller slibende rengørings- eller opløsningmiddel. Sæt ikke maskinen i opvaskemaskinen. Sænk aldrig apparatet eller dele af det i vand.

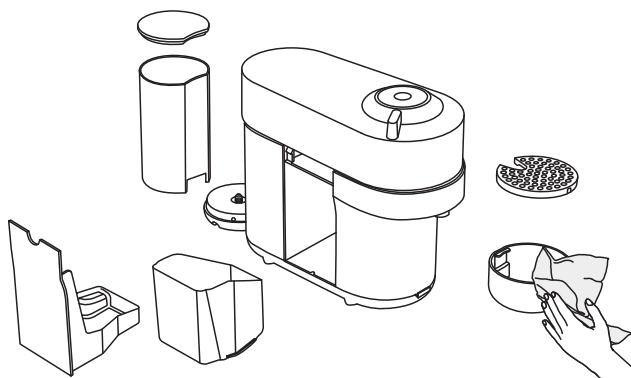

- 12** Tør maskinen med et rent og frisk håndklæde. Lad maskinen tørre i 10 minutter før brug.

**BEMÆRK:** Det kan forekomme at vand samles i maskinhovedet under rengøring. Hvis dette forekommer, tør synlige dele med en tør klud.

**BEMÆRK:** maskinen kan først skifte til afkalkning efter mere end 30 kaffer er blevet brygget.

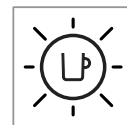
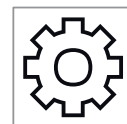
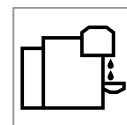
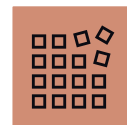
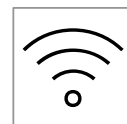

## TØM SYSTEMET

Tømning af systemet er en proces, der kan udføres før en periode uden brug, for frostbeskyttelse, eller før maskinen sendes til reparation.

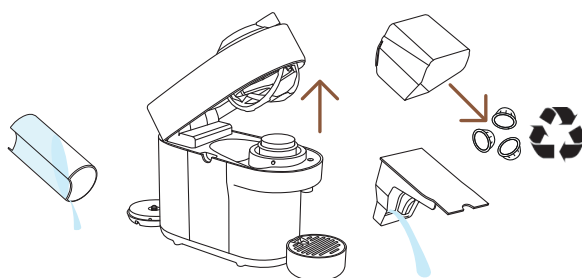

- 1** Tøm vandtanken, åben maskinhovedet og lad den brugte kaffekapsel falde ud. Tøm kapselbeholderen og drypbakken. Glem ikke at genanvende dine **Nespresso**-kaffekapsler\*.

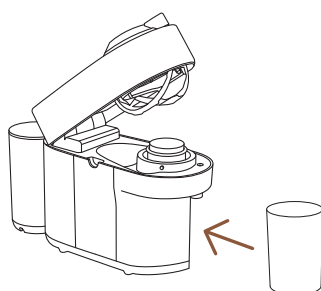

- 2** Sæt dem tilbage på plads på maskinen, fjern kopstøtten og placer en tom beholder (0,5 L.) under kaffeudløbet.

\* DETTE ER **NESPRESSO**. DETTE ER GENANVENDELIGT. For mere information om genanvendelse af din **Nespresso**-kaffekapsel, besøg [www.nespresso.com](http://www.nespresso.com)

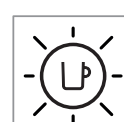
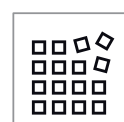
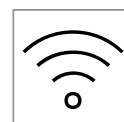

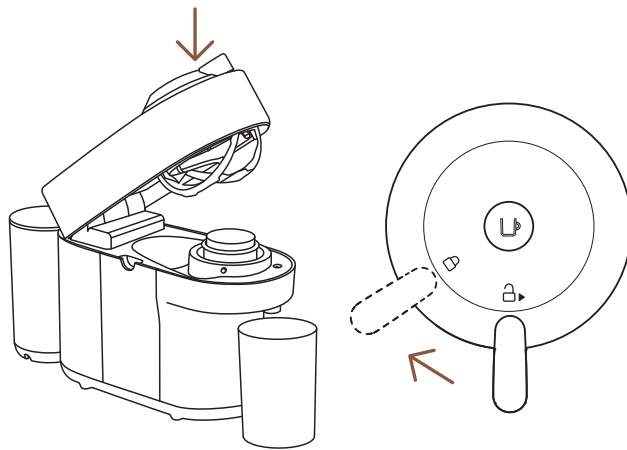

- 3** Med maskinen koblet til og tændt, drej håndtaget mod låst position.

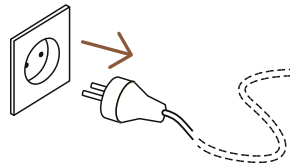

- 4** Træk maskinens stik ud af stikkontakten.

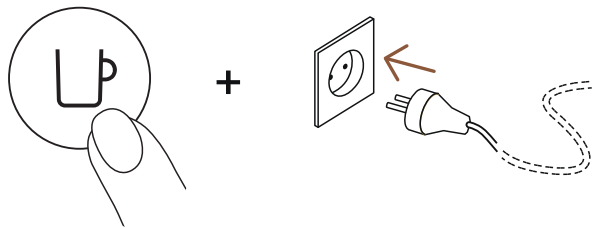

- 5** Tryk og hold knappen inde imens du sætter stikket i.



- 6** Slip knappen. Den vil blinke orange og tømningssprocessen vil starte.

- i** Det vil tage cirka 30 sekunder før maskinen fuldfører tømningssprocessen. Maskinen slukker automatisk når den er tømt.



## GENDAN TIL FABRIKSINDSTILLINGER

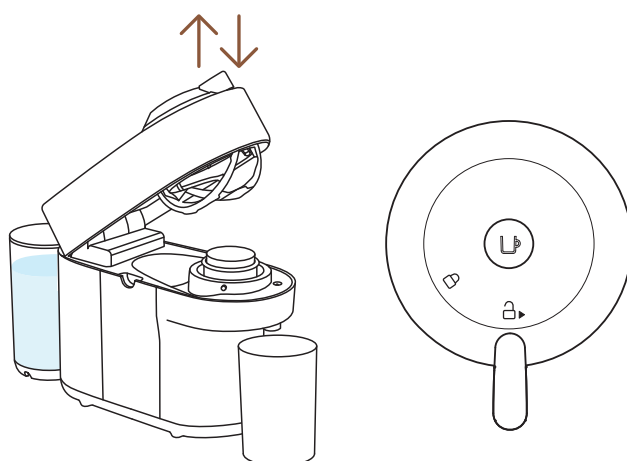

- 1 Med maskinen koblet til, åben og så luk maskinhovedet før håndtaget sættes i **ulåst** position.

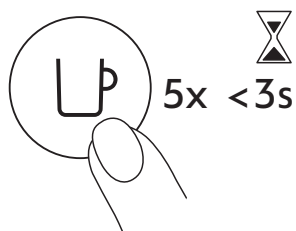

- 2 Tryk herefter på knappen 5 gange inden for 3 sekunder. Maskinen er nu indstillet til fabriksindstillinger.

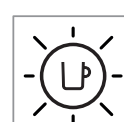
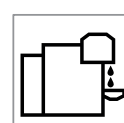
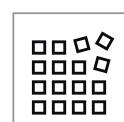
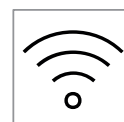

## KORT BESKRIVELSE AF KNAPPERNES BLINK

Søger du mere information om blinkene på Vertuo Pop?  
Se venligst følgende video:

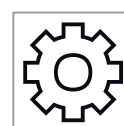
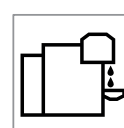
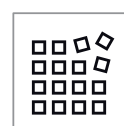
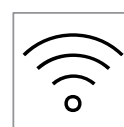

## FEJLFINDING

- Ingen lys i knappen.**
- Maskinen er slukket automatisk; tryk på knappen eller "LÅS OP" for maskinen.
  - Tjek nettet, stik, spænding og sikring.
- Ingen kaffe, ingen vand.**
- Tjek at vandtanken er fyldt.
  - Tjek at en ny kaffekapsel er indsat korrekt, håndtaget er lukket rigitgt og tryk på knappen for at starte.
  - Afkalk hvis nødvendigt.
  - Åben maskinens låg og lad kaffekapslen falde ud. Lav herefter en rengøring, som beskrevet i rengørings-sektionen.
- Kaffen er ikke varm nok.**
- Forvarm din kop med varmt vand i hanen.
  - Afkalk hvis nødvendigt.
- Lækage eller udsædvanlig kaffe flow.**
- Tjek at vandtanken sidder korrekt.
  - Afkalk hvis nødvendigt.
- Maskinen skifter til "OFF-tilstand".**
- For at sparre strøm vil maskinen slukke efter 2 minutter uden brug.
  - Maskinen kan slukkes manuelt når som helst (når den ikke er i brug) ved at trykke og holde knappen nede i 3 sekunder
- Kaffegrums i koppen.**
- Gå igennem rengørings-proceduren to gange.
  - Se afsnittet "Rengøring".
- Maskinen vil ikke starte og lyser konstant. Hvis den blinker, se de følgende punkter.**
- Tjek at håndtaget er korrekt låst.
  - Hvis du ønsker at brygge en kop kaffe eller en Espresso, tjek først at din kaffekapsel er indsat korrekt, håndtaget er låst korrekt og tryk herefter på knappen for at starte
  - Hvis du rengører, afkalker eller tømmer systemet, tjek at der ikke sidder en kaffekapsel i og luk herefter, lås maskinen og tryk på knappen for at starte en af aktiviteterne.
- Maskinen vil ikke starte og lys blinker skiftevis: 1 blink og herefter 1 pause.**
- Fyld vandtanken og tryk på knappen for at starte.
  - Tjek at maskinens håndtag er låst korrekt.

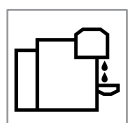

## Lyset blinker mens maskinen er i gang.

- Hvis kaffen løber normalt betyder det, at maskinen virker ordentligt.
- Hvis kun vand strømmer ud, udfører maskinen en brugeranmodning om enten rengøring, afkalkning eller tømning af systemet. Se venligst det rette afsnit i brugermanualen.
- Sæt maskinen i "OFF-tilstand" ved at trykke på knappen i 3 sekunder og tryk herefter igen for at skifte maskinen til ON. Du bør nu vente omkring 20 minutter for at lade maskinen køle ned efter det omfattende brug.

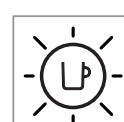
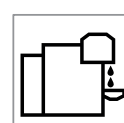
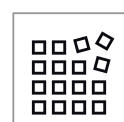
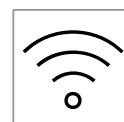

## Maskinen vil ikke starte og lys blinker skiftevis: 1 blink og herefter 1 pause.

- Det vil tage noget tid før der kommer et kaffe flow (grundet stregkoden skal læses og der skal løbe vand ind til kaffen).
- Tjek at en ny kaffekapsel er indsat korrekt, håndtaget er lukket rigtigt og tryk på knappen for at starte.
- Fyld vandtanken og tryk på knappen for at starte.
- Sæt maskinen i "OFF-tilstand" ved at trykke på knappen i 3 sekunder og tryk herefter igen for at skifte maskinen til "ON". Du bør nu vente omkring 20 minutter for at lade maskinen køle ned efter det omfattende brug.

## Lys blinker hele tiden skiftevis mellem at blinke 2 gange og så 1 pause. Maskinen brygger ikke.

- Under en normal brygning af Kaffe/Espresso:
  - 1) Aflås håndtaget og åben maskinens låg, for at tjekke at den nye kaffekapsel er ubeskadiget og indsat korrekt.
  - 2) Tjek at håndtaget er i "LÅST" position.
  - 3) Tjek at vandtanken er fyldt.
- Under afkalkning, tømning eller rengøring:
  - 1) Tjek at kaffekapslen er væk.
  - 2) Tjek at håndtaget er i "LÅST" position.
- Under indstilling af vandmængde:
  - 1) Kontroller at kaffekapslen er blevet indsat korrekt
  - 2) Se venligst det rette afsnit i brugermanualen.



**Lys blinker skiftevis  
3 gange og lyser  
herefter konstant.**

- Hvis problemet bliver ved:
  - 1) Lås håndtaget op og åben maskinens låg.
  - 2) Erstat kaffekapslen (hvis nødvendigt).
  - 3) Træk stikket ud af stikkontakten og sæt strøm til maskinen igen efter 10 sekunder.
  - 4) Luk låget og tryk på knappen for at skifte til ON og tryk igen for at starte kaffebrygning.

Hvis problemet bliver ved bedes du ringe til **Nespresso**.
- Afkalkning er nødvendig: maskinen kan godt bruges få gange efter alarmeren vises før, at afkalkning vil være en nødvendighed da maskinen blokeres.

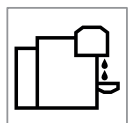

## SPECIFIKATIONER

<b>Strøm</b>	<b>~220–240 V, 50–60 Hz, 1300–1500 W</b> <b>US, CA:</b> 120 V, 60 Hz, 1500 W <b>MX:</b> 127 V~, 60 Hz, 1380 W
<b>Frekvens</b>	2.402–2.480 GHz
<b>RF-udgangseffekt (EIRP)</b>	Bluetooth 4 dBm Max. e.i.r.p og Wi-Fi <20 dMm max e.i.r.p.
<b>Standby</b>	0.39 W/h
<b>Energibesparellestilstand</b>	Auto-off efter 2 min.
<b>Opvarmningstid</b>	30 sekunder (hoved lukket og låst)
<b>Justerbar kopstøtte for større opskrifter</b>	Aftagelig enkeltposition
<b>Kabellængde fra enhedens afsendelse</b>	75 cm / 30 in
<b>Dimensioner (BxDxH)</b>	13.6 x 42.6 x 25 cm / 5.3 x 16.7 x 9.8 in
<b>Vægt</b>	3.5 kg / 7.72 lbs
<b>Vandtankkapacitet</b>	0.6 l / 20 fl oz
<b>Kapselbeholderkapacitet</b>	8 Espresso- eller 5 Mug-kaffekapsler

## MASKINKODER

<b>Nespresso</b>	<b>Breville</b>	<b>Delonghi</b>
GCV2, GDV2	BNV120, BNV150	ENV90
<b>Krups</b>	<b>Magimix</b>	
XN9201, XN9204, XN9205, XN9211	M800	

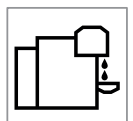
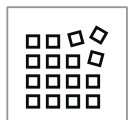

# KLIKK OG VELG SPRÅK

NO



**SIKKERHET**



**OVERSIKT**



**TILKOBLING**



**DE FØRSTE STEGENE**



**KAFFETILBEREDNING**



**TILPASS KAFFEMENGDE**



**RENGJØRING**



**AVKALKING**



**TØMMING AV SYSTEMET**



**TILBAKESTILL TIL  
FABRIKKINNSTILLINGER**



**BESKRIVELSE AV BLINKING PÅ  
KNAPPENE**



**FEILSØKING**



**SPESIFIKASJONER**

## SIKKERHET

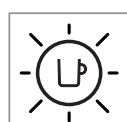
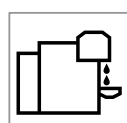
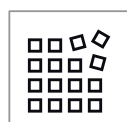
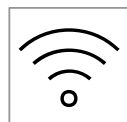

**ADVARSEL:** Vennligst les sikkerhetsinstruksjonen før du bruker din maskin for å unngå farlige situasjoner og mulig skade.

### AVFALLSHÅNDTERING OG MILJØHENSYN

Denne maskinen er i overensstemmelse med EU-direktivet 2012/19/EC. Pakningsmaterialer og maskinen inneholder verdifulle materialer som kan gjenvinnes eller resirkuleres. Maskinen inneholder flere ulike avfallsemner som skal sorteres og resirkuleres til verdifulle råmaterialer. Lever inn maskinen ved din miljøstasjon. Lokale myndigheter kan gi deg mer informasjon om avfallshåndtering.



## OVERSIKT

### MASKINOVERSIKT

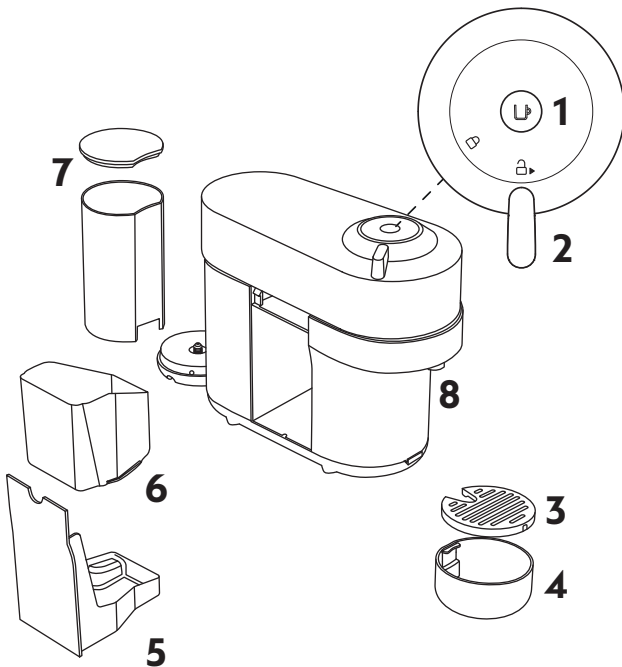

- 1 PÅ/AV og kaffeknapp
- 2 Låse/låse opp håndtak
- 3 Drypprist
- 4 Justerbar koppholder
- 5 Dryppskål
- 6 Kapselbeholder
- 7 Vanntank og lokk
- 8 Kaffeutløp

### PAKKENS INNHOLD



- 1 Kaffemaskin
- 2 Eske med et utvalg av **Nespresso**-kaffekapsler
- 3 **Nespresso** velkomstmateriale
- 4 Sikkerhetsinstruksjoner
- 5 Hurtigveiledning
- 6 Garanti

**i Utpakking:** Noe støv kan være tilstede på overflaten av maskinen på grunn av gjenvunnet materialer som brukes i emballasjen. Det er ikke farlig og du kan enkelt vaske det bort. Fjern plastfilmene når du pakker ut maskinen.

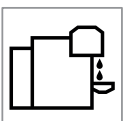



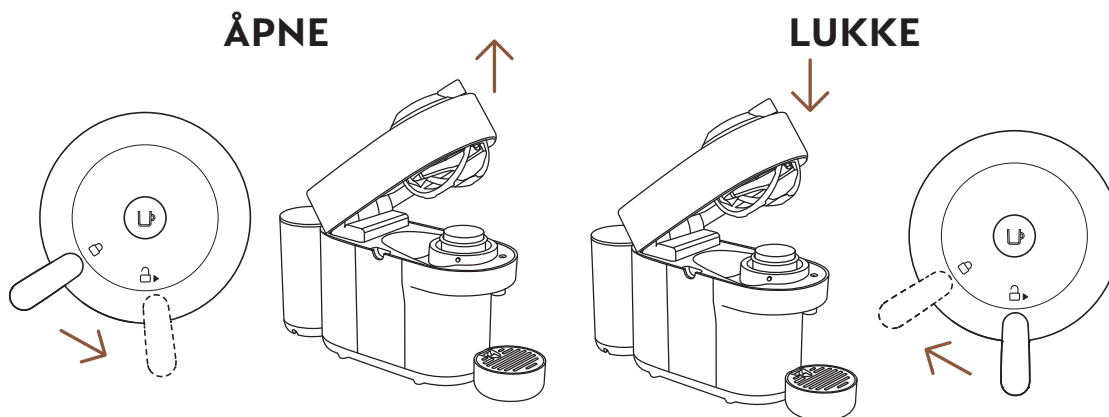

## ÅPNE/LUKKE



**FORSIKTIG:** For korrekt bruk av maskinen, vennligst ikke åpne maskinhodet mens kaffen brygger, vent til kaffeknappen lyser konstant hvitt. Hvis du ønsker å stoppe bryggingen tidligere, trykk én gang på kaffeknappen og vent til maskinen stopper før du åpner maskinhodet.

## VERTUO-SYSTEMET

### KAPSELKOMPATIBILITET

			
<b>S</b>	<b>M</b>	<b>L</b>	<b>XL</b>
<b>Ristretto</b> (25 ml)	<b>Double Espresso</b> (80 ml)	<b>Mug</b> (230 ml)	<b>Alto, Cold Brew Style</b> (355 ml)
<b>Espresso</b> (40 ml)	<b>Gran Lungo</b> (150 ml)		<b>Carafe</b> (535 ml)

### TILBEHØRSKOMPATIBILITET



Oppdag hele tilbehørskolleksjonen vår på [www.nespresso.com](http://www.nespresso.com)

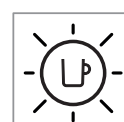
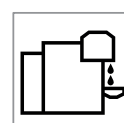
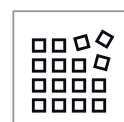
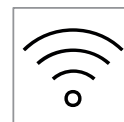

## PÅ/AV

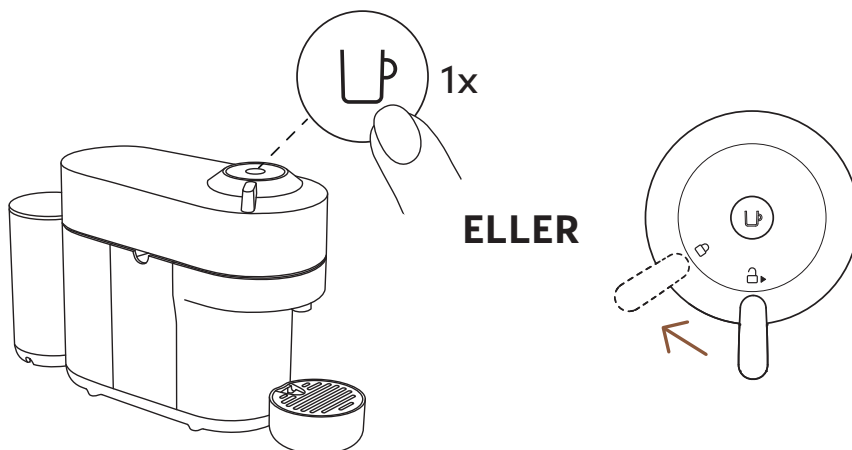
**PÅ**

Når maskinen er koblet til slås den på ved å trykke én gang på knappen eller ved å lukke spaken i låst stilling (med hodet lukket).

- i** Lampen vil blinke i omtrent 30 sekunder mens maskinen varmes opp. Når lyset er konstant, er maskinen klar til bruk.

**AV**

For å spare strøm vil maskinen slå seg av automatisk etter 2 minutter uten bruk.

- i** Maskinen kan slås "AV" manuelt når som helst (når den ikke er i bruk) ved å trykke og holde nede knappen i 3 sekunder.



## TILKOBLING

### HVORFOR SKAL DU PARKOBLE DIN VERTUO POP-KAFFEMASKIN

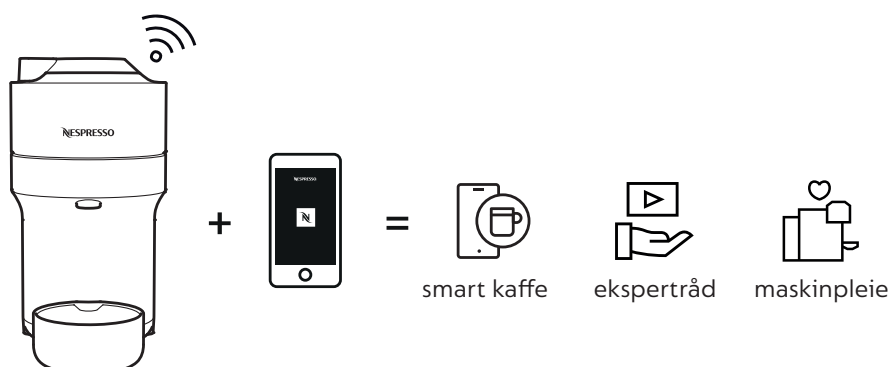

### FORDELER MED Å KOBLE TIL DIN VERTUO POP-KAFFEMASKIN

- **Smart kaffe:** Hold deg alltid et skritt foran for å få siste nytt om kaffeinnovasjonene fra **Nespresso** ved å hele tiden holde maskinen din oppdatert.
- **Eksperttråd:** Få support og enkle opplæringsvideoer for å følge kaffereisen din via smarttelefonen
- **Maskinpleie:** Motta umiddelbar varsling om hvordan og når du skal utføre service på maskinen din med en enkel trinnveiledning om avkalking, skylling, rengjøring osv.

### HVORDAN KOBLE TIL DIN VERTUO POP-KAFFEMASKIN?

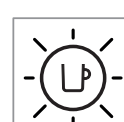
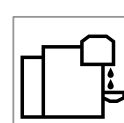
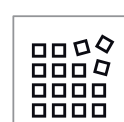



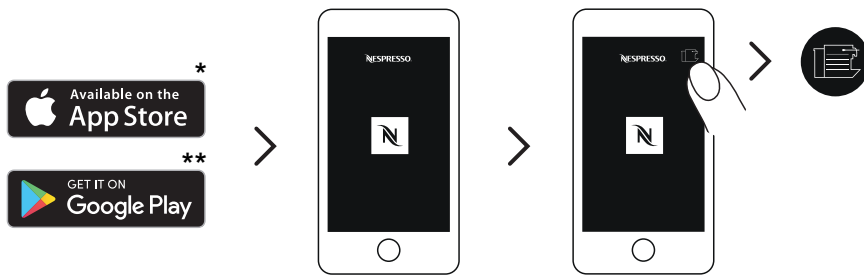

- 1** Last ned eller oppdater **Nespresso**-appen. Start **Nespresso**-appen på smarttelefonen eller nettbrettet. Trykk på maskinikonet øverst til høyre på skjermen.

**MERK:** For optimal ytelse og en sømløs opplevelse anbefaler vi å koble maskinen til en Wi-Fi-ruter i stedet for å bruke en smarttelefon-hotspot.

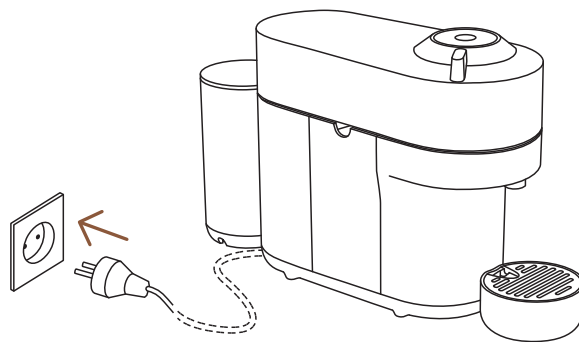

- 2** Koble til strømledningen.



- 3** Følg instruksjonene via **Nespresso**-appen.

**ADVARSEL:** Les først sikkerhetsreglene for å unngå fare for dødelig elektrisk støt og brann. Sørg for at stikkontakten er jordet når du kobler maskinen til strømuttaket.

- \* App Store® er et varemerke som tilhører Apple Inc., registrert i USA og andre land.  
 \*\* Google Play og Google Play-logo er varemerker som tilhører Google LLC.

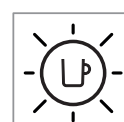
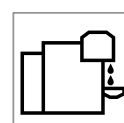
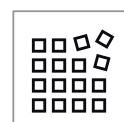

## DEAKTIVERING AV MASKINENS BLUETOOTH OG WI-FI

Maskinen leveres med en tilkoblingsmodul, aktivert som standard. Det gir tilgang til tilleggsfunksjoner som forbedrer kaffeopplevelsen din. Følg disse stegene for å deaktivere tilkoblingsmodulen:

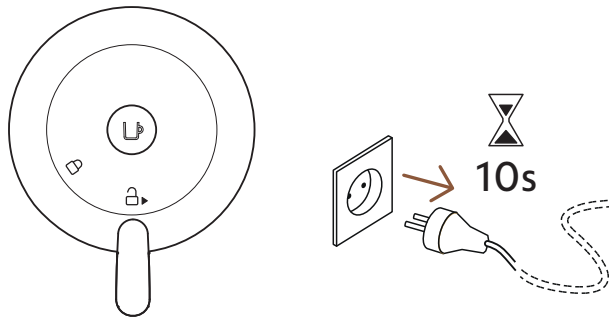

- 1 Med maskinen lukket og håndtaket i **låst** posisjon, koble fra maskinen i minst 10 sekunder.

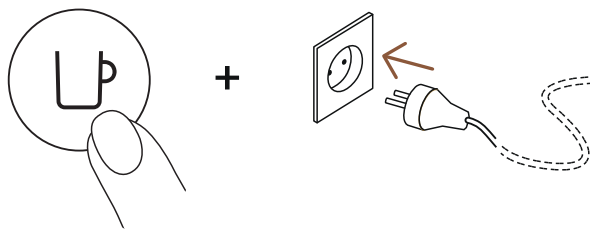

- 2 Press og hold knappen inne når du plugges i kontakten. Knappen vil blinke oransje for å bekrefte at tilkoblingsmodulen nå er deaktivert.
- i** Følg de samme trinnene for å sette tilkoblingsmodulen på igjen. Knappen blinker hvitt for å bekrefte at modulen er reaktivert.

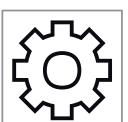
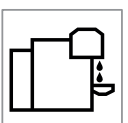

## FØRSTE STEG

## FØRSTE RENGJØRING

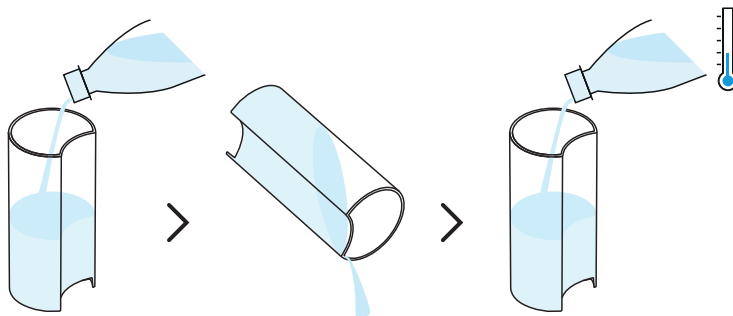

- 1** Skyll og rengjør vanntanken og lokket før den fylles med ferskt drikkevann.

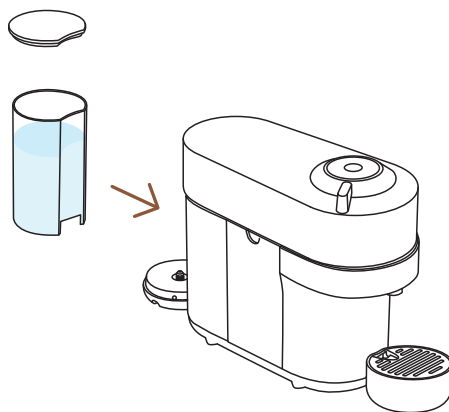

- 2** Lukk vanntanken med lokket og sett vanntanken på plass og sørg for at den er ordentlig på plass.



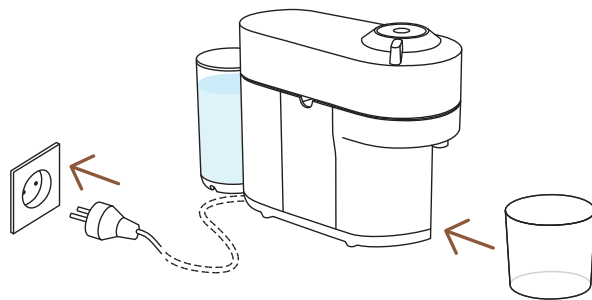

- 3** Med maskinen tilkoblet, fjern koppholderen og plasser en tom beholder (på minst 1 L ) under kaffeuttaket.

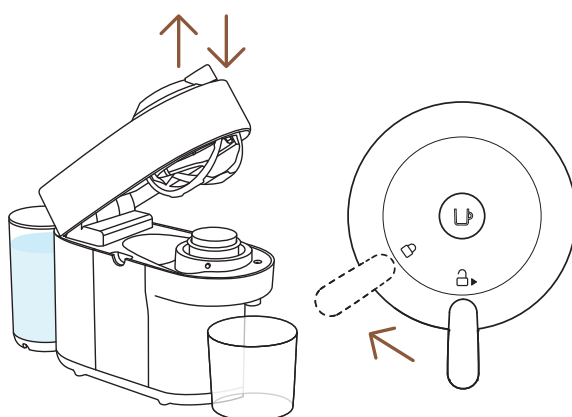

- 4** Åpne og lukke maskinen. Sørg for at spaken er i låst stilling.

- i** Lampen vil blinke mens maskinen varmes opp. Det vil ta omtrent 30 sekunder. Når lyset lyser konstant er maskinen klar. Pass på at ingen kapsel er satt inn.

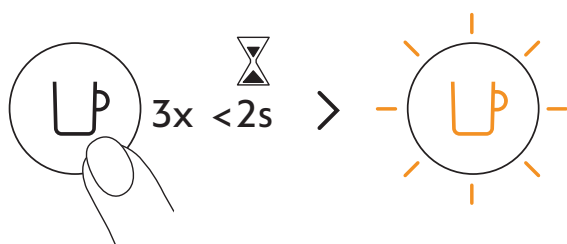

- 5** Trykk på knappen 3 ganger innen 2 sekunder for å starte skyllingen. La skyllingsprosedyren fullføres automatisk mens lyset blinker oransje. Når lyset blir konstant hvitt, er syklusen fullført.

- i** Det bør ta mindre enn 2 minutter før skylleprosessen starter og vann begynner å renne. Denne prosedyren kan ta opp til 7 minutter.

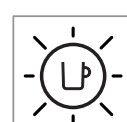
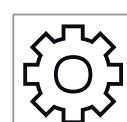
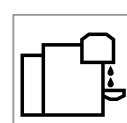
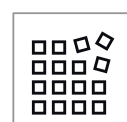
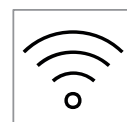

# KAFFETILBEREDNING

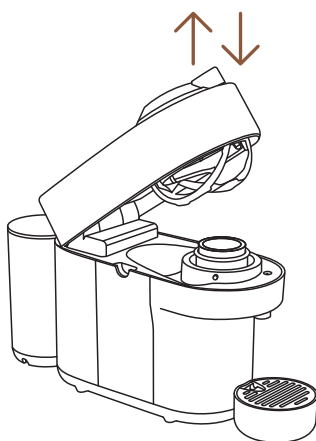

**1** Åpne og lukke maskinen.

**i** Lampen for kaffeknappen vil blinke mens maskinen varmes opp. Når lyset blir konstant er maskinen klar til bruk.

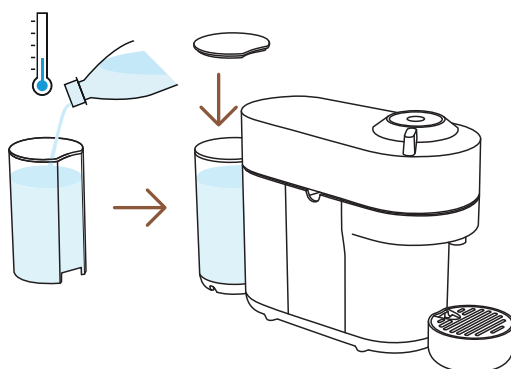

**2** Fyll vanntanken med ferskt drikkevann og sett den på plass igjen.

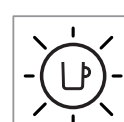
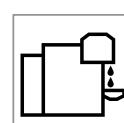
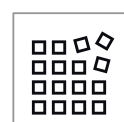
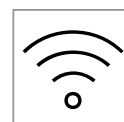

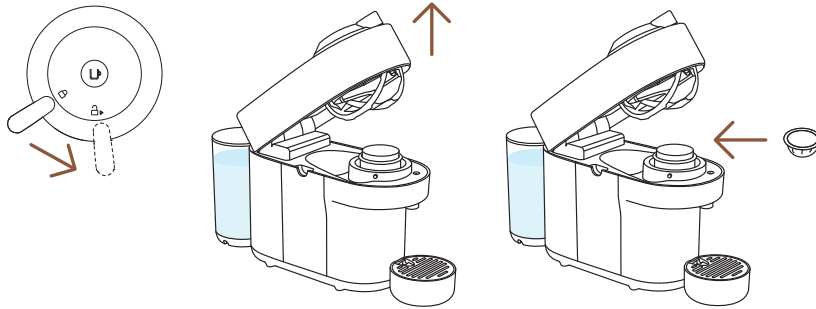

- 3** Lås opp og åpne maskinhodet helt, sett inn en **Vertuo**-kaffekapsel med kuppelformen vendt ned.

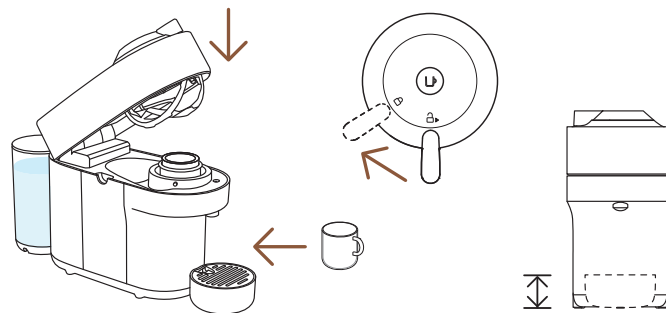

- 4** Lukk maskinhodet og lås ved å dreie spaken til venstre i låseposisjon og sett en kopp i koppholderen. Koppholderen kan justeres for å tilpasse din koppstørrelse.

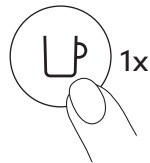

- 5** Start bryggingen ved å trykke én gang på knappen.

**FORSIKTIG:** For korrekt bruk av maskinen, vennligst ikke åpne maskinhodet mens kaffen brygger, vent til kaffeknappen blir konstant hvitt. Hvis du ønsker å stoppe bryggingen tidligere, trykk én gang på kaffeknappen og vent til maskinen stopper før du åpner maskinhodet.

- i** På grunn av kodeavlesning, forhåndsfukting av kaffe og infusjonstid vil det ta en liten stund før kaffen begynner å strømme. Maskinen vil automatisk gjenkjenne kapselen som er satt inn og velge kaffetilberedningsparametrene og koppstørrelsen definert av **Nespresso**-kaffeekspertene for å ekstrahere kaffeblendingene på sitt beste.

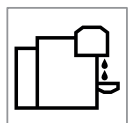

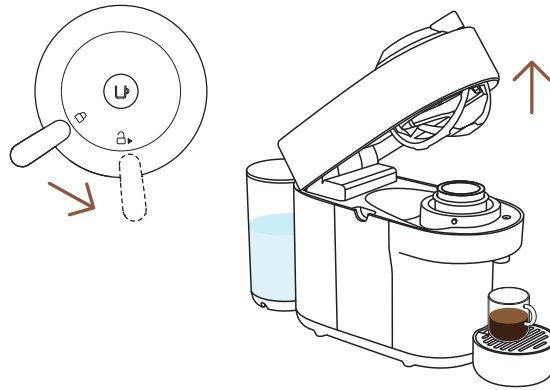

- 6** Når kaffen slutter å brygge, åpner du maskinhodet ved å vri håndtaket mot høyre til opplåst posisjon slik at kapselen automatisk løses ut.



- 7** Ikke glem å gjenvinne dine **Nespresso**-kaffekapsler.\*

\* DETTE ER **NESPRESSO**. PRODUKTET ER GJENVINNBAR. For mer informasjon om gjenvinning av dine **Nespresso**-kaffekapsler, besøk [www.nespresso.com](http://www.nespresso.com)

## OPPDAG VÅRE KAFFEOPPSKRIFT-FUNKSJONER



Med denne maskinen tilbyr **Nespresso** deg en spesifikk funksjon for kaffebryggingene dine og for å lage dine egne oppskrifter.

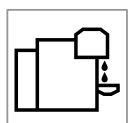

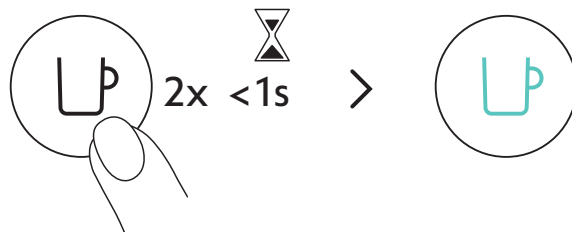

Med maskinen på, dobbeltklikk på kaffeknappen. Den vil blinke turkist og din kaffebrugging vil bli konsentrert, hvilket optimaliserer kaffesmaken i oppskrifter med tilsetninger (melk, fløtekrem, over is...). For uforglemmelige kaffeopplevelser.

40 ml	80 ml	150 ml	230 ml	355 ml	535 ml
✓	✓	✓	✓	✗	✗
25 ml	40 ml	40 ml	80 ml		

For å dra full nytte av fordelene anbefaler vi å brygge vår Coffee+-serie kun med de offisielle koppstørrelsene. For de beste resultatene i koppen, anbefaler vi ikke å brygge vår XL (Alto Ambrato, Alto Onice), Cold Brew Style og Carafe Pour Over Style med denne modusen.

**MERK:** En oppdatering av maskinen din via **Nespresso**-appen kan være nødvendig for å aktivere denne innstillingen

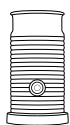

Oppdag hvordan du oppgraderer maskinen din med vårt Aeroccino-sortiment på [www.nespresso.com](http://www.nespresso.com)

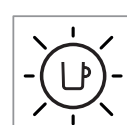
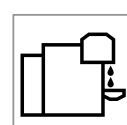
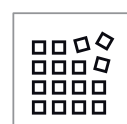
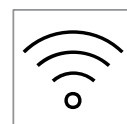



## TILPASS DINE KOPPSTØRRELSER

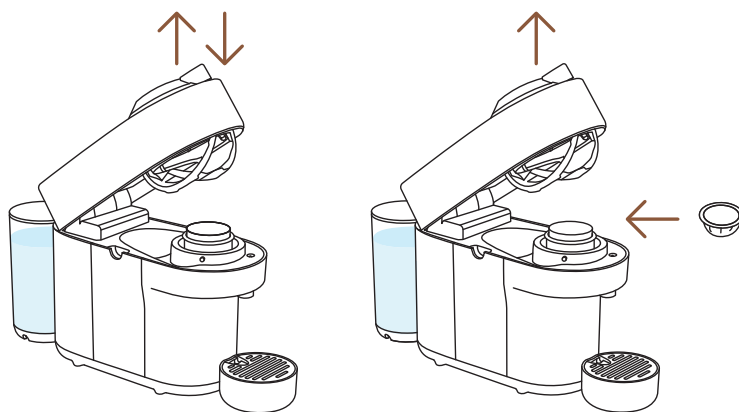

- 1** Åpne og lukke maskinen mens maskinen er på, åpne maskinenhodet og sett inn kapselen du vil programmere.

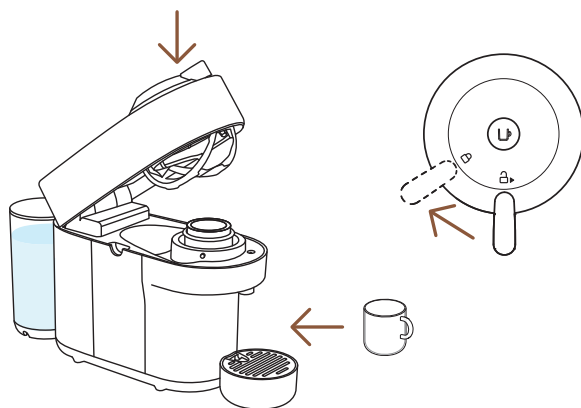

- 2** Lukk maskinhodet, vri håndtaket til venstre til låseposisjon og plasser en kopp i koppholderen.

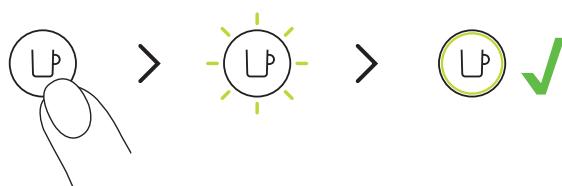

- 3** Trykk og hold inne knappen, slipp noen sekunder før ønsket mengde er nådd. Det nye vannvolumet er nå programmert for kapseltypen som ble brukt under innstillingen.

- i** Programmeringen er spesifikt tilegnet til hver kapseltype. Koppstørrelser kan programmeres fra 20 ml til 535 ml.

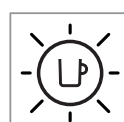
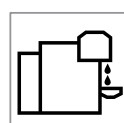
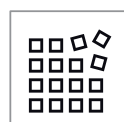
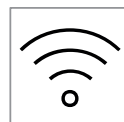

**FORSIKTIG:** For korrekt bruk av maskinen, vennligst ikke åpne maskinhodet mens kaffen brygger, vent til kaffeknappen blir konstant hvitt. Hvis du ønsker å stoppe bryggingen tidligere, trykk én gang på kaffeknappen og vent til maskinen stopper før du åpner maskinhodet.

**MERK:** Når et kundespesifikt volum er programmert av brukeren, vil den hver gang kapseltypen settes inn i maskinen stoppe tilberedningen ved den brukerprogrammerte koppstørrelsen. Hvis du ønsker å gå tilbake til standardinnstillingene, se avsnittet **“Tilbakestill til fabrikkinnstillinger”**.

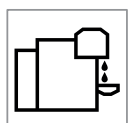

## RENGJØRING

Rengjør maskinen en gang i måned, når du begynner å ha kafferester inne i maskinhodet eller etter en lang periode uten bruk.

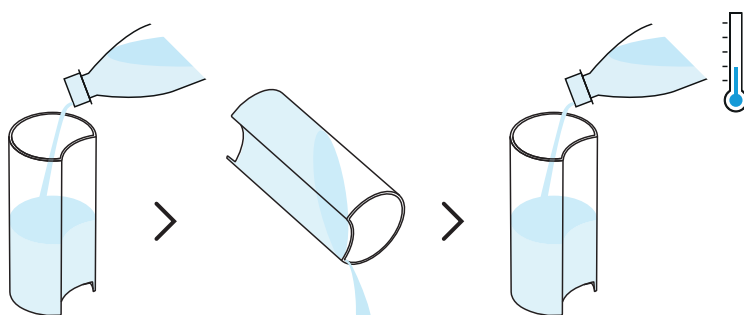

- 1** Skyll og rengjør vanntanken og lokket før du fyller den med ferskt drikkevann.

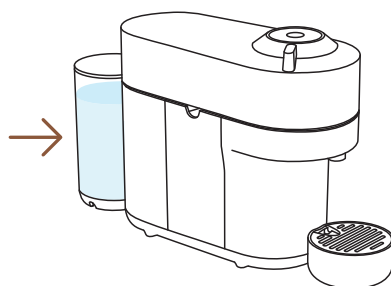

- 2** Sett vanntanken tilbake på plass på maskinen.

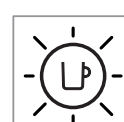
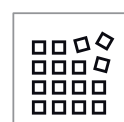
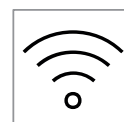

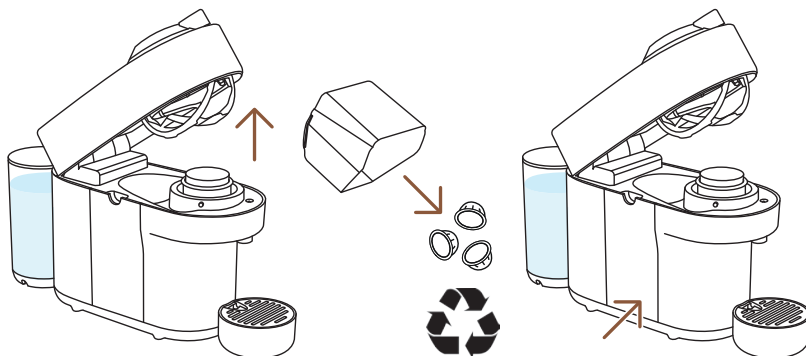

- 3** Med maskinen på, lås opp og åpne maskinen og la den brukte kapselen løses ut. Tøm og skyll kapselbeholderen og dryppbrettet, sett dem så tilbake på plass. Ikke glem å gjenvinne dine **Nespresso**-kaffekapsler.\*

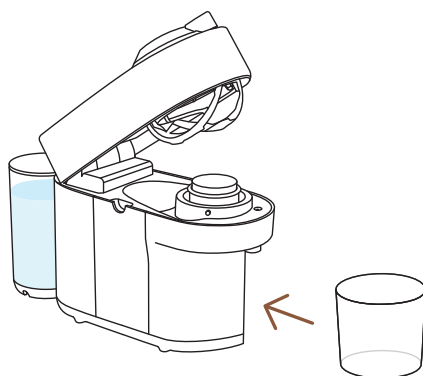

- 4** Fjern koppholderen og plasser en tom beholder (på minst 1 L) under kaffeutløpet.

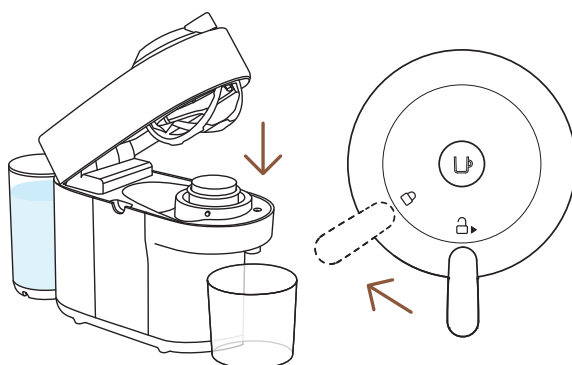

- 5** Lukk maskinhodet og vri håndtaket til venstre mot låseposisjon. Sørg for at det ikke er noen kapsler i maskinen før du starter skyllingsprosedyren.

\* DETTE ER **NESPRESSO**. PRODUKTET ER GJENVINNBART. For mer informasjon om gjenvinning av dine **Nespresso**-kaffekapsler, besøk [www.nespresso.com](http://www.nespresso.com)

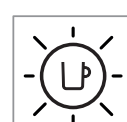
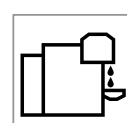
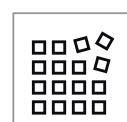
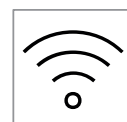

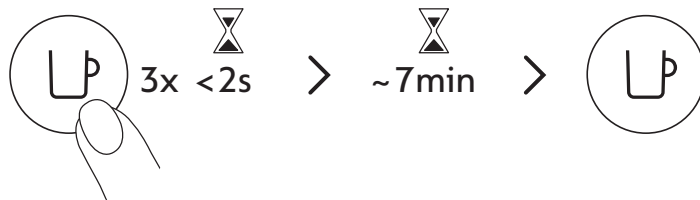

- 6** Trykk på knappen 3 ganger innen 2 sekunder for å starte skyllingen. Med lyset blinkende oransje, la skyllingsprosedyren fullføres automatisk.

- i** Det bør ta mindre enn 2 minutter før skylleprosessen starter og vannet begynner å strømme. Denne prosessen kan ta opptil 7 minutter og stopper automatisk når syklusen er fullført. Prosedyren kan stoppes når som helst ved å trykke på knappen.

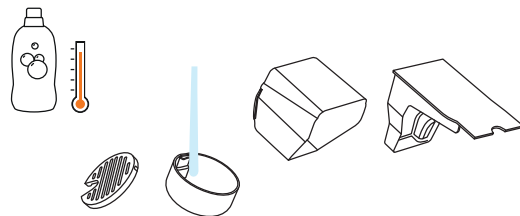

- 7** Vask kapselbeholderen, koppholderen og dryppbrettet med varmt vann og mildt luktfritt vaskemiddel.

**ADVARSEL:** Ikke bruk sterke eller slipende rengjøringsmidler eller løsemidler. Ikke legg maskinen i oppvaskmaskinen. Senk aldri apparatet eller deler av den i vann.

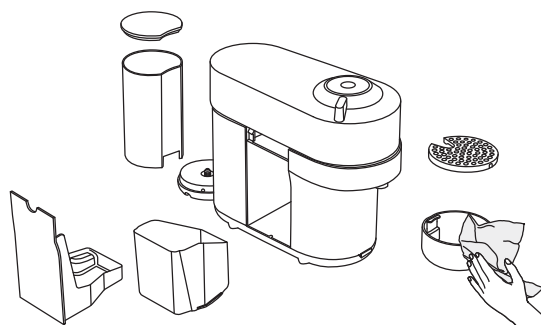

- 8** Tørk maskinen med et rent håndkle.

**ADVARSEL:** Rengjør kaffeuttaket regelmessig med en ren fuktig klut. Bruk alltid myke kluter for å rengjøre maskinen.

**MERK:** Vann kan samle seg i maskinens hode under rengjøring. Hvis dette skjer, tørk synlige deler med en ren og tørr klut.

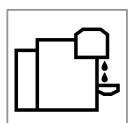

## AVKALKING

Avkalking av maskinen vil sikre at den fungerer som den skal gjennom hele levetiden og vil gjøre kaffeopplevelsen din like fantastisk som den var den første dagen. Maskinen din vil indikere når avkalking er nødvendig ved å blinke oransje 3 ganger før konstant hvitt lys.



**i** Avkalkingsprosedyren tar 20 minutter og **kan ikke avbrytes**.

**MERK:** Les nøye gjennom avkalkingsinstruksjonen før du starter.

### Du trenger:

- Ett avkalkingssett tilgjengelig på [www.nespresso.com](http://www.nespresso.com)
- En tom beholder (1 L)

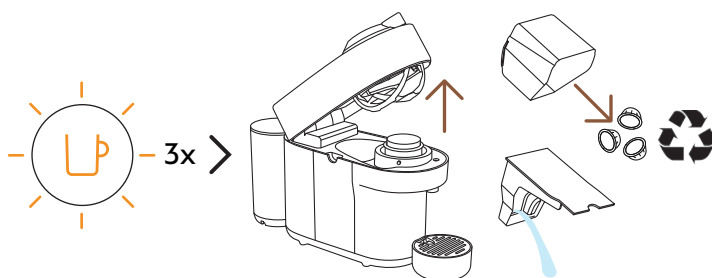

- 1** Med knappen blinkende oransje 3 ganger: Lås opp og åpne maskinhodet, la den brukte kapselen løses ut. Tøm kapselbeholderen og dryppbrettet, sett dem så tilbake på plass på maskinen. Ikke glem å gjenvinne dine **Nespresso**-kaffekapsler.\*

\* DETTE ER **NESPRESSO**. PRODUKTET ER GJENVINNBART. For mer informasjon om gjenvinning av dine **Nespresso**-kaffekapsler, besøk [www.nespresso.com](http://www.nespresso.com)

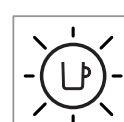
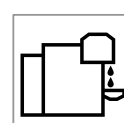
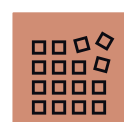
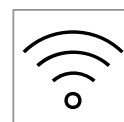

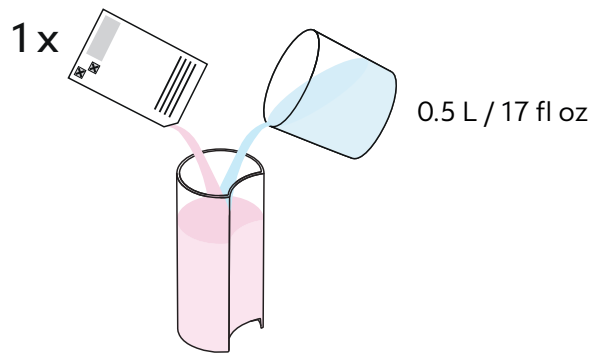

- 2** Fyll vanntanken med 0,5 L vann og tilsett 1 enhet **Nespresso**-avkalkingsvæske.

**ADVARSEL:** Vær oppmerksom på at avkalkingsløsningen kan være skadelig. Unngå kontakt med øyne, hud og overflater.

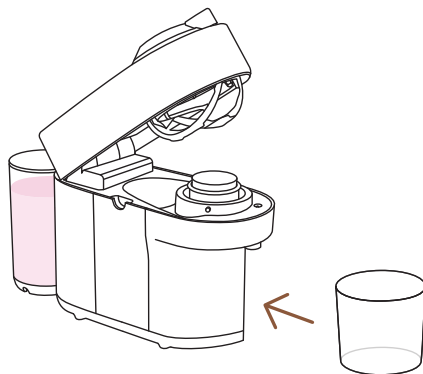

- 3** Fjern koppholderen og plasser en tom beholder (på minst 1 L) under kaffeutløpet.

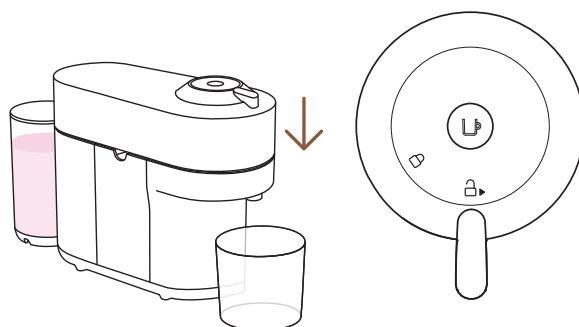

- 4** Med maskinen på, lukk maskinhodet å la håndtaket stå i ulåst posisjon.

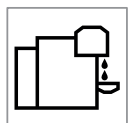
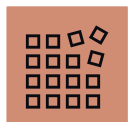

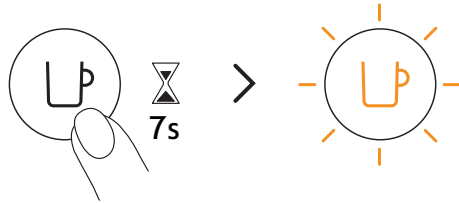

- 5** Hold knappen inne i minst 7 sekunder eller til du ser at lyset slås av. Knappen begynner å blinke oransje raskt.

**ADVARSEL:** Du har nå 45 sekunder på deg til å gå inn i avkalkingsmodus, ellers går maskinen tilbake til bryggemodus.

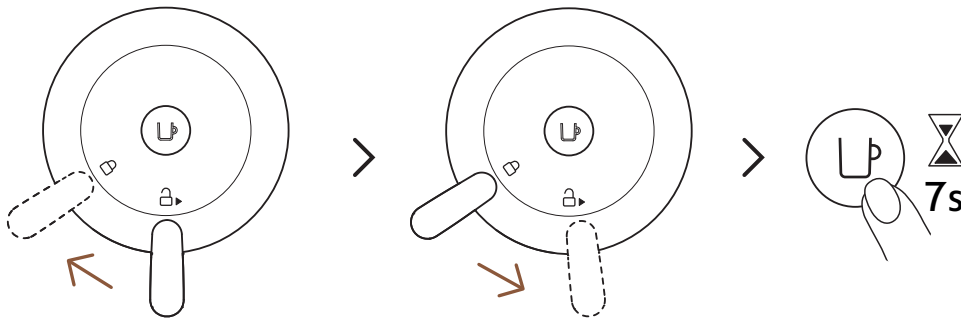

- 6** Lås maskinhodet ved å vri håndtaket mot venstre til låsesymbolet, og lås opp håndtaket ved å vri mot høyre til opplåst posisjon. Trykk og hold knappen inne i ca. 7 sekunder eller til lyset slås av. Knappen begynner å blinke oransje raskt.

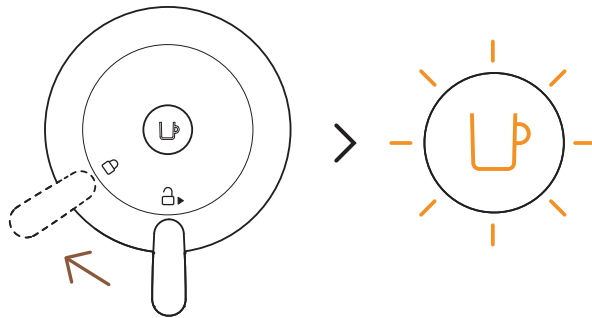

- 7** For å gå inn i avkalkingsmodus låser du maskinen ved å vri håndtaket mot venstre til låseposisjonen. Lyset skal fortsatt blinke oransje raskt. Dette er en indikasjon på at du har gått inn i avkalkingsmodus.

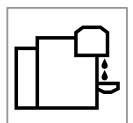
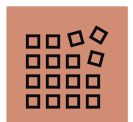



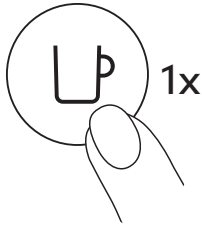

- 8** Trykk én gang på kaffeknappen for å starte avkalkingsprosessen. Lyset vil kontinuerlig blinke oransje gjennom hele prosessen.

- i** Maskinen stopper automatisk når den første fasen av avkalkingen er fullført.

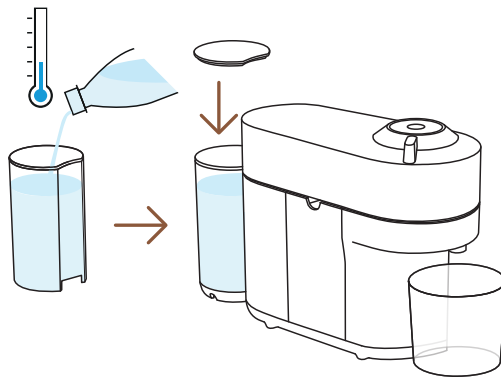

- 9** På slutten av avkalkingsprosessen er det på tide å skylle maskinen. Skyll vanntanken og dryppbrettet grundig. Fyll vanntanken med ferskt drikkevann og sett den på plass igjen. Tøm beholderen og sett den tilbake under kaffeuttaket.

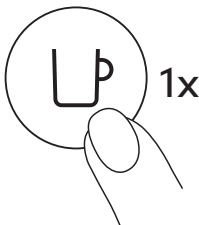

- 10** Trykk på knappen for å skylle maskinen. Når knappen slutter å blinke raskt og blir konstant, er avkalkingsprosedyren fullført.

- i** Maskinen stopper automatisk når prosedyren er fullført.



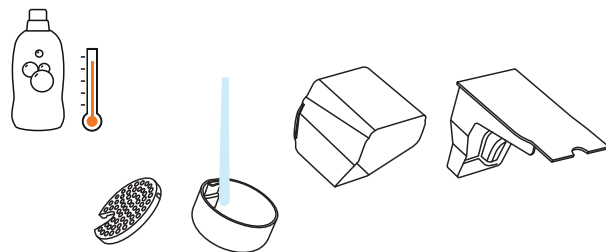

- 11** Vask kapselbeholderen, koppholderen og dryppbrettet med varmt vann og mildt luktfritt vaskemiddel.

**ADVARSEL:** Ikke bruk sterke eller slpende rengjøringsmidler eller løsemidler. Ikke legg maskinen i oppvaskmaskinen. Legg aldri apparatet eller deler av den i vann.

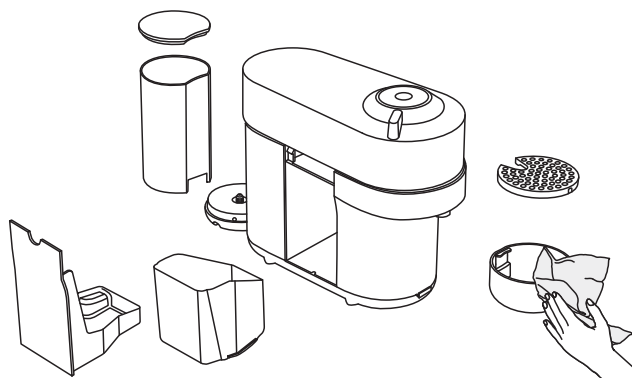

- 11** Tørk maskinen med en ren, tørr klut. La maskinen tørke i 10 minutter før du bruker den.

**MERK:** Vann kan samle seg inne i maskinhode under rengjøring. Hvis dette skjer, tørk synlige deler med en ren, tørr klut.

**MERK:** Maskinen kan bare gå inn i avkalkingsmodus etter å ha brygget 30 kaffekopper eller flere.

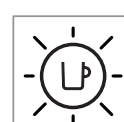
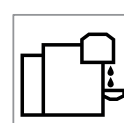
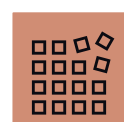
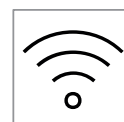

## TØM SYSTEMET

Tømming av systemet er en prosess som kan gjøres før en periode uten bruk, for frostbeskyttelse eller før du sender maskinen til reparasjon.

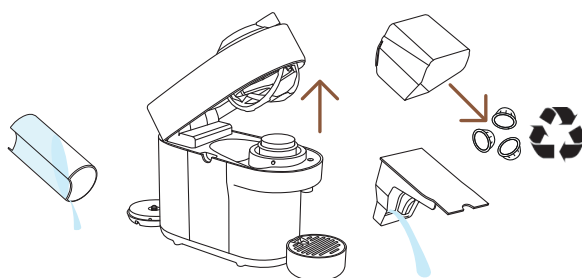

- 1** Tøm vanntanken, åpne maskinhodet å la den brukte kapselen løses ut. Tøm kapselbeholderen og dryppbrettet. Ikke glem å gjenvinne dine **Nespresso**-kaffekapsler.\*

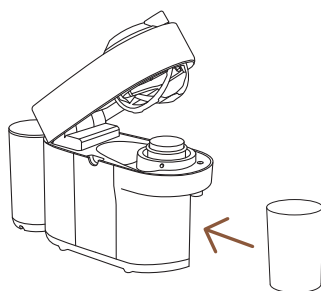

- 2** Sett dem tilbake på plass på maskinen, fjern koppholderen og plasser en tom beholder (0,5 L) under kaffeutløpet.

\* DETTE ER **NESPRESSO**. PRODUKTET ER GJENVINNBART. For mer informasjon om gjenvinning av dine **Nespresso**-kaffekapsler, besøk [www.nespresso.com](http://www.nespresso.com)

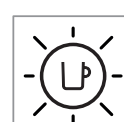
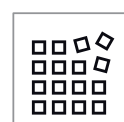
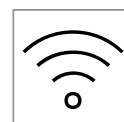

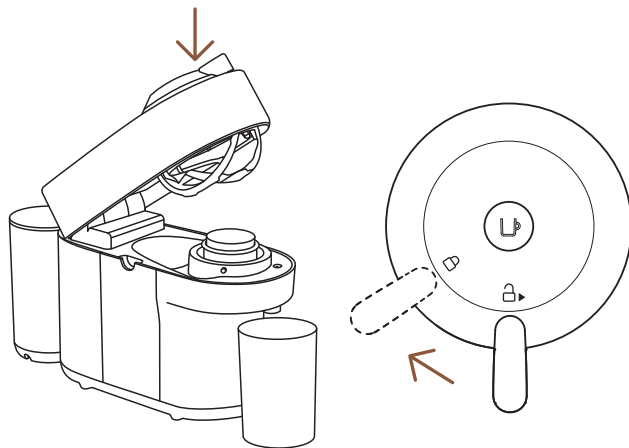

- 3** Med maskinen tilkoblet og på, dreii håndtaket til låseposisjonen.

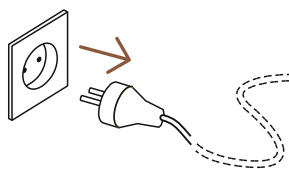

- 4** Koble fra maskinen.

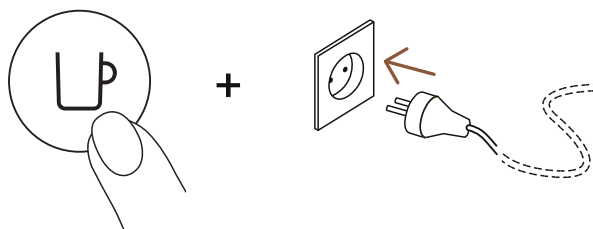

- 5** Trykk og hold inne knappen mens du kobler til maskinen.

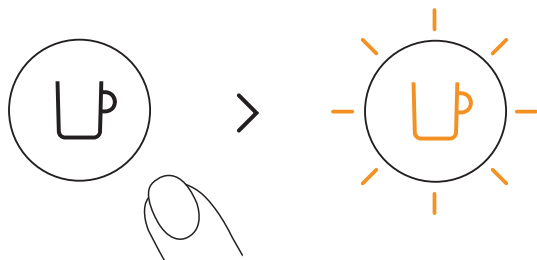

- 6** Slipp knappen. Den vil blinke oransje og tømmeprosessen starter.

- i** Det vil ta omtrent 30 sekunder før maskinen fullfører tømmeprosessen. Maskinen slår seg av automatisk når den er tom.

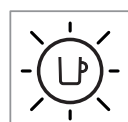
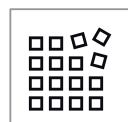
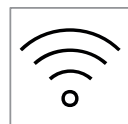

## TILBAKESTILL TIL FABRIKKINNSTILLINGER

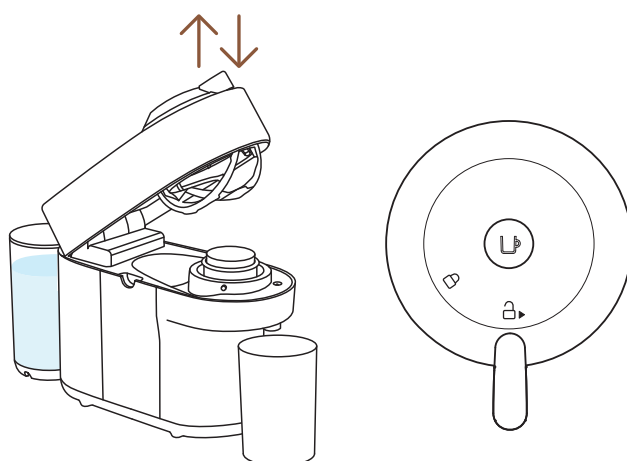

- 1 Med maskinen tilkoblet, åpne og lukke maskinhodet før du lar håndtaket stå i **ulåst** stilling.

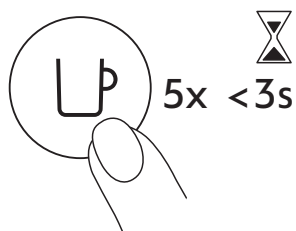

- 2 Trykk på knappen 5 ganger innen 3 sekunder. Maskinen er nå programmert med fabrikkinnstillingene.

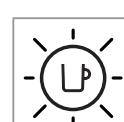
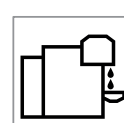
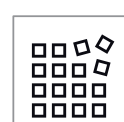
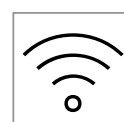

## BESKRIVELSE AV KNAPPENE

Vil du lære mer om knappeblinkene til **Vertuo Pop**?  
Vennligst se følgende video:

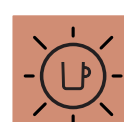
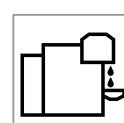
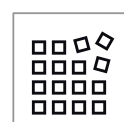
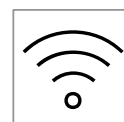

## FEILSØKING

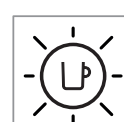
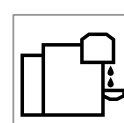
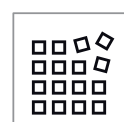
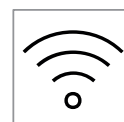

### Knappen lyser ikke.

- Maskinen har slått seg AV automatisk. Trykk på knappen eller "LÅS OPP" maskinen.
- Kontroller strømmettet, støpset, spenningen og sikringen.

### Ingen kaffe, ikke noe vann.

- Sjekk at vanntanken er fylt.
- Sjekk at en ny kapsel er satt inn i riktig posisjon, at håndtaket er ordentlig låst og trykk på knappen for å starte.
- Avkalk om nødvendig.
- Åpne maskinhodet å la kapselen løses ut. Utfør deretter en rengjøring i henhold til rengjøringsseksjonen.

### Kaffen er ikke varm nok.

- Forvarm koppen med varmt drikkevann fra springen.
- Avkalk om nødvendig.

### Lekkasje eller uvanlig kaffeestrøm.

- Sjekk at vanntanken er korrekt plassert.
- Avkalk om nødvendig.

### Maskinen går i "AV-modus".

- For å spare strøm vil maskinen slå seg av automatisk etter 2 minutter uten bruk.
- Maskinen kan slås "AV" manuelt når som helst (når den ikke er i bruk) ved å trykke og holde nede knappen i 3 sekunder.

### Kaffegrut i koppen.

- Utfør rengjøringsprosedyren to ganger.
- Se avsnittet om "Rengjøring".

### Maskinen starter ikke og lyser konstant. Hvis den blinker, se neste punkt.

- Kontroller at håndtaket er ordentlig låst.
- Hvis du ønsker å brygge en kaffe eller espresso, sjekk at en ny kapsel er satt inn i riktig posisjon, at håndtaket er ordentlig låst og trykk på knappen for å starte.
- Hvis du rengjør, avkalker eller tømmer systemet, kontroller at ingen kapsel er satt inn, lukk og lås maskinen, trykk deretter på knappen for å starte en av disse operasjonene.

### Maskinen starter ikke og lyset blinker vekselvis; ett blink og én pause.

- Fyll vanntanken og trykk på knappen for å starte.
- Kontroller at håndtaket er ordentlig låst.

## Lyset blinker mens maskinen er i gang.

- Hvis kaffen renner normalt, indikerer dette at maskinen fungerer som den skal.
- Hvis det bare renner vann, utfører maskinen en brukerforespørsel om enten rengjøring, avkalking eller tømning av systemet. Se det tilsvarende avsnittet i denne brukerhåndboken.
- Sett maskinen i "AV-modus" ved å trykke på knappen i 3 sekunder, og trykk deretter på den igjen for å slå maskinen PÅ. Vent nå i ca. 20 minutter for å la maskinen kjøle seg ned etter omfattende bruk.

## Lyset blinker og maskinen går ikke.

- Det vil ta litt tid før kaffestrømmen kommer ut (på grunn av kodelesing og forhåndsfukting av kaffen).
- Sjekk at det er satt inn en ny kapsel i riktig posisjon, at håndtaket er lukket og trykk på knappen for å starte.
- Fyll vanntanken og trykk på knappen for å starte.
- Sett maskinen i "AV-modus" ved å trykke på knappen og holde den nede i 3 sekunder, trykk deretter på den igjen for å slå maskinen PÅ. Vent nå i ca. 20 minutter for å la maskinen kjøle seg ned etter omfattende bruk.

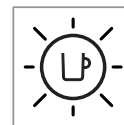
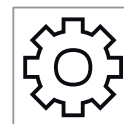
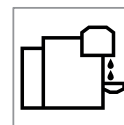
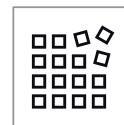
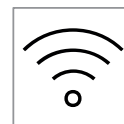



**Lyset blinker vekselvis to blink og én pause kontinuerlig. Maskinen brygger ikke.**

- Under vanlig tilberedning av kaffe/espresso:
  - 1) Lås opp håndtaket og åpne maskinhodet for å kontrollere at en ny uskadet kapsel er satt inn i riktig posisjon.
  - 2) Kontroller at håndtaket er i "LÅST"-posisjon.
  - 3) Sjekk at vanntanken er fylt.
- Under avkalking, tømning og rengjøring:
  - 1) Sjekk at kapselen løses ut.
  - 2) Kontroller at håndtaket er i "LÅST"-posisjon.
- Under programmeringsvolum:
  - 1) Kontroller at kapselen er satt inn korrekt.
  - 2) Vennligst se avsnitt "Tilpass kaffevolumet" i brukermanualen.
- Hvis problemet vedvarer:
  - 1) Lås opp håndtaket og åpne maskinhodet.
  - 2) Bytt ut kapselen (om nødvendig).
  - 3) Koble strømledningen fra stikkontakten og koble maskinen tilbake til stikkontakten etter 10 sekunder.
  - 4) Lukk maskinhodet og trykk på knappen for å slå PÅ maskinen, trykk igjen for å starte bryggingen.

Hvis problemet vedvarer, ring **Nespresso**.

**Lyset blinker vekselvis tre ganger og lyser deretter konstant.**

- Avkalking nødvendig: Maskinen kan bare brukes noen få ganger etter at avkalkingsvarselet vises før det blir nødvendig.

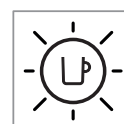
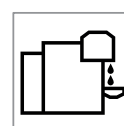
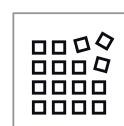
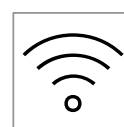

## SPESIFIKASJONER

<b>Strøm</b>	<b>~220–240 V, 50–60 Hz, 1300–1500 W</b> <b>US, CA:</b> 120 V, 60 Hz, 1500 W <b>MX:</b> 127 V~, 60 Hz, 1380 W
<b>Frekvens</b>	2.402–2.480 GHz
<b>RF utgangseffekt (EIRP)</b>	Bluetooth 4 dBm Maks. e.i.r.p. og Wi-Fi <20 dMm maks. e.i.r.p.
<b>Standby</b>	0.39 W/h
<b>Strømsparingsmodus</b>	Auto-off etter 2 min
<b>Oppvarmingstid</b>	30 sekunder (maskinhodet lukket og låst)
<b>Bevegelig koppholder for store oppskrifter</b>	Avtakbar enkeltstilling
<b>Kabellengde fra enhetsutsendelse</b>	75 cm / 30 in
<b>Dimensjoner (B x D x H)</b>	13.6 x 42.6 x 25 cm / 5.3 x 16.7 x 9.8 in
<b>Vekt</b>	3.5 kg / 7.72 lbs
<b>Vanntankkapasitet</b>	0.6 l / 20 fl oz
<b>Kapselbeholderkapasitet</b>	8 espresso eller 5 kopp-kapsler

## MASKINKODER

Nespresso	Breville	Delonghi
GCV2, GDV2	BNV120, BNV150	ENV90
Krups	Magimix	
XN9201, XN9204, XN9205, XN9211	M800	

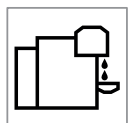

# PAINA VALITAKSESI KIELI

FI



**TURVALLISUUS**



**YLEISKATSAUS**



**YHDISTETTÄVYYS**



**ENSIMMÄINEN KÄYTTÖKERTA**



**KAHVIN VALMISTUS**



**SÄÄDÄ KAHVIN MÄÄRÄÄ**



**PUHDISTAMINEN**



**KALKINPOISTO**



**JÄRJESTELMÄN TYHJENTÄMINEN**



**PALAUTA TEHDASASETUKSET**



**MERKKIVALOJEN YHTEENVETO**



**VIANMÄÄRITYS**



**TEKNISET TIEDOT**

# TURVALLISUUS

**HUOM:** Lue turvallisuusohjeet ennen koneen käyttöä välttyäksesi mahdollisilta vahingoilta.

## HÄVITTÄMINEN JA YMPÄRISTÖNSUOJELU

Tämä laite noudattaa EU-direktiiviä 2012/19/EC.

Pakkausmateriaalit ja laite sisältävät kierrätettäviä materiaaleja.

Laitteesi sisältää arvokkaita materiaaleja, jotka voidaan ottaa talteen tai kierrättää. Jäljelle jääneiden jättemateriaalien lajittelu eri tyyppeihin auttaa arvokkaiden raaka-aineiden kierrätystä.

Vie laite keräyspisteeseen. Lisätietoa hävittämisestä saa paikallisviranomaisilta.

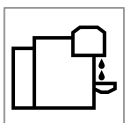
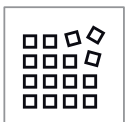

## YLEISKATSAUS

### KONE YLEISESTI

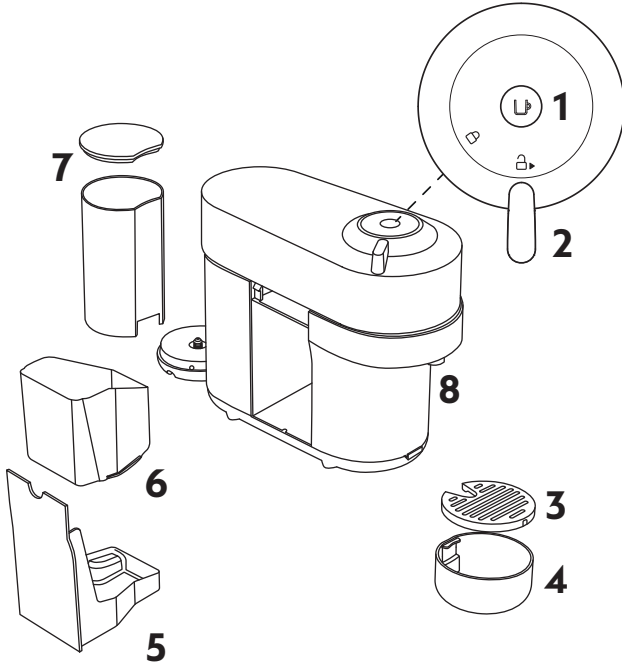

- 1 ON/OFF- ja kahvipainike
- 2 Lukitus- ja avausvipu
- 3 Tipparitilä
- 4 Säädetty kupin tuki
- 5 Tippa-astia
- 6 Käytettyjen kapselien säiliö
- 7 Vesisäiliö ja kansi
- 8 Kahvisuutin

### PAKKAUKSEN SISÄLTÖ



- 1 Kahvikone
- 2 **Nespresso-** kahvikapselivalikoima
- 3 **Nespresson** tervetuliaismateriaali
- 4 Turvallisuusohjeet
- 5 Pikaopas
- 6 Takuu

4 + 5 + 6

**i Pakkauksen avaaminen:** laitteen päällä saattaa olla pakkausmateriaalista irronnutta pölyä, johtuen pakkauksessa käytetystä kierrätysmateriaalista. Tämä ei ole haitallista ja voidaan pyyhkiä pois liinalla ennen käyttöä. Poista koneesta löytyvät suojamuovit.

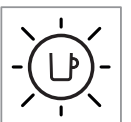
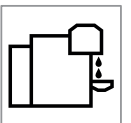
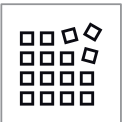



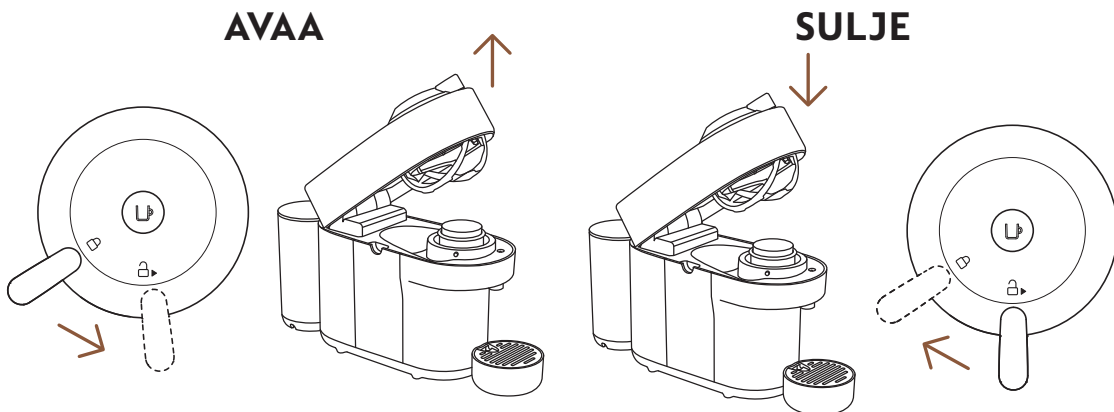

## AVAA/SULJE



**VAROITUS:** koneen oikean käytön varmistamiseksi älä avaa konetta kahvin valmistuksen aikana, vaan odota, kunnes kone on pysähtynyt ja kahvipainike palaa tasaisen valkoisena. Mikäli haluat lopettaa valmistuksen aikaisemmin, paina kahvipainiketta kerran ja odota, kunnes kahvipainike palaa tasaisen valkoisena.

## VERTUO-JÄRJESTELMÄ

### KAPSELEIDEN YHTEENSOPIVUUS

			
<b>S</b>	<b>M</b>	<b>L</b>	<b>XL</b>
<b>Ristretto</b> (25 ml)	<b>Tuplaespresso</b> (80 ml)	<b>Muki</b> (230 ml)	<b>Alto, Cold Brew</b> (355 ml)
<b>Espresso</b> (40 ml)	<b>Gran Lungo</b> (150 ml)		<b>Carafe</b> (535 ml)

### OHEISTUOTTEIDEN YHTEENSOPIVUUS



Tutustu täyteen oheistuotevalikoimaamme osoitteessa [www.nespresso.fi](http://www.nespresso.fi)

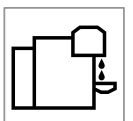
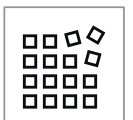
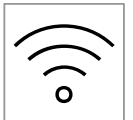

## ON/OFF

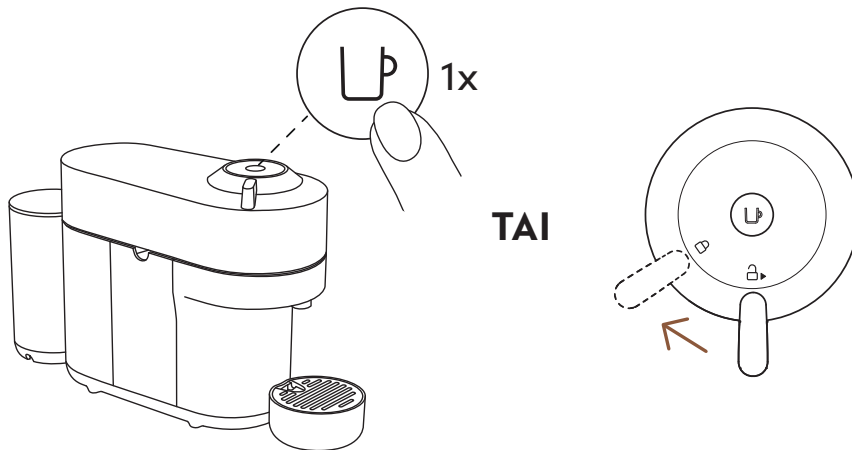
**ON**

Kun kone on kytketty, käynnistä se painamalla painiketta kerran tai sulkemalla vipu lukitsemisasentoon (koneen kansi suljettuna).

- i** Valo vilkkuu noin 30 sekunnin ajan kun kone lämpenee. Kun valo palaa tasaisesti, kone on valmis käytettäväksi.

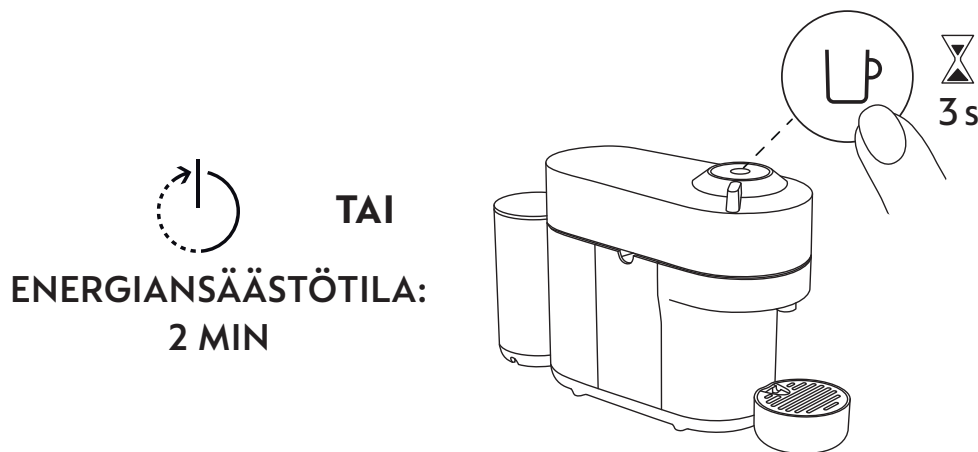
**OFF**

Kahvikoneessa on automaattinen virrankatkaisu kahden minuutin kuluttua edellisen käytön jälkeen.

- i** Kone voidaan kytkeä manuaalisesti pois päältä milloin tahansa (kun ei käytössä) painamalla painiketta yhtäjaksoisesti kolmen sekunnin ajan.

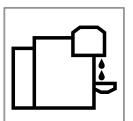
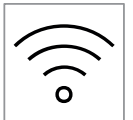

## YHDISTETTÄVYYS

### MIKSI SINUN KANNATTAA YHDISTÄÄ VERTUO POP -KONEESI LAITEPARIKSI\*



\*Saatavuus vaihtelee maittain

### VERTUO POPIN YHDISTÄMISEN EDUT

- **älykäs kahvi:** Pysy aina ajan tasalla ja saat tietoosi viimeisimmät **Nespresso** kahvi-innovaatiot, pitämällä koneesi hyvässä kunnossa ja päivitetynä
- **Asiantuntijan neuvo:** Saat tukea ja helppoja opetusvideoita kahvimatkaasi varten, älypuhelimesi välityksellä
- **koneen hoito:** Saat välittömiä ilmoituksia ja helppoja ohjeita kahvikoneesi huoltoon, kalkinpoistoon, huuhteluun ja puhdistamiseen liittyen

### KUINKA YHDISTÄN VERTUO POP -KAHVIKONEENI?

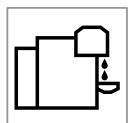



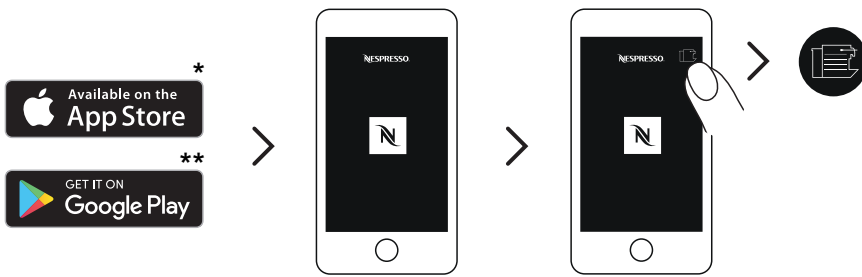

- 1** Lataa tai päivitä **Nespresso**-sovellus. Käynnistä sovellus mobiililaitteellasi. Valitse kahvikoneen kuva näytön oikeasta ylänurkasta.

**HUOMAUTUS:** optimaalisen suorituskyvyn ja saumattoman käyttökokemuksen saavuttamiseksi suosittelemme, että yhdistät laitteesi Wi-Fi-reitittimeen älypuhelimien hotspotin käyttämisen sijaan.

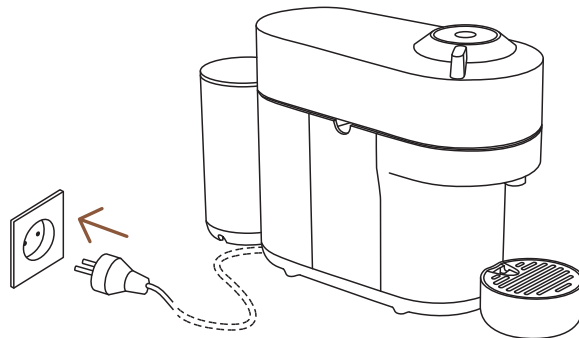

- 2** Kytke virtajohto.



- 3** Seuraa **Nespresso**-sovelluksen ohjeita.

**HUOM:** Lue ensin turvallisuusvarotoimet, välttyäksesi kohtalokkaan sähköiskun tai tulipalon vaaralta. Varmista maadoitus kytkettäessä konetta virtalähteeseen.

- \* App Store® on Apple Inc:n tavaramerkki, joka on rekisteröity Yhdysvalloissa ja muissa maissa.  
 \*\* Google Play ja Google Play -logo ovat Google LLC:n tavaramerkkejä.

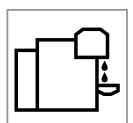
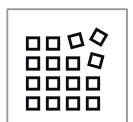

## KONEEN BLUETOOTHIN JA WI-FI:N POISTAMINEN KÄYTÖSTÄ

Koneessa on yhdistettävyystoiminto, joka on oletuksena käytössä. Se antaa pääsyn lisäominaisuuksiin, jotka parantavat kahvielämystäsi. Poistaaksesi yhdistettävyystoiminnon, seuraa näitä ohjeita:

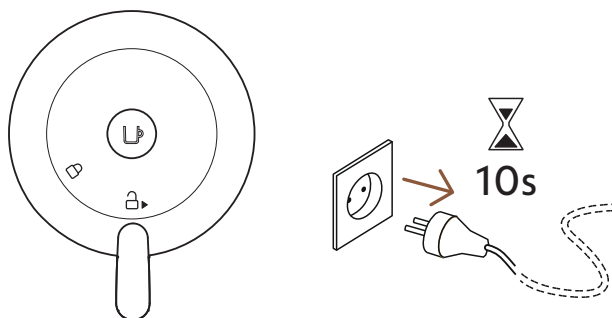

- 1** Kun kone on suljettu ja vipu **auki-asennossa**, irrota kone pistorasiasta vähintään 10 sekunniksi.

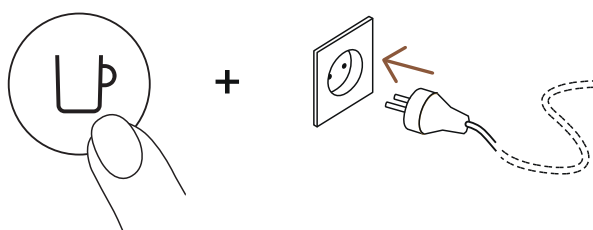

- 2** Paina painiketta pohjaan laittaessasi virtajohdon pistokkeeseen. Painike vilkuu oranssina vahvistaakseen että yhdistettävyystoiminto on kytketty pois päältä.

- i** Seuraa samoja ohjeita kytkeäksesi yhdistettävyystoiminnon takaisin päälle. Painike vilkuu valkoisena vahvistaakseen että toiminto on kytketty uudelleen päälle.

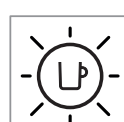
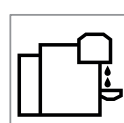
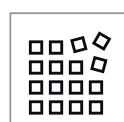

# ENSIMMÄINEN KÄYTTÖKERTA

## ENSIMMÄINEN HUUHTELU

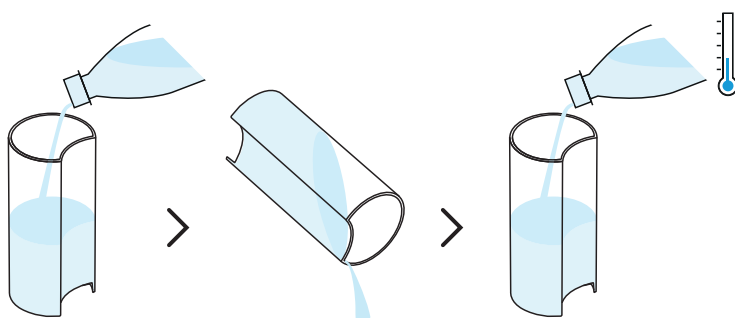
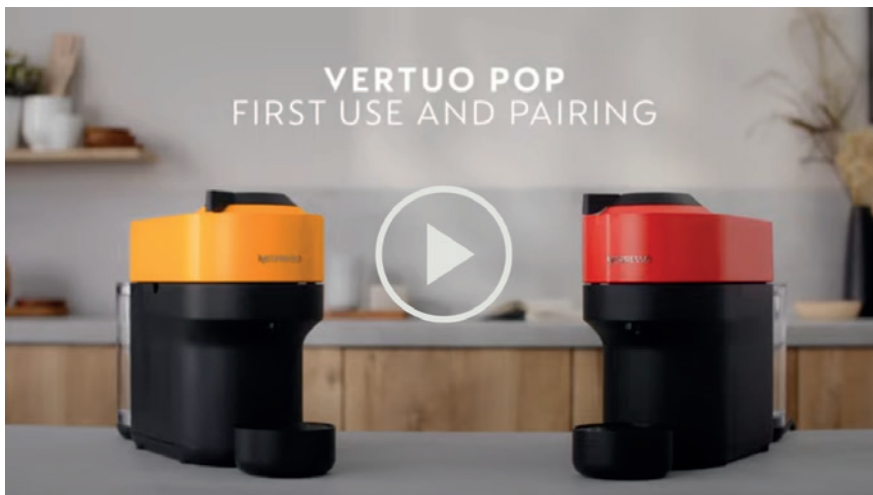

- 1** Huuhtele ja puhdista vesisäiliö ja kansi ennen kuin täytät säiliön puhtaalla juomavedellä.

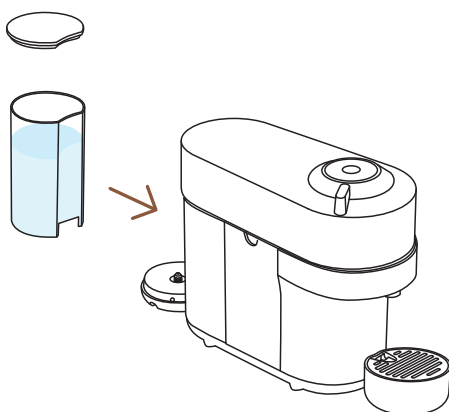

- 2** Sulje vesisäiliö kannella ja aseta säiliö paikalleen ja pidä huolta että se on asetettu oikein.

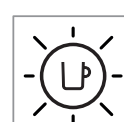
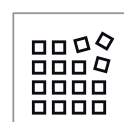
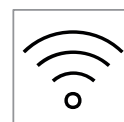

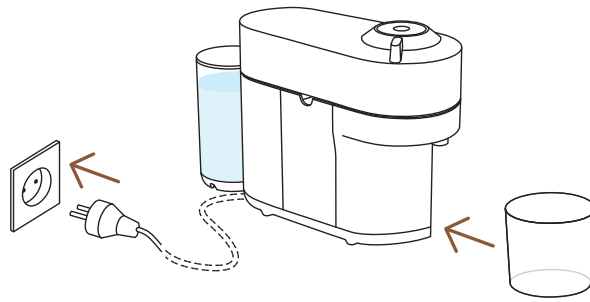

- 3** Kytke virtajohto, irrota kupin tuki ja aseta tyhjä astia (vähintään 1 litran vetoinen) kahvisuuttimen alle.

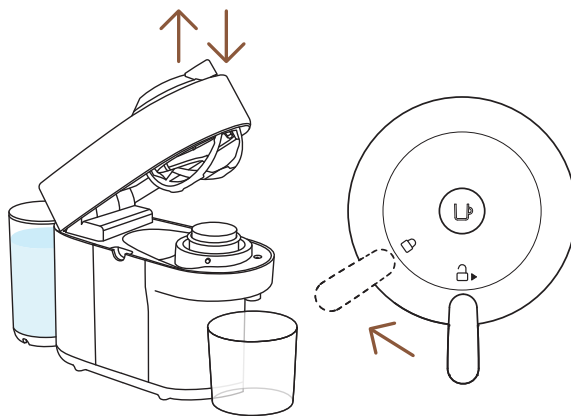

- 4** Avaa ja sulje kone. Pidä huolta että kahva on lukittu.

- i** Valo vilkkuu kun kone lämpenee. Tämä vie noin 30 sekuntia. Kun valo palaa tasaisesti, kone on valmis. Varmista että koneen sisällä ei ole kahvikapselia.

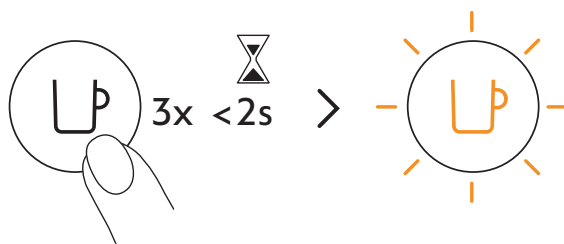

- 5** Paina painiketta kolme kertaa kahden sekunnin sisään aloittaaksesi huuhtelun. Aloita huuhtelu painamalla painiketta 3 kertaa 2 sekunnin sisällä. Anna huuhtelun päättyä automaattisesti.

- i** Vie alle kaksi minuuttia, kunnes huuhtelutoiminto alkaa ja vesi alkaa virrata. Tämä vaihe voi kestää 7 minuuttia.



## KAHVIN VALMISTUS

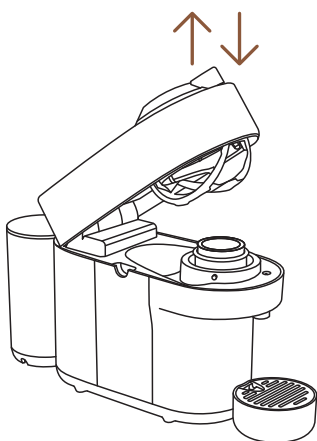

**1** Avaa ja sulje kone.

**i** Kahvipainikevalo vilkkuu kun kone lämpenee. Kun valo palaa tasaisesti, kone on valmis käytettäväksi.

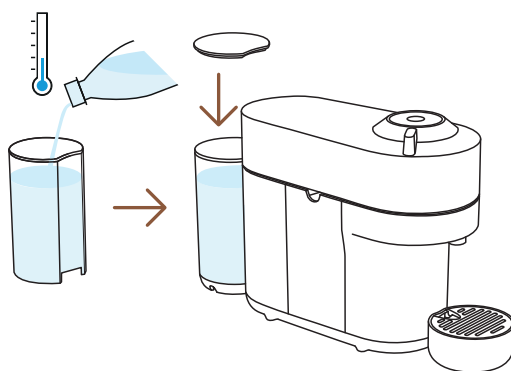

**2** Täytä vesisäiliö raikkaalla juomavedellä ja aseta se paikalleen.

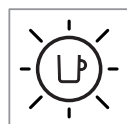
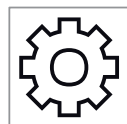
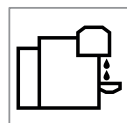
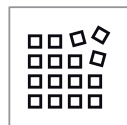
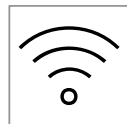

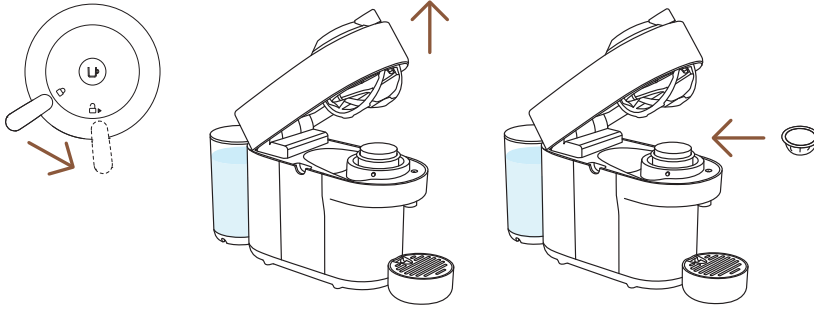

- 3** Avaa koneen kansi kokonaan ja aseta sisään Vertuo-kahvikapseli, pyöreä puoli alaspäin.

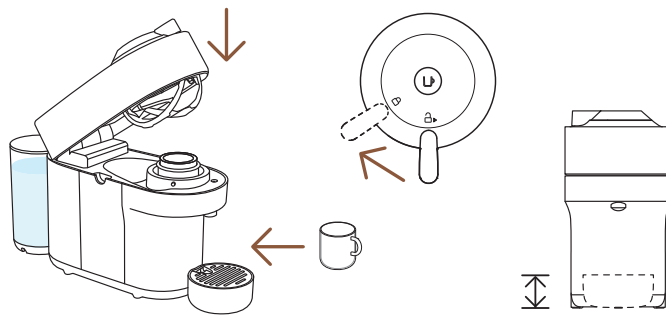

- 4** Sulje koneen kansi ja lukitse kääntämällä vipua vasemmalle lukitusasentoon ja aseta kuppi paikalleen. Kupintuki voidaan säätää kupin koon mukaan.

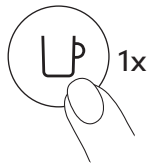

- 5** Aloita valmistus painamalla painiketta kerran.

**VAROITUS:** koneen oikean käytön varmistamiseksi älä avaa koneen kantta kahvin valmistamisen aikana, vaan odota, kunnes kone on pysähtynyt ja kahvipainike palaa tasaisesti valkoisena. Mikäli haluat lopettaa haudutuksen aikaisemmin, paina kahvipainiketta kerran ja odota, kunnes kahvipainike palaa tasaisen valkoiseksi.

- i** Viivakoodin lukemisen, kahvin esikostutuksen ja infuusioajan vuoksi kestää hetken ennen kuin kahvi alkaa virrata. Kone tunnistaa automaattisesti asetetun kapselin ja valitsee **Nespresso** kahviasiantuntijoiden määrittämät valmistusparametrit sekä kahvin määrän, valmistaakseen optimaalisen kupillisen.

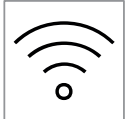

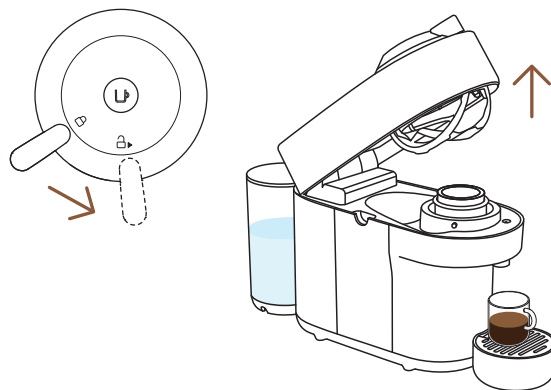

- 6** Kun kahvin tulo loppuu, avaa koneen kahva kääntämällä vipua oikealle avausasentoon, poistaaksesi kapselin ja nauttiaksesi kahvistasi.



- 7** Kiitos kun kierrätät **Nespresso**-kahvikapselisi.\*

\* TÄMÄ ON **NESPRESSO**. TÄMÄ ON KIERRÄTETTÄVÄÄ. Lue lisätietoa **Nespresso**-kahvikapseleiden kierrätyksestä osoitteessa [www.nespresso.fi](http://www.nespresso.fi)

## TUTUSTU COFFEE CREATIONS -TILAAN



Tällä kahvikoneella **Nespresso** tarjoaa erityisen toiminnon keskittyäksesi kahvinvalmistukseen ja luodaksesi omia reseptejasi.

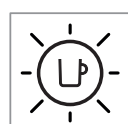
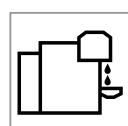
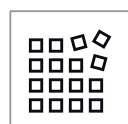
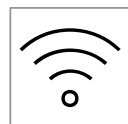

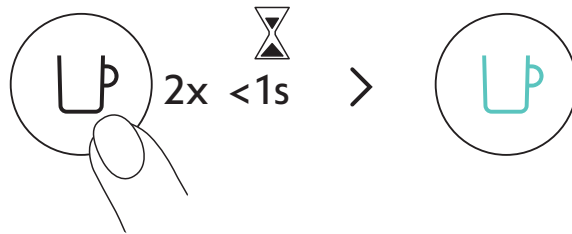

Kun kone on päällä, tuplaklikkaa kahvipainiketta. Valo palaa turkoosina ja kahvinvalmistuksesi keskitetään, mikä optimoi kahvin maun resepteissä, joissa on lisäaineita (maito, kerma, jäitä...). Vertaamattomia kahvielämyksiä varten.

40 ml	80 ml	150 ml	230 ml	355 ml	535 ml
✓	✓	✓	✓	✗	✗
25 ml	40 ml	40 ml	80 ml		

Jotta voit nauttia kaikista eduista, suosittelemme Coffee+ -valikoimamme valmistamista käyttämällä vain virallisia kahvikuppikokoja. Parhaan kupillisen lopputuloksen saavuttamiseksi emme suosittele XL (Alto Ambrato, Alto Onice) Cold Brew Style & Carafe Pour Over Style -kahvien valmistamista tässä tilassa.

**HUOMAUTUS:** Koneesi päivitys **Nespresso**-sovelluksen kautta saattaa olla tarpeen tämän tilan käyttöön ottamiseksi.



Lue kuinka voit parantaa kahvielämystäsi Aeroccino-mallistollamme [www.nespresso.fi](http://www.nespresso.fi)

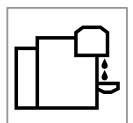



# SÄÄDÄ KAHVISI MÄÄRÄÄ

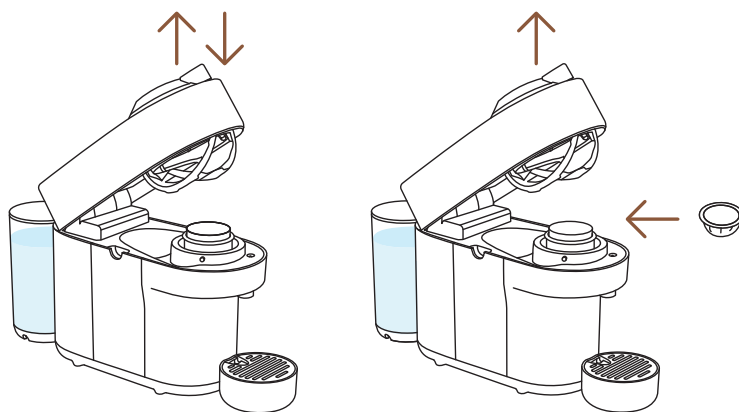

- 1** Avaa kahvikone ja aseta kahvikapseli jonka asetuksia haluat muuttaa.

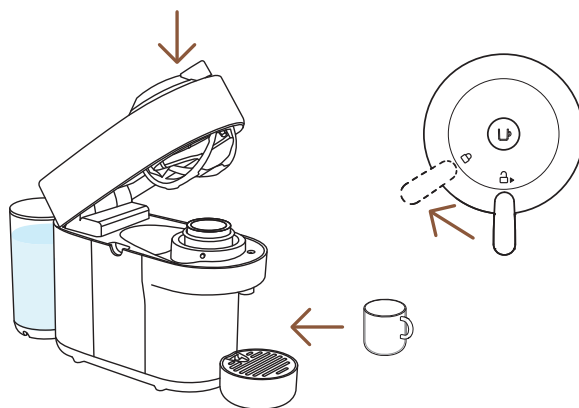

- 2** Sulje koneen kansi, käännä vipua vasemmalle lukitusasentoon ja aseta kuppi.

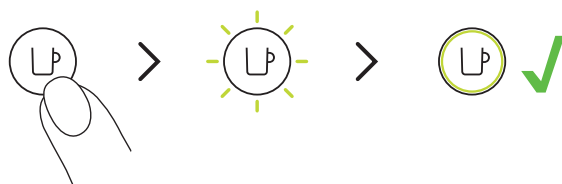

- 3** Pidä painiketta painettuna, päästää irti muutama sekunti ennen, kunnes haluttu kahvin määrä on saavutettu. Nyt veden määrä on asetettu valitsemalessi kapselille.

- i** Laitteen ohjelmointi on kapselikohtainen. Kahvien koot voi ohjelmoida välille 20 ml – 535 ml.

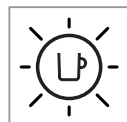
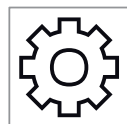
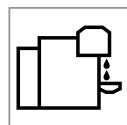
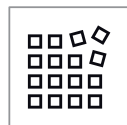
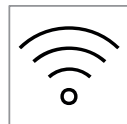

**VAROITUS:** koneen oikean käytön varmistamiseksi älä avaa koneen kantta kahvin valmistamisen aikana, vaan odota, kunnes kone on pysähtynyt ja kahvipainike palaa tasaisen valkoisena. Mikäli haluat lopettaa valmistuksen aikaisemmin, paina kahvipainiketta kerran ja odota, kunnes kahvipainike palaa tasaisen valkoiseksi.

**HUOMAUTUS:** Kun kapselikohtainen määrä on ohjelmoitu käyttäjän toimesta, kyseinen kapseli valmistuu aina uudelleen käyttäjän valitsemalle määrälle. Mikäli haluat palauttaa oletusparametreihin, katso kohta “Palauta tehdasasetukset”.

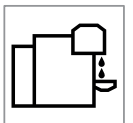
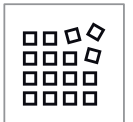

## PUHDISTAMINEN

Puhdista koneesi kuukausittain, kun alat saamaan kahvin ylijäämää koneen sisälle tai pitkän käyttämättäjäättämisen jälkeen.

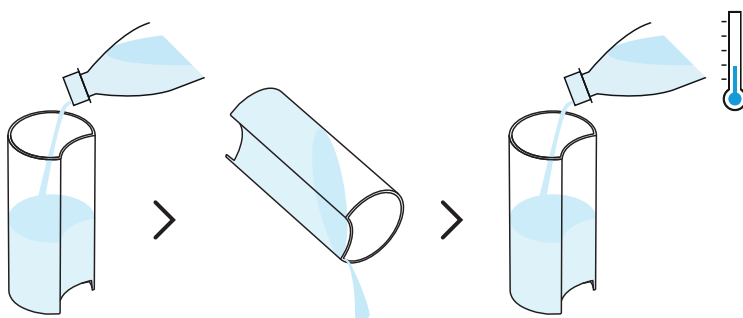

- 1** Huuhtele ja puhdista vesisäiliö ja kansi ennen kuin täytät säiliön raikkaalla juomavedellä.

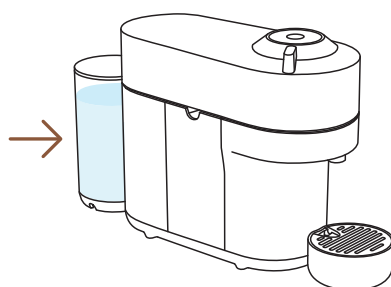

- 2** Aseta vesisäiliö takaisin paikalleen koneeseen.

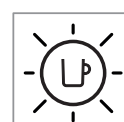
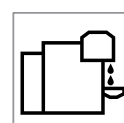
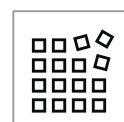
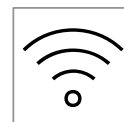

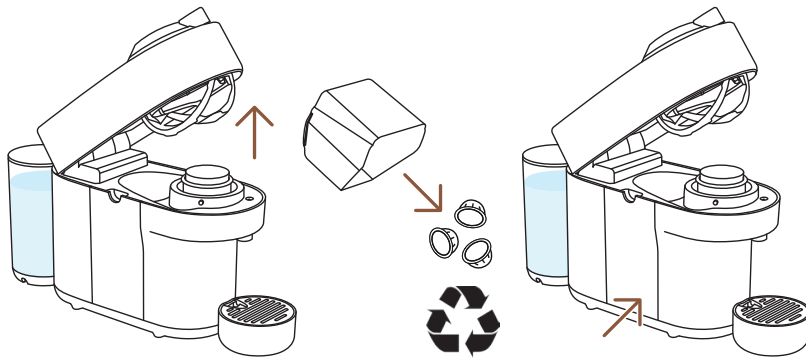

- 3** Avaa kahvikone ja anna käytetyn kapselin tippua säiliöön. Tyhjennä ja huuhtele käytettyjen kapseleiden säiliö ja tippa-alusta, ja aseta ne takaisin paikalleen. Kiitos kun kierrätät **Nespresso**-kahvikapselisi.\*

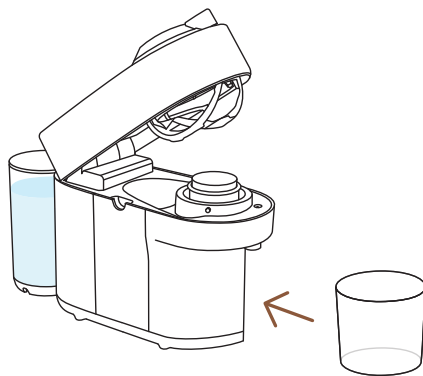

- 4** Poista kupin tuki ja aseta kahvisuuttimen alle tyhjä nestesäiliö (väh. 1L vetoinen).

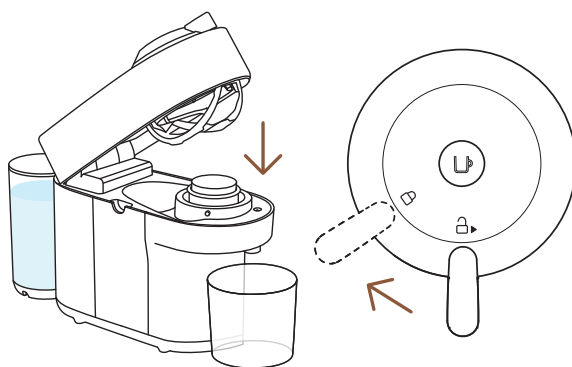

- 5** Sulje kansi ja käännä vipua vasemmalle lukitusasentoon. Varmista, että koneessa ei ole kapseleita ennen puhdistustoimenpiteen aloittamista.

\* TÄMÄ ON **NESPRESSO**. TÄMÄ ON KIERRÄTETTÄVÄÄ. Lue lisätietoa **Nespresso**-kahvikapselien kierrätyksestä osoitteessa [www.nespresso.fi](http://www.nespresso.fi)

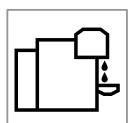

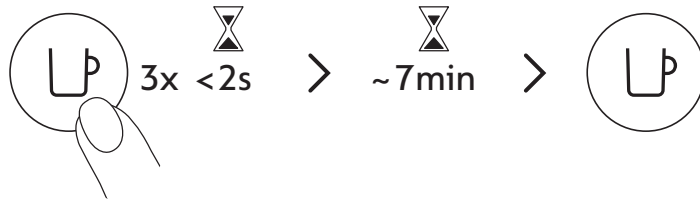

**6** Paina painiketta kolme kertaa kahden sekunnin sisään aloittaaksesi huuhtelun. Anna puhdistusprosessin päättyä automaattisesti.

**i** Kestää alle 2 minuuttia ennen kuin puhdistusprosessi alkaa ja vettä alkaa virrata. Tämä toiminto saattaa viedä seitsemän minuuttia ja se loppuu automaattisesti kun toiminto on valmis. Toiminnon voi keskeyttää koska tahansa painamalla painiketta

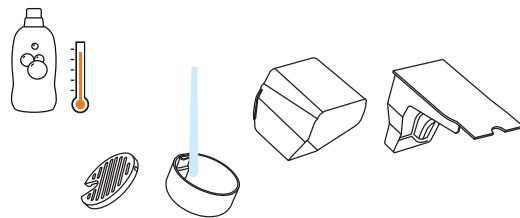

**7** Pese kapselisäiliö, kupin tuki ja tippa-alusta kuumalla vedellä ja miedolla hajusteettomalla pesuaineella.

**HUOM:** Älä käytä voimakkaita tai hankaavia pesuaineita tai välineitä. Älä laita konetta pesukoneeseen. Älä koskaan kasta laitetta tai osaa siitä veteen tai muuhun nesteeseen.

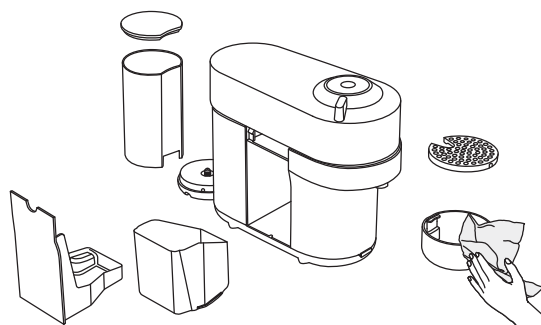

**8** Kuivaa puhtaalla ja raikkaalla pyyhkeellä

**HUOM:** Puhdista kahvisuutin säännöllisesti puhtaalla ja kostealla liinalla. Käytä aina pehmeää liinaa puhdistaksesi koneen.

**HUOMAUTUS:** Koneen kannen sisään voi kerääntyä vettä, kuivaa näkyvät osat puhtaalla ja kuivalla liinalla.

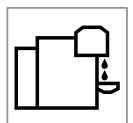
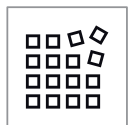

## KALKINPOISTO

Kalkinpoisto pitää huolen että koneesi toimii oikein koko käyttöikänsä ajan, ja että kahvielämyksesi on yhtä hyvä kuin ensimmäisenä käyttöpäivänä. Koneesi ilmoittaa kun kalkinpoisto on tarpeen vilkuttamalla oranssia valoa kolme kertaa ennen kuin se vaihtuu valkoiseksi tasaisesti palavaksi valoksi.



**i** Kalkinpoistotoiminto kestää noin 20 minuuttia ja **sitä ei voi keskeyttää.**

**HUOMIO:** Lue huolellisesti kalkinpoisto-ohjeet ennen aloittamista.

### Tarvitset:

- Kalkinpoistosesti on saatavana [www.nespresso.fi](http://www.nespresso.fi)
- Tyhjä astia (1 L vetoinen)

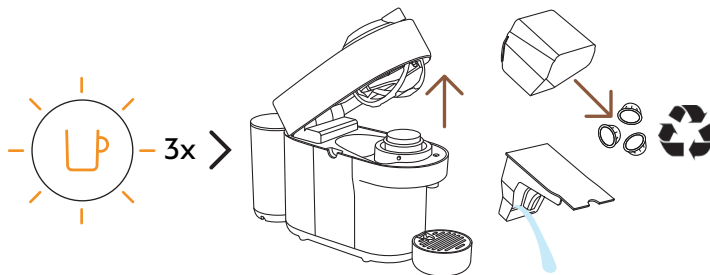

**1** Kun oranssi valo vilkkuu kolme kertaa: Avaa koneen kansi ja vapauta käytetty kapseli. Tyhjennä kapselisäiliö ja tippa-alusta ja aseta ne takaisin paikoilleen. Kiitos kun kierrätät käytetyt **Nespresso**-kahvikapselisi.\*

\* TÄMÄ ON **NESPRESSO**. TÄMÄ ON KIERRÄTETTÄVÄÄ. Lue lisätietoa **Nespresso**-kahvikapseleiden kierrätyksestä osoitteessa [www.nespresso.fi](http://www.nespresso.fi)

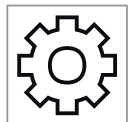

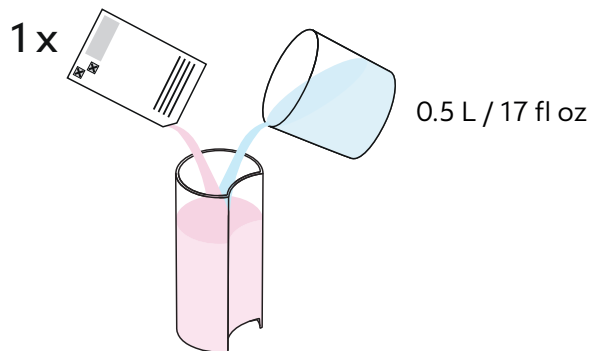

- 2** Täytä vesisäiliö 0.5 L vedellä ja lisää yksi yksikkö **Nespresso** kalkinpoistoliuosta.

**HUOM:** Huomioithan että kalkinpoistoliuos voi olla haitallista. Vältä kontaktia silmien, ihon ja pintojen kanssa.

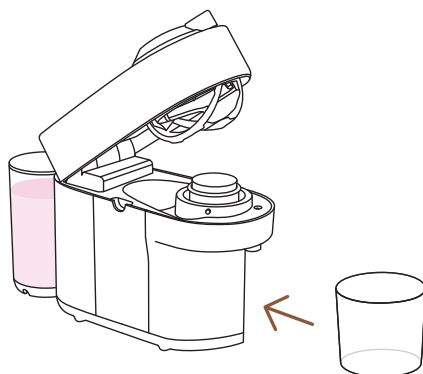

- 3** Poista kupin tuki ja aseta kahvisuuttimen alle tyhjä astia (väh. 1 L vetoinen).

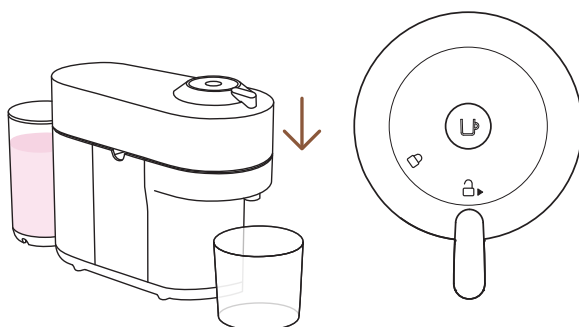

- 4** Kun kone on päällä, sulje koneen kansi ja jätä vipu aukiasentoon.

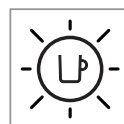
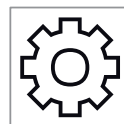
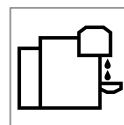
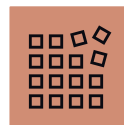
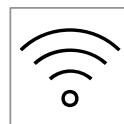

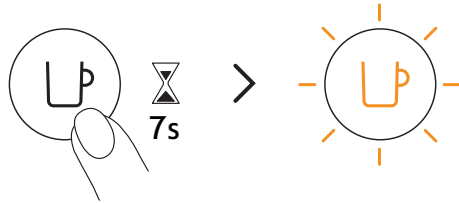

- 5** Paina painiketta ainakin seitsemän sekunnin ajan tai kunnes valo sammuu. Valo alkaa vilkkumaan nopeasti oranssina.

**HUOM:** Sinulla on 45 sekuntia aikaa mennä kalkinpoistotilaan, muuten kone palaa takaisin valmistustilaan.

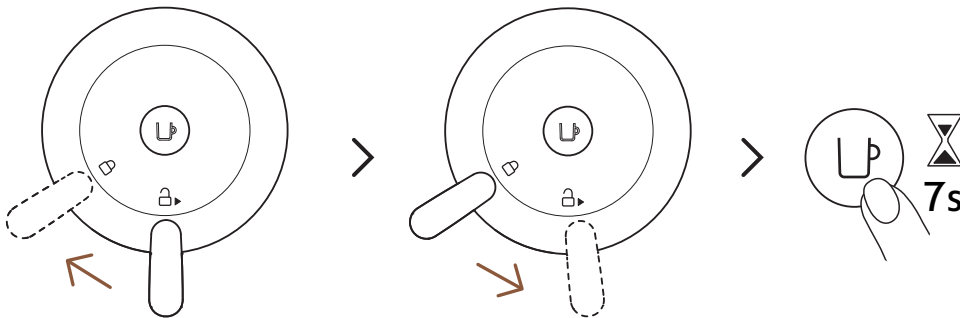

- 6** Sulje koneen kansi kääntämällä vipua vasemmalle lukon kuvaan asti ja avaa vipu kääntämällä sitä oikealle avausasentoon. Paina ja pidä pohjassa painiketta noin seitsemän sekunnin ajan tai niin kauan kunnes valo sammuu. Painike alkaa vilkuttamaan oranssia valoa nopeasti.

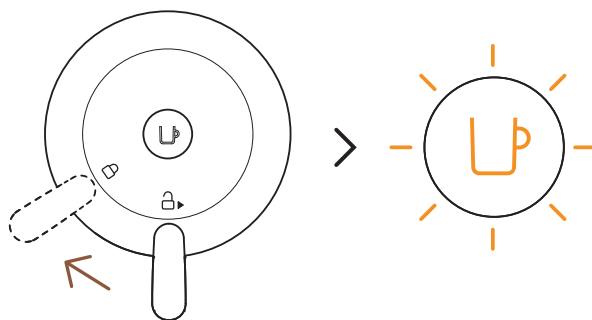

- 7** Päästäksesi kalkinpoistotilaan, lukitse kone kääntämällä vipua vasemmalle lukitusasentoon. Oranssi valo jatkaa vilkkumista. Tämä kertoo että olet kalkinpoistotilassa.

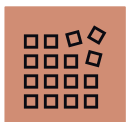



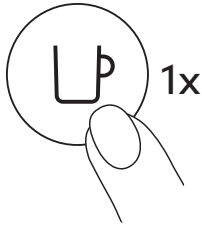

- 8** Aloita kalkinpoisto painamalla kahvipainiketta kerran. Valo vilkkuu jatkuvasti oranssina koko prosessin ajan.

- i** Kone lopettaa automaattisesti kun kalkinpoiston ensimmäinen vaihe on valmis.

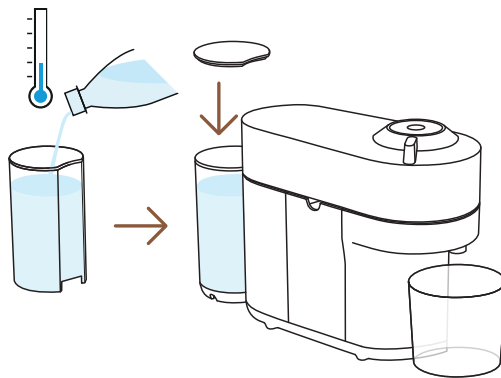

- 9** Kalkinpoistoprosessin päätyttyä, on aika huuhdella kone. Huuhtelee vesisäiliö ja tippa-alusta huolellisesti. Täytä vesisäiliö raikkaalla juomavedellä ja aseta takaisin paikalleen. Tyhjennä säiliö ja aseta se kahvisuuttimen alle.

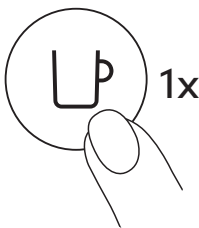

- 10** Paina painiketta aloittaaksesi huuhtelun. Kun valo ensin vilkkuu nopeasti ja sen jälkeen palaa tasaisesti, tämä tarkoittaa että kalkinpoistoprosessi on valmis.

- i** Kone lopettaa automaattisesti kun prosessi on valmis.

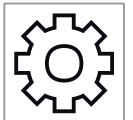
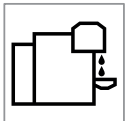

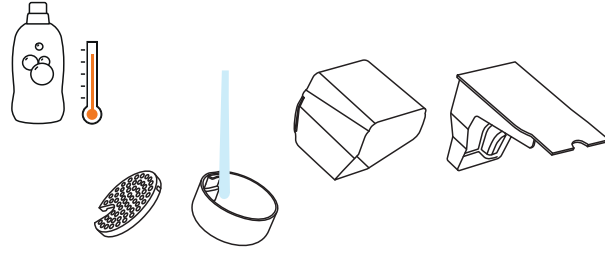

- 11** Pese kapselisäiliö, kupin tuki ja tippa-alusta kuumalla vedellä ja miedolla, hajusteettomalla pesuaineella.

**HUOM:** Älä käytä voimakkaita tai hankaavia pesuaineita tai välineitä. Älä laita konetta astianpesukoneeseen. Älä koskaan kasta konetta tai osaa siitä veteen tai muuhun nesteeseen.

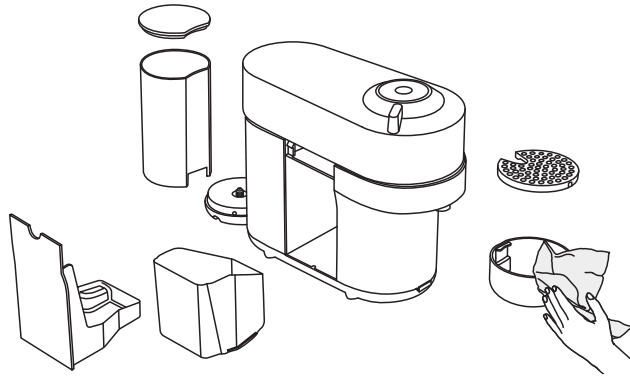

- 12** Kuivaa kone puhtaalla ja raikkaalla pyyheellä. Anna koneen kuivua 10 minuutin ajan ennen seuraavaa käyttöä.

**HUOMAUTUS:** Vettä saattaa kertyä koneen kahvan sisään puhdistuksen aikana. Mikäli tämä tapahtuu, kuivaa näkyvät osat puhtaalla ja kuivalla pyyheellä.

**HUOMIO:** kone voi siirtyä kalkinpoistotilaan vasta, kun 30 tai enemmän kahvia on valmistettu.

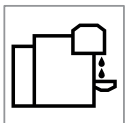

## JÄRJESTELMÄN TYHJENTÄMINEN

Järjestelmän tyhjentäminen on prosessi, mikä tulisi tehdä pitkän käyttämättömyysajan valmistamiseksi, pakkassuojaksi tai kahvikoneen huollon vuoksi.

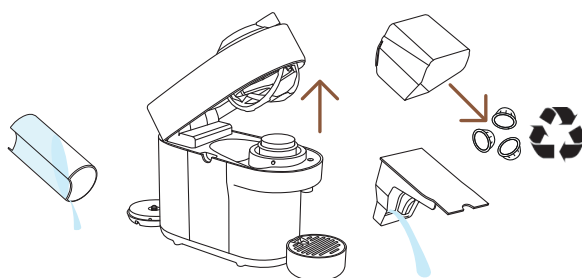

- 1** Tyhjennä vesisäiliö, avaa koneen kansi ja poista käytetty kapseli. Tyhjennä kapselisäiliö ja tippa-alusta. Kiitos kun kierrätät **Nespresso**-kahvikapselisi.\*

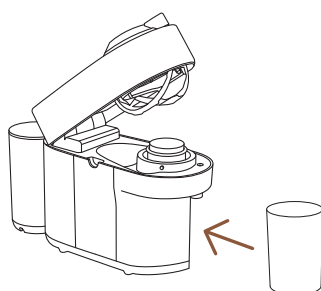

- 2** Aseta ne takaisin paikoilleen koneeseen, poista kupin tuki ja aseta kahvisuuttimen alle tyhjä astia (0.5 L).

\*TÄMÄ ON **NESPRESSO**. TÄMÄ ON KIERRÄTETTÄVÄÄ. Lue lisätietoa **Nespresso**-kahvikapselien kierrätyksestä osoitteessa [www.nespresso.fi](http://www.nespresso.fi)

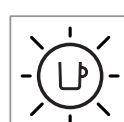
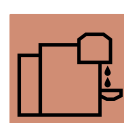
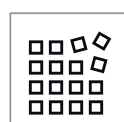
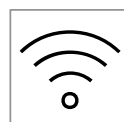

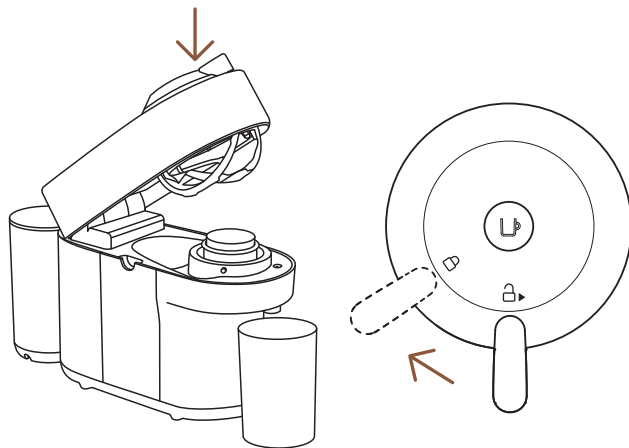

- 3** Kun kone on kytketty, avaa ja sulje koneen kansi ja käännä vipu lukitusasentoon.

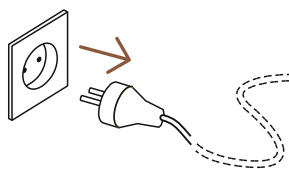

- 4** Irrota virtajohto pistorasiasta

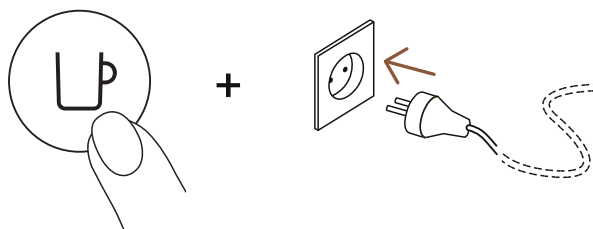

- 5** Paina painiketta pohjaan laittaessasi virtajohdon pistokkeeseen

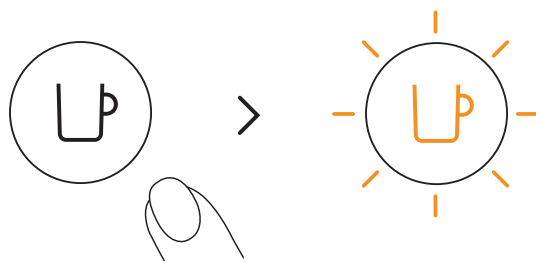

- 6** Vapauta painike. Se vilkkuu oranssina ja tyhjennysprosessi alkaa.

- i** Vie noin 30 sekuntia kun kone saattaa tyhjennysprosessin loppuun. Kone sammuu automaattisesti kun se on valmis.

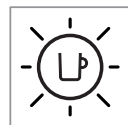
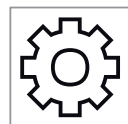
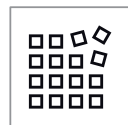
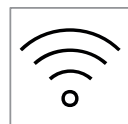

## PALAUTA TEHDASASETUKSET

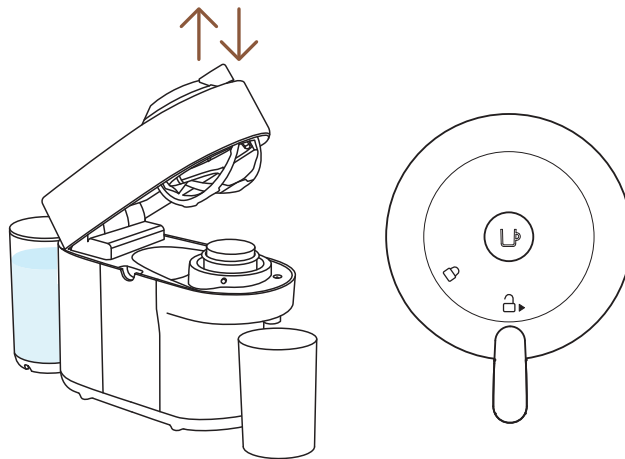

- 1** Kun kone on kytketty, avaa ja sulje koneen kansi ennen kuin jätät vivun **avausasettoon**.

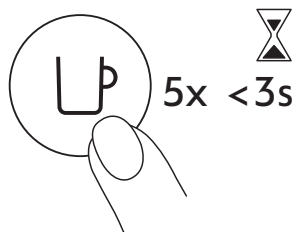

- 2** Paina kahvipainiketta viidesti kolmen sekunnin sisään. Kone on nyt ohjelmoitu tehdasasetuksiin.



## MERKKIVALOJEN YHTEENVETO

Haluatko oppia lisää Vertuo POP:n merkkivaloista?  
Ole hyvä ja katso seuraava video:



## VIANMÄÄRITYS

### Kahvipainikkeessa ei ole valoa

- Kahvikone on mennyt pois päältä automaattisesti; käynnistä kahvikone painamalla kahvipainiketta tai avaamalla se
- Tarkista pistoke, jännite ja sulake.

### Kahvi ei valu, eikä vettä tule.

- Tarkista, että vesisäiliössä on vettä.
- Tarkista, että kahvikapseli on asetettu oikein paikalleen ja että kahvikoneen kansi on suljettu. Käynnistä kahvikone painamalla kahvipainiketta.
- Suorita tarvittaessa kalkinpoisto
- Avaa kahvikoneen kansi ja odota käytetyn kahvikapselin poistumista. Suorita tämän jälkeen puhdistustoimenpiteet puhdistusohjeiden mukaisesti.

### Kahvi ei ole riittävän kuumaa.

- Esilämmitä kahvikuppi kuumalla hanavedellä.
- Suorita tarvittaessa kalkinpoisto

### Vuoto tai kahvin valuminen epätavallisesti.

- Tarkista, että vesisäiliö on asetettu oikein paikalleen.
- Suorita tarvittaessa kalkinpoisto

### Kahvikone menee pois päältä.

- Kahvikoneessa on automaattinen virrankatkaisu kahden minuutin kuluttua edellisen käytön jälkeen.
- Kone voidaan sammuttaa manuaalisesti milloin tahansa (kun ei käytössä) painamalla ja pitämällä painiketta pohjassa kolmen sekunnin ajan.

### Kupissa on kahvinporoja.

- Suorita puhdistustoiminto kahdesti.
- Lue "[Kahvikoneen puhdistus](#)"-osio.

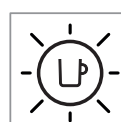
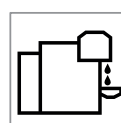
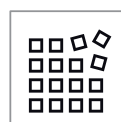
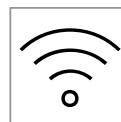

**Kahvikone ei aloita kahvin valuttamista ja kahvipainikkeessa on tasaisesti palava valo. Jos valo välkkyi, katso seuraavat kohdat.**

- Tarkista, että kahvikoneen vipu on lukitusasennossa.
- Jos haluat valmistaa kahvin tai espresson, tarkista, että uusi kahvikapseli on asetettu oikeaan asentoon ja että vipu on lukittu kunnolla. Käynnistä kahvikone painamalla kahvipainiketta.
- Jos olet suorittamassa kahvikoneen puhdistus-, tyhjennys- tai kalkinpoistotoimintoa, niin tarkista, että kahvikapseli on poistunut, sulje kansi ja lukitse kahvikone. Käynnistä haluamasi toiminto kahvipainiketta painamalla.

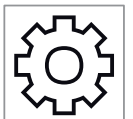
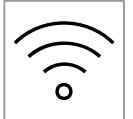

**Kahvikone ei käynnisty ja merkkivalo vilkkuu vuorotellen: yksi välähdys ja yksi tauko.**

- Täytä vesisäiliö ja käynnistä kahvikone painamalla kahvipainiketta.
- Tarkista, että kahvikoneen vipu on lukitusasennossa.

**Merkkivalo vilkkuu, kun kahvikone on käynnissä.**

- Jos kahvi valuu normaalisti, kahvikone toimii oikein.
- Kahvikoneen puhdistus-, kalkinpoisto- tai tyhjennystoiminto on käynnissä, jos kahvikoneen suuttimesta valuu vain vettä. Tarkista käyttöohjeet "Kahvin määrän ohjelmointi" -kohdasta.
- Sammuta kahvikone painamalla kahvipainiketta kolmen sekunnin ajan ja paina kahvipainiketta käynnistääksesi kahvikoneen uudelleen. Odota nyt noin 20 minuuttia, jotta kahvikone voi jäähtyä.

**Kahvikone ei käynnisty ja merkkivalo vilkkuu vuorotellen: yksi välähdys ja yksi tauko.**

- Kahvin valumisen alkaminen kestää hieman viivakoodin lukemisen ja kahvin esikastelun vuoksi.
- Tarkista, että kahvikapseli on asetettu oikein paikalleen ja että kahvikoneen kansi on suljettu. Käynnistä kahvikone painamalla kahvipainiketta.
- Täytä vesisäiliö ja käynnistä kahvikone painamalla kahvipainiketta.
- Sammuta kahvikone painamalla kahvipainiketta kolmen sekunnin ajan ja paina kahvipainiketta käynnistääksesi kahvikoneen uudelleen. Odota nyt noin 20 minuuttia, jotta kahvikone voi jäähtyä.



**Valo vilkkuu vuorotellen: kaksi välähdystä ja yksi tauko. Kahvikone ei ole käynnissä.**

- Tarkista tavallisen kahvin ja espresson valmistuksen aikana, että:
  - 1) Uusi ja ehjä kahvikapseli on asetettu oikeaan asentoon. Käännä vipua lukituksen vapauttamiseksi ja avaa kahvikoneen kansi.
  - 2) Kahvikoneen vipu on lukitusasennossa.
  - 3) Tarkista, että vesisäiliössä on vettä.
- Tarkista kalkinpoisto-, tyhjennys- ja puhdistustoimintojen aikana, että:
  - 1) Käytetty kahvikapseli on poistunut.
  - 2) Kahvikoneen vipu on lukitusasennossa.
- Tarkista kahvin määrän ohjelmoinnin aikana, että:
  - 1) Varmista että kapseli on hyvin paikoillaan.
  - 2) Tarkista käyttöohjeet "**Kahvin määrän ohjelmointi**" -kohdasta.
- Jos ongelma jatkuu:
  - 1) Avaa kahvikone kääntämällä vivusta ja avaamalla kahvikoneen kansi
  - 2) Vaihda kapseli (tarvittaessa).
  - 3) Irrota kahvikoneen virtajohto pistorasiasta ja kytke kahvikone uudelleen pistorasiaan 10 sekunnin kuluttua.
  - 4) Sulje kahvikoneen kansi ja paina kahvipainiketta aloittaaksesi kahvin valmistuksen.

Jos ongelma jatkuu, ota yhteyttä **Nespresso**n asiakaspalveluun

**Valo vilkkuu vuorotellen kolmesti ja jää sitten pysyvästi päälle.**

- Kalkinpoisto on tarpeen: kahvia voidaan valmistaa tämän merkkivaloilmoituksen jälkeen vain muutaman kerran ennen kuin kalkinpoisto on pakollista suorittaa.



## TEKNISET TIEDOT

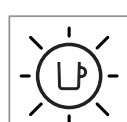
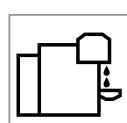
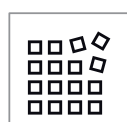
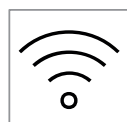

<b>Teho</b>	<b>~220–240 V, 50–60 Hz, 1300–1500 W</b> <b>US, CA:</b> 120 V, 60 Hz, 1500 W <b>MX:</b> 127 V~, 60 Hz, 1380 W
<b>Taajuus</b>	2.402–2.480 GHz
<b>RF-ulostulon teho (EIRP)</b>	Bluetooth 4 dBm Max. e.i.r.p. ja Wi-Fi <20 dMm max. e.i.r.p.
<b>Valmiustila</b>	0.39 W/h
<b>Virransäästötila</b>	Energiansäästötila: 2 min
<b>Lämmitysaika</b>	30 sekuntia (kansi suljettu ja lukittu)
<b>Säädettävä kupin tuki isoja reseptejä varten</b>	Irrotettava asento
<b>Virtajohdon pituus</b>	75 cm
<b>Mitat (L x S x K)</b>	13.6 x 42.6 x 25 cm / 5.3 x 16.7 x 9.8 in
<b>Paino</b>	3.5 kg / 7.72 lbs
<b>Vesisäiliön tilavuus</b>	0.6 l / 20 fl oz
<b>Kapselisäiliön vetoisuus</b>	8 espresso- tai 5 Muki-kapselia

## KONEEN KOODIT

Nespresso	Breville	Delonghi
GCV2, GDV2	BNV120, BNV150	ENV90
Krups	Magimix	
XN9201, XN9204, XN9205, XN9211	M800	

# KLICKA OCH VÄLJ SPRÅK

SV



**SÄKERHET**



**ÖVERSIKT**



**ANSLUTNING**



**FÖRSTA STEGEN**



**KAFFEFÖRBEREDELSE**



**ANPASSA DIN KAFFEMÄNGD**



**RENGÖRING**



**AVKALKNING**



**TÖMNING AV SYSTEMET**



**ÅTERSTÄLL TILL FABRIKSINSTÄLLNINGAR**



**SAMMANFATTNING BLINKNINGAR**



**FELSÖKNING**



**SPECIFIKATIONER**

## SÄKERHET

**VARNING:** Innan du använder din kaffemaskin, var vänlig läs igenom säkerhetsinstruktionerna för att undvika potentiell fara och skada.

### AVFALLSHANTERING OCH MILJÖSKYDD

Denna maskin uppfyller EU-direktiv 2012/19/EG.

Förpackningsmaterial och maskin innehåller återvinningsbara material. Din maskin innehåller värdefulla material som kan återvinnas. Separering av återstående avfallsmaterial till olika typer underlättar återvinning av värdefulla råvaror. Lämna maskinen på en samlingspunkt för återvinning. Du kan få information om bortskaffande från din lokala myndighet.

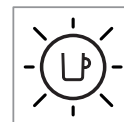
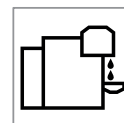
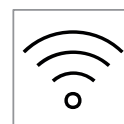

# ÖVERSIKT

## MASKINÖVERSIKT

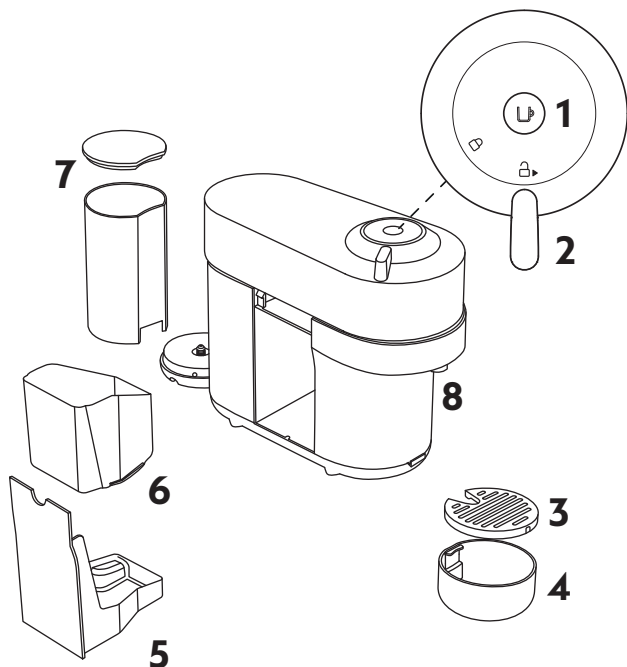

- 1 PÅ/AV och kaffeknapp
- 2 Låsa/Låsa upp spak
- 3 Droppgaller
- 4 Justerbar kopphållare
- 5 Droppbricka
- 6 Behållare för använda kapslar
- 7 Vattentank och lock
- 8 Kaffeutlopp

## FÖRPACKNINGENS INNEHÅLL



- 1 Kaffemaskin
- 2 **Nespresso** kapselbox
- 3 **Nespresso** välkomstmateriel
- 4 Säkerhetsinstruktioner
- 5 Snabbstarts-guide
- 6 Garanti

4 + 5 + 6

**i Uppackning:** Det kan finnas damm på maskinen på grund av det återvunna materialet som används i förpackningen. Detta är inte farligt, rengör helt enkelt med en mjuk trasa.

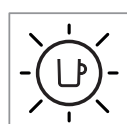
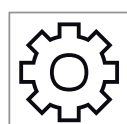
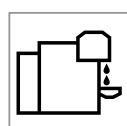
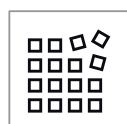
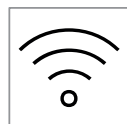

## ÖPPNA/STÄNG

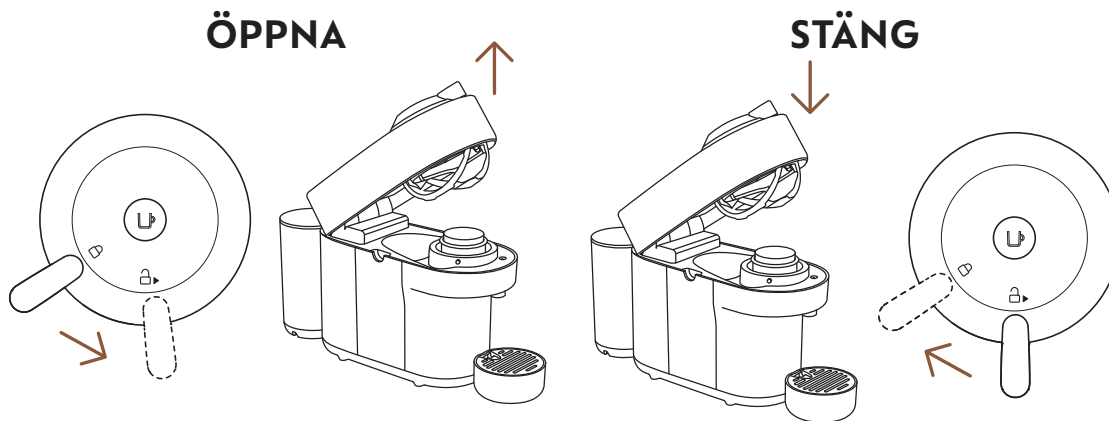

**OBSERVERA:** För korrekt användning av maskinen, öppna inte maskinhuvudet medan maskinen brygger. Vänta till kaffeknappen lyser stadigt vitt. Om du vill stoppa bryggningen tidigare, tryck en gång på kaffeknappen och vänta tills maskinen stoppar innan du öppnar maskinhuvudet.

## VERTUO-SYSTEMET

## KAPSELKOMPATIBILITET

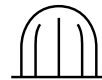
**S****Ristretto**  
(25 ml)**Espresso**  
(40 ml)**M****Double Espresso**  
(80 ml)**Gran Lungo**  
(150 ml)**L****Mug**  
(230 ml)**XL****Alto, Cold Brew Style**  
(355 ml)**Carafe**  
(535 ml)

## TILLBEHÖRSKOMPATIBILITET



Tillbehörskompatibilitet

**Ristretto****Espresso****Double Espresso****Gran Lungo****Mug (S)****Mug (M)****Reveal-glas**

Inte lämpliga tillbehör

**Mug (L)****Carafe**Upptäck hela vår accessoarkollektion på [www.nespresso.com](http://www.nespresso.com)

## PÅ/AV

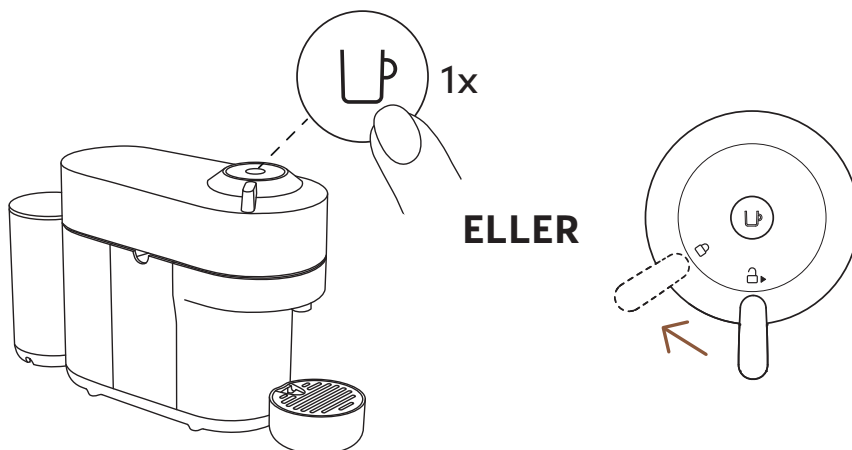
**PÅ**

När maskinen är inkopplad, starta genom att trycka på knappen en gång eller genom att stänga spaken i låst position (med huvudet stängt).

- i** Lampan kommer att blinka i cirka 30 sekunder medan maskinen värms upp. När lampan är stadig, är maskinen redo att användas.

**AV**

För att spara energi kommer maskinen stänga av sig efter 2 minuter utan användning.

- i** Maskinen kan stängas "AV" manuellt när som helst (när den inte används) genom att trycka och hålla ned knappen i 3 sekunder.

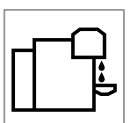
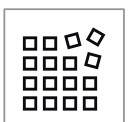

## ANSLUTNING

### VARFÖR DU SKA PARKOPPLA DIN VERTUO POP KAFFEMASKIN

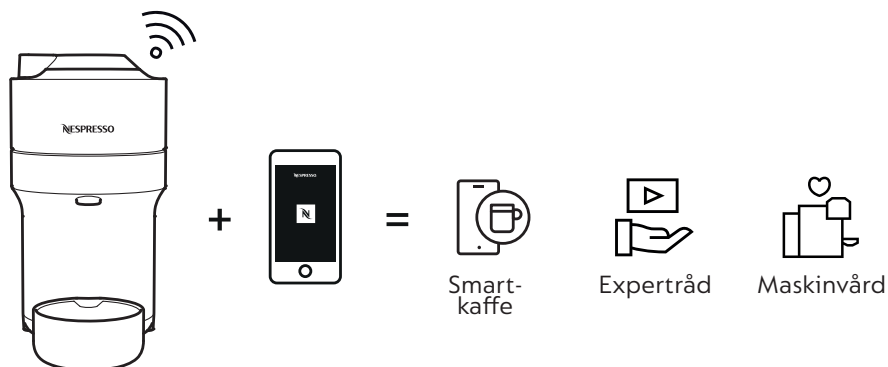

### FÖRDELAR MED ATT KOPPLA UPP DIN VERTUO POP-MASKIN

- **Smart-kaffe:** Håll dig alltid steget före för att få det senaste inom kaffeinnovation från **Nespresso** genom att hålla din maskin i toppskick och uppdaterad.
- **Expertråd:** Få support och enkla handledningsvideor som följer med din kafferesa via din smartphone.
- **Maskinvård:** Få omedelbar notifikation om när och hur du ska serva din maskin med en enkel guide för avkalkning, sköljning, rengöring, osv.

### HUR MAN KOPPLAR UPP SIN VERTUO POP-MASKIN?

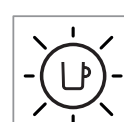
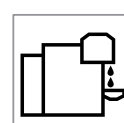
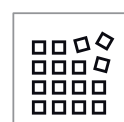





- 1** Ladda ner eller uppdatera **Nespresso**-appen. Starta **Nespresso**-appen på din smartphone eller surfplatta. Tryck på maskinikonen längst upp till höger på din skärm.

**NOTERA:** För optimalt utförande och en smidig upplevelse rekommenderar vi att du ansluter din maskin till en Wi-Fi router istället för en smartphone-hotspot.

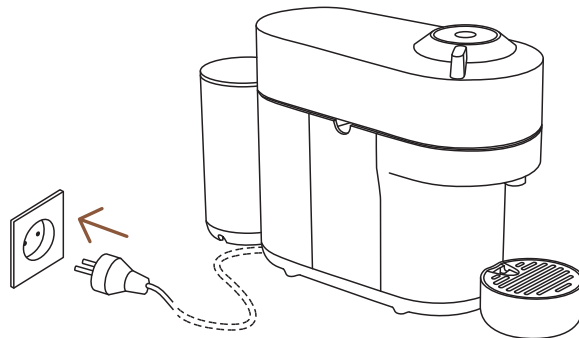

- 2** Koppla in strömkabeln.



- 3** Följ instruktionerna via **Nespresso**-appen.

**WARNING:** Läs först säkerhetsföreskrifterna för att undvika risker för allvarliga elchockar och brand. Se till att jordförbindelsen är korrekt när du sätter in maskinen i eluttaget.

- \* App Store® är ett varumärke som tillhör Apple Inc., registrerat i USA och andra länder
- \*\* Google Play och Google Play-logotypen är varumärken som tillhör Google LLC.

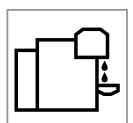
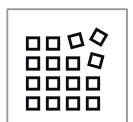

## INAKTIVERA BLUETOOTH OCH WI-FI PÅ MASKINEN

Maskinen levereras med en anslutningsmodul som är aktiverad som standard. Det ger tillgång till ytterligare funktioner som förbättrar din kaffeupplevelse. För att inaktivera anslutningsmodulen följer du dessa steg:

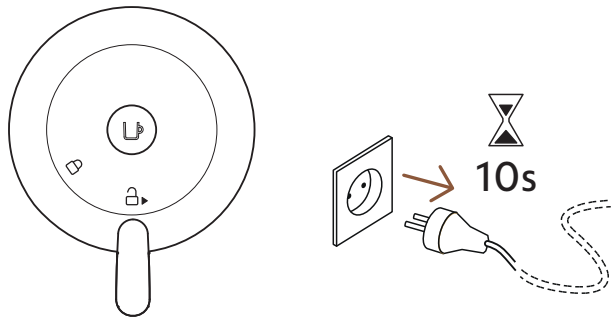

- 1 Med maskinen stängd och spaken i **upplåst** position, koppla ur maskinen i minst 10 sekunder.

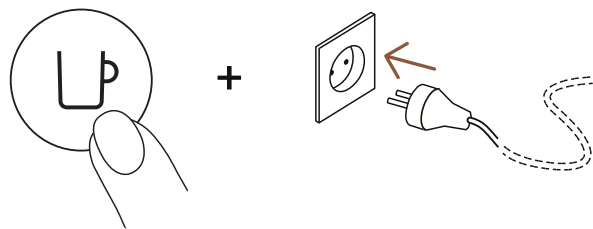

- 2 Tryck och håll ned knappen när du kopplar i kontakten. Knappen kommer att blinka orange för att bekräfta att anslutningsmodulen nu har inaktiverats.

- i** Följ samma steg för att aktivera anslutningsmodulen igen. Knappen kommer att blinka vit för att bekräfta att modulen har aktiverats igen.

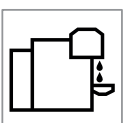

# FÖRSTA STEGEN

## FÖRSTA RENGÖRING

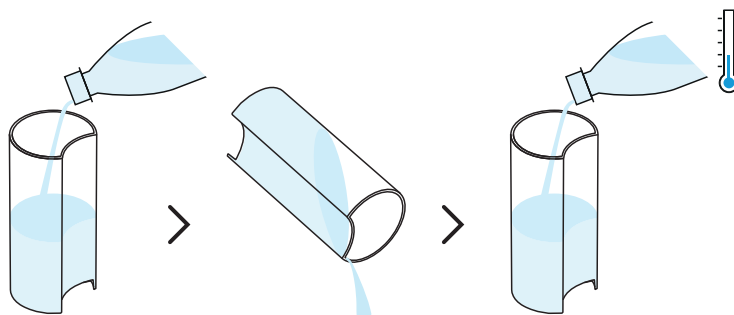

- 1** Skölj och rengör först vattentanken och locket innan du fyller den med färskt dricksvatten.

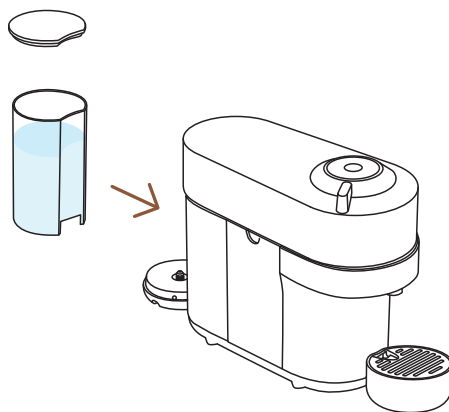

- 2** Stäng vattentanken med locket och se till att den sitter ordentligt på plats.

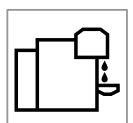

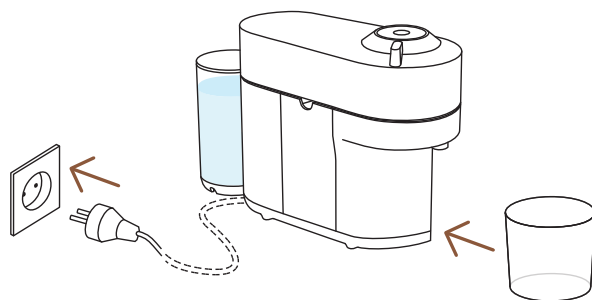

- 3** Med maskinen inkopplad, ta bort kopphållaren och placera en tom behållare (på minst 1 L) under kaffeutloppet.

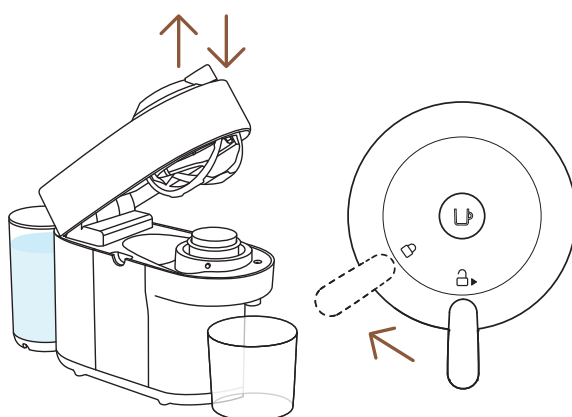

- 4** Öppna och stäng maskinen. Se till att spaken är i låst position.

- i** Lampan kommer att blinka medan maskinen värms upp. Det tar cirka 30 sekunder. När lampan är stadig är maskinen redo. Se till att ingen kapsel är insatt.

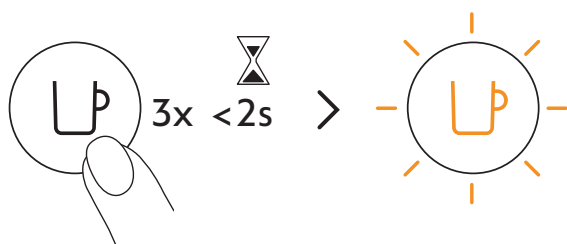

- 5** Tryck på knappen 3 gånger inom 2 sekunder för att börja skölja. När lampan blinkar orange, låt sköljningsproceduren slutföras automatiskt. När lampan lyser stadigt vitt är cykeln klar.

- i** Det bör ta mindre än 2 minuter innan sköljningsprocessen börjar och vatten börjar strömma. Detta kan ta upp till 7 minuter.

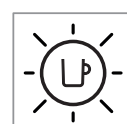
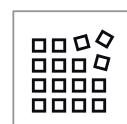
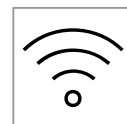

# KAFFEFÖRBEREDELSE

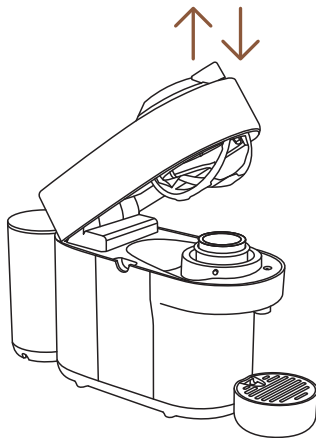

**1** Öppna och stäng maskinen.

**i** Lampan på kaffeknappen kommer att blinka medan maskinen värms upp. När lampan är stadig är maskinen redo att användas.

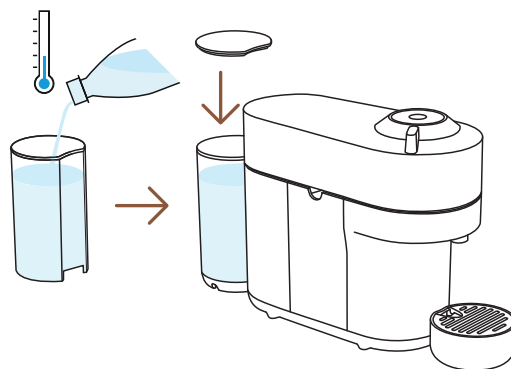

**2** Fyll tanken med färskt dricksvatten och placera tillbaka den på plats.

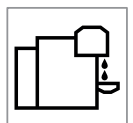

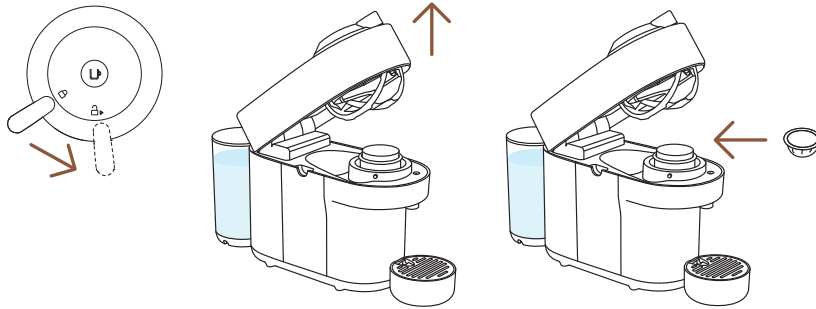

- 3** Lås upp och öppna maskinhuvudet helt och sätt i en Vertuo-kapsel med den höga sidan nedåt.

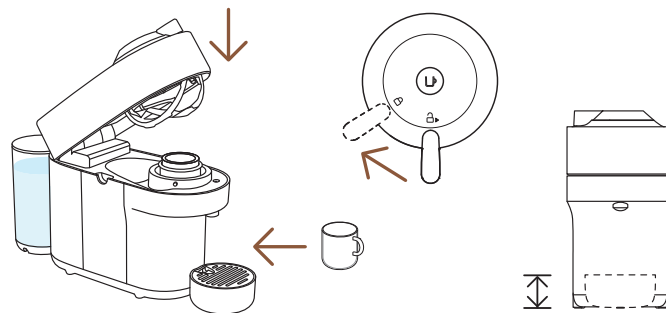

- 4** Stäng maskinhuvudet och lås genom att vrida spaken åt vänster tills låsställning och placera en kopp. Kopphållaren kan justeras för att rymma din koppstorlek.

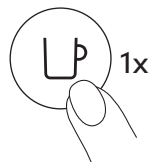

- 5** Börja brygga genom att trycka på knappen en gång.

**OBSERVERA:** För korrekt användning av maskinen, öppna inte maskinhuvudet medan maskinen brygger. Vänta till kaffeknappen lyser stadigt vitt. Om du vill stoppa bryggningen tidigare, tryck en gång på kaffeknappen och vänta tills maskinen stoppar innan du öppnar maskinhuvudet.

- i** På grund av streckodsläsningen, kaffe-precipitationen och infusionstiden tar det en stund innan kaffet börjar strömma. Maskinen känner automatiskt igen den insatta kapseln och väljer kaffeberedningsparametrar och kopplängd som definierats av **Nespresso**-kaffeexperter för att extrahera kaffeblandningarna på bästa sätt.

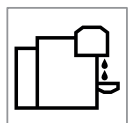

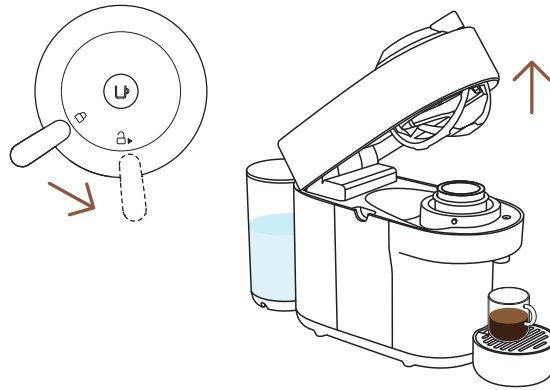

- 6** När kaffet slutar brygga, öppna maskinhuvudet genom att vrida spaken åt höger mot upplåst läge för att automatiskt mata ut kapseln och njut av ditt kaffe. När kaffet slutar brygga, öppna maskinen, mata ut kapseln och njut av ditt kaffe.



- 7** Glöm inte att återvinna dina **Nespresso**-kapslar.\*

\* **DETTA ÄR NESPRESSO. DETTA ÄR ÅTERVINNINGSBART.** För mer information om återvinning av dina **Nespresso** kaffekapslar, besök [www.nespresso.com](http://www.nespresso.com)

## UPPTÄCK VÅR KAFFERECEPT-FUNKTION.



Med denna maskin erbjuder **Nespresso** dig en specifik funktion för att koncentrera dina kaffebryggingar och skapa dina egna recept.

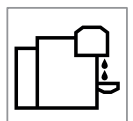
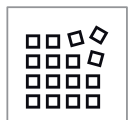

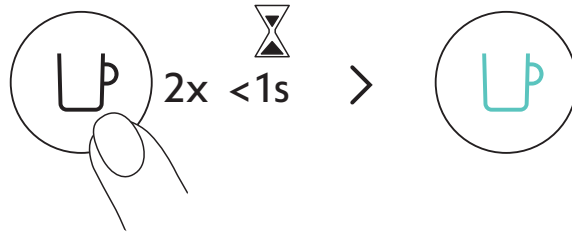

Med din maskin på, dubbelklicka på kaffeknappen. Det kommer att blinka turkos och din kaffebruggning kommer att vara koncentrerad, vilket optimerar kaffesmaken i recept med tillsatser (mjölk, grädde, över is ...). För en oslagbar kaffeupplevelse.

40 ml	80 ml	150 ml	230 ml	355 ml	535 ml
✓	✓	✓	✓	✗	✗
25 ml	40 ml	40 ml	80 ml		

För att njuta av alla fördelar rekommenderar vi att du brygger vårt Coffee+-sortiment enbart som de officiella koppstorlekarna. För det bästa koppresultatet rekommenderar vi inte att brygga våra XL (Alto Ambrato, Alto Onice), Cold Brew Style & Carafe Pour Over Style med denna funktion.

**NOTERA:** En uppdatering av din maskin via **Nespresso**-appen kan vara nödvändig för att aktivera denna funktion.



Upptäck hur du kan uppgradera din maskin med vår Aeroccino-serie på [www.nespresso.com](http://www.nespresso.com).

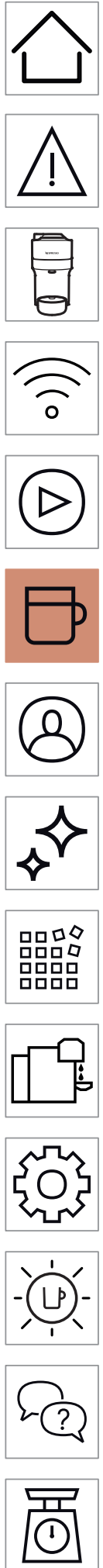



## ANPASSA DINA KAFFESTORLEKAR

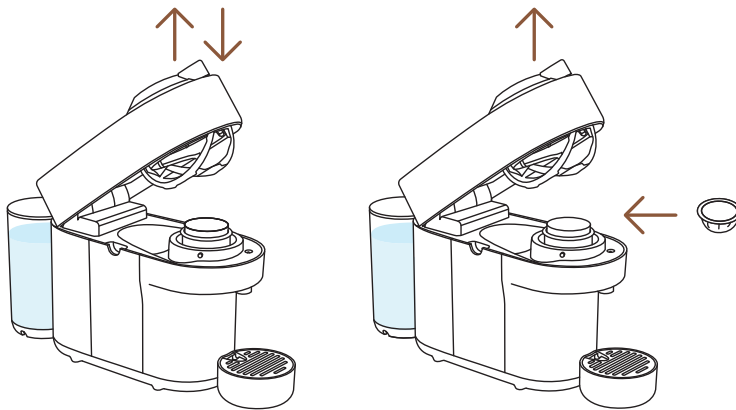

- 1** Med maskinen på, öppna maskinen och lägg i kapseln som du vill programmera.

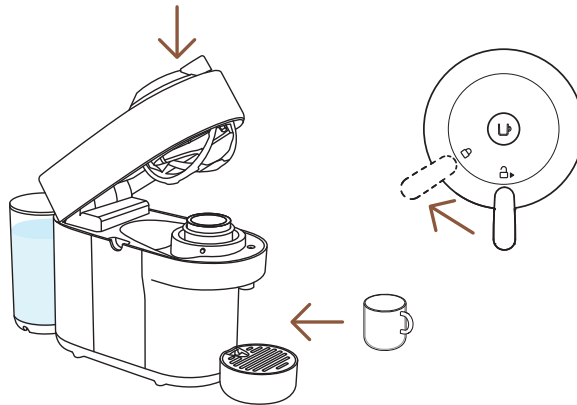

- 2** Stäng maskinhuvudet, vrid spaken åt vänster mot låsställning och placera en kopp.

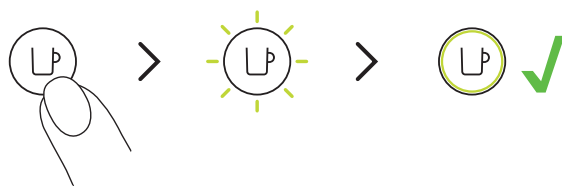

- 3** Tryck och håll ner knappen, släpp några sekunder innan önskad mängd har uppnåtts. Den nya vattenmängden är nu programmerad för kapseltypen som användes under inställningen.

- i** Programmeringen är specifik för varje kapseltyp. Koppstorleken är programmerbar från 20 ml till 535 ml.

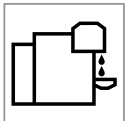

**OBSERVERA:** För korrekt användning av maskinen, öppna inte maskinhuvudet medan maskinen brygger. Vänta till kaffeknappen lyser stadigt vitt. Om du vill stoppa bryggningen tidigare, tryck en gång på kaffeknappen och vänta tills maskinen stoppar innan du öppnar maskinhuvudet.

**NOTERA:** När en kundspecifik volym programmeras av användaren, kommer varje gång den typen av kapsel sätts in i maskinen, förberedelsen att stanna vid den koppstorleken som användaren har programmerat. Om du vill återgå till standardinställningarna, se avsnittet **“Återställning till fabriksinställningar”**.

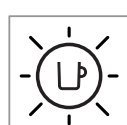
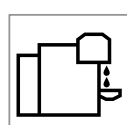
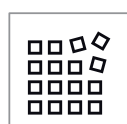
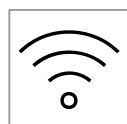

# RENGÖRING

Rengör maskinen en gång i månaden, när det börjar dyka upp kaffefläckar inuti maskinhuvudet eller efter en lång tidsperiod utan användning.

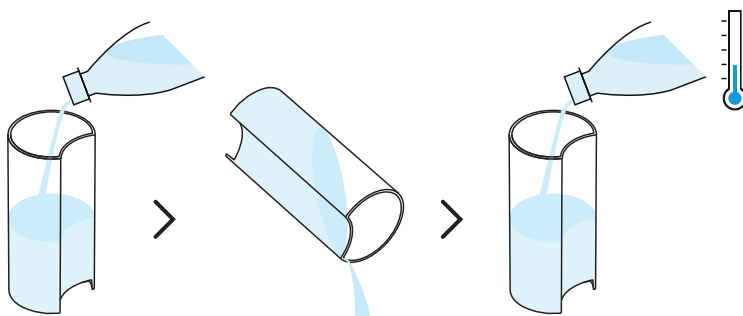

- 1** Skölj och rengör vattentanken och locket innan du fyller den med färskt dricksvatten.

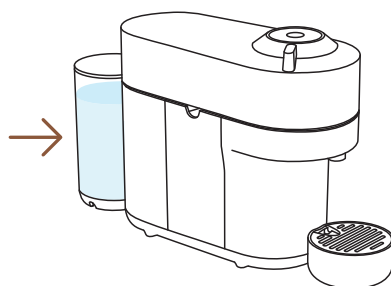

- 2** Sätt tillbaka vattentanken på maskinen.

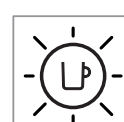
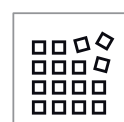
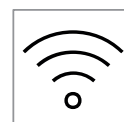

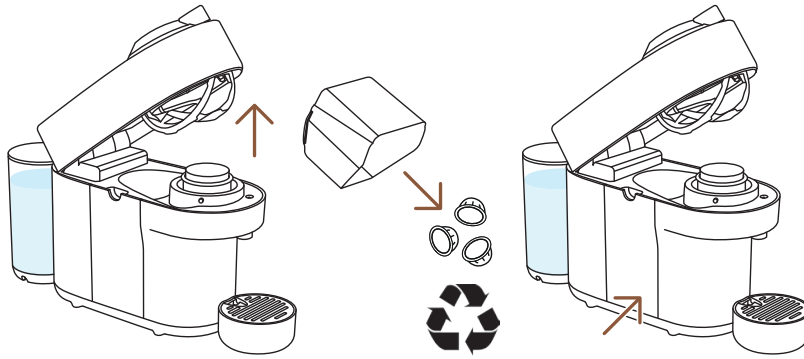

- 3** Med maskinen på, lås upp och öppna maskinen och låt den använda kapseln bli utkastad. Töm och skölj kapselbehållaren och droppbrickan och sätt tillbaka dem på plats. Glöm inte att återvinna dina **Nespresso**-kapslar.\*

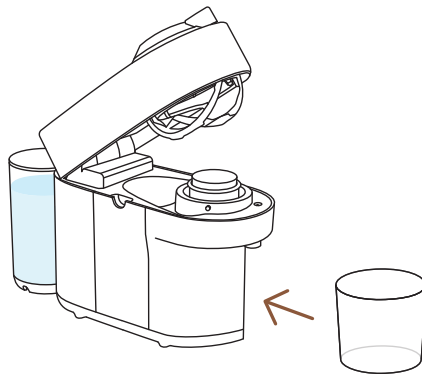

- 4** Ta bort kophållaren och placera en tom behållare (på minst 1 L) under kaffeutloppet.

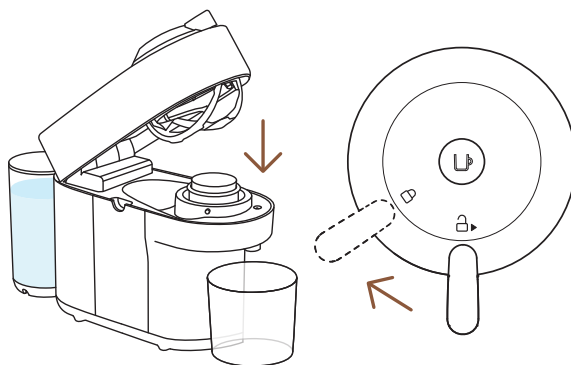

- 5** Stäng maskinhuvudet och vrid spaken till vänster mot låst position. Se till att det inte finns några kapslar i maskinen innan du startar sköljningsproceduren.

\* DETTA ÄR **NESPRESSO**. DETTA ÄR ÅTERVINNINGSBART. För mer information om återvinning av dina **Nespresso** kaffekapslar, besök [www.nespresso.com](http://www.nespresso.com)



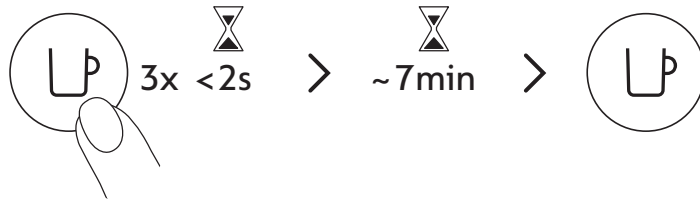

- 6** Tryck på knappen 3 gånger inom 2 sekunder för att börja skölja. När lampan blinkar orange, låt rengöringsproceduren slutföras automatiskt.

- i** Det bör ta mindre än 2 minuter innan sköljningsprocessen börjar och vattnet börjar flöda. Denna process kan ta upp till 7 minuter och kommer att stoppa automatiskt när cykeln är klar. Processen kan stoppas när som helst genom att trycka på knappen

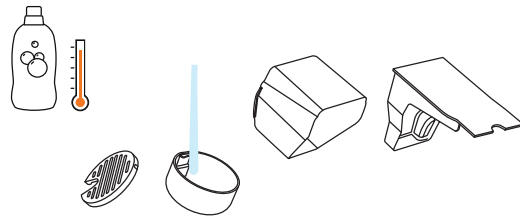

- 7** Tvätta kapselbehållaren, koppållaren och droppbrickan med varmt vatten och mild doftlöst rengöringsmedel.

**VARNING:** Använd inte starka eller slipande rengöringsmedel eller lösningsmedel. Sätt inte in maskinen i diskmaskinen. Sänk aldrig ned apparaten eller delar av den i vatten.

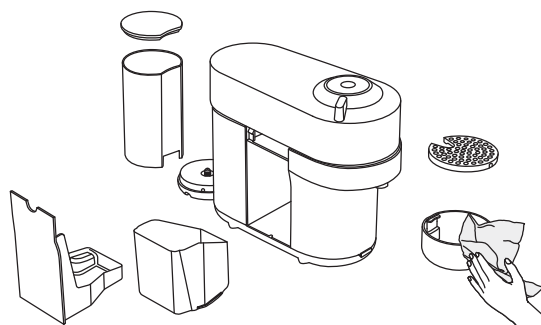

- 8** Torka med en ren handduk.

**VARNING:** Rengör kaffeutloppet regelbundet med en ren fuktig trasa. Använd alltid mjuka trasor för att rengöra maskinen.

**NOTERA:** Vatten kan samlas i maskinhuvudet, torka av synliga delar med en ren, torr trasa.

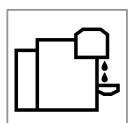

## AVKALKNING

Att avkalka din maskin kommer att säkerställa att den fungerar korrekt under hela dess livstid och kommer att göra din kaffeupplevelse lika fantastisk som den första dagen. Din maskin kommer att indikera när avkalkning behövs genom att blinka orange 3 gånger innan den blir stadigt vit.



**i** Avkalkningsproceduren tar ~20 minuter och kan inte avbrytas.

**NOTERA:** Läs igenom avkalkningsinstruktionerna noga innan du börjar.

### Du kommer att behöva:

- Ett avkalkningskit, tillgängligt på [www.nespresso.com](http://www.nespresso.com).
- En tom behållare (på 1 L).

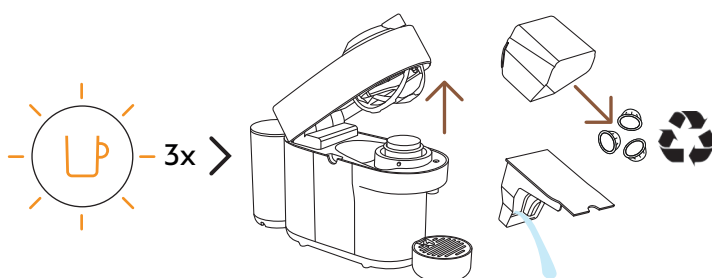

- 1** Med knappen blinkande orange 3 gånger: Lås upp och öppna maskinhuvudet och låt den använda kapseln lösas ut. Töm kapselbehållaren och droppbrickan och placera tillbaka dem på maskinen. Glöm inte att återvinna dina **Nespresso**-kapslar.\*

\* DETTA ÄR **NESPRESSO**. DETTA ÄR ÅTERVINNINGSBART. För mer information om återvinning av dina **Nespresso** kaffekapslar, besök [www.nespresso.com](http://www.nespresso.com)

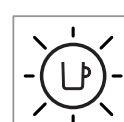
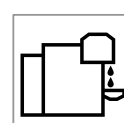
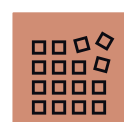
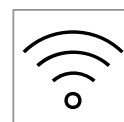

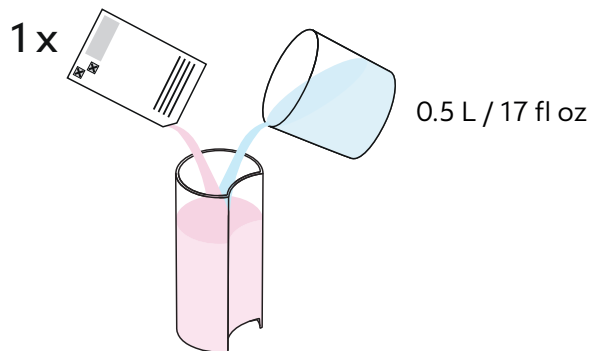

- 2** Fyll vattentanken med 0,5 L vatten och tillsätt 1 enhet av **Nespresso** avkalkningsvätska.

**WARNING:** Observera att avkalkningslösningen kan vara skadlig. Undvik kontakt med ögon, hud och ytor.

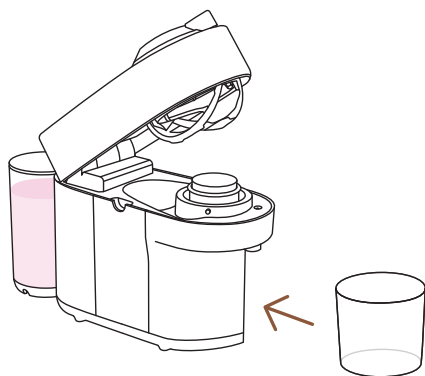

- 3** Ta bort kopphållaren och placera en tom behållare (på minst 1 L) under kaffeutloppet.

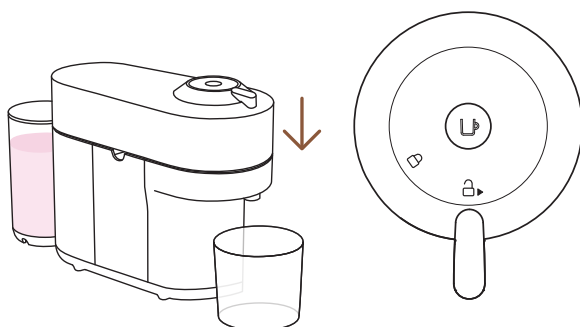

- 4** Med maskinen på, stäng maskinhuvudet och låt spaken vara olåst.

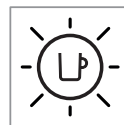
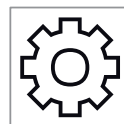
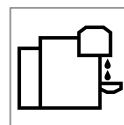
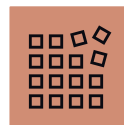
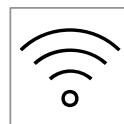

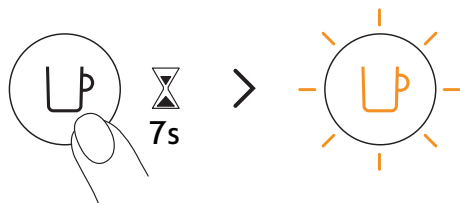

- 5** Håll ned knappen i minst 7 sekunder eller tills du ser att ljuset stängs av. Knappen kommer att börja blinka orange snabbt.

**WARNING:** Du har nu 45 sekunder på dig att gå in i avkalkningsläget, annars kommer maskinen gå tillbaka till bryggläget.

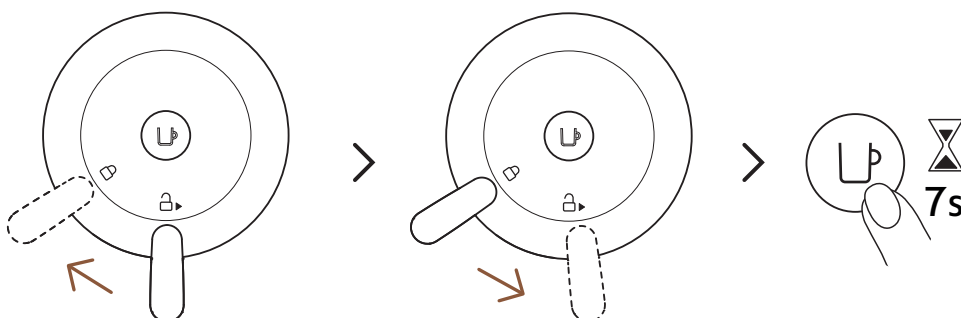

- 6** Lås maskinhuvudet genom att vrida spaken till vänster tills låssymbolen syns och lås sedan upp spaken genom att vrida till höger till olåst position. Tryck sedan och håll ned knappen igen i cirka 7 sekunder eller tills lampan stängs av. Knappen börjar blinka orange snabbt.

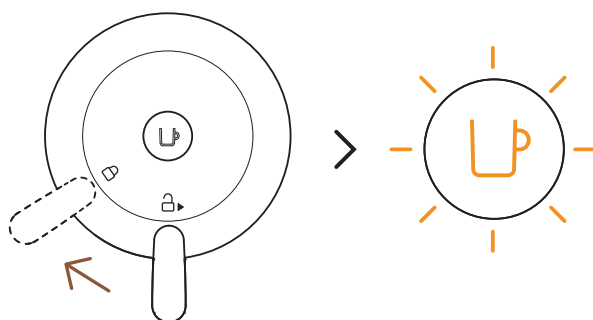

- 7** För att komma in i avkalkningsläget, lås maskinen genom att vrida spaken till vänster mot låst position. Lamporna ska fortfarande blinka orange snabbt. Detta indikerar att du har gått in i avkalkningsläget.

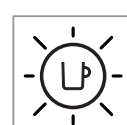
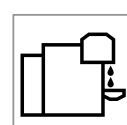
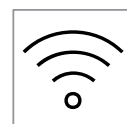



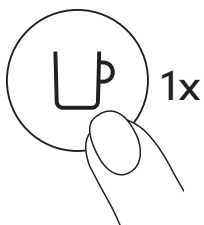

- 8** Tryck på kaffeknappen för att starta avkalkningsprocessen. Lampan kommer blinka orange under hela processen.
- i** Maskinen kommer att stanna automatiskt när den första fasen av avkalkningen är klar.

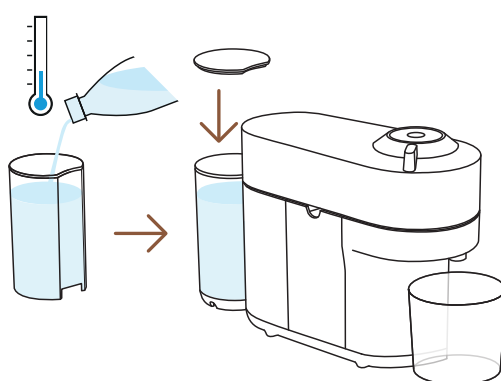

- 9** När avkalkningsprocessen är klar är det dags att skölja maskinen. Skölj vattentanken och droppbrickan ordentligt. Fyll vattentanken med färskt dricksvatten och sätt tillbaka den på plats. Töm behållaren och placera tillbaka den under kaffeutloppet.

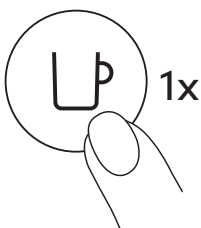

- 10** Tryck på knappen för att skölja maskinen. När knappen slutar blinka snabbt och blir stadigt, är avkalkningsproceduren klar.
- i** Maskinen stannar automatiskt när proceduren är klar.

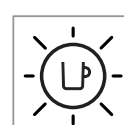
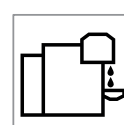
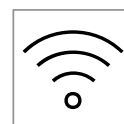

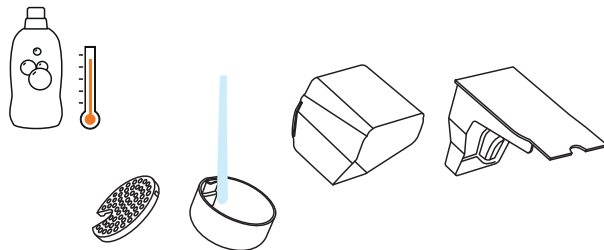

- 11** Tvätta kapselbehållaren, koppållaren och droppbrickan med varmt vatten och ett mildt, luktfritt rengöringsmedel.

**WARNING:** Använd inte något starkt eller abrasivt rengöringsmedel eller lösningsmedel. Sätt inte in maskinen i diskmaskinen. Doppa aldrig apparaten eller delar av den i vatten.

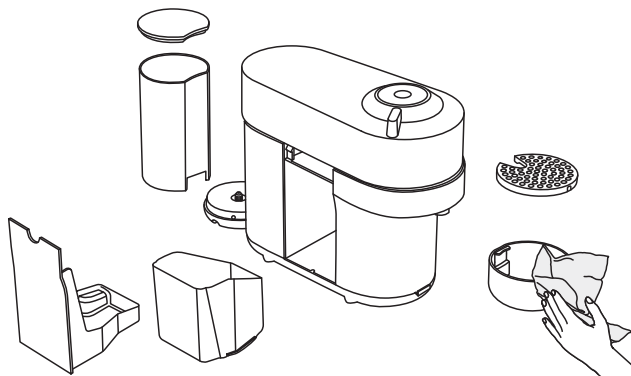

- 12** Torka maskinen med en ren och fräsch handduk. Låt maskinen torka i 10 minuter innan du använder den.

**NOTERA:** Vatten kan samlas inne i maskinhuvudet under rengöring. Om detta händer, torka synliga delar med en ren torr trasa.

**NOTERA:** Maskinen kan endast gå in i avkalkningsläge efter minst 30 kaffekapslar har blivit bryggda.

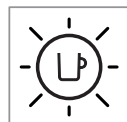
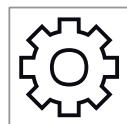
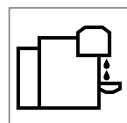
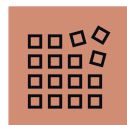
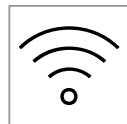

## TÖMNING AV SYSTEMET

Att tömma systemet är en process som kan göras före en period av icke-användning, för frostskydd eller innan maskinen skickas för reparation.

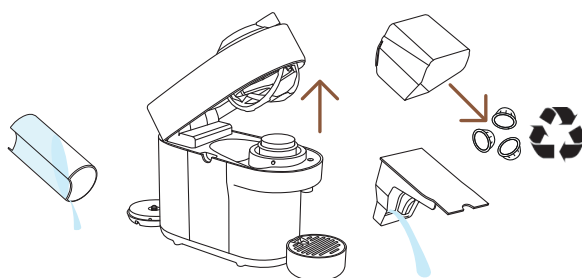

- 1** Töm vattentanken, öppna maskinhuvudet och låt den använda kapseln kastas ut. Töm behållaren för använda kapslar och droppbrickan. Glöm inte att återvinna dina **Nespresso**-kapslar.\*

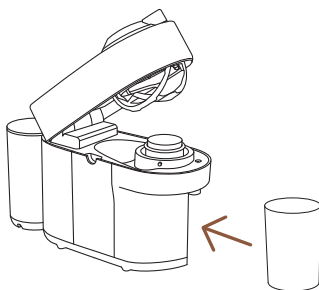

- 2** Placera tillbaka dem på maskinen, ta bort kopphållaren och placera en tom behållare (0,5 L) under kaffeutloppet.

\* DETTA ÄR **NESPRESSO**. DETTA ÄR ÅTERVINNINGSBART. För mer information om återvinning av dina **Nespresso** kaffekapslar, besök [www.nespresso.com](http://www.nespresso.com)

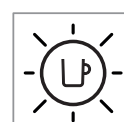
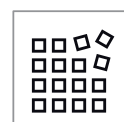
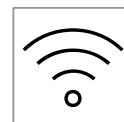

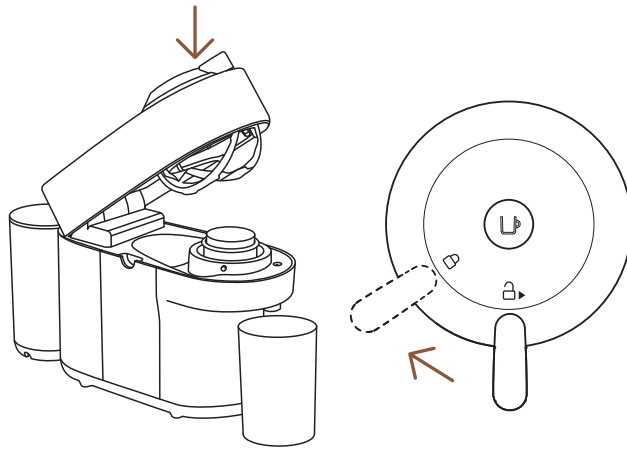

- 3** Med maskinen inkopplad och på, öppna och stäng maskinhuvudet och vrid spaken mot låst position.

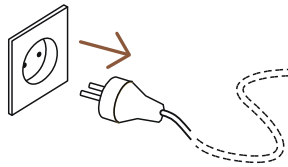

- 4** Koppla ur maskinen

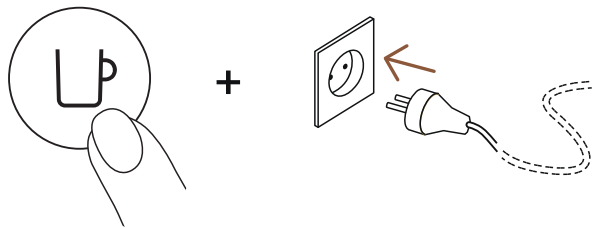

- 5** Tryck och håll ned knappen när du kopplar i kontakten



- 6** Släpp knappen. En orange lampa kommer att börja blinka och tömningsprocessen kommer att börja.

- i** Det tar ungefär 30 sekunder för maskinen att slutföra tömningsprocessen. Maskinen stängs automatiskt av när den är tom.

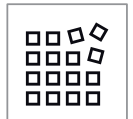

## ÅTERSTÄLL TILL FABRIKSINSTÄLLNINGAR

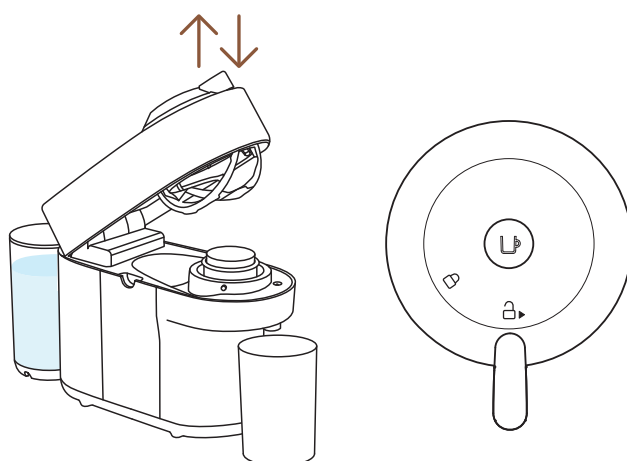

- 1 Med maskinen inkopplad, öppna och stäng maskinhuvudet innan du lämnar spaken i **upplåst** position.

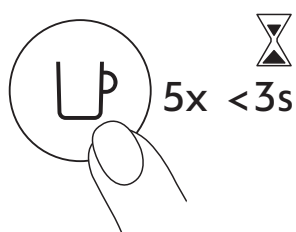

- 2 Tryck på knappen 5 gånger inom 3 sekunder. Maskinen är nu programmerad med fabriksinställningarna.

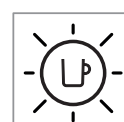
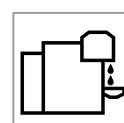
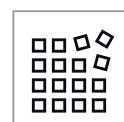
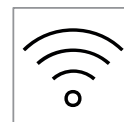

## SAMMANFATTNING BLINKNINGAR

Söker du mer information om blinkningar på Vertuo Pop?  
Vänligen titta på följande video.



## FELSÖKNING

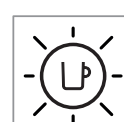
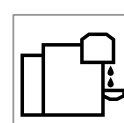
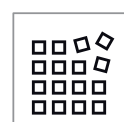
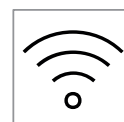

### Inget ljus runt knappen

- Maskinen har stängts AV automatiskt; tryck på knappen eller "LÅS UPP" maskinen.
- Kontrollera elnätet, kontakten, spänningen och säkringen.

### Inget kaffe, inget vatten

- Kontrollera att vattentanken är fylld.
- Kontrollera att en ny kapsel är isatt korrekt, att spaken är ordentligt låst och tryck på knappen för att starta.
- Avkalka om nödvändigt.
- Öppna maskinhuvudet och låt kapseln matas ur. Utför sedan rengöring enligt rengöringsavsnittet.

### Kaffet är inte varmt nog

- Förvärm koppen med varmt dricksvatten från kranen.
- Avkalka om nödvändigt.

### Läckage eller ovanligt kaffeflöde

- Kontrollera att vattentanken är korrekt placerad.
- Avkalka om nödvändigt.

### Maskinen sätter sig i "AV-läge"

- För att spara energi kommer maskinen stänga av sig efter 2 minuter utan användning.
- Maskinen kan stängas "AV" manuellt när som helst (när den inte används) genom att trycka och hålla ned knappen i 3 sekunder.

### Kaffesump i koppen

- Utför rengöringsproceduren två gånger.
- Se avsnittet om "Rengöring"

### Maskinen startar inte och har stadigt ljus på. Om ljuset blinkar, se nästa punkter:

- Kontrollera att spaken är låst ordentligt.
- Om du vill brygga en Kaffe eller Espresso, kontrollera att en ny kapsel är isatt korrekt, att spaken är låst ordentligt och tryck på knappen för att starta.
- Om du rengör, avkalkar eller tömmer systemet, kontrollera att ingen kapsel sitter i, stäng sedan och lås maskinen och tryck på knappen för att starta någon av dessa funktioner.

**Maskinen startar inte och ljuset blinkar växelvis: 1 blinkning och 1 paus.**

**Ljuset blinkar under tiden som maskinen körs.**

**Maskinen startar inte och ljuset blinkar växelvis: 1 blinkning och 1 paus.**

**Ljuset blinkar växelvis: 2 blinkningar och 1 paus kontinuerligt. Maskinen körs inte.**

- Fyll vattentanken och tryck på knappen för att starta.
- Kontrollera att spaken är låst ordentligt.
- Om kaffet rinner normalt indikerar detta att maskinen fungerar som den ska.
- Om det bara rinner vatten kör maskinen en användarbegäran för antingen rengöring, avkalkning eller tömning av systemet. Se motsvarande avsnitt.
- Sätt maskinen på "AV-läge" genom att trycka på knappen i 3 sekunder och tryck sedan på den igen för att slå på maskinen. Vänta nu cirka 20 minuter för att låta maskinen svalna efter omfattande användning.
- Det kommer att ta lite tid innan kaffeströmmen kommer ut (på grund av streckkodsläsning och förvätning av kaffet).
- Kontrollera att en ny kapsel är isatt korrekt, att spaken är ordentligt låst och tryck på knappen för att starta.
- Fyll vattentanken och tryck på knappen för att starta.
- Sätt maskinen på "AV-läge" genom att trycka på knappen i 3 sekunder och tryck sedan på den igen för att slå på maskinen. Vänta nu cirka 20 minuter för att låta maskinen svalna efter omfattande användning.
- Under vanlig Kaffe/Espresso-förberedelse:
  - 1) Lås upp spaken och öppna maskinhuvudet och kontrollera att en ny oskadad kapsel är isatt korrekt.
  - 2) Kontrollera att spaken är i "LÅST" position
  - 3) Kontrollera att vattentanken är fylld.
- Under Avkalkning, Tömning och Rengöring
  - 1) Kontrollera att kapseln har matats ut.
  - 2) Kontrollera att spaken är i "LÅST" position
- Under Volymprogrammering
  - 1) Kontrollera om en kapsel har isatts korrekt.
  - 2) Se motsvarande avsnitt.

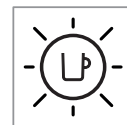
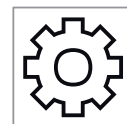
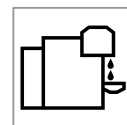
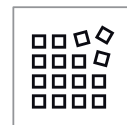
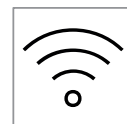



**Ljust blinkar växelvis 3 gånger och är sedan stadigt på.**

- Om problemet kvarstår:
  - 1) Lås upp spaken och öppna maskinhuvudet.
  - 2) Ersätt kapseln (om nödvändigt).
  - 3) Koppla ut sladden från uttaget och anslut maskinen till uttaget efter 10 sekunder.
  - 4) Stäng maskinhuvudet och tryck på knappen för att sätta PÅ och tryck igen för att börja brygga. Om problemet kvarstår, kontakta **Nespresso**.

Om problemet kvarstår, kontakta **Nespresso**.
- Avkalkning behövs: maskinen kan endast köras några få gånger när varning visas innan avkalkning blir nödvändig

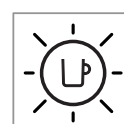
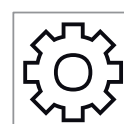
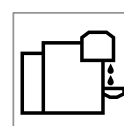
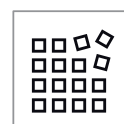
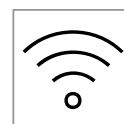

## SPECIFIKATIONER

<b>Ström</b>	<b>~220–240 V, 50–60 Hz, 1300–1500 W</b> <b>US, CA:</b> 120 V, 60 Hz, 1500 W <b>MX:</b> 127 V~, 60 Hz, 1380 W
<b>Frekvens</b>	2.402–2.480 GHz
<b>RF utgångseffekt (EIRP)</b>	Bluetooth 4 dBm Max. e.i.r.p. och Wi-Fi <20 dMm max. e.i.r.p.
<b>Standby</b>	0.39 W/h
<b>Strömsparkläge</b>	Automatisk avstängning: 2 min
<b>Uppvärmningstid</b>	30 sekunder (maskinhuvudet stängt och låst)
<b>Rörlig kopphållare för stora recept</b>	Avtagbar enpositionsållare
<b>Kabellängd från enhetens försändelse</b>	75 cm / 30 in
<b>Dimensioner (BxDxH)</b>	13.6 x 42.6 x 25 cm / 5.3 x 16.7 x 9.8 in
<b>Vikt</b>	3.5 kg / 7.72 lbs
<b>Vattentankskapacitet</b>	0.6 l / 20 fl oz
<b>Kapselbehållarkapacitet</b>	8 espresso- eller 5 mug-kapslar

## MASKINKODER

<b>Nespresso</b>	<b>Breville</b>	<b>Delonghi</b>
GCV2, GDV2	BNV120, BNV150	ENV90
<b>Krups</b>	<b>Magimix</b>	
XN9201, XN9204, XN9205, XN9211	M800	



# DAȚI CLICK ȘI ALEGEȚI LIMBA DVS.

RO



**INSTRUCȚIUNI DE SIGURANȚĂ**



**PREZENTARE GENERALĂ A APARATULUI**



**CONECTIVITATE**



**PRIMII PAȘI**



**PREGĂTIREA CAFELEI**



**ADAPTAȚI VOLUMUL CAFELEI  
CONFORM PREFERINȚELOR**



**CURĂȚARE**



**DECALCIFIERE**



**GOLIREA SISTEMULUI**



**RESETAREA LA SETĂRILE DIN FABRICĂ**



**PREZENTAREA ALERTELOR**



**DEPANARE**



**SPECIFICAȚII**

## INSTRUCȚIUNI DE SIGURANȚĂ

**ATENȚIE:** Înainte de a folosi aparatul de cafea, vă rugăm să citiți broșura cu instrucțiuni de siguranță pentru a evita posibile vătămări și daune.

### RECICLAREA ȘI PROTECȚIA MEDIULUI

Aparatul dumneavoastră conține materiale valoroase, care pot fi recuperate sau reciclate. Separarea deșeurilor pe categorii ajută în procesul de reciclare a materiilor prime valoroase. Transportați aparatul la un punct de colectare. Puteți obține informații despre colectarea în vederea reciclării de la autoritățile locale.

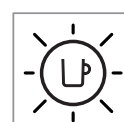
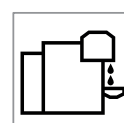
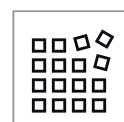
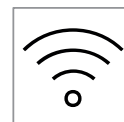

# PREZENTARE GENERALĂ A APARATULUI

## PREZENTAREA APARATULUI

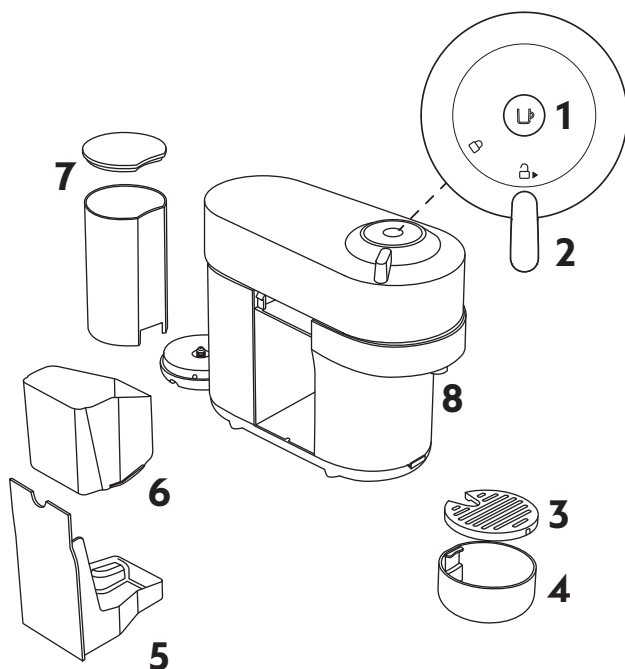

- 1 Buton de PORNIRE/OPRIRE și buton pentru cafea
- 2 Mâner blocare/deblocare
- 3 Grilă de picurare
- 4 Suport pentru ceașcă ajustabil
- 5 Tăviță de picurare
- 6 Recipient colectare capsule
- 7 Rezervor de apă și capac
- 8 Unitate de extracție a cafelei

## CONȚINUTUL AMBALAJULUI



- 1 Aparat de cafea
- 2 Cutie capsule **Nespresso**
- 3 Broșură de bun venit **Nespresso**
- 4 Instrucțiuni de siguranță
- 5 Ghid de pornire rapidă
- 6 Garanție

**i Despachetare:** este posibil să existe praf pe suprafața aparatului din cauza materialelor reciclate utilizate în ambalaj. Acestea nu sunt periculoase, curățați cu o lavetă moale. Când despachetați espressoorul, îndepărtați materialele protectoare din plastic.

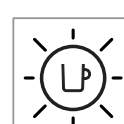
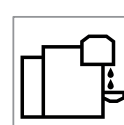
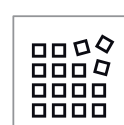
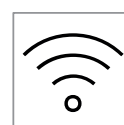

## PORNIRE/OPRIRE

### DESCHIDE

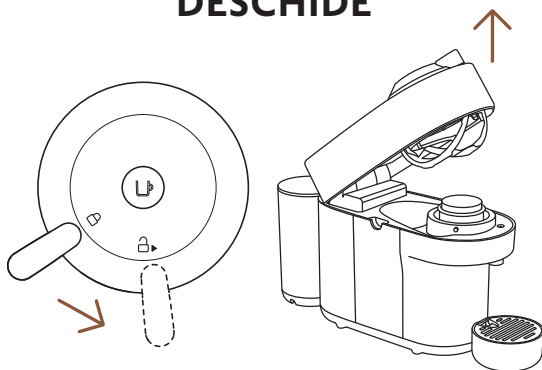

### ÎNCHIDE

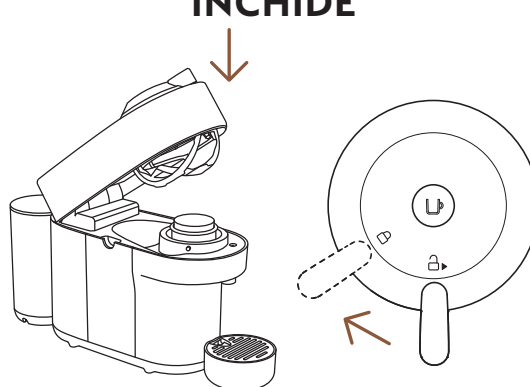

**ATENȚIE:** pentru utilizarea corectă a espressoarei, vă rugăm să nu deschideți capul de extracție al mașinii în timp ce se prepară cafeaua, așteptați până când lumina butonului de cafea devine albă. Dacă doriți să opriți procesul de extracție mai devreme, vă rugăm să apăsați o singură dată butonul de cafea și așteptați până când mașina se oprește înainte să deschideți capul de extracție.

## SISTEMUL VERTUO

### COMPATIBILITATEA CAPSULEI



**S**

**Ristretto**

(25 ml)

**Espresso**

(40 ml)



**M**

**Espresso Dublu**

(80 ml)

**Gran Lungo**

(150 ml)



**L**

**Mug**

(230 ml)



**XL**

**Alto, Cold Brew**

(355 ml)

**Carafe**

(535 ml)

### COMPATIBILITATEA ACCESORIULUI



Compatibilitatea  
accesoriului



**Ristretto**



**Espresso**



**Espresso  
Dublu**



**Gran  
Lungo**



**Mug (S)**



**Mug (M)**



**Pahare  
Reveal**



Accesorii in-  
compatibile



**Mug (L)**



**Carafe**

Descoperiți întreaga gamă de accesorii **Nespresso** accesând  
[www.nespresso.com](http://www.nespresso.com)

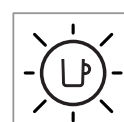
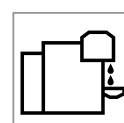
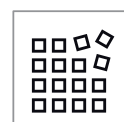
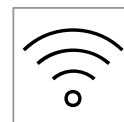

## PORNIT/OPRIT

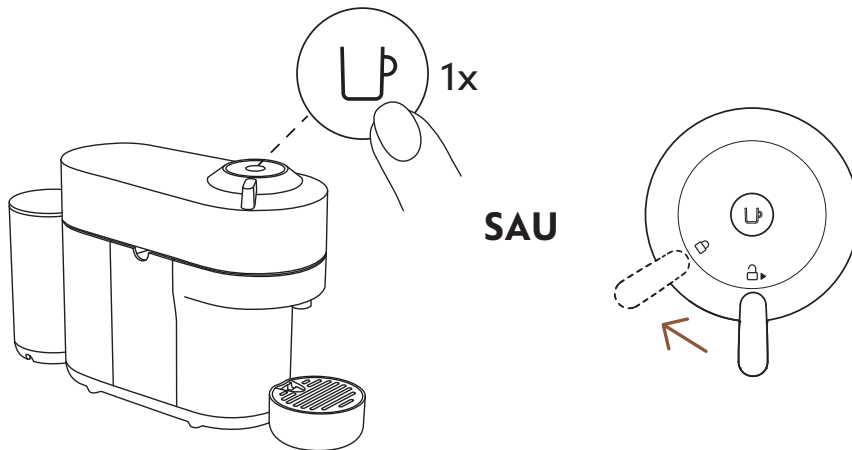

### PORNIT

În timp ce espressoorul este conectat la priză, porniți-l prin apăsarea butonului o singură dată sau prin închiderea mânerului în poziția de blocare (cu unitatea de extracție închisă).

- i** Butoanele vor lumina intermitent pentru aproximativ 30 de secunde în timp ce mașina se va încălzi. Odată ce luina devine stabilă, mașina este gata de utilizare.

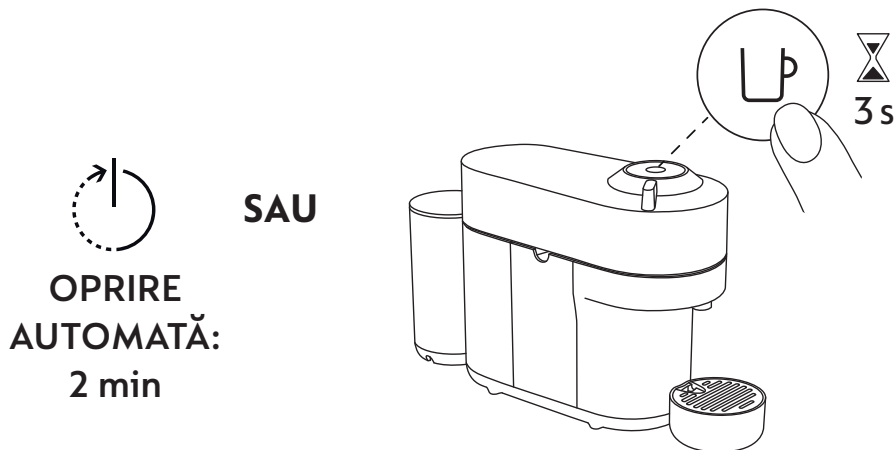

### OPRIRE

Pentru a economisi energie, aparatul se va închide automat după 2 minute de neutilizare.

- i** Aparatul se poate închide manual oricând (atunci când nu este în funcțiune) prin menținerea apăsării butonului timp de 3 secunde.

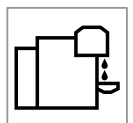

## CONECTIVITATE

### DE CE TREBUIE SĂ CONECTAȚI APARATUL DUMNEAVOASTRĂ VERTUO POP?

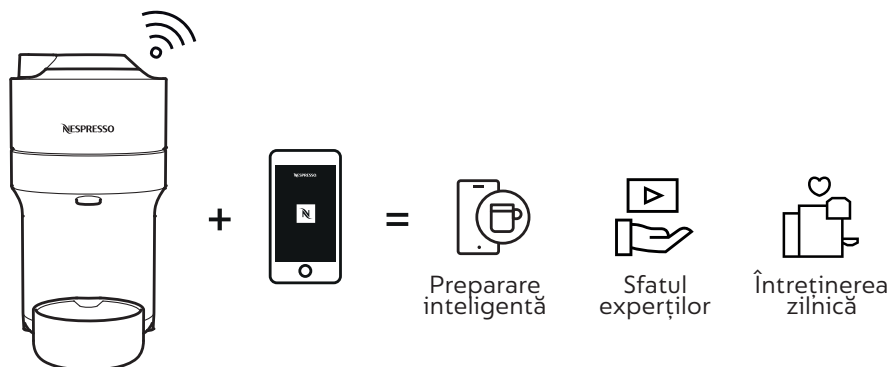

### BENEFICIILE CONECTĂRII ESPRESSORULUI DUMNEAVOASTRĂ VERTUO POP

- **Preparare inteligentă:** Fiți întotdeauna cu un pas înaintea pentru a fi la curent cu ultimele noutăți **Nespresso** în materie de cafea, menținând espressorul actualizat
- **Sfatul experților:** Obțineți asistență și tutoriale video simple pentru a vă însoți în călătoria cafelei prin intermediul smartphone-ului
- **Întreținerea zilnică:** Primiți notificări instant despre cum și când să vă întrețineți espressorul prin intermediul unui ghid simplu pentru decalcifiere, clătire, curățare etc.

### CUM PUTEȚI CONECTA ESPRESSORULUI DUMNEAVOASTRĂ VERTUO POP?

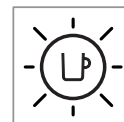
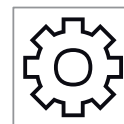
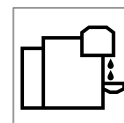
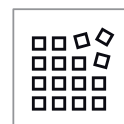





**1** Descărcati și actualizați aplicația **Nespresso**. Deschideți aplicația **Nespresso** pe telefonul dvs. sau pe tabletă. Apăsați pictograma cu aparatul de cafea din partea dreaptă a ecranului.

**NOTĂ:** pentru o performanță optimă și o experiență de utilizare fără cusur, vă recomandăm să conectați espressoorul la un router Wi-Fi, mai degrabă decât la un hotspot mobil.

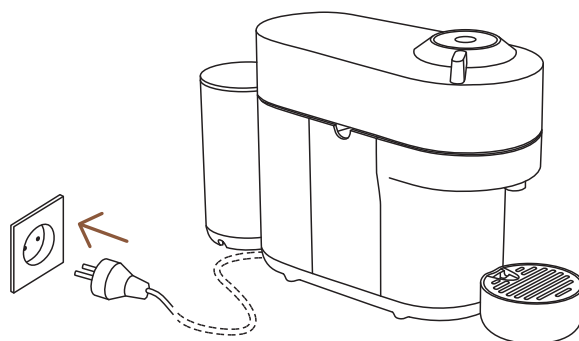

**2** Conectați cablul de alimentare.



**3** Urmați instrucțiunile prin intermediul aplicației **Nespresso**.

**ATENȚIE:** Înainte de a folosi aparatul de cafea, vă rugăm să citiți broșura cu instrucțiuni de siguranță pentru a evita riscul de electrocutare și daune. Vă rugăm să asigurați Vă rugăm să asigurați continuitatea împământării atunci când conectați mașina la priză.

\* App Store® este marcă înregistrată a Apple Inc., înregistrată în USA și alte țări.

\*\* Google Play și Google Play logo sunt mărci înregistrate ale Google LLC.

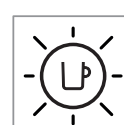
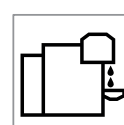
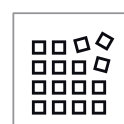

## DECONNECTAREA BLUETOOTH SAU WI-FI A ESPRESSORULUI

Espressorul dispune de un modul electronic de conectivitate, activat în mod implicit. Acesta oferă acces la funcții suplimentare, îmbunătățind experiența dvs. de cafea. Pentru a dezactiva modulul de conectivitate, urmați acești pași:

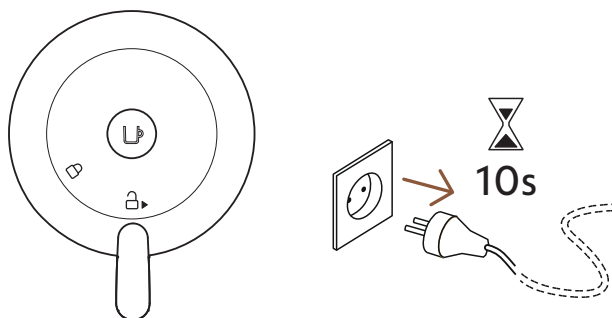

- 1** Cu aparatul închis și mânerul în poziția **deblocată**, scoateți aparatul din priză timp de cel puțin 10 secunde.

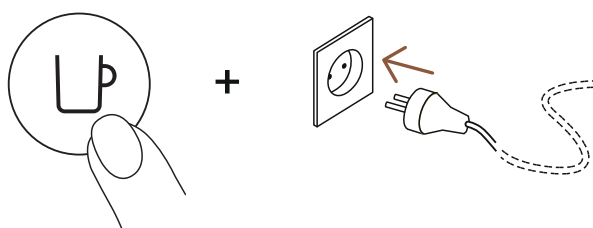

- 2** Apăsați și țineți apăsat butonul când aparatul este în priză. Butonul va clipi în portocaliu pentru a confirma faptul că modulul de conectivitate a fost dezactivat.

- i** Urmăți aceiași pași pentru a reporni modulul de conectivitate. Butonul va clipi în alb pentru a confirma faptul că modulul a fost reactivat.

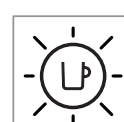
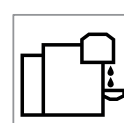
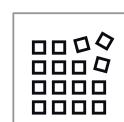

# PRIMII PAȘI

## PRIMA CURĂȚARE

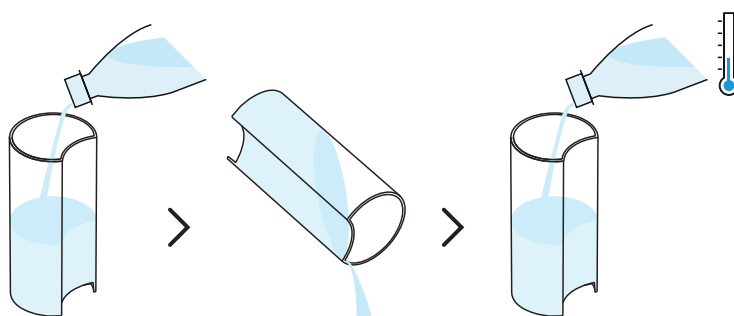

- 1** Mai întâi clățiți și curățați rezervorul de apă și capacul înainte de a-l umple cu apă potabilă proaspătă.

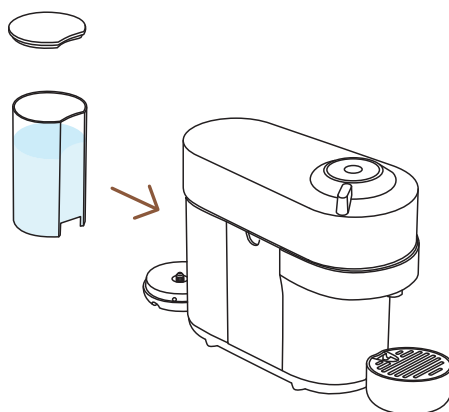

- 2** Închideți rezervorul de apă cu ajutorul capacului și puneți rezervorul de apă la locul său, asigurându-vă că este fixat corect în poziție.

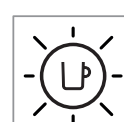
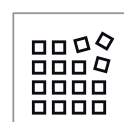
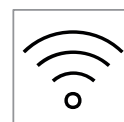

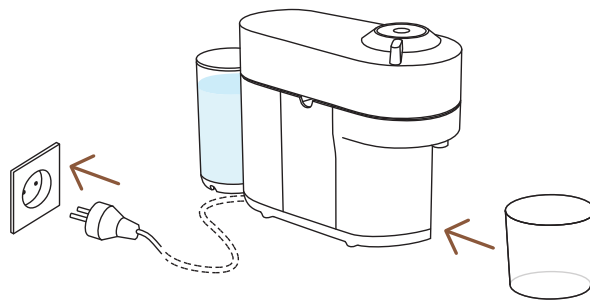

- 3** Asigurați-vă că espressoorul este conectat la o sursă de alimentare, scoateți suportul pentru cești și așezați un recipient gol (de cel puțin 1 L / 34 fl oz) sub duza de cafea.

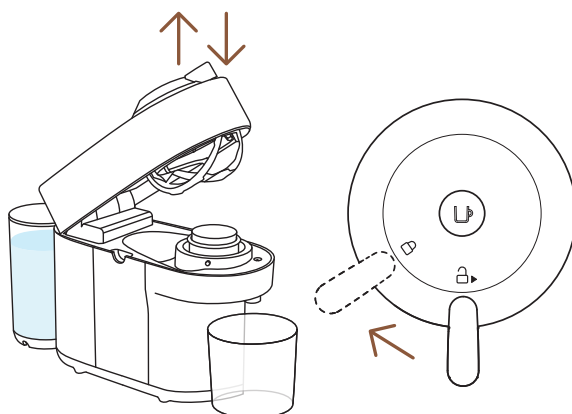

- 4** Deschideți și închideți aparatul. Asigurați-vă că mânerul este în poziția de blocare.

- i** Lumina va clipi în timp ce aparatul se încălzește. Aceasta va dura aproximativ 30 de secunde. Când lumina intermitentă devine continuă, aparatul este gata de utilizare. Asigurați-vă că nu este introdusă nicio capsulă.

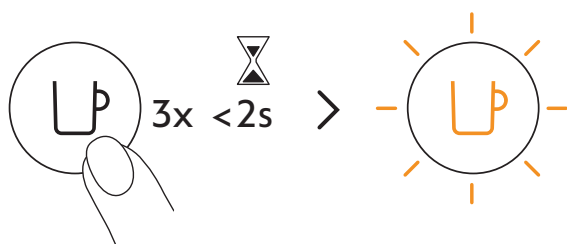

- 5** Apăsați butonul de 3 ori în decurs de 2 secunde pentru a începe clătirea. Cu lumina intermitentă portocalie, lăsați procedura de clătire să se încheie automat. Când lumina devine stabilă și albă, ciclul este complet.

- i** Ar trebui să dureze mai puțin de 2 minute până când începe procesul de clătire și începe să curgă apa. Această procedură poate dura până la 7 minute.

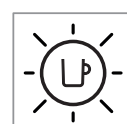
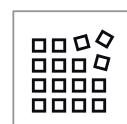
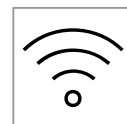

# PREGĂTIREA CAFELEI

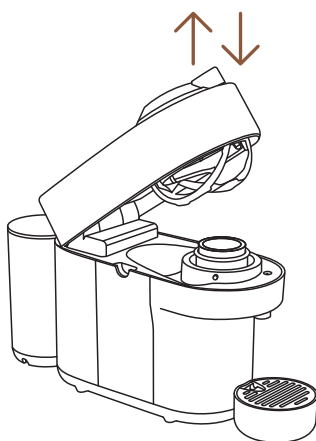

**1** Deschideți și închideți aparatul.

**i** Lumina butonului de cafea va clipi în timp ce aparatul se încălzește. Când lumina devine continuă, aparatul este gata de utilizare.

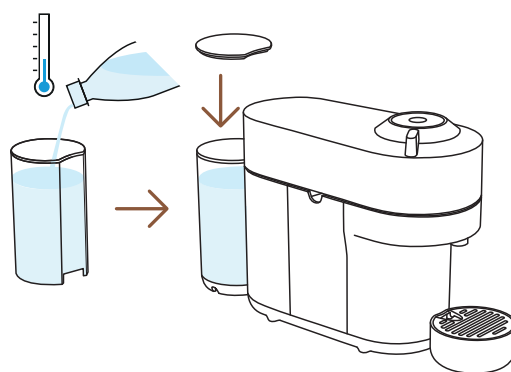

**2** Umpleți rezervorul de apă cu apă potabilă proaspătă și puneți-l înapoi în poziție.

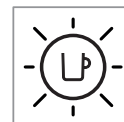
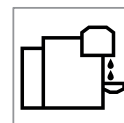
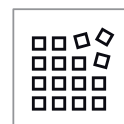
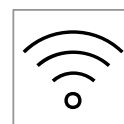

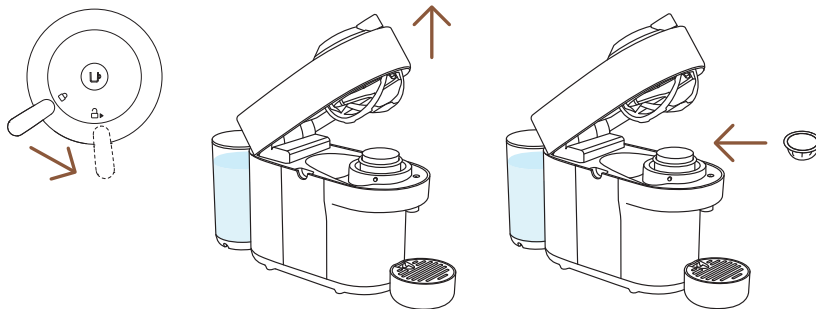

- 3** Deblocați și deschideți complet capul aparatului și introduceți o capsulă Vertuo, cu forma circulară orientată în jos.

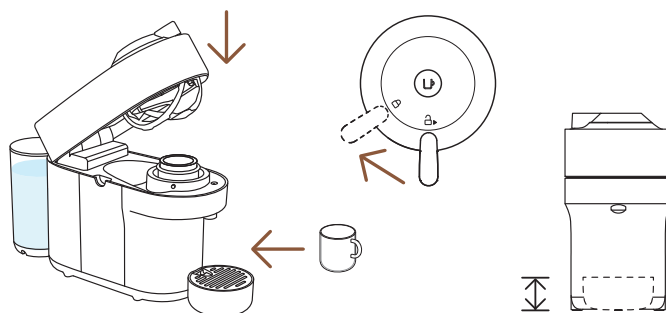

- 4** Închideți capul aparatului și blocați-l, rotind mânerul spre stânga până în dreptul simbolului de blocar, apoi așezați o ceașcă. Suportul pentru cești se poate ajuta pe înălțime, în funcție de dimensiunile ceștii dvs.

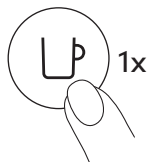

- 5** Începeți prepararea cafelei apăsând o dată pe buton.

**ATENȚIE:** pentru utilizarea corectă a espressorului, vă rugăm să nu deschideți capul de extracție al mașinii în timp ce se prepară cafeaua, așteptați până când lumina butonul de cafea devine albă. Dacă doriți să opriți procesul de extracție mai devreme, vă rugăm să apăsați o singură dată butonul de cafea și așteptați până când mașina se oprește înainte să deschideți capul de extracție.

- i** Datorită citirii codului de bare, preinfuzării cafelei și timpului de infuzare fluxul de cafea nu va începe să curgă imediat. Pentru a extrage amestecul de cafea la cel mai bun nivel, aparatul va recunoaște automat capsula introdusă și va selecta parametrii de preparare a cafelei, dar și dimensiunile ceștii, așa cum sunt definite de experții **Nespresso** în prepararea cafelei.

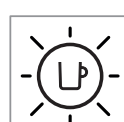
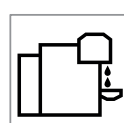
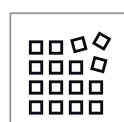
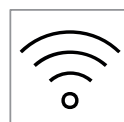

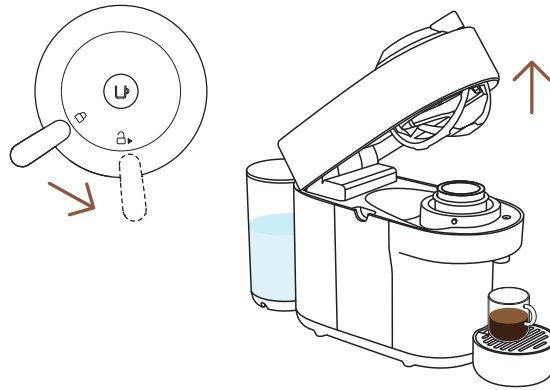

- 6** Când cafeaua este gata, deschideți capul aparatului prin rotirea manetei spre dreapta, spre poziția de deblocare, pentru a ejecta automat capsula și a vă bucura de cafea.



- 7** Nu uitați să reciclați capsulele dvs. **Nespresso** utilizate.\*

\* CAPSULELE DE CAFEA **NESPRESSO**. SUNT RECICLABILE.

Pentru mai multe informații despre reciclarea capsulelor **Nespresso**, vizitați [www.nespresso.com](http://www.nespresso.com)

## DESCOPERIȚI MODURILE NOASTRE DE PREPARARE A CAFELEI



Acest espresso **Nespresso** dispune de o funcție specifică de grupare a concentrației din extracțiile de cafea pentru a vă crea propriile rețete.

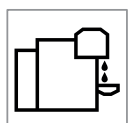

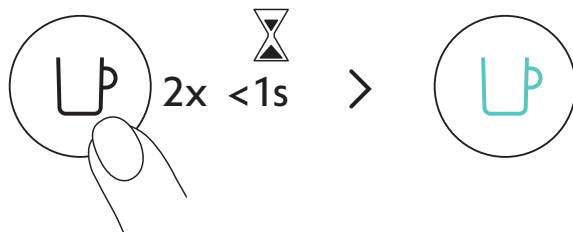

Când aparatul este pornit, faceți dublu clic pe butonul de cafea. Va lumina intermitent în culoarea turcoaz, iar preparatul de cafea va fi mai concentrat, pentru un gust mai intens și optimizat al cafelei, special pentru rețetele cu ingrediente suplimentare (lapte, cremă de cafea, gheață...). Pentru o experiență de cafea de neegalat.

40 ml	80 ml	150 ml	230 ml	355 ml	535 ml
✓	✓	✓	✓	✗	✗
25 ml	40 ml	40 ml	80 ml		

Pentru a vă bucura pe deplin de beneficii, vă recomandăm să preparați gama noastră Coffee+ folosind doar dimensiunile oficiale ale ceștilor. Pentru cele mai bune rezultate în ceașcă, nu vă recomandăm să preparați XL (Alto Ambrato, Alto Onice), Cold Brew Style & Carafe Pour Over Style cu acest mod.

**NOTĂ:** Poate fi necesară o actualizare a aparatului dumneavoastră prin intermediul aplicației **Nespresso** pentru a activa acest mod.



Descoperiți cum să faceți un upgrade al aparatului dvs. cu ajutorul gamei Aeroccino pe [www.nespresso.com](http://www.nespresso.com)

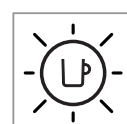
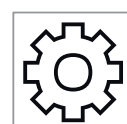
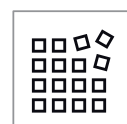
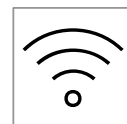



## AJUSTAȚI CANTITATEA DE APĂ ȘI CAFEA

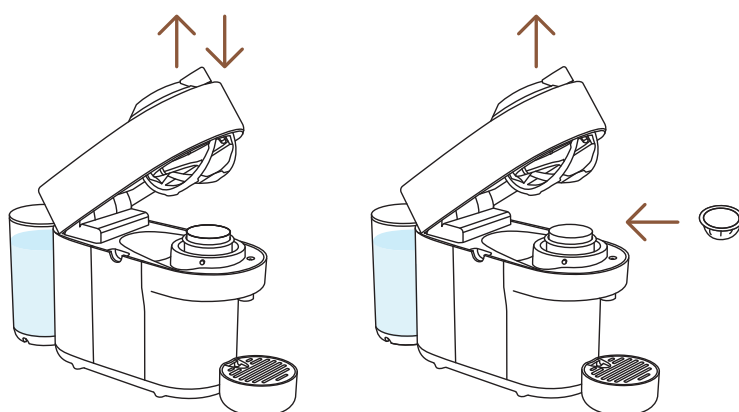

- 1** Deschideți și închideți aparatul. Cu aparatul pornit, deschideți aparatul și introduceți capsula pe care doriți să o programați.

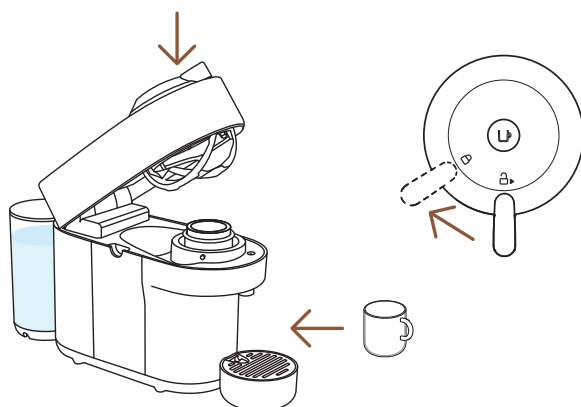

- 2** Închideți capul espressorului, rotiți mânerul spre stânga, spre poziția de blocare și așezați o ceașcă sub duză.

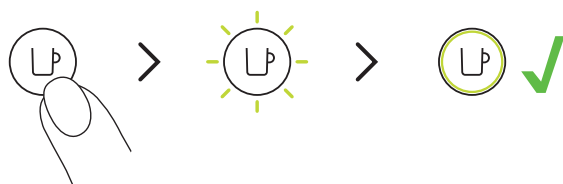

- 3** Apăsați și țineți apăsat butonul până se ajunge la cantitatea dorită. Noua cantitate de apă pentru acest tip de capsulă este acum pre-programat și înregistrat cu aceste setări.

- i** Programarea este specifică fiecărui tip de capsulă. Dimensiunile ceștii pot fi programate de la 20 ml până la 535 ml.

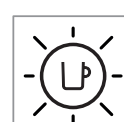
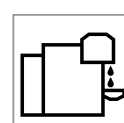
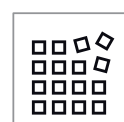
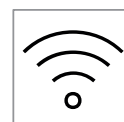

**ATENȚIE:** pentru utilizarea corectă a espressorului, vă rugăm să nu deschideți capul de extracție al mașinii în timp ce se prepară cafeaua, așteptați până când lumina butonul de cafea devine albă. Dacă doriți să opriți procesul de extracție mai devreme, vă rugăm să apăsați o singură dată butonul de cafea și așteptați până când mașina se oprește înainte să deschideți capul de extracție.

**NOTĂ:** Odată ce utilizatorul înregistrează o cantitate specifică, personalizată în funcție de preferințele de consum, de fiecare dată când acel tip de capsulă este introdus în espressor, preparatul va fi realizat conform dimensiunilor pre-programate. Dacă doriți să reveniți la parametrii din fabrică, consultați paragraful **„Revenire la setările din fabrică”**.

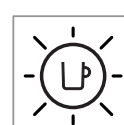
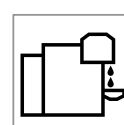
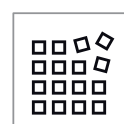
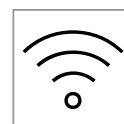

## CURĂȚARE

Curățați epsressorul lunar, atunci când încep să apară reziduuri de cafea la interiorul capului sau după o perioadă lungă de inutilizare.

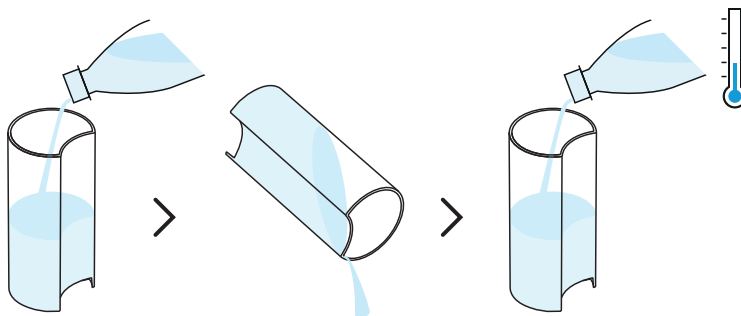

- 1** Clătiți și curățați rezervorul de apă și capacul înainte de a-l umple cu apă potabilă proaspătă.

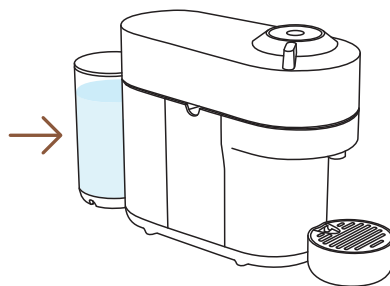

- 2** Fixați rezervorul de apă înapoi pe aparat.

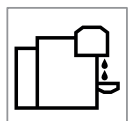
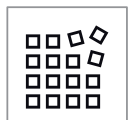

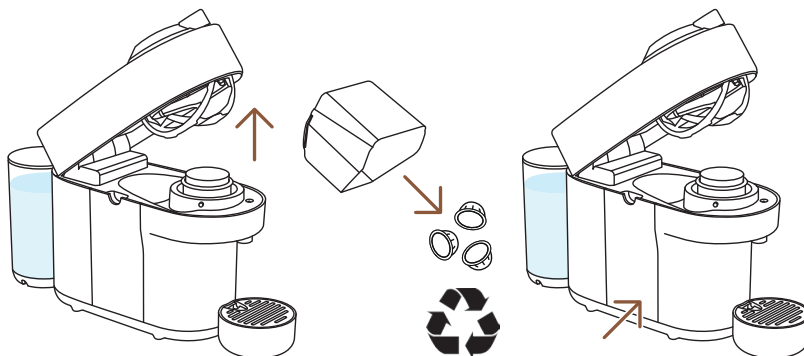

- 3** Cu aparatul pornit, deblocați și deschideți aparatul și lăsați capsula utilizată să fie scoasă. Goliți tăvița de picurare și recipientul pentru capsule și puneți-le la loc. Nu uitați să reciclați capsulele dvs. **Nespresso** utilizate.\*

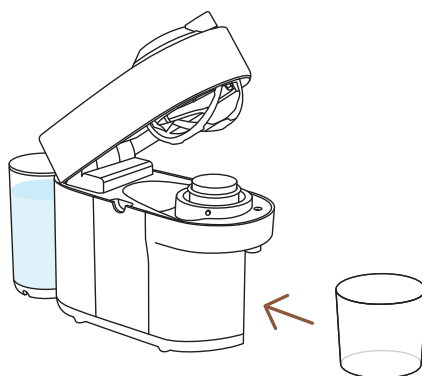

- 4** Îndepărtați suportul pentru cești și așezați un recipient gol (de cel puțin 1 L / 34 fl oz) sub duza de cafea.

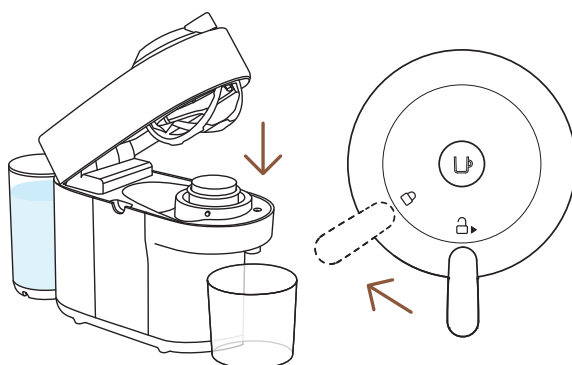

- 5** Închideți capul aparatului și rotiți mânerul spre stânga, în poziția de blocare. Asigurați-vă că nicio capsulă nu este introdusă în espresso înainte începerii procesului de curățare.

\* CAPSULELE DE CAFEĂ **NESPRESSO**. SUNT RECICLABILE.  
Pentru mai multe informații despre reciclarea capsulelor **Nespresso**, vizitați [www.nespresso.com](http://www.nespresso.com)

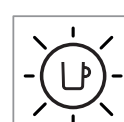
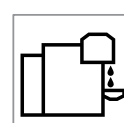
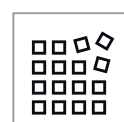
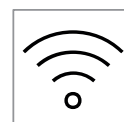

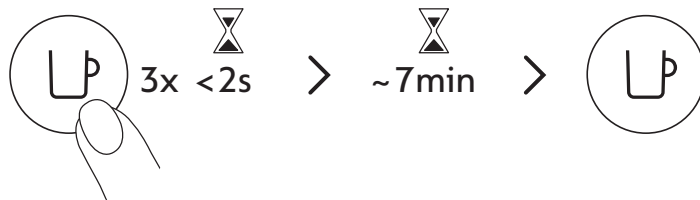

- 6** Apăsați butonul de 3 ori în decurs de 2 secunde pentru a începe clătirea. Lăsați procedura de curățare să se finalizeze automat.
- i** Ar trebui să dureze mai puțin de 2 minute înainte de începerea procesului de curățare și ca apa să înceapă să curgă. Această operațiune poate dura până la 7 minute și se va opri automat la încheierea ciclului de curățare. Procedura poate fi oprită oricând prin apăsarea butonului.

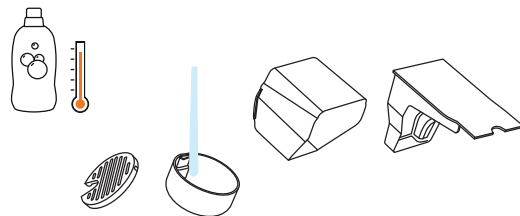

- 7** Spălați recipientul pentru capsule, suportul pentru pahare și tava de picurare cu apă caldă și cu un detergent cu acțiune de curățare blândă, inodor.

**ATENȚIE:** Nu folosiți niciun agent de curățare puternic sau abraziv sau solvenți de curățare. Nu introduceți aparatul în mașina de spălat vase. Nu scufundați niciodată aparatul sau o parte a acestuia în apă.

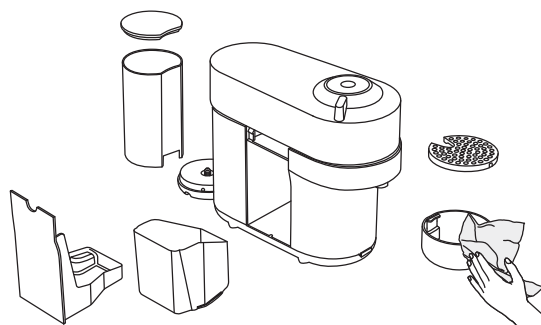

- 8** Curățați cu un prosop curat și nou

**ATENȚIE:** Curățați duza de cafea regulat, cu o lavetă curată și umezită. Utilizați întotdeauna cârpe moi pentru a curăța aparatul.

**NOTĂ:** Se poate acumula apă în capătul aparatului, vă rugăm să curățați părțile vizibile cu o cârpă curată și uscată.

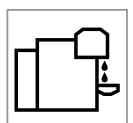

## DECALCIFIERE

Decalcifierea aparatului dvs. va asigura funcționarea corectă a acestuia pe toată durata ciclului său de viață și va face ca experiența dvs. de cafea să fie la fel de plăcută ca în prima zi. Aparatul dvs. vă va indica atunci când este necesară decalcifierea, cu o lumină portocalie care pâlpâie de 3 ori înainte de a deveni albă, continuă.



**i** Procedura de detartrare durează ~20 minute și nu **poate fi întreruptă**.

**NOTĂ:** Vă rugăm să citiți cu atenție instrucțiunile de decalcifiere înainte de a începe.

### Veți avea nevoie de:

- Un kit de decalcifiere disponibil pe [www.nespresso.com](http://www.nespresso.com)
- Un recipient gol (de 1 L / 34 fl oz)

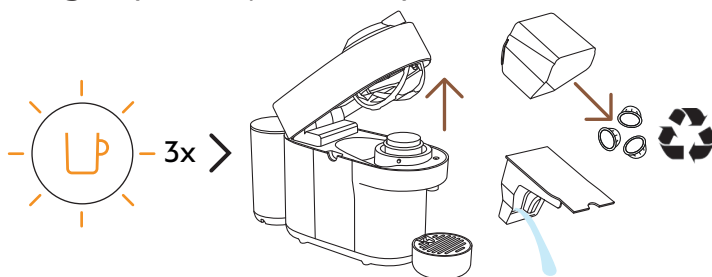

- 1** Când butonul luminează de 3 ori și este de culoare portocalie: Deblocați și deschideți capul aparatului și permiteți scoaterea capsulei. Goliți recipientul pentru capsule și tava de picurare și așezați-le la loc în aparat. Nu uitați să reciclați capsulele dvs. **Nespresso** utilizate.\*

\* CAPSULELE DE CAFEA **NESPRESSO**. SUNT RECICLABILE.  
Pentru mai multe informații despre reciclarea capsulelor **Nespresso**, vizitați [www.nespresso.com](http://www.nespresso.com)

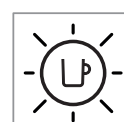
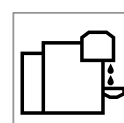
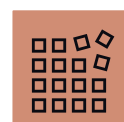
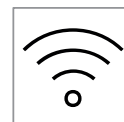

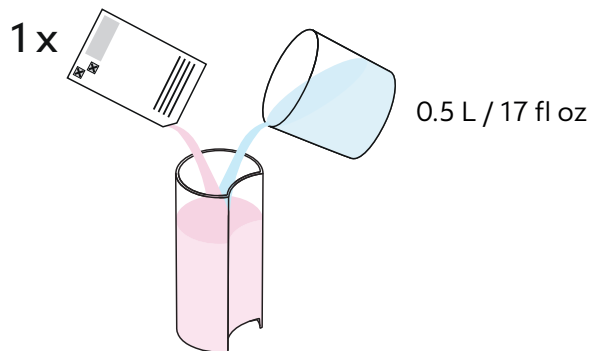

- 2** Umpleți rezervorul de apă cu 0,5 L de apă și adăugați 1 unitate din lichidul pentru decalcifiere **Nespresso**.

**ATENȚIE:** Vă rugăm să rețineți că soluția de decalcifiere poate fi dăunătoare. Evitați contactul cu ochii, pielea și suprafețele.

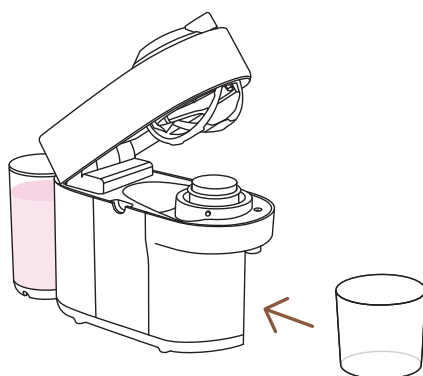

- 3** Îndepărtați suportul pentru cești și așezați un recipient gol (de cel puțin 1 L) sub duza de cafea.

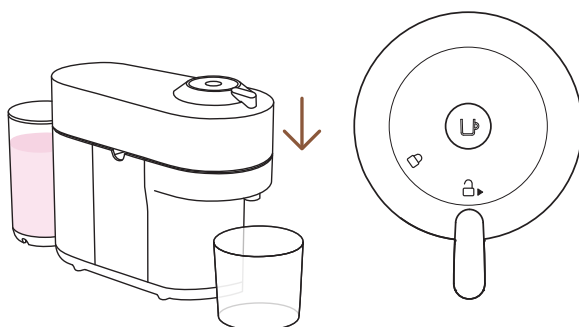

- 4** Cât timp este pornit, închideți capul aparatului și lăsați mânerul în poziția de deblocare.

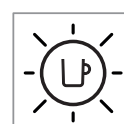
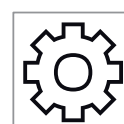
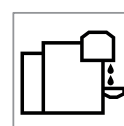
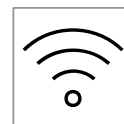

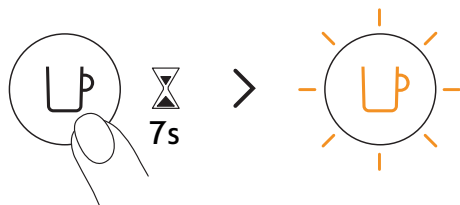

- 5** Țineți apăsat butonul timp de cel puțin 7 secunde sau până când vedeți că lumina se stinge. Butonul va avea o lumina portocalie intermitentă.

**ATENȚIE:** Aveți la dispoziție 45 de secunde pentru a intra în modul de decalcifiere, altfel aparatul va reveni la modul pentru prepararea cafelei.

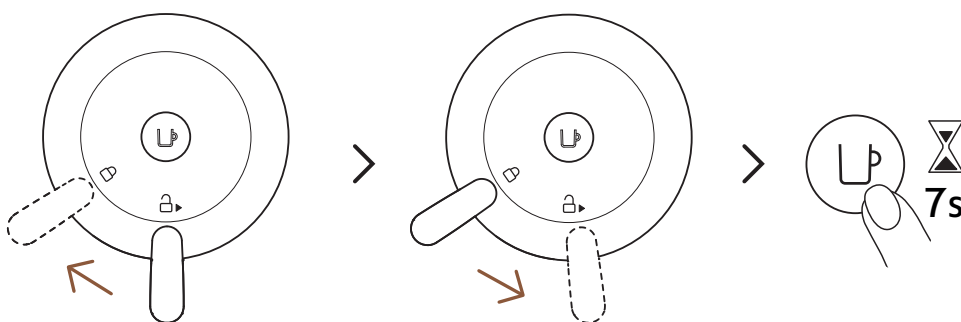

- 6** Blocați aparatul rotind mânerul spre stânga, la simbolul de blocare, și deblocați rotind spre dreapta. Țineți apăsat din nou butonul timp de aproximativ 7 secunde sau până când lumina se stinge. Butonul va avea o lumina portocalie intermitentă.

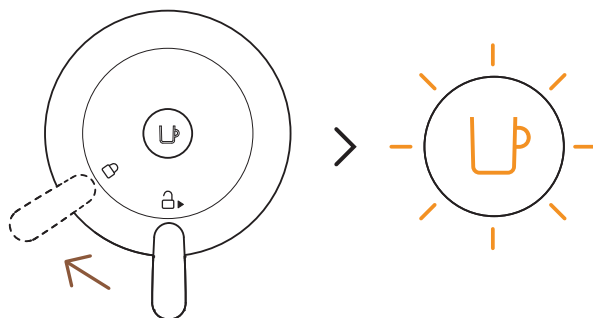

- 7** Pentru a intra în modul de decalcifiere, blocați aparatul prin rotirea manetei spre stânga. Lumina portocalie ar trebui să lumineze intermitent. Acest lucru indică faptul că ați accesat modul de decalcifiere.

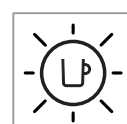
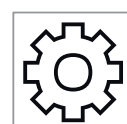
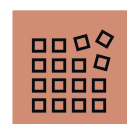
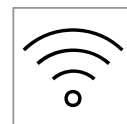



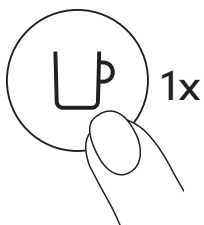

- 8** Apăsați butonul pentru cafea o dată pentru a începe procesul de detartrare. Lumina va clipi continuu portocaliu pe tot parcursul procesului.

- i** Aparatul se va opri automat atunci când se încheie prima fază de decalcifiere.

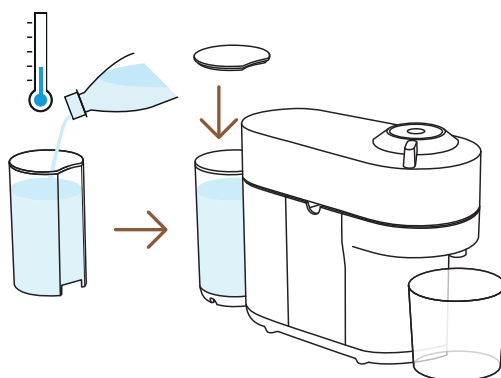

- 9** La sfârșitul procesului de decalcifiere, este timpul să clățiți aparatul. Clățiți bine rezervorul de apă și tava de picurare. Umpleți rezervorul de apă cu apă potabilă proaspătă și puneți-l la loc. Goliți recipientul și așezați-l din nou sub duza de cafea.

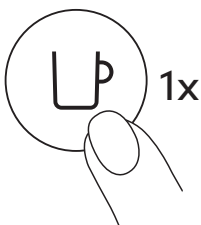

- 10** Apăsați butonul pentru a clăți aparatul. Atunci când butonul nu mai clipește rapid și devine fix, procedura de decalcifiere este finalizată.

- i** Aparatul se va opri automat la finalizarea procedurii.

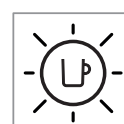
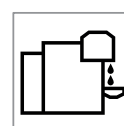
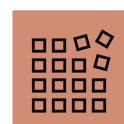
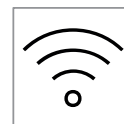

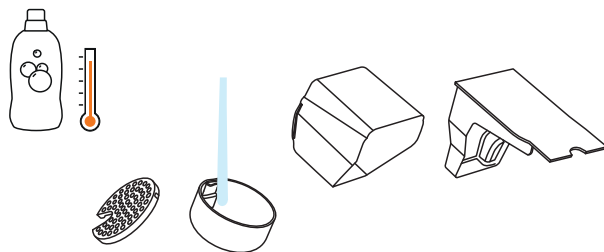

- 11** Spălați recipientul pentru capsule, suportul pentru pahare și tava de picurare cu apă caldă și cu un detergent cu acțiune de curățare blândă, inodor.

**ATENȚIE:** Nu folosiți niciun agent de curățare puternic sau abraziv sau solvenți de curățare. Nu introduceți aparatul în mașina de spălat vase. Nu scufundați niciodată aparatul sau o parte a acestuia în apă.

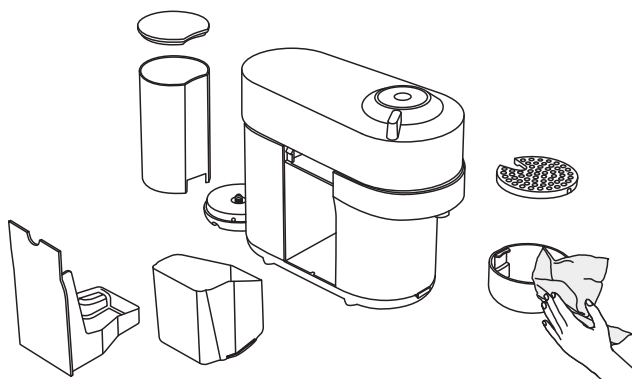

- 12** Curățați cu un prosop curat și nou. Lăsați aparatul să se usuce timp de 10 minute înainte de a-l utiliza.

**NOTĂ:** Apa se poate acumula în interiorul capului aparatului în timpul curățării. Dacă se întâmplă acest lucru, vă rugăm să uscați părțile vizibile cu o cârpă curată și uscată.

**NOTĂ:** Espressorul poate intra în modul de decalcifiere numai după prepararea a 30 sau mai multe cafele.

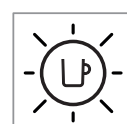
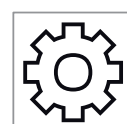
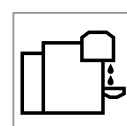
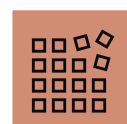
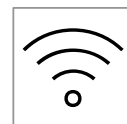

## GOLIREA SISTEMULUI

Golirea sistemului este un proces care ar putea fi efectuat înainte de o perioadă de neutilizare, pentru a proteja aparatul împotriva înghețului sau înainte de a-l trimite la reparat.

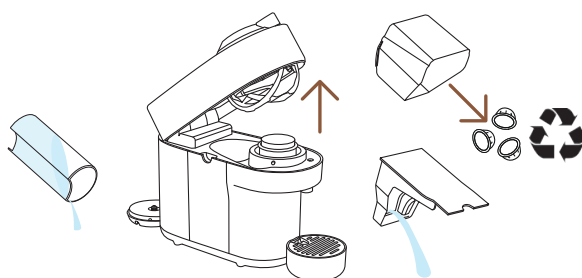

- 1** Goliți rezervorul de apă, deschideți capul aparatului și permiteți ejectarea capsulei. Goliți recipientul pentru capsule și tava de picurare. Nu uitați să reciclați capsulele dvs. **Nespresso** utilizate.\*

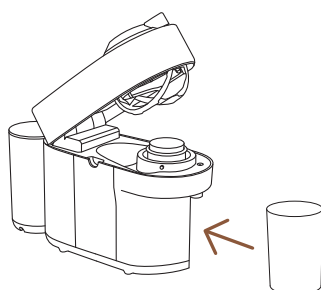

- 2** Așezați-le înapoi în aparat, scoateți suportul pentru cești și plasați un recipient gol (0,5 L) sub duza de cafea.

\* CAPSULELE DE CAFEĂ **NESPRESSO**. SUNT RECICLABILE.

Pentru mai multe informații despre reciclarea capsulelor **Nespresso**, vizitați [www.nespresso.com](http://www.nespresso.com)

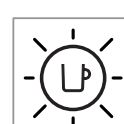
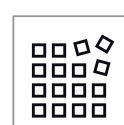
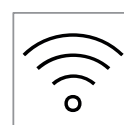

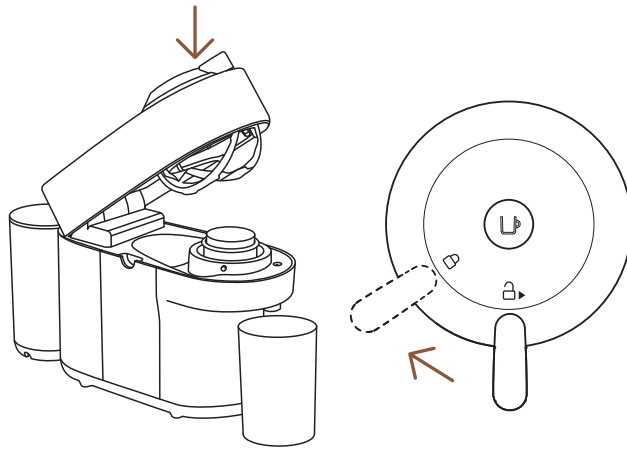

- 3** Cu mașina conectată și pornită, rotiți mânerul spre poziția de blocare.

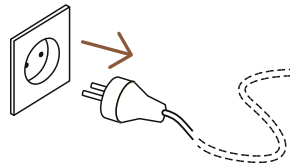

- 4** Scoateți aparatul din priză

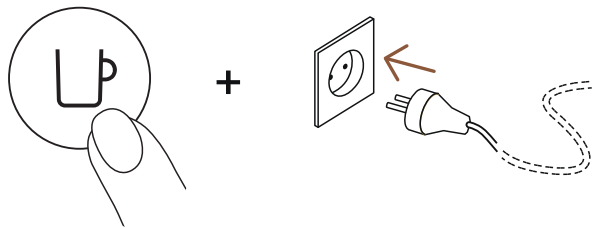

- 5** Apăsați și țineți apăsat butonul când aparatul este în priză



- 6** Eliberați butonul. Acesta va clipi în portocaliu și va începe procesul de golire.

- i** Va dura aproximativ 30 de secunde pentru ca aparatul să finalizeze procesul de golire. Aparatul se oprește automat atunci când este golit.



## REVENIREA LA SETĂRILE DIN FABRICĂ

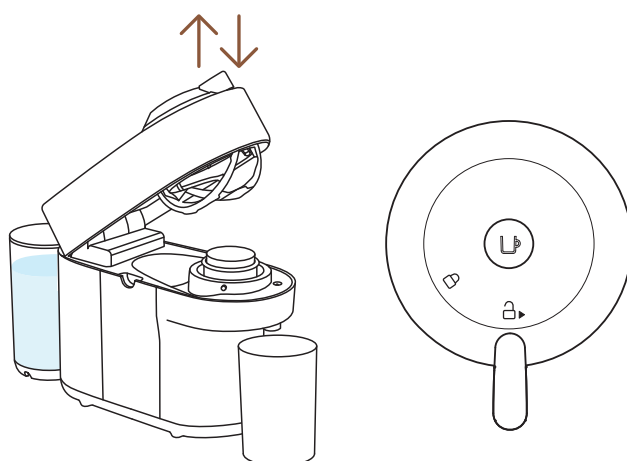

- 1 Cu aparatul conectat la priză, deschideți și apoi închideți capul aparatului înainte de a **debloca** mânerul.

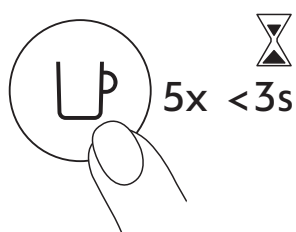

- 2 Apăsați butonul de 5 ori în 3 secunde. Aparatul este acum programat cu setările din fabrică.

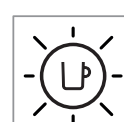
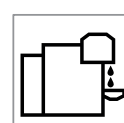
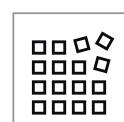
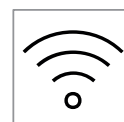

## PREZENTAREA ALERTELOR

Doriți să știți mai multe despre luminile intermitente produse de aparatul Vertuo Pop? Vă rugăm să urmăriți următorul video:



## DEPANARE

- Butonul nu este luminat**
- Aparatul s-a OPRIT automat; apăsați butonul sau „DEBLOCAȚI” aparatul.
  - Verificați rețeaua de alimentare cu electricitate, priza, tensiunea și siguranța.
- Fără cafea, fără apă.**
- Verificați dacă rezervorul de apă este umplut.
  - Verificați dacă este introdusă o capsulă nouă în poziția corectă și că mânerul este închis corect și apăsați butonul pentru a porni.
  - Decalcificați dacă este necesar.
  - Deschideți capătul aparatului și ejectați capsula. Apoi curățați conform secțiunii de curățare.
- Cafeaua nu este suficient de fierbinte.**
- Pre-încălziți ceașca cu apă fierbinte de băut de la robinet.
  - Decalcificați dacă este necesar.
- Scurgere sau flux de cafea neobișnuit.**
- Verificați dacă rezervorul de apă este bine poziționat.
  - Decalcificați dacă este necesar.
- Aparatul intră în „modul OPRIRE”.**
- Pentru a economisi energie, aparatul se va închide după 2 minute de neutilizare.
  - Aparatul se poate închide manual oricând (atunci când nu este în funcțiune) prin menținerea apăsării butonului timp de 3 secunde.
- Zaț de cafea în ceașcă.**
- Realizați procedura de curățare de două ori.
  - Consultați paragraful privind **„Curățare”**
- Aparatul nu pornește și are o lumină stabilă. Dacă clipește, consultați punctele următoare.**
- Verificați dacă mânerul este bine închis.
  - Dacă doriți să preparați o cafea sau un espresso, verificați dacă este introdusă o capsulă nouă în poziția corectă, dacă mânerul este închis corect și apăsați butonul pentru a porni.
  - Dacă curățați, decalcificați sau goliți sistemul, verificați că nu este introdusă nicio capsulă apoi închideți, blocați aparatul și apăsați butonul pentru a începe una dintre aceste operațiuni.

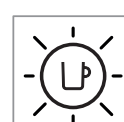
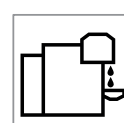
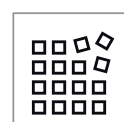
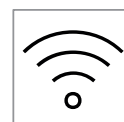

**Aparatul nu pornește și lumina clipește alternativ; 1 clipire și 1 pauză.**

**Lumina este intermitentă în timp ce espressorul prepară cafeaua.**

**Aparatul nu pornește și lumina clipește alternativ; 1 clipire și 1 pauză.**

- Umpleți rezervorul de apă și apăsați butonul pentru a începe.
- Verificați dacă mânerul este bine închis.

- Dacă cafeaua curge normal, aceasta indică faptul că aparatul funcționează corespunzător
- Dacă curge doar apă, aparatul face o solicitare utilizatorului fie pentru curățare, decalcifiere sau golirea sistemului. Consultați capitolul corespunzător.
- Puneți aparatul în „modul de OPRIRE” apăsând butonul timp de 3 secunde și apoi apăsați-l din nou pentru a PORNI aparatul. Acum așteptați aproximativ 2 minute pentru a permite aparatului să se răcească după utilizarea prelungită.

- Va dura ceva timp până când începe să curgă cafeaua (din cauza citirii codului de bare și pre-udării cafelei).
- Verificați dacă este introdusă o capsulă nouă în poziția corectă și că mânerul este închis corect și apăsați butonul pentru a porni.
- Umpleți rezervorul de apă și apăsați butonul pentru a începe.
- Puneți aparatul în „modul de OPRIRE” apăsând butonul timp de 3 secunde și apoi apăsați-l din nou pentru a PORNI aparatul. Acum așteptați aproximativ 2 minute pentru a permite aparatului să se răcească după utilizarea prelungită.

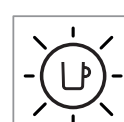
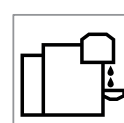
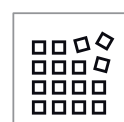
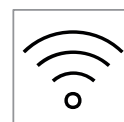



**Lumina clipește  
alternativ 2 clipiri și  
1 pauză în continuu.  
Aparatul nu  
funcționează.**

- În timpul preparării de cafea/espresso obișnuit:
  - 1) Deblocați mânerul și deschideți capătul aparatului pentru a verifica dacă o capsulă nouă întreagă este introdusă în poziția corectă.
  - 2) Verificați dacă mânerul este în poziția „BLOCAT”.
  - 3) Verificați dacă rezervorul de apă este umplut.
- În timpul decalcifierii, golirii și curățării:
  - 1) Verificați dacă capsula este eliminată
  - 2) Verificați dacă mânerul este în poziția „BLOCAT”.
- În timpul Programării volumului:
  - 1) Verificați dacă capsula a fost bine introdusă corespunzător.
  - 2) Consultați capitolul corespunzător.
- Pokud problém přetrvává:
  - 1) Deblocați mânerul și deschideți capul mașinii.
  - 2) Înlocuiți capsula (dacă este cazul).
  - 3) Deconectați cablul de alimentare din priză și băgați aparatul în priză din nou după 10 secunde.
  - 4) Închideți capătul și apăsați butonul pentru a PORNI și apăsați din nou pentru a începe prepararea.

Dacă problema persistă, contactați **Nespresso**.

**Lumini ce clipesc  
alternativ de 3 ori și  
apoi se fixează.**

- Este nevoie de decalcifiere: aparatul poate fi folosit când apare alerta doar de câteva ori după alertă înainte ca decalcifierea să devină necesară

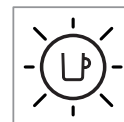
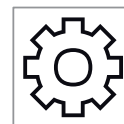
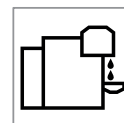
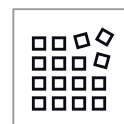
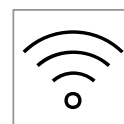

## SPECIFICAȚII

<b>Putere</b>	<b>~220-240 V, 50-60 Hz, 1300-1500 W</b> <b>US, CA:</b> 120 V, 60 Hz, 1500 W <b>MX:</b> 127 V~, 60 Hz, 1380 W
<b>Frecvență</b>	2.402-2.480 GHz
<b>RF Putere ieșire (EIRP)</b>	Bluetooth 4 dBm max. e.i.r.p. și Wi-Fi <20 dMm max. e.i.r.p.
<b>Standby (așteptare)</b>	0.39 W/h
<b>Mod de economisire a energiei</b>	Oprire auto: 2 min
<b>Timp de încălzire</b>	30 de secunde (capul închis și blocat)
<b>Suport pentru cești mobil pentru rețete de dimensiuni mai mari</b>	Poziție unică detașabilă
<b>Lungimea cablului</b>	75 cm / 30 in
<b>Dimensiuni (L x A x Î)</b>	13.6 x 42.6 x 25 cm / 5.3 x 16.7 x 9.8 in
<b>Greutate</b>	3.5 kg / 7.72 lbs
<b>Capacitatea rezervorului de apă</b>	0.6 l / 20 fl oz
<b>Capacitatea recipientului pentru capsule utilizate</b>	8 capsule pentru espresso sau 5 capsule pentru cană tip „Mug”

## CODURI ESPRESSOARE

Nespresso	Breville	Delonghi
GCV2, GDV2	BNV120, BNV150	ENV90
Krups	Magimix	
XN9201, XN9204, XN9205, XN9211	M800	

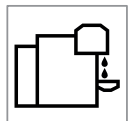
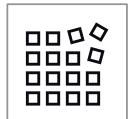

# TIKLAYIN VE DİLİNİZİ SEÇİNİZ

TR



**GÜVENLİK**



**GENEL BAKIŞ**



**BAĞLANTI**



**İLK ADIMLAR**



**KAHVE HAZIRLAMA**



**KAHVE HACMİNİZİ AYARLAYIN**



**TEMİZLEME**



**KİREÇ ÇÖZME**



**SİSTEMİN BOŞALTILMASI**



**FABRİKA AYARLARINA SIFIRLA**



**SİNYAL ÖZETİ**



**SORUN GİDERME**



**ÖZELLİKLER**

## GÜVENLİK

**DİKKAT:** Kahve makinenizi çalıştırmadan önce, olası zarar ve hasarları önlemek için lütfen güvenlik talimatları kitapçığına bakınız.

### İMHA VE ÇEVRE KORUMA

Bu cihaz 2012/19/EC sayılı AB Direktifine uygundur. Ambalaj malzemeleri ve makine, geri dönüştürülebilir materyaller ve makineniz, iyileştirilebilir veya geri dönüştürülebilir değerli malzemeler içermektedir. Kalan atık malzemelerin farklı türlere ayrılması, değerli ham maddelerin geri dönüşümünü kolaylaştırmaktadır. Cihazı bir toplama noktasında bırakın. İmha etme konusunda yerel yetkililerden bilgi alabilirsiniz.

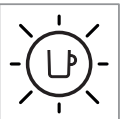
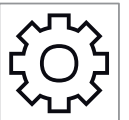
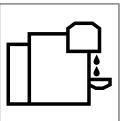
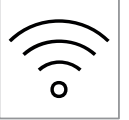

## GENEL BAKIŞ

### MAKİNEYE GENEL BAKIŞ

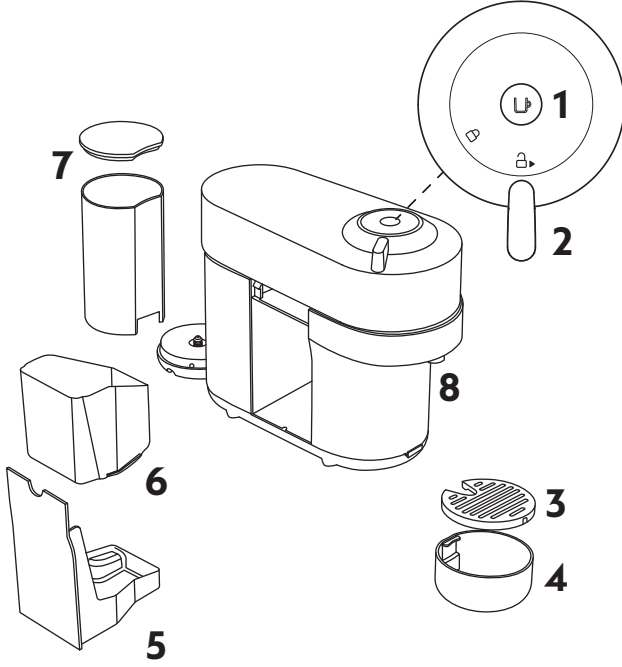

- 1 AÇ/KAPA ve kahve düğmesi
- 2 Kitleme/Kilit açma kolu
- 3 Damlama ızgarası
- 4 Ayarlanabilir fincan desteği
- 5 Damlama tepsi
- 6 Kullanılmış kapsül haznesi
- 7 Su haznesi ve kapak
- 8 Kahve çıkışı

### AMBALAJ İÇERİĞİ



- 1 Kahve makinesi
- 2 Nespresso kapsül seti
- 3 Nespresso ile tanışın kitapçığı
- 4 Güvenlik talimatları
- 5 Hızlı başlangıç rehberi
- 6 Garanti

4 + 5 + 6

**i Kutudan çıkarma:** Ambalajda kullanılan geri dönüştürülmüş malzemeler nedeniyle makinenin yüzeyinde bir miktar toz bulunabilir. Bu tehlikeli bir durum değildir. Makineye zarar gelmemesi için yumuşak bir bezle tozu temizleyiniz. Makineyi ambalajından çıkarırken plastik filmleri çıkarınız.

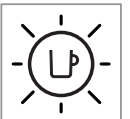
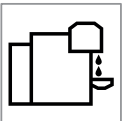
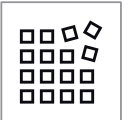
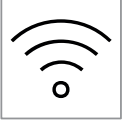



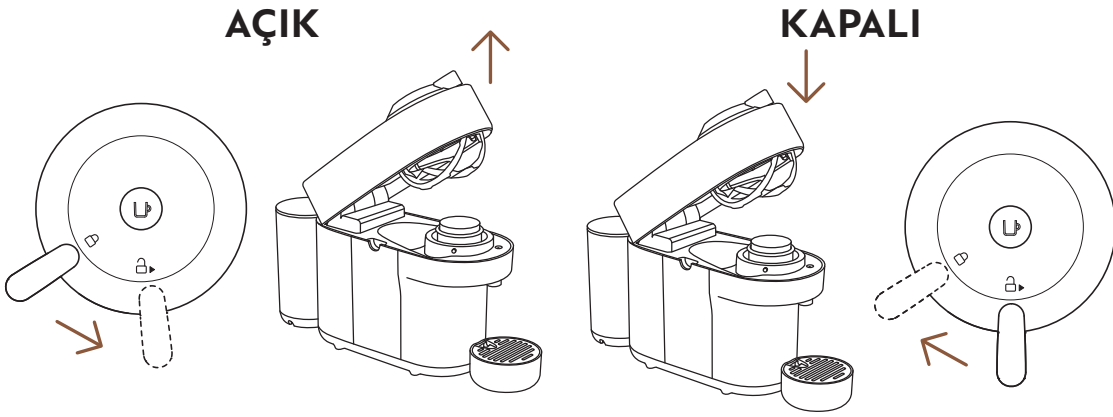

## AÇIK/KAPALI



**DİKKAT:** Makinenin doğru kullanımı için lütfen kahve demlenirken makine kafasını açmayınız, kahve düğmesi sabit beyaza dönene kadar bekleyiniz. Demlemeyi daha erken durdurmak isterseniz, lütfen kahve düğmesine bir kez basın ve makine kafasını açmadan önce makinenin durmasını bekleyiniz.

## VERTUO SİSTEMİ

## KAPSÜL UYUMLULUĞU

			
<b>S</b>	<b>M</b>	<b>L</b>	<b>XL</b>
<b>Ristretto</b>	<b>Double Espresso</b>	<b>Mug</b>	<b>Alto, Cold Brew Style</b>
(25 ml / 0.84 fl oz)	(80 ml / 2.7 fl oz)	(230 ml / 7.77 fl oz)	(355 ml / 12 fl oz)
<b>Espresso</b>	<b>Gran Lungo</b>		<b>Carafe</b>
(40 ml / 1.35 fl oz)	(150 ml / 5.07 fl oz)		(535 ml / 18.8 fl oz)

## AKSESUAR UYUMLULUĞU

							
Aksesuar uyumluluğu	<b>Ristretto</b>	<b>Espresso</b>	<b>Double Espresso</b>	<b>Gran Lungo</b>	<b>Mug (S)</b>	<b>Mug (M)</b>	<b>Reveal Glass</b>

		
Uygun olmayan aksesuarlar	<b>Mug (L)</b>	<b>Carafe</b>

Aksesuar koleksiyonunu [www.nespresso.com](http://www.nespresso.com) adresinden keşfedin

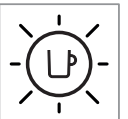
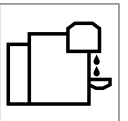
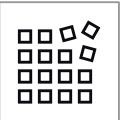
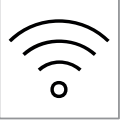

## AÇ / KAPA

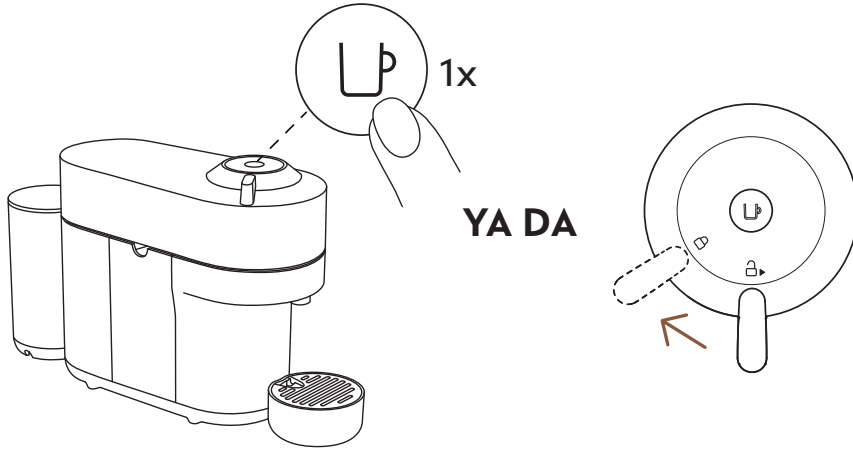
**AÇ**

Makinenin fişi prize takıldıktan sonra, düğmeye bir kez basarak veya kolu kilitli konumda (ürünün üst kısmı kapalı şekilde) kapatarak açınız.

- i** Makine ısınırken ışık yaklaşık 30 saniye boyunca yanıp sönecektir. Işık sabit olduğunda, makineyi kullanmaya başlayabilirsiniz.

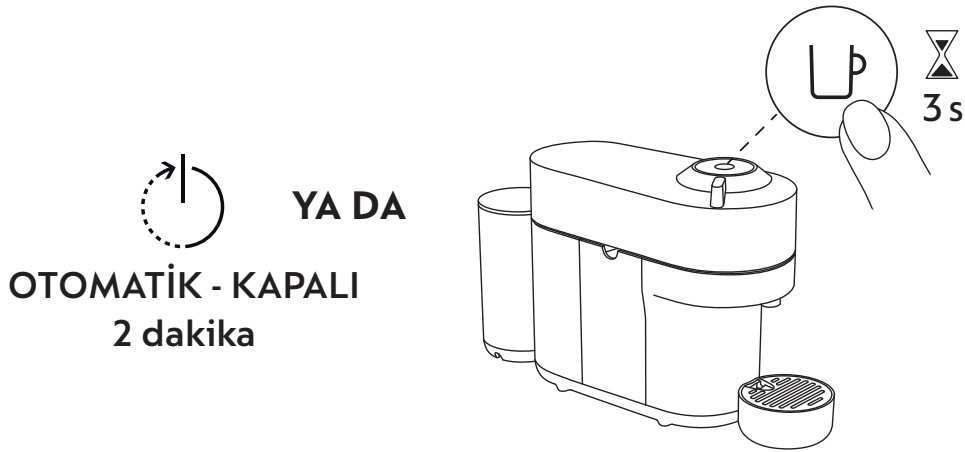

**OTOMATİK - KAPALI**  
2 dakika

**KAPALI**

Enerji tasarrufu için, makine 2 dakika kullanılmadığında otomatik olarak kapanacaktır.

- i** Makine istenildiği zaman (kullanılmadığında) düğmeye 3 saniye basılı tutularak manuel olarak "KAPALI" konuma getirilebilir.

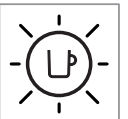
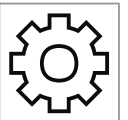
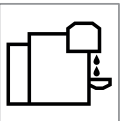
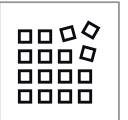
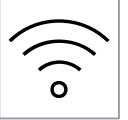

## BAĞLANTI

### NEDEN VERTUO POP MAKİNESİNİZİ EŞLEŞTİRMELİSİNİZ?



### VERTUO POP MAKİNESİNİZİ BAĞLAMANNIN FAYDALARI

- **Akıllı Kahve:** Nespresso'nun kahve yenilikleriyle ilgili en son haberleri alarak, her zaman bir adım önde olun
- **Uzman Tavsiyesi:** Akıllı telefonlarınız ile, kahve yolculuğunuza eşlik edecek destek ve basit eğitim videoları izleyin
- **Makine Bakımı:** Kireç çözme, durulama, temizleme vb. konularda kolay adımlı kılavuzla makinenize nasıl ve ne zaman bakım yapacağınıza dair anında bildirim alın.

### VERTUO POP MAKİNESİNİZİ NASIL BAĞLAYABİLİRSİNİZ?

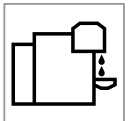



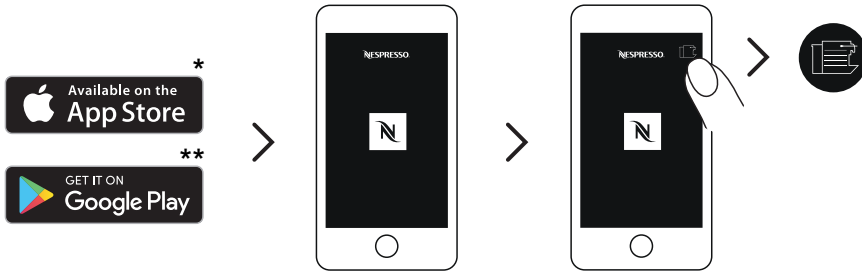

- 1 Nespresso** Uygulamasını indirin veya güncelleyiniz. Akıllı telefonunuzda veya tabletinizde **Nespresso** Uygulamasını açınız. Ekranınızın sağ üst kısmındaki makine simgesine basınız.

**NOT:** Optimum performans ve sorunsuz bir deneyim için, makinenizi bir akıllı telefon erişimi kullanmak için bir Wi-Fi'a bağlamanızı öneririz.

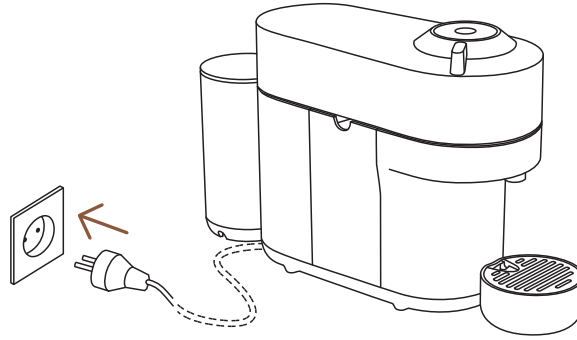

- 2 Güç kablosunu takınız.**



- 3 Nespresso** Uygulaması aracılığıyla talimatları izleyin.

**DİKKAT:** Ölümcül elektrik çarpması ve yangın risklerinden kaçınmak için önce güvenlik önlemlerini okuyunuz. Lütfen makineyi elektrik prizine takarken toprak sürekliliğini sağlayınız.

\* App Store® Apple Inc.'in ABD ve diğer ülkelerde tescilli ticari markasıdır.  
\*\* Google Play ve Google Play logosu, Google LLC'nin ticari markalarıdır.

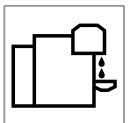
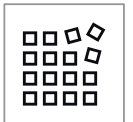

## MAKİNEİN BLUETOOTH VE WI-FI BAĞLANTISINI DEVRE DIŐI BIRAKMAK

Makine, varsayılan olarak etkinleştirilen bir bağlantı modülüyle birlikte gelir. Ek özelliklere erişim sağlayarak kahve deneyiminizi geliştirir. Bağlantı modülünü devre dışı bırakmak için şu adımları izleyin:

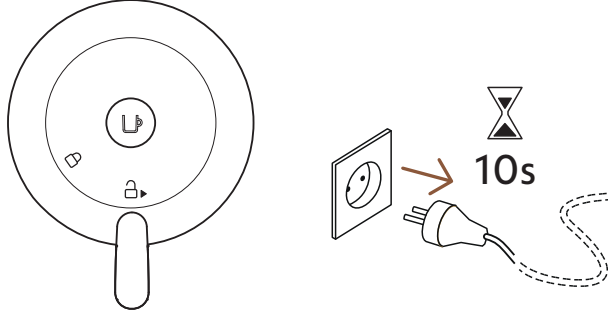

- 1** Makine kapalı ve kol açık konumdayken makinenin fişini en az 10 saniye prizden çekin.

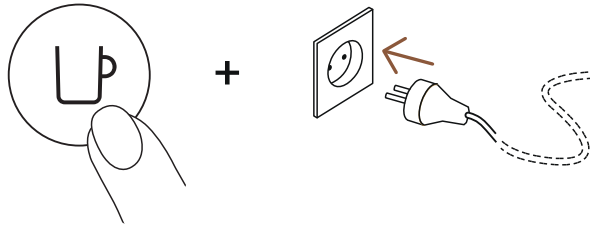

- 2** Makineyi fişe takarken düğmeyi basılı tutun. Düğme, bağlantı modülünün artık devre dışı bırakıldığını onaylamak için turuncu renkte yanıp sönecektir.

- i** Bağlantı modülünü tekrar açmak için aynı adımları izleyin. Düğme, modülün yeniden etkinleştirildiğini onaylamak için beyaz renkte yanıp sönecektir.

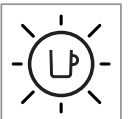
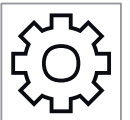
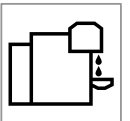
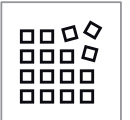

## İLK ADIMLAR

## İLK DURULAMA

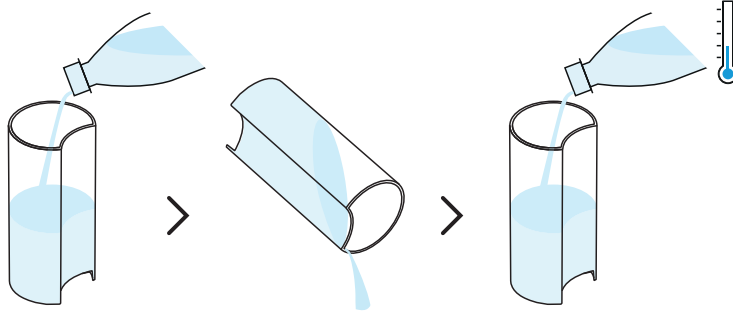

- 1** Taze içme suyuyla doldurmadan önce su haznesini ve kapağını durulayın ve temizleyiniz.

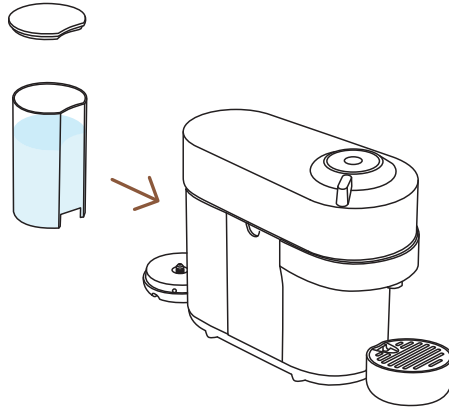

- 2** Su haznesini kapağı ile kapatın, yerine yerleştirin ve doğru takıldığından emin olunuz.

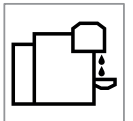
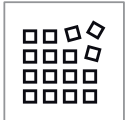
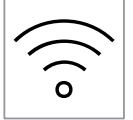

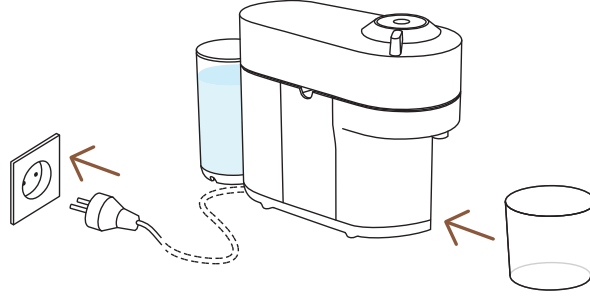

- 3** Makine fişe takılıyken, fincan desteğini çıkarın ve kahve çıkışının altına boş bir kap (en az 1 L / 34 fl oz) yerleştiriniz.

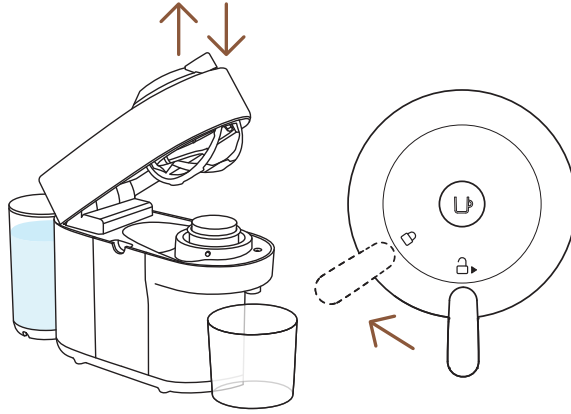

- 4** Makineyi açıp kapatınız. Kolun kilitli konumda olduğundan emin olunuz.

- i** Makine ısınırken ışık yanıp sönecektir. Yaklaşık 30 saniye sürecektir. Işık sabit hale geldiğinde makine hazırdır. Kapsülün takılı olmadığından emin olunuz.

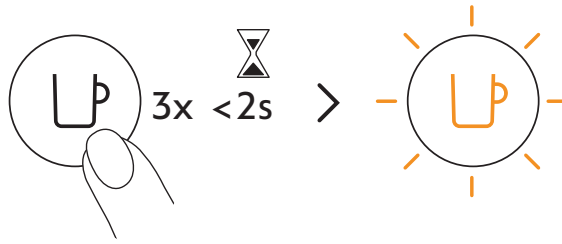

- 5** Durulamayı başlatmak için düğmeye 2 saniye içinde 3 kez basınız. Turuncu yanıp sönen ışıkla, durulama prosedürünün otomatik olarak tamamlanmasına izin veriniz. Işık sabit beyaz olduğunda, döngü tamamlanmıştır.

- i** Durulama işleminin başlaması ve suyun akmaya başlaması 2 dakikadan az sürecektir. Bu prosedür 7 dakika kadar sürebilir.

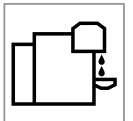
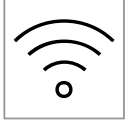

## KAHVE HAZIRLAMA

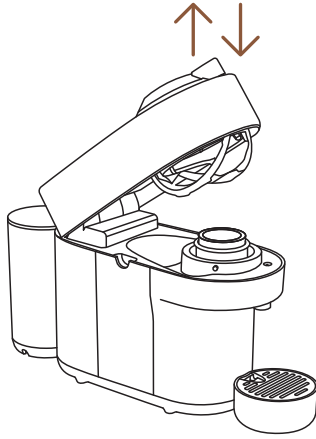

**1** Makineyi açıp kapatınız.

**i** Makine ısınırken kahve düğmesi ışığı yanıp sönecektir. Işık sabit hale geldiğinde, makine kullanıma hazırdır.

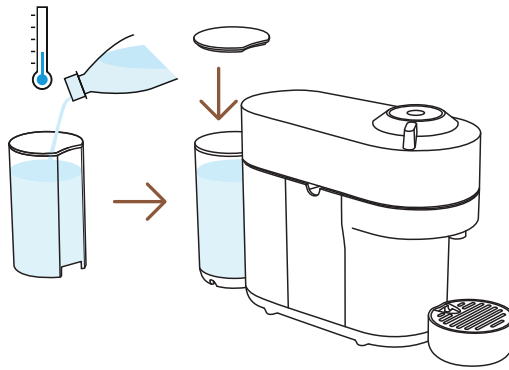

**2** Su haznesini temiz içme suyuyla doldurun ve yerine geri koyunuz.

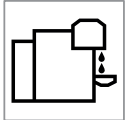
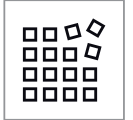

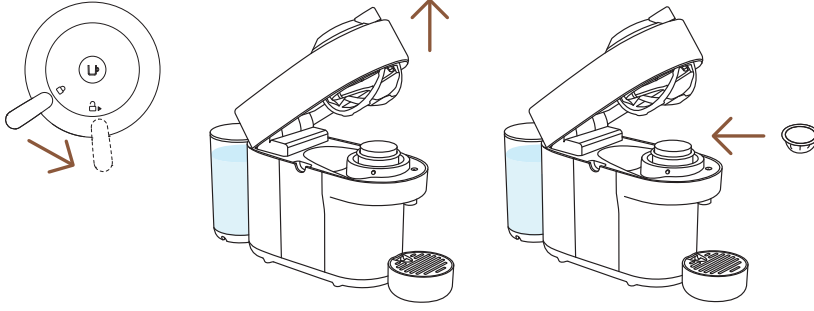

- 3** Makine kafasının kilidini açın ve kapsülün yuvarlak kısmı aşağı bakacak şekilde bir Vertuo kapsülü yerleştiriniz.

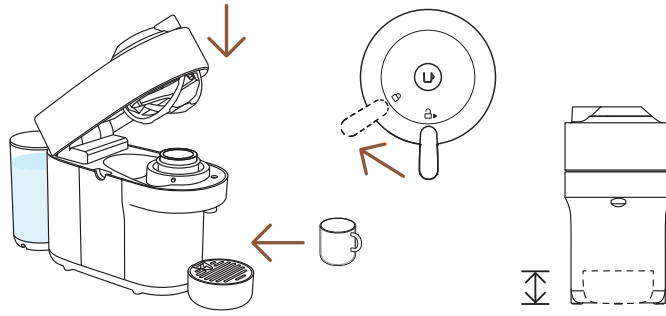

- 4** Makine kafasını kapatınız, kolu kilitli konuma gelene kadar sola çevirerek kilitleyin ve bir fincan yerleştiriniz. Kup desteği, kup boyutunuza uyacak şekilde ayarlanabilir.

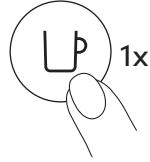

- 5** Düğmeye bir kez basarak demlemeye başlayınız.

**DİKKAT:** Makinenin doğru kullanımı için lütfen kahve demlenirken makine kafasını açmayınız, kahve düğmesi sabit beyaza dönene kadar bekleyiniz. Demlemeyi daha erken durdurmak isterseniz, lütfen kahve düğmesine bir kez basın ve makine kafasını açmadan önce makinenin durmasını bekleyiniz.

- i** Kod okuma, kahve ön ıslatma ve demleme süresi nedeniyle kahvenin akmaya başlaması biraz zaman alacaktır. Makine, yerleştirilen kapsülü otomatik olarak tanıyacak ve kahveyi en iyi şekilde demlemek için **Nespresso** kahve uzmanları tarafından tanımlanan kahve hazırlama parametrelerini ve fincan uzunluğunu seçecektir.



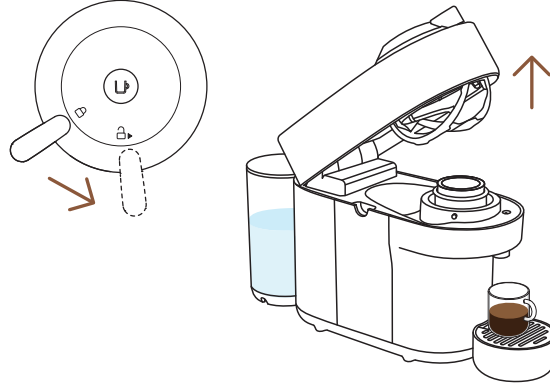

- 6** Kahvenin demlenmesi durduğunda, kapsülü otomatik olarak çıkarmak ve kahvenizin tadını çıkarmak için kolu sağa çevirerek makine kafasını açınız.



- 7 Nespresso** kapsüllerinizi geri dönüştürmeyi unutmayınız.\*

\* THIS IS **NESPRESSO**. THIS IS RECYCLABLE. **Nespresso** kapsüllerinin geri dönüşümü ile ilgili daha fazla bilgi edinmek için, [www.nespresso.com](http://www.nespresso.com)'u ziyaret edin

## KAHVE KREASYONLARI MODUMUZU KEŞFEDİN



Bu makine ile **Nespresso**, kendi tariflerinizi oluşturmak için kahve ekstraksiyonlarınızı yoğunlaştırmanız için size özel bir işlem sunar.

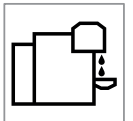

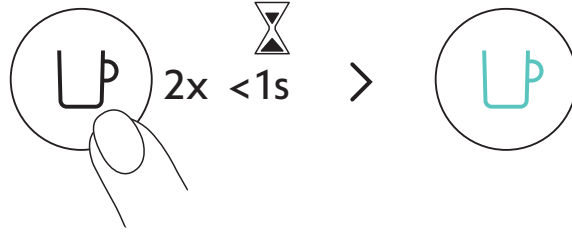

Makineniz açıkken kahve düğmesine çift tıklayın. Turkuaz renkte yanıp sönecek ve kahve demlemeniz konsantre olacak, ilaveli tariflerde (süt, krema, buz üstü...) kahve tadını arttıracaktır. Eşsiz Kahve Deneyimi İçin...

40 ml / 1.35 fl oz	80 ml / 2.7 fl oz	150 ml / 5.07 fl oz	230 ml / 7.77 fl oz	355 ml / 12 fl oz	535 ml / 18.8 fl oz
✓	✓	✓	✓	✗	✗
25 ml / 0.85 fl oz	40 ml / 1.35 fl oz	40 ml / 1.35 fl oz	80 ml / 2.7 fl oz		

**Nespresso** kahve deneyiminizi arttırmak için Coffee+ serimizi yalnızca önerilen fincan ölçülerini kullanarak demlemenizi öneririz. En iyi fincan sonuçlar için, XL (Alto Ambrato, Alto Onice), Cold Brew Style ve Carefe Pour Over Style modları ile demlemenizi öneririz.

**NOT:** Bu modu etkinleştirmek için **Nespresso** Uygulaması aracılığıyla makinenizin güncellenmesi gerekebilir.



Aeroccino serimiz ile kahve deneyimimizi arttırmak için [www.nespresso.com](http://www.nespresso.com) adresinden ürünlerimizi keşfedin.

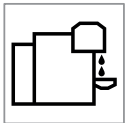



# KAHVE ÖLÇÜLERİNİZİ UYARLAYIN

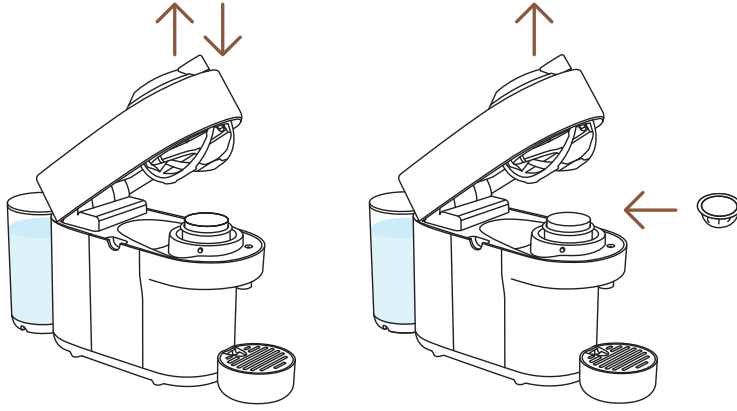

- 1** Makineyi açıp kapatınız. Makine açıkken kapağını açın ve programlamak istediğiniz kapsülü yerleştiriniz.

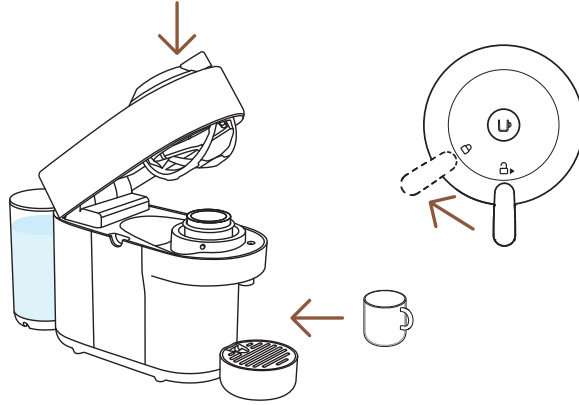

- 2** Makinenin üst kısmını kapatınız, kolu sola doğru kilitli konuma çeviriniz ve bir fincan yerleştiriniz.

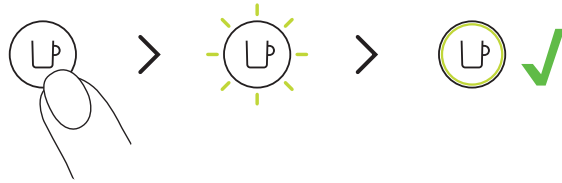

- 3** İstenen ses seviyesine ulaşılan kadar düğmeyi birkaç saniye bırakarak düğmeyi basılı tutunuz. Yeni su hacmi artık ayar sırasında kullanılan kapsül tipi için programlanmıştır.

- i** Programlama, her bir kapsül tipine özeldir. Bardak boyutları 20 ml / 0,7 fl oz ile 535 ml / 18 fl oz arasında programlanabilir.

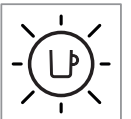
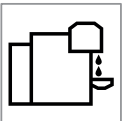
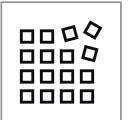
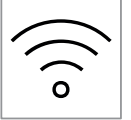

**DİKKAT:** Makinenin doğru kullanımı için lütfen kahve demlenirken makine kafasını açmayınız, kahve düğmesi sabit beyaza dönene kadar bekleyiniz. Demlemeyi daha erken durdurmak isterseniz, lütfen kahve düğmesine bir kez basın ve makine kafasını açmadan önce makinenin durmasını bekleyiniz.

**NOT:** Kullanıcı tarafından müşteriye özel bir ölçü programlandıktan sonra, bu kapsül türü makineye her takıldığında, hazırlama işlemi kullanıcı tarafından programlanan kap boyutunda duracaktır. Varsayılan parametrelere geri dönmek isterseniz "Fabrika ayarlarına sıfırla" kısmına bakınız.

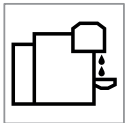

## TEMİZLEME

Ayda bir, makinenin üst kısmında kahve kalıntısı kalmaya başladığında veya uzun süre kullanılmadığında makinenizi temizleyiniz.

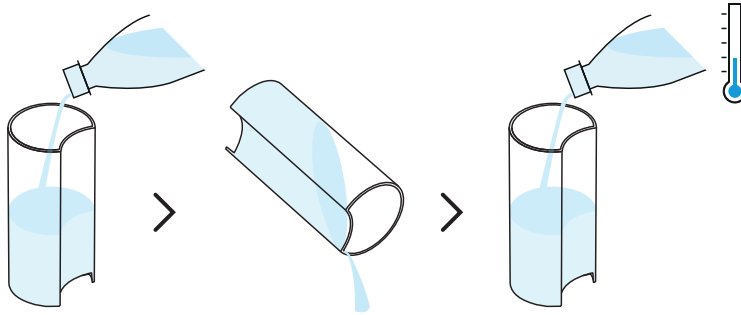

- 1** Taze içme suyuyla doldurmadan önce su haznesini ve kapağı durulayın ve temizleyiniz.

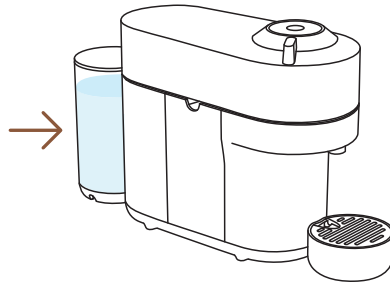

- 2** Su haznesini makine üzerindeki yerine geri koyunuz.

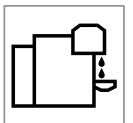
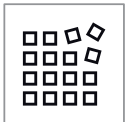

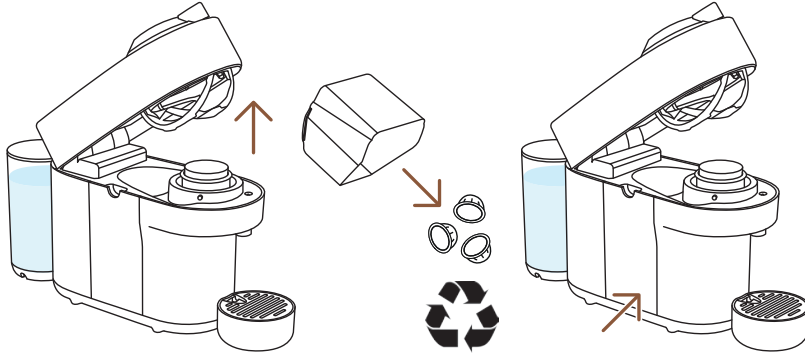

- 3** Makine açıkken, makinenin kilidini açıp açın ve kullanılmış kapsülün dışarı atılmasına izin veriniz. Kapsül kabını ve damlama tepsisini boşaltın, durulayın ve tekrar yerine koyunuz. **Nespresso** kapsüllerinizi geri dönüştürmeyi unutmayınız.\*

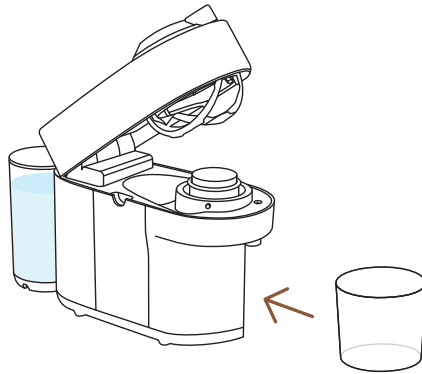

- 4** Fincan desteğini çıkarın ve kahve çıkışının altına boş bir kap (en az 1 L / 34 fl oz) yerleştiriniz.

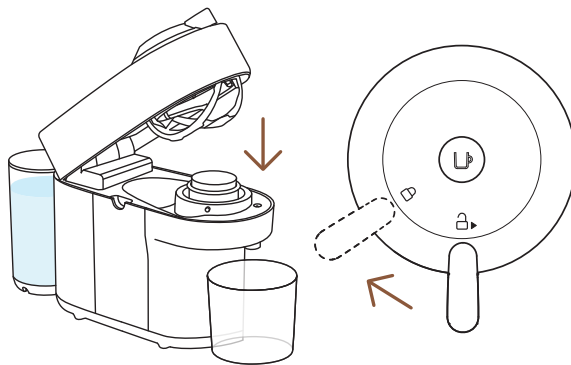

- 5** Makinenin üst kısmını kapatın ve kolu sola, kilitli konuma çeviriniz. Durulama işlemine başlamadan önce makinede kapsül bulunmadığından emin olunuz.

\* THIS IS **NESPRESSO**. THIS IS RECYCLABLE. **Nespresso** kapsüllerinin geri dönüşümü ile ilgili daha fazla bilgi edinmek için, [www.nespresso.com](http://www.nespresso.com)'u ziyaret edin

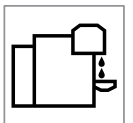
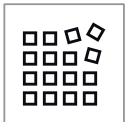

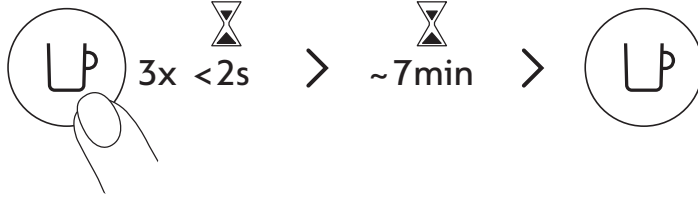

**6** Durulamayı başlatmak için düğmeye 2 saniye içinde 3 kez basınız. Turuncu yanıp sönen ışıkla, durulama prosedürünün otomatik olarak tamamlanmasına izin veriniz.

**i** Durulama işleminin başlaması ve suyun akmaya başlaması 2 dakikadan az sürmelidir. Bu işlem 7 dakika kadar sürebilir ve döngü tamamlandığında otomatik olarak duracaktır. Prosedür, düğmeye basılarak herhangi bir zamanda durdurulabilir.

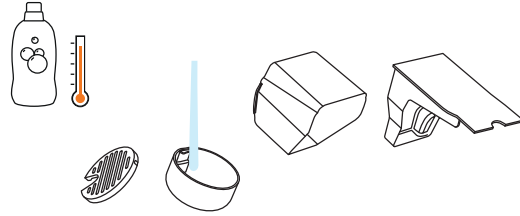

**7** Kapsül kabını, bardak desteğini ve damlama tepsisini sıcak su ve hafif kokusuz deterjanla yıkayınız.

**DİKKAT:** Herhangi bir güçlü veya aşındırıcı temizlik maddesi veya çözücü temizleyici kullanmayınız. Makineyi bulaşık makinesine koymayınız. Cihazı veya bir parçasını asla suya batırmayınız.

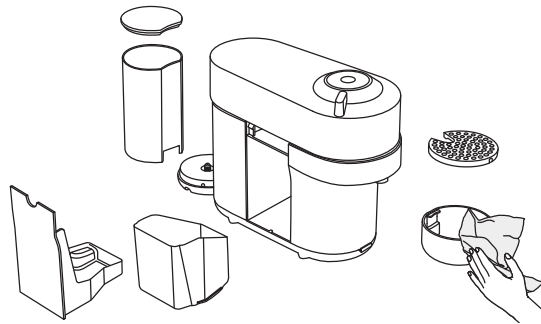

**8** Makineyi temiz bir havluyla kurulayınız.

**DİKKAT:** Kahve çıkışı temiz nemli bir bezle düzenli olarak temizleyiniz. Makineyi temizlemek için daima yumuşak bezler kullanınız.

**NOT:** Temizlik sırasında makinenin kafasında su birikebilir. Bu olursa, lütfen görünen kısımları temiz ve kuru bir bezle kurulayınız.



## KİREÇ ÇÖZME

Makinenizi kireçten arındırmak, kullanım ömrü boyunca düzgün çalışmasını sağlayacak ve kahve deneyiminizi ilk günkü gibi eşsiz kılacaktır. Makineniz, sürekli beyaz renkte yanıp sönmeden önce 3 kez turuncu renkte yanıp sönerken kireç çözmenin gerekli olduğunu belirtecektir.



**i** Kireç çözme prosedürü ~20 dakika sürer ve yarıda kesilemez.

**NOT:** Lütfen başlamadan önce kireç çözme talimatlarını dikkatlice okuyunuz.

### İhtiyacınız olabilecek bilgiler:

- [www.nespresso.com](http://www.nespresso.com) adresinden kireç çözme kitini keşfedebilirsiniz
- Boş bir kap (1 L / 34 fl oz)

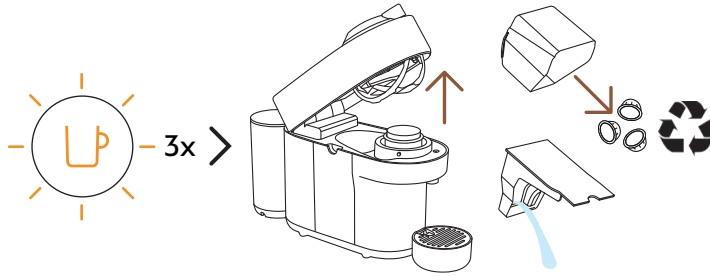

- 1** Düğme 3 kez turuncu renkte yanıp sönerken: Makine kafasının kilidini açın ve açın ve kullanılmış kapsülün dışarı atılmasına izin veriniz. Kapsül kabını ve damlama tepsisini boşaltın ve makinedeki yerine yerleştiriniz. **Nespresso** kapsüllerinizi geri dönüştürmeyi unutmayınız.\*

\* THIS IS **NESPRESSO**. THIS IS RECYCLABLE. **Nespresso** kapsüllerinin geri dönüşümü ile ilgili daha fazla bilgi edinmek için, [www.nespresso.com](http://www.nespresso.com)'u ziyaret edin

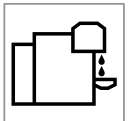

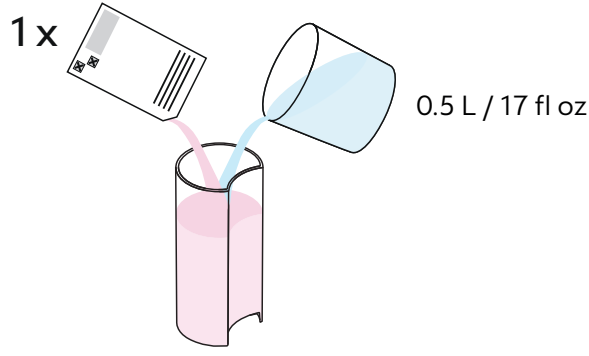

- 2** Su haznesini 0,5 L / 17 fl oz suyla doldurun ve 1 birim **Nespresso** kireç çözücü sıvı ekleyin.

**DİKKAT:** Lütfen kireç çözüme solüsyonunun zararlı olabileceğini unutmayın. Göz, cilt ve yüzeylerle temasından kaçınınız.

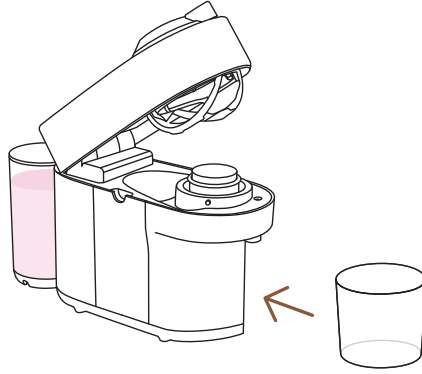

- 3** Fincan desteğini çıkarın ve kahve çıkışının altına boş bir kap (en az 1 L / fl 34 oz) yerleştirin.

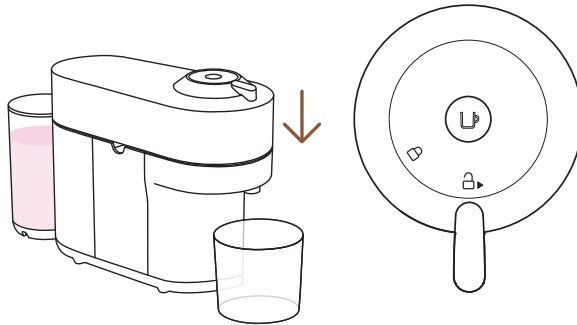

- 4** Makine açıkken, makinenin kafa kısmını kapatın ve kolu açık konumda bırakın.

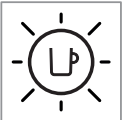
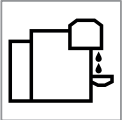
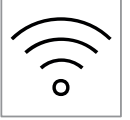

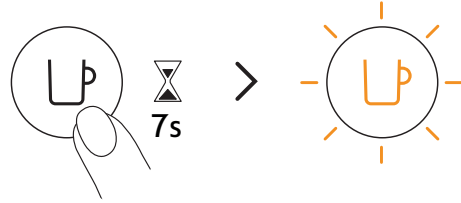

- 5** Düğmeyi en az 7 saniye veya ışığın kapandığını görene kadar basılı tutun. Düğme, hızla turuncu renkte yanıp sönmeye başlayacaktır.

**DİKKAT:** Artık kireç çözme moduna girmek için 45 saniyeniz var, aksi takdirde makine kahve hazırlama moduna geri dönecektir.

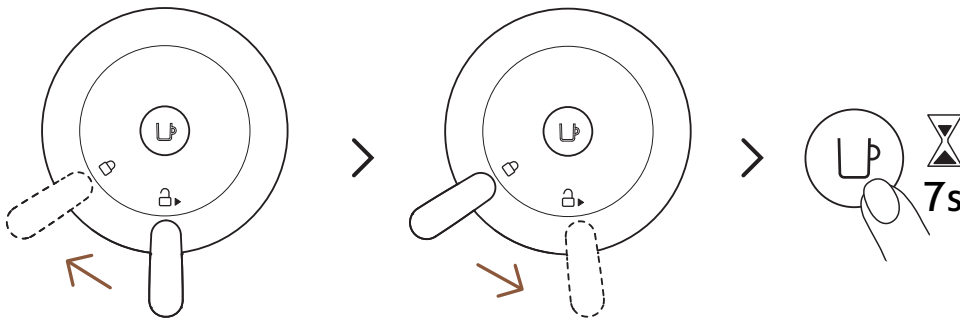

- 6** Kolu kilit sembolüne kadar sola çevirerek makine kafa kısmını kilitleyin ve ardından kolu sağa çevirerek kilit açma konumuna getirin. Yaklaşık 7 saniye veya ışık sönmeye kadar düğmeyi tekrar basılı tutun. Düğme hızla turuncu renkte yanıp sönmeye başlayacaktır.

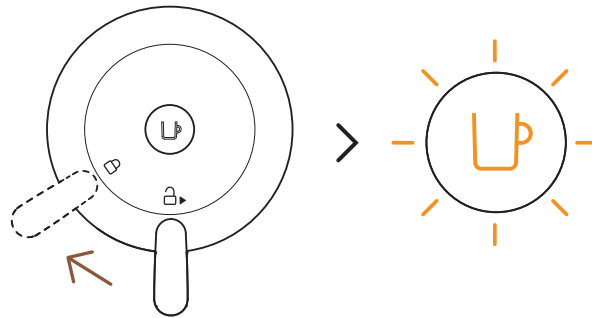

- 7** Kireç çözme moduna girmek için, kolu sola, kilitli konuma çevirerek makineyi kilitleyin. Işık hala hızlı bir şekilde turuncu renkte yanıp sönmeye devam etmelidir. Bu, kireç çözme moduna girdiğinizin bir göstergesidir.

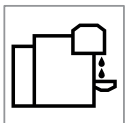



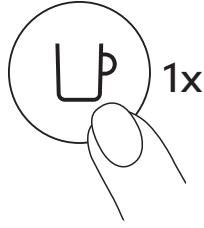

- 8** Kireç çözme işlemini başlatmak için kahve düğmesine bir kez basın. Işık, işlem boyunca sürekli olarak turuncu renkte yanıp sönecektir.

- i** Kireç temizlemenin ilk aşaması tamamlandığında makine otomatik olarak duracaktır.

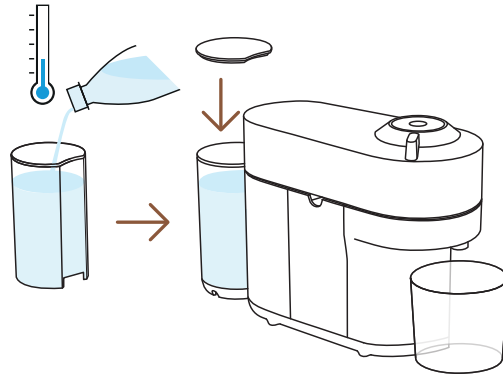

- 9** Kireç çözme işleminin sonunda makineyi durulama zamanı gelir. Su haznesini ve damlama tepsisini iyice durulayın. Su haznesini taze içme suyuyla doldurun ve yerine geri koyun. Hazneyi boşaltın ve tekrar kahve çıkışının altına yerleştirin.

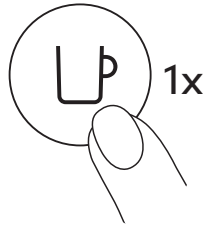

- 10** Makineyi durulamak için düğmeye basın. Düğmenin hızlı yanıp sönmesi durup sabit hale geldiğinde, kireç çözme işlemi tamamlanmıştır.

- i** Prosedür tamamlandığında makine otomatik olarak duracaktır.

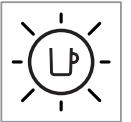
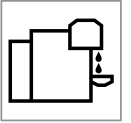
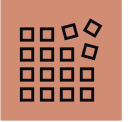
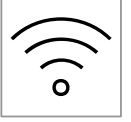

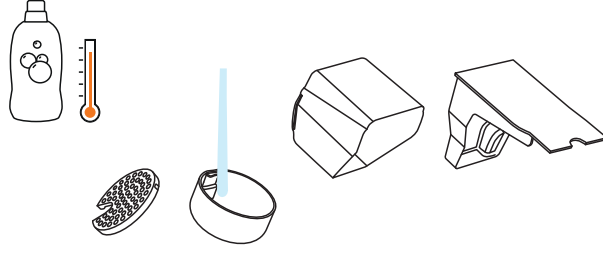

- 11** Kapsül kabını, bardak desteğini ve damlama tepsisini sıcak su ve hafif kokusuz deterjanla yıkayın.

**DİKKAT:** Herhangi bir güçlü veya aşındırıcı temizlik maddesi veya çözücü temizleyici kullanmayın. Makineyi bulaşık makinesine koymayın. Cihazı veya bir parçasını asla suya batırmayın.

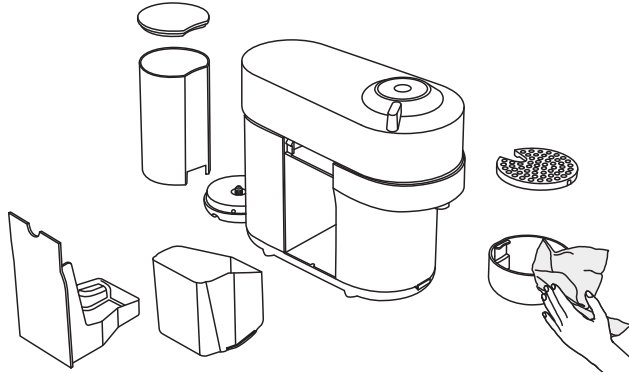

- 12** Makineyi temiz bir havluyla kurulayın. Kullanmadan önce makinenin 10 dakika kurumasını bekleyin.

**NOT:** Temizlik sırasında makinenin kafa kısmında su birikebilir. Bu olursa, lütfen görünen kısımları temiz ve kuru bir bezle kurulayın.

**NOT:** Makine 30 veya daha fazla kahve demlendikten sonra kireç çözme moduna geçmektedir.

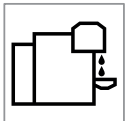

## SİSTEMİN BOŞALTIMASI

Sistemin boşaltılması, donma koruması için veya makineyi tamire göndermeden önce, belirli bir süre kullanılmadan önce yapılabilecek bir işlemdir.

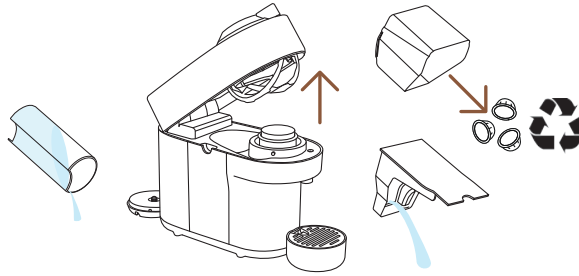

- 1** Su haznesini boşaltın, makine kafasını açın ve kullanılmış kapsülü dışarı atın. Kapsül kabını ve damlama tepsisini boşaltın. **Nespresso** kapsüllerinizi geri dönüştürmeyi unutmayınız.\*

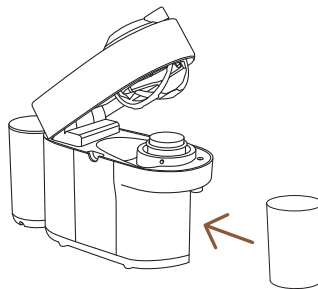

- 2** Bunları makinedeki yerine yerleştirin, fincan desteğini çıkarın ve kahve çıkışının altına boş bir kap (0,5 L / 17 fl oz) yerleştirin.

\* THIS IS **NESPRESSO**. THIS IS RECYCLABLE. **Nespresso** kapsüllerinin geri dönüşümü ile ilgili daha fazla bilgi edinmek için, [www.nespresso.com](http://www.nespresso.com)'u ziyaret edin



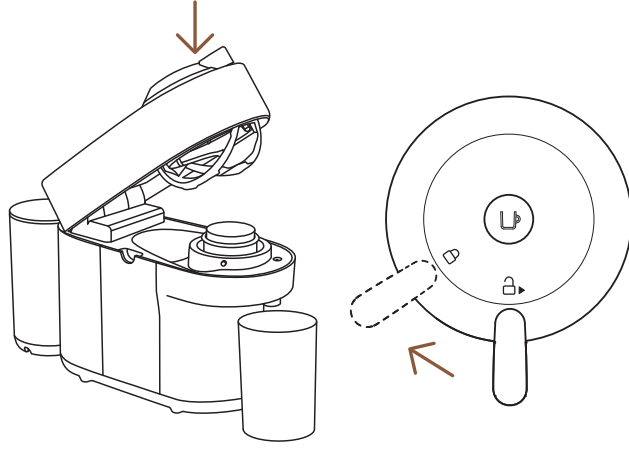

- 3** Makine fişe takılıken ve açıkken, makine kafasını açıp kapatın ve kolu kilitli konuma çevirin.

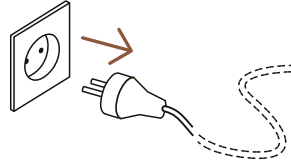

- 4** Makinenin fişini çekin.

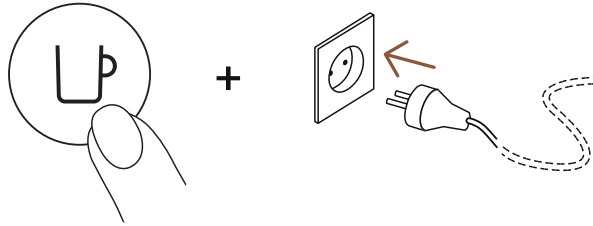

- 5** Makineyi fişe takarken düğmeye basılı tutun.

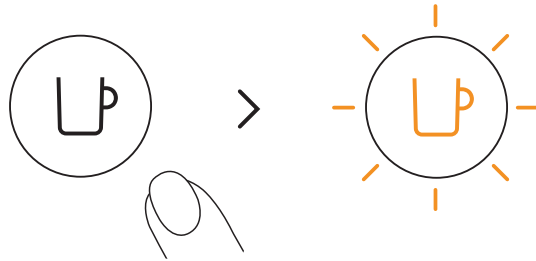

- 6** Düğmeyi bırakın. Turuncu renkte yanıp sönecek ve boşaltma işlemi başlayacaktır.

- i** Makinenin boşaltma işlemini tamamlaması yaklaşık 30 saniye sürecektir. Boşaldığında makine otomatik olarak kapanır.

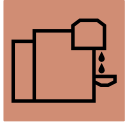

## FABRİKA AYARLARINA SIFIRLA

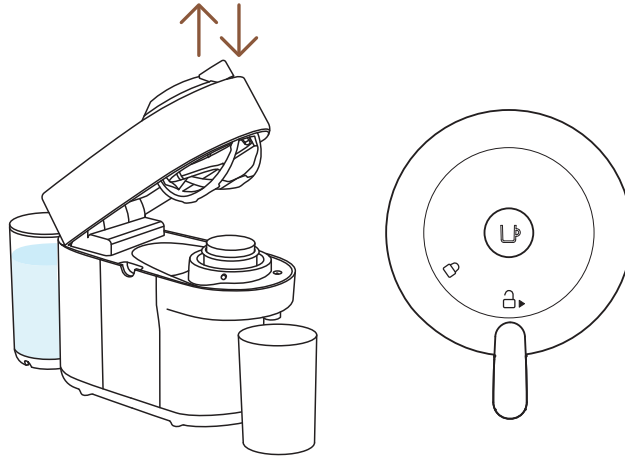

- 1 Makine fişe takılıyken, kolu açık konumda bırakmadan önce makinenin kafa kısmını açın ve kapatın.

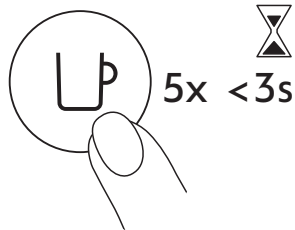

- 2 Düğmeye 3 saniye içinde 5 kez basın. Makine artık fabrika ayarlarıyla programlanmıştır.

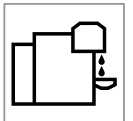

## YANIP SÖNME ÖZETİ

Vertuo Pop yanıp sönme uyarıları hakkında daha fazla bilgi edinmek ister misiniz? Lütfen aşağıdaki videoyu izleyin:

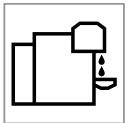

## SORUN GİDERME

### Düğmede ışık yok.

- Makine otomatik olarak KAPALI duruma geldi; düğmesine basın veya makinenin "KİLİTİNİ AÇIN".
- Şebekeyi, fişi, voltajı ve sigortayı kontrol edin.

### Kahve yok, su yok.

- Su deposunun dolu olduğunu kontrol edin.
- Yeni bir kapsülün doğru konumda yerleştirildiğini, kolun düzgün bir şekilde kilitlendiğini kontrol edin ve başlatmak için düğmeye basın.
- Gerekirse kireçten arındırın.
- Makine kafa kısmını açın ve kapsülün dışarı çıkmasına izin verin. Ardından temizleme bölümüne göre bir temizlik yapın.

### Kahve yeterince sıcak değil.

- Bardağı, musluktan sıcak içme suyuyla önceden ısıtın.
- Gerekirse kireçten arındırın.

### Sızıntı veya olağandışı kahve akışı.

- Su deposunun iyi yerleştirilip yerleştirilmediğini kontrol edin.
- Gerekirse kireçten arındırın.

### Makine "KAPALI modu"na döner.

- Enerjiden tasarruf etmek için makine 2 dakika kullanılmadığında kapanacaktır.
- Makine istenildiği zaman (kullanılmadığında) düğmeye 3 saniye basılı tutularak manuel olarak "KAPALI" konuma getirilebilir.

### Fincanda kahve telvesi.

- Temizleme prosedürünü iki kez gerçekleştirin.
- "Temizlik" bölümüne bakın.

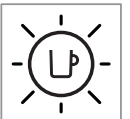
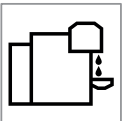
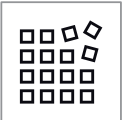
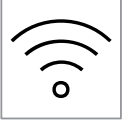

**Makine çalışmıyor ve ışığı sürekli yanıyor. Yanıp sönüyorsa sonraki noktalara bakın.**

**Makine çalışmıyor ve ışık dönüşümlü olarak yanıp sönüyor; 1 yanıp sönme ve 1 duraklama.**

**Makine çalışırken ışık yanıp söner.**

**Işık yanıp sönüyor ve makine çalışmıyor.**

- Kolun düzgün bir şekilde kilitlendiğini kontrol edin.
- Kahve veya Espresso yapmak istiyorsanız, yeni bir kapsülün doğru konumda yerleştirildiğini, kolun düzgün bir şekilde kilitlendiğini kontrol edin ve başlatmak için düğmeye basın.
- Sistemi temizliyor, kireçten arındırıyor veya boşaltıyorsanız, kapsülün takılı olmadığından emin olun, ardından makineyi kapatın, kilitleyin ve bu işlemlerden birini başlatmak için düğmeye basın.
- Su haznesini doldurun ve başlatmak için düğmeye basın.
- Kolun düzgün bir şekilde kilitlendiğini kontrol edin.
- Kahve normal şekilde akıyorsa bu, makinenin düzgün çalıştığını gösterir.
- Yalnızca su akıyorsa makine, sistemi temizlemek, kireçten arındırmak veya boşaltmak için bir kullanıcı talebini yerine getiriyor demektir. Kullanım kılavuzundaki ilgili bölüme bakın.
- Düğmeye 3 saniye basarak makineyi “KAPALI moda” getirin ve ardından makineyi AÇIK konuma getirmek için tekrar basın. Yoğun kullanımdan sonra makinenin soğuması için yaklaşık 20 dakika bekleyin.
- Kahve akışının başlaması biraz zaman alacaktır (kod okuma süresi ve kahvenin önceden ıslatılması nedeniyle).
- Yeni bir kapsülün doğru konumda yerleştirildiğini, kolun düzgün bir şekilde kilitlendiğini kontrol edin ve başlatmak için düğmeye basın.
- Su haznesini doldurun ve başlatmak için düğmeye basın.
- Düğmeye 3 saniye basarak makineyi “KAPALI moda” getirin ve ardından makineyi AÇIK konuma getirmek için tekrar basın. Şimdi, yoğun kullanımdan sonra makinenin soğuması için yaklaşık 20 dakika bekleyin.

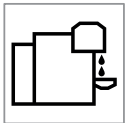



**Işık dönüşümlü olarak yanıp söner, 2 yanıp sönmeye ve 1 sürekli duraklama. Makine çalışmıyor.**

- Normal Kahve/Espresso hazırlığı sırasında:
  - 1) Yeni, hasarsız bir kapsülün doğru konuma yerleştirildiğini kontrol etmek için kolun kilidini açın ve makine kafasını açın.
  - 2) Kolun "KİLİTLİ" konumda olduğunu kontrol edin.
  - 3) Su haznesinin dolu olduğunu kontrol edin.
- Kireç Çözme, Boşaltma ve Temizleme Sırasında:
  - 1) Kapsülün çıkıp çıkmadığını kontrol edin.
  - 2) Kolun "KİLİTLİ" konumda olduğunu kontrol edin.
- Programlama sırasında:
  - 1) Kapsülün iyi yerleştirilip yerleştirilmediğini kontrol edin.
  - 2) Lütfen ilgili "**Kahve miktarınızı ayarlayın**" bölümünü inceleyin.
- Sorun devam ederse:
  - 1) Kolun kilidini açın ve makinenin kafa kısmını açın.
  - 2) Kapsülü yeniden yerleştirin. (gerekli takdirde)
  - 3) Güç kablosunu prizden çıkarın ve 10 saniye sonra makineyi tekrar prize takın.
  - 4) Başlığı kapatın. AÇIK konuma getirmek için düğmeye basın ve demlemeye başlamak için tekrar basın.

Sorun devam ederse, **Nespresso**'yu arayın.
- Kireç çözme işlemi gerekli: Makine, kireç çözme uyarısı görüldükten sonra yalnızca birkaç kez kullanılabilir.

**Işık dönüşümlü olarak 3 kez yanıp sönüyor ve ardından sürekli yanıyor.**

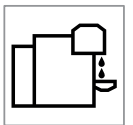
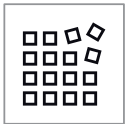

## ÖZELLİKLER

<b>Güç</b>	<b>~220-240 V, 50-60 Hz, 1300-1500 W</b> <b>US, CA:</b> 120 V, 60 Hz, 1500 W <b>MX:</b> 127 V~, 60 Hz, 1380 W
<b>Frekans</b>	2.402-2.480 GHz
<b>RF çıkış gücü (EIRP)</b>	Bluetooth 4 dBm Maks. e.i.r.p. ve Wi-Fi <20 dMm maks. e.i.r.p.
<b>Bekleme</b>	0.39 W/h
<b>Düşük enerji tüketim modu</b>	2 dakika sonra otomatik kapanma
<b>Isınma süresi</b>	30 saniye (kapak kapalı ve kitli)
<b>Büyük tarifler için ayarlanabilir fincan desteği</b>	Çıkarılabilir, tek pozisyon
<b>Cihazdan itibaren kablo uzunluğu</b>	75 cm / 30 in
<b>Boyutlar (G x D x Y)</b>	13.6 x 42.6 x 25 cm / 5.3 x 16.7 x 9.8 in
<b>Ağırlık</b>	3.5 kg / 7.72 lbs
<b>Su haznesi kapasitesi</b>	0.6 l / 20 fl oz
<b>Kullanılmış Kapsül Kapasitesi</b>	8 espresso kapsülü veya 5 mug kapsülü

## MAKİNE KODLARI

Nespresso	Breville	Delonghi
GCV2, GDV2	BNV120, BNV150	ENV90
Krups	Magimix	
XN9201, XN9204, XN9205, XN9211	M800	

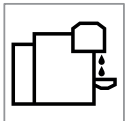

## المواصفات

W 1000-1300 ,Hz 60-50 ,V 240-220~ W 1000 ,Hz 60 ,V 120 :US, CA W 1380 ,Hz 60 ,~V 127 :MX	الطاقة	
GHz 2,480-2,402	التواتر	
البلوتوث 4 e.i.r.p Max. dBm والواي فاي > 2.0 .dMm max. e.i.r.p	و تردد اخراج طاقة	
W/h 0,39	تعليق	
وضع الترشيح البيئي: دقيقتان 30 ثانية (مع إغلاق وتأمين الرأس)	وضع توفير الطاقة	
وضعية واحدة قابلة للفك	زمن التسخين	
in 30 / cm 70	داعم فناجين متحرك للمواصفات بفناجين الكبيرة	
in 9,8 x 16,7 x 0,3 / cm 20 x 42,6 x 13,6	طول سلك الكهرباء بدءاً من الماكينة	
lbs 7,72 / kg 3,0	الأبعاد (العرض x العمق x الارتفاع)	
fl oz 20 / ml 600	الوزن	
8 كبسولات اسبريسو أو 0 كبسولات ماج	سعة خزان المياه سعة حاوية الكبسولات	
<b>أكواد الماكينة</b>		
<b>Nespresso</b>	<b>Breville</b>	<b>Delonghi</b>
GDV2 ,GCV2	BNV100 ,BNV120	ENV90
<b>Krups</b>	<b>Magimix</b>	
,XN9204 ,XN9201 XN9211 ,XN9200	M800	

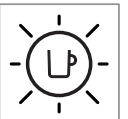
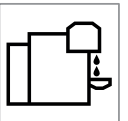
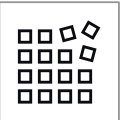
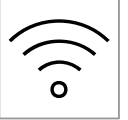

- أثناء عملية تحضير القهوة/السبريسو العتيادية:
  - ١) حرر المقبض وافتح رأس الماكينة لتفقد الكبسولة. تأكد من أنك وضعت كبسولة جديدة صالحة بالوضعية الصحيحة.
  - ٢) تأكد من أن المقبض بوضعية "مقفل".
  - ٣) تأكد من أن خزان الماء مليء بالماء.
- أثناء عملية إزالة الترسبات وإفراغ الماكينة وتنظيفها:
  - ١) تأكد من أن الماكينة قد لفظت الكبسولة.
  - ٢) تأكد من أن المقبض بوضعية "مقفل".
- خلال برمجة الماكينة بكمية الماء المفضلة:
  - ١) تأكد من إدخال كبسولة بالوضعية الصحيحة.
  - ٢) راجع القسم المتعلق بهذه العملية "اضبط كمية القهوة".
- إذا استمرت المشكلة:
  - ١) حرر قفل المقبض وافتح رأس الماكينة.
  - ٢) غير الكبسولة (إذا لزم الأمر).
  - ٣) نزع قابس الماكينة من مقبس الكهرباء. انتظر لـ ١٠ ثوان ثم أعد وصل الماكينة بالكهرباء.
  - ٤) غلق رأس الماكينة واضغط على الزر لتشغل الماكينة ثم اضغط مرة أخرى للبدء بعملية التحضير. إذا استمرت المشكلة يرجى الاتصال بنسبريسو.
- إذا استمرت المشكلة يرجى الاتصال **بنادي نسبريسو**
- الماكينة بحاجة لإزالة الترسبات. بعد ظهور التنبيه، يمكنك تشغيل الماكينة لتحضير عدد محدود من أكواب القهوة لتصبح عملية إزالة الترسبات بعد ذلك ضرورية.
- **الضوء يومض بالتناوب - ومضتان ثم توقف باطراد. الماكينة لا تعمل.**
- **ضوء يومض ٣ مرات بالتناوب ثم باستمرار.**

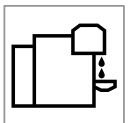
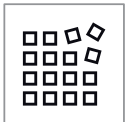

- **الضوء يومض بينما الماكينة تعمل**
- إذا كانت الماكينة تعمل بشكل طبيعي فهذا يشير إلى أنها تعمل كما يجب.
- ولكن إذا كان الماء فقط هو ما يتدفق منها فهذا يعني أنها تطلب من المستخدم أن يجرى عملية تنظيف أو إزالة للترسبات أو إفراغ النظام. راجع القسم المتعلق بهذه العمليات في دليل المستخدم. راجع القسم المعني في دليل المستخدم.
- ضع الماكينة في "وضع إيقاف التشغيل" بالضغط على الزر لمدة ٣ ثوان ثم اضغط عليه مرة أخرى لتشغيل الماكينة. انتظر حوالي ٢٠ دقيقة كي تبرد الماكينة. انتظر حوالي ٢٠ دقيقة كي تبرد الماكينة بعد الاستخدام المكثف.
- ستأخذ الماكينة بعض الوقت قبل أن تبدأ القهوة بالتدفق (حتى تكتمل قراءة الباركود وترطب الماكينة شبكة الأنابيب الداخلية).
- تأكد من إدخال كبسولة جديدة في الموضع الصحيح وأن المقبض مغلق كما يجب واضغط على الزر لبدء التشغيل.
- إمأل خزان الماء بالماء ثم اضغط على الزر للبدء.
- ضع الماكينة في "وضع إيقاف التشغيل" بالضغط على الزر لمدة ٣ ثوان ثم اضغط عليه مرة أخرى لتشغيل الماكينة. انتظر حوالي ٢٠ دقيقة كي تبرد الماكينة. انتظر حوالي ٢٠ دقيقة كي تبرد الماكينة بعد الاستخدام المكثف.

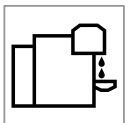
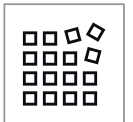

## استكشاف الأخطاء وإصلاحها

- ضوء الزر مطغماً.
  - الماكينة أطفأت نفسها تلقائياً. اضغط على الزر أو «حرر قفل» الماكينة.
  - تحقق من الأنابيب والقابس ووصول التيار الكهربائي والقاطع (الفيوز).
- لا قهوة ولا ماء.
  - تأكد من أن خزان الماء مليء بالماء.
  - تأكد من إدخال كبسولة جديدة في الموضع الصحيح وأن المقبض مغلق كما يجب واضغط على الزر لبدء التشغيل.
  - قم بإزالة الترسبات إذا كان ذلك ضرورياً.
  - افتح رأس الماكينة ودع الكبسولة تخرج. ثم قم بتنظيف الماكينة باتباع التعليمات في قسم تنظيف الماكينة.
- القهوة ليست ساخنة بما فيه الكفاية.
  - سخّن الغنجان بماء شرب ساخن من الصنبور. قم بإزالة الترسبات إذا كان ذلك ضرورياً.
  - تحقق من صحة وضعية خزان الماء.
  - قم بإزالة الترسبات إذا كان ذلك ضرورياً.
- تسرب أو تدفق غير اعتيادي للقهوة.
  - تطفئ الماكينة تطفئ نفسها تلقائياً بعد دقيقتين من عدم الاستخدام لتوفير الطاقة
  - يمكن إطفاء الماكينة في أي وقت (عندما لا تكون قيد الاستخدام) بالضغط باستمرار على الزر لـ ٣ ثوانٍ.
- الماكينة تطفئ نفسها تلقائياً.
  - شغل عملية التنظيف الآلي مرتين.
  - راجع فقرة «تنظيف الماكينة»
  - تحقق من أن المقبض مقفل كما يجب.
  - إذا كنت تريد تحضير قهوة أو اسبريسو، تأكد من إدخال كبسولة جديدة في الموضع الصحيح وأن المقبض مغلق كما يجب واضغط على الزر لبدء التشغيل.
  - إذا كنت تريد تنظيف الماكينة أو إزالة الترسبات أو تفريغها، تأكد من أنه لا توجد كبسولة في الماكينة ثم أغلق وأقفل الماكينة واضغط على الزر لبدء العملية التي ترغب أن تنفذها الماكينة.
- توجد بقايا من البن المطحون في الغنجان
  - الماكينة لا تعمل لكن هناك ضوء مستمر. إذا كان الضوء يومض، راجع الفقرات التالية.
- الماكينة لا تعمل والضوء يومض بالتناوب - ومضة ثم توقف.
  - إمأل خزان الماء بالماء ثم اضغط على الزر للبدء.
  - تحقق من أن المقبض مقفل كما يجب.

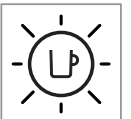
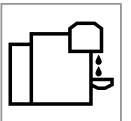
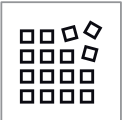
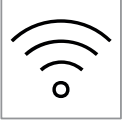

## دليل وميض الزر

هل تريد أن تعرف المزيد عن ضوء الوميض في شيرتو بوب؟  
يرجى مشاهدة الفيديو التالي:

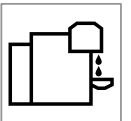
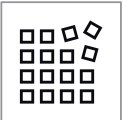
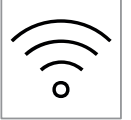

## استعادة إعدادات المصنع

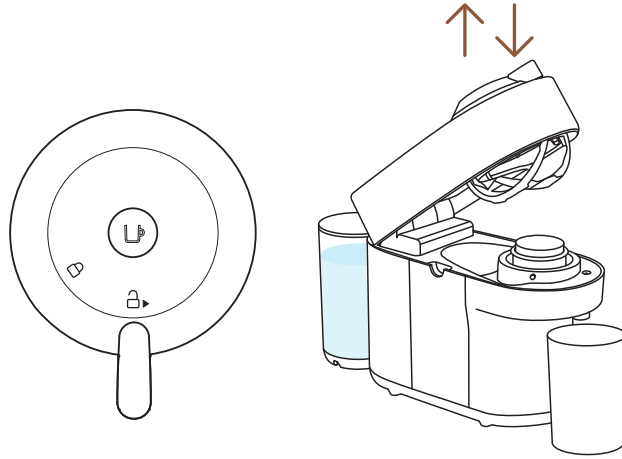

**1** أثناء تشغيل الماكينة، افتح وأغلق رأس الماكينة قبل أن تترك المقبض بوضع "إلغاء القفل".

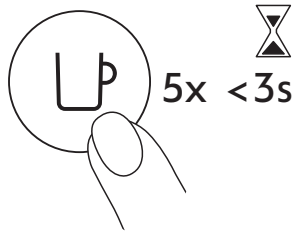

**2** اضغط على الزر 0 مرات خلال 3 ثوان الماكينة الآن مبرمجة بإعدادات المصنع.

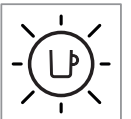
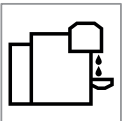
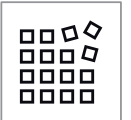
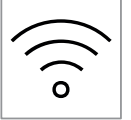



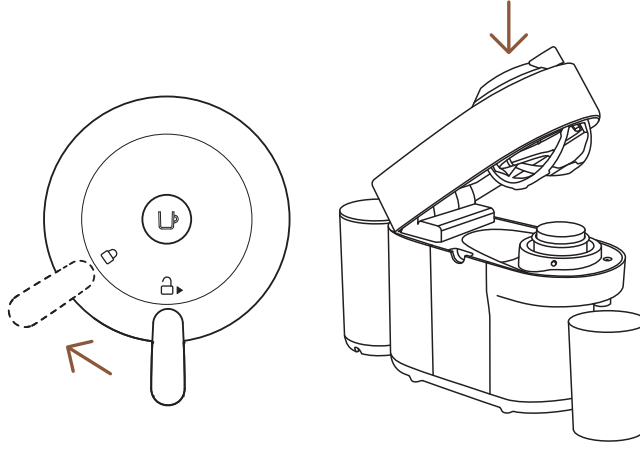

**٣** مع توصيل الماكينة و تشغيلها، افتح وأغلق رأس الماكينة وأدر المقبض للييسار لوضع "مقفل".

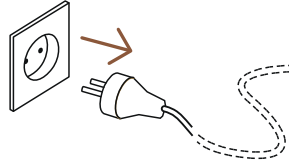

**٤** إ فصل الماكينة

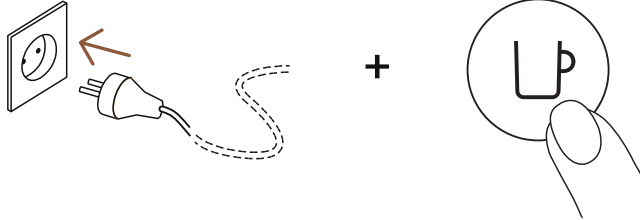

**٥** اضغط باستمرار على الزر أثناء التوصيل

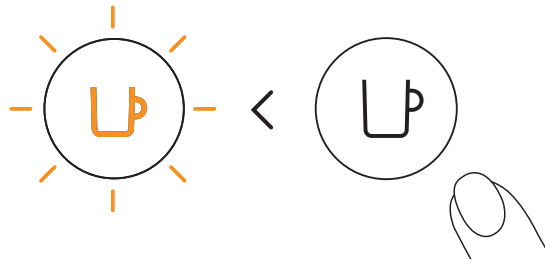

**٦** حرر الزر. سيومض الزر باللون البرتقالي لتبدأ عملية تفريغ الماكينة.

**i** تستغرق الماكينة حوالي ٣٠ ثانية لتكتمل عملية التفريغ. تتوقف الماكينة عن العمل تلقائياً عندما تفرغ تماماً.

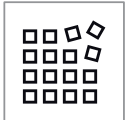
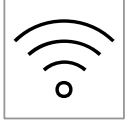

## تفريغ الماكينة

ننصح بتفريغ الماكينة قبل تركها لفترة طويلة بدون استخدام أو للحماية ضد تجمد السوائل أو قبل إرسال الماكينة للصيانة.

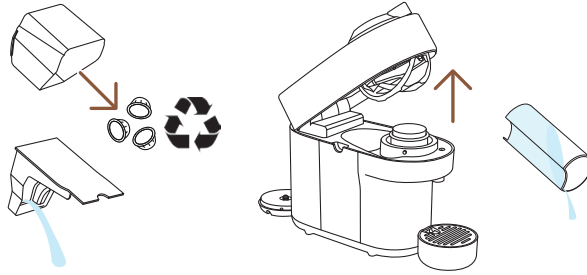

**١** أفرغ خزان الماء وافتح رأس الماكينة ودع الكبسولة المستعملة تخرج. أفرغ صينية التنقيط وحاوية الكبسولات. لا تنس إعادة تدوير كبسولات **قهوة** نسبريسو التي تستعملها\*.

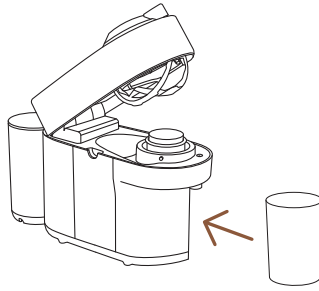

**٢** ثم أعدهما إلى مكانهما بصورة صحيحة، انزع دعامة الفنجان وضع وعاء فارغاً (سعة ٠,٥ لتر على الأقل / ١٧ أونصة سائل) تحت مخرج القهوة.

\* نقدم لكم نسبريسو، انها قابلة لإعادة التدوير. للمزيد من المعلومات حول إعادة تدوير كبسولات **نسبريسو** الخاصة بك، قم بزيارة

[www.buynespresso.com](http://www.buynespresso.com)

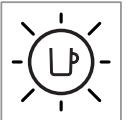
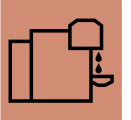
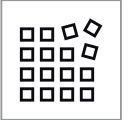
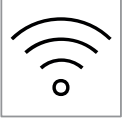

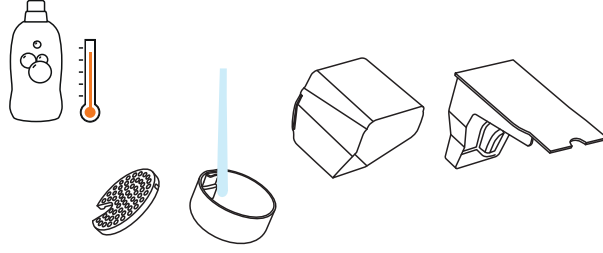

**11** اغسل حاوية الكبسولة ودعامة الفنجان وصينية التنقيط بالماء الساخن وامنظف خفيف عديم الرائحة.

**تحذير:** لا تستخدم منظفات قوية أو كاشطة أو مذيبات. لا تضعها في جلاية الصحون. لا تغمر الجهاز أو جزءاً منه بالماء.

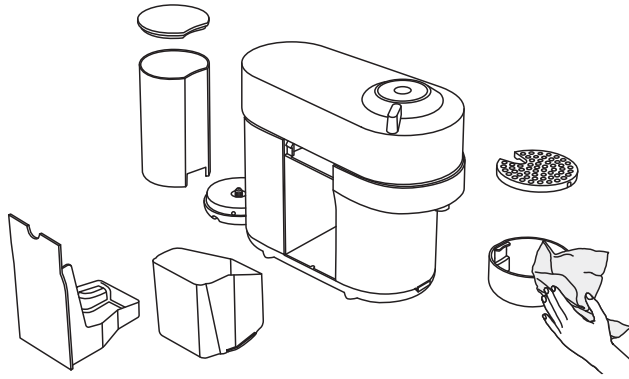

**12** نشّف الماكينة بمنشفة نظيفة. انتظر لمدة ١٠ دقائق حتى تجفّ الماكينة قبل استخدامها مرة أخرى.

**ملاحظة:** قد يتجمع الماء داخل رأس الماكينة أثناء التنظيف. وفي حال حدوث ذلك، يرجى تجفيف الأجزاء المرئية من الماكينة بقطعة قماش جافة ونظيفة.

**ملحوظة:** لا يمكن للآلة الدخول في وضع إزالة الترسبات إلا بعد تحضير 30 قهوة أو أكثر.

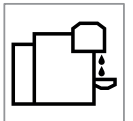
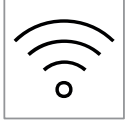

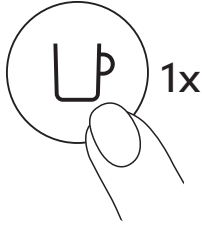

**٨** اضغط على زر القهوة مرة واحدة لبدء عملية إزالة الترسبات. سيومض الضوء باللون البرتقالي باستمرار طوال العملية.

**i** ستتوقف الماكينة تلقائياً عند اكتمال المرحلة الأولى من إزالة الترسبات.

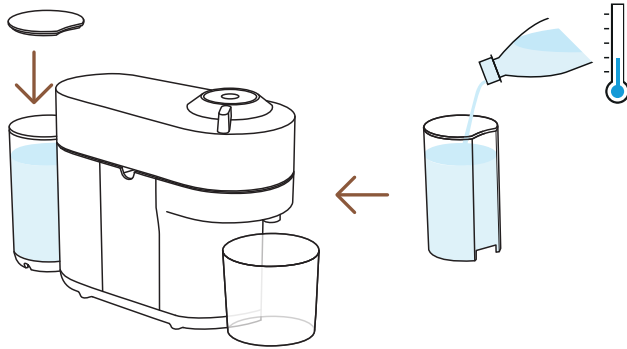

**٩** في نهاية عملية إزالة الترسبات، حان وقت شطف الماكينة. اشطف خزان الماء وصينية التنقيط جيداً. إملأ خزان الماء بماء عذب صالح للشرب وأعدّه إلى مكانه. أفرغ الوعاء ثم أعد وضعه تحت مخرج القهوة.

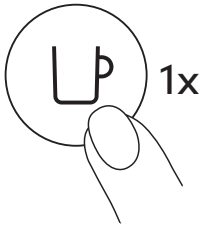

**١٠** اضغط على الزر لشطف الماكينة. عندما يتوقف الزر عن الوميض بسرعة ويصبح ثابتاً تكون عملية إزالة الترسبات قد اكتملت.

**i** ستتوقف الماكينة تلقائياً عند اكتمال عملية إزالة الترسبات.

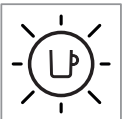
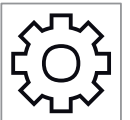
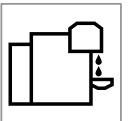
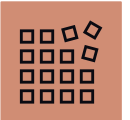

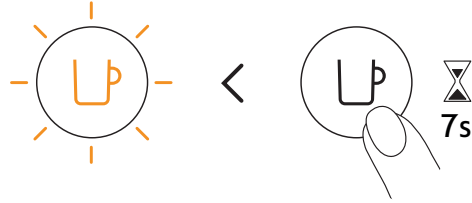

**٥** اضغط على الزر لمدة ٧ ثوان متواصلة على الأقل أو حتى ينطفئ الضوء. سيبدأ الزر بالوميض باللون البرتقالي بسرعة.

**تحذير:** لديك الآن ٤٥ ثانية لتدخل في وضع إزالة الترسبات وإلا ستعود الماكينة إلى وضع الاستخلاص.

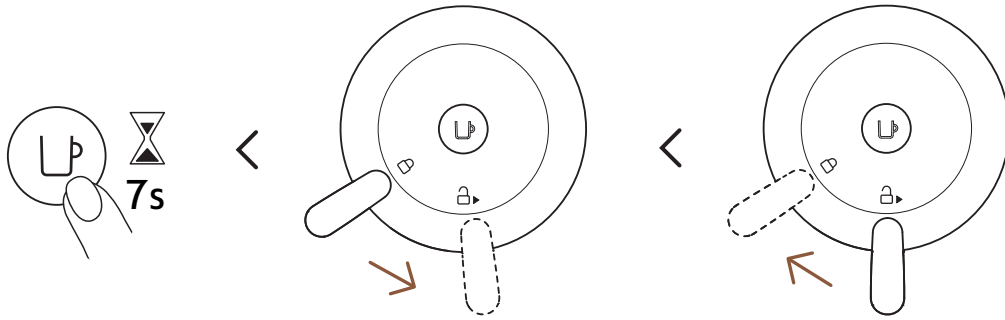

**٦** أغلق رأس الماكينة بإدارة المقبض لإدارة اليسار حتى وضع "مقفل"، ثم افتح المقبض بإدارته يمينا حتى وضع "إلغاء القفل". اضغط مع الاستمرار على الزر مرة أخرى لمدة ٧ ثوان تقريبا أو حتى ينطفئ الضوء. سيبدأ الزر بالوميض باللون البرتقالي بسرعة.

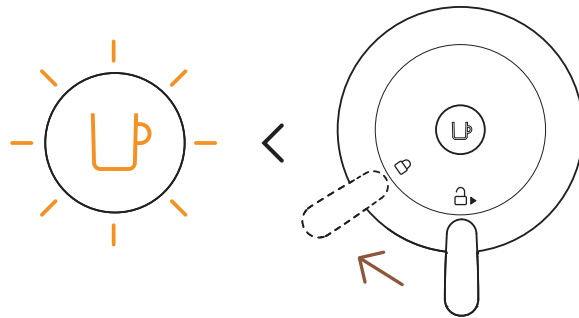

**٧** لتدخل في وضع إزالة الترسبات، أقفل الماكينة بإدارة المقبض لليسار حتى وضع "مقفل". يجب أن يستمر الزر بالوميض باللون البرتقالي بسرعة وهو مؤشر على دخولك في وضع إزالة الترسبات.

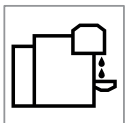
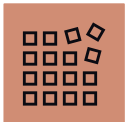

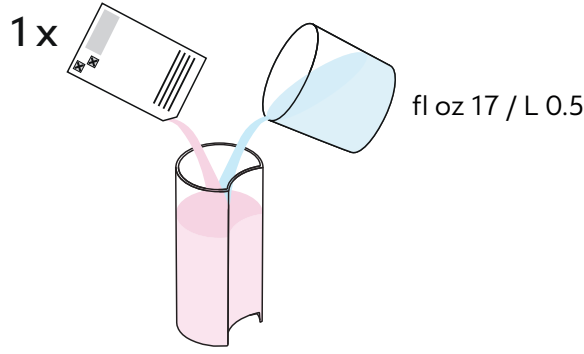

**٢** املاً خزان الماء حتى ٠,٥ لتر / ١٧ أونصة سوائل بالماء، ثم أضف وحدة من سائل نسبريسو لإزالة الترسبات.

**تحذير:** يرجى الانتباه إلى أن محلول إزالة الترسبات قد يكون مؤذياً. تجنب أن تتعرض له الأعين والبشرة والأسطح.

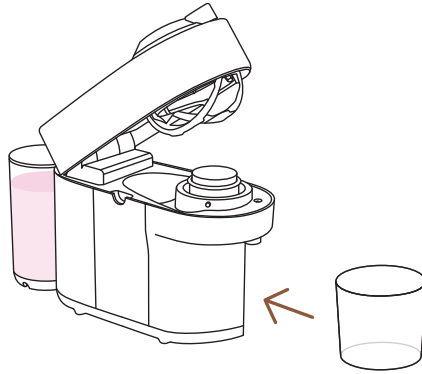

**٣** انزع دعامة الفنجان وضع وعاء فارغاً (سعة ١ لتر على الأقل / ٣٤ أونصة سوائل) تحت مخرج القهوة.

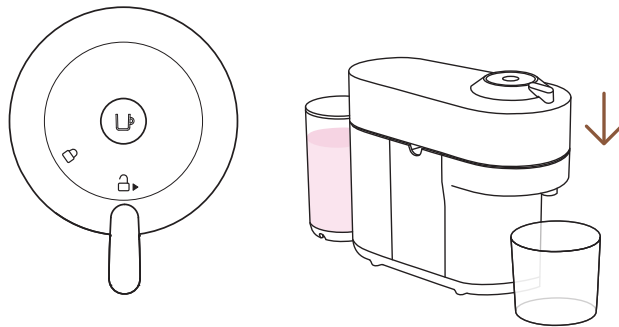

**٤** أثناء تشغيل الماكينة، أغلق رأس الماكينة واترك المقبض في وضع "إلغاء القفل".



## إزالة الترسبات

إن إزالة الترسبات العالقة في الماكينة تضمن أنها تعمل بصورة صحيحة طوال عمرها وتجعل تجربة تناول القهوة لا تضاهى تماماً كما كانت في اليوم الأول لاستخدام الماكينة. ستنبهك الماكينة عند الحاجة لإزالة الترسبات بإضاءة ٣ ومضات برتقالية قبل أن يثبت الضوء باللون الأبيض.



**i** تستغرق عملية إزالة الترسبات حوالي ٢٠ دقيقة ولا يمكن وقفها.

**ملاحظة:** يُرجى قراءة تعليمات إزالة الترسبات بعناية قبل البدء.

**ستحتاج إلى:**

- طقم إزالة الترسبات متوافر على موقعنا الإلكتروني [www.nespresso.com](http://www.nespresso.com)
- وعاء فارغ (سعة ١ لتر على الأقل / ٣٤ أونصة سوائل)

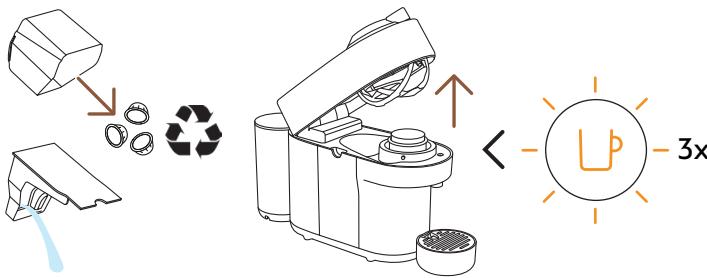

**i** عندما يومض الضوء ٣ ومضات برتقالية: ألغي القفل وافتح رأس الماكينة ودع الكبسولة المستعملة تخرج. أفرغ صينية التنقيط وحاوية الكبسولات ثم أعد تركيبها بصورة صحيحة. لا تنس إعادة تدوير كبسولات **قهوة** نسبريسو التي تستعملها.\*

\* نقدم لكم نسبريسو، انها قابلة لإعادة التدوير. للمزيد من المعلومات حول إعادة تدوير كبسولات **نسبريسو** الخاصة بك، قم بزيارة [www.buynespresso.com](http://www.buynespresso.com)



**٦** اضغط على الزر ٣ مرات خلال ثانيتين لبدء الشطف.  
دع إجراء التنظيف يكتمل تلقائياً.

**i** يجب أن يستغرق الأمر أقل من دقيقتين قبل أن تبدأ عملية التنظيف ويبدأ الماء في التدفق. قد تستغرق هذه العملية ما يصل إلى ٥ دقائق وستتوقف تلقائياً عند اكتمالها. يمكن إيقاف الإجراء في أي وقت بالضغط على الزر

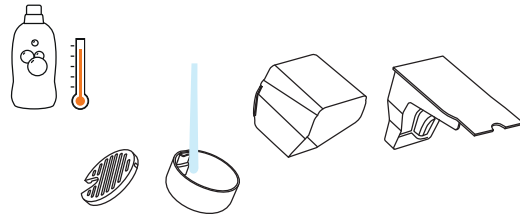

**v** اغسل حاوية الكبسولة ودعامة الفنجان وصينية التنقيط بالماء الساخن  
ومنظف خفيف عديم الرائحة.

**تحذير:** لا تستخدم منظفات قوية أو كاشطة أو مذيبات. لا تضعها في جلاية  
الصحون. لا تغمر الجهاز أو جزءاً منه بالماء.

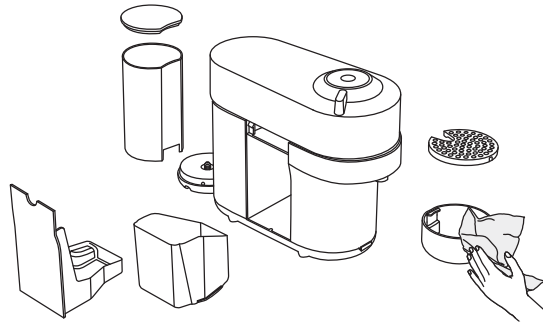

**٨** نشف بمنشفة نظيفة

**تحذير:** امسح مخرج القهوة على نحو منتظم بقطعة قماش مبللة ونظيفة. استخدم  
دائماً قطعة قماش ناعمة لتنظيف الماكينة.

**ملاحظة:** قد يتراكم الماء داخل رأس الجهاز ، يرجى تجفيف الأجزاء المرئية بقطعة  
قماش جافة ونظيفة

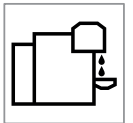



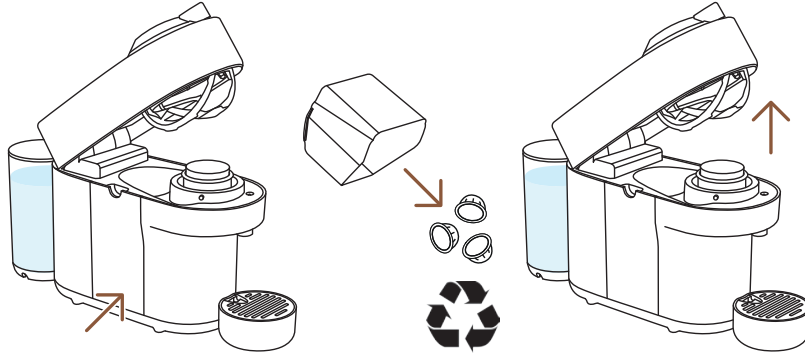

**٣** افتح الجهاز واترك الكبسولة المستخدمة ليتم إخراجها. أفرغ صينية التنقيط وحاوية الكبسولات واشطفهما وأعدهما إلى مكانهما بصورة صحيحة. لا تنس إعادة تدوير كبسولات **قهوة نسبريسو** التي تستعملها\*.

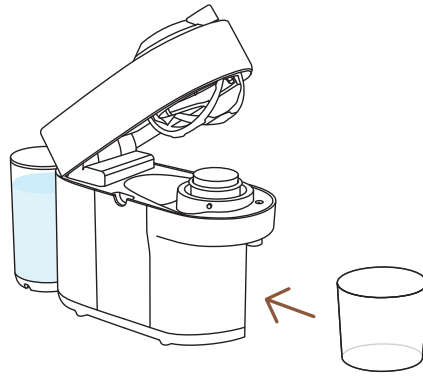

**٤** انزع دعامة الفنجان وضع وعاء فارغاً (سعة ١ لتر على الأقل / ٣٤ أونصة سوائل) تحت مخرج القهوة.

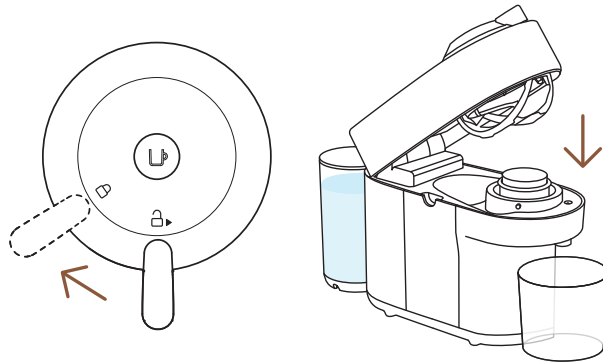

**٥** أغلق رأس الماكينة وأدر المقبض لليسار لوضع "مقفل". تأكد من عدم وجود كبسولات في الجهاز قبل البدء في عملية التنظيف.

\* نقدم لكم نسبريسو، انها قابلة لإعادة التدوير. للمزيد من المعلومات حول إعادة تدوير كبسولات **نسبريسو** الخاصة بك، قم بزيارة [www.buynespesso.com](http://www.buynespesso.com)

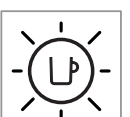
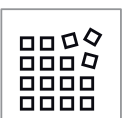
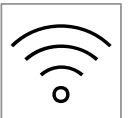

## تنظيف الماكينة

قم بتنظيف الماكينة شهرياً عندما تجد بقايا رواسب قهوة في رأس الماكينة أو بعد فترة طويلة من عدم الاستخدام.

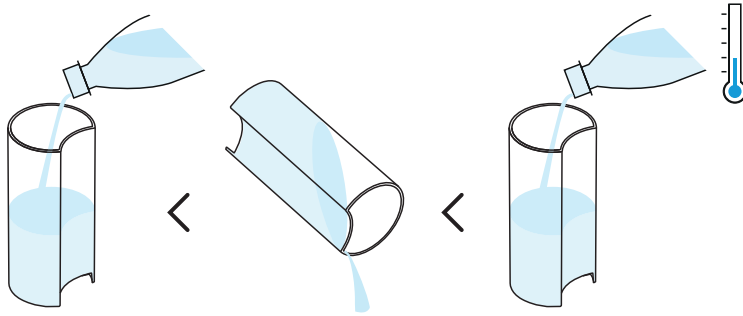

**١** قم أولاً بشطف وتنظيف خزان المياه والغطاء قبل ملئه بماء شرب عذب وطازج.

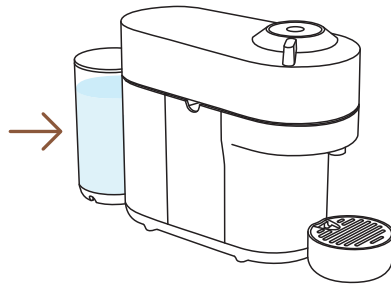

**٢** أعد خزان المياه إلى مكانه على الماكينة.

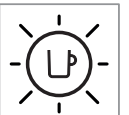
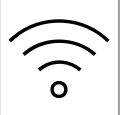

**تحذير:** لاستخدام صحيح للماكينة يرجى عدم فتح رأس الماكينة أثناء استخلاص القهوة، وانتظر حتى يعود زر القهوة إلى اللون الأبيض الثابت. إذا كنت ترغب في إيقاف عملية الاستخلاص قبل انتهائها، اضغط مرة واحدة على زر القهوة وانتظر حتى تتوقف عن العمل قبل فتح رأس الماكينة.

**ملاحظة:** بمجرد برمجة كمية السائل التي يفضلها المستخدم ستقوم الماكينة بتحضير القهوة وفقاً للكمية المبرمجة في كل مرة يتم إدخال نفس الكبسولة في الماكينة. إذا كنت ترغب في إعادة المعايير الأصلية للماكينة راجع فقرة "استعادة إعدادات المصنع".

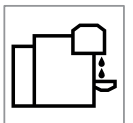
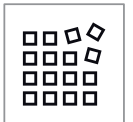

## اضبط كمية القهوة

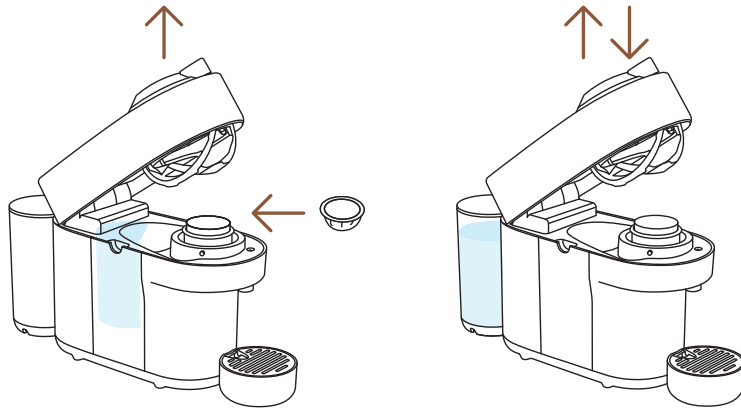

١ افتح وأغلق الماكينة. شغل الماكينة ثم قم بفتحها وأدخل الكبسولة التي تريد برمجتها.

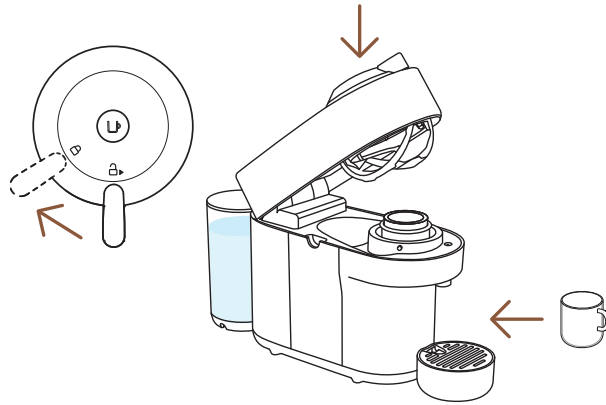

٢ أغلق رأس الماكينة وأدر المقبض لليساار حتى وضع "مقفل"، ثم ضع فنجان القهوة.

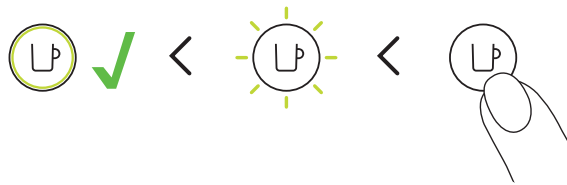

٣ اضغط باستمرار على الزر و اترك قبل بضعة ثواني من الوصول إلى الكمية المطلوبة تمت برمجة كمية الماء الجديدة لنوع الكبسولة المستخدمة أثناء الإعداد.

٤ البرمجة خاصة بكل نوع كبسولة يمكن إعادة ضبط كمية السائل وفقاً لسعة الفنجان من ٢٠ مل / ٧,٠ أونصة سوائل إلى ٣٥٠ مل / ١٨ أونصة سوائل.

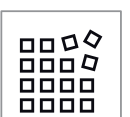
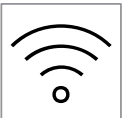

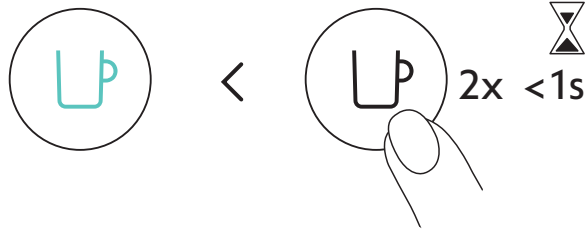

أثناء تشغيل الماكينة انقر نقرة مزدوجة علي زر القهوة. سيومض الزر باللون الفيروزي وسيكون استخلاص القهوة مركزاً لتحسين مذاق القهوة في وصفات القهوة مع إضافات (كالحليب ومبيض القهوة ومع الثلج ...) لتجربة لا تضاهى مع القهوة.

18.8 أونصة سوائل / 535 مل	12 أونصة سوائل / 355 مل	7.77 أونصة سوائل / 230 مل	5.07 أونصة سوائل / 150 مل	2.7 أونصة سوائل / 80 مل	1.35 أونصة سوائل / 40 مل
✗	✗	✓	✓	✓	✓
		2.7 أونصة سوائل / 80 مل	1.35 أونصة سوائل / 40 مل	1.35 أونصة سوائل / 40 مل	0.85 أونصة سوائل / 25 مل

لاستمتاع الكامل بالمزايا ، نوصي بإستخلاص مجموعة كوفي + الخاصة بنا باستخدام أحجام الأكواب الرسمية فقط. للحصول على أفضل النتائج في الكوب ، لا نوصي بتخمير XL (ألتو أمبراتو و ألتو أونيس) وكوار برو ستايل و كاراف بور اوفر ستايل باستخدام هذا الوضع.

**ملاحظة:** قد يكون من الضروري تحديث جهازك عبر **تطبيق** نسبريسو لتمكين هذا الوضع.

اكتشف كيفية ترقية ماكينتك مع مجموعة آيروتشينو على موقعنا الإلكتروني [www.buynespresso.com](http://www.buynespresso.com)

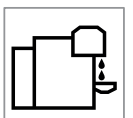

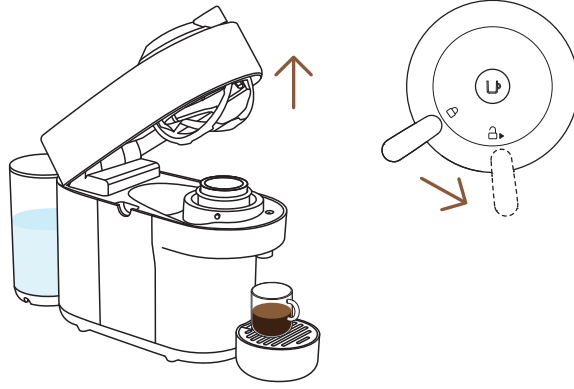

**٦** عندما تتوقف الماكينة عن استخلاص القهوة افتح رأس الماكينة بإدارة المقبض يمينا نحو وضع "إلغاء القفل" لتخرج الكبسولة تلقائياً ثم استمتع بتناول قهوتك.

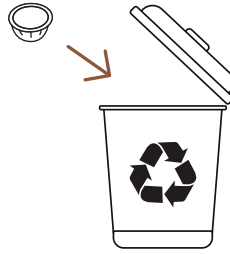

**٧** لا تنس إعادة تدوير كبسولات قهوة نسبريسو التي تستعملها.\*

\* نقدم لكم نسبريسو، انها قابلة لإعادة التدوير.  
للمزيد من المعلومات حول إعادة تدوير كبسولات نسبريسو الخاصة بك، قم بزيارة  
[www.buynespesso.com](http://www.buynespesso.com)

## اكتشف وضعية كوفي كريشنز



مع هذه الماكينة **تقدم** لك نسبريسو وظيفة محدّدة تركّز على استخلاص القهوة لتعدّ وصفاتك الخاصة.

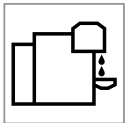

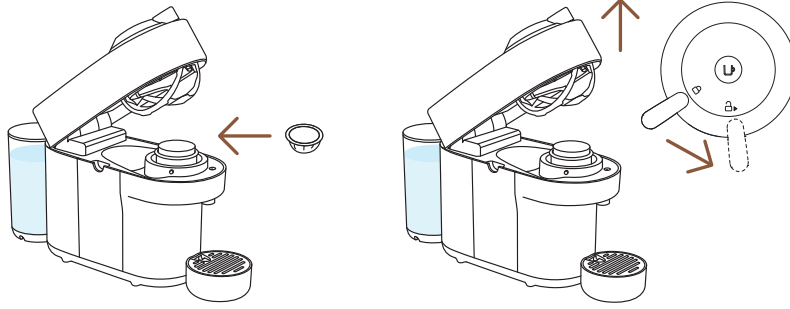

**٣** أَلْغِي القفل وافتح رأس الماكينة لحدده الأقصى وضع كبسولة فيرتو (التي تشبه القبة) بحيث يشير رأس القبة إلى الأسفل.

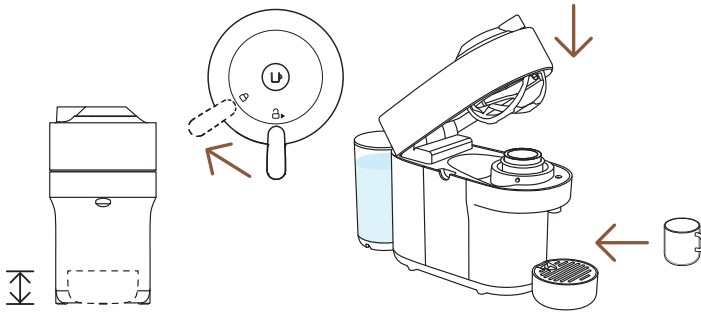

**٤** أغلق وأقفل رأس الماكينة بإدارة المقبض لليسار حتى وضع القفل، ثم ضع فنجان القهوة. يمكن تعديل دعامة الفنجان لتلائم حجم الكوب الذي لديك.

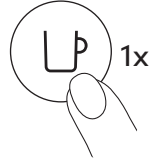

**٥** ابدأ استخلاص القهوة بالضغط على الزر مرة واحدة.

**تحذير:** لاستخدام صحيح للماكينة يرجى عدم فتح رأس الماكينة أثناء استخلاص القهوة، وانتظر حتى يعود زر القهوة إلى اللون الأبيض الثابت. إذا كنت ترغب في إيقاف عملية الاستخلاص قبل انتهائها، اضغط مرة واحدة على زر القهوة وانتظر حتى تتوقف عن العمل قبل فتح رأس الماكينة.

**i** تستغرق الماكينة لحظات قبل أن يبدأ تدفق القهوة بينما تقرأ الكود وترطب القهوة وتعددها للوصفة المطلوبة. ستتعرف الماكينة تلقائياً على الكبسولة التي تم إدخالها وتحدد معايير تحضير القهوة وحجم الفنجان وفقاً للمحددات التي وضعها خبراء **قهوة** نسبريسو لاستخلاص مثالي للقهوة.

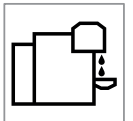

## تحضير القهوة

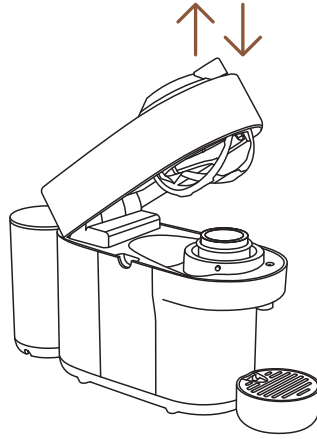

١ إفتح وأغلق الماكينة.

٢ سيومض ضوء القهوة بينما تسخن الماكينة. تصبح الماكينة جاهزة للاستخدام عندما يصبح الضوء ثابتاً.

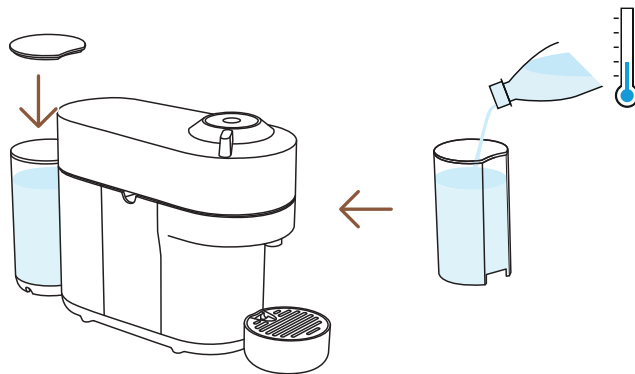

٣ إملأ خزان الماء بماء عذب صالح للشرب وأعدده إلى مكانه.

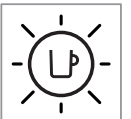
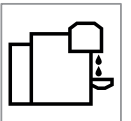
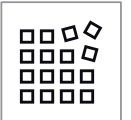
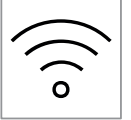



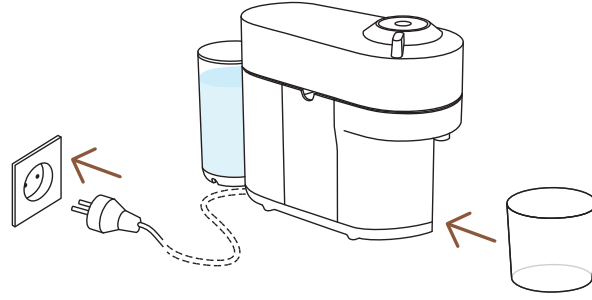

٣ عندما تكون الماكينة مرتبطة بالكهرباء , انزع دعامة الفنجان وضع وعاء فارغاً (سعة ١ لتر على الأقل / ٣٤ أونصة سوائل) تحت مخرج القهوة.

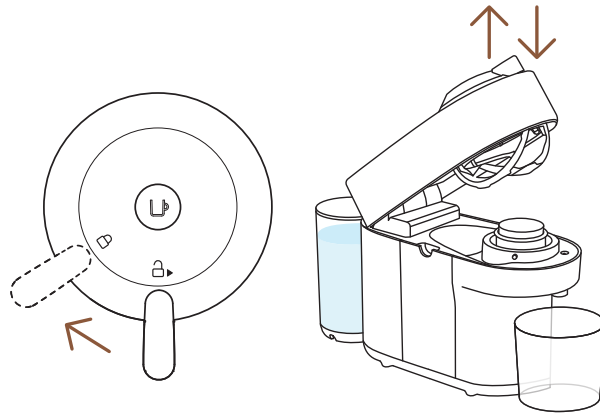

٤ افتح وأغلق الماكينة. تأكد من أن المقبض في وضع القفل.

٥ سيومض الضوء بينما تسخن الماكينة. تستغرق العملية حوالي ٣٠ ثانية. تصبح الماكينة جاهزة عندما يصبح الضوء ثابتاً. تأكد من عدم إدخال أي كبسولة في الماكينة.

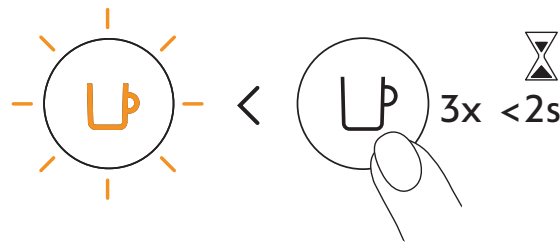

٥ اضغط على الزر ٣ مرات خلال ثانيتين لبدء الشطف. عند وميض الضوء البرتقالي, دع عملية التنظيف حتى تنتهي تلقائياً. تصبح الماكينة جاهزة عندما يصبح الضوء الأبيض ثابتاً.

٥ يجب أن تبدأ عملية الشطف خلال أقل من دقيقتين ليبدأ الماء بالتدفق. قد يستغرق هذا الإجراء ما يصل إلى ٧ دقائق.

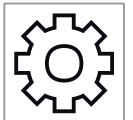
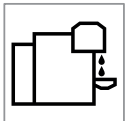

## خطوات التركيب الأولى

## الشطفه الأولى

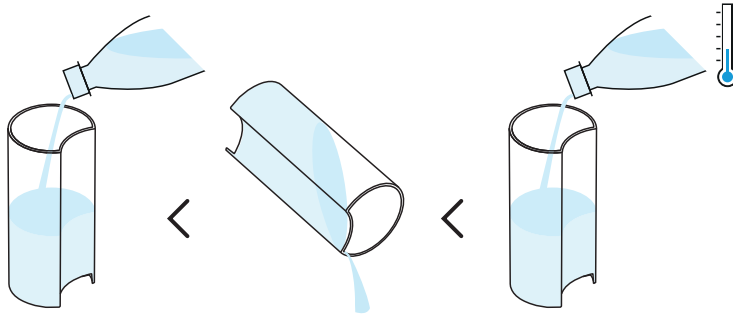
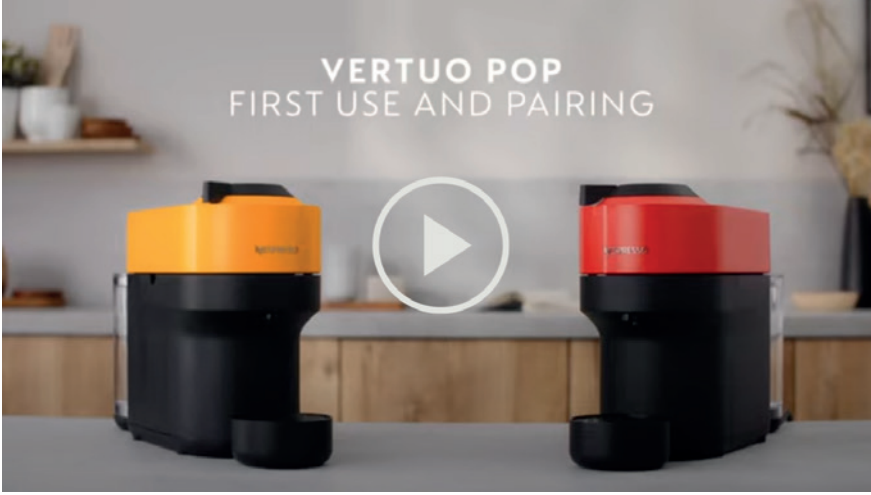

**١** قم أولاً بشطف وتنظيف خزان المياه والغطاء قبل ملئه بماء شرب عذب وطازج.

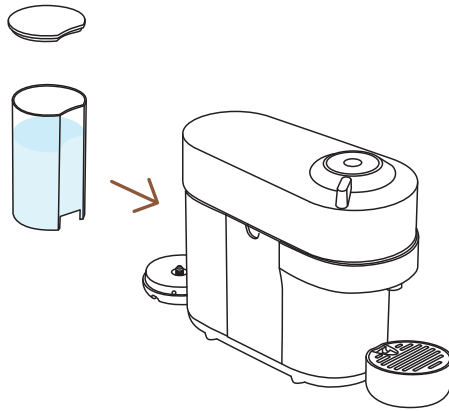

**٢** أغلق خزان المياه بالغطاء وضع خزان المياه في مكانه وتأكد من تركيبه بصورة صحيحة.

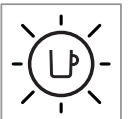
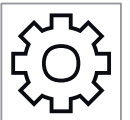
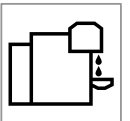
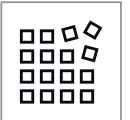
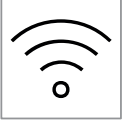

## إيقاف توصيل الجهاز بالبلوتوث او الوي فاي

تأتي الماكينة بوحدة اتصال تعمل تلقائياً. تتيح هذه الوحدة الوصول إلى ميزات إضافية تعزز تجربتك مع القهوة. لوقف وحدة الاتصال عن العمل، اتبع الخطوات التالية:

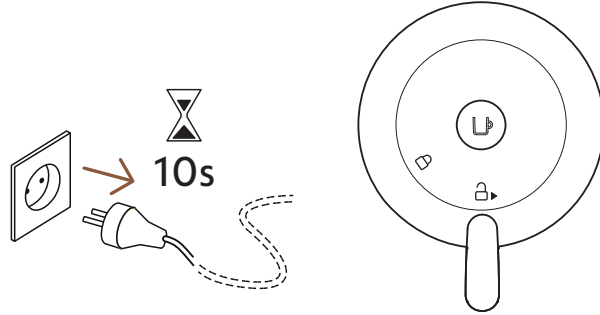

**1** بينما تكون الماكينة مطفاةً والمقبض في وضع "إلغاء القفل"، إفصل الماكينة وانتظر لمدة ١٠ ثوانٍ على الأقل.

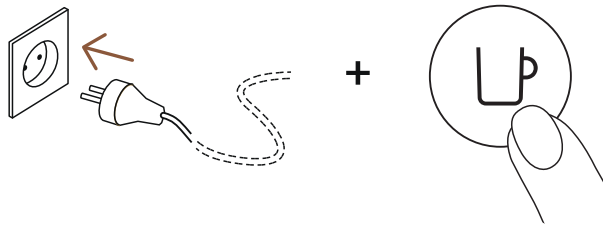

**٢** اضغط باستمرار على الزر أثناء التوصيل سيومض الزر باللون البرتقالي للتأكيد على أن وحدة الاتصال توقفت عن العمل.

**i** اتبع نفس الخطوات لإعادة تشغيل وحدة الاتصال مرة أخرى. سيومض الزر باللون الأبيض للتأكيد على أن وحدة الاتصال عادت لعملها.

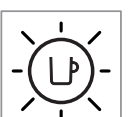
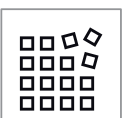

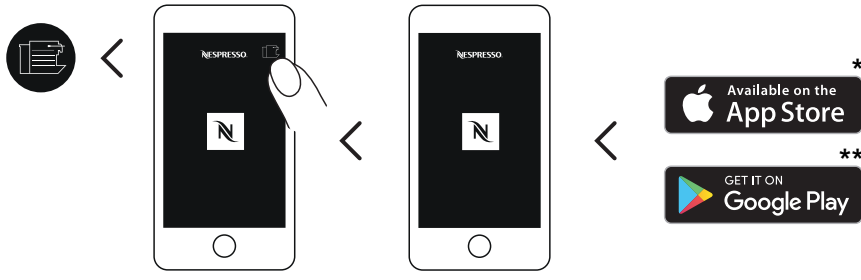

**١** قم بتنزيل أو تحديث **تطبيق** نسبريسو. شغل التطبيق **على** هاتفك المحمول أو الكمبيوتر اللوحي (تابلت). اضغط على رمز الماكينة أعلى يمين الشاشة.

**ملاحظة:** لتحصل على أفضل أداء للماكينة وتجربة سلسلة نوصي بتوصيل الماكينة مباشرة بالـ Wi-Fi بدلاً من استخدام ميزة هوتسبوت في الهاتف الذكي.

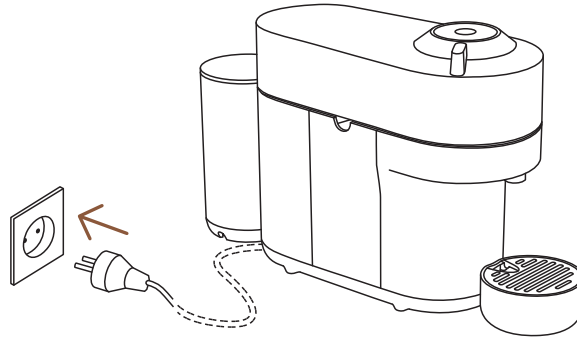

**٢** قم بتوصيل سلك الطاقة.



**٣** اتبع التعليمات على تطبيق **نسبريسو**.

**تحذير:** إقرأ احتياطات السلامة أولاً لتجنب خطر الحريق والصدمات الكهربائية. يرجى التأكد من تأريض الماكينة عند وصلها بالكهرباء.

\* Store App ® هي علامة تجارية مملوكة لشركة Inc Apple ، مسجلة في الولايات المتحدة وبلدان أخرى.  
\* Google LLC شركة تجاريتان عالمتان هما Google Play وشعار Google Play

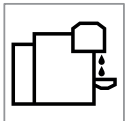

## الإتصال

حسب توفر هذه الميزة في البلد. لماذا يجب عليك إقران ماكينة فيرتو بوب

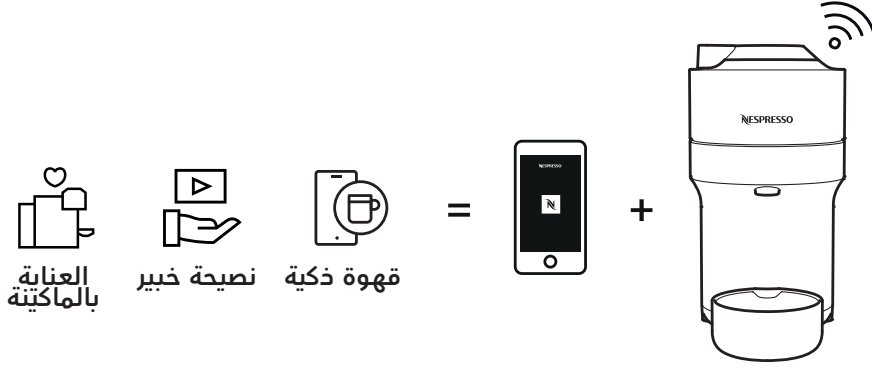

### فوائد وصل ماكينة فيرتو بوب بالانترنت

- **قهوة ذكية:** ابق دائماً في المقدمة لتحصل على أحدث ابتكارات القهوة من نسبريسو بتحديث **الماكينة** دائماً
- **نصيحة خبير:** احصل على الدعم ومقاطع الفيديو التعليمية المبسطة على هاتفك الذكي
- **العناية بالماكينة:** احصل على إشعار فوري حول كيفية وموعد صيانة الماكينة بفضل دليل سهل الخطوات لإزالة الترسبات والشطف والتنظيف وغيرها من الإجراءات المهمة لصحة الماكينة.

### كيف تصل ماكينة فيرتو بوب بالانترنت؟

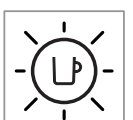
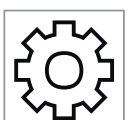
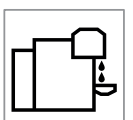
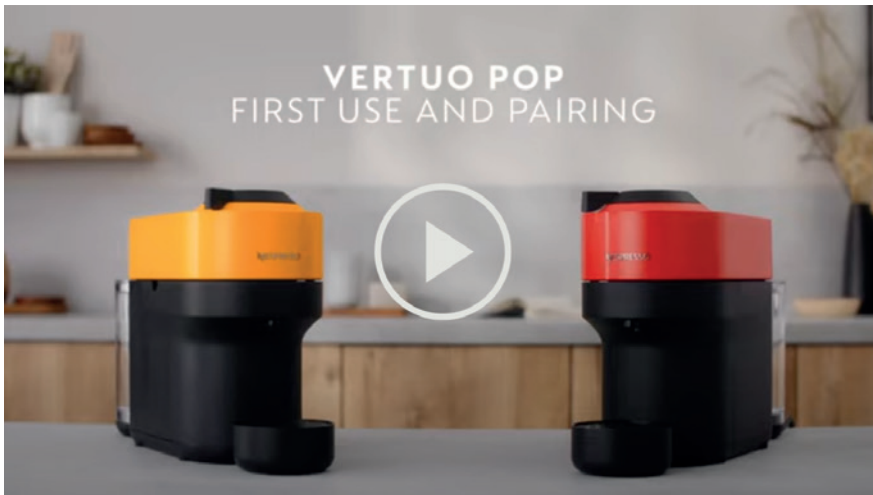

## تشغيل / إيقاف

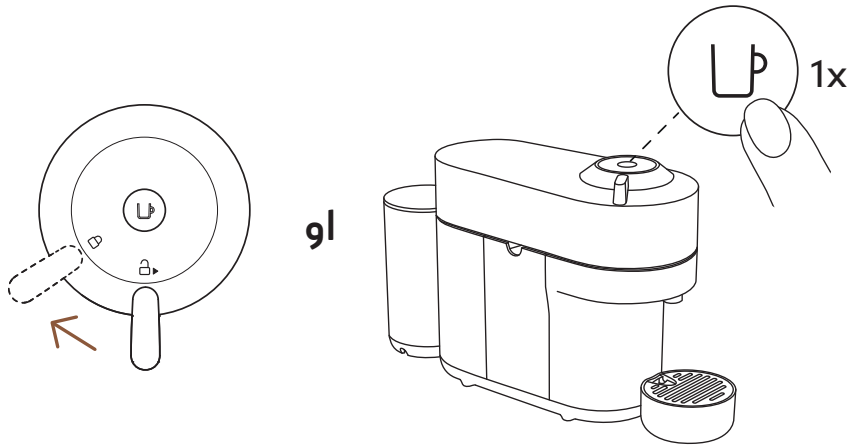

## تشغيل

بمجرد توصيل الماكينة بالكهرباء، قم بتشغيلها بالضغط على الزر مرة واحدة أو بإغلاق المقبض في وضع القفل (مع إغلاق الرأس).

**i** سيومض الضوء لمدة ٣٠ ثانية تقريباً بينما تسخن الماكينة. وستصبح الماكينة جاهزة للاستخدام عندما يصبح الضوء ثابتاً.

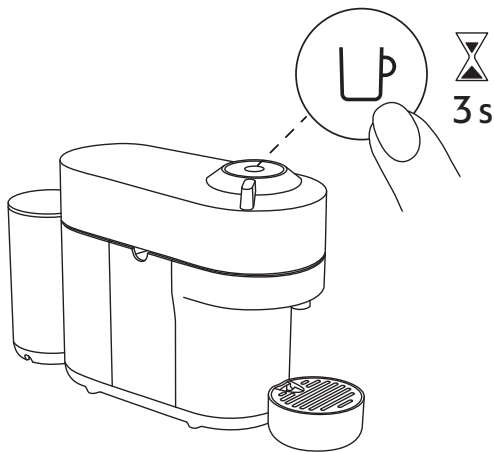

او  
وضع الترشيح البيئي: دقيقتان

## إيقاف

تطفئ الماكينة نفسها تلقائياً بعد دقيقتين من عدم الاستخدام لتوفير الطاقة.

**i** يمكن إطفاء الماكينة في أي وقت (عندما لا تكون قيد الاستخدام) بالضغط باستمرار على الزر لـ ٣ ثوان.

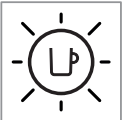
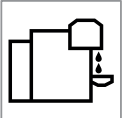
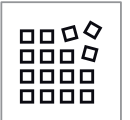
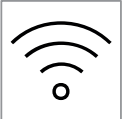

## فتح/إغلاق

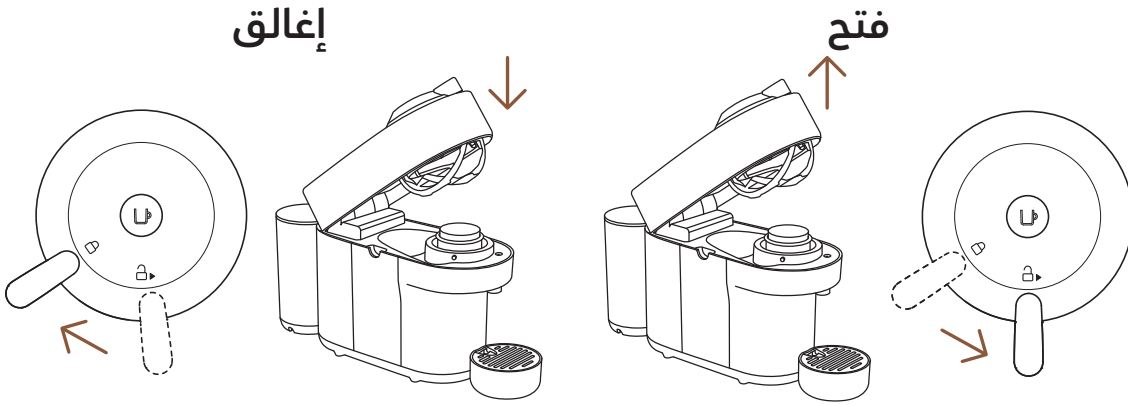

**تحذير:** لاستخدام صحيح للماكينة يرجى عدم فتح رأس الماكينة أثناء استخلاص القهوة، وانتظر حتى يعود زر القهوة إلى اللون الأبيض الثابت. إذا كنت ترغب في إيقاف عملية الاستخلاص قبل انتهائها، اضغط مرة واحدة على زر القهوة وانتظر حتى تتوقف عن العمل قبل فتح رأس الماكينة.

## نظام فيرتو

## توافق الكبسولة

XL	L	M	S
آتو، كولد برو ستايل (٣٥٥ مل / ١٢ أونصة سوائل)	ماج (٢٣٠ مل / ٧,٧٧ أونصة سوائل)	زر اسبريسو (٨٠ مل / ٢,٧ أونصة سوائل)	ريسترتو (٢٥ مل / ٠,٨٤ أونصة سوائل)
كاراف (٥٣٥ مل / ١٨,٨ أونصة سوائل)		گران لونغو (١٥٠ مل / ٥,٠٧ أونصة سوائل)	زر اسبريسو (٤٠ مل / ١,٣٥ أونصة سوائل)

## توافق الإكسسوارات



اكتشف مجموعتنا الكاملة من الإكسسوارات على موقعنا الإلكتروني

[www.buynespesso.com](http://www.buynespesso.com)

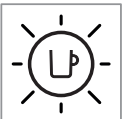
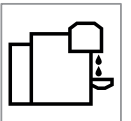
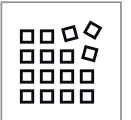
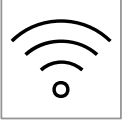

## ملخص

## أجزاء الماكينة

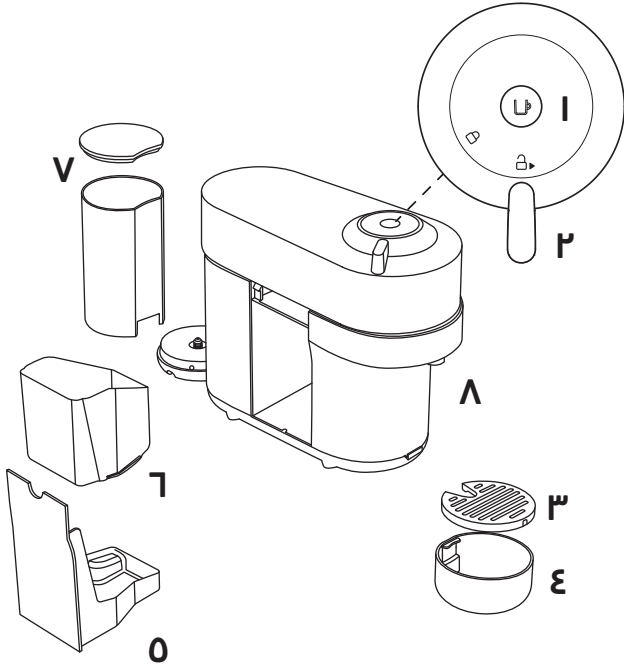

- |   |                           |
|---|---------------------------|
| ١ | زر تشغيل/إيقاف وزر القهوة |
| ٢ | قفل/تحرير المقبض          |
| ٣ | شبكة التقطير              |
| ٤ | حامل فنجان قابل للتعديل   |
| ٥ | صينية التقطير             |
| ٦ | دمة الكبسولات و           |
| ٧ | خزان الماء والغطاء        |
| ٨ | مخرج القهوة               |

## محتوى المغلف



- |   |                         |
|---|-------------------------|
| ١ | ماكينة قهوة             |
| ٢ | إرشادات السلامة         |
| ٣ | مواد ترحيبية من نسبريسو |
| ٤ | إرشادات السلامة         |
| ٥ | دليل خطوات البدء السريع |
| ٦ | الضمان                  |

٦ + ٥ + ٤

**فتح** العبوة : قد يوجد بعض الغبار على سطح الماكينة بسبب المواد المعاد تدويرها المستخدمة في العبوة. هذا ليس خطيرا ، ببساطة نظف بمنديل ناعم.

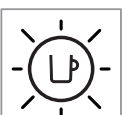



## تحذيرات السلامة

**تحذير:** يرجى قراءة إرشادات السلامة قبل البدء بتشغيل ماكينة القهوة  
لتجنب الأضرار والأعطال المحتملة.

### التخلص من الماكينة وحماية البيئة

يتوافق هذا الجهاز مع توجيه الاتحاد الأوروبي EC/19/2012. مواد التغليف والجهاز يحتويان على مواد قابلة لإعادة التدوير. يحتوي الجهاز على مواد يمكن استردادها أو إعادة تدويرها. لذلك ننصح بفصل أجزاء الماكينة وفقاً لأنواعها المختلفة حتى يسهل إعادة تدوير المواد الخام. أترك الجهاز عند نقطة الاستلام. يمكنك الحصول على المعلومات اللازمة حول التخلص من الجهاز أو تصريفه من السلطة المحلية في مكان إقامتك.

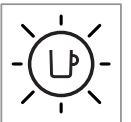
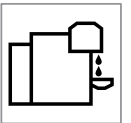
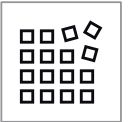
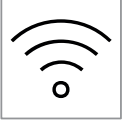

## انقر واختر اللغة

AR

تحذيرات السلامة	
ملخص	
وظائف الاتصال	
خطوات التركيب الأولى	
تحضير القهوة	
اضبط كمية القهوة	
تنظيف الماكينة	
إزالة الترسبات	
تفريغ الماكينة	
استعادة إعدادات المصنع	
دليل زر التشغيل	
استكشاف الأخطاء وإصلاحها	
المواصفات	

