

**NETGEAR®**

# User Manual

---

## Whole Home Tri-Band Mesh WiFi 7 System

### Models

RBE871: Orbi 11BE WiFi 7 Tri-band Router

RBE870: Orbi 11BE WiFi 7 Tri-band Satellite

January 2025  
202-12749-01

**NETGEAR, Inc.**

350 E. Plumeria Drive  
San Jose, CA 95134, USA

## Support and Community

Visit [netgear.com/support](https://netgear.com/support) to get your questions answered and access the latest downloads.

You can also check out our NETGEAR Community for helpful advice at [community.netgear.com](https://community.netgear.com).

## Regulatory and Legal

Si ce produit est vendu au Canada, vous pouvez accéder à ce document en français canadien à <https://www.netgear.com/support/download/>.

(If this product is sold in Canada, you can access this document in Canadian French at <https://www.netgear.com/support/download/>.)

For regulatory compliance information including the EU Declaration of Conformity, visit <https://www.netgear.com/about/regulatory/>.

See the regulatory compliance document before connecting the power supply.

For NETGEAR's Privacy Policy, visit <https://www.netgear.com/about/privacy-policy>.

By using this device, you are agreeing to NETGEAR's Terms and Conditions at <https://www.netgear.com/about/terms-and-conditions>. If you do not agree, return the device to your place of purchase within your return period.

Applicable to 6 GHz devices only: Only use the device indoors when the 6 GHz band is enabled. The operation of 6 GHz devices is prohibited on oil platforms, cars, trains, boats, and aircraft, except that operation of this device is permitted in large aircraft while flying above 10,000 feet. Operation of transmitters in the 5.925-7.125 GHz band is prohibited for control of or communications with unmanned aircraft systems.

## Trademarks

Trademarks© NETGEAR, Inc., NETGEAR, and the NETGEAR Logo are trademarks of NETGEAR, Inc. Any non-NETGEAR trademarks are used for reference purposes only.

## Revision History

Publication Part Number	Publish Date	Comments
202-12749-01	January 2025	First publication.

# Contents

## Chapter 1 Overview and Setup

- What is WiFi ?..... 10
- Orbi router overview..... 10
  - Orbi router hardware features..... 10
  - Orbi router LED behavior..... 12
- Orbi satellite overview..... 13
  - Orbi satellite hardware features..... 13
  - Orbi satellite LED behavior..... 14
- Router and satellite labels..... 15
- Connect your router..... 17
- Place your Orbi satellite..... 18
- Sync your Orbi satellite with your Orbi router..... 18
- Set up your satellite with a wired connection to your router..... 19
  - Set up and sync an Orbi satellite over a wired connection..... 19
  - Ethernet backhaul connections for multiple satellites..... 20

## Chapter 2 Connect to the Network and Access the Router

- Connect to the network..... 23
  - Wired connection..... 23
  - WiFi connection..... 23
  - WiFi connection using WPS..... 24
- Types of logins..... 24
- Set up and manage with the NETGEAR Orbi app..... 25
- Use a web browser to access the router..... 26
  - Use the automatic Internet setup option..... 26
  - Log in to the Orbi router web interface..... 27
- Change the language..... 28

## Chapter 3 Specify Your Internet Settings

- Manually set up the Internet connection..... 30
  - Specify an Internet connection without a login..... 30
  - Specify an Internet connection that uses a login..... 31
- Manage an IPv6 Internet connection..... 33
  - Types of IPv6 Internet connections..... 33
  - Requirements for entering IPv6 addresses..... 34
  - Specify IPv6 Internet connections..... 34
  - Use auto detection for an IPv6 Internet connection..... 35
  - Use auto configuration for an IPv6 Internet connection..... 36
  - Set up an IPv6 6to4 tunnel Internet connection..... 38

## Whole Home Tri-Band Mesh WiFi 7 System

Set up an IPv6 pass-through Internet connection.....	39
Set up an IPv6 fixed Internet connection.....	40
Set up an IPv6 DHCP Internet connection.....	41
Set up an IPv6 PPPoE Internet connection.....	43
Set up an IPv6 6rd tunnel Internet connection.....	44
Change the MTU size.....	46

### Chapter 4 Control Access to the Internet

Manage NETGEAR Armor.....	50
Network access control list.....	50
Enable the network access control list, set the access rule, and allow or block connected devices.....	51
Manage allowed devices currently not on the network.....	53
Manage blocked devices currently not on the network.....	54

### Chapter 5 Manage the WiFi Settings

About the WiFi networks.....	58
Manage the settings for the main WiFi network.....	58
Change the name of the main WiFi network.....	59
Change the 2.4 GHz or 5 GHz WiFi channel.....	59
Change the WiFi password or security option for the main WiFi network.....	60
Manage the IoT WiFi settings.....	61
Enable or disable the IoT network.....	61
Change the WiFi radio band for the IoT network.....	62
Change the WiFi network name for the IoT network.....	63
Change the WiFi password for the IoT network.....	63
Set up a guest WiFi network.....	64
Change your region.....	65
Enable or disable 20/40 MHz coexistence for the 2.4 GHz radio.....	66
Change the preamble mode for a radio.....	67
Change the transmission power control.....	68
Generate a new backhaul password.....	68
Use the router as a WiFi access point only.....	69

### Chapter 6 Specify Network Settings

View or change WAN settings.....	72
Manage Dynamic DNS.....	73
Set up a new Dynamic DNS account.....	73
Specify a Dynamic DNS account that you already created.....	74
Change the Dynamic DNS settings.....	75
Set up a default DMZ server.....	76
Change the router's device name.....	77
Change the LAN IP or RIP settings.....	77

## Whole Home Tri-Band Mesh WiFi 7 System

Use the router as a DHCP server.....	79
Disable the DHCP server feature in the router.....	80
Manage reserved LAN IP addresses.....	81
Reserve an IP address.....	81
Edit a reserved IP address.....	82
Delete a reserved IP address entry.....	83
Manage custom static routes.....	83
Set up a static route.....	84
Edit a static route.....	85
Delete a static route.....	86
Change the router back to router mode.....	86
Improve network connections with Universal Plug and Play.....	87
Set up a bridge for a port group or VLAN tag group.....	88
Set up a bridge for a port group.....	88
Set up a bridge for a VLAN tag group.....	89

### Chapter 7 Mantain and Monitor Your Network

Update the router and satellite firmware.....	93
Check for firmware updates.....	93
Manage automatic firmware updates.....	94
Manually update firmware.....	94
Manually update satellite firmware.....	95
Manually update router firmware.....	96
Change the admin password.....	97
Enable admin password reset.....	97
Reset the admin password.....	98
Always use HTTPS to access the router.....	99
View router status and usage information.....	100
Display Internet port statistics.....	100
Check the Internet connection status.....	101
View and manage logs of router activity.....	102
View devices connected to the network or edit device information.....	103
View devices connected to the network.....	103
Edit device information on the Attached Devices page.....	105
View satellites connected to the network or edit satellite information.....	105
View satellites connected to the network.....	106
Edit satellite information that displays on the Attached Devices page.....	106
View the satellite status.....	107
Monitor, meter, and control Internet traffic.....	108
Start the traffic meter without traffic volume restrictions.....	108
Restrict Internet traffic by volume.....	109

Restrict Internet traffic by connection time.....	110
View the Internet traffic volume and statistics.....	111
Unblock the traffic meter after the traffic limit is reached....	112
Change the NTP server.....	112
Set the time zone.....	113
Manage the router configuration file.....	114
Back up settings.....	114
Restore configuration settings.....	115
Erase the current configuration settings.....	115

**Chapter 8 Customize Internet Traffic Rules for Ports**

Manage port forwarding to a local server.....	118
Set up port forwarding to a local server.....	118
Add a custom port forwarding service.....	119
Edit a port forwarding service.....	120
Delete a port forwarding entry.....	121
How the router implements the port forwarding rule.....	121
Application example: Make a local web server public.....	122
Manage port triggering.....	122
Add a port triggering service.....	123
Edit a port triggering service.....	124
Disable port triggering or change the time-out period.....	125
Delete a port triggering service.....	126
Application example: Port triggering for Internet Relay Chat.	127

**Chapter 9 Use OpenVPN to Access Your Network**

About VPN connections.....	129
LAN IP addressing in VPN networks.....	129
Enable OpenVPN service in the router.....	130
Install OpenVPN software on a VPN client.....	131
Install OpenVPN software on a Windows-based computer..	132
Install OpenVPN software on a Mac computer.....	133
Install OpenVPN software on an iOS device.....	134
Install OpenVPN software on an Android device.....	135
Use VPN to access your Internet service at home.....	136
Allow VPN client Internet access in the router.....	136
Block VPN client Internet access in the router.....	137

**Chapter 10 Troubleshooting**

Quick tips.....	140
Sequence to restart your network.....	140
WiFi settings.....	140
Network settings.....	140
The router and satellites do not sync.....	141

## Whole Home Tri-Band Mesh WiFi 7 System

You cannot log in to the router.....	141
You cannot access the Internet.....	142
Troubleshoot Internet browsing.....	143
Troubleshoot PPPoE.....	143
Troubleshoot WiFi connectivity.....	144
Troubleshoot your network using the ping utility.....	145
Test the LAN path to your router.....	145
Test the path from your computer to a remote device.....	146

# 1

## Overview and Setup

---

The Whole Home Tri-Band WiFi 7 Mesh System creates dedicated high-speed WiFi 7 connections to your Internet service and provides three WiFi radios that operate simultaneously:

- One 2.4 GHz radio that supports IEEE 802.11be with 1024-QAM for a throughput of 688 Mbps
- One 5 GHz radio that support the new IEEE 802.11be standard with 4K-QAM and a 240 MHz channel width for a throughput of 8640 Mbps
- One 6 GHz radio that supports the new IEEE 802.11be standard with 4K-QAM and a 320 MHz channel width for a throughput of 11520 Mbps

The new WiFi 7 features allow the Whole Home Tri-Band WiFi 7 Mesh System to provide a total WiFi throughput of 21000 Mbps.

The Orbi router (model RBE871) connects to your modem or gateway. The Orbi satellite (model RBE870) extends the WiFi 7 signal throughout your home.

This manual describes how to manage your Whole Home Tri-Band WiFi 7 Mesh System from your Orbi router web interface. You can also manage your Orbi system from the NETGEAR Orbi app.

This chapter contains the following sections:

- [What is WiFi 7?](#)
- [Orbi router overview](#)
- [Orbi satellite overview](#)
- [Router and satellite labels](#)
- [Connect your router](#)
- [Place your Orbi satellite](#)
- [Sync your Orbi satellite with your Orbi router](#)
- [Set up your satellite with a wired connection to your router](#)



For more information about the topics covered in this manual, visit the support website at [netgear.com/support](http://netgear.com/support).

ⓘ **NOTE:** This manual might refer to the Orbi router (model RBE871) as the *router* and refer to the Orbi satellite (model RBE870) as the *satellite*.

# What is WiFi 7?

WiFi 7, also known as IEEE 802.11be Extremely High Throughput (EHT), is a next-generation WiFi standard. The new standard provides the capability for multi-gigabit (multi-gig) WiFi throughout the home with faster speeds, less interference, and better performance for high-bandwidth online activities.

New technologies in WiFi 7 provide the following benefits:

- 2.4 times faster speed than WiFi 6
- Double the maximum bandwidth for your devices
- Lower latency than WiFi 6
- A more reliable connection

For more information, visit the NETGEAR WiFi 7 page at [netgear.com/home/discover/wifi7](https://netgear.com/home/discover/wifi7).

## Orbi router overview

The following sections are an overview of the Orbi router hardware features and LED behavior.

## Orbi router hardware features

The following figures shows the Orbi router hardware features.

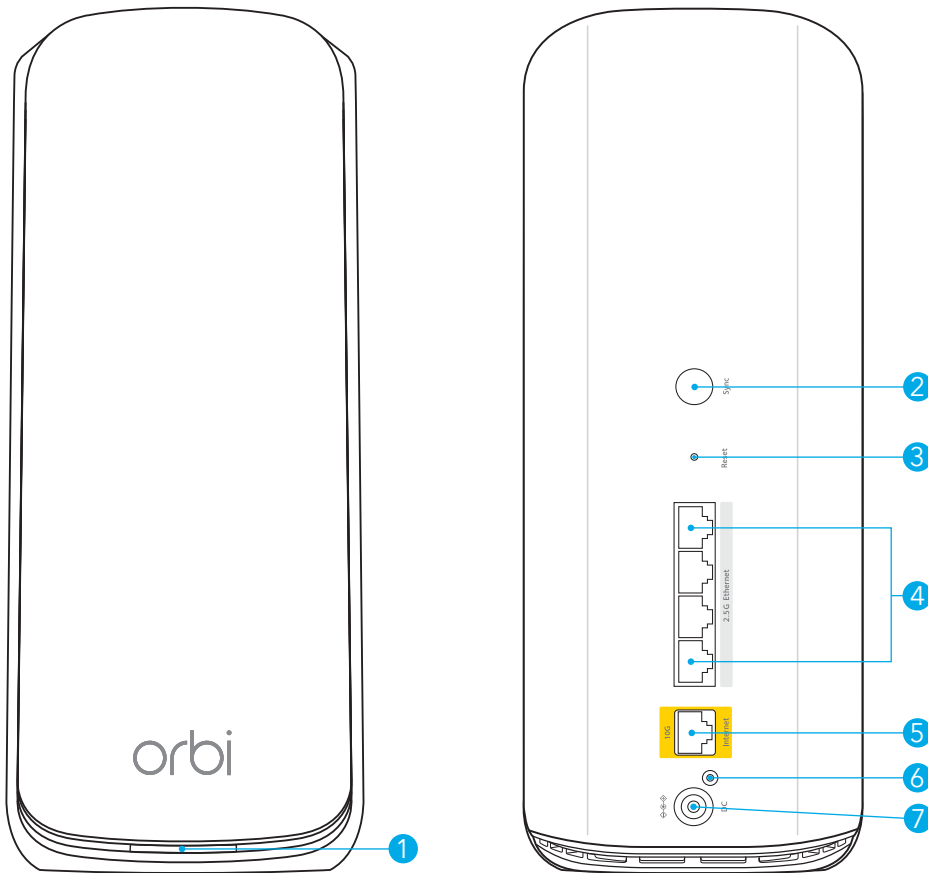

Figure 1. Orbi router front (left figure) and back (right figure) views

1. **Router LED:** Use the LED on the front of the router to determine its status. For more information about the LED behavior, see [Orbi router LED behavior](#) on page 12.
2. **Sync button:** Use the **Sync** button to connect a WPS device to the router. For more information, see [WiFi connection using WPS](#) on page 24.
3. **Reset button:** Use the **Reset** button to restart (reboot) the router or reset the router to its factory default settings:
  - **Restart the router:** Press the **Reset** button for less than five seconds. The Power LED lights solid amber and the router restarts.
  - **Reset the router to its factory default settings:** Press and hold the **Reset** button until the Power LED starts blinking amber. The router resets and returns to its factory settings.
4. **2.5G Multi-Gigabit LAN ports:** These Ethernet ports provide a wired connection speed of up to 2.5 Gigabit Ethernet (2.5GbE). You can connect a LAN device to each of the three ports, each of which support speeds up to 2.5 Gbps. You can also connect these ports to a 2.5 Gigabit Ethernet (2.5GbE) port on each satellite to create a wired

backhaul connection. For more information, see [Set up your satellite with a wired connection to your router](#) on page 19.

5. **10G Multi-Gigabit Internet port:** Connect your modem to this port and get up to 10 Gigabit Ethernet (10GbE) Internet speeds.
6. **Power LED:** For more information about the Power LED behavior, see [Orbi router LED behavior](#) on page 12.
7. **Power connector:** Connect the power adapter that came with your router to this port.

## Orbi router LED behavior

The Orbi router has an LED on the front and a Power LED on the back. The following table describes the LED behavior for the router's Power LED.

Table 1. Power LED behavior

LED color	Description
Solid green	Power is on.
Solid amber	The router is restarting.
Blinking amber	The router's firmware is resetting to its factory default settings.
Blinking red	The router's firmware is corrupted.
Off	Power is not supplied to the router

The following table describes the LED behavior for the router LED located on the front of the router.

Table 2. Router LED behavior

LED color	Description
Pulsing white	The router is powering up or the <b>Sync</b> button was pressed.
Solid white	The router is resetting to its factory default settings.
Solid magenta	The router is not connected to the Internet.
Off	The router is connected to the Internet and working normally.

# Orbi satellite overview

The following sections are an overview of the Orbi satellite hardware features and LED behavior.

## Orbi satellite hardware features

The following figures shows the Orbi satellite hardware features.

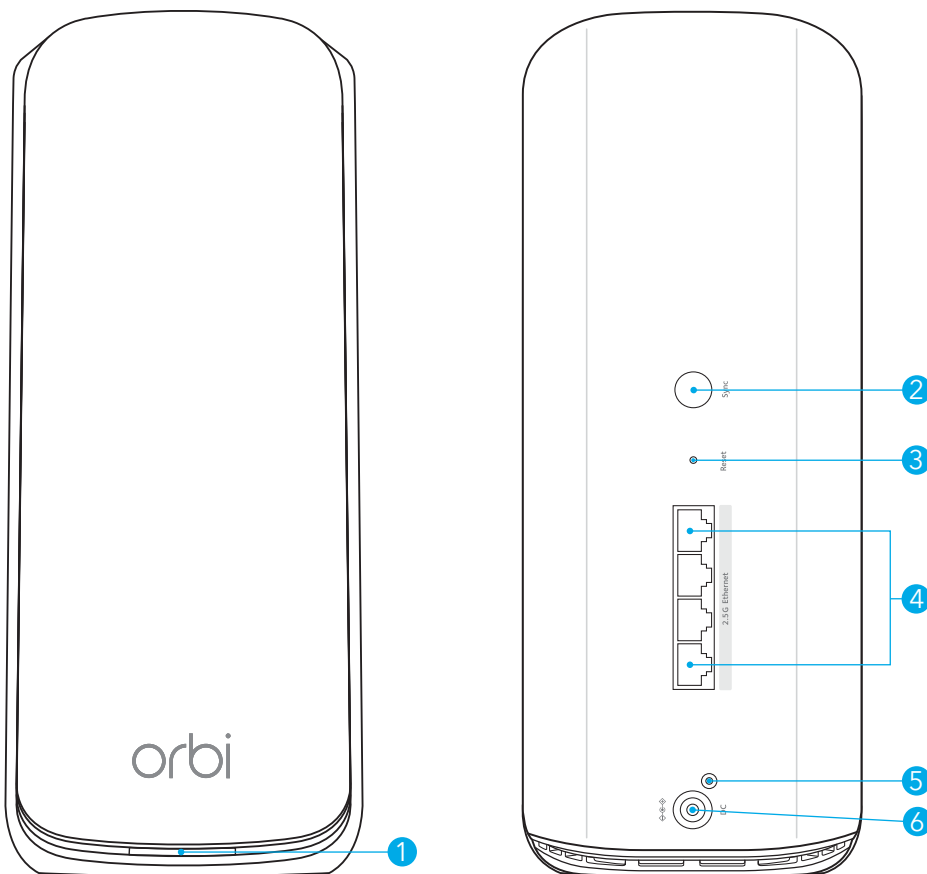

Figure 2. Orbi satellite front (left figure) and back (right figure) views

1. **Satellite LED:** Use the LED on the front of the router to determine its status. For more information about the LED behavior, see [Orbi satellite LED behavior](#) on page 14.
2. **Sync button:** Use the **Sync** button to connect the satellite to the router. For more information, see [Sync your Orbi satellite with your Orbi router](#) on page 18.

3. **Reset button:** Use the **Reset** button to restart (reboot) the satellite or reset the satellite to its factory default settings:
  - **Restart the satellite:** Press the **Reset** button for less than five seconds. The Power LED lights solid amber and the satellite restarts.
  - **Reset the satellite to its factory default settings:** Press and hold the **Reset** button until the Power LED starts blinking amber. The satellite resets and returns to its factory settings.
4. **2.5G Multi-Gigabit LAN ports:** These Ethernet ports provide a wired connection speed of up to 2.5 Gigabit Ethernet (2.5GbE). You can connect a LAN device to each of the two ports, each of which support speeds up to 2.5 Gbps. You can also connect this port to a 2.5 Gigabit Ethernet (2.5GbE) LAN port on the router to create a wired backhaul connection. For more information, see [Set up your satellite with a wired connection to your router](#) on page 19.
5. **Power LED:** For more information about the Power LED behavior, see [Orbi satellite LED behavior](#) on page 14.
6. **Power connector:** Connect the power adapter that came with your satellite to this port.

## Orbi satellite LED behavior

The Orbi satellite has an LED on the front and a Power LED on the back.

The following table describes the LED behavior for the satellite's Power LED.

Table 3. Power LED behavior

LED color	Description
Solid green	Power is on.
Solid amber	The satellite is restarting.
Blinking amber	The satellite's firmware is resetting to its factory default settings.
Blinking red	The satellite's firmware is corrupted.
Off	Power is not supplied to the satellite

The following table describes the LED behavior for the satellite LED located on the front of the satellite.

Table 4. Satellite LED behavior

LED color	Description
Pulsing white	The satellite is powering up.
Solid blue	The satellite connected to the router and the connection is good. The LED lights blue for three minutes and then turns off.
Solid amber	The satellite connected to the router and the connection is fair. The LED lights amber for three minutes and then turns off.
Solid magenta	The satellite failed to sync with the router.
Off	The satellite synced with the router and is working normally.

## Router and satellite labels

The Orbi router and satellite labels show the router's or satellite's MAC address and serial number. The label also includes a QR code that you can scan during setup to connect to the Orbi setup network. The labels are located on the bottom of the router

## Whole Home Tri-Band Mesh WiFi 7 System

and satellite. Following is an example of what the router or satellite label might look like:

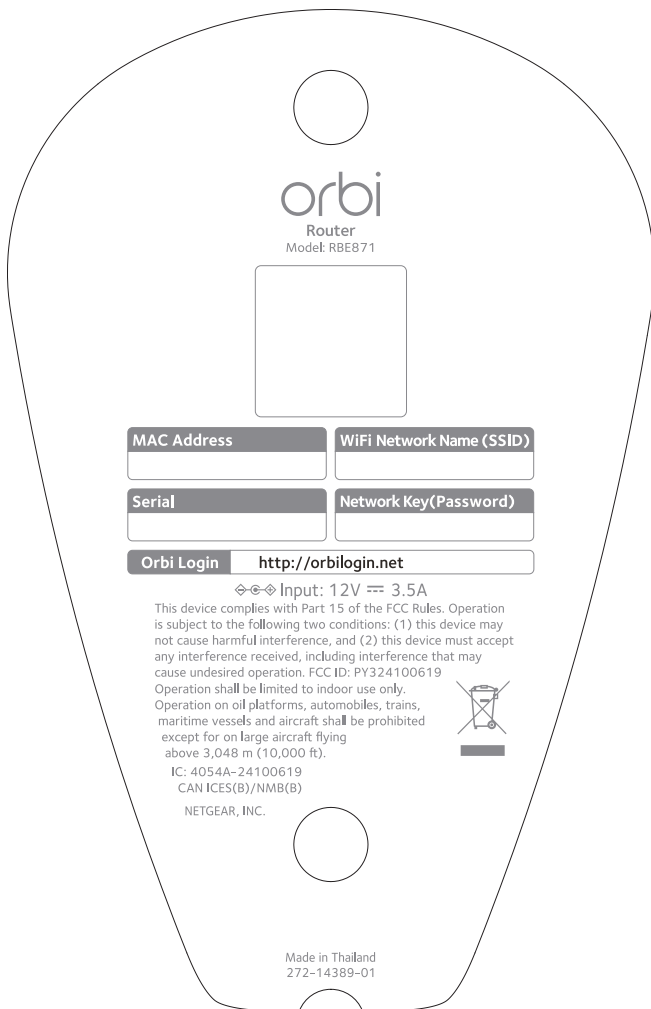



# Connect your router

**!** **NOTE:** If both your Internet service provider (ISP) and modem support a speed of 10 Gbps, the router's Internet connection also functions at 10 Gbps. Otherwise, the Internet connection functions at the maximum speed that is supported by both your ISP and your modem. (1 Gbps is a common speed.)

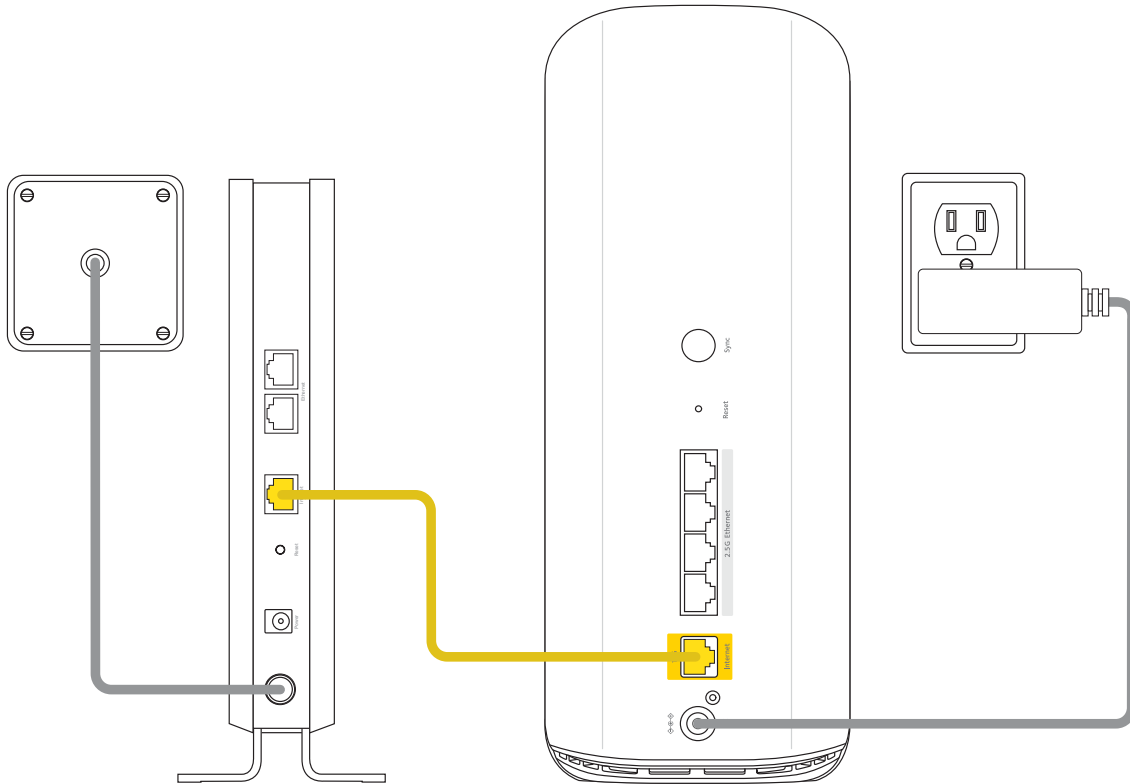

Figure 3. Connect the router to a modem

## To connect your router to a modem:

1. Unplug your modem's power, leaving the modem connected to the wall jack for your Internet service.
2. If your modem uses a battery backup, remove the battery.
3. Plug in and turn on your modem.
4. If your modem uses a battery backup, put the battery back in.
5. Connect your modem to the Internet port of your router with the Ethernet cable that came with your router.
6. (Optional) If your package comes with plug adapters for the power adapter, connect the plug adapter for your region to the power adapter.

❗ **NOTE:** For Singapore, use the 2-pin EU plug adapter or the 3-pin UK plug adapter only. Do not use the snap pin on the power adapter.

7. Connect the power adapter to your router and plug the power adapter into an outlet.
8. If the Power LED does not light, make sure that the power adapter is properly connected to your router and power outlet.

## Place your Orbi satellite

Your Orbi satellite must be within range of your Orbi router's WiFi signal for it to sync with your router. Use your satellite's LED to help you determine where to place your satellite. For more information about the satellite LED colors and behaviors, see [Orbi satellite LED behavior](#) on page 14.

❗ **NOTE:** The high-speed 6 GHz WiFi band has a shorter range than the 5 GHz band. This means that you must be closer to your router or satellites for complete 6 GHz coverage.

Because of this shorter range, 6 GHz WiFi routers and satellites must be positioned close to where you actually require the high-speed 6 GHz connection. We recommend that you avoid placing your router or satellites in places like your basement, attic, or closet.

## Sync your Orbi satellite with your Orbi router

The Orbi satellite that comes with your Orbi router is preset to automatically find and sync to your Orbi router's WiFi signal.

### To sync your satellite:

1. Place your satellite.

For more information, see [Place your Orbi satellite](#) on page 18.

2. Connect the satellite to a power source.

The satellite LED pulses white. The satellite automatically finds the Orbi router's WiFi signal and attempts to sync to the Orbi router.

The satellite LED lights one of the following colors:

- **Blue:** The Orbi router and satellite successfully synced, and the connection between the router and satellite is good.
  - **Amber:** The connection with the router is fair. We recommend that you move the Orbi satellite closer to the Orbi router and try again.
3. If the satellite LED lights magenta, do the following:
    - a. Unplug your Orbi satellite, move the satellite closer to the router.
    - b. Plug the satellite back in and wait two minutes for the LED to turn blue or amber.If you have trouble syncing the satellites, you can troubleshoot the connection. For more information, see [The router and satellites do not sync](#) on page 141.

# Set up your satellite with a wired connection to your router

Backhaul is a term for the communication performed between a mesh WiFi system's router and its satellites. Instead of using a WiFi backhaul connection between the router and the satellite, you can use a wired connection.

## Set up and sync an Orbi satellite over a wired connection

Your Orbi satellite automatically connects wirelessly to your Orbi router to create a wireless backhaul. Your satellite and router also support Ethernet backhaul, which means that you can use an Ethernet cable to connect your satellite to your router.

If your home has built-in Ethernet outlets in the rooms and the cables lead into the same physical network, you can also connect both your Orbi router and Orbi satellite to the Ethernet outlets and let them sync.

### **To set up and sync your Orbi satellite over a wired connection:**

1. Place your satellite in the room where you want WiFi service.
2. Connect an Ethernet cable to a 2.5G Ethernet port on the satellite.

3. Connect the other end of the Ethernet cable to a 2.5G Ethernet LAN port on the router.

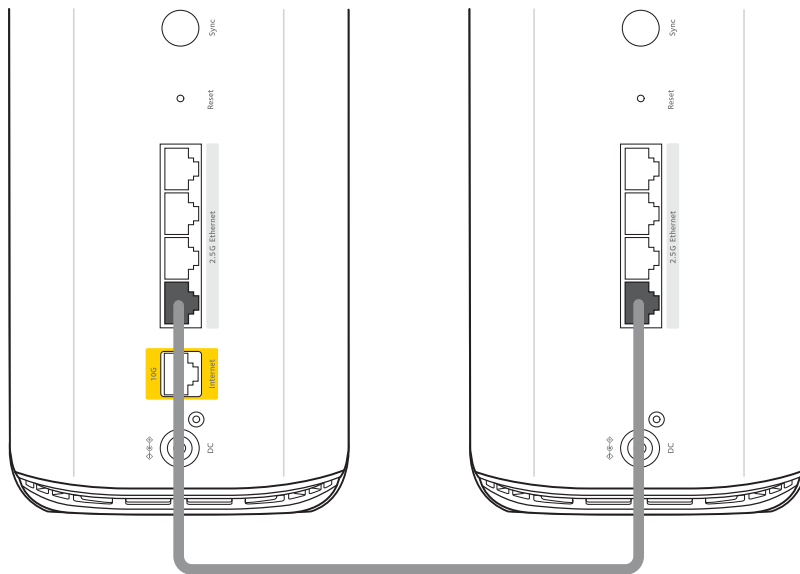

4. Connect the satellite to a power source.  
The Power LED on the back of the satellite lights green.  
The satellite LED pulses white. The satellite automatically syncs to the Orbi router.

**! NOTE:** The first time that you sync the satellite and the router, the sync process can take between five and ten minutes because the router might automatically update the satellite's firmware.

After the sync process is complete, the satellite LED lights blue for about three minutes and then turns off. Blue indicates that the router and satellite successfully synced and the wired connection between the router and satellite is good.

## Ethernet backhaul connections for multiple satellites

Your Orbi satellite automatically connects over WiFi to your Orbi router or another Orbi satellite to create a WiFi backhaul connection, or you can use an Ethernet cable to connect your satellite to your router or another satellite to create a wired backhaul connection.

**! NOTE:** The products shown in the following diagrams do not represent any particular Orbi models, but the topologies and setups in the diagrams do apply to your model.

## Whole Home Tri-Band Mesh WiFi 7 System

The following figure shows how to connect your Orbi satellites to your Orbi router using a star topology to create an Ethernet backhaul connection.

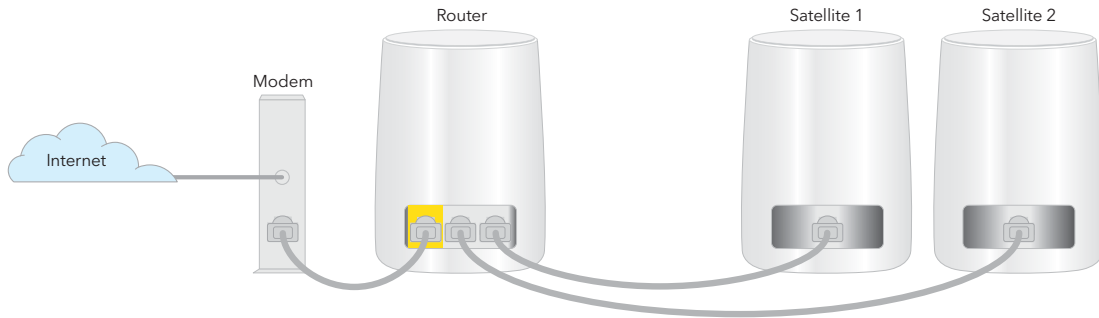

Figure 4. Star topology: Satellites connected to the router's Ethernet ports

The following figure shows another way to connect your Orbi satellites to your Orbi router using a daisy chain topology to create an Ethernet backhaul connection.

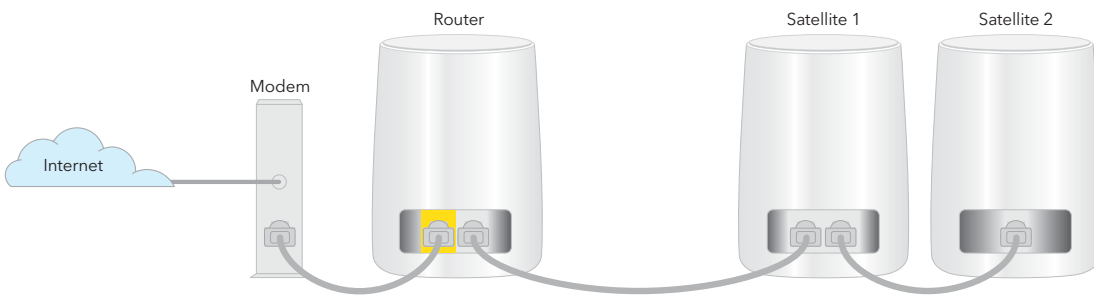

Figure 5. Daisy chain topology: Satellite 1 connected to router and satellite 2 connected to satellite 1

The following figure shows how to connect your Orbi satellites to your Orbi router through an Ethernet switch.

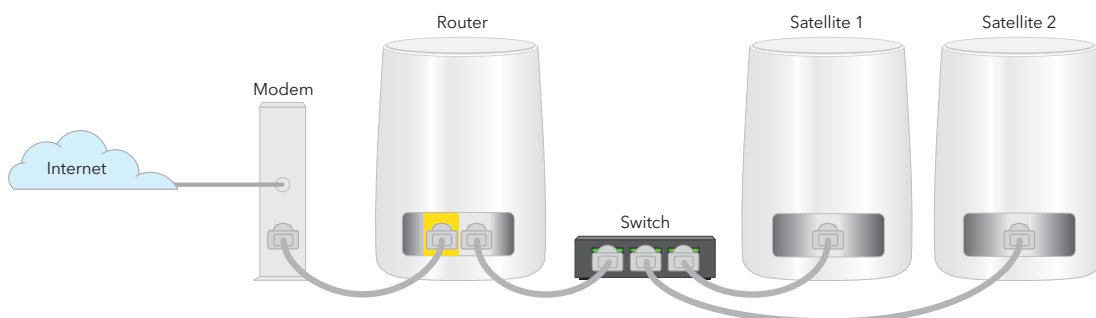

Figure 6. Ethernet backhaul connection using a switch

# 2

## Connect to the Network and Access the Router

---

This chapter contains the following sections:

- [Connect to the network](#)
- [Types of logins](#)
- [Set up and manage with the NETGEAR Orbi app](#)
- [Use a web browser to access the router](#)
- [Change the language](#)

# Connect to the network

You can connect to the Orbi network through a wired or WiFi connection. If you want to connect on a computer using a static IP address, change the settings so that it uses Dynamic Host Configuration Protocol (DHCP).

## Wired connection

You can connect your computer to the router using an Ethernet cable and join the router's local area network (LAN). The computer must have an Ethernet port.

### **To connect your computer to the router with an Ethernet cable:**

1. Make sure that the router is receiving power (its Power LED is lit).
2. Connect an Ethernet cable to an Ethernet port on your computer.
3. Connect the other end of the Ethernet cable to one of the router's Ethernet ports.

Your computer connects to the local area network (LAN). A message might display on your computer screen to notify you that an Ethernet cable is connected.

## WiFi connection

If you're installing your Orbi router for the first time, you can connect to the router's WiFi network by scanning the QR code on your router with the camera app on your mobile device. To scan the QR code with your camera app, your mobile device must have iOS version 11 or later or Android version 10 or later.

You can also manually find and select the Orbi router's WiFi network from your WiFi-enabled computer or mobile device.

### **To find and select the WiFi network:**

1. Make sure that the router or satellite is receiving power (its Power LED is lit).
2. On your WiFi-enabled computer or mobile device, find and select the WiFi network.

The WiFi network name is on the router label. The WiFi network name is the same for the router and the satellite in the Orbi WiFi System.

**!** **NOTE:** If you bought the router and the satellite separately, their default WiFi network names are different. Use the router's WiFi network name during initial setup.

3. Join the WiFi network and enter the WiFi password.

The password is on the router label.

Your WiFi-enabled computer or mobile device connects to the WiFi network.

## WiFi connection using WPS

You can connect to the router's WiFi network with Wi-Fi Protected Setup (WPS) or you can find and select the WiFi network.

### To use WPS to connect to the WiFi network:

1. Make sure that the router is receiving power (its Power LED is lit).
2. Check the WPS instructions for your computer or WiFi device.
3. Press the **Sync** button on the router.
4. Within two minutes, on your WiFi-enabled computer or mobile device, press its **WPS** button or follow its instructions for WPS connections.

Your computer or mobile device connects to the WiFi network.

## Types of logins

Separate types of logins serve different purposes. It is important that you understand the difference so that you know which login to use when.

Types of logins:

- **ISP login:** The login that your Internet service provider (ISP) gave you logs you in to your Internet service. Your service provider gave you this login information in a letter or some other way. If you cannot find this login information, contact your service provider.
- **WiFi network name and network key:** Your router and satellite are preset with the same WiFi network name (SSID) and network key (password) for WiFi access. This information is on the router label and the satellite label.
- **NETGEAR account login:** The free NETGEAR account that you need to register your router and manage your subscriptions. If you do not have a NETGEAR account, you can create one using the NETGEAR Orbi app.
- **Router login:** This logs you in to the router web interface from a web browser as the router administrator (admin).



# Set up and manage with the NETGEAR Orbi app

You can use the NETGEAR Orbi app to set up and access your Orbi network.

To find the app, scan a QR code or search for NETGEAR Orbi in the Apple App Store or Google Play Store.

For more information about the Orbi app, visit <https://www.netgear.com/home/apps-services/orbi-app>.



**!** **NOTE:** If you do not want to use the NETGEAR Orbi app, you can use the Orbi router web interface to set up your Orbi devices. For more information about how to access your Orbi router web interface, see [Use a web browser to access the router](#) on page 26.

## To set up your Orbi WiFi system with the Orbi app:

1. Download the NETGEAR Orbi app on your mobile device.
2. On your mobile device, open the WiFi connection manager.
3. Locate and connect your mobile device to your Orbi WiFi network.  
Your preset Orbi WiFi network and password is on the Orbi router label. You can change the WiFi credentials after setup.
4. Launch the Orbi app and follow the setup instructions.

# Use a web browser to access the router

When you connect to the network (either with WiFi or with an Ethernet cable), you can use a web browser to access the router to view or change its settings. The first time you access the router, the NETGEAR installation assistant automatically checks to see if your router can connect to your Internet service.

## Use the automatic Internet setup option

You can set up your router automatically, or you can use a web browser to access the router and set up your router manually. Before you start the setup process, get your ISP information and make sure that the computers and devices in your WiFi network use the settings described here.

When your Internet service starts, your Internet service provider (ISP) typically gives you all the information needed to connect to the Internet. For DSL service, you might need the following information to set up your router:

- The ISP configuration information for your DSL account
- ISP login name and password
- Fixed or static IP address settings (special deployment by ISP; this setting is rare)

If you cannot locate this information, ask your ISP to provide it. When your Internet connection is working, you no longer need to launch the ISP login program on your computer to access the Internet. When you start an Internet application, your router automatically logs you in.

Installation and basic setup takes about 15 minutes to complete.

### **To automatically set up your router:**

1. Power on your router.
2. Make sure that your WiFi-enabled computer or mobile device is connected to the router with an Ethernet cable (wired) or wirelessly with the preset WiFi security settings listed on the label.

**!** **NOTE:** If you want to change the router's WiFi settings, use a wired connection so that you won't be disconnected when the new WiFi settings take effect.

3. Launch a web browser.

The page that displays depends on whether you accessed the router before:

- The first time that you set up the Internet connection for your router, the browser goes to **orbilogin.com** (Windows and Android devices) or **orbilogin.local** (Apple MacOS and iOS devices), and the Orbi login page displays.
- If you already set up the Internet connection, enter **orbilogin.com** (Windows and Android devices) or **orbilogin.local** (Apple MacOS and iOS devices) in the address field for your browser to start the installation process.

The page that displays recommends that you use the Orbi app. However, the current procedure describes how you can use the Orbi router web interface.

4. Scroll down and click the **If you don't have a compatible smartphone, click here** link.

The Welcome to Orbi page displays.

5. Follow the onscreen instructions.

The router connects to the Internet.

6. If the browser does not display the web page, do the following:
  - Make sure that the computer is connected to one of the LAN Ethernet ports or over WiFi to the router.
  - Make sure that the router is receiving power, and that its Power LED is lit.
  - Close and reopen the browser or clear the browser cache.
  - Browse to **orbilogin.com** (Windows and Android devices) or **orbilogin.local** (Apple MacOS and iOS devices).
  - If the computer is set to a static or fixed IP address (this setting is uncommon), change it to obtain an IP address automatically from the router.
7. If the router does not connect to the Internet, do the following:
  - Review your settings.
  - Make sure that you selected the correct options and typed everything correctly.
  - Contact your ISP to verify that you are using the correct configuration information.
  - See [Troubleshooting](#) on page 139.

If problems persist, register your NETGEAR product and contact NETGEAR technical support.

## Log in to the Orbi router web interface

When you log in to the Orbi, the browser displays the router web interface. You can use the router web interface to change the router or satellite settings.

### To log in to your Orbi:

1. Launch a web browser from a computer or mobile device that is connected to your Orbi network.
2. Enter **orbilogin.com** (Windows and Android devices) or **orbilogin.local** (Apple MacOS and iOS devices).  
A login window displays.
3. Enter the Orbi admin user name and password.  
The user name is **admin**. The password is the one that you specified when you set up your Orbi. The user name and password are case-sensitive.  
The BASIC Home page displays.

## Change the language

By default, the Auto setting uses your region to automatically set the language that displays when you log in to the router web interface.

### To change the language:

1. Launch a web browser from a computer or mobile device that is connected to your Orbi network.
2. Enter **orbilogin.com** (Windows and Android devices) or **orbilogin.local** (Apple MacOS and iOS devices).  
A login window displays.
3. Enter the Orbi admin user name and password.  
The user name is **admin**. The password is the one that you specified when you set up your Orbi. The user name and password are case-sensitive.  
The BASIC Home page displays.
4. In the upper right corner, select a language from the menu.
5. When prompted, click the **OK** button to confirm this change.  
The page refreshes with the language that you selected.

# 3

## Specify Your Internet Settings

---

Usually, the quickest way to set up the router to use your Internet connection is to allow Orbi to detect the Internet connection when you first access the router with a web browser. You can also customize or specify your Internet settings.

This chapter contains the following sections:

- [Manually set up the Internet connection](#)
- [Manage an IPv6 Internet connection](#)
- [Change the MTU size](#)

# Manually set up the Internet connection

You can view or change the router's Internet connection settings.

## Specify an Internet connection without a login

### To specify the Internet connection settings:

1. Launch a web browser from a computer or mobile device that is connected to your Orbi network.
2. Enter **orbilogin.com** (Windows and Android devices) or **orbilogin.local** (Apple MacOS and iOS devices).  
A login window displays.
3. Enter the Orbi admin user name and password.  
The user name is **admin**. The password is the one that you specified when you set up your Orbi. The user name and password are case-sensitive.  
The BASIC Home page displays.
4. Select **Internet**.  
The Internet Setup page displays.
5. Leave the Does your Internet connection require a login **No** radio button selected.
6. If your Internet connection requires an account name or host name, do the following:
  - a. In the Account Name section, click the **Edit** button.
  - b. Enter the account name.  
By default, the account name is the model number of the router.
  - c. Click the **Apply** button.
  - d. Select **Internet**.  
The Internet Setup page displays again.
7. If your Internet connection requires a domain name, type it in the **Domain Name (If Required)** field.  
For the other sections in this page, the default settings usually work, but you can change them.

8. Select an Internet IP Address radio button:
  - **Get Dynamically from ISP:** Your ISP uses DHCP to assign your IP address. Your ISP automatically assigns these addresses.
  - **Use Static IP Address:** Enter the IP address, IP subnet mask, and gateway IP address that your ISP assigned. The gateway is the ISP router to which your router connects.
9. Select a Domain Name Server (DNS) Address radio button:
  - **Get Automatically from ISP:** Your ISP uses DHCP to assign your DNS servers. Your ISP automatically assigns this address.
  - **Use These DNS Servers:** If you know that your ISP requires specific servers, select this option. Enter the IP address of your ISP's primary DNS server. If a secondary DNS server address is available, enter it also.
10. Select a Router MAC Address radio button:
  - **Use Default Address:** Use the default MAC address.
  - **Use Computer MAC Address:** The router captures and uses the MAC address of the computer that you are now using. You must use the one computer that the ISP allows.
  - **Use This MAC Address:** Enter the MAC address that you want to use.
11. In the **Vendor Class Identifier String (option 60)** field, enter the vendor class identifier (VCI) string, as indicated by your ISP.

If your ISP did not provide you with a VCI string, leave this field blank.
12. In the **Client Identifier String (option 61)** field, enter the client identifier (client ID) string, as indicated by your ISP.

If your ISP did not provide you with a client ID string, leave this field blank.
13. Click the **Apply** button.

Your settings are saved.
14. Click the **Test** button to test your Internet connection.

## Specify an Internet connection that uses a login

### To view or change the basic Internet setup:

1. Launch a web browser from a computer or mobile device that is connected to your Orbi network.
2. Enter **orbilogin.com** (Windows and Android devices) or **orbilogin.local** (Apple MacOS and iOS devices).

A login window displays.

3. Enter the Orbi admin user name and password.

The user name is **admin**. The password is the one that you specified when you set up your Orbi. The user name and password are case-sensitive.

The BASIC Home page displays.

4. Select **Internet**.

The Internet Setup page displays.

5. Select the Does your Internet connection require a login **Yes** radio button.

The page adjusts.

6. From the **Internet Service Provider** menu, select the encapsulation method:

The selections are **PPPoE**, **PPTP**, or **L2TP**.

7. In the **Login** field, enter the login name your ISP gave you.

This login name is often an email address.

8. In the **Password** field, type the password that you use to log in to your Internet service.

9. If your ISP requires a service name, type it in the **Service Name (if Required)** field.

10. From the **Connection Mode** menu, select **Always On**, **Dial on Demand**, or **Manually Connect**.

11. To change the number of minutes until the Internet login time out, in the **Idle Timeout (In minutes)** field, type the number of minutes.

This is how long the router keeps the Internet connection active when no one on the network is using the Internet connection. A value of 0 (zero) means never log out.

12. Select an Internet IP Address radio button:

- **Get Dynamically from ISP:** Your ISP uses DHCP to assign your IP address. Your ISP automatically assigns these addresses.
- **Use Static IP Address:** Enter the IP address, IP subnet mask, and gateway IP address that your ISP assigned. The gateway is the ISP router to which your router connects.

13. Select a Domain Name Server (DNS) radio button:

- **Get Automatically from ISP:** Your ISP uses DHCP to assign your DNS servers. Your ISP automatically assigns this address.
- **Use These DNS Servers:** If you know that your ISP requires specific servers, select this option. Enter the IP address of your ISP's primary DNS server. If a secondary DNS server address is available, enter it also.

14. Select a Router MAC Address radio button:



- **Use Default Address:** Use the default MAC address.
- **Use Computer MAC Address:** The router captures and uses the MAC address of the computer that you are now using. You must use the one computer that the ISP allows.
- **Use This MAC Address:** Enter the MAC address that you want to use.

15. Click the **Apply** button.

Your settings are saved.

16. Click the **Test** button to test your Internet connection.

# Manage an IPv6 Internet connection

The router supports many different types of IPv6 Internet connections for which you can specify the settings manually.

## Types of IPv6 Internet connections

The router can support an IPv6 Internet connection through the following connection types:

- **Auto Detect:** See [Use auto detection for an IPv6 Internet connection](#) on page 35.
- **Auto Config:** See [Use auto configuration for an IPv6 Internet connection](#) on page 36.
- **6to4 tunnel:** See [Set up an IPv6 6to4 tunnel Internet connection](#) on page 38.
- **Pass-through:** See [Set up an IPv6 pass-through Internet connection](#) on page 39.
- **Fixed:** See [Set up an IPv6 fixed Internet connection](#) on page 40.
- **DHCP:** See [Set up an IPv6 DHCP Internet connection](#) on page 41.
- **PPPoE:** See [Set up an IPv6 PPPoE Internet connection](#) on page 43.
- **6rd:** See [Set up an IPv6 6rd tunnel Internet connection](#) on page 44.

Which connection type you must use depends on your IPv6 ISP. Follow the directions that your IPv6 ISP gave you.

- If you are not sure what type of IPv6 connection the router uses, use the Auto Detect connection type, which lets the router detect the IPv6 type that is in use (see [Use auto detection for an IPv6 Internet connection](#) on page 35).
- If your ISP did not provide details, use the 6to4 tunnel connection type (see [Set up an IPv6 6to4 tunnel Internet connection](#) on page 38).

When you enable IPv6 and select any connection type other than IPv6 pass-through, the router starts the stateful packet inspection (SPI) firewall function on the WAN interface. The router creates connection records and checks every inbound IPv6 packet. If the router does not expect to receive such a packet, or the packet is not in the connection record, the router blocks this packet.

## Requirements for entering IPv6 addresses

IPv6 addresses are denoted by eight groups of hexadecimal quartets that are separated by colons. You can reduce any four-digit group of zeros within an IPv6 address to a single zero or omit it.

All of the following examples specify the *same* IPv6 address:

- 2001:db8:0000:0000:020f:24ff:febf:dbcb
- 2001:db8:0:0:20f:24ff:febf:dbcb
- 2001:db8::20f:24ff:febf:dbcb
- 2001:db8:0:0:20f:24ff:128.141.49.32

The following errors invalidate an IPv6 address:

- More than eight groups of hexadecimal quartets
- More than four hexadecimal characters in a quartet
- More than two colons in a row

## Specify IPv6 Internet connections

You can set up an IPv6 Internet connection if the router does not detect it automatically.

### To set up an IPv6 Internet connection:

1. Launch a web browser from a computer or mobile device that is connected to your Orbi network.
2. Enter **orbilogin.com** (Windows and Android devices) or **orbilogin.local** (Apple MacOS and iOS devices).  
A login window displays.
3. Enter the Orbi admin user name and password.  
The user name is **admin**. The password is the one that you specified when you set up your Orbi. The user name and password are case-sensitive.  
The BASIC Home page displays.
4. Select **ADVANCED > Advanced > IPv6**.

The IPv6 page displays.

5. From the **Internet Connection Type** menu, select the IPv6 connection type.
  - If you are not sure, select **Auto Detect** so that the router detects the IPv6 type that is in use.
6. Click the **Apply** button.

Your settings are saved.

## Use auto detection for an IPv6 Internet connection

### To set up an IPv6 Internet connection through auto detection:

1. Launch a web browser from a computer or mobile device that is connected to your Orbi network.
2. Enter **orbilogin.com** (Windows and Android devices) or **orbilogin.local** (Apple MacOS and iOS devices).

A login window displays.
3. Enter the Orbi admin user name and password.

The user name is **admin**. The password is the one that you specified when you set up your Orbi. The user name and password are case-sensitive.

The BASIC Home page displays.
4. Select **ADVANCED > Advanced > IPv6**.

The IPv6 page displays.
5. From the **Internet Connection Type** menu, select **Auto Detect**.

The page adjusts.

The router automatically detects the information in the following fields:

  - **Connection Type:** This field indicates the connection type that is detected.
  - **Router's IPv6 Address on WAN:** This field shows the IPv6 address that is acquired for the router's WAN (or Internet) interface. The number after the slash (/) is the length of the prefix, which is also indicated by the underline ( ) under the IPv6 address. If no address is acquired, the field displays Not Available.
  - **Router's IPv6 Address on LAN:** This field shows the IPv6 address that is acquired for the router's LAN (or local network) interface. The number after the slash (/) is the length of the prefix, which is also indicated by the underline ( ) under the IPv6 address. If no address is acquired, the field displays Not Available.
6. Select an **IP Address Assignment** radio button:

- **Use DHCP Server:** This method passes more information to LAN devices, but some IPv6 systems might not support the DHCv6 client function.
- **Auto Config:** This is the default setting.

This setting specifies how the router assigns IPv6 addresses to the devices on your home network (the LAN).

7. (Optional) Select the **Enable RIPng** check box.

This selection enables RIP Next Generation (RIPng) on IPv6 Internet connections. RIPng is an extension of Routing Information Protocol (RIP) that supports IPv6. You might want to enable RIPng if you are an advanced user with a complex home network configuration that requires dynamic routing.

8. (Optional) Select the **Use This Interface ID** check box and specify the interface ID to be used for the IPv6 address of the router's LAN interface.

If you do not specify an ID here, the router generates one automatically from its MAC address.

9. Click the **Apply** button.

Your settings are saved.

## Use auto configuration for an IPv6 Internet connection

### To set up an IPv6 Internet connection through auto configuration:

1. Launch a web browser from a computer or mobile device that is connected to your Orbi network.
2. Enter **orbilogin.com** (Windows and Android devices) or **orbilogin.local** (Apple MacOS and iOS devices).

A login window displays.

3. Enter the Orbi admin user name and password.

The user name is **admin**. The password is the one that you specified when you set up your Orbi. The user name and password are case-sensitive.

The BASIC Home page displays.

4. Select **ADVANCED > Advanced > IPv6**.

The IPv6 page displays.

5. From the **Internet Connection Type** menu, select **Auto Config**.

The page adjusts.

The router automatically detects the information in the following fields:

- **Router's IPv6 Address on WAN:** This field shows the IPv6 address that is acquired for the router's WAN (or Internet) interface. The number after the slash (/) is the length of the prefix, which is also indicated by the underline ( ) under the IPv6 address. If no address is acquired, the field displays Not Available.
  - **Router's IPv6 Address on LAN:** This field shows the IPv6 address that is acquired for the router's LAN (or local network) interface. The number after the slash (/) is the length of the prefix, which is also indicated by the underline ( ) under the IPv6 address. If no address is acquired, the field displays Not Available.
6. (Optional) In the **DHCP User Class (If Required)** field, enter a host name.  
Most people can leave this field blank, but if your ISP gave you a specific host name, enter it here.
  7. (Optional) In the **DHCP Domain Name (If Required)** field, enter a domain name.  
You can type the domain name of your IPv6 ISP. Do not enter the domain name for the IPv4 ISP here. For example, if your ISP's mail server is mail.xxx.yyy.zzz, type xxx.yyy.zzz as the domain name. If your ISP provided a domain name, type it in this field. For example, Earthlink Cable might require a host name of home, and Comcast sometimes supplies a domain name.
  8. Select an **IPv6 Domain Name Server (DNS) Address** radio button:
    - **Get Automatically from ISP:** Your ISP uses DHCP to assign your DNS servers. Your ISP automatically assigns this address.
    - **Use These DNS Servers:** If you know that your ISP requires specific servers, select this option. Enter the IP address of your ISP's primary DNS server. If a secondary DNS server address is available, enter it also.
  9. Select an **IP Address Assignment** radio button:
    - **Use DHCP Server:** This method passes more information to LAN devices, but some IPv6 systems might not support the DHCv6 client function.
    - **Auto Config:** This is the default setting.
  10. (Optional) Select the **Enable RIPng** check box.  
This selection enables RIP Next Generation (RIPng) on IPv6 Internet connections. RIPng is an extension of Routing Information Protocol (RIP) that supports IPv6. You might want to enable RIPng if you are an advanced user with a complex home network configuration that requires dynamic routing.
  11. (Optional) Select the **Use This Interface ID** check box and specify the interface ID that you want to be used for the IPv6 address of the router's LAN interface.  
If you do not specify an ID here, the router generates one automatically from its MAC address.
  12. Click the **Apply** button.  
Your settings are saved.
-

# Set up an IPv6 6to4 tunnel Internet connection

The remote relay router is the device to which your router creates a 6to4 tunnel. Make sure that the IPv4 Internet connection is working before you apply the 6to4 tunnel settings for the IPv6 connection.

## To set up an IPv6 Internet connection by using a 6to4 tunnel:

1. Launch a web browser from a computer or mobile device that is connected to your Orbi network.
2. Enter **orbilogin.com** (Windows and Android devices) or **orbilogin.local** (Apple MacOS and iOS devices).

A login window displays.

3. Enter the Orbi admin user name and password.

The user name is **admin**. The password is the one that you specified when you set up your Orbi. The user name and password are case-sensitive.

The BASIC Home page displays.

4. Select **ADVANCED > Advanced > IPv6**.

The IPv6 page displays.

5. From the **Internet Connection Type** menu, select **6to4 Tunnel**.

The page adjusts.

The router automatically detects the information in the Router's IPv6 Address on LAN field. This field shows the IPv6 address that is acquired for the router's LAN (or local network) interface. The number after the slash (/) is the length of the prefix, which is also indicated by the underline ( ) under the IPv6 address. If no address is acquired, the field displays Not Available.

6. Select a Remote 6to4 Relay Router radio button:

- **Auto:** Your router uses any remote relay router that is available on the Internet. This is the default setting.
- **Static IP Address:** Enter the static IPv4 address of the remote relay router. Your IPv6 ISP usually provides this address.

7. Select an IPv6 Domain Name Server (DNS Address) radio button:

- **Get Automatically from ISP:** Your ISP uses DHCP to assign your DNS servers. Your ISP automatically assigns this address.
- **Use These DNS Servers:** If you know that your ISP requires specific servers, select this option. Enter the IP address of your ISP's primary DNS server. If a secondary DNS server address is available, enter it also.

8. Select an IP Address Assignment radio button:

- **Use DHCP Server:** This method passes more information to LAN devices, but some IPv6 systems might not support the DHCv6 client function.
- **Auto Config:** This is the default setting.

This setting specifies how the router assigns IPv6 addresses to the devices on your home network.

9. (Optional) Select the **Enable RIPng** check box.

This selection enables RIP Next Generation (RIPng) on IPv6 Internet connections. RIPng is an extension of Routing Information Protocol (RIP) that supports IPv6. You might want to enable RIPng if you are an advanced user with a complex home network configuration that requires dynamic routing.

10. (Optional) Select the **Use This Interface ID** check box and specify the interface ID that you want to be used for the IPv6 address of the router's LAN interface.

If you do not specify an ID here, the router generates one automatically from its MAC address.

11. Click the **Apply** button.

Your settings are saved.

## Set up an IPv6 pass-through Internet connection

In pass-through mode, the router works as a Layer 2 Ethernet switch with two ports (LAN and WAN Ethernet ports) for IPv6 packets. The router does not process any IPv6 header packets.

### To set up a pass-through IPv6 Internet connection:

1. Launch a web browser from a computer or mobile device that is connected to your Orbi network.
2. Enter **orbilogin.com** (Windows and Android devices) or **orbilogin.local** (Apple MacOS and iOS devices).

A login window displays.

3. Enter the Orbi admin user name and password.

The user name is **admin**. The password is the one that you specified when you set up your Orbi. The user name and password are case-sensitive.

The BASIC Home page displays.

4. Select **ADVANCED > Advanced > IPv6**.

The IPv6 page displays.

5. From the **Internet Connection Type** menu, select **Pass Through**.  
The page adjusts, but no additional fields display.
6. Click the **Apply** button.  
Your settings are saved.

## Set up an IPv6 fixed Internet connection

### To set up a fixed IPv6 Internet connection:

1. Launch a web browser from a computer or mobile device that is connected to your Orbi network.
  2. Enter **orbilogin.com** (Windows and Android devices) or **orbilogin.local** (Apple MacOS and iOS devices).  
A login window displays.
  3. Enter the Orbi admin user name and password.  
The user name is **admin**. The password is the one that you specified when you set up your Orbi. The user name and password are case-sensitive.  
The BASIC Home page displays.
  4. Select **ADVANCED > Advanced > IPv6**.  
The IPv6 page displays.
  5. From the **Internet Connection Type** menu, select **Fixed**.  
The page adjusts.
  6. Configure the fixed IPv6 addresses for the WAN connection:
    - **IPv6 Address/Prefix Length:** The IPv6 address and prefix length of the router WAN interface.
    - **Default IPv6 Gateway:** The IPv6 address of the default IPv6 gateway for the router's WAN interface.
    - **Primary DNS Server:** The primary DNS server that resolves IPv6 domain name records for the router.
    - **Secondary DNS Server:** The secondary DNS server that resolves IPv6 domain name records for the router.
- ⓘ **NOTE:** If you do not specify the DNS servers, the router uses the DNS servers that are configured for the IPv4 Internet connection on the Internet Setup page. (See [Manually set up the Internet connection](#) on page 30.)
7. Select an IP Address Assignment radio button:



- **Use DHCP Server:** This method passes more information to LAN devices, but some IPv6 systems might not support the DHCv6 client function.
- **Auto Config:** This is the default setting.

This setting specifies how the router assigns IPv6 addresses to the devices on your home network.

8. (Optional) Select the **Enable RIPng** check box.

This selection enables RIP Next Generation (RIPng) on IPv6 Internet connections. RIPng is an extension of Routing Information Protocol (RIP) that supports IPv6.

9. In the **IPv6 Address/Prefix Length** fields, specify the static IPv6 address and prefix length of the router's LAN interface.

If you do not specify an ID here, the router generates one automatically from its MAC address.

10. Click the **Apply** button.

Your settings are saved.

## Set up an IPv6 DHCP Internet connection

### To set up an IPv6 Internet connection with a DHCP server:

1. Launch a web browser from a computer or mobile device that is connected to your Orbi network.
2. Enter **orbilogin.com** (Windows and Android devices) or **orbilogin.local** (Apple MacOS and iOS devices).

A login window displays.

3. Enter the Orbi admin user name and password.

The user name is **admin**. The password is the one that you specified when you set up your Orbi. The user name and password are case-sensitive.

The BASIC Home page displays.

4. Select **ADVANCED > Advanced > IPv6**.

The IPv6 page displays.

5. From the **Internet Connection Type** menu, select **DHCP**.

The page adjusts.

The router automatically detects the information in the following fields:

- **Router's IPv6 Address on WAN:** This field shows the IPv6 address that is acquired for the router's WAN (or Internet) interface. The number after the slash (/) is the

length of the prefix, which is also indicated by the underline (   ) under the IPv6 address. If no address is acquired, the field displays Not Available.

- **Router's IPv6 Address on LAN:** This field shows the IPv6 address that is acquired for the router's LAN (or local network) interface. The number after the slash (/) is the length of the prefix, which is also indicated by the underline (   ) under the IPv6 address. If no address is acquired, the field displays Not Available.

6. (Optional) In the **User Class (If Required)** field, enter a host name.

Most people can leave this field blank, but if your ISP gave you a specific host name, enter it here.

7. (Optional) In the **Domain Name (If Required)** field, enter a domain name.

You can type the domain name of your IPv6 ISP. Do not enter the domain name for the IPv4 ISP here. For example, if your ISP's mail server is mail.xxx.yyy.zzz, type xxx.yyy.zzz as the domain name. If your ISP provided a domain name, type it in this field. For example, Earthlink Cable might require a host name of home, and Comcast sometimes supplies a domain name.

8. Select an IPv6 Domain Name Server (DNS) Address radio button:

- **Get Automatically from ISP:** Your ISP uses DHCP to assign your DNS servers. Your ISP automatically assigns this address.
- **Use These DNS Servers:** If you know that your ISP requires specific servers, select this option. Enter the IP address of your ISP's primary DNS server. If a secondary DNS server address is available, enter it also.

9. Select an IP Address Assignment radio button:

- **Use DHCP Server:** This method passes more information to LAN devices, but some IPv6 systems might not support the DHCv6 client function.
- **Auto Config:** This is the default setting.

This setting specifies how the router assigns IPv6 addresses to the devices on your home network (the LAN).

10. (Optional) Select the **Enable RIPng** check box.

This selection enables RIP Next Generation (RIPng) on IPv6 Internet connections. RIPng is an extension of Routing Information Protocol (RIP) that supports IPv6. You might want to enable RIPng if you are an advanced user with a complex home network configuration that requires dynamic routing.

11. (Optional) Select the **Use This Interface ID** check box and specify the interface ID that you want to be used for the IPv6 address of the router's LAN interface.

If you do not specify an ID here, the router generates one automatically from its MAC address.

12. Click the **Apply** button.

Your settings are saved.

# Set up an IPv6 PPPoE Internet connection

## To set up a PPPoE IPv6 Internet connection:

1. Launch a web browser from a computer or mobile device that is connected to your Orbi network.
2. Enter **orbilogin.com** (Windows and Android devices) or **orbilogin.local** (Apple MacOS and iOS devices).

A login window displays.

3. Enter the Orbi admin user name and password.

The user name is **admin**. The password is the one that you specified when you set up your Orbi. The user name and password are case-sensitive.

The BASIC Home page displays.

4. Select **ADVANCED > Advanced > IPv6**.

The IPv6 page displays.

5. From the **Internet Connection Type** menu, select **PPPoE**.

The page adjusts.

The router automatically detects the information in the following fields:

- **Router's IPv6 Address on WAN:** This field shows the IPv6 address that is acquired for the router's WAN (or Internet) interface. The number after the slash (/) is the length of the prefix, which is also indicated by the underline (\_\_) under the IPv6 address. If no address is acquired, the field displays Not Available.
- **Router's IPv6 Address on LAN:** This field shows the IPv6 address that is acquired for the router's LAN (or local network) interface. The number after the slash (/) is the length of the prefix, which is also indicated by the underline (\_\_) under the IPv6 address. If no address is acquired, the field displays Not Available.

6. Configure the login settings:

- a. In the **Login** field, enter the login information for the IPv6 PPPoE ISP connection.

This is usually the name that you use in your email address. For example, if your main mail account is JerAB@ISP.com, you would type JerAB in this field. Some ISPs (like Earthlink and Deutsche Telekom) require that you use your full email address when you log in. If your ISP requires your full email address, type it in this field.

- b. In the **Password** field, enter the password for the IPv6 PPPoE ISP connection.

- c. In the **Service Name (If Required)** field, enter a service name for the IPv6 PPPoE ISP connection.

If your ISP did not provide a service name, leave this field blank.

**!** **NOTE:** The default setting of the **Connection Mode** field is Always On to provide a steady IPv6 connection. The router never terminates the connection. If the connection is terminated, for example, when the modem is turned off, the router attempts to reestablish the connection immediately after the PPPoE connection becomes available again.

7. Select an IPv6 Domain Name Server (DNS) Address radio button:
  - **Get Automatically from ISP:** Your ISP uses DHCP to assign your DNS servers. Your ISP automatically assigns this address.
  - **Use These DNS Servers:** If you know that your ISP requires specific servers, select this option. Enter the IP address of your ISP's primary DNS server. If a secondary DNS server address is available, enter it also.

8. Select an IP Address Assignment radio button:
  - **Use DHCP Server:** This method passes more information to LAN devices, but some IPv6 systems might not support the DHCv6 client function.
  - **Auto Config:** This is the default setting.

This setting specifies how the router assigns IPv6 addresses to the devices on your home network (the LAN).

9. (Optional) Select the **Enable RIPng** check box.

This selection enables RIP Next Generation (RIPng) on IPv6 Internet connections. RIPng is an extension of Routing Information Protocol (RIP) that supports IPv6. You might want to enable RIPng if you are an advanced user with a complex home network configuration that requires dynamic routing.

10. (Optional) Select the **Use This Interface ID** check box and specify the interface ID that you want to be used for the IPv6 address of the router's LAN interface.

If you do not specify an ID here, the router generates one automatically from its MAC address.

11. Click the **Apply** button.

Your settings are saved.

## Set up an IPv6 6rd tunnel Internet connection

The 6rd protocol makes it possible to deploy IPv6 to sites using a service provider's IPv4 network. 6rd uses the service provider's own IPv6 address prefix. This limits the operational domain of 6rd to the service provider's network and is under direct control of the service provider. The IPv6 service provided is equivalent to native IPv6. The 6rd mechanism relies on an algorithmic mapping between the IPv6 and IPv4 addresses that are assigned for use within the service provider's network. This mapping allows for

automatic determination of IPv4 tunnel endpoints from IPv6 prefixes, allowing stateless operation of 6rd.

With a 6rd Tunnel configuration, the router follows the RFC5969 standard, supporting two ways to establish a 6rd tunnel IPv6 WAN connection:

- **Auto Detect Mode:** In IPv6 Auto Detect mode, when the router receives option 212 from the DHCPv4 option, auto detect selects the IPv6 as 6rd Tunnel setting. The router uses the 6rd option information to establish the 6rd connection.
- **Manual Mode:** Select 6rd. If the router receives option 212, the fields are automatically completed. Otherwise, you must enter the 6rd settings.

### To set up an IPv6 6rd tunnel Internet connection:

1. Launch a web browser from a computer or mobile device that is connected to your Orbi network.
2. Enter **orbilogin.com** (Windows and Android devices) or **orbilogin.local** (Apple MacOS and iOS devices).

A login window displays.

3. Enter the Orbi admin user name and password.

The user name is **admin**. The password is the one that you specified when you set up your Orbi. The user name and password are case-sensitive.

The BASIC Home page displays.

4. Select **ADVANCED > Advanced > IPv6**.

The IPv6 page displays.

5. In the **Internet Connection Type** menu, select **6rd Tunnel**.

The page adjusts.

The router automatically detects the information in the following sections:

- **6rd (IPv6 Rapid Development) Configuration:** The router detects the service provider's IPv4 network and attempts to establish an IPv6 6rd Tunnel connection. If the IPv4 network returns 6rd parameters to the router, the page adjusts to display the correct settings in this section.
  - **Router's IPv6 Address on LAN:** This field shows the IPv6 address that is acquired for the router's LAN (or local network) interface. The number after the slash (/) is the length of the prefix, which is also indicated by the underline ( ) under the IPv6 address. If no address is acquired, the field displays Not Available.
6. Select an IPv6 Domain Name Server (DNS) Address radio button:

- **Get Automatically from ISP:** Your ISP uses DHCP to assign your DNS servers. Your ISP automatically assigns this address.
  - **Use These DNS Servers:** If you know that your ISP requires specific servers, select this option. Enter the IP address of your ISP's primary DNS server. If a secondary DNS server address is available, enter it also.
7. Select an IP Address Assignment radio button:
    - **Use DHCP Server:** This method passes more information to LAN devices, but some IPv6 systems might not support the DHCv6 client function.
    - **Auto Config:** This is the default setting.

This setting specifies how the router assigns IPv6 addresses to the devices on your home network.
  8. (Optional) Select the **Enable RIPng** check box.

This selection enables RIP Next Generation (RIPng) on IPv6 Internet connections. RIPng is an extension of Routing Information Protocol (RIP) that supports IPv6. You might want to enable RIPng if you are an advanced user with a complex home network configuration that requires dynamic routing.
  9. (Optional) Select the **Use This Interface ID** check box and specify the interface ID that you want to be used for the IPv6 address of the router's LAN interface.

If you do not specify an ID here, the router generates one automatically from its MAC address.
  10. (Optional) To set a specific MTU size for an IPv6 6rd tunnel Internet connection, specify the MTU size in the **MTU Size (in bytes)** field.
  11. Click the **Apply** button.

Your settings are saved.

## Change the MTU size

The maximum transmission unit (MTU) is the largest data packet a network device transmits. When one network device communicates across the Internet with another, the data packets travel through many devices along the way. If a device in the data path uses a lower MTU setting than the other devices, the data packets must be split or "fragmented" to accommodate the device with the smallest MTU.

The best MTU setting for NETGEAR equipment is often the default value. In some situations, changing the value fixes one problem but causes another. Leave the MTU unchanged unless one of these situations occurs:

- You experience problems connecting to your ISP or other Internet service, and the technical support of either the ISP or NETGEAR recommends changing the MTU setting.

For example, if a secure website does not open, or displays only part of a web page, you might need to change the MTU.

- You use VPN and experience severe performance problems.
- You used a program to optimize MTU for performance reasons, and now you are experiencing connectivity or performance problems.

**!** **NOTE:** An incorrect MTU setting can cause Internet communication problems. For example, you might not be able to access certain websites, frames within websites, secure login pages, or FTP or POP servers.

### To change the MTU size:

1. Launch a web browser from a computer or mobile device that is connected to your Orbi network.
2. Enter **orbilogin.com** (Windows and Android devices) or **orbilogin.local** (Apple MacOS and iOS devices).

A login window displays.

3. Enter the Orbi admin user name and password.

The user name is **admin**. The password is the one that you specified when you set up your Orbi. The user name and password are case-sensitive.

The BASIC Home page displays.

4. Select **ADVANCED > Setup > WAN Setup**.

The WAN Setup page displays.

5. In the **MTU Size** field, enter a value from 616 to 1500.

6. Click the Apply button.

Your settings are saved.

If you suspect an MTU problem, a common solution is to change the MTU to 1400. If you are willing to experiment, you can gradually reduce the MTU from the maximum value of 1500 until the problem goes away. The following table describes common MTU sizes and applications.

Table 5. Common MTU sizes

MTU	Application
1500	The largest Ethernet packet size. This setting is typical for connections that do not use PPPoE or VPN, and is the default value for NETGEAR routers, adapters, and switches.
1492	Used in PPPoE environments.
1472	Maximum size to use for ping. (Larger packets are fragmented.)

## Whole Home Tri-Band Mesh WiFi 7 System

Table 5. Common MTU sizes (Continued)

MTU	Application
1468	Used in some DHCP environments.
1436	Used in PPTP environments or with VPN.



# 4

## Control Access to the Internet

---

The router comes with a built-in firewall that helps protect your home network from unwanted intrusions from the Internet.

This chapter includes the following sections:

- [Manage NETGEAR Armor](#)
- [Network access control list](#)

# Manage NETGEAR Armor

NETGEAR Armor protects your home network from potential cyber threats and provides complete data protection, advanced threat defense, webcam protection, multilayer ransomware protection, anti-phishing, safe files, secure browsing, rescue mode, anti-fraud, and anti-theft. In addition, NETGEAR Armor provides multiple performance and privacy tools.

NETGEAR Armor can support features for your Windows-based computers and your Mac OS, iOS, and Android devices.

For more information about NETGEAR Armor, visit [netgear.com/home/services/armor/](https://netgear.com/home/services/armor/).

You can manage NETGEAR Armor from the Orbi app.

## Network access control list

You can use the network access control list (ACL) on the router to block or allow access to your network and the Internet. The ACL identifies a WiFi or wired device by its MAC address. The router detects the MAC addresses of the devices on the network and either allows or denies access.

The router detects and stores the MAC addresses of devices that connect to the network, so it lists the MAC addresses both of devices that are currently connected and any that were previously connected.

If you set up a network ACL that *allows* all new devices to connect, the following applies:

- You can either select or manually enter devices that you want to *block* from connecting to the network.
- All other devices are allowed access to the network.

If you set up a network ACL that *blocks* all new devices from connecting, the following applies:

- You can either select or manually enter devices that you want to *allow* access to the network.
- Devices that are currently connected to the network or that were allowed to connect in the past are automatically placed on the network ACL as allowed devices.
- All other devices are denied access to the network.

**!** **NOTE:** Each network device has a MAC address that serves as a unique identifier. The MAC address is a 12-character physical address, containing the hexadecimal characters 0-9, a-f, or A-F (uppercase or lowercase) only, and separated by colons (for example, 00:09:AB:CD:EF:01). Typically, the MAC address is on the label of a device. If you cannot see the label, you can display the MAC address using the network configuration utilities on your computer or mobile device.

# Enable the network access control list, set the access rule, and allow or block connected devices

When you enable network access control, you must select whether new devices are automatically allowed to access the network or are blocked from accessing the network. By default, devices that are already connected to the network are added to the ACL as allowed, but you can choose to block one or more of these devices from accessing the network.

## To enable and manage the network access control list for the entire network and allow or block connected devices:

1. Launch a web browser from a computer or mobile device that is connected to your Orbi network.
2. Enter **orbilogin.com** (Windows and Android devices) or **orbilogin.local** (Apple MacOS and iOS devices).  
A login window displays.
3. Enter the Orbi admin user name and password.  
The user name is **admin**. The password is the one that you specified when you set up your Orbi. The user name and password are case-sensitive.  
The BASIC Home page displays.
4. Select **ADVANCED > Security > Access Control**.  
The Access Control page displays.
5. Select the **Turn on Access Control** check box.  
You must select this check box before you can select an access rule and use the Allow and Block buttons. When the Turn on Access Control check box is cleared, all devices are allowed to connect, even if a device is on the list of blocked devices.
6. Click the **Apply** button.  
Your settings are saved. Network access control is enabled.

7. Select an access rule to apply to new devices:

- **Allow all new devices to connect:** With this setting, if you connect a new device to the network, it can access the network. You do not need to enter its MAC address on this page. This option works for most home networks. You can also block one or more devices from accessing the network. For more information, see the following step.
- **Block all new devices from connecting:** With this setting, if you want to allow a new device to connect, you must enter its MAC address on this page. (In this situation, a new device is a device that was never previously connected to the network.) For more information about allowing one or more devices, see the following step.

If you block all *new* devices from connecting, the device that you are currently using to connect to the router web interface, any other devices that are currently connected to the network, and all devices that were allowed to connect to the network in the past *are* still allowed access. That means that these devices are automatically added to the network ACL as allowed devices. If you want to block any of these devices, see the following step.

**!** **NOTE:** Selecting an access rule does not affect previously blocked or allowed devices. It applies only to *new* devices trying to access the network after you apply this setting.

8. To change access for devices that are connected or were connected to the network, do the following:

- **Currently connected devices:**

In the table that contains the ACL, the Status column shows either Allowed or Blocked for a device. To change the status, select the check box for the device, and click either the **Allow** button or the **Block** button.

**!** **NOTE:** If you blocked all new devices from connecting, make sure that the computer or mobile device that you are currently using to access the router web interface shows as Allowed in the Status column.

- **Devices that were connected in the past:**

- To manage allowed devices that are currently not connected to the network, see [Manage allowed devices currently not on the network](#) on page 53.
- To manage blocked devices that are currently not connected to the network, see [Manage blocked devices currently not on the network](#) on page 54.

9. Click the **Apply** button.

Your settings are saved.

# Manage allowed devices currently not on the network

If you set up an access control list (ACL) that blocks all new devices from accessing the network, you can add new devices that must be allowed access to the network, remove old devices, or change whether devices that were allowed must now be blocked when they try to connect to the network.

For example, you could add a second computer or mobile device for access to the router web management interface in case the device that you are currently using needs to be removed from the network for repairs.

## To manage allowed devices currently not on the network:

1. Launch a web browser from a computer or mobile device that is connected to your Orbi network.
2. Enter **orbilogin.com** (Windows and Android devices) or **orbilogin.local** (Apple MacOS and iOS devices).

A login window displays.

3. Enter the Orbi admin user name and password.

The user name is **admin**. The password is the one that you specified when you set up your Orbi. The user name and password are case-sensitive.

The BASIC Home page displays.

4. Select **ADVANCED > Security > Access Control**.

The Access Control page displays.

5. Click the **View list of allowed devices not currently connected to the network** link.

A table displays the detected device name, MAC address, and connection type of the devices that are not connected but allowed to access the network.

In the following steps, we refer to the list of allowed devices not currently connected to the network as *the list of allowed devices*.

6. To add a device to the list of allowed devices, do the following:

- a. Click the **Add** button.

The Add Allowed Device page displays.

- b. Enter the MAC address and device name for the device that you want to allow.

- c. On the Add Allowed Device page, click the **Apply** button.

The device is added to the list of allowed devices.

7. To remove a device from the list of allowed devices, do the following:

- a. Select the check box for the device.
- b. Click the **Remove from the list** button.

The device is removed from the list of allowed devices.

8. To change the device status by blocking access for a device on the list of allowed devices, do the following:

- a. Select the check box for the device.
- b. Click the **Edit** button.
- c. From the **Access Control** menu, selected **Block**.
- d. On the Edit Device Name page, click the **Apply** button.

The device is moved to the list of blocked devices not currently connected to the network.

9. To change the device name for a device on the list of allowed devices, do the following:

- a. Select the check box for the device.
- b. Click the **Edit** button.
- c. In the **Device Name** field, enter a name.
- d. On the Edit Device Name page, click the **Apply** button.

The device name is changed on the list of allowed devices.

10. Click the **Apply** button.

Your settings are saved.

## Manage blocked devices currently not on the network

If you set up an access control list (ACL) that allows all new devices to access the network, you can add new devices that must be blocked from accessing the network, remove old devices, or change whether devices that were blocked must now be allowed when they try to connect to the network.

**To manage blocked devices currently not on the network:**

1. Launch a web browser from a computer or mobile device that is connected to your Orbi network.
  2. Enter **orbilogin.com** (Windows and Android devices) or **orbilogin.local** (Apple MacOS and iOS devices).  
A login window displays.
  3. Enter the Orbi admin user name and password.  
The user name is **admin**. The password is the one that you specified when you set up your Orbi. The user name and password are case-sensitive.  
The BASIC Home page displays.
  4. Select **ADVANCED > Security > Access Control**.  
The Access Control page displays.
  5. Click the **View list of blocked devices not currently connected to the network** link.  
The Access Control page displays.  
A table displays the detected device name, MAC address, and connection type of the devices that are not connected and are blocked from accessing the network.  
In the following steps, we refer to the list of blocked devices not currently connected to the network as *the list of blocked devices*.
  6. To add a device to the list of blocked devices, do the following:
    - a. Click the **Add** button.  
The Add Blocked Device page displays.
    - b. Enter the MAC address and device name for the device that you want to block.
    - c. On the Add Blocked Device page, click the **Apply** button.  
The device is added to the list of blocked devices.
  7. To remove a device from the list of blocked devices, do the following:
    - a. Select the check box for the device.
    - b. Click the **Remove from the list** button.  
The device is removed from the list of blocked devices.
  8. To change the device status by allowing access for a device on the list of blocked devices, do the following:
    - a. Select the check box for the device.
    - b. Click the **Edit** button.  
The Edit Device Name page displays.
-

c. From the **Access Control** menu, selected **Allow**.

d. On the Edit Device Name page, click the **Apply** button.

The device is moved to the list of allowed devices not currently connected to the network.

9. To change the device name for a device on the list of blocked devices, do the following:

a. Select the check box for the device.

b. Click the **Edit** button.

The Edit Device Name page displays.

c. In the **Device Name** field, enter a name.

d. On the Edit Device Name page, click the **Apply** button.

The device name is changed on the list of blocked devices.

10. Click the **Apply** button.

Your settings are saved.



# 5

## Manage the WiFi Settings

---

This chapter includes the following sections:

- [About the WiFi networks](#)
- [Manage the settings for the main WiFi network](#)
- [Manage the IoT WiFi settings](#)
- [Set up a guest WiFi network](#)
- [Change your region](#)
- [Enable or disable 20/40 MHz coexistence for the 2.4 GHz radio](#)
- [Change the preamble mode for a radio](#)
- [Change the transmission power control](#)
- [Generate a new backhaul password](#)
- [Use the router as a WiFi access point only](#)

# About the WiFi networks

The router provides three WiFi networks:

- **Main network:** The main WiFi network of the router broadcasts simultaneously in the 2.4 GHz, 5 GHz, and 6 GHz radio bands. The router supports automatic bandsteering between these three radio bands in the main WiFi network. The main network is enabled by default. You cannot disable the main network, or broadcast of the 2.4 GHz, 5 GHz, and 6 GHz radio bands in the main network. You can change the WiFi network name (SSID), security option, and password for the main network, all of which are unique to the main network. However, if you change the channel for the main network, the changes apply to *all* WiFi networks on the router. You can set fixed channels for the 2.4 GHz and 5 GHz radio bands individually.
- **IoT network:** The Internet of things (IoT) network is enabled by default so that you can connect WiFi-enabled smart devices that can range from light bulbs to appliances. If you do not need the IoT network, you can disable it. You can select the radio bands for the IoT network and change the WiFi network name (SSID), security option, and password, all of which are unique to the IoT network.
- **Guest network:** The optional guest network is disabled by default, but you can enable it so that guests and visitors can connect to your WiFi without compromising the security of your other WiFi networks. You can change the WiFi network name (SSID), security option, and password for the guest network, all of which are unique to the guest network.

## Manage the settings for the main WiFi network

The router and satellite(s) come preset with the same WiFi network name (SSID) and the same WiFi security. You can find the SSID and password on the router label and on the satellite label. If you log in to the router and change the WiFi settings, the router automatically sends the new settings to the satellite(s).

If you change your WiFi settings, make a note of the new settings and store the information in a safe place where you can easily find it.

If your computer or mobile device is using a WiFi connection when you change the network name (SSID) or other WiFi security settings, you are disconnected when you click the **Apply** button. To avoid this problem, use a computer with a wired connection to access the router.

# Change the name of the main WiFi network

## To change the WiFi network name (SSID) of the main WiFi network:

1. Launch a web browser from a computer or mobile device that is connected to your Orbi network.
2. Enter **orbilogin.com** (Windows and Android devices) or **orbilogin.local** (Apple MacOS and iOS devices).  
A login window displays.
3. Enter the Orbi admin user name and password.  
The user name is **admin**. The password is the one that you specified when you set up your Orbi. The user name and password are case-sensitive.  
The BASIC Home page displays.
4. Select **Wireless**.  
The Wireless Setup page displays.
5. Enter a new name in the **Name (SSID)** field.  
The name can be up to 32 characters long and it is case-sensitive. The default SSID is randomly generated and is on the router's label. If you change the name, make sure to write down the new name and keep it in a safe place.
6. Click the **Apply** button.  
Your settings are saved. The router sends the new settings to the satellite.  
If you are using a WiFi connection to your Orbi router and you changed the SSID, you are disconnected from the network.

# Change the 2.4 GHz or 5 GHz WiFi channel

You can change the 2.4 GHz or 5 GHz WiFi channel.

In some regions, not all channels are available. Do not change the channel unless you experience interference (shown by lost connections or slow data transfers). If this happens, experiment with different channels to see which is the best.

When you use multiple access points, it is better if adjacent access points use different channels to reduce interference. The recommended channel spacing between adjacent access points is four channels (for example, for the 2.4 GHz radio band, use Channels 1 and 5, or 6 and 10).

**!** **NOTE:** If you change the 2.4 GHz or 5 GHz channel, the change also applies to the IoT network and the guest network.

**To change the WiFi channel:**

1. Launch a web browser from a computer or mobile device that is connected to your Orbi network.
  2. Enter **orbilogin.com** (Windows and Android devices) or **orbilogin.local** (Apple MacOS and iOS devices).  
A login window displays.
  3. Enter the Orbi admin user name and password.  
The user name is **admin**. The password is the one that you specified when you set up your Orbi. The user name and password are case-sensitive.  
The BASIC Home page displays.
  4. Select **Wireless**.  
The Wireless Setup page displays.
  5. To change the 2.4 GHz or 5 GHz WiFi channel, select a number from one of the following menus:
    - **2.4 GHz Channel**
    - **5 GHz Channel**
- !** **NOTE:** You can change the channel for one or both radio bands.
6. Click the **Apply** button.  
Your settings are saved. The router sends the new settings to the satellite.

## Change the WiFi password or security option for the main WiFi network

The router and satellite(s) come preset with the same WiFi network name (SSID) and the same WiFi security. You can find the SSID and password on the router label and on the satellite label. If you log in to the router and change the WiFi settings, the router automatically sends the new settings to the satellite(s).

**To change the WiFi password or security option for the main WiFi network:**

1. Launch a web browser from a computer or mobile device that is connected to your Orbi network.
2. Enter **orbilogin.com** (Windows and Android devices) or **orbilogin.local** (Apple MacOS and iOS devices).  
A login window displays.
3. Enter the Orbi admin user name and password.

The user name is **admin**. The password is the one that you specified when you set up your Orbi. The user name and password are case-sensitive.

The BASIC Home page displays.

4. Select **Wireless**.

The Wireless Setup page displays.

5. In the Security Options section, select a radio button:

- **WPA2-PSK + WPA3-Personal**
- **WPA3-Personal**

6. In the **Password (Network Key)** field, enter the network key (password) that you want to use.

For mixed WPA2 and WPA3, it is a text string from 8 to 63 characters. For WPA3, it is a text string from 8 to 127 characters.

7. Keep your new password in a secure place for future reference.
8. Click the **Apply** button.

Your settings are saved. The router sends the new settings to the satellite.

# Manage the IoT WiFi settings

You can enable or disable the Internet of things (IoT) WiFi network, change the IoT WiFi radio band, change the IoT WiFi network name, and change the IoT WiFi password or security option.

## Enable or disable the IoT network

### To enable or disable the IoT network:

1. Launch a web browser from a computer or mobile device that is connected to your Orbi network.

2. Enter **orbilogin.net**.

A login window displays.

3. Enter the admin user name and password.

The user name is **admin**. The password is the one that you specified the first time that you logged in. The user name and password are case-sensitive.

The BASIC Home page displays.

4. Select **Wireless**.

The Wireless Setup page displays.

5. In the Wireless IoT Settings section, select or clear the **Enable IoT Network** check box.

Selecting the check box enables the IoT network. Clearing this check box disables the IoT network.

6. Click the **Apply** button.

Your settings are saved.

## Change the WiFi radio band for the IoT network

### To change the WiFi radio band for the IoT network:

1. Launch a web browser from a computer or mobile device that is connected to your Orbi network.
2. Enter **orbilogin.com** (Windows and Android devices) or **orbilogin.local** (Apple MacOS and iOS devices).

A login window displays.

3. Enter the Orbi admin user name and password.

The user name is **admin**. The password is the one that you specified when you set up your Orbi. The user name and password are case-sensitive.

The BASIC Home page displays.

4. Select **Wireless**.

The Wireless Setup page displays.

5. In the Wireless IoT Settings section, select one of the following radio buttons:

- **2.4 GHz and 5 GHz**
- **2.4 GHz only**
- **5 GHz only**

6. Click the **Apply** button.

Your settings are saved.

# Change the WiFi network name for the IoT network

## To change the WiFi network name (SSID) for the IoT network:

1. Launch a web browser from a computer or mobile device that is connected to your Orbi network.
2. Enter **orbilogin.com** (Windows and Android devices) or **orbilogin.local** (Apple MacOS and iOS devices).  
A login window displays.
3. Enter the Orbi admin user name and password.  
The user name is **admin**. The password is the one that you specified when you set up your Orbi. The user name and password are case-sensitive.  
The BASIC Home page displays.
4. Select **Wireless**.  
The Wireless Setup page displays.
5. In the Wireless IoT Settings section, enter a new name in the **IoT Name (SSID)** field.  
The name can be up to 32 characters long and is case-sensitive. The default SSID is randomly generated and is on the router's label. If you change the name, make sure to write down the new name and keep it in a safe place.
6. Click the **Apply** button.  
Your settings are saved. The router sends the new settings to the satellite.

# Change the WiFi password for the IoT network

## To change the WiFi password for the IoT network:

1. Launch a web browser from a computer or mobile device that is connected to your Orbi network.
2. Enter **orbilogin.com** (Windows and Android devices) or **orbilogin.local** (Apple MacOS and iOS devices).  
A login window displays.
3. Enter the Orbi admin user name and password.  
The user name is **admin**. The password is the one that you specified when you set up your Orbi. The user name and password are case-sensitive.

The BASIC Home page displays.

4. Select **Wireless**.

The Wireless Setup page displays.

5. In the **Password (Network Key)** field, create a new password (network key).  
Enter a text string from 8 to 63 characters.
6. Keep your new password in a secure place for future reference.
7. Click the **Apply** button.

Your settings are saved. The router sends the new settings to the satellite.

## Set up a guest WiFi network

### To set up a guest WiFi network:

1. Launch a web browser from a computer or mobile device that is connected to your Orbi network.
2. Enter **orbilogin.com** (Windows and Android devices) or **orbilogin.local** (Apple MacOS and iOS devices).

A login window displays.

3. Enter the Orbi admin user name and password.

The user name is **admin**. The password is the one that you specified when you set up your Orbi. The user name and password are case-sensitive.

The BASIC Home page displays.

4. Select **Guest Network**.

The Guest Network Settings page displays.

5. Select the **Enable Guest Network** check box.

6. To change the network name, type a new name in the **Guest Wireless Network Name (SSID)** field.

The name can be up to 32 characters long and is case-sensitive. If you change the name, make sure to write down the new name and keep it in a safe place.

By default, security and encryption are disabled for the guest WiFi network. (Under Security Options, the **None** radio button is selected).

7. To enable security and encryption for the guest WiFi network, under Security Options, select a WPA radio button:



- **WPA2-PSK**
- **WPA2-PSK + WPA3-Personal**
- **WPA3-Personal**

The WPA3 option uses the newest standard for the strongest security.

Some older computers and WiFi devices cannot use WPA3. If your network includes such computers and WiFi devices, select the **WPA2-PSK** radio button.

The Password (Network Key) field displays.

8. In the **Password (Network Key)** field, enter the network key (password) that you want to use.

For WPA2 or mixed WPA2 and WPA3, it is a text string from 8 to 63 characters. For WPA3, it is a text string from 8 to 127 characters.

9. Write down the new password and keep it in a secure place for future reference.
10. Click the **Apply** button.

Your settings are saved. The router sends the new settings to the satellite.

## Change your region

### To view or change your region:

1. Launch a web browser from a computer or mobile device that is connected to your Orbi network.
2. Enter **orbilogin.com** (Windows and Android devices) or **orbilogin.local** (Apple MacOS and iOS devices).

A login window displays.

3. Enter the Orbi admin user name and password.

The user name is **admin**. The password is the one that you specified when you set up your Orbi. The user name and password are case-sensitive.

The BASIC Home page displays.

4. Select **ADVANCED > Advanced > Wireless Settings**.

The Advanced Wireless Settings page displays.

5. In the **Region** menu, select your region.

In some locations, you cannot change this setting.

6. Click the **Apply** button.

Your settings are saved.

# Enable or disable 20/40 MHz coexistence for the 2.4 GHz radio

20/40 coexistence allows a 20 MHz and 40 MHz channel width to be supported simultaneously. By default, 20/40 MHz coexistence is enabled on the 2.4 GHz radio to prevent interference with other WiFi networks in your environment at the expense of the WiFi speed. If no other WiFi networks are present in your environment, you can disable 20/40 MHz coexistence to increase the WiFi speed on the 2.4 GHz radio to the maximum supported speed for the WiFi mode.

20/40 MHz coexistence does not apply to the 5 GHz and 6 GHz radios.

## To enable or disable 20/40 MHz coexistence for the 2.4 GHz radio:

1. Launch a web browser from a computer or mobile device that is connected to your Orbi network.
2. Enter **orbilogin.com** (Windows and Android devices) or **orbilogin.local** (Apple MacOS and iOS devices).  
A login window displays.
3. Enter the Orbi admin user name and password.  
The user name is **admin**. The password is the one that you specified when you set up your Orbi. The user name and password are case-sensitive.  
The BASIC Home page displays.
4. Select **ADVANCED > Advanced > Wireless Settings**.  
The Advanced Wireless Settings page displays.
5. In the Wireless Network (2.4GHz b/g/n/ax section), select or clear the **Enable 20/40 MHz Coexistence** check box.  
Selecting this check box enables 20/40 MHz coexistence and clearing this check box disables 20/40 MHz coexistence.  
By default, 20/40 MHz coexistence is enabled and the check box is selected.
6. Click the **Apply** button.  
Your settings are saved. The 2.4 GHz radio restarts and WiFi clients might need to reconnect.

# Change the preamble mode for a radio

For most WiFi networks, the preamble mode works fine and we recommend that you do not change the setting. (In general, this setting is intended for WiFi testing.)

 **CAUTION:** Do not change the preamble mode unless directed by NETGEAR support or unless you are sure what the consequences are. An incorrect setting might disable the WiFi function of a radio unexpectedly.

## To change the preamble mode for a radio:

1. Launch a web browser from a computer or mobile device that is connected to your Orbi network.
  2. Enter **orbilogin.com** (Windows and Android devices) or **orbilogin.local** (Apple MacOS and iOS devices).  
A login window displays.
  3. Enter the Orbi admin user name and password.  
The user name is **admin**. The password is the one that you specified when you set up your Orbi. The user name and password are case-sensitive.  
The BASIC Home page displays.
  4. Select **ADVANCED > Advanced > Wireless Settings**.  
The Advanced Wireless Settings page displays.
  5. From the **Preamble Mode** menu, select the preamble mode:
    - **Automatic:** The automatic option (which is the default option) lets the router process both long and short preambles.
    - **Long Preamble:** A long transmit preamble might provide a more reliable connection or a slightly longer range.
    - **Short Preamble:** A short transmit preamble might give better performance.
-  **CAUTION:** An incorrect setting might disable the WiFi function for the selected radio unexpectedly.
6. Click the **Apply** button.  
Your settings are saved.

# Change the transmission power control

By default, your router's radio transmission power is set to 100%. This allows your router to give you whole home WiFi coverage. If you don't need whole home WiFi coverage, and you also want to save power consumption while using your router, you can lower the transmission power of your router for the 2.4 GHz radio, 5 GHz radios, or both the 2.4 GHz radio and the 5 GHz radios. You cannot change the transmission power control for the 6 GHz radio.

## To change the transmission power control:

1. Launch a web browser from a computer or mobile device that is connected to your Orbi network.
2. Enter **orbilogin.com** (Windows and Android devices) or **orbilogin.local** (Apple MacOS and iOS devices).  
A login window displays.
3. Enter the Orbi admin user name and password.  
The user name is **admin**. The password is the one that you specified when you set up your Orbi. The user name and password are case-sensitive.  
The BASIC Home page displays.
4. Select **ADVANCED > Advanced > Wireless Settings**.  
The Advanced Wireless Settings page displays.
5. In the Advanced Wireless Network (2.4 GHz b/g/n/ax) section, select a percentage from the **Transmit Power Control** menu.
6. In the Advanced Wireless Network (5 GHz 802.11a/n/ac/ax/be) section, select a percentage from the **Transmit Power Control** menu.
7. Click the **Apply** button.  
Your settings are saved.

# Generate a new backhaul password

The backhaul password is a security key that is used in WiFi communication between the router and the satellite. You can generate a new backhaul password. After you generate a new backhaul password, you must use the **Sync** button to build a new backhaul connection so that the router and satellite can communicate with each other using WiFi.

**To generate a new backhaul password:**

1. Launch a web browser from a computer or mobile device that is connected to your Orbi network.
2. Enter **orbilogin.com** (Windows and Android devices) or **orbilogin.local** (Apple MacOS and iOS devices).  
A login window displays.
3. Enter the Orbi admin user name and password.  
The user name is **admin**. The password is the one that you specified when you set up your Orbi. The user name and password are case-sensitive.  
The BASIC Home page displays.
4. Select **ADVANCED > Advanced > Wireless Settings**.  
The Advanced Wireless Settings page displays.
5. In the **Backhaul Password** section, click the **Generate** button.  
The router generates a new backhaul password.

## Use the router as a WiFi access point only

By default, the Orbi router functions as both a router and WiFi access point. You can set up the router to run as a WiFi access point only on the same local network as another router or gateway.

For example, you can use the Orbi router as a WiFi access point that connects to a gateway or modem router that you already use for your Internet service. In this situation, you do not need to change the settings for the gateway or modem router.

**To set up the Orbi router as an AP after you set up your Internet connection:**

1. Use an Ethernet cable to connect the Internet port of the Orbi router to a LAN port on your existing gateway or modem router.
2. Launch a web browser from a computer or mobile device that is connected to your Orbi network.
3. Enter **orbilogin.com** (Windows and Android devices) or **orbilogin.local** (Apple MacOS and iOS devices).  
A login window displays.
4. Enter the Orbi admin user name and password.

The user name is **admin**. The password is the one that you specified when you set up your Orbi. The user name and password are case-sensitive.

The BASIC Home page displays.

5. Select **ADVANCED > Advanced > Router / AP Mode**.

The Router / AP Mode page displays.

6. Select the **AP Mode** radio button.

The page adjusts.

7. Select the IP address setting:

- **Get dynamically from existing router:** The other router on the network assigns an IP address to the Orbi router while the Orbi router is in AP mode.
- **Enable fixed IP settings on this device (not recommended):** Use this setting if you want to manually assign a specific IP address to the Orbi router while it is in AP mode. Using this option effectively requires advanced networking experience.

**!** **NOTE:** To avoid interference with other routers or gateways in your network, we recommend that you use different WiFi settings on each router and gateway. If the other router or gateway is also a WiFi access point, you could turn off the WiFi radio on the other router or gateway and use the Orbi router only for WiFi client access.

8. Click the **Apply** button.

The IP address of the Orbi router changes, and you are disconnected.

9. To reconnect, close and restart your browser and enter **orbilogin.com** (Windows and Android devices) or **orbilogin.local** (Apple MacOS and iOS devices).

# 6

## Specify Network Settings

---

This chapter includes the following sections:

- [View or change WAN settings](#)
- [Manage Dynamic DNS](#)
- [Set up a default DMZ server](#)
- [Change the router's device name](#)
- [Change the LAN IP or RIP settings](#)
- [Use the router as a DHCP server](#)
- [Disable the DHCP server feature in the router](#)
- [Manage reserved LAN IP addresses](#)
- [Manage custom static routes](#)
- [Change the router back to router mode](#)
- [Improve network connections with Universal Plug and Play](#)
- [Set up a bridge for a port group or VLAN tag group](#)

# View or change WAN settings

You can view or configure wide area network (WAN) settings for the Internet port. You can set up a DMZ (demilitarized zone) server, change the maximum transmit unit (MTU) size, and enable the router to respond to a ping to its WAN (Internet) port.

## To view the WAN settings:

1. Launch a web browser from a computer or mobile device that is connected to your Orbi network.
2. Enter **orbilogin.com** (Windows and Android devices) or **orbilogin.local** (Apple MacOS and iOS devices).

A login window displays.

3. Enter the Orbi admin user name and password.

The user name is **admin**. The password is the one that you specified when you set up your Orbi. The user name and password are case-sensitive.

The BASIC Home page displays.

4. Select **ADVANCED > Setup > WAN Setup**

The WAN Setup page displays.

5. View or change the following settings:

- **Disable Port Scan and DoS Protection:** DoS protection protects your LAN against denial of service attacks such as Syn flood, Smurf Attack, Ping of Death, and many others. Select this check box only in special circumstances.
- **Default DMZ Server:** This feature is sometimes helpful when you are playing online games or videoconferencing, but it makes the firewall security less effective. See [Set up a default DMZ server](#) on page 76.
- **Respond to Ping on Internet Port:** This feature allows your router to be discovered. Use this feature only as a diagnostic tool or if you have a specific reason.
- **Disable IGMP Proxying:** IGMP proxying allows a computer on the local area network (LAN) to receive the multicast traffic it is interested in from the Internet. If you do not need this feature, select this check box to disable it.
- **MTU Size (in bytes):** The normal MTU (maximum transmit unit) value for most Ethernet networks is 1500 bytes, or 1492 bytes for PPPoE connections. Change the MTU only if you are sure that it is necessary for your ISP connection. See [Change the MTU size](#) on page 46.
- **NAT Filtering:** Network Address Translation (NAT) determines how the router processes inbound traffic. Secured NAT protects computers on the LAN from attacks from the Internet, but might prevent some Internet games, point-to-point



applications, or multimedia applications from working. Open NAT provides a much less secured firewall, but allows almost all Internet applications to work.

- **Disable SIP ALG:** The application-level gateway (ALG) for the Session Initiation Protocol (SIP) is enabled by default for enhanced address and port translation. However, some types of VoIP and video traffic might not work well when the SIP ALG is enabled. For this reason, the router provides the option to disable the SIP ALG.

6. Click the **Apply** button.

Your settings are saved.

# Manage Dynamic DNS

Internet service providers (ISPs) assign numbers called IP addresses to identify each Internet account. Most ISPs use dynamically assigned IP addresses. This means that the IP address can change at any time. You can use the IP address to access your network remotely, but most people don't know what their IP addresses are or when this number changes.

To make it easier to connect, you can get a free account with a Dynamic DNS service that lets you use a domain name to access your home network. To use this account, you must set up the router to use Dynamic DNS. Then the router notifies the Dynamic DNS service provider whenever its IP address changes. When you access your Dynamic DNS account, the service finds the current IP address of your home network and automatically connects you.

If your ISP assigns a private WAN IP address (such as 192.168.x.x or 10.x.x.x), the Dynamic DNS service does not work because private addresses are not routed on the Internet.

## Set up a new Dynamic DNS account

### To set up Dynamic DNS and register for a free NETGEAR account:

1. Launch a web browser from a computer or mobile device that is connected to your Orbi network.
2. Enter **orbilogin.com** (Windows and Android devices) or **orbilogin.local** (Apple MacOS and iOS devices).  
A login window displays.
3. Enter the Orbi admin user name and password.

The user name is **admin**. The password is the one that you specified when you set up your Orbi. The user name and password are case-sensitive.

The BASIC Home page displays.

4. Select **ADVANCED > Advanced > Dynamic DNS**.

The Dynamic DNS page displays.

5. Select the **Use a Dynamic DNS Service** check box.
6. In the **Service Provider** list, select **NETGEAR**.
7. Select the **No** radio button.
8. In the **Host Name** field, type the name that you want to use for your URL.  
The host name is sometimes called the domain name. Your free URL includes the host name that you specify, and ends with mynetgear.com. For example, specify *MyName.mynetgear.com*.
9. In the **Email** field, type the email address that you want to use for your account.
10. In the **Password (6-32 characters)** field, type the password for your account.
11. To agree to the terms of service, select the check box above the **Register** button.
12. Click the **Register** button.
13. Follow the onscreen instructions to register for your NETGEAR Dynamic DNS service.
14. To check that Dynamic DNS is enabled in the router, click the **Show Status** button.

A message displays the Dynamic DNS status.

## Specify a Dynamic DNS account that you already created

If you already own a Dynamic DNS account with NETGEAR, No-IP, or DynDNS, you can set up the router to use your account.

### To set up Dynamic DNS if you already created an account:

1. Launch a web browser from a computer or mobile device that is connected to your Orbi network.
2. Enter **orbilogin.com** (Windows and Android devices) or **orbilogin.local** (Apple MacOS and iOS devices).

A login window displays.

3. Enter the Orbi admin user name and password.

The user name is **admin**. The password is the one that you specified when you set up your Orbi. The user name and password are case-sensitive.

The BASIC Home page displays.

4. Select **ADVANCED > Advanced > Dynamic DNS**.

The Dynamic DNS page displays.

5. Select the **Use a Dynamic DNS Service** check box.
6. In the **Service Provider** list, select your provider.
7. Select the **Yes** radio button.

The page adjusts and displays to show the **Status**, **Cancel**, and **Apply** buttons.
8. In the **Host Name** field, type the host name (sometimes called the domain name) for your account.
9. For a No-IP account or DynDNS account, in the **User Name** field, enter the user name for your account.
10. For a NETGEAR account, in the **Email** field, type the email address for your account.
11. In the **Password (6-32 characters)** field, type the password for your DDNS account.
12. Click the **Apply** button.

Your settings are saved.
13. To verify that your Dynamic DNS service is enabled in the router, click the **Show Status** button.

A message displays the Dynamic DNS status.

## Change the Dynamic DNS settings

### To change your settings:

1. Launch a web browser from a computer or mobile device that is connected to your Orbi network.
2. Enter **orbilogin.com** (Windows and Android devices) or **orbilogin.local** (Apple MacOS and iOS devices).

A login window displays.
3. Enter the Orbi admin user name and password.

The user name is **admin**. The password is the one that you specified when you set up your Orbi. The user name and password are case-sensitive.

The BASIC Home page displays.
4. Select **ADVANCED > Advanced > Dynamic DNS**.

The Dynamic DNS page displays.
5. Change your DDNS account settings as necessary.
6. Click the **Apply** button.

Your settings are saved.

# Set up a default DMZ server

The default DMZ server feature is helpful when you are using some online games and videoconferencing applications that are incompatible with Network Address Translation (NAT). The router is programmed to recognize some of these applications and to work correctly with them, but other applications might not function well. In some cases, one local computer can run the application correctly if the IP address for that computer is entered as the default DMZ server.

DMZ servers pose a security risk. A computer designated as the default DMZ server loses much of the protection of the firewall and is exposed to exploits from the Internet. If compromised, the DMZ server computer can be used to attack other computers on your network.

The router usually detects and discards incoming traffic from the Internet that is not a response to one of your local computers or a service that you configured in the Port Forwarding/Port Triggering page. Instead of discarding this traffic, you can specify that the router forwards the traffic to one computer on your network. This computer is called the default DMZ server.

## To set up a default DMZ server:

1. Launch a web browser from a computer or mobile device that is connected to your Orbi network.
2. Enter **orbilogin.com** (Windows and Android devices) or **orbilogin.local** (Apple MacOS and iOS devices).  
A login window displays.
3. Enter the Orbi admin user name and password.  
The user name is **admin**. The password is the one that you specified when you set up your Orbi. The user name and password are case-sensitive.  
The BASIC Home page displays.
4. Select **ADVANCED > Setup > WAN Setup**.  
The WAN Setup page displays.
5. Select the **Default DMZ Server** check box.
6. Type the IP address.
7. Click the **Apply** button.  
Your settings are saved.

# Change the router's device name

The router's default device name is its model number. This device name displays in a file manager when you browse your network.

## To change the router's device name:

1. Launch a web browser from a computer or mobile device that is connected to your Orbi network.
2. Enter **orbilogin.com** (Windows and Android devices) or **orbilogin.local** (Apple MacOS and iOS devices).  
A login window displays.
3. Enter the Orbi admin user name and password.  
The user name is **admin**. The password is the one that you specified when you set up your Orbi. The user name and password are case-sensitive.  
The BASIC Home page displays.
4. Select **ADVANCED > Setup > Device Name**.  
The Device Name page displays.
5. In the **Device Name** field, type a new name.
6. Click the **Apply** button.  
Your settings are saved.

# Change the LAN IP or RIP settings

The router is preconfigured to use private IP addresses on the LAN side and to act as a DHCP server. The router's default LAN IP configuration is as follows:

- **LAN IP address.** 10.168.168.1
- **Subnet mask.** 255.255.255.0

These addresses are part of the designated private address range for use in private networks and are suitable for most applications. If your network requires a different IP addressing scheme, you can change these settings.

You might want to change these settings if you need a specific IP subnet that one or more devices on the network uses, or if you use competing subnets with the same IP scheme.

Router Information Protocol (RIP) allows a router to exchange routing information with other routers. You can change the RIP settings.

### To change the LAN IP or RIP settings:

1. Launch a web browser from a computer or mobile device that is connected to your Orbi network.
2. Enter **orbilogin.com** (Windows and Android devices) or **orbilogin.local** (Apple MacOS and iOS devices).

A login window displays.

3. Enter the Orbi admin user name and password.

The user name is **admin**. The password is the one that you specified when you set up your Orbi. The user name and password are case-sensitive.

The BASIC Home page displays.

4. Select **ADVANCED > Setup > LAN Setup**.

The LAN Setup page displays.

5. To change the IP settings, do the following:

- a. In the **IP Address** field, type the IP address.
- b. In the **IP Subnet Mask**, type the subnet mask of the router.

The IP address and subnet mask identifies which addresses are local to a specific device and which must be reached through a gateway or router.

6. To change the RIP settings, do the following:

- a. From the **RIP direction** menu, select a direction:

- **Both**: The router broadcasts its routing table periodically *and* incorporates information that it receives.
- **Out Only**: The router broadcasts its routing table periodically.
- **In Only**: The router incorporates the RIP information that it receives.

- b. From the **RIP version** menu, select the version, if any:

- **Disabled**: This is the default setting.
- **RIP-1**: This RIP format is universally supported. It is adequate for most networks, unless you are using an unusual network setup.
- **RIP-2B**: This RIP format carries more information. RIP-2B sends the routing data in RIP-2 format and uses subnet broadcasting.
- **RIP-2M**: This RIP format carries more information. RIP-2M sends the routing data in RIP-2 format and uses multicasting.

- c. If you select **RIP-2B** or **RIP-2M** in the previous step, as an option, select one of the following security options from the **RIPv2 authentication mode** menu:

- **Text:** RIPv2 communication is protected by a password, which you must set in the **Password** field.
  - **MD5:** RIPv2 communication is protected by the MD5 message-digest algorithm, for which you must set a password in the **Key String** field. This option is the most secure option for RIPv2.
7. Click the **Apply** button.  
Your settings are saved.  
If you changed the LAN IP address of the router, you are disconnected when this change takes effect.
  8. To reconnect, close your browser, relaunch it, and log in to the router.

# Use the router as a DHCP server

By default, the router acts as a Dynamic Host Configuration Protocol (DHCP) server. The router assigns IP, DNS server, and default gateway addresses to all computers connected to the LAN. The assigned default gateway address is the LAN address of the router.

These addresses must be part of the same IP address subnet as the router's LAN IP address. Using the default addressing scheme, define a range between 192.168.1.2 and 192.168.1.254, although you can save part of the range for devices with fixed addresses.

### **To use the router as a DHCP server and specify the pool of IP addresses that the router assigns:**

1. Launch a web browser from a computer or mobile device that is connected to your Orbi network.
  2. Enter **orbilogin.com** (Windows and Android devices) or **orbilogin.local** (Apple MacOS and iOS devices).  
A login window displays.
  3. Enter the Orbi admin user name and password.  
The user name is **admin**. The password is the one that you specified when you set up your Orbi. The user name and password are case-sensitive.  
The BASIC Home page displays.
  4. Select **ADVANCED > Setup > LAN Setup**.  
The LAN Setup page displays.
  5. If you previously disabled the DHCP server feature, select the **Use Router as DHCP Server** check box.
  6. Specify the range of IP addresses that the router assigns:
-

- a. In the **Starting IP Address** field, enter the lowest number in the range.  
This IP address must be in the same subnet as the router. The default starting IP address is 192.168.1.2.
  - b. In the **Ending IP Address** field, enter the number at the end of the range of IP addresses.  
This IP address must be in the same subnet as the router. The default ending IP address is 192.168.1.254.
7. Click the **Apply** button.  
Your settings are saved.  
The router delivers the following parameters to any LAN device that requests DHCP:
- An IP address from the range that you defined
  - Subnet mask
  - Gateway IP address (the router's LAN IP address)
  - DNS server IP address (the router's LAN IP address)

# Disable the DHCP server feature in the router

By default, the router acts as a DHCP server. The router assigns IP, DNS server, and default gateway addresses to all computers connected to the LAN. The assigned default gateway address is the LAN address of the router.

You can use another device on your network as the DHCP server, or specify the network settings of all your computers.

### To disable the DHCP server feature in the router:

1. Launch a web browser from a computer or mobile device that is connected to your Orbi network.
2. Enter **orbilogin.com** (Windows and Android devices) or **orbilogin.local** (Apple MacOS and iOS devices).  
A login window displays.
3. Enter the Orbi admin user name and password.  
The user name is **admin**. The password is the one that you specified when you set up your Orbi. The user name and password are case-sensitive.  
The BASIC Home page displays.
4. Select **ADVANCED > Setup > LAN Setup**.



The LAN Setup page displays.

5. Clear the **Use Router as DHCP Server** check box.
6. Click the **Apply** button.
7. (Optional) If this service is disabled and no other DHCP server is on your network, set your computer and device IP addresses manually so that they can access the router.

## Manage reserved LAN IP addresses

When you specify a reserved IP address for a computer on the LAN, that computer always receives the same IP address each time it accesses the router's DHCP server. Assign reserved IP addresses to computers or devices that require permanent IP settings.

### Reserve an IP address

#### To reserve an IP address:

1. Launch a web browser from a computer or mobile device that is connected to your Orbi network.
2. Enter **orbilogin.com** (Windows and Android devices) or **orbilogin.local** (Apple MacOS and iOS devices).

A login window displays.

3. Enter the Orbi admin user name and password.

The user name is **admin**. The password is the one that you specified when you set up your Orbi. The user name and password are case-sensitive.

The BASIC Home page displays.

4. Select **ADVANCED > Setup > LAN Setup**.

The LAN Setup page displays.

5. In the Address Reservation section of the page, click the **Add** button.

The page adjusts.

The Address Reservation table displays the IP address, device name, and MAC address for each device that the router detects on its network.

6. Do one of the following:
  - To reserve an IP address for a device that is already on the network, select the radio button for the device.
  - To reserve an IP address for a device that not on the network, do the following:

- a. In the **IP Address** field, type the IP address to assign to the device.  
Choose an IP address from the router's LAN subnet, such as 10.168.168.x.
  - b. In the **MAC Address** field, type the MAC address of the device.
  - c. In the **Device Name** field, type a name for the device
7. Click the **Apply** button.  
The reserved address is entered into the table.  
The reserved address is not assigned until the next time the device contacts the router's DHCP server. Reboot the device, or access its IP configuration and force a DHCP release and renew.

## Edit a reserved IP address

### To edit a reserved address entry:

1. Launch a web browser from a computer or mobile device that is connected to your Orbi network.
2. Enter **orbilogin.com** (Windows and Android devices) or **orbilogin.local** (Apple MacOS and iOS devices).  
A login window displays.
3. Enter the Orbi admin user name and password.  
The user name is **admin**. The password is the one that you specified when you set up your Orbi. The user name and password are case-sensitive.  
The BASIC Home page displays.
4. Select **ADVANCED > Setup > LAN Setup**.  
The LAN Setup page displays.
5. Select the radio button next to the reserved address.
6. Click the **Edit** button.  
The Address Reservation page displays.
7. Change the settings.
8. Click the **Apply** button.  
Your settings are saved.

# Delete a reserved IP address entry

## To delete a reserved address entry:

1. Launch a web browser from a computer or mobile device that is connected to your Orbi network.
2. Enter **orbilogin.com** (Windows and Android devices) or **orbilogin.local** (Apple MacOS and iOS devices).  
A login window displays.
3. Enter the Orbi admin user name and password.  
The user name is **admin**. The password is the one that you specified when you set up your Orbi. The user name and password are case-sensitive.  
The BASIC Home page displays.
4. Select **ADVANCED > Setup > LAN Setup**.  
The LAN Setup page displays.
5. Select the radio button next to the reserved address.
6. Click the **Delete** button.  
The address is removed.

# Manage custom static routes

For almost all Internet traffic, routes are automatically and dynamically selected. You can also set up a fixed, static route. Typically, you only need to add static routes when you have more than one router or multiple IP subnets on your network.

As an example of when a static route is needed, consider the following case:

- Your main Internet access is through a cable modem to your ISP. The cable modem is connected to your router.
- Your network also includes an ADSL router that you use to access a remote office site. This ADSL router is connected to a DSL modem, which is used on-demand only.
- Your LAN subnet is 192.168.1.0, and the ADSL router's address on your LAN is 192.168.1.100.
- The public IP address range at the remote office site is 134.177.0.0.

When you set up your router, two implicit static routes were created:

1. A default route was created between your router and the cable modem that connects to your ISP.
2. A second static route was created between your router and your LAN for all 192.168.1.0 addresses.

With this configuration, if you try to access a device on the 134.177.0.0 network at the remote office site, your router forwards your request to your ISP. In turn, the ISP forwards your request to the remote office site, where the firewall will deny the request.

In this situation, you must define a static route, telling your router to access 134.177.0.0 addresses through your ADSL router at its LAN address of 192.168.1.100.

Here is an example static route setting for this configuration:

- **Destination IP address and subnet mask settings:** The route applies to all addresses at the remote site, so set the destination IP address to 134.177.0.0 and the subnet mask to 255.255.255.0.
- **Gateway IP address:** Traffic for addresses in the 134.177.0.0 network must be forwarded to the ADSL router, so set the gateway IP address to 192.168.1.100 (the ADSL router's address on your LAN).
- **Private route:** Make the static route private as a security precaution in case Routing Information Protocol (RIP) is activated. A private route is not reported in RIP messages.

## Set up a static route

### To set up a static route:

1. Launch a web browser from a computer or mobile device that is connected to your Orbi network.
2. Enter **orbilogin.com** (Windows and Android devices) or **orbilogin.local** (Apple MacOS and iOS devices).  
A login window displays.
3. Enter the Orbi admin user name and password.  
The user name is **admin**. The password is the one that you specified when you set up your Orbi. The user name and password are case-sensitive.  
The BASIC Home page displays.
4. Select **ADVANCED > Advanced > Static Routes**.  
The Static Routes page displays.
5. Click the **Add** button.  
The page adjusts.
6. In the **Route Name** field, type a name for this static route (for identification purposes only.)

- To limit access to the LAN only, select the **Private** check box.  
If Private is selected, the static route is not reported in RIP.
- Select the **Active** check box to make this route take effect.
- Type the IP address of the final destination.
- Type the IP subnet mask for this destination.  
If the destination is a single host, type **255.255.255.255**.
- Type the gateway IP address.  
This address must be on the same LAN segment as the router.
- Type a number from 2 through 15 as the metric value.  
This value represents the number of routers between your network and the destination. Usually, a setting of 2 or 3 works.
- Click the **Apply** button.  
The static route is added.

## Edit a static route

### To edit a static route:

- Launch a web browser from a computer or mobile device that is connected to your Orbi network.
- Enter **orbilogin.com** (Windows and Android devices) or **orbilogin.local** (Apple MacOS and iOS devices).  
A login window displays.
- Enter the Orbi admin user name and password.  
The user name is **admin**. The password is the one that you specified when you set up your Orbi. The user name and password are case-sensitive.  
The BASIC Home page displays.
- Select **ADVANCED > Advanced > Static Routes**.  
The Static Routes page displays.
- In the table, select the radio button for the route.
- Click the **Edit** button.  
The Static Routes page adjusts.
- Edit the route information.
- Click the **Apply** button.  
Your settings are saved.

# Delete a static route

## To delete a static route:

1. Launch a web browser from a computer or mobile device that is connected to your Orbi network.
2. Enter **orbilogin.com** (Windows and Android devices) or **orbilogin.local** (Apple MacOS and iOS devices).  
A login window displays.
3. Enter the Orbi admin user name and password.  
The user name is **admin**. The password is the one that you specified when you set up your Orbi. The user name and password are case-sensitive.  
The BASIC Home page displays.
4. Select **ADVANCED > Advanced > Static Routes**.  
The Static Routes page displays.
5. In the table, select the radio button for the route.
6. Click the **Delete** button.  
The route is removed from the table.

# Change the router back to router mode

If you set up your Orbi router as an access point, you can change it back to a router.

## To change the router back to router mode:

1. Launch a web browser from a computer or mobile device that is connected to your Orbi network.
2. Enter **orbilogin.com** (Windows and Android devices) or **orbilogin.local** (Apple MacOS and iOS devices).  
A login window displays.
3. Enter the Orbi admin user name and password.  
The user name is **admin**. The password is the one that you specified when you set up your Orbi. The user name and password are case-sensitive.  
The BASIC Home page displays.
4. Select **ADVANCED > Advanced > Router / AP Mode**.

The Router / AP Mode page displays.

5. Select the **Router Mode** radio button.

The page adjusts.

6. Click the **Apply** button.

Your settings are saved and the router restarts.

# Improve network connections with Universal Plug and Play

Universal Plug and Play (UPnP) helps devices, such as Internet appliances and computers, access the network and connect to other devices as needed. UPnP devices can automatically discover the services from other registered UPnP devices on the network.

If you use applications such as multiplayer gaming, peer-to-peer connections, or real-time communications such as instant messaging or remote assistance, enable UPnP.

## To enable Universal Plug and Play:

1. Launch a web browser from a computer or mobile device that is connected to your Orbi network.

2. Enter **orbilogin.com** (Windows and Android devices) or **orbilogin.local** (Apple MacOS and iOS devices).

A login window displays.

3. Enter the Orbi admin user name and password.

The user name is **admin**. The password is the one that you specified when you set up your Orbi. The user name and password are case-sensitive.

The BASIC Home page displays.

4. Select **ADVANCED > Advanced > UPnP**.

The UPnP page displays.

5. Select the **Turn UPnP On** check box.

By default, this check box is selected. UPnP for automatic device configuration can be enabled or disabled. If the **Turn UPnP On** check box is cleared, the router does not allow any device to automatically control router resources, such as port forwarding.

6. Type the advertisement period in minutes.

The advertisement period specifies how often the router broadcasts its UPnP information. This value can range from 1 to 1440 minutes. The default period is 30

minutes. Shorter durations ensure that control points receive current device status at the expense of more network traffic. Longer durations can compromise the freshness of the device status but can significantly reduce network traffic.

7. Type the advertisement time to live in hops.

The time to live for the advertisement is measured in hops (steps) for each UPnP packet sent. Hops are the steps a packet takes between routers. The number of hops can range from 1 to 255. The default value for the advertisement time to live is 4 hops, which should be fine for most home networks. If you notice that some devices are not being updated or reached correctly, it might be necessary to increase this value.

8. Click the **Apply** button.

The UPnP Portmap Table displays the IP address of each UPnP device that is accessing the router and which ports (internal and external) that device opened. The UPnP Portmap Table also displays what type of port is open and whether that port is still active for each IP address.

9. To refresh the information in the UPnP Portmap Table, click the **Refresh** button.

## Set up a bridge for a port group or VLAN tag group

Some devices, such as IPTVs, cannot function behind the router's Network Address Translation (NAT) service or firewall. Based on what your Internet service provider (ISP) requires for the device to connect to the ISP's network directly, you can enable the bridge between the device and the router's Internet port or add new VLAN tag groups to the bridge.

**!** **NOTE:** If your ISP provides directions on how to set up a bridge for IPTV and Internet service, follow those directions.

**!** **NOTE:** This feature is only supported if the router is in router mode.

## Set up a bridge for a port group

If the devices that are connected to the router's Ethernet LAN port include an IPTV device, your ISP might require you to set up a bridge for a port group for the router's Internet interface.



A bridge with a port group prevents packets that are sent between the IPTV device and the router's Internet port from being processed through the router's Network Address Translation (NAT) service.

### To configure a port group and enable the bridge:

1. Launch a web browser from a computer or mobile device that is connected to your Orbi network.
2. Enter **orbilogin.com** (Windows and Android devices) or **orbilogin.local** (Apple MacOS and iOS devices).  
A login window displays.
3. Enter the Orbi admin user name and password.  
The user name is **admin**. The password is the one that you specified when you set up your Orbi. The user name and password are case-sensitive.  
The BASIC Home page displays.
4. Select **ADVANCED > Advanced > VLAN / Bridge Settings**.  
The VLAN / Bridge Settings page displays.
5. Select the **Enable VLAN / Bridge Settings** check box.  
The page expands.
6. Select the **By bridge group** radio button.  
The section expands.
7. Select the **Wired Ports** check box that corresponds to the Ethernet port on the router to which the device is connected.  
You must select at least one **Wired Ports** check box. You can select more than one check box.
8. Click the **Apply** button.  
Your settings are saved.

## Set up a bridge for a VLAN tag group

If the devices that are connected to the router's Ethernet LAN ports include an IPTV device, your ISP might require you to set up a bridge for a VLAN tag group for the router's Internet interface.

If you are subscribed to IPTV service, the router might require VLAN tags to distinguish between the Internet traffic and the IPTV traffic. A bridge with a VLAN tag group prevents packets that are sent between the IPTV device and the router's Internet port from being processed through the router's Network Address Translation (NAT) service.

You can add VLAN tag groups to a bridge and assign VLAN IDs and priority values to each VLAN tag group.

### To add a VLAN tag group and enable the bridge:

1. Launch a web browser from a computer or mobile device that is connected to your Orbi network.
2. Enter **orbilogin.com** (Windows and Android devices) or **orbilogin.local** (Apple MacOS and iOS devices).

A login window displays.

3. Enter the Orbi admin user name and password.

The user name is **admin**. The password is the one that you specified when you set up your Orbi. The user name and password are case-sensitive.

The BASIC Home page displays.

4. Select **ADVANCED > Advanced > VLAN / Bridge Settings**.

The VLAN / Bridge Settings page displays.

5. Select the **Enable VLAN / Bridge Group** check box.

The page expands.

6. Select the **By VLAN tag group** radio button.

The section expands.

7. Click the **Add** button.

The Add VLAN Rule page displays.

The table includes default VLAN 10 that has all Ethernet ports and WiFi networks as members. This VLAN is enabled by default.

8. Specify the settings as described in the following table.

Field	Description
Name	Enter a name for the VLAN tag group. The name can be up to 10 characters.
VLAN ID	Enter a value from 1 to 4094.
Priority	Enter a value from 0 to 7.

9. Select the check box for a wired Ethernet port.

If your device is connected to an Ethernet port on the router, select the Ethernet port check box that corresponds to the Ethernet port on the router to which the device is connected.

You must select at least one Ethernet port. You can select more than one port.

10. Click the **Add** button.

The VLAN tag group is added.

11. Click the **Apply** button.

Your settings are saved.

# 7

## Maintain and Monitor Your Network

---

This chapter describes the router settings for administering and maintaining your router and home network.

The chapter includes the following sections:

- [Update the router and satellite firmware](#)
- [Change the admin password](#)
- [Enable admin password reset](#)
- [Reset the admin password](#)
- [Always use HTTPS to access the router](#)
- [View router status and usage information](#)
- [Display Internet port statistics](#)
- [Check the Internet connection status](#)
- [View and manage logs of router activity](#)
- [View devices connected to the network or edit device information](#)
- [View satellites connected to the network or edit satellite information](#)
- [View the satellite status](#)
- [Monitor, meter, and control Internet traffic](#)
- [Change the NTP server](#)
- [Set the time zone](#)
- [Manage the router configuration file](#)

# Update the router and satellite firmware

You can use the router web interface to check if new firmware is available and update your router and satellites, or you can manually update the firmware for your router and satellites.

## Check for firmware updates

### To check for new firmware and update your router and satellite:

1. Launch a web browser from a computer or mobile device that is connected to your Orbi network.
2. Enter **orbilogin.com** (Windows and Android devices) or **orbilogin.local** (Apple MacOS and iOS devices).  
A login window displays.
3. Enter the Orbi admin user name and password.  
The user name is **admin**. The password is the one that you specified when you set up your Orbi. The user name and password are case-sensitive.  
The BASIC Home page displays.
4. Select **ADVANCED > Administration > Firmware Update > Online Update**.  
The Firmware Update page displays.
5. Click the **Check** button.  
The router checks to see if new firmware is available for the router and satellites.
6. If new firmware is available, click the **Update All** button.  
The router locates and downloads the firmware for the router and satellites and begins the update.

 **WARNING:** To avoid the risk of corrupting the firmware, do not interrupt the upgrade. For example, do not close the browser, click a link, or load a new page. Do not turn off the router or satellite.

When the upload is complete, your router and satellites restart. The update process typically takes about two minutes. Read the new firmware release notes to find out if you must reconfigure the router after updating.

# Manage automatic firmware updates

By default, the Orbi system automatically updates to the latest firmware if it detects new firmware. You can disable the automatic updates if you prefer to update manually.

## To manage automatic firmware updates:

1. Launch a web browser from a computer or mobile device that is connected to your Orbi network.
2. Enter **orbilogin.com** (Windows and Android devices) or **orbilogin.local** (Apple MacOS and iOS devices).  
A login window displays.
3. Enter the Orbi admin user name and password.  
The user name is **admin**. The password is the one that you specified when you set up your Orbi. The user name and password are case-sensitive.  
The BASIC Home page displays.
4. Select **ADVANCED > Administration > Firmware Update > Online Update**.  
The Firmware Update page displays.
5. Enable or disable automatic firmware updates by selecting one of the radio buttons:
  - **Enable**: Automatic firmware updates are enabled. This is the default setting.
  - **Disable**: Automatic firmware updates are disabled.
6. Click the **Apply** button.  
Your settings are saved.

# Manually update firmware

If a satellite is connected to your router, you can log in to the router to manually upload the firmware on your satellite.

 **WARNING:** We recommend that you always update the firmware on your satellite first, and then update your router. Also, do not update the firmware on your router and satellite at the same time, and do not update more than one Orbi device (router or satellite) at a time. If you need to update more than one Orbi device, wait for the first Orbi device to finish updating before updating your next Orbi device.

### To manually update the firmware on your Orbi router and satellites, follow these high level steps:

1. Visit [netgear.com/support](https://netgear.com/support) and download the firmware for both your Orbi router and satellites.
2. Update the firmware on your Orbi satellites, one at a time.  
For more information, see [Manually update satellite firmware](#) on page 95.
3. Update the firmware on your Orbi router.  
For more information, see [Manually update router firmware](#) on page 96.

## Manually update satellite firmware

We recommend that you update your satellites' firmware *before* you update the router's firmware.

### To manually update your satellites' firmware:

1. Launch a web browser from a computer or mobile device that is connected to your Orbi network.
2. Enter **orbilogin.com** (Windows and Android devices) or **orbilogin.local** (Apple MacOS and iOS devices).  
A login window displays.
3. Enter the Orbi admin user name and password.  
The user name is **admin**. The password is the one that you specified when you set up your Orbi. The user name and password are case-sensitive.  
The BASIC Home page displays.
4. Select **ADVANCED > Administration > Firmware Update > Manual Update**.  
The Firmware Update page displays.
5. Select the check box next to your satellite's model name.  
If you have more than one satellite, only update one satellite at a time. You must wait for the first satellite to finish updating before updating the next satellite.
6. Click the **Update** button.  
The Orbi satellite Firmware Update window displays.
7. If the browser asks you for the admin password, enter the same password that you entered for the router.
8. Click the **Browse** button.
9. Locate and select the satellite firmware file that you downloaded.  
The firmware file name ends in `.img`.
10. Click the **Upload** button.

The upload process starts.

 **WARNING:** To avoid the risk of corrupting the firmware, do not interrupt the upgrade. For example, do not close the browser, click a link, or load a new page. Do not turn off the satellite.

When the upload is complete, your satellite restarts. The update process typically takes about two minutes.

## Manually update router firmware

We recommend that you update your router's firmware *after* you update the satellites' firmware.

 **WARNING:** Make sure that your satellites completes their firmware updates before you update your router's firmware.

### To manually update your router's firmware:

1. Launch a web browser from a computer or mobile device that is connected to your Orbi network.
2. Enter **orbilogin.com** (Windows and Android devices) or **orbilogin.local** (Apple MacOS and iOS devices).

A login window displays.

3. Enter the Orbi admin user name and password.

The user name is **admin**. The password is the one that you specified when you set up your Orbi. The user name and password are case-sensitive.

The BASIC Home page displays.

4. Select **ADVANCED > Administration > Firmware Update > Manual Update**.

The Firmware Update page displays.

5. Click the **Browse** button.
6. Locate and select the router firmware file you downloaded.

The firmware file name ends in **.img**.

7. Click the **Upload** button.

The upload process starts.

 **WARNING:** To avoid the risk of corrupting the firmware, do not interrupt the upgrade. For example, do not close the browser, click a link, or load a new page. Do not turn off the router.

When the upload is complete, your router restarts. The update process typically takes about two minutes.



# Change the admin password

This feature lets you change the default password that is used to log in to the router with the user name admin. This password is not the one that you use to access the Orbi WiFi network.

**!** **NOTE:** Be sure to change the admin password to a secure password. The ideal password contains no dictionary words from any language and contains uppercase and lowercase letters, numbers, and symbols. It can be up to 30 characters.

## To set the password for the user name admin:

1. Launch a web browser from a computer or mobile device that is connected to your Orbi network.
2. Enter **orbilogin.com** (Windows and Android devices) or **orbilogin.local** (Apple MacOS and iOS devices).  
A login window displays.
3. Enter the Orbi admin user name and password.  
The user name is **admin**. The password is the one that you specified when you set up your Orbi. The user name and password are case-sensitive.  
The BASIC Home page displays.
4. Select **ADVANCED > Administration > Set Password**.  
The Set Password page displays.
5. Type the old password, and type the new password twice.
6. To be able to reset the password, select the **Enable Password Reset** check box.  
We recommend that you enable password reset.
7. Click the **Apply** button.  
Your settings are saved.

# Enable admin password reset

The router admin password is used to log in to your router web interface. We recommend that you enable the password reset feature so that you can reset the password if it is forgotten. This reset process is supported in Chrome, Safari, Firefox, Edge, and Internet Explorer.

**To enable password reset:**

1. Launch a web browser from a computer or mobile device that is connected to your Orbi network.
2. Enter **orbilogin.com** (Windows and Android devices) or **orbilogin.local** (Apple MacOS and iOS devices).  
A login window displays.
3. Enter the Orbi admin user name and password.  
The user name is **admin**. The password is the one that you specified when you set up your Orbi. The user name and password are case-sensitive.  
The BASIC Home page displays.
4. Select **ADVANCED > Administration > Set Password**.  
The Set Password page displays.
5. Select the **Enable Password Reset** check box.
6. Select two security questions and provide answers to them.
7. Click the **Apply** button.  
Your settings are saved.

## Reset the admin password

If you set up the password reset feature, you can recover your router admin password.

**!** **NOTE:** If you did not enable router password recovery, you must perform a factory reset to set a new admin password. For more information, see [Orbi router hardware features](#) on page 10.

**To reset your admin password::**

1. Launch a web browser from a computer or mobile device that is connected to your Orbi network.
2. Enter **orbilogin.com** (Windows and Android devices) or **orbilogin.local** (Apple MacOS and iOS devices).  
A login window displays.
3. Click the **Cancel** button.  
If password reset is enabled, you are prompted to enter the router's serial number.
4. Enter the router's serial number in the field.  
You can find the router's serial number on the router label.
5. Click the **CONTINUE** button.

6. Enter your answers to the security questions.  
You defined these answers when you set up the password reset feature.
7. Click the **CONTINUE** button.  
You are requested to set a new admin password and set new security questions.
8. Enter your new admin password, set new security questions and answers, and click the **NEXT** button.  
Your settings are saved.
9. Click the **LOGIN AGAIN** button.  
A login window displays.
10. With your new admin password, log in to the router.

# Always use HTTPS to access the router

You can configure the router to require HTTPS connections between your web browser and the router web interface, for example, "https://www.orbilogin.com". When you enable the HTTPS requirement, connection requests to the router web interface that specify HTTP are automatically converted to HTTPS.

**!** **NOTE:** After you enable the HTTPS requirement, when you visit the router web interface, your browser might display a security warning because of the self-signed certificate on the router. This is expected behavior. You can proceed, or add an exception for the security warning. For more information, visit [kb.netgear.com/000062980/what-to-do-incase-of-security-message](https://kb.netgear.com/000062980/what-to-do-incase-of-security-message).

To require HTTPS connections:

1. Launch a web browser from a computer or mobile device that is connected to your Orbi network.
2. Enter **orbilogin.com** (Windows and Android devices) or **orbilogin.local** (Apple MacOS and iOS devices).  
A login window displays.
3. Enter the Orbi admin user name and password.  
The user name is **admin**. The password is the one that you specified when you set up your Orbi. The user name and password are case-sensitive.  
The BASIC Home page displays.
4. Select **ADVANCED > Advanced > Web Services Management**.

The Web Services Management page displays.

5. Select the **Always Use HTTPS to Access Router** check box.
6. Click the **Apply** button.

Your settings are saved.

## View router status and usage information

### To view router status and usage information:

1. Launch a web browser from a computer or mobile device that is connected to your Orbi network.
2. Enter **orbilogin.com** (Windows and Android devices) or **orbilogin.local** (Apple MacOS and iOS devices).

A login window displays.

3. Enter the Orbi admin user name and password.

The user name is **admin**. The password is the one that you specified when you set up your Orbi. The user name and password are case-sensitive.

The BASIC Home page displays.

4. Click the **ADVANCED** tab.

The ADVANCED Home page displays the router status.

## Display Internet port statistics

### To display Internet port statistics:

1. Launch a web browser from a computer or mobile device that is connected to your Orbi network.
2. Enter **orbilogin.com** (Windows and Android devices) or **orbilogin.local** (Apple MacOS and iOS devices).

A login window displays.

3. Enter the Orbi admin user name and password.

The user name is **admin**. The password is the one that you specified when you set up your Orbi. The user name and password are case-sensitive.

The BASIC Home page displays.

4. Click the **ADVANCED** tab.
5. In the Internet Port pane, click the **Show Statistics** button.

The Show Statistics window displays and shows following information:

- **System Up Time.** The time elapsed since the router was last restarted.
  - **Port.** The statistics for the WAN (Internet) and LAN (Ethernet) ports. For each port, the page displays the following information:
    - **Status:** The link status of the port.
    - **TxPkts:** The number of packets transmitted on this port since reset or manual clear.
    - **RxPkts:** The number of packets received on this port since reset or manual clear.
    - **Collisions:** The number of collisions on this port since reset or manual clear.
    - **Tx B/s:** The current transmission (outbound) bandwidth used on the WAN and LAN ports.
    - **Rx B/s:** The current reception (inbound) bandwidth used on the WAN and LAN ports.
    - **Up Time:** The time elapsed since this port acquired the link.
    - **Poll Interval:** The interval at which the statistics are updated in this page.
6. To change the polling frequency, enter a time in seconds in the **Poll Interval** field and click the **Set Interval** button.
  7. To stop the polling entirely, click the **Stop** button.

# Check the Internet connection status

## To check the Internet connection status:

1. Launch a web browser from a computer or mobile device that is connected to your Orbi network.
2. Enter **orbilogin.com** (Windows and Android devices) or **orbilogin.local** (Apple MacOS and iOS devices).  
A login window displays.
3. Enter the Orbi admin user name and password.

The user name is **admin**. The password is the one that you specified when you set up your Orbi. The user name and password are case-sensitive.

The BASIC Home page displays.

4. Click the **ADVANCED** tab.
5. In the Internet Port pane, click the **Connection Status** button.

The Connection Status window displays. The information that displays depends on the type of Internet connection.

For example, if your Internet connection does not require a login and the router receives an IP address automatically, the window displays the following information:

- **IP Address:** The IP address that is assigned to the router.
  - **Subnet Mask:** The subnet mask that is assigned to the router.
  - **Default Gateway:** The IP address for the default gateway that the router communicates with.
  - **DHCP Server:** The IP address for the Dynamic Host Configuration Protocol server that provides the TCP/IP configuration for all the computers that are connected to the router.
  - **DNS Server:** The IP address of the Domain Name Service server that provides translation of network names to IP addresses.
  - **Lease Obtained:** The date and time when the lease was obtained.
  - **Lease Expires:** The date and time that the lease expires.
6. To release (stop) the Internet connection, click the **Release** button.  
If you are using a PPPoE, PPTP, or L2TP connection, the name of the button might be different.
  7. To renew the Internet connection, click the **Renew** button.  
If you are using a PPPoE, PPTP, or L2TP connection, the name of the button might be different.
  8. To exit the page, click the **Close Window** button.

# View and manage logs of router activity

The log is a detailed record of the websites you accessed or attempted to access and other router actions. Up to 256 entries are stored in the log.

### To view and manage logs:

1. Launch a web browser from a computer or mobile device that is connected to your Orbi network.
2. Enter **orbilogin.com** (Windows and Android devices) or **orbilogin.local** (Apple MacOS and iOS devices).  
A login window displays.
3. Enter the Orbi admin user name and password.  
The user name is **admin**. The password is the one that you specified when you set up your Orbi. The user name and password are case-sensitive.  
The BASIC Home page displays.
4. Select **ADVANCED > Administration > Logs**.  
The Logs page displays the following information:
  - **Date and time.** The date and time the log entry was recorded.
  - **Source IP.** The IP address of the initiating device for this log entry.
  - **Target address.** The name or IP address of the website or news group visited or to which access was attempted.
  - **Action.** The action that occurred, such as whether Internet access was blocked or allowed.
5. To refresh the log page, click the **Refresh** button.
6. To clear the log entries, click the **Clear Log** button.

## View devices connected to the network or edit device information

You can view the devices that are connected to your Orbi network. You can also edit the information that displays on the Attached Devices page in the router web interface.

## View devices connected to the network

You can view all computers or devices that are currently connected to your Orbi network.

### To view devices connected to your network:

1. Launch a web browser from a computer or mobile device that is connected to your Orbi network.
2. Enter **orbilogin.com** (Windows and Android devices) or **orbilogin.local** (Apple MacOS and iOS devices).

A login window displays.

3. Enter the Orbi admin user name and password.

The user name is **admin**. The password is the one that you specified when you set up your Orbi. The user name and password are case-sensitive.

The BASIC Home page displays.

4. Select **Attached Devices**.

The Attached Devices page displays the following information in the Connected Devices section:

- **Status:** Displays only if you enable network access control (see [Network access control list](#) on page 50). The field displays if a device is allowed or blocked.
- **Device Name:** This section displays the device model, name, type, and IP address.
- **IP Address:** This section displays the device IP address. The device's IP address can change because the router assigns an IP address to each device when it joins the network.
- **MAC Address:** This section displays the device MAC address. The unique MAC address for each device does not change.
- **Connection Type:** This section displays how the device is connected to the Orbi network through a wired Ethernet connection or a 2.4 GHz, 5 GHz, or 6 GHz WiFi connection.
- **Connected Orbi:** This section displays the Orbi router or satellite that the device is connected to. The Orbi router's or satellite's MAC address also displays.

If you configured VPN (see [Use OpenVPN to Access Your Network](#) on page 128) and any VPN client devices are connected to the router, the following information is displayed in a separate table:

- **Device Name:** If the device name is known, it is shown here.
- **Remote IP Address:** The device IP address at the remote location
- **Local IP Address:** The device IP address at the router network.
- **Connection Time:** The time that the VPN connection is active.

5. To update this page, click the **Refresh** button.



# Edit device information on the Attached Devices page

You can change the connected device model and name that display on the Attached Devices page.

## To view devices connected to your network:

1. Launch a web browser from a computer or mobile device that is connected to your Orbi network.
2. Enter **orbilogin.com** (Windows and Android devices) or **orbilogin.local** (Apple MacOS and iOS devices).  
A login window displays.
3. Enter the Orbi admin user name and password.  
The user name is **admin**. The password is the one that you specified when you set up your Orbi. The user name and password are case-sensitive.  
The BASIC Home page displays.
4. Select **Attached Devices**.  
The Attached Devices page displays.
5. In the Device Name column, click a field for a connected device that displays on the page.  
The Edit Device page displays.
6. To change the device model information, enter a new model in the **Device Model** field.
7. To change the device name, enter a new name in the **Device Name** field.
8. To change the device group, select a group option from the **Device Group** menu.
9. To change the device type, select a device from the **Device Type** menu.
10. Click the **Apply** button.  
Your settings are saved.

# View satellites connected to the network or edit satellite information

You can view the satellites that are connected to your Orbi network. You can also edit the information that displays on the Attached Devices page in the router web interface.

# View satellites connected to the network

You can view the satellites that are connected to your Orbi network.

## To view satellites connected to your network:

1. Launch a web browser from a computer or mobile device that is connected to your Orbi network.

2. Enter **orbilogin.com** (Windows and Android devices) or **orbilogin.local** (Apple MacOS and iOS devices).

A login window displays.

3. Enter the Orbi admin user name and password.

The user name is **admin**. The password is the one that you specified when you set up your Orbi. The user name and password are case-sensitive.

The BASIC Home page displays.

4. Select **Attached Devices**.

The Attached Devices page displays the following information in the Connected Satellites section:

- **Device Name:** This section displays the satellite model, name, and IP address.
- **IP Address:** This section displays the satellite IP address. The satellite's IP address can change because the router assigns an IP address to each satellite when it joins the network.
- **MAC Address:** This section displays the satellite MAC address. The unique MAC address for each satellite does not change.
- **Connection Type:** This section displays how the satellite is connected to the Orbi network through a wired Ethernet connection or a 2.4 GHz, 5 GHz, or 6 GHz WiFi connection.
- **Connected Orbi:** This section displays the Orbi router or satellite that the satellite is connected to. The Orbi router's or satellite's MAC address also displays.
- **Backhaul Status:** This section displays the backhaul connection status between the satellite and router or another satellite.

5. To update this page, click the **Refresh** button.

# Edit satellite information that displays on the Attached Devices page

You can change the satellite's device name that displays on the Attached Devices page.

**To edit the satellite's device name that displays on the Attached Devices page:**

1. Launch a web browser from a computer or mobile device that is connected to your Orbi network.
2. Enter **orbilogin.com** (Windows and Android devices) or **orbilogin.local** (Apple MacOS and iOS devices).  
A login window displays.
3. Enter the Orbi admin user name and password.  
The user name is **admin**. The password is the one that you specified when you set up your Orbi. The user name and password are case-sensitive.  
The BASIC Home page displays.
4. Select **Attached Devices**.  
The Attached Devices page displays.
5. Select a connected device that displays on the page.  
The Edit Device page displays.
6. To change the device name, enter a new name in the **Device Name** field.
7. Click the **Apply** button.  
Your settings are saved.

## View the satellite status

To view your satellite's status, it must be connected to your Orbi network.

**To view your satellite's status:**

1. Launch a web browser from a computer or mobile device that is connected to your Orbi network.
2. Enter **orbilogin.com** (Windows and Android devices) or **orbilogin.local** (Apple MacOS and iOS devices).  
A login window displays.
3. Enter the Orbi admin user name and password.  
The user name is **admin**. The password is the one that you specified when you set up your Orbi. The user name and password are case-sensitive.  
The BASIC Home page displays.
4. Select **Attached Devices**.  
The Attached Devices page displays.
5. In the Connected Satellites section, find your satellite's IP address.

6. Enter your satellite's IP address in your web browser's address bar.  
A login window displays.
7. Enter the same admin user name and password that you entered for the router.  
The satellite's status displays.

## Monitor, meter, and control Internet traffic

Traffic metering allows you to monitor the volume of Internet traffic that passes through the router Internet port. With the traffic meter utility, you can set limits for traffic volume, set a monthly limit, and get a live update of traffic usage.

### Start the traffic meter without traffic volume restrictions

You can monitor the traffic volume without setting a limit.

**To start or restart the traffic meter without configuring traffic volume restrictions:**

1. Launch a web browser from a computer or mobile device that is connected to your Orbi network.
2. Enter **orbilogin.com** (Windows and Android devices) or **orbilogin.local** (Apple MacOS and iOS devices).  
A login window displays.
3. Enter the Orbi admin user name and password.  
The user name is **admin**. The password is the one that you specified when you set up your Orbi. The user name and password are case-sensitive.  
The BASIC Home page displays.
4. Select **ADVANCED > Advanced Setup > Traffic Meter**.  
The Traffic Meter page displays.
5. Select the **Enable Traffic Meter** check box.  
By default, no traffic limit is specified and the traffic volume is not controlled.
6. In the Traffic Counter section, set the traffic counter to begin at a specific time and date.

7. To start the traffic counter immediately, click the **Restart Counter Now** button.
8. Click the **Apply** button.

Your settings are saved and the router restarts.

The Internet Traffic Statistics section helps you to monitor the data traffic. For more information, see [View the Internet traffic volume and statistics](#) on page 111.

## Restrict Internet traffic by volume

You can record and restrict the traffic by volume in MB. This is useful when your ISP measures your traffic in volume.

### To record and restrict the Internet traffic by volume:

1. Launch a web browser from a computer or mobile device that is connected to your Orbi network.
2. Enter **orbilogin.com** (Windows and Android devices) or **orbilogin.local** (Apple MacOS and iOS devices).  
A login window displays.
3. Enter the Orbi admin user name and password.  
The user name is **admin**. The password is the one that you specified when you set up your Orbi. The user name and password are case-sensitive.  
The BASIC Home page displays.
4. Select **ADVANCED > Advanced Setup > Traffic Meter**.  
The Traffic Meter page displays.
5. Select the **Enable Traffic Meter** check box.
6. Select the **Traffic volume control by** radio button.
7. From the corresponding menu, select an option:
  - **Download only**: The restriction is applied to incoming traffic only.
  - **Both Directions**: The restriction is applied to both incoming and outgoing traffic.
8. In the **Monthly Limit** field, enter how many MBytes (MB) per month are allowed.
9. If your ISP charges you for extra data volume when you make a new connection, enter the extra data volume in MB in the **Round up data volume for each connection by** field.
10. In the Traffic Counter section, set the traffic counter to begin at a specific time and date.
11. In the Traffic Control section, enter a value in MB to specify when the router issues a warning message before the monthly limit in volume is reached.

This setting is optional. The router generates a warning when the balance falls below the volume that you enter. By default, the value is 0 and no warning message is issued.

12. In the Traffic Control section, to let the router disconnect and disable the Internet connection when the traffic limit is reached, select the **Disconnect and disable the Internet connection** check box.
13. Click the **Apply** button.

Your settings are saved and the router restarts.

The Internet Traffic Statistics section helps you to monitor data traffic. For more information, see [View the Internet traffic volume and statistics](#) on page 111.

## Restrict Internet traffic by connection time

You can record and restrict traffic by connection time. This is useful when your ISP measures your connection time.

### To record and restrict Internet traffic by connection time:

1. Launch a web browser from a computer or mobile device that is connected to your Orbi network.
2. Enter **orbilogin.com** (Windows and Android devices) or **orbilogin.local** (Apple MacOS and iOS devices).

A login window displays.

3. Enter the Orbi admin user name and password.

The user name is **admin**. The password is the one that you specified when you set up your Orbi. The user name and password are case-sensitive.

The BASIC Home page displays.

4. Select **ADVANCED > Advanced Setup > Traffic Meter**.

The Traffic Meter page displays.

5. Select the **Enable Traffic Meter** check box.

6. Select the **Connection time control** radio button.

**!** **NOTE:** The router must be connected to the Internet for you to be able to select the **Connection time control** radio button.

7. In the **Monthly Limit** field, enter how many hours per month are allowed.

**!** **NOTE:** The router must be connected to the Internet for you to be able to enter information in the **Monthly Limit** field.

8. In the Traffic Counter section, set the traffic counter to begin at a specific time and date.

9. In the Traffic Control section, enter a value in minutes to specify when the router issues a warning message before the monthly limit in hours is reached.

This setting is optional. The router generates a warning when the balance falls under the number of minutes that you enter. By default, the value is 0 and no warning message is issued.

10. In the Traffic Control section, to let the router disconnect and disable the Internet connection when the traffic limit is reached, select the **Disconnect and disable the Internet connection** check box.

11. Click the **Apply** button.

Your settings are saved and the router restarts.

The Internet Traffic Statistics section helps you to monitor data traffic. For more information, see [View the Internet traffic volume and statistics](#) on page 111.

## View the Internet traffic volume and statistics

If you enabled the traffic meter (see [Start the traffic meter without traffic volume restrictions](#) on page 108), you can view the Internet traffic volume and statistics.

### To view the Internet traffic volume and statistics shown by the traffic meter:

1. Launch a web browser from a computer or mobile device that is connected to your Orbi network.
2. Enter **orbilogin.com** (Windows and Android devices) or **orbilogin.local** (Apple MacOS and iOS devices).

A login window displays.

3. Enter the Orbi admin user name and password.

The user name is **admin**. The password is the one that you specified when you set up your Orbi. The user name and password are case-sensitive.

The BASIC Home page displays.

4. Select **ADVANCED > Advanced Setup > Traffic Meter**.

The Traffic Meter page displays.

5. Scroll down to the Internet Traffic Statistics section.

The Internet Traffic Statistics section displays when the traffic counter was started and what the traffic balance is. The table displays information about the connection time and traffic volume in MB.

6. To refresh the information onscreen, click the **Refresh** button.

The information is updated.

7. To display more information about the data traffic and to change the polling interval, click the **Traffic Status** button.

The Traffic Status pop-up window displays.

## Unblock the traffic meter after the traffic limit is reached

If you configured the traffic meter to disconnect and disable the Internet connection after the traffic limit is reached, you cannot access the Internet until you unblock the traffic meter.

 **CAUTION:** If your ISP set a traffic limit, your ISP might charge you for the overage traffic.

### To unblock the traffic meter:

1. Launch a web browser from a computer or mobile device that is connected to your Orbi network.
2. Enter **orbilogin.com** (Windows and Android devices) or **orbilogin.local** (Apple MacOS and iOS devices).  
A login window displays.
3. Enter the Orbi admin user name and password.

The user name is **admin**. The password is the one that you specified when you set up your Orbi. The user name and password are case-sensitive.

The BASIC Home page displays.

4. Select **ADVANCED > Advanced Setup > Traffic Meter**.  
The Traffic Meter page displays.
5. In the Traffic Control section, clear the **Disconnect and disable the Internet connection** check box.
6. Click the **Apply** button.

Your settings are saved and the router restarts.

## Change the NTP server

By default, the router uses the NETGEAR Network Time Protocol (NTP) server to sync the network time. You can change the NTP server to your preferred NTP server.



**To change the NTP server to your preferred NTP server:**

1. Launch a web browser from a computer or mobile device that is connected to your Orbi network.
2. Enter **orbilogin.com** (Windows and Android devices) or **orbilogin.local** (Apple MacOS and iOS devices).  
A login window displays.
3. Enter the Orbi admin user name and password.  
The user name is **admin**. The password is the one that you specified when you set up your Orbi. The user name and password are case-sensitive.  
The BASIC Home page displays.
4. Select **ADVANCED > Administration > NTP Settings**.  
The NTP Settings page displays.
5. Select the **Set your preferred NTP server** radio button.
6. Enter the NTP server domain name or IP address in the **Primary NTP server** field.
7. Click the **Apply** button.  
Your settings are saved.

## Set the time zone

**To set your time zone manually:**

1. Launch a web browser from a computer or mobile device that is connected to your Orbi network.
2. Enter **orbilogin.com** (Windows and Android devices) or **orbilogin.local** (Apple MacOS and iOS devices).  
A login window displays.
3. Enter the Orbi admin user name and password.  
The user name is **admin**. The password is the one that you specified when you set up your Orbi. The user name and password are case-sensitive.  
The BASIC Home page displays.
4. Select **ADVANCED > Administration > NTP Settings**.  
The NTP Settings page displays.
5. Select your time zone from the menu.

6. If you live in a region that observes daylight saving time, select the **Automatically adjust for daylight savings time** check box.
7. Click the **Apply** button.  
Your settings are saved.

## Manage the router configuration file

The configuration settings of the router are stored within the router in a configuration file. You can back up (save) this file to your computer, restore it, or reset it to the factory default settings.

### Back up settings

#### **To back up the router's configuration settings:**

1. Launch a web browser from a computer or mobile device that is connected to your Orbi network.
2. Enter **orbilogin.com** (Windows and Android devices) or **orbilogin.local** (Apple MacOS and iOS devices).  
A login window displays.
3. Enter the Orbi admin user name and password.  
The user name is **admin**. The password is the one that you specified when you set up your Orbi. The user name and password are case-sensitive.  
The BASIC Home page displays.
4. Select **ADVANCED > Administration > Backup Settings**.  
The Backup Settings page displays.
5. Click the **BACK UP** button.
6. Specify a location on your network.  
A copy of the current settings is saved in the location you specified.

# Restore configuration settings

## To restore configuration settings that you backed up:

1. Launch a web browser from a computer or mobile device that is connected to your Orbi network.
2. Enter **orbilogin.com** (Windows and Android devices) or **orbilogin.local** (Apple MacOS and iOS devices).  
A login window displays.
3. Enter the Orbi admin user name and password.  
The user name is **admin**. The password is the one that you specified when you set up your Orbi. The user name and password are case-sensitive.  
The BASIC Home page displays.
4. Select **ADVANCED > Administration > Backup Settings**.  
The Backup Settings page displays.
5. Click the **BROWSE** button to find and select the **.cfg** file.
6. Click the **RESTORE** button.  
The file is uploaded to the router and the router reboots.

 **WARNING:** Do not interrupt the reboot process.

# Erase the current configuration settings

You can erase the current configuration and restore the factory default settings. You might want to do this if you move the router to a different network.

## To erase the configuration settings:

1. Launch a web browser from a computer or mobile device that is connected to your Orbi network.
2. Enter **orbilogin.com** (Windows and Android devices) or **orbilogin.local** (Apple MacOS and iOS devices).  
A login window displays.
3. Enter the Orbi admin user name and password.  
The user name is **admin**. The password is the one that you specified when you set up your Orbi. The user name and password are case-sensitive.  
The BASIC Home page displays.
4. Select **ADVANCED > Administration > Backup Settings**.

The Backup Settings page displays.

5. Click the **ERASE** button.

The factory default settings are restored. The user name is admin, the password is password, and the LAN IP address is 10.168.168.1. DHCP is enabled.

# 8

## Customize Internet Traffic Rules for Ports

---

You can use port forwarding and port triggering to set up rules for Internet traffic. You need networking knowledge to set up these features.

This chapter includes the following sections:

- [Manage port forwarding to a local server](#)
- [Manage port triggering](#)

# Manage port forwarding to a local server

If your home network includes a server, you can allow certain types of incoming traffic to reach the server. For example, you might want to make a local web server, FTP server, or game server visible and available to the Internet.

The router can forward incoming traffic with specific protocols to computers on your local network. You can specify the servers for applications and you can also specify a default DMZ server to which the router forwards all other incoming protocols.

## Set up port forwarding to a local server

### To forward specific incoming protocols to a local server:

1. Decide which type of service, application, or game you want to provide.
2. Find the local IP address of the computer on your network that will provide the service.

The server computer must always use the same IP address. To specify this setting, use the reserved IP address feature. See [Manage reserved LAN IP addresses](#) on page 81.

3. Launch a web browser from a computer or mobile device that is connected to your Orbi network.
4. Enter **orbilogin.com** (Windows and Android devices) or **orbilogin.local** (Apple MacOS and iOS devices).

A login window displays.

5. Enter the Orbi admin user name and password.

The user name is **admin**. The password is the one that you specified when you set up your Orbi. The user name and password are case-sensitive.

The BASIC Home page displays.

6. Select **ADVANCED > Advanced > Port Forwarding / Port Triggering**.

The Port Forwarding / Port Triggering page displays.

7. Leave the **Port Forwarding** radio button selected as the service type.
8. From the **Service Name** menu, select the service name.

If the service that you want to add is not in the menu, create a custom service. See [Add a custom port forwarding service](#) on page 119.

9. In the **Server IP Address** field, enter the IP address of the computer that must provide the service.
10. Click the **Add** button.  
The service displays in the table.

## Add a custom port forwarding service

### To add a custom service:

1. Find out which port number or range of numbers the application uses.  
You can usually find this information by contacting the publisher of the application or user groups or news groups.
2. Launch a web browser from a computer or mobile device that is connected to your Orbi network.
3. Enter **orbilogin.com** (Windows and Android devices) or **orbilogin.local** (Apple MacOS and iOS devices).  
A login window displays.
4. Enter the Orbi admin user name and password.  
The user name is **admin**. The password is the one that you specified when you set up your Orbi. The user name and password are case-sensitive.  
The BASIC Home page displays.
5. Select **ADVANCED > Advanced > Port Forwarding / Port Triggering**.  
The Port Forwarding / Port Triggering page displays.
6. Leave the **Port Forwarding** radio button selected as the service type.
7. Click the **Add Custom Service** button.  
The Ports - Custom Services page displays.
8. In the **Service Name** field, enter a descriptive name.
9. In the **Protocol** menu, select the protocol.  
If you are unsure, select **TCP/UDP**.
10. In the **External Port range** field, enter the port numbers.
11. Specify the internal ports by one of these methods:
  - Leave the **Use the same port range for Internal port** check box selected.
  - Type the port numbers in the **Internal port range** field.

12. Type the IP address in the **Internal IP address** fields or select the radio button for an attached device listed in the table.
13. Click the **Apply** button.  
Your settings are saved. The service is now in the table on the Port Forwarding / Port Triggering page.

## Edit a port forwarding service

### To edit a port forwarding entry:

1. Launch a web browser from a computer or mobile device that is connected to your Orbi network.
2. Enter **orbilogin.com** (Windows and Android devices) or **orbilogin.local** (Apple MacOS and iOS devices).  
A login window displays.
3. Enter the Orbi admin user name and password.  
The user name is **admin**. The password is the one that you specified when you set up your Orbi. The user name and password are case-sensitive.  
The BASIC Home page displays.
4. Select **ADVANCED > Advanced > Port Forwarding / Port Triggering**.  
The Port Forwarding / Port Triggering page displays.
5. Leave the **Port Forwarding** radio button selected as the service type.
6. In the table, select the radio button next to the service name.
7. Click the **Edit Service** button.  
The Ports - Custom Services page displays.
8. Change any of the following settings:
  - **Service Name:** Type the service name.
  - **Protocol:** Select the protocol.  
If you are unsure, select **TCP/UP**.
  - **External port range:** Enter the port numbers.
  - For the internal ports, leave the **Use the same port range for Internal port** check box selected or enter the ports in the **Internal port range** field.
  - **Internal IP address:** Type the IP address in the **Internal IP address** fields, or select the radio button for an attached device listed in the table.
9. Click the **Apply** button.



Your settings are saved. The service is changed in the table on the Port Forwarding / Port Triggering page.

## Delete a port forwarding entry

### To delete a port forwarding entry:

1. Launch a web browser from a computer or mobile device that is connected to your Orbi network.
2. Enter **orbilogin.com** (Windows and Android devices) or **orbilogin.local** (Apple MacOS and iOS devices).  
A login window displays.
3. Enter the Orbi admin user name and password.  
The user name is **admin**. The password is the one that you specified when you set up your Orbi. The user name and password are case-sensitive.  
The BASIC Home page displays.
4. Select **ADVANCED > Advanced > Port Forwarding / Port Triggering**.  
The Port Forwarding / Port Triggering page displays.
5. Select the **Port Forwarding** radio button as the service type.
6. In the table, select the radio button next to the service name.
7. Click the **Delete Service** button.  
The port forwarding entry is removed from the table.

## How the router implements the port forwarding rule

The following sequence shows the effects of a port forwarding rule:

1. When you type the URL `www.example.com` in your browser, the browser sends a web page request message with the following destination information:
  - **Destination address:** The IP address of `www.example.com`, which is the address of your router.
  - **Destination port number:** 80, which is the standard port number for a web server process.
2. Your router receives the message and finds your port forwarding rule for incoming port 80 traffic.

3. The router changes the destination in the message to IP address 10.168.168.123 and sends the message to that computer.
4. Your web server at IP address 10.168.168.123 receives the request and sends a reply message to your router.
5. Your router performs Network Address Translation (NAT) on the source IP address, and sends the reply through the Internet to the computer or WiFi device that sent the web page request.

## Application example: Make a local web server public

If you host a web server on your local network, you can use port forwarding to allow web requests from anyone on the Internet to reach your web server.

### **To make a local web server public:**

1. Assign your web server either a fixed IP address or a dynamic IP address using DHCP address reservation.

In this example, your router always gives your web server an IP address of 192.168.1.33.

2. On the Port Forwarding/Port Triggering page, configure the router to forward the HTTP service to the local address of your web server at 192.168.1.33.

HTTP (port 80) is the standard protocol for web servers.

3. (Optional) Register a host name with a Dynamic DNS service, and specify that name on the Dynamic DNS page of the router.

Dynamic DNS makes it much easier to access a server from the Internet because you can type the name in the Internet browser. Otherwise, you must know the IP address that the ISP assigned, which typically changes.

## Manage port triggering

Port triggering is a dynamic extension of port forwarding that is useful in these cases:

- An application must use port forwarding to more than one local computer (but not simultaneously).
- An application must open incoming ports that are different from the outgoing port.

With port triggering, the router monitors traffic to the Internet from an outbound “trigger” port that you specify. For outbound traffic from that port, the router saves the IP address

of the computer that sent the traffic. The router temporarily opens the incoming port or ports that you specify in your rule and forwards that incoming traffic to that destination. Port forwarding creates a static mapping of a port number or range of ports to a single local computer. Port triggering can dynamically open ports to any computer when needed and close the ports when they are no longer needed.

# Add a port triggering service

### To add a port triggering service:

1. Launch a web browser from a computer or mobile device that is connected to your Orbi network.
2. Enter **orbilogin.com** (Windows and Android devices) or **orbilogin.local** (Apple MacOS and iOS devices).  
A login window displays.
3. Enter the Orbi admin user name and password.  
The user name is **admin**. The password is the one that you specified when you set up your Orbi. The user name and password are case-sensitive.  
The BASIC Home page displays.
4. Select **ADVANCED > Advanced > Port Forwarding / Port Triggering**.  
The Port Forwarding / Port Triggering page displays.
5. Select the **Port Triggering** radio button.  
The page adjusts.
6. Click the **Add Service** button.  
The Port Triggering - Services page displays.
7. In the **Service Name** field, type a descriptive service name.
8. In the **Service User** menu, select **Any**, or select **Single address** and enter the IP address of one computer:
  - **Any**: This selection (the default) allows any computer on the local area network (LAN) to use this service.
  - **Single address**: This selection restricts the service to a particular computer on the LAN. Enter the IP address in the field that becomes available with this selection from the menu.
9. From the **Service Type** menu, select the service type, either **TCP** or **UDP**.
10. In the **Triggering Port** field, enter the number of the outbound traffic port that must open the inbound ports.

11. From the **Connection Type** menu, select the inbound connection type, **TCP**, **UDP**, or **TCP/UDP**.

If you are not sure, select **TCP/UDP**.

12. Enter the inbound connection port numbers the **Starting Port**, and **Ending Port** fields.

For a single port, enter the same number in each field.

13. Click the **Apply** button.

The service is now in the Portmap Table.

## Edit a port triggering service

### To edit a port triggering service:

1. Launch a web browser from a computer or mobile device that is connected to your Orbi network.

2. Enter **orbilogin.com** (Windows and Android devices) or **orbilogin.local** (Apple MacOS and iOS devices).

A login window displays.

3. Enter the Orbi admin user name and password.

The user name is **admin**. The password is the one that you specified when you set up your Orbi. The user name and password are case-sensitive.

The BASIC Home page displays.

4. Select **ADVANCED > Advanced > Port Forwarding / Port Triggering**.

The Port Forwarding / Port Triggering page displays.

5. Select the **Port Triggering** radio button.

The port triggering settings display.

6. In the Port Triggering Portmap Table, select the radio button for the service.

7. Click the **Edit Service** button.

The Port Triggering Services page displays.

8. Change any of the following settings.

- **Service Name:** Type the service name.
- **Service User:** From the menu, select **Any**, or select **Single address** and enter the IP address of one computer:

- **Any:** This selection (the default) allows any computer on the local area network (LAN) to use this service.
  - **Single address:** This selection restricts the service to a particular computer on the LAN. Enter the IP address in the field that becomes available with this selection from the menu.
  - **Service Type:** From the menu, select the service type, which can be **TCP** or **UDP**.
  - **Triggering Port:** Enter the number of the outbound traffic port that must open the inbound ports.
  - **Connection Type:** From the menu, select the inbound connection type, which can be **TCP**, **UDP**, or **TCP/UDP**.  
If you are not sure, select **TCP/UDP**.
  - **Starting Port** and **Ending Port:** Enter the inbound connection port numbers.  
For a single port, enter the same number in each field.
9. Click the **Apply** button.

Your settings are saved. The changed service displays in the Port Triggering Portmap Table on the Port Forwarding / Port Triggering page.

## Disable port triggering or change the time-out period

By default, port triggering is enabled and a default time-out period is defined. You can disable port triggering or change the time-out period.

### To disable port triggering or change the time-out period:

1. Launch a web browser from a computer or mobile device that is connected to your Orbi network.
2. Enter **orbilogin.com** (Windows and Android devices) or **orbilogin.local** (Apple MacOS and iOS devices).  
A login window displays.
3. Enter the Orbi admin user name and password.  
The user name is **admin**. The password is the one that you specified when you set up your Orbi. The user name and password are case-sensitive.  
The BASIC Home page displays.
4. Select **ADVANCED > Advanced > Port Forwarding / Port Triggering**.  
The Port Forwarding / Port Triggering page displays.
5. Select the **Port Triggering** radio button.

The page adjusts.

6. To disable port triggering, select the **Disable Port Triggering** check box.  
If this check box is selected, the router does not use port triggering even if you specified port triggering settings.
7. To change the time-out period, in the **Port Triggering Timeout** field, enter a value up to 9999 minutes.  
This value controls how long the inbound ports stay open when the router detects no activity. This value is required because the router cannot detect when the application terminates.

## Delete a port triggering service

### To delete a port triggering service:

1. Launch a web browser from a computer or mobile device that is connected to your Orbi network.
2. Enter **orbilogin.com** (Windows and Android devices) or **orbilogin.local** (Apple MacOS and iOS devices).  
A login window displays.
3. Enter the Orbi admin user name and password.  
The user name is **admin**. The password is the one that you specified when you set up your Orbi. The user name and password are case-sensitive.  
The BASIC Home page displays.
4. Select **ADVANCED > Advanced > Port Forwarding / Port Triggering**.  
The Port Forwarding / Port Triggering page displays.
5. Select the **Port Triggering** radio button.  
The port triggering settings display.
6. In the Port Triggering Portmap Table, select the radio button for the service.
7. Click the **Delete Service** button.  
Your settings are saved. The service is removed from the Port Triggering Portmap Table.

# Application example: Port triggering for Internet Relay Chat

Some application servers, such as FTP and IRC servers, send replies to multiple port numbers. Using port triggering, you can tell the router to open more incoming ports when a particular outgoing port starts a session.

An example is Internet Relay Chat (IRC). Your computer connects to an IRC server at destination port 6667. The IRC server not only responds to your originating source port, but also sends an “identify” message to your computer on port 113. Using port triggering, you can tell the router, “When you initiate a session with destination port 6667, you must also allow incoming traffic on port 113 to reach the originating computer.” The following sequence shows the effects of the port triggering rule you define:

1. You open an IRC client program to start a chat session on your computer.
2. Your IRC client composes a request message to an IRC server using a destination port number of 6667, the standard port number for an IRC server process. Your computer then sends this request message to your router.
3. Your router creates an entry in its internal session table describing this communication session between your computer and the IRC server. Your router stores the original information, performs Network Address Translation (NAT) on the source address and port, and sends this request message through the Internet to the IRC server.
4. Noting your port triggering rule and observing the destination port number of 6667, your router creates another session entry to send any incoming port 113 traffic to your computer.
5. The IRC server sends a return message to your router using the NAT-assigned source port (for example, port 33333) as the destination port. The IRC server also sends an “identify” message to your router with destination port 113.
6. When your router receives the incoming message to destination port 33333, it checks its session table to see if a session is active for port number 33333. Finding an active session, the router restores the original address information replaced by NAT and sends this reply message to your computer.
7. When your router receives the incoming message to destination port 113, it checks its session table and finds an active session for port 113 associated with your computer. The router replaces the message’s destination IP address with your computer’s IP address and forwards the message to your computer.
8. When you finish your chat session, your router eventually senses a period of inactivity in the communications. The router then removes the session information from its session table, and incoming traffic is no longer accepted on port numbers 33333 or 113.

# 9

## Use OpenVPN to Access Your Network

---

You can use OpenVPN software to remotely access your router with virtual private networking (VPN). This chapter explains how to install and use OpenVPN software to set up a VPN tunnel.

The chapter contains the following sections:

- [About VPN connections](#)
- [LAN IP addressing in VPN networks](#)
- [Enable OpenVPN service in the router](#)
- [Install OpenVPN software on a VPN client](#)
- [Use VPN to access your Internet service at home](#)



# About VPN connections

A virtual private network (VPN) lets you use the Internet to securely access your network when you aren't home.

This type of VPN access is called a client-to-gateway tunnel. The computer is the client, and the router is the gateway. To use the VPN feature, you must do the following:

- Log in to the router to enable and configure OpenVPN (see [Enable OpenVPN service in the router](#) on page 130).
- Install OpenVPN client software and configuration files on your device from which you want to use VPN (see [Install OpenVPN software on a VPN client](#) on page 131).
- Run the OpenVPN client software on your device when you want to use a VPN connection.

Enabling OpenVPN on your router allows VPN connections between the router and a client, for example your laptop when you are away from home. The router provides the VPN service and the laptop is the VPN client. Traffic between the router and the laptop is encrypted.

**!** **NOTE:** The router itself does not function as a VPN client to an external VPN service provider, so it does not encrypt traffic passing between your home network and the Internet.

VPN can use either Dynamic DNS (DDNS) or a static IP address to connect with your router:

- To use a DDNS service, register for a DDNS account with a host name. You use the host name to access your network. The router supports these DDNS accounts: NETGEAR, No-IP, and Dyn. For more information, see [Manage Dynamic DNS](#) on page 73.
- If your Internet service provider (ISP) assigned a static WAN IP address that never changes, the VPN can use that IP address to connect to your home network.

## LAN IP addressing in VPN networks

For the VPN connection to work, your computer or device (the VPN client) must be connected to a network that uses a different LAN IP address scheme than your router.

The default LAN IP address scheme for the router is 192.168.1.x. (The most common IP schemes are 192.168.x.x, 172.x.x.x, and 10.x.x.x.) If you experience a conflict, change the IP scheme either for your home network or for the network where your VPN client device is connected.

If both networks use the same LAN IP scheme, when the VPN tunnel is established, you cannot access your home router or your home network with the OpenVPN software.

For information about changing the LAN settings on the router, see [Change the LAN IP or RIP settings](#) on page 77.

# Enable OpenVPN service in the router

You must enable the OpenVPN service settings in the router before you can use a VPN connection.

## To enable OpenVPN service:

1. Launch a web browser from a computer or mobile device that is connected to your Orbi network.

2. Enter **orbilogin.com** (Windows and Android devices) or **orbilogin.local** (Apple MacOS and iOS devices).

A login window displays.

3. Enter the Orbi admin user name and password.

The user name is **admin**. The password is the one that you specified when you set up your Orbi. The user name and password are case-sensitive.

The BASIC Home page displays.

4. Select **ADVANCED > Advanced > VPN Service**.

The VPN Service page displays.

**!** **NOTE:** The OpenVPN configuration software packages that you can download on the page are for the VPN client devices (see [Install OpenVPN software on a VPN client](#) on page 131).

5. Select the **Enable VPN Service** check box.

We recommend that you use the default TUN mode and TAP mode settings. (These settings determine how VPN information is transferred.) If you know that you need other settings, you can change the TUN mode and TAP mode settings, but you must do so *before* you download and install the OpenVPN configuration software packages on client devices (see [Install OpenVPN software on a VPN client](#) on page 131).

6. To change the TUN mode settings, do the following:

- To change the TUN mode service type, select the **UDP** or **TCP** radio button.

The default protocol for TUN mode is UDP.

- To change the TUN mode service port, type the port number that you want to use in the field.

The default port number for TUN mode is 12973. The TUN port number is used in the `.ovpn` file of the OpenVPN configuration software package for Mac and non-Windows clients.

7. To change the TAP mode settings, do the following:

- To change the TAP mode service type, select the **UDP** or **TCP** radio button.

The default protocol for TAP mode is UDP.

- To change the TAP mode service port, type the port number that you want to use in the field.

The default port number for TAP mode is 12974. The TAP port number is used in the `.ovpn` file of the OpenVPN configuration software package for Windows clients.

8. Click the **Apply** button.

Your changes are saved. VPN is enabled in the router, but you must install and set up OpenVPN software on your device before you can use a VPN connection.

# Install OpenVPN software on a VPN client

You must install OpenVPN software on each Windows-based computer, Mac computer, iOS device, and Android device that you plan to use for VPN connections to your router. Each computer or device is called a VPN client.

The software consists of the application software and the configuration files:

- Download and install the application software from the link that is provided in each client-specific section.
- Download and install the configuration files from the router as described in each client-specific section. The configuration files provide the correct router configuration information for the client utility. You must download the configuration files *after* you enable and configure OpenVPN service in the router (see [Enable OpenVPN service in the router](#) on page 130).

**!** **NOTE:** If you later change the OpenVPN configuration in the router (for example, you change the TUN or TAP port number), you must download and install the `.ovpn` configuration file again on each client, depending on its operating system. If you change the TUN port number in the router, the `.ovpn` configuration file for Mac and non-Windows clients changes. If you change the TAP port number in the router, the `.ovpn` configuration file for Windows clients changes.

## Install OpenVPN software on a Windows-based computer

You must install both the OpenVPN client utility and OpenVPN configuration files on each Windows-based computer where you want to use a VPN connection to your router.

### To download and install the OpenVPN client utility and OpenVPN configuration files on a Windows-based computer:

1. To download the OpenVPN client utility on your Windows-based computer, visit [openvpn.net/community-downloads/](https://openvpn.net/community-downloads/).
2. Select the Windows package with the installer files.  
In most situations, you can download the Windows 32-bit or Windows 64-bit installer files, depending on your Windows operating system.
3. Download and install the OpenVPN client utility on your computer.  
You need to have administrative privileges.
4. Launch a web browser from a computer or mobile device that is connected to your Orbi network.
5. Enter **orbilogin.com** (Windows and Android devices) or **orbilogin.local** (Apple MacOS and iOS devices).  
A login window displays.
6. Enter the Orbi admin user name and password.  
The user name is **admin**. The password is the one that you specified when you set up your Orbi. The user name and password are case-sensitive.  
The BASIC Home page displays.
7. Select **ADVANCED > Advanced > VPN Service**.  
The VPN Service page displays.
8. Make sure that the **Enable VPN Service** check box is selected.  
For more information about the VPN configuration for the router, see [Enable OpenVPN service in the router](#) on page 130.

9. Click the **For Windows** button to download the router's OpenVPN configuration files to your Windows-based computer.
10. Unzip the OpenVPN configuration files and copy them to the folder in which you installed the OpenVPN client utility.
11. Modify the VPN interface name to **NETGEAR-VPN**:
  - a. If your computer is running Windows 10, select **Control Panel > Network and Sharing Center > Change adapter settings**.  
If your computer is running another Windows version, find the page that lets you change the adapter settings.
  - b. In the local area connection list, find the local area connection with the device name **TAP-Windows Adapter**.
  - c. Select the local area connection and change its name (*not* its device name) to **NETGEAR-VPN**.

If you do not change the VPN interface name, the VPN tunnel connection will fail.

You can now open a VPN tunnel to the router.

For more information about installing and using OpenVPN on your Windows-based computer, visit <https://openvpn.net/community-resources/how-to/#quick>.

## Install OpenVPN software on a Mac computer

You must install both the Tunnelblick OpenVPN client utility and OpenVPN configuration files on each Mac computer where you want to use a VPN connection to your router.

### **To download and install the Tunnelblick OpenVPN client utility and OpenVPN configuration files on a Mac computer:**

1. To download the Tunnelblick OpenVPN client utility on your Mac computer, visit <https://tunnelblick.net/downloads.html>.
2. Download and install the Tunnelblick OpenVPN client utility on your Mac computer.  
You need to have administrative privileges.
3. Launch a web browser from a computer or mobile device that is connected to your Orbi network.
4. Enter **orbilogin.com** (Windows and Android devices) or **orbilogin.local** (Apple MacOS and iOS devices).  
A login window displays.
5. Enter the Orbi admin user name and password.

The user name is **admin**. The password is the one that you specified when you set up your Orbi. The user name and password are case-sensitive.

The BASIC Home page displays.

6. Select **ADVANCED > Advanced > VPN Service**.

The VPN Service page displays.

7. Make sure that the **Enable VPN Service** check box is selected.

For more information about the VPN configuration for the router, see [Enable OpenVPN service in the router](#) on page 130.

8. Click the **For MacOSX** button to download the router's OpenVPN configuration files to your Mac computer.
9. Unzip the OpenVPN configuration files and copy them to the folder in which you installed the Tunnelblick OpenVPN client utility.

You can now open a VPN tunnel to the router.

For more information about installing and using OpenVPN on your Mac computer, visit <https://openvpn.net/vpn-server-resources/installation-guide-for-openvpn-connect-client-on-macos/>.

## Install OpenVPN software on an iOS device

You must install both the OpenVPN Connect app and OpenVPN configuration files on each iOS device where you want to use a VPN connection to your router.

### To download and install the OpenVPN Connect app and OpenVPN configuration files on an iOS device:

1. On your iOS device, download and install the OpenVPN Connect app from the Apple app store.
2. Launch a web browser from a computer or mobile device that is connected to your Orbi network.
3. Enter **orbilogin.com** (Windows and Android devices) or **orbilogin.local** (Apple MacOS and iOS devices).

A login window displays.

4. Enter the Orbi admin user name and password.

The user name is **admin**. The password is the one that you specified when you set up your Orbi. The user name and password are case-sensitive.

The BASIC Home page displays.

5. Select **ADVANCED > Advanced > VPN Service**.

The VPN Service page displays.

6. Make sure that the **Enable VPN Service** check box is selected.

For more information about the VPN configuration for the router, see [Enable OpenVPN service in the router](#) on page 130.

7. Click the **For Smart Phone** button to download the router's OpenVPN configuration files to your computer or iOS device.

If you download the configuration files to your computer, unzip the files, and send them your iOS device.

8. On your iOS device, do the following:
  - a. Open the `.ovpn` file.
  - b. If the OpenVPN Connect app does not start automatically, a list of apps might display: Select the OpenVPN Connect app.
  - c. Install the `.ovpn` file.

You can now open a VPN tunnel to the router.

For more information about installing and using OpenVPN on your iOS device, visit [https://www.vpngate.net/en/howto\\_openvpn.aspx#ios](https://www.vpngate.net/en/howto_openvpn.aspx#ios).

## Install OpenVPN software on an Android device

You must install both the OpenVPN Connect app and OpenVPN configuration files on each Android device where you want to use a VPN connection to your router.

### **To download and install the OpenVPN Connect app and OpenVPN configuration files on an Android device:**

1. On your Android device, download and install the OpenVPN Connect app from the Google Play Store.
2. Launch a web browser from a computer or mobile device that is connected to your Orbi network.
3. Enter **orbilogin.com** (Windows and Android devices) or **orbilogin.local** (Apple MacOS and iOS devices).

A login window displays.

4. Enter the Orbi admin user name and password.

The user name is **admin**. The password is the one that you specified when you set up your Orbi. The user name and password are case-sensitive.

The BASIC Home page displays.

5. Select **ADVANCED > Advanced > VPN Service**.

The VPN Service page displays.

6. Make sure that the **Enable VPN Service** check box is selected.  
For more information about the VPN configuration for the router, see [Enable OpenVPN service in the router](#) on page 130.
7. Click the **For Smart Phone** button to download the router's OpenVPN configuration files to your computer or Android device.  
If you download the configuration files to your computer, unzip the files, and send them your Android device.
8. On your Android device, open the `.ovpn` file and import it into the OpenVPN Connect app.

You can now open a VPN tunnel to the router.

For more information about using OpenVPN on your Android device, visit [https://www.vpngate.net/en/howto\\_openvpn.aspx#android](https://www.vpngate.net/en/howto_openvpn.aspx#android).

## Use VPN to access your Internet service at home

When you're away from home and you access the Internet, you usually use a local Internet service provider. For example, at a coffee shop you might be given a code that lets you use the coffee shop's Internet service account to surf the web.

Your router lets you use a VPN connection to access your own Internet service when you're away from home. You might want to do this if you travel to a geographic location that doesn't support all the Internet services that you use at home. For example, your Netflix account might work at home but not in a different country.

## Allow VPN client Internet access in the router

By default, the router is set up to allow VPN connections only to your home network, but you can change the settings to allow Internet access. Accessing the Internet remotely through a VPN might be slower than accessing the Internet directly.

### **To allow VPN clients to use your home Internet service:**

1. Launch a web browser from a computer or mobile device that is connected to your Orbi network.
2. Enter **orbilogin.com** (Windows and Android devices) or **orbilogin.local** (Apple MacOS and iOS devices).

A login window displays.



3. Enter the Orbi admin user name and password.

The user name is **admin**. The password is the one that you specified when you set up your Orbi. The user name and password are case-sensitive.

The BASIC Home page displays.

4. Select **ADVANCED > Advanced > VPN Service**.

The VPN Service page displays.

5. Make sure that the **Enable VPN Service** check box is selected.

For more information about the VPN configuration for the router, see [Enable OpenVPN service in the router](#) on page 130.

6. Scroll down to the Clients will use this VPN connection to access section, and select the **All sites on the Internet & Home Network** radio button.

When you access the Internet with the VPN connection, instead of using a local Internet service, you use the Internet service from your home network.

7. Click the **Apply** button.

Your settings are saved.

## Block VPN client Internet access in the router

By default, the router is set up to allow VPN connections only to your home network, not to the Internet service for your home network. If you changed this setting to allow Internet access, you can change it back.

### **To allow VPN clients to access only your home network and block them from using the Internet service for your home network:**

1. Launch a web browser from a computer or mobile device that is connected to your Orbi network.

2. Enter **orbilogin.com** (Windows and Android devices) or **orbilogin.local** (Apple MacOS and iOS devices).

A login window displays.

3. Enter the Orbi admin user name and password.

The user name is **admin**. The password is the one that you specified when you set up your Orbi. The user name and password are case-sensitive.

The BASIC Home page displays.

4. Select **ADVANCED > Advanced > VPN Service**.

The VPN Service page displays.

5. Make sure that the **Enable VPN Service** check box is selected.

For more information about the VPN configuration for the router, see [Enable OpenVPN service in the router](#) on page 130.

6. Scroll down to the Clients will use this VPN connection to access section, and select the **Home Network only** radio button.

This is the default setting. The VPN connection is only to your home network, not to the Internet service for your home network.

7. Click the **Apply** button.

Your settings are saved.

# 10

## Troubleshooting

---

This chapter provides information to help you diagnose and solve problems you might experience with your Orbi router or satellite. If you do not find the solution here, check the NETGEAR support site at [netgear.com/support](http://netgear.com/support) for product and contact information.

This chapter includes the following sections:

- [Quick tips](#)
- [The router and satellites do not sync](#)
- [You cannot log in to the router](#)
- [You cannot access the Internet](#)
- [Troubleshoot Internet browsing](#)
- [Troubleshoot PPPoE](#)
- [Troubleshoot WiFi connectivity](#)
- [Troubleshoot your network using the ping utility](#)

# Quick tips

This section describes tips for troubleshooting some common problems.

## Sequence to restart your network

When you restart your network, follow this sequence:

1. Turn off and unplug the modem.
2. Turn off the router.
3. Plug in the modem and turn it on.  
Wait two minutes.
4. Turn on the router and wait two minutes.

## WiFi settings

Make sure that the WiFi settings in the WiFi-enabled computer or mobile device and the router match.

The WiFi network name (SSID) and WiFi security settings must match exactly.

If you set up an access list, you must add each WiFi-enabled device's MAC address to the router's access list.

## Network settings

Make sure that the network settings of the computer are correct. Wired and wirelessly connected computers must use network (IP) addresses on the same network as the router. The simplest way to do this is to configure each computer to obtain an IP address automatically using DHCP.

Some cable modem service providers require you to use the MAC address of the computer initially registered on the account. You can view the MAC address on the Attached Devices page.

# The router and satellites do not sync

If you are experiencing difficulty syncing the router and the satellites, we recommend that you move the problem satellites into the same room as the router during the sync. Then move the satellites to a different location.

## To sync the router and satellites:

1. Place the satellite in the same room as the Orbi router.  
Use this satellite location only during the sync process.
2. Connect the satellite to a power source.
3. Wait for the satellite LED to light solid white or magenta.
4. Press the **Sync** button on the router and then within two minutes, press the **Sync** button on the satellite.
5. Wait for the satellite to light.

The satellite LED pulses white while it attempts to sync with the router. After the LED pulses white, it lights one of the following colors:

- **Blue:** The Orbi router and satellite successfully synced, and the connection between the router and satellite is good.
  - **Amber:** The Orbi router and satellite failed to sync. Try repeating Step 4 again. If the sync keeps failing, try moving the satellite to a different location that's closer to the router.
6. Move the satellite to a new location and connect the satellite to a power source.
  7. At the new location, check the satellite LED and make sure it lights blue.  
If the satellite LED lights blue, the satellite synced successfully. If the satellite LED lights amber, move the satellite closer to the router and try again. The satellite must be within range of the router's WiFi cover area for a good connection to the router.

# You cannot log in to the router

Make sure that your computer or mobile device is connected to the Orbi WiFi network. If you do not want to use a WiFi connection, you can connect your computer to the Orbi router with an Ethernet cable.

If you changed the admin password and you forgot what it is, see [Reset the admin password](#) on page 98.

# You cannot access the Internet

Check your network and Internet connections:

1. Make sure that your WiFi-enabled computer or mobile device is connected to the Orbi network.
2. If you are connected to Orbi but you cannot access the Internet, check to see if your Internet connection is working.
3. Launch a web browser from a computer or mobile device that is connected to your Orbi network.

4. Enter **orbilogin.com** (Windows and Android devices) or **orbilogin.local** (Apple MacOS and iOS devices).

A login window displays.

5. Enter the Orbi admin user name and password.

The user name is **admin**. The password is the one that you specified when you set up your Orbi. The user name and password are case-sensitive.

The BASIC Home page displays.

6. Click the **ADVANCED** tab.

The ADVANCED Home page displays.

7. Check that an IP address is shown for the Internet port.

If 0.0.0.0 is shown, your router did not obtain an IP address from your Internet service provider (ISP).

If your router cannot obtain an IP address from the ISP, you can force your cable or DSL modem to recognize your new router by restarting your network. For more information, see [Sequence to restart your network](#) on page 140.

If your router is still unable to obtain an IP address from the ISP, the problem might be one of the following:

- Your Internet service provider (ISP) might require a login program. Ask your ISP whether they require PPP over Ethernet (PPPoE) or some other type of login.
- If your ISP requires a login, the login name and password might be set incorrectly.
- Your ISP might check for your computer's host name. Assign the computer host name of your ISP account as the account name on the Internet Setup page.
- If your ISP allows only one Ethernet MAC address to connect to Internet and checks for your computer's MAC address, do one of the following:
  - Inform your ISP that you bought a new network device and ask them to use the router's MAC address.
  - Configure your router to clone your computer's MAC address.

# Troubleshoot Internet browsing

If your router can obtain an IP address but your computer is unable to load any web pages from the Internet, it might be for one of the following reasons:

- The traffic meter is enabled, and the limit was reached.  
By configuring the traffic meter not to block Internet access when the traffic limit is reached, you can resume Internet access. If your ISP sets a usage limit, they might charge you for the overage.
- Your computer might not recognize any DNS server addresses. A DNS server is a host on the Internet that translates Internet names (such as www addresses) to numeric IP addresses.  
Typically, your ISP provides the addresses of one or two DNS servers for your use. If you entered a DNS address during the router's configuration, restart your computer.  
Alternatively, you can configure your computer manually with a DNS address, as explained in the documentation for your computer.
- The router might not be configured as the default gateway on your computer.  
Reboot the computer and verify that the router address ([www.orbilogin.com](http://www.orbilogin.com) or [www.orbilogin.local](http://www.orbilogin.local)) is listed by your computer as the default gateway address.
- You might be running login software that is no longer needed. If your ISP provided a program to log you in to the Internet, you no longer need to run that software after installing your router.

# Troubleshoot PPPoE

If you are using PPPoE, try troubleshooting your Internet connection.

## To troubleshoot a PPPoE connection:

1. Launch a web browser from a computer or mobile device that is connected to your Orbi network.
2. Enter **orbilogin.com** (Windows and Android devices) or **orbilogin.local** (Apple MacOS and iOS devices).  
A login window displays.
3. Enter the Orbi admin user name and password.  
The user name is **admin**. The password is the one that you specified when you set up your Orbi. The user name and password are case-sensitive.  
The BASIC Home page displays.

4. Click the **ADVANCED** tab.

The ADVANCED Home page displays.

5. In the Internet Port pane, click the **Connection Status** button.

The Connection Status window displays.

6. Check the Connection Status window to see if your PPPoE connection is active and working.

If the router is not connected, click the **Connect** button.

The router continues to attempt to connect indefinitely.

7. If you cannot connect after several minutes, the router might be set up with an incorrect service name, user name, or password, or your ISP might be experiencing a provisioning problem.

Unless you connect manually, the router does not authenticate using PPPoE until data is transmitted to the network.

# Troubleshoot WiFi connectivity

If you are experiencing trouble connecting to the Orbi WiFi network, try to isolate the problem:

- Can your WiFi-enabled computer or mobile device that you are using find your WiFi network?
- Does your WiFi-capable device support the security that you are using for your WiFi network (WPA3, WPA2, or WPA)?
- To view the WiFi settings for the router, use an Ethernet cable to connect a computer to an Ethernet port on the router. Then log in to the router, and select **BASIC > Wireless**.

**ⓘ NOTE:** Be sure to click the **Apply** button if you change settings.

- If you are trying to connect to the 5 GHz or 6 GHz WiFi band, does your WiFi-enabled computer or mobile device support this standard?
- Did your computer or WiFi device automatically connect to a different WiFi network in your area, such as a WiFi hotspot?



# Troubleshoot your network using the ping utility

Most network devices and routers contain a ping utility that sends an echo request packet to the designated device. The device then responds with an echo reply. You can easily troubleshoot a network using the ping utility in your computer or workstation.

## Test the LAN path to your router

You can ping the router from your computer to verify that the LAN path to your router is set up correctly.

### To ping the router from a Windows computer:

1. From the Windows toolbar, click the **Start** button and select **Run**.
2. In the field provided, type **ping** followed by the IP address of the router, as in this example:

**ping www.orbilogin.com**

3. Click the **OK** button.

You should see a message like this one:

```
Pinging <IP address > with 32 bytes of data
```

If the path is working, you see this message:

```
Reply from < IP address >: bytes=32 time=NN ms TTL=xxx
```

If the path is not working, you see this message:

```
Request timed out
```

If the path is not functioning correctly, you might be experiencing one of the following problems:

- Wrong physical connections  
Check that the appropriate LEDs are on for your network devices. If your router and computer are connected to a separate Ethernet switch, make sure that the link LEDs on the switch are lit for the switch ports that your computer and router are connected to.
- Wrong network configuration  
Verify that the Ethernet card driver software and TCP/IP software are both installed and configured on your computer.

Verify that the IP address for your router and your computer are correct and that the addresses are on the same subnet.

# Test the path from your computer to a remote device

After verifying that the LAN path works correctly, test the path from your computer to a remote device.

### To test the path from your computer to a remote device:

1. From the Windows toolbar, click the **Start** button and select **Run**.
2. In the Windows Run window, type:

**ping -n 10** <IP address>

where <IP address> is the IP address of a remote device such as your ISP DNS server.

If the path is functioning correctly, messages display that are similar to those shown in [Test the LAN path to your router](#) on page 145.

If you do not receive replies, check the following:

- Check to see that the IP address of your router is listed as the default gateway for your computer. If DHCP assigns the IP configuration of your computers, this information is not visible in your computer Network Control Panel. Verify that the IP address of the router is listed as the default gateway.
- Check to see that the network address of your computer (the portion of the IP address specified by the subnet mask) is different from the network address of the remote device.
- Check to see that your cable or DSL modem is connected and functioning.
- If your ISP assigned a host name to your computer, enter that host name as the account name on the Internet Setup page.
- Your ISP might be rejecting the Ethernet MAC addresses of all but one of your computers.

Many broadband ISPs restrict access by allowing traffic only from the MAC address of your broadband modem. Some ISPs additionally restrict access to the MAC address of a single computer connected to that modem. If your ISP does this, configure your router to “clone” or “spoof” the MAC address from the authorized computer.