

# Advanced Deployment Guide

Lenovo  
**ThinkSmart**

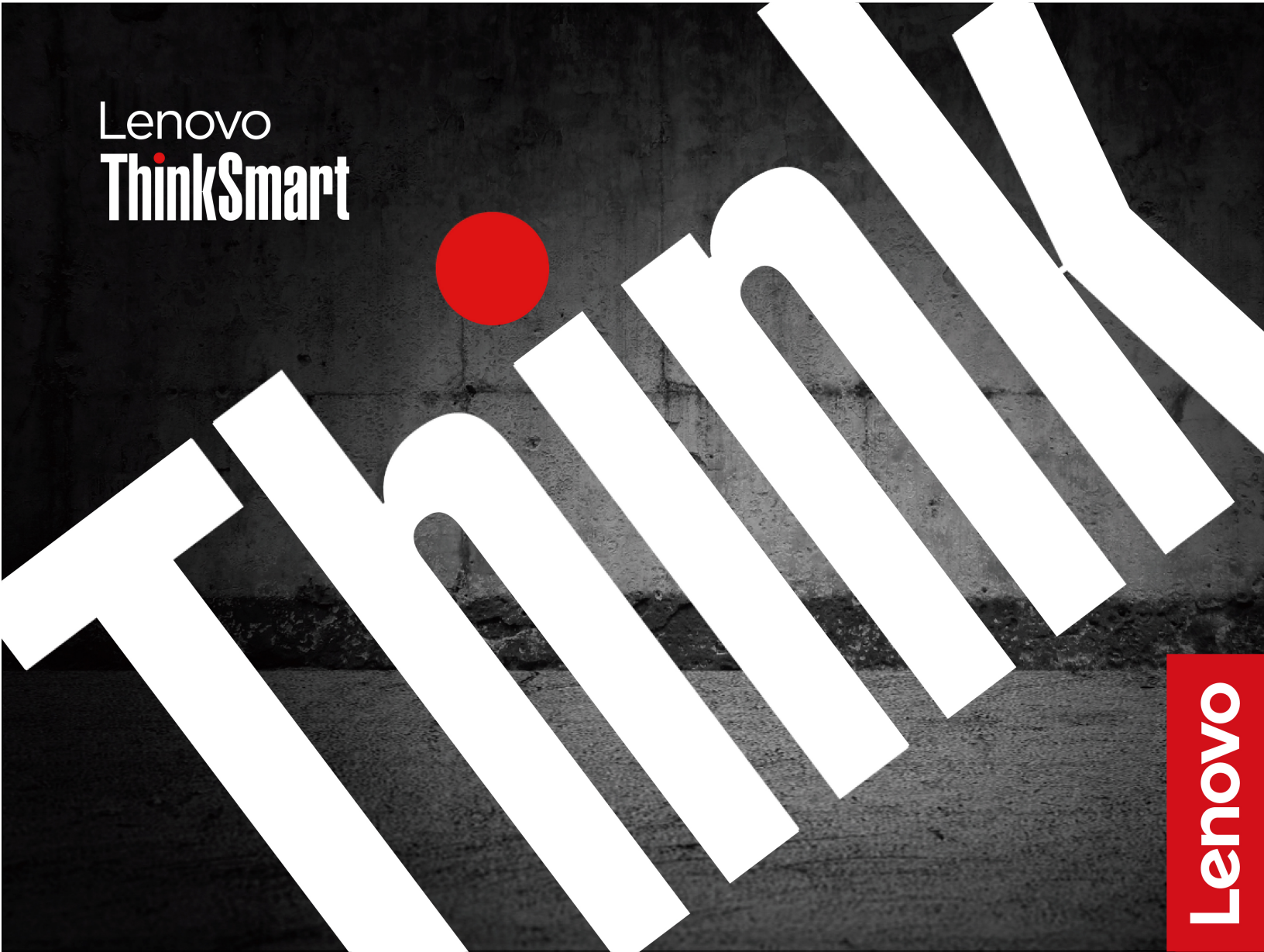

**Lenovo**

ThinkSmart Core Gen 2

## About this documentation

This guide applies to the Lenovo product models listed below.

Model name	Machine types (MT)
ThinkSmart Core Gen 2	12W6, 12W7, 12W8, 12W9, 12WA, 12WB, 12WC, 12WD, 12WE, 12WF, 12WG, 12WH, 12WJ, 12WK, 12WL, 12WM, 12WN, 12WQ, 12WR, 12WS, 12WT, 12WU, 12WV, 12WW, 12WY, 12X0, 12X1, 12X2, 12X3, 12X4, 12X5, 12X6, 12X7

Before using this documentation and the product it supports, ensure that you read and understand the following:

- *Setup Guide, Safety and Warranty Guide, and Regulatory Notice* at <https://smartsupport.lenovo.com>
- *Generic Safety and Compliance Notices* at <https://smartsupport.lenovo.com> or under the directory of your device: C:\Windows\System32\Safety & Compliance Notices

### Notes:

- Illustrations in this guide may look slightly different from your product model.
- Depending on the model, some optional accessories, features, and software programs might not be available on your device.
- Depending on the version of the operating systems and programs, some user interface instructions might not be applicable to your device.
- Documentation content is subject to change without notice. Lenovo makes constant improvements to the documentation of your device, including this *Guide*. To get the latest documentation, go to <https://smartsupport.lenovo.com>.
- Microsoft® makes periodic feature changes to the Windows® operating system through Windows Update. As a result, some information in this documentation might become outdated. Refer to Microsoft resources for the latest information.

**First Edition (December 2024)**

© Copyright Lenovo 2024.

LIMITED AND RESTRICTED RIGHTS NOTICE: If data or software is delivered pursuant to a General Services Administration "GSA" contract, use, reproduction, or disclosure is subject to restrictions set forth in Contract No. GS-35F-05925.

---

# Contents

## Chapter 1. Meet your device . . . . . 1

Front . . . . .	1
Rear . . . . .	1
Left . . . . .	2
Right . . . . .	2
USB specifications . . . . .	4
Specifications . . . . .	5

## Chapter 2. UEFI BIOS . . . . . 7

What is UEFI BIOS. . . . .	7
Enter the UEFI BIOS menu . . . . .	7
Navigate the UEFI BIOS menu . . . . .	7
Update the UEFI BIOS . . . . .	8
From the Lenovo Support Web site . . . . .	8
From the Windows Update . . . . .	8
Enable or disable the ErP LPS compliance mode. . . . .	8
Enable or disable the smart power-on feature . . . . .	9
Use software security solutions. . . . .	9

## Chapter 3. Frequently asked questions. . . . . 11

For Microsoft Teams Rooms. . . . .	11
For operating system. . . . .	12
For hardware . . . . .	13

## Chapter 4. Updates, diagnostics, and recovery . . . . . 15

Updates. . . . .	15
Update the MTR app . . . . .	15

Update the operating system. . . . .	15
Update or install the device driver . . . . .	15
Diagnostics . . . . .	16
UEFI Diagnostics tool. . . . .	16
Recovery . . . . .	16
Recover your operating system . . . . .	16

## Chapter 5. CRU replacement . . . . . 17

CRU list . . . . .	17
Power adapter, power cord, and power adapter cage . . . . .	17
VESA mount brackets and screws . . . . .	19
Cable management top cover and bottom cover . . . . .	20
Top cover assembly . . . . .	22
M.2 solid-state drive and thermal pad . . . . .	22
Memory modules and thermal pads . . . . .	24

## Chapter 6. Help and support . . . . . 27

Register with Lenovo. . . . .	27
Self-help resources . . . . .	27
Additional services . . . . .	27
Call Lenovo . . . . .	27
Before you contact Lenovo . . . . .	27
Lenovo Customer Support Center . . . . .	28
Accessibility features. . . . .	28

## Appendix A. Notices and trademarks. . . . . 31



# Chapter 1. Meet your device

This device is equipped with an extensive selection of ports, providing convenient connectivity options for multiple devices.

## Front

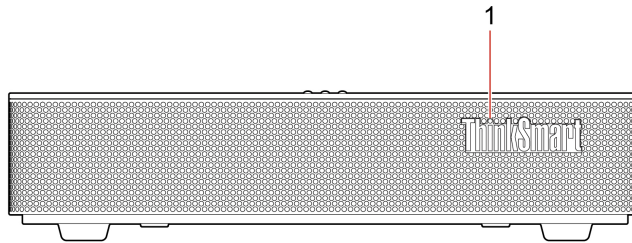

Item	Description
1	ThinkSmart® LED

### ThinkSmart LED

Show the system status of your device.

- **On:** The device is starting up or working.
- **Off:** The device is off.

## Rear

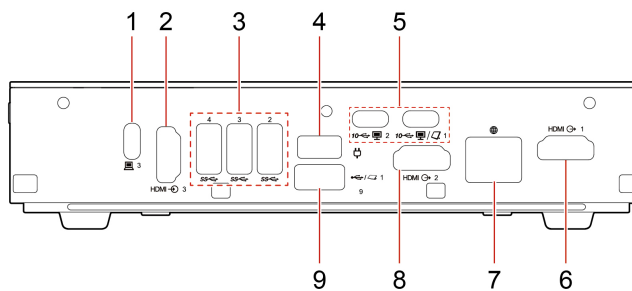

Item	Description	Item	Description
1	Bring Your Own Meeting (BYOM) connector*	2	HDMI™ -in connector*
3	USB-A connectors (USB 5Gbps) (with BYOM)	4	Power connector
5	USB-C® connectors (USB 10Gbps)	6	HDMI-out connector
7	Ethernet connector (1000Mbps)	8	HDMI-out connector
9	USB-A connector (Hi-Speed USB) (with smart power-on)		

\* for selected models

### Statement on USB transfer rate

Depending on many factors such as the processing capability of the host and peripheral devices, file attributes, and other factors related to system configuration and operating environments, the actual transfer rate using the various USB connectors on this device will vary and will be slower than the data rate listed in the connector name for each corresponding device.

### HDMI-in connector

Support up to 3840 x 2160 @ 60 Hz.

### HDMI-out connector

Support up to 3840 x 2160 @ 60 Hz.

### Related topics

- “USB specifications” on page 4.

---

## Left

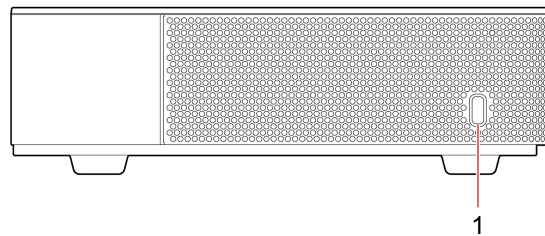

---

Item	Description
1	Security-lock slot

---

### Security-lock slot

Lock your device to a desk, table, or other fixtures through a security lock.

**Note:** Lenovo makes no comments, judgments, or warranties about the function, quality, or performance of the locking device and security feature. You can purchase security locks from Lenovo.

---

## Right

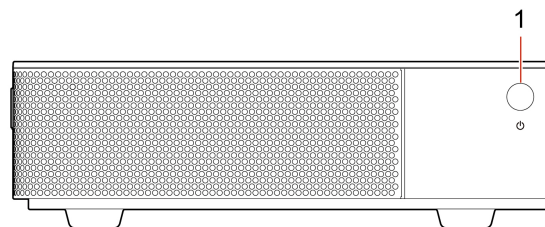

---





Item	Description
1	Power button

---

---

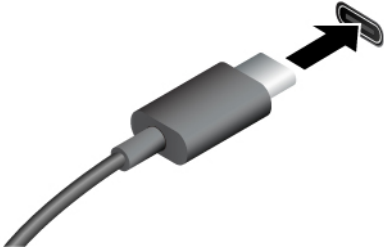
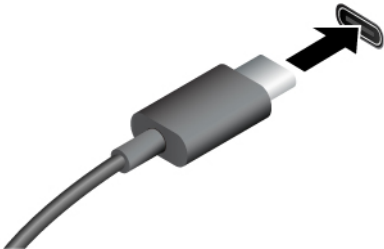
## USB specifications

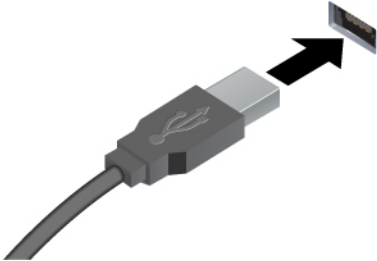
**Note:** Depending on the model, some USB connectors might not be available on your device.

Connector name	Description
 BYOM (USB-C) connector	<ul style="list-style-type: none"><li>• Connect to your computer to use the camera, microphones, and speakers connected to ThinkSmart Core Gen 2 for BYOM experience.</li><li>• Support power output up to 45 W (20 V, 2.25 A).</li></ul>
 10  USB-C connector (USB 10Gbps)	<ul style="list-style-type: none"><li>• Multi-purpose USB-C connector<ul style="list-style-type: none"><li>– Support SuperSpeed USB 10 Gbps</li><li>– Support SuperSpeed USB 5 Gbps</li><li>– Support DisplayPort Alt Mode (DisplayPort 1.4 compliant)</li><li>– Support power output up to 15 W (5 V, 3 A)</li><li>– Support USB Power Delivery</li></ul></li><li>• Connect to ThinkSmart Controller or other USB-C accessories to help expand your device functionality. To purchase USB-C accessories, go to <a href="https://www.lenovo.com/accessories">https://www.lenovo.com/accessories</a>.</li></ul> <p><b>Note:</b> Data rates and performance ratings are dependent on connected devices and cables if they are used. USB Type-C connectors that are DisplayPort 1.4 compliant through DisplayPort alternate mode provide maximum output resolution of 5120 x 3200, at 60 Hz frame rate and color depth of 24 bpp (bits per pixel). For connections using a converter or an adapter, the actual output resolution may be lower.</p>
 •  USB-A connector (Hi-Speed USB) •  USB-A connector (USB 5Gbps)	<p>Connect to USB-A compatible devices, such as a keyboard, mouse, audio device, camera, or Lenovo IP Controller.</p>



---

## Specifications

---

Specification	Description
<b>Dimensions (with cable management box)</b>	<ul style="list-style-type: none"><li>• Width: 185 mm (7.2 inches)</li><li>• Height: 42.8 mm (1.7 inches)</li><li>• Depth: 220 mm (8.7 inches)</li></ul>
<b>Weight (without packaging)</b>	Maximum configuration as shipped: 1.01 kg (2.23 lb)
<b>Hardware configuration</b>	Type Device Manager in the Windows search box and then press Enter. Type the administrator password or provide confirmation, if prompted.
<b>Power supply</b>	<ul style="list-style-type: none"><li>• 135-watt automatic voltage-sensing power supply</li><li>• 170-watt automatic voltage-sensing power supply</li></ul>
<b>Electrical input and output</b>	<ul style="list-style-type: none"><li>• Input voltage: From 100 V ac to 240 V ac</li><li>• Input frequency: 50/60 Hz</li><li>• Output voltage: 20 V dc</li><li>• Output current: 6.75 A or 8.5 A</li></ul>
<b>Memory</b>	<ul style="list-style-type: none"><li>• Up to two double data rate 5 (DDR5) small outline dual in-line memory modules (SODIMMs)</li><li>• Maximum memory capacity: 32 GB</li></ul>
<b>Storage device</b>	<p>M.2 solid-state drive</p> <p>To view the storage drive capacity of your device, type disk management in the Windows search box and then press Enter.</p> <p><b>Note:</b> The storage drive capacity indicated by the system is less than the nominal capacity.</p>
<b>Network features</b>	<ul style="list-style-type: none"><li>• Bluetooth</li><li>• Ethernet LAN</li><li>• Wireless LAN</li></ul>
<b>Operating system</b>	Windows
<b>Preloaded Lenovo app</b>	ThinkSmart Manager*
<b>Preloaded meeting app</b>	Microsoft Teams Rooms (MTR)

\* Only support in some countries or regions.

### Operating environment

#### Maximum altitude (without pressurization)

- Operating: From -15.2 m (-50 ft) to 3048 m (10 000 ft)
- Storage: From -15.2 m (-50 ft) to 10 668 m (35 000 ft)

#### Temperature

- Operating: From 10°C (50°F) to 35°C (95°F)
- Storage in original shipping packaging: From -20°C (-4°F) to 60°C (140°F)

- Storage without packaging: From -10°C (14°F) to 60°C (140°F)

**Relative humidity**

- Operating: 20%-80% (non-condensing)
- Storage: 20%–90% (non-condensing)

---

## Chapter 2. UEFI BIOS

This chapter explains the UEFI BIOS and provides instructions on how to access, navigate, and update it.

**Note:** Connect a keyboard and a mouse to the device for configurations.

---

### What is UEFI BIOS

Unified Extensible Firmware Interface (UEFI) Basic Input/Output System (BIOS) is the first program that the device runs. UEFI BIOS initializes the hardware components and loads the operating system and other programs. Your device comes with a setup program with which you can change UEFI BIOS settings.

---

### Enter the UEFI BIOS menu

Turn on or restart the device. When the logo screen is displayed, press F1 or Fn+F1 to enter the UEFI BIOS menu.

**Note:** If you have set UEFI BIOS passwords, enter the correct passwords when prompted. You also can select **No** or press Esc to skip the password prompt and enter the UEFI BIOS menu. However, you cannot change the system configurations that are protected by passwords.

---

### Navigate the UEFI BIOS menu

Follow the on-screen instructions to navigate in the UEFI BIOS menu.

The table below introduces the available settings of the UEFI BIOS menu. You can follow the on-screen instructions to navigate in the UEFI BIOS menu.

**Note:** The UEFI BIOS menu might vary depending on system configurations.

---

Menu	Introduction
<b>Main</b>	This category provides the general product-related and firmware information including system summary, machine type, product serial number, UUID number, etc.
<b>Devices</b>	This category introduces how to configure various devices such as USB connectors and audio controllers.
<b>Advanced</b>	This category provides advanced information about the device such as the microprocessor features.
<b>Power</b>	This category introduces power.
<b>Security</b>	This category introduces various passwords, locks, and software to protect your device.
<b>Startup</b>	This category introduces how to set the boot priority order.
<b>Exit</b>	This category introduces how to exit as you prefer.

---

You can go to Lenovo BIOS Simulator Center <https://download.lenovo.com/bsco/index.html> to explore the detailed settings by your product name.

**Note:** The Lenovo BIOS Simulator Center makes periodic updates to the settings. The UEFI BIOS simulator interface and description of settings might be different from that on your actual user interface.

---

## Update the UEFI BIOS

When you install a new program, device driver, or hardware component, you might need to update the UEFI BIOS.

Download and install the latest UEFI BIOS update package by one of the following methods:

### From the Lenovo Support Web site

Follow the instructions to update the UEFI BIOS from the Lenovo Support Web site.

1. Go to <https://smartsupport.lenovo.com> and search by your product name.
2. Click **Drivers & Software** → **Manual Update** → **BIOS/UEFI**.
3. Follow the on-screen instructions to download and install the latest UEFI BIOS update package.

### From the Windows Update

Follow the instructions to update the UEFI BIOS from the Windows Update.

1. Type Windows Update in the Windows search box and press Enter.
2. Click **Check for updates**. If the update package is available, it will be automatically downloaded and installed.

---

## Enable or disable the ErP LPS compliance mode

Lenovo devices meet the eco-design requirements of the ErP Lot 6/26 regulation. Follow the instructions to enable or disable the ErP LPS compliance mode.

For more information about the eco-design requirements, go to <https://www.lenovo.com/us/en/compliance/eco-declaration>.

You can enable the ErP LPS compliance mode to reduce the consumption of electricity when the device is off. To enable or disable the ErP LPS compliance mode:

1. Restart the device. When the logo screen is displayed, press F1 or Fn+F1.
2. Select **Power** → **Enhanced Power Saving Mode** and press Enter.
3. Enable or disable the feature as desired.

**Note:** Please note that when the Enhanced Power Saving Mode is disabled, the power consumption might be increased when the device is off.

4. Press F10 or Fn+F10 to save the changes and exit.

When the ErP LPS compliance mode is enabled, you can wake up the device by doing one of the following:

- Press the power button.
- Enable the Wake Up on Alarm feature to make the device wake up at a set time.

To meet the requirement of ErP compliance, you need to disable the Fast Startup function.

1. Go to **Control Panel** and view by large icons or small icons.
2. Click **Power Options** → **Choose what the power buttons do** → **Change settings that are currently unavailable**.
3. Clear the **Turn on fast startup (recommended)** option from the **Shutdown settings** list.

---

## Enable or disable the smart power-on feature

The smart power-on feature helps you start up or wake up the device from the hibernation mode simply by pressing Alt+P.

**Note:** Ensure that the keyboard is connected to the USB-A connector (Hi-Speed USB) (with smart power-on) located below the power connector.

### Enable or disable the smart power-on feature

To enable or disable the smart power-on feature:

1. Restart the device. When the logo screen is displayed, press F1 or Fn+F1.
2. Select **Power** → **Smart Power On** → **USB** and press Enter.
3. Enable or disable the feature as desired.
4. Press F10 or Fn+F10 to save the changes and exit.

---

## Use software security solutions

The following software solutions help secure your device and information.

- **Windows Security**

Windows Security is a software built into the operating system. It continually scans for malicious software, viruses, and other security threats. Besides, Windows updates are downloaded automatically to help keep your device safe. Windows Security also enables you to manage tools including firewall, account protection, application and browser control, and so on.

- **Absolute Persistence**

Absolute Persistence technology is embedded in firmware. It detects changes that happen on the hardware, software, or the call-in location. It keeps you always knowing what condition the device is in. To activate the technology, you have to purchase a subscription to Absolute.

**Note:** For more information about how to use these software solutions, refer to their help systems respectively.



---

## Chapter 3. Frequently asked questions

This chapter lists out some most frequently asked questions for your reference.

---

### For Microsoft Teams Rooms

#### How to apply for an MTR account and its password?

Refer to <https://learn.microsoft.com/microsoftteams/rooms/with-office-365>.

#### What should I do if the MTR main interface shows “Sign in failed. Sign in to Microsoft Teams was unsuccessful. Reach out to the device administrator or restart the device.”?

- Ensure that you have entered the correct user name and password.
- Ensure that the device is connected to an Ethernet connector.
- Ensure that the network is working properly and not restricted or blocked by firewall.
- Restart the device and sign in to MTR again.
- Ensure that the MTR account has not been signed in with another device. Switch to the administrator account and connect to a Wi-Fi® network.

#### How to switch between an MTR account and an administrator account?

- From MTR account to administrator account:
  1. Go to **More** → **Settings**. Enter the administrator password as prompted.
  2. Go to **Windows Settings** → **Administrator**. Enter the administrator password as prompted.
- From administrator account to MTR account:

Restart the device to go back to the MTR app.

#### How to change the administrator password?

- **From the MTR app**
  1. On the MTR touchscreen console, go to **More** → **Settings** → **Windows Settings** → **Administrator**. When prompted, enter the administrator password.
  2. Go to **Start** → **Settings** → **Accounts** → **Sign-in options**. Under **Password**, tap **Change**. Then, follow the on-screen instructions to change the administrator password.
- **From the Windows desktop**

Press **Ctrl + Alt + Delete** on your keyboard. Then, follow the on-screen instructions to change the administrator password.
- **From the ThinkSmart Manager portal**
  1. Log in to [ThinkSmart Manager portal](#).
  2. Go to **Device Manager** → **Devices**.
  3. Select the device you want to manage.
  4. Go to **Configuration** → **Windows**. Then, follow the on-screen instructions to change the administrator password.

## How to update the MTR app?

The MTR app is distributed through the Microsoft Store and updates automatically through Windows. If you can't get updates from the Microsoft Store, you can manually update your devices to a newer version of MTR app. To manually update the app, go to <https://learn.microsoft.com/MicrosoftTeams/rooms/manual-update>.

---

## For operating system

### What should I do if Controller does not show the Out of Box Experience (OOBE) window when the device is turned on for the first time?

The OOBE window is designed to display on the connected external display rather than Controller. Complete the settings on the external display with your keyboard and mouse.

### When will the Controller screen go into standby mode?

When Controller is not in a meeting and no one is in the room, Controller will go into standby mode automatically after 10 minutes by default.

**Attention:** Do not change the default screen-off setting to protect the Controller screen.

### What should I do if the Controller screen is blurry?

1. Check the screen-off setting: Go to **Start** → **Settings** → **System** → **Power**, and ensure that the setting is the default **10 minutes**.
2. If the problem persists, call Lenovo Customer Support Center for help. See “Lenovo Customer Support Center” on page 28.

### What can I do if I can't enter the BYOM mode?

Ensure that the device supports BYOM and that BYOM is enabled. For detailed information, refer to [https://support.lenovo.com/docs/thinksmart\\_core\\_g2\\_dg](https://support.lenovo.com/docs/thinksmart_core_g2_dg).

### Can I install other meeting apps on the device?

No. The device is designed for Microsoft Teams Rooms only. It's not recommended to install any other meeting apps or any type of app on the device.

### Can I update the operating system to the latest version?

Yes. For detailed instructions, see “Update the operating system” on page 15.

### Can I downgrade the operating system to a previous version?

No. For optimal performance and security of the device, it's recommended to get the latest operating system.

### How to configure the network proxy for the device?

Refer to <https://docs.microsoft.com/microsoft-teams/proxy-servers-for-skype-for-business-online>.

### How to reset the device to factory mode?

Refer to <https://learn.microsoft.com/microsoftteams/rooms/recovery-tool>.



---

## For hardware

### What type of Ethernet connection is supported by ThinkSmart Core Gen 2?

ThinkSmart Core Gen 2 supports both wired Ethernet and Wi-Fi connections. For optimal performance, use the wired Ethernet connection for deployment and meeting calls.

### What can I do if there is no video signal output to the external display?

1. Disconnect the external display and reconnect it to ThinkSmart Core Gen 2.

**Note:** It is recommended to connect the external display to the HDMI-out connector and to avoid connecting more than two external displays.

2. If the problem persists, you can try the Extended Display Identification Data (EDID) emulator after connecting your external display to the HDMI-out connector on ThinkSmart Core Gen 2.

The EDID emulator can help optimize the video signal output by using the built-in EDID information on ThinkSmart Core Gen 2.

To enable or disable the EDID emulator:

- a. Restart the device. When the logo screen is displayed, press F1 or Fn+F1.
- b. Select **Devices → EDID emulator** and press Enter.
- c. Enable or disable the feature as desired.
- d. Press F10 or Fn+F10 to save the changes and exit.

### Can I use ThinkSmart Core Gen 2 as a personal computer?

No. ThinkSmart Core Gen 2 is designed to be a smart video conferencing device.

### Can I store my presentations or other materials in ThinkSmart Core Gen 2 for sharing?

No. All content sharing happens in real-time through client devices that are connected to ThinkSmart Core Gen 2. It does not support storing any user data for sharing during meetings.

### What are the TCP/IP ports that must be opened in the infrastructure?

These are the basic default ports MTR will need.

There may be other requirements based on your environment. For more information, see:

- Firewall Proxy Host Name/Port Examples section at <https://learn.microsoft.com/MicrosoftTeams/rooms/rooms-prep>
- Office 365 URLs and IP address ranges at <https://learn.microsoft.com/microsoft-365/enterprise/urls-and-ip-address-ranges>

### Does ThinkSmart Core Gen 2 support PXE boot?

Yes.

### Does ThinkSmart Core Gen 2 support network boot?

Yes. ThinkSmart Core Gen 2 supports network boot through the Ethernet connector.

To perform a network boot:

1. Restart ThinkSmart Core Gen 2.
2. During the boot, press F12 multiple times to load the Startup Device Menu.
3. Based on your infrastructure, select the IPv4 or IPv6 option to initiate the network boot.

**Does ThinkSmart Core Gen 2 support USB boot?**

Yes. ThinkSmart Core Gen 2 supports USB boot.

To perform a USB boot:

1. Insert a USB key into one of the USB connectors, and then restart ThinkSmart Core Gen 2.
2. During the boot, press F12 multiple times to load the Startup Device Menu.
3. Based on your infrastructure, select the USB key to initiate the USB boot.

**Does ThinkSmart Core Gen 2 support Consumer Electronics Control (CEC)?**

Yes. If your external display is CEC-enabled and connected to the HDMI-out connector on ThinkSmart Core Gen 2, you can wake up, turn on, or turn off the external display from ThinkSmart Core Gen 2 through CEC.

---

## Chapter 4. Updates, diagnostics, and recovery

This chapter covers essential procedures for updating your device, performing diagnostics, and utilizing recovery tools.

---

### Updates

#### Update the MTR app

- Automatic update:  
The MTR app updates automatically via the Microsoft Store. Ensure your device is connected to the Internet and has access to the Microsoft Store for the automatic update.
- Manual update:  
If the automatic update is not available, you can manually update the MTR app using an offline update script. For detailed instructions, refer to <https://learn.microsoft.com/MicrosoftTeams/rooms/manual-update>.

#### Update the operating system

Microsoft releases updates for the Windows operating system to enhance security, performance, and functionality. Follow these steps to update the operating system:

1. Update the MTR app. Ensure that the MTR app is updated to the latest version.
2. Update the Windows operating system. Type **Windows Update** in the Windows search box, press Enter, and then click **Check for updates**. If the system update package is available, it will be automatically downloaded and installed.

#### Update or install the device driver

You should download the latest driver for a component when you notice poor performance from that component or when you install a new component. Updating or installing the latest driver might eliminate problems caused by the driver.

##### Attention:

- It is recommended to download Lenovo qualified drivers from Lenovo Support Web site. Before downloading, check if it is compatible with your device. Make sure that the driver you download matches your device and system version to avoid compatibility issues.
- Before updating or installing a driver, it is recommended to make a backup copy of all the essential data to avoid data loss.
- Keep your device connected to the network during the process of updating or installing a driver.
- When the process of update or installation is complete, restart your device. The new driver will take effect then.
- Reinstalling device drivers will change the current configuration of the device.

Update and install the latest driver by one of the following methods:

- From the Lenovo Support Web site:
  1. Go to <https://smartsupport.lenovo.com> and search by your product name.
  2. Click **Drivers & Software** → **Manual Update**.
  3. Follow the on-screen instructions to download and install the latest driver update package.

- From the Windows Update:

**Note:** The device drivers provided by Windows Update might not be tested by Lenovo. It is recommended that you get device drivers from Lenovo.

1. Type Windows Update in the Windows search box and press Enter.
2. Click **Check for updates**. If the driver update package is available, it will be automatically downloaded and installed.

---

## Diagnostics

### UEFI Diagnostics tool

UEFI Diagnostics tool enables you to view system information and identify hardware issues when you cannot log in to the operating system, or the device cannot connect to the network.

To use the UEFI Diagnostics tool:

1. Connect your device to ac power.
2. Turn on your device, and press F10 repeatedly to enter the UEFI Diagnostics tool.
3. Follow the on-screen instructions to run the test.
4. Press Esc to exit the tool. Your device will restart immediately.

**Note:** If any hardware failure is detected and you are unable to locate and resolve the problem, you can call Lenovo Customer Support Center. See “Lenovo Customer Support Center” on page 28.

---

## Recovery

### Recover your operating system

When you encounter some unexpected issues with your operating system, you can choose to recover your operating system by the following methods.

To recover your operating system with...	How to
Lenovo USB Recovery Creator tool	Refer to the instructions at <a href="https://support.lenovo.com/HowToCreateLenovoRecovery">https://support.lenovo.com/HowToCreateLenovoRecovery</a> .
Microsoft Teams Rooms recovery tool	Refer to the instructions at <a href="https://learn.microsoft.com/microsoftteams/rooms/recovery-tool">https://learn.microsoft.com/microsoftteams/rooms/recovery-tool</a> .

---

## Chapter 5. CRU replacement

This chapter outlines the Customer Replaceable Units (CRUs) and provides detailed instructions for replacing them.

CRUs are parts that can be upgraded or replaced by the customer. Lenovo devices contain the following types of CRUs:

- **Self-service CRUs:** Refer to parts that can be installed or replaced easily by customers themselves or by trained service technicians at an additional cost.
- **Optional-service CRUs:** Refer to parts that can be installed or replaced by customers with a greater skill level. Trained service technicians can also provide service to install or replace the parts under the type of warranty designated for the customer's machine.

If you intend to install the CRU, Lenovo will ship the CRU to you. CRU information and replacement instructions are shipped with your product and are available from Lenovo at any time upon request. You might be required to return the defective part that is replaced by the CRU. When return is required: (1) return instructions, a prepaid shipping label, and a container will be included with the replacement CRU; and (2) you might be charged for the replacement CRU if Lenovo does not receive the defective CRU within thirty (30) days of your receipt of the replacement CRU. For full details, see the Lenovo Limited Warranty (LLW) documentation at:

[https://www.lenovo.com/warranty/llw\\_02](https://www.lenovo.com/warranty/llw_02)

---

### CRU list

The following is the CRU list of your device.

#### Self-service CRUs

- Cable management bottom cover\*
- Cable management top cover\*
- Memory module
- Memory module thermal pads
- M.2 solid-state drive
- M.2 solid-state drive thermal pad
- Power adapter
- Power adapter cage\*
- Power cord
- Top cover assembly
- VESA® mount brackets and screws\*

\* for selected models

---

### Power adapter, power cord, and power adapter cage

#### Prerequisite

Before you start, read *Generic Safety and Compliance Notices*, and print the following instructions.

For access, do the following:

1. Turn off the device and remove all connected devices and cables.
2. Disconnect the device from ac power and all connected cables.

### Removal steps

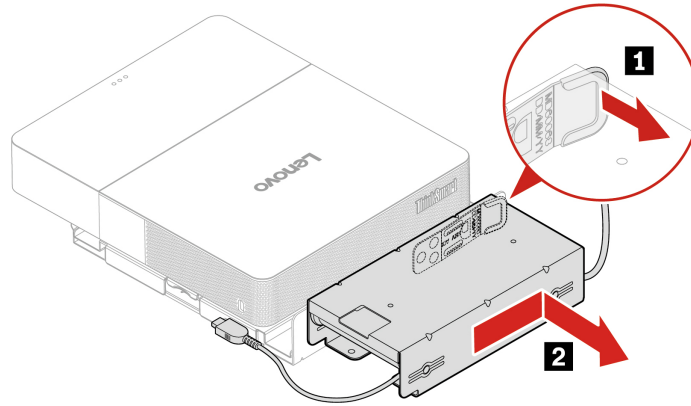

**Note:** Hold the latch in step **1** when removing the power adapter cage.

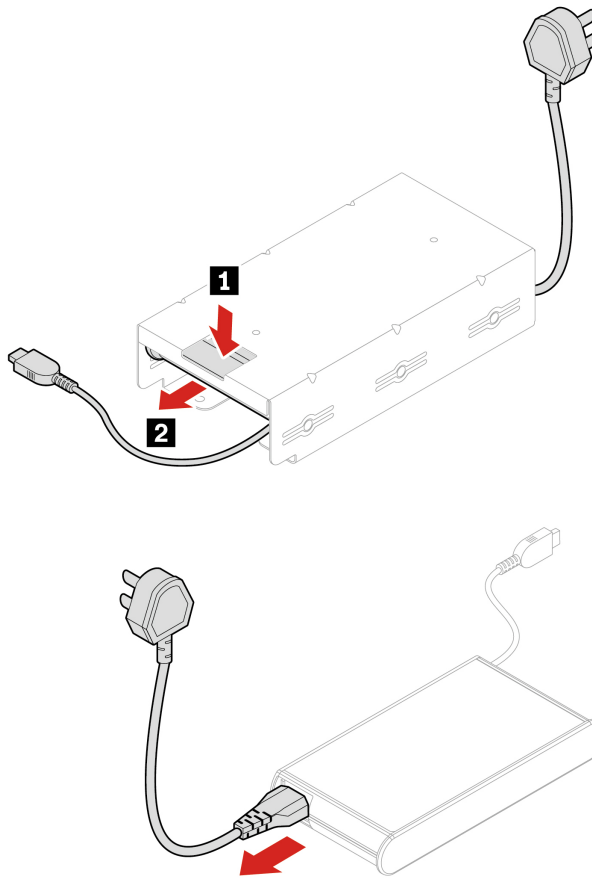

---

## VESA mount brackets and screws

### Prerequisite

Before you start, read *Generic Safety and Compliance Notices*, and print the following instructions.

For access, do the following:

1. Turn off the device and remove all connected devices and cables.
2. Disconnect the device from ac power and all connected cables.
3. Unlock any locking device that secures the device.
4. Remove the power adapter cage, if any. See “Power adapter, power cord, and power adapter cage” on page 17

### Removal steps

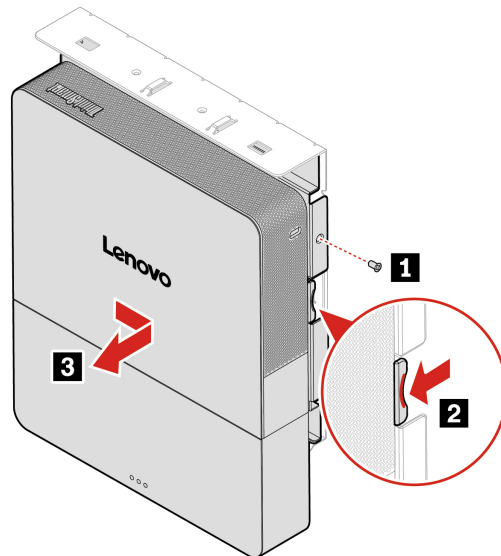

**Note:** Hold the latch in step **2** when removing the top bracket.

Screw (quantity)	Color	Torque
M3 x 3.3 mm, Zn coated (1)	Black	5.0 ± 0.5 lb/in

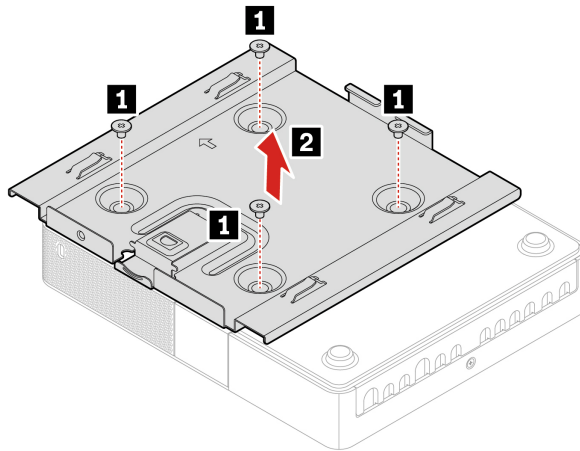

Screw (quantity)	Color	Torque
M4 x 5.8 mm, Ni coated (4)	Black	5.0 ± 0.5 lb/in

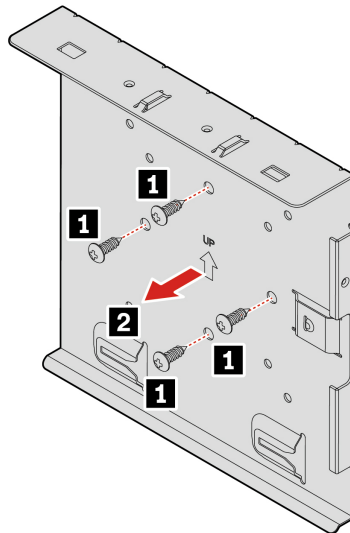

Screw (quantity)	Color	Torque
M5 x 16 mm, Zn coated (4)	Black	5.0 ± 0.5 lb/in

## Cable management top cover and bottom cover

### Prerequisite

Before you start, read *Generic Safety and Compliance Notices*, and print the following instructions.

For access, do the following:



1. Turn off the device and remove all connected devices and cables.
2. Disconnect the device from ac power and all connected cables.
3. Unlock any locking device that secures the device.
4. Remove the following parts in order, if any:
  - “Power adapter, power cord, and power adapter cage” on page 17
  - “VESA mount brackets and screws” on page 19

**Removal steps**

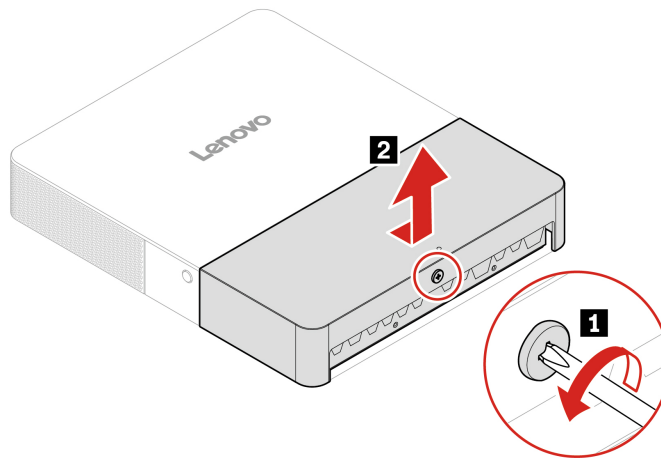

Screw (quantity)	Color	Torque
M2 x 2 + 8 mm, Zn coated (1)	Black	1.2 ± 0.2 lb/in

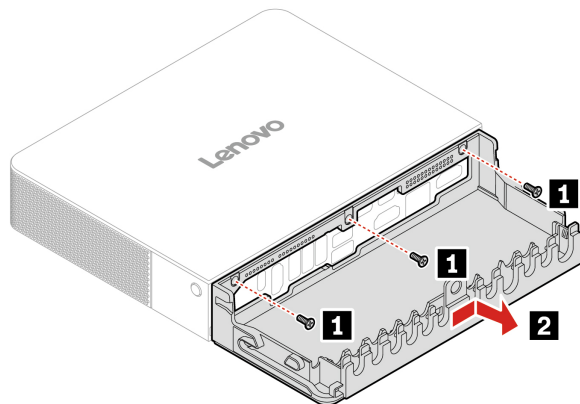

Screw (quantity)	Color	Torque
M2 x 6.5 mm, Zn coated (3)	Black	1.2 ± 0.2 lb/in

---

## Top cover assembly

### Prerequisite

Before you start, read *Generic Safety and Compliance Notices*, and print the following instructions.



Before you open the device cover, turn off the device and wait several minutes until the device is cool.

For access, do the following:

1. Turn off the device and remove all connected devices and cables.
2. Disconnect the device from ac power and all connected cables.
3. Unlock any locking device that secures the device.
4. Remove the following parts in order, if any:
  - “Power adapter, power cord, and power adapter cage” on page 17
  - “VESA mount brackets and screws” on page 19
  - “Cable management top cover and bottom cover” on page 20

### Removal step

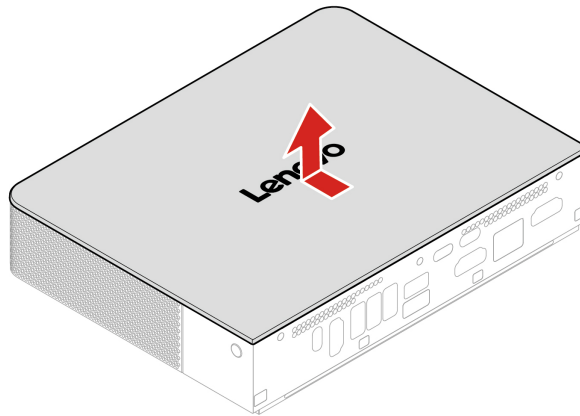

**Note:** Ensure that the internal parts are installed correctly and the internal cables are routed correctly before installing the top cover assembly.

---

## M.2 solid-state drive and thermal pad

### Prerequisite

Before you start, read *Generic Safety and Compliance Notices*, and print the following instructions.



The heat sink might be very hot. Before you open the device cover, turn off the device and wait several minutes until the device is cool.

**Attention:** The internal storage drive is sensitive. Inappropriate handling might cause damage and permanent loss of data. When handling the internal storage drive, observe the following guidelines:

- Replace the internal storage drive only for repair. The internal storage drive is not designed for frequent changes or replacement.
- Before replacing the internal storage drive, make a backup copy of all the data that you want to keep.
- Do not touch the contact edge of the internal storage drive. Otherwise, the internal storage drive might get damaged.
- Do not apply pressure to the internal storage drive.
- Do not make the internal storage drive subject to physical shocks or vibration. Put the internal storage drive on a soft material, such as cloth, to absorb physical shocks.

For access, do the following:

1. Turn off the device and remove all connected devices and cables.
2. Disconnect the device from ac power and all connected cables.
3. Unlock any locking device that secures the device.
4. Remove the following parts in order, if any:
  - “Power adapter, power cord, and power adapter cage” on page 17
  - “VESA mount brackets and screws” on page 19
  - “Cable management top cover and bottom cover” on page 20
  - “Top cover assembly” on page 22

## Removal steps

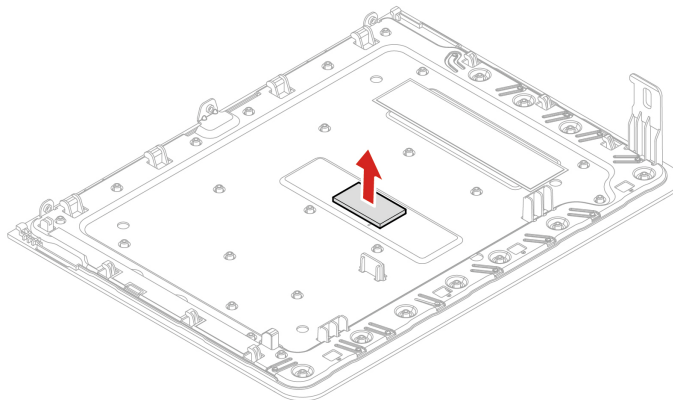

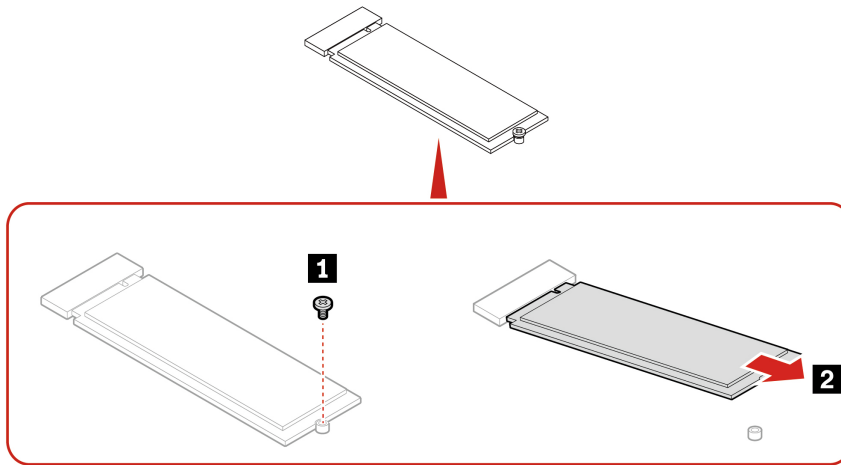

Screw (quantity)	Color	Torque
M2 x 6.5 mm, Zn coated (1)	Black	1.5 ± 0.2 lb/in

## Memory modules and thermal pads

### Prerequisite

Before you start, read *Generic Safety and Compliance Notices*, and print the following instructions.



The heat sink might be very hot. Before you open the device cover, turn off the device and wait several minutes until the device is cool.

Ensure that you follow the installation order for memory modules shown in the following illustration.

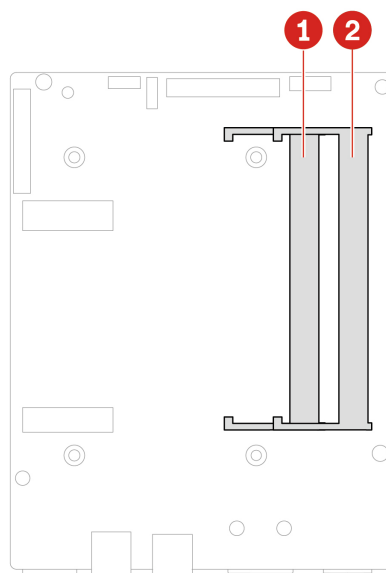

For access, do the following:

1. Turn off the device and remove all connected devices and cables.
2. Disconnect the device from ac power and all connected cables.
3. Unlock any locking device that secures the device.
4. Remove the following parts in order, if any:
  - “Power adapter, power cord, and power adapter cage” on page 17
  - “VESA mount brackets and screws” on page 19
  - “Cable management top cover and bottom cover” on page 20
  - “Top cover assembly” on page 22

### Replacement procedures

Replace the thermal pad(s) according to the location of the memory module(s).

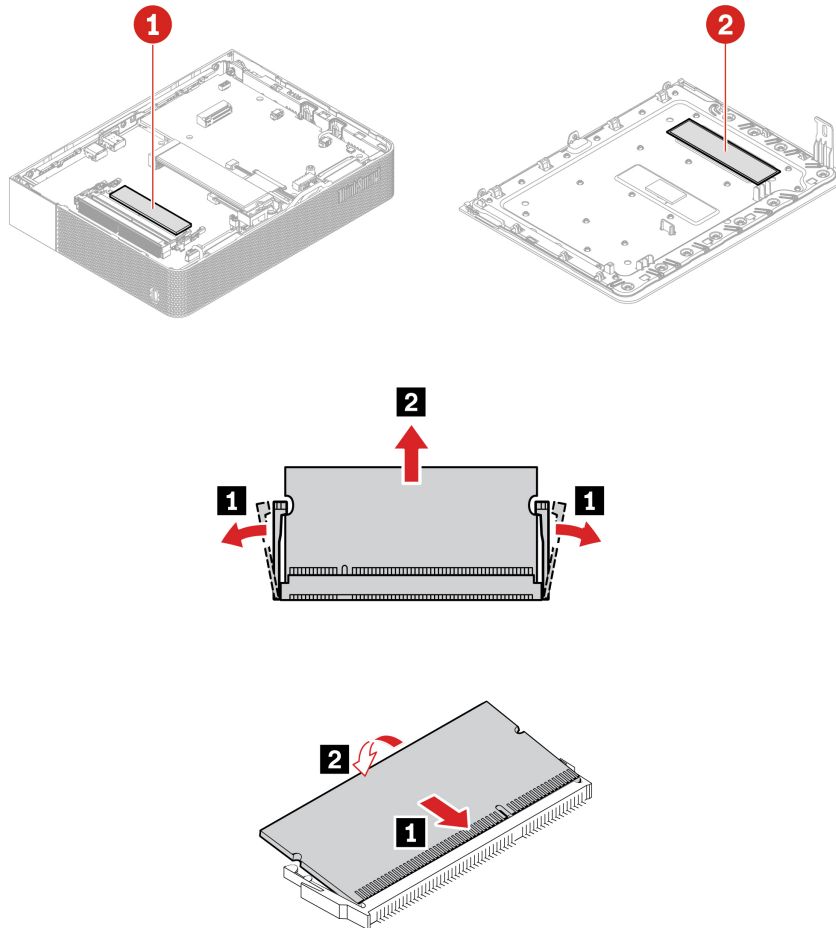

**Note:** When installing, remove the film that covers the thermal pad (if any).



---

## Chapter 6. Help and support

This chapter provides help and support information for your product.

---

### Register with Lenovo

To register with Lenovo, ensure that the device is connected to the Internet. Then, go to <https://www.lenovo.com/register> and follow the instructions on the screen to enter the required information into Lenovo database.

The information enables Lenovo to contact you when there is a recall or other severe problem and provide quicker service when you call Lenovo for help. In addition, some locations offer extended privileges and services to registered users.

---

### Self-help resources

Use the following self-help resources to learn more about the product and troubleshoot problems.

Resources	How to access?
Lenovo Support Web site	<a href="https://smartsupport.lenovo.com">https://smartsupport.lenovo.com</a>
Product specifications	<a href="https://psref.lenovo.com">https://psref.lenovo.com</a>
Serial number information	<a href="https://smartsupport.lenovo.com/solutions/ht512857">https://smartsupport.lenovo.com/solutions/ht512857</a>
Windows help information	<ul style="list-style-type: none"><li>• Open the <b>Start</b> menu and click <b>Get Help</b> or <b>Tips</b>.</li><li>• Use Windows Search.</li><li>• Microsoft support Web site: <a href="https://support.microsoft.com">https://support.microsoft.com</a></li></ul>
ThinkSmart Manager Services	<a href="https://support.lenovo.com/solutions/tsm">https://support.lenovo.com/solutions/tsm</a>
Microsoft Teams Rooms	<a href="https://learn.microsoft.com/MicrosoftTeams/rooms/">https://learn.microsoft.com/MicrosoftTeams/rooms/</a>
Lenovo Community	<a href="https://forums.lenovo.com">https://forums.lenovo.com</a>

---

### Additional services

Thank you, Lenovo customer, for your purchase of a ThinkSmart device.

During and after the warranty period, you can purchase additional services from Lenovo at: <https://pcsupport.lenovo.com/warrantyupgrade>. Service availability and service name might vary by country or region.

---

### Call Lenovo

If you have tried to correct the problem yourself and still need help, you can call Lenovo Customer Support Center.

### Before you contact Lenovo

Prepare the following before you contact Lenovo:

1. Record the problem symptoms and details:
  - What is the problem? Is it continuous or intermittent?
  - Any error message or error code?
  - What operating system are you using? Which version?
  - Which software applications were running at the time of the problem?
  - Can the problem be reproduced? If so, how?
2. Record the system information:
  - Product name
  - Machine type and serial number

## Lenovo Customer Support Center

During the warranty period, you can call Lenovo Customer Support Center for help.

### Telephone numbers

For a list of the Lenovo Support phone numbers for your country or region, go to:

<https://smartsupport.lenovo.com/supportphonest>

**Note:** Phone numbers are subject to change without notice. If the number for your country or region is not provided, contact your Lenovo reseller or Lenovo marketing representative.

### Services available during the warranty period

- Problem determination - Trained personnel are available to assist you with determining if you have a hardware problem and deciding what action is necessary to fix the problem.
- Lenovo hardware repair - If the problem is determined to be caused by Lenovo hardware under warranty, trained service personnel are available to provide the applicable level of service.
- Engineering change management - Occasionally, there might be changes that are required after a product has been sold. Lenovo or your reseller, if authorized by Lenovo, will make selected Engineering Changes (ECs) that apply to your hardware available.

### Services not covered

- Replacement or use of parts not manufactured for or by Lenovo or nonwarranted parts
- Identification of software problem sources
- Configuration of UEFI BIOS as part of an installation or upgrade
- Changes, modifications, or upgrades to device drivers
- Installation and maintenance of network operating systems (NOS)
- Installation and maintenance of programs

For the terms and conditions of the LLW that apply to your Lenovo hardware product, see the LLW documentation at:

[https://www.lenovo.com/warranty/llw\\_02](https://www.lenovo.com/warranty/llw_02)

The LLW is also preinstalled on your device. To access the LLW, go to the following directory:

C:\Windows\System32\oobe\info\default

---

## Accessibility features

Lenovo is committed to making information technology accessible to everyone, including those with hearing, vision, or mobility limitations. Lenovo supports accessibility features in the following ways to help all users better engage with Lenovo products.



## Accessible documentation

Lenovo documentation is designed to meet users' accessibility needs. Users can read the documentation with assistance as needed. For example:

- Text and images are in high contrast. Color contrast can enhance the visual experience. In this mode, all contents are highlighted to be more visible.
- Text is logical and readable. Images are also readable with alternative text provided. A screen reader can enhance the hearing or listening experience. In this mode, all contents are clearer and easier to understand.
- Text is large and clear, making it easier to read. A magnifier can enlarge the text to improve readability.

For more information, watch the video at:

[https://support.lenovo.com/docs/pc\\_pub\\_accessibility](https://support.lenovo.com/docs/pc_pub_accessibility)

## Accessible product design

Lenovo product design also supports accessibility features.

**Note:** The accessibility features vary by product. Depending on the product model, some accessibility features listed below might not be applicable to the product. To get the most up-to-date accessibility information for the product, go to <https://www.lenovo.com/accessibility>. For additional support from Lenovo, users can find phone numbers for their country or region from <https://support.lenovo.com/supportphonenumber>.

- **Keyboards**

If your device has a keyboard, read the following information.

Lenovo keyboards support various accessibility features. For example:

- Consistent layout of keyboards for easier use
- Tactile markings on some keys for easier identification
- Appropriate spacing between keys for typing efficiency
- Sufficient contrast of keys, controls, and labels for better visibility
- On-screen notification or lighted notification for some keys for ease of use
- Keys and controls that can be reached and operated using one hand and require minimal dexterity for ease of use

- **Industry-standard connectors**

The industry-standard connectors on Lenovo products enable better compatibility with peripheral devices.

- **Operating systems**

The accessibility features of the operating systems can be configured to assist users in the following ways:

- Vision features, such as text size and visual effect settings, make the screen contents easier to see.
- Hearing features, such as audio and caption settings, make the screen contents easier to hear.
- Interaction features, such as speech and eye-control settings, make the product easier to control.

To access the accessibility features of the Windows operating system, go to **Start → Settings → Accessibility**.



---

## Appendix A. Notices and trademarks

### Notices

Lenovo may not offer the products, services, or features discussed in this document in all countries. Consult your local Lenovo representative for information on the products and services currently available in your area. Any reference to a Lenovo product, program, or service is not intended to state or imply that only that Lenovo product, program, or service may be used. Any functionally equivalent product, program, or service that does not infringe any Lenovo intellectual property right may be used instead. However, it is the user's responsibility to evaluate and verify the operation of any other product, program, or service.

Lenovo may have patents or pending patent programs covering subject matter described in this document. The furnishing of this document does not give you any license to these patents. You can send license inquiries, in writing, to:

*Lenovo (United States), Inc.  
8001 Development Drive  
Morrisville, NC 27560  
U.S.A.  
Attention: Lenovo Director of Licensing*

LENOVO PROVIDES THIS PUBLICATION "AS IS" WITHOUT WARRANTY OF ANY KIND, EITHER EXPRESS OR IMPLIED, INCLUDING, BUT NOT LIMITED TO, THE IMPLIED WARRANTIES OF NON-INFRINGEMENT, MERCHANTABILITY OR FITNESS FOR A PARTICULAR PURPOSE. Some jurisdictions do not allow disclaimer of express or implied warranties in certain transactions, therefore, this statement may not apply to you.

Changes are made periodically to the information herein; these changes will be incorporated in new editions of the publication. To provide better service, Lenovo reserves the right to improve and/or modify the products and software programs described in the manuals included with your device, and the content of the manual, at any time without additional notice.

The software interface and function and hardware configuration described in the manuals included with your device might not match exactly the actual configuration of the device that you purchase. For the configuration of the product, refer to the related contract (if any) or product packing list, or consult the distributor for the product sales. Lenovo may use or distribute any of the information you supply in any way it believes appropriate without incurring any obligation to you.

The products described in this document are not intended for use in implantation or other life support applications where malfunction may result in injury or death to persons. The information contained in this document does not affect or change Lenovo product specifications or warranties. Nothing in this document shall operate as an express or implied license or indemnity under the intellectual property rights of Lenovo or third parties. All information contained in this document was obtained in specific environments and is presented as an illustration. The result obtained in other operating environments may vary.

Lenovo may use or distribute any of the information you supply in any way it believes appropriate without incurring any obligation to you.

Any references in this publication to non-Lenovo Web sites are provided for convenience only and do not in any manner serve as an endorsement of those Web sites. The materials at those Web sites are not part of the materials for this Lenovo product, and use of those Web sites is at your own risk.

Any performance data contained herein was determined in a controlled environment. Therefore, the result obtained in other operating environments may vary significantly. Some measurements may have been made on development-level systems and there is no guarantee that these measurements will be the same on generally available systems. Furthermore, some measurements may have been estimated through extrapolation. Actual results may vary. Users of this document should verify the applicable data for their specific environment.

This document is copyrighted by Lenovo and is not covered by any open source license. Lenovo may update this document at any time without notice.

For the latest information or any questions or comments, contact or visit the Lenovo Web site:

<https://smartsupport.lenovo.com>

### **Trademarks**

Lenovo, Lenovo logo, ThinkSmart, and ThinkSmart logo are trademarks of Lenovo. Microsoft and Windows are trademarks of the Microsoft group of companies. The terms HDMI and HDMI High-Definition Multimedia Interface are trademarks or registered trademarks of HDMI Licensing LLC in the United States and other countries. Wi-Fi is a registered trademark of Wi-Fi Alliance. USB-C is a registered trademark of USB Implementers Forum. All other trademarks are the property of their respective owners.



**Lenovo**