



DMS Local

# User Manual

## Copyright

Copyright 2025 BenQ Corporation. All rights reserved. No part of this publication may be reproduced, transmitted, transcribed, stored in a retrieval system or translated into any language or computer language, in any form or by any means, electronic, mechanical, magnetic, optical, chemical, manual or otherwise, without the prior written permission of BenQ Corporation.

All other logos, products, or company names mentioned in this manual may be the registered trademarks or copyrights of their respective companies, and are used for informational purposes only.

## Disclaimer

BenQ Corporation makes no representations or warranties, either expressed or implied, with respect to the contents hereof and specifically disclaims any warranties, merchantability or fitness for any particular purpose. Further, BenQ Corporation reserves the right to revise this publication and to make changes from time to time in the contents hereof without obligation of BenQ Corporation to notify any person of such revision or changes.

This user manual aims to provide the most updated and accurate information to customers, and thus all contents may be modified from time to time without prior notice. Please visit <http://www.benq.com> for the latest version of this manual.

The illustrations and the screens shown in this guide are for your reference. The actual content and available functions may vary by the connected devices and the product supplied for your region.

# Table of Contents

<b>Copyright</b> .....	<b>2</b>
<b>Introduction</b> .....	<b>5</b>
System requirements .....	5
<b>Initial Setup</b> .....	<b>6</b>
Connecting the device(s) and computer to a network.....	6
Installing DMS Local .....	7
Configuring Settings (For Projectors Only).....	7
<b>Using DMS Local</b> .....	<b>8</b>
Launching DMS Local for the First Time.....	8
Closing DMS Local.....	8
The DMS Local Main Page .....	10
Adding Devices to DMS Local .....	11
Managing Your devices .....	14
Creating Groups .....	15
Renaming a Device .....	16
Deleting a Device .....	16
Device Tree Icons .....	17
Status Icons .....	17
Monitoring Your Devices.....	18
The Device Panel.....	18
The Information Tab.....	21
Controlling Your devices.....	23
The Control Tab (Single BenQ Projector).....	24
The Control Tab (Single Non-BenQ Projector) .....	25
The Control Tab (Single BenQ Display) .....	26
The Control Tab (Multiple Projectors).....	27
The Control Tab (Multiple Displays) .....	28
The Control Tab (Multiple Devices).....	29
Quick Settings .....	30
Direct Command Input.....	32

- Scheduling a Task for Your Devices ..... 36
  - Creating/Editing a Scheduled Task..... 37
- The App List Tab ..... 39
  - Viewing Installed Apps ..... 39
  - Editing an App Name and Description ..... 41
  - Installing an App ..... 42
  - Uninstalling an App..... 43
  - Updating the Android Operating System on your Device..... 44
- Setting a Login Password for DMS Local ..... 45
- Other Functions ..... 46
  - Generating an Error Report (For Projectors Only) ..... 46
  - Exporting Device Listings..... 47
  - Updating Firmware (For Projectors Only) ..... 47
  - Virtual Keypad (For Projectors Only) ..... 48
  - Error Notifications via E-mail (For Projectors Only) ..... 49
  - Backing Up Device Listings ..... 51
  - Transferring Device Listings to DMS Cloud via Agent Mode 52
- About DMS Local ..... 57**
- Troubleshooting ..... 58**
- Appendix: About DMS Cloud..... 59**



# Introduction

DMS Local is a software tool for computers that enables remote and centralized management of multiple digital projectors and/or displays by IT administrators/technicians via a local network. DMS Local's management capabilities include the ability to remotely monitor, control, and configure projectors/displays individually or as groups.

DMS Local is designed for use in settings where multiple devices are spread out across various spaces and, as a result, needs a central portal to manage and monitor each device remotely, for example a multi-floored office building or a school with multiple classrooms.

## System requirements

To install and run DMS Local, a computer must meet the following minimum hardware and software requirements.

<b>CPU</b>	Intel i7 2.6GHz
<b>Free memory</b>	8 GB
<b>Hard disk space</b>	2 GB
<b>Connectivity</b>	<ul style="list-style-type: none"> <li>• Wi-Fi capability</li> <li>• RJ-45 Ethernet port</li> </ul>
<b>Display Resolution</b>	1054x640 or higher  It is suggested that the resolution for your computer's is set to 1054x640 or higher with a standard size/ratio to ensure the best visualization of the DMS Local interface.
<b>Operating system</b>	<ul style="list-style-type: none"> <li>• Windows 11</li> <li>• Windows 10</li> </ul>
<b>Other</b>	For certain functions within DMS Local, the following requirements may need to be met: <ul style="list-style-type: none"> <li>• Internet access</li> <li>• A Gmail, Yahoo Mail, or Outlook Mail Service account</li> </ul>  Mail accounts must be configured to allow less secure sign-ins for full functionality in DMS Local. For Gmail accounts, you can configure this setting in the <b>Google Account &gt; Apps with account access &gt; Allow less secure apps</b> menu. For other mail services, this setting should be located in the security settings menu for the service.

For a device to support management via DMS Local, the device must feature the following item:

- An RJ-45 Ethernet port with LAN control functionality



DMS Local also supports non-BenQ projectors that utilize the PJLink protocol.

## Initial Setup

Before you can properly use DMS Local to manage your device(s), the following setup procedures must be completed:

- Connect the devices and computer to the same network
- Install DMS Local on your computer
- Configure device settings

### Connecting the device(s) and computer to a network

To connect the devices and computer to the same network, follow the steps below:

1. Connect the devices to an Ethernet LAN or WAN network via a hub, switch or router using RJ-45 cables.
2. Connect the computer to the same network using either an RJ-45 cable or via a wireless connection.

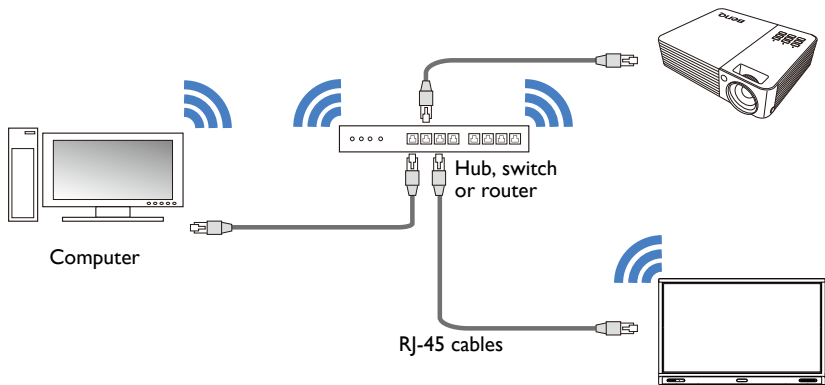

- For details on the location of ports and connectors, please refer to the documentations for the computer and devices.
- It is suggested that you connect your computer to the network using a RJ-45 cable to ensure a stable connection.

3. [For Projectors Only]: Ensure that the IP address for each projector is properly set and that the IP address is shown on the OSD menu of the projector. You may need to contact your network administrator for assistance in setting the projectors' IP addresses.

---

## Installing DMS Local

To install DMS Local on your computer, first ensure that the computer meets the minimum system requirements described on [System requirements](#), then follow the steps below:



To avoid improper functioning for DMS Local, it is suggested that only one computer in the shared network install and run DMS Local. Multiple computers simultaneously running DMS Local will prevent DMS Local from functioning properly.

---

1. Download the DMS Local software from the following URL:  
[https://www.benq.com/content/dam/newb2b/Support/Software/DMS\\_Local/dms\\_local\\_2.2.4.1.exe](https://www.benq.com/content/dam/newb2b/Support/Software/DMS_Local/dms_local_2.2.4.1.exe)
2. Launch the installation file and follow the on-screen instructions to complete the installation.

## Configuring Settings (For Projectors Only)

For DMS Local to be able to access a projector while it is in standby mode, the settings on the projector must be pre-configured by your IT administrator to ensure that the **Enable Network Standby Mode** setting in the projector's setting menu is set to **On**.



- For BenQ projectors, this setting can be found in either the **System > Standby Settings > Network** or **Advanced > Standby Settings > Network** menu.
  - For non-BenQ projectors, refer to the documentation for the device.
  - For certain projectors, "Monitor Out" should be enabled in the standby settings menu to ensure that the projector is accessible while in standby mode. Please refer to your projector's user manual for details.
-

# Using DMS Local

## Launching DMS Local for the First Time

1. Make sure you have completed the steps described in [Initial Setup](#).
2. Launch DMS Local in one of the following ways:
  - Click the Windows **Start** button and then select **Programs > DMSLocal > DMSLocal**.
  - Double-click the **DMSLocal** icon on the Windows desktop.



[For Projectors Only]: Some functions such as [Error \(For Projectors Only\)](#) icon projector panel, [Setting a Login Password for DMS Local](#), and [Generating an Error Report \(For Projectors Only\)](#) are not available for current projector models.

3. Select **Activate** and sign in to BenQ service. If you don't have a BenQ account, click **Register Here**.

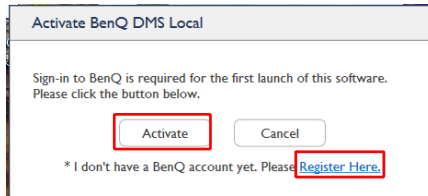

4. Follow the instructions on the BenQ service website to verify your account. You'll see the following screen when you're all set.

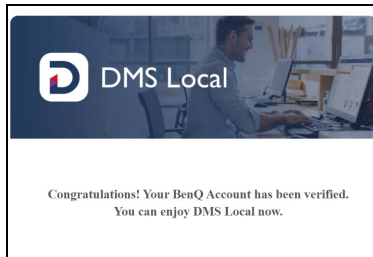

Once you have activated DMS Local and begin using DMS Local for the first time, it is suggested that you update DMS Local's database of devices to ensure that DMS Local features the most up-to-date information available on BenQ's cloud service site. For more information on updating DMS Local's database of devices, refer to the instructions in [Adding Devices to DMS Local](#).

## Closing DMS Local

When you are finished using DMS Local, closing the program window alone does not properly close DMS Local. You must fully exit the program to ensure that DMS Local is properly closed. To exit DMS Local, follow the instructions below:



1. Click  in the Windows system tray.

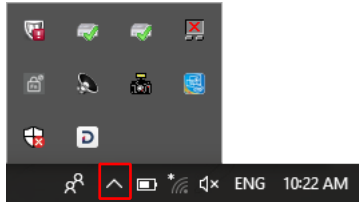

2. Right-click the DMS Local icon  and select **Exit**.

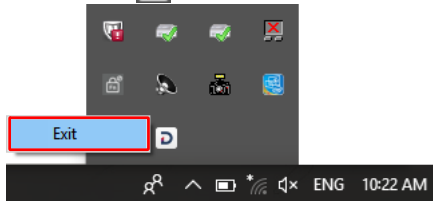





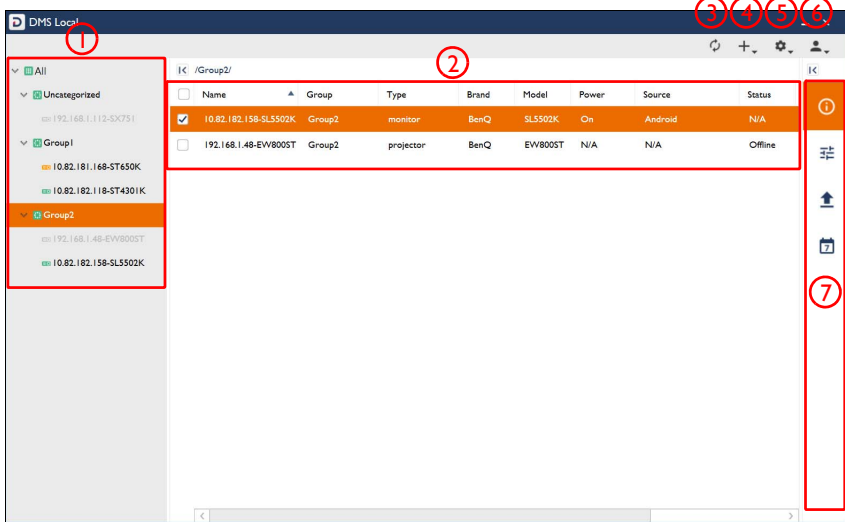





## The DMS Local Main Page

The main page for DMS Local will be shown. The following items are featured on the DMS Local main page.



The illustrations and the screens shown in this guide are for your reference. The actual content and available functions may vary by the connected devices and the product supplied for your region.

No.	Item	Description
1	Device Tree	Shows all the devices and device groups managed by DMS Local in a tree-view structure. See <a href="#">Adding Devices to DMS Local</a> for more information on the adding devices to the device tree. See <a href="#">Device Tree Icons</a> for more information on the status icons shown in the device tree.
2	Device Panel	Shows status information for the device(s) or device groups selected in the device tree. See <a href="#">The Device Panel</a> for more information on the various fields featured in the device panel.
3	Refresh 	Click to refresh the status of the devices shown on the main page.  DMS Local will automatically refresh the device status after a given interval of time. The refresh button is to allow users to get the most up-to-date information at any given time.

No.	Item	Description
4	Add 	Click to search for and add devices to the DMS Local management system, or to create groups for better organization in the device tree. See <a href="#">Adding Devices to DMS Local</a> for more information on adding devices and device groups.
5	Settings 	Click to access various system management functions for administrators, such as error reports, e-mail alerts, database backups, and more. See <a href="#">Other Functions</a> for more information on the system management functions available for the Settings button.
6	User 	Click to setup a login password for DMS Local. See <a href="#">Setting a Login Password for DMS Local</a> for more information on setting up a login password.
7	Action Panel	Provides various tools that allow you to further manage/monitor devices and device groups, including the information tab (  ) , control tab (  ) , and the schedule tab (  ) . For certain devices an apps list tab (  ) is also available in the Action Panel. See <a href="#">The Information Tab</a> , <a href="#">Controlling Your devices</a> , or <a href="#">Scheduling a Task for Your Devices</a> for more information on each tab in the Action Panel.  The action panel only appears when a device or device group is selected in the device panel. The information tab only appears when a single device is selected in the device panel.

## Adding Devices to DMS Local

In order to manage a device via the DMS Local software, the device must first be added into the DMS Local device tree.

Before adding any devices, it is suggested that you first update DMS Local's database of devices to ensure that DMS Local features the most up-to-date information regarding newly added devices, including their product names and available configurations. To update DMS Local's device database, follow the steps below:

1. Ensure that the computer running DMS Local is connected to the Internet.
2. Click the Settings button  and then select **Update device definitions (JSON)**.

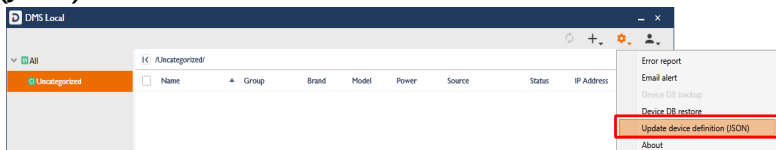

- Once the prompt notifying you that the device definitions have been updated appears, restart DMS Local and begin adding devices.

To add device(s) to DMS Local follow the steps below:



Before following the steps below, ensure that your computer and devices are connected to the same network, as described in [Connecting the device\(s\) and computer to a network](#).

- Click the add button (+) and then select **Add new device**.



- In **Add new device** pop-up window, choose one of the following options:
  - In the **Network Interface** field select the interface your computer is using to connect to the network, and then click **Scan**.

**Add new device**

Please select the network interface connected to the target device network for scanning.

Network Interface

Realtek PCIe FE Family Controller - [192.168.1.103]

Search specific IP range

~



The network interface can be either your computer's network card (for wired connections) or its wireless card (for wireless connections).

- Check the **Search specific IP range** box, enter the IP range set for the devices in the network by the IT administrator, and then click **Scan**.

**Add new device**

Please select the network interface connected to the target device network for scanning.

Network Interface

Realtek PCIe FE Family Controller - [192.168.1.103]

Search specific IP range

~



To obtain the IP range for the devices on your network, consult your IT administrator.

3. After DMS Local is finished scanning, a list of devices that are connected to your network will appear. In the devices list you can choose from the following options:

Add new device

Select device(s) to be added

Checked device(s) will be added. Modify Name/Description fields if needed.

<input type="checkbox"/>	IP Address ▲	Model	Name	Description	Identify
<input type="checkbox"/>	192.168.31.111	ST5501K	192.168.31.111-ST5501K		9
<input type="checkbox"/>	192.168.31.116	RM7502K	192.168.31.116-RM7502K		7
<input type="checkbox"/>	192.168.31.164	BH2401	192.168.31.164-BH2401		6
<input type="checkbox"/>	192.168.31.185	RP860K	192.168.31.185-RP860K		2
<input type="checkbox"/>	192.168.31.188	RM6501K	192.168.31.188-RM6501K		8
<input type="checkbox"/>	192.168.31.28	BH3501	192.168.31.28-BH3501		1

Back Add Cancel

- Check the box next to the device(s) you want to add or check the select all box to select all the devices on the list.
  - Enter a name for the device in the **Name** field. If you do not enter a name in the field, the default name for the device (the IP address for the device followed by the device's model name) will be used.
  - Enter a description for the display in the **Description** field to provide more detailed information about the device to be viewed in the Information Tab.
  - [For BenQ projectors and displays only] Click the numbered button in the **Identify** field to help you identify which device corresponds to the device name shown. Once you click the numbered button, the corresponding device will flash a screen to help you identify the respective device.
4. Once you have finished with the options described above, click **Add** to add the selected devices.

Add new device

Select device(s) to be added

Checked device(s) will be added. Modify Name/Description fields if needed.

<input checked="" type="checkbox"/>	IP Address ▲	Model	Name	Description	Identify
<input checked="" type="checkbox"/>	192.168.31.111	ST5501K	192.168.31.111-ST5501K		9
<input checked="" type="checkbox"/>	192.168.31.116	RM7502K	192.168.31.116-RM7502K		7
<input checked="" type="checkbox"/>	192.168.31.164	BH2401	192.168.31.164-BH2401		6
<input checked="" type="checkbox"/>	192.168.31.185	RP860K	192.168.31.185-RP860K		2
<input checked="" type="checkbox"/>	192.168.31.188	RM6501K	192.168.31.188-RM6501K		8
<input checked="" type="checkbox"/>	192.168.31.28	BH3501	192.168.31.28-BH3501		1

Back Add Cancel

## Managing Your devices

Once you have added the device(s) into the DMS Local system, the devices will appear in the device tree on the main page. Initially all newly added device will be listed in the **Uncategorized** group of devices.

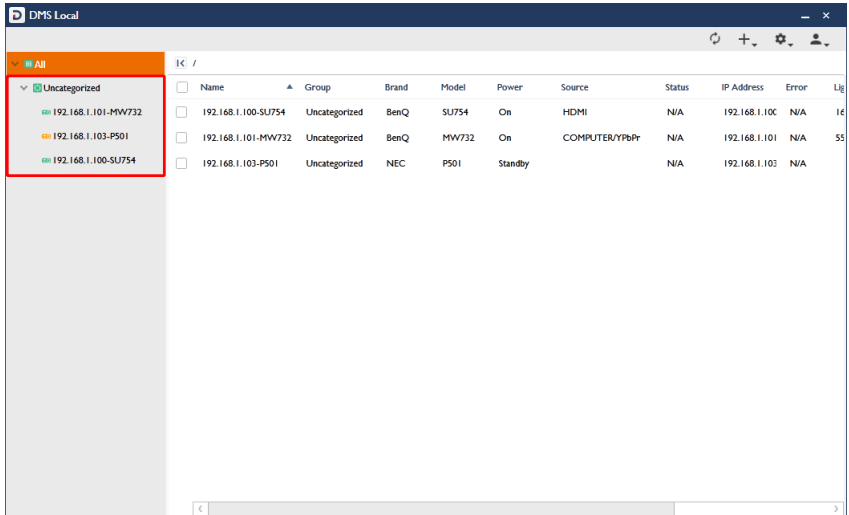

The screenshot shows the DMS Local application window. On the left, a sidebar displays a tree view with 'All' and 'Uncategorized' folders. The 'Uncategorized' folder is expanded, showing three device entries: 192.168.1.101-MW732, 192.168.1.103-P501, and 192.168.1.100-SU754. The main area displays a table of these devices with columns for Name, Group, Brand, Model, Power, Source, Status, IP Address, and Error.

<input type="checkbox"/>	Name	Group	Brand	Model	Power	Source	Status	IP Address	Error	Log
<input type="checkbox"/>	192.168.1.100-SU754	Uncategorized	BenQ	SU754	On	HDMI	N/A	192.168.1.100	N/A	16
<input type="checkbox"/>	192.168.1.101-MW732	Uncategorized	BenQ	MW732	On	COMPUTER/YPrPr	N/A	192.168.1.101	N/A	55
<input type="checkbox"/>	192.168.1.103-P501	Uncategorized	NEC	P501	Standby		N/A	192.168.1.103	N/A	

To help you better organize and identify your devices, DMS Local features the following options:

- Create Device Groups
- Rename Devices
- Delete Devices

## Creating Groups

In instances where DMS Local is used to manage a large number of devices spread out over various spaces, organizing devices into groups may be useful to manage your devices. To create a device group follow the steps below:

1. Select the **All** category in the device tree, then click the add button (+) and select **Add new group**.

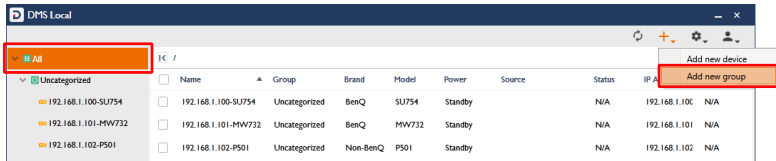

- A sub-group can be created within a group by selecting the group in the device tree that you want to create the sub-group in and then following the steps described in this section.
- A group cannot be created within the **Uncategorized** group in the device tree.

2. In the **Add new group** pop-up window enter a name for the group and then click **Add**.

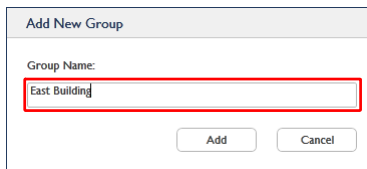

3. Once the new group has been created, it will appear in the device tree. You can begin adding devices to the group by selecting the respective device in the device tree, dragging it into the group, and then confirming the addition.

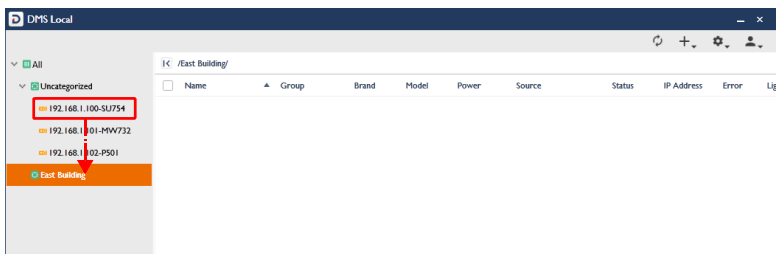

- A device can only be part of one group at a time.

4. To rename a group, right-click the group you want to rename and select **Rename**.

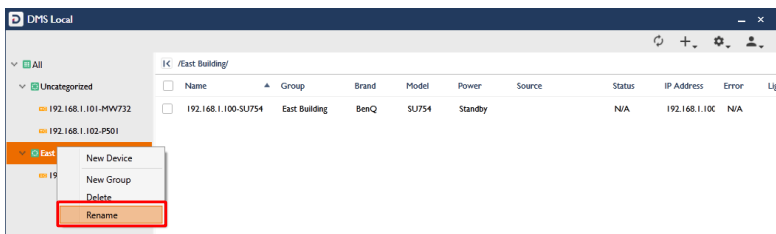

## Renaming a Device

As described in [Adding Devices to DMS Local](#), the **Add new device** menu allows you to rename a device while adding it to DMS Local. In instances where a device is not renamed while it is being added to DMS Local, the device will be added using its default name (the IP address for the device followed by the device's model number). You can then rename a device to a more easily identifiable name at any time by following the steps below:

1. Right-click on the device you want to rename in the device tree, and then select **Rename**.

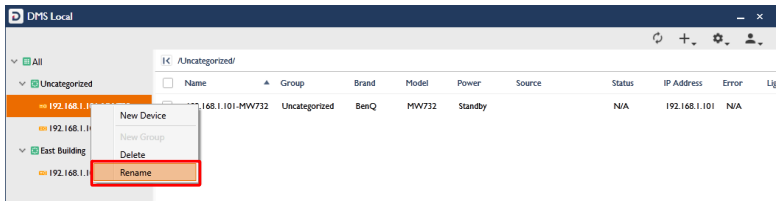

2. In the **Rename** menu enter the new name and then click **Rename**.

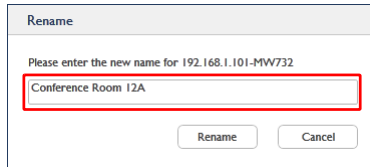

## Deleting a Device

To delete a device from the device tree, right-click on the device you want to delete in the device tree, and then select **Delete**.

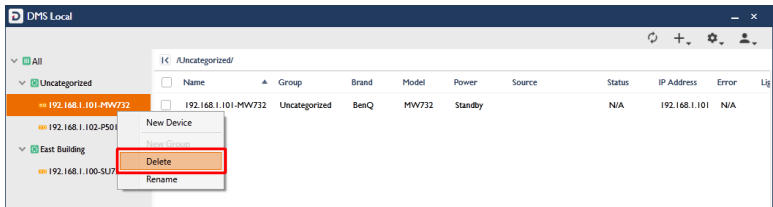



## Device Tree Icons

As described earlier, the device tree lists all devices managed by DMS Local in a hierarchical, tree-view structure. The device tree also shows various icons that allow you to quickly view the current status of all devices and whether or not there are any errors causing the device to malfunction.

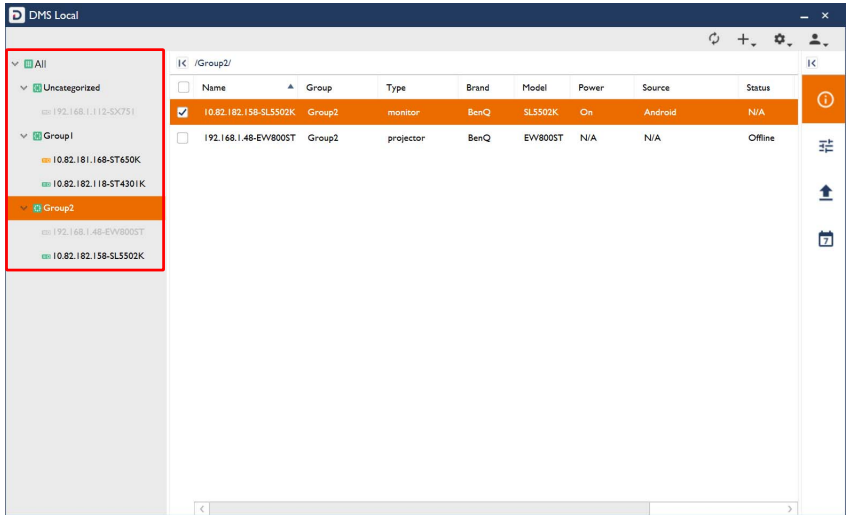

## Status Icons

Icons that indicate the current status of each device appears to the left of the device's name in the device tree. Icons that indicate errors for a device appears to the right of the device's name in the device tree. The table below provides descriptions of each icon.

Icon	Status	Description
	Online	The device is powered on.
	Standby	The device is in standby mode.
	Offline	The device is undetected by DMS Local. This status usually indicates a problem with the device's connection to the network or with the network itself, in such instances it is suggested that you check the device's connection.
	Error*	There is an error detected with the projector. For a more detailed description of the error, check the projector's <b>Error</b> column in the Projector Panel.

\*For projectors only

## Monitoring Your Devices

Beyond the status icons shown in the device tree, DMS Local features the device panel to monitor the status of your device and the information tab to view detailed information for each device, both of which are described in the sections below.

### The Device Panel

When either an individual device or a device group is selected in the device tree, the device panel of the DMS Local main page will show in-depth status information for the selected device or the devices in the selected group.

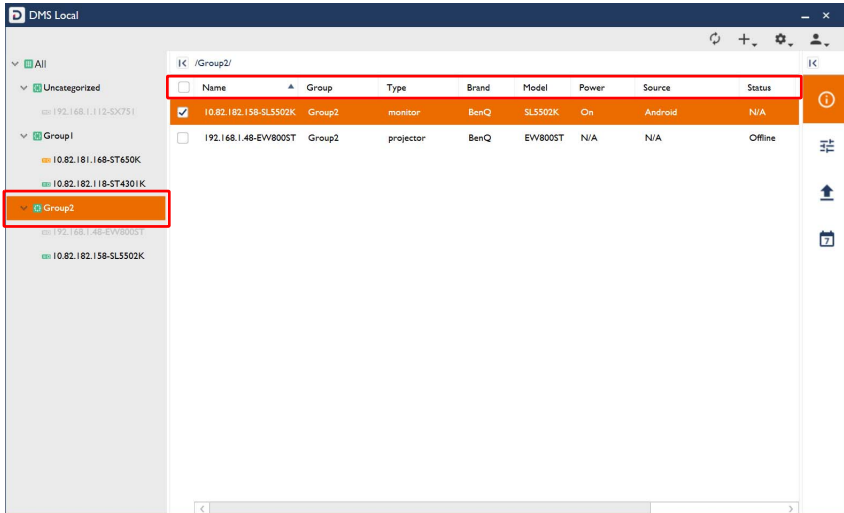

The table below describes the information featured in the device panel.

Item	Description
<b>Name</b>	Name of the device.
<b>Group</b>	Group that the device belongs to.
<b>Type</b>	Type of device, projector or monitor.
<b>Brand</b>	Brand of the device.
<b>Model</b>	Model name for device.
<b>Power</b>	Current power status of the device. See <a href="#">Power</a> for definitions of the various power statuses.
<b>Source</b>	Current signal source for the device.
<b>Status</b>	Current operating status of the device. See <a href="#">Status</a> for definitions of the various statuses.
<b>IP Address</b>	IP address for the device.

Item	Description
<b>Error*</b>	Error or warning messages for the projector. See <a href="#">Error (For Projectors Only)</a> for definitions of the various error messages.
<b>Light Used*</b>	The cumulative hours the lamp has been used.
<b>Light 2 Used*</b>	The cumulative hours the second lamp has been used.
*For projectors only	

## Power

The **Power** column in the device panel shows the current power status of the device(s). The following table defines the various power statuses available in the device panel.

Power Status	Description
<b>On</b>	The device is powered on.
<b>Standby</b>	The device is in standby mode.
<b>N/A</b>	The device is undetected by DMS Local. This status usually indicates a problem with the device's connection to the network or with the network itself, in such instances it is suggested that you check the device's connection.





## Status

The **Status** column in the device panel shows the current operating status of the device(s). The following table defines the various statuses available in the device panel.

Status	Description
<b>Normal</b>	The device is operating normally.
<b>Error*</b>	The projector has encountered an operating error. When this status is shown, check the <b>Error</b> column in the projector panel to view detailed information regarding the operating error.
<b>N/A</b>	<ul style="list-style-type: none"> <li>The device does not support the transmission of error messages over the network.</li> <li>The device is in standby mode.</li> </ul>
<b>Offline</b>	The device is undetected by DMS Local. This status usually indicates a problem with the device's connection to the network or with the network itself, in such instances it is suggested that you check the device's connection.
*For projectors only	

## Error (For Projectors Only)

Depending on the operating status indicated in the **Status** column of the projector panel, the **Error** column may show a more detailed message regarding the type of operating error the projector may have encountered. The following table defines the various operating errors featured in the projector panel.

Error Icon/ Message	Description
	<p>Indicates a system error based on one of the following scenarios:</p> <ul style="list-style-type: none"> <li>• The color wheel has failed to start.</li> <li>• The scaler has shutdown abnormally.</li> <li>• The filter life has changed.</li> <li>• The scaler has failed to reset.</li> </ul>
	<p>Indicates a lamp error based on one of the following scenarios:</p> <ul style="list-style-type: none"> <li>• The life of the lamp/light source has been exhausted.</li> <li>• The lamp door is not closed.</li> <li>• Lamp 1 / Light source error.</li> <li>• Lamp 2 / Light source error.</li> <li>• Both lamps have failed.</li> <li>• Lamp 1 / light source is not lit up.</li> </ul>
	<p>Indicates that at least one of the fans in the projector has encountered an error.</p>
	<p>Indicates a temperature error based on one of the following scenarios:</p> <ul style="list-style-type: none"> <li>• Temperature 1 or 2 error.</li> <li>• Thermal sensor 1 or 2 open error.</li> <li>• Thermal sensor 1 or 2 short error.</li> <li>• Thermal IC #1 or 2 I2C connection error.</li> <li>• Thermal break error</li> </ul>
(No message)	<p>There is currently no operating issues (the <b>Status</b> field will show <b>Normal</b>).</p>
<p><b>N/A</b></p>	<p>DMS Local is not able to read the status information of the projector. This can indicate the following scenarios:</p> <ul style="list-style-type: none"> <li>• The projector does not support the transmission of error messages over the network.</li> <li>• The projector is in standby mode (the <b>Status</b> field will show <b>N/A</b>).</li> <li>• The projector is undetected by DMS Local (the <b>Status</b> field will show <b>Offline</b>).</li> </ul>



For more information on error descriptions, projector indicator definitions, and troubleshooting, please refer to the projector's user manual.

## The Information Tab

The information tab of DMS Local shows detailed information for a device and is only accessible when a single device is selected in the device panel and the information button in the action panel is clicked.

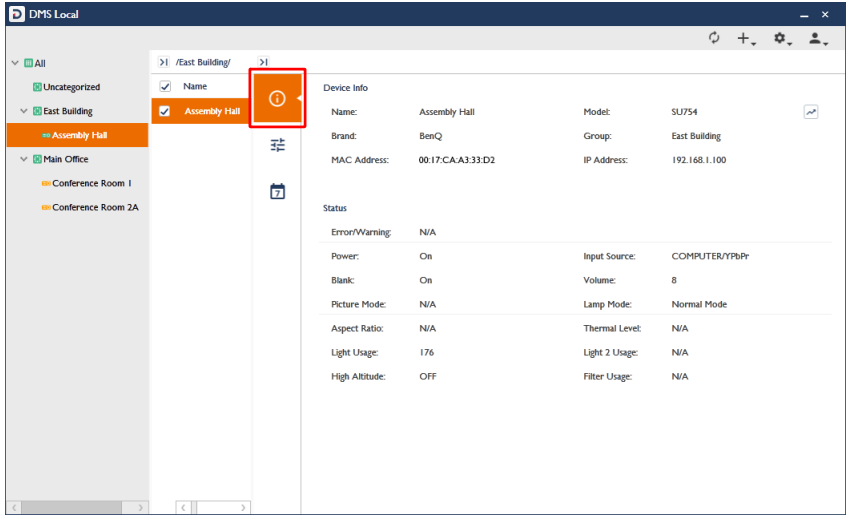

The table below describes the detailed information featured in the information tab.

Item	Description
<b>Name</b>	Name of the device.
<b>Model</b>	Model name for device.
<b>Brand</b>	Brand of the device.
<b>Group</b>	Group that the device belongs to.
<b>Type<sup>1</sup></b>	Describes the type of device/display (e.g. monitor, IFP, Signage, etc).
<b>MAC Address</b>	MAC address for the device.
<b>IP Address</b>	IP address for the device.
<b>Version<sup>1</sup></b>	Indicates the firmware version installed on the display.
<b>Device ID<sup>1</sup></b>	Unique ID number for the display.
<b>Error/Warning<sup>2</sup></b>	Error or warning messages for the projector. See <a href="#">Error (For Projectors Only)</a> for definitions of the various error messages.
<b>Power</b>	Current power status of the device. See <a href="#">Power</a> for definitions of the various power statuses.
<b>Input Source</b>	Current signal source for the device.

Item	Description
<b>Blank</b>	Indicates whether the blank screen function for the device is on or off.
<b>Volume</b>	Current volume level for the device.
<b>Picture Mode</b>	Current picture mode setting for the device.
<b>Lamp Mode<sup>2</sup></b>	Current lamp mode setting for the projector.
<b>Aspect Ratio</b>	Current aspect ratio for the device.
<b>Thermal Level<sup>2</sup></b>	Current thermal level for the projector.
<b>Light Used<sup>2</sup></b>	The cumulative hours the lamp has been used.
<b>Light 2 Used<sup>2</sup></b>	The cumulative hours the 2nd lamp has been used.
<b>High Altitude<sup>2</sup></b>	Indicates whether the high altitude configuration is on or off.
<b>Filter Usage<sup>2</sup></b>	Current filter used for the projector.
<b>Device Runtime<sup>1</sup></b>	Current operating time for the display (in hours).
<sup>1</sup> For displays only	
<sup>2</sup> For projectors only	



- The fields displayed in the information tab may vary depending on the model selected.
- If the projector does not support the transmission of a certain field's information over the network, the field will show "N/A".
- For non-BenQ projectors, only the following fields will display information: **Name, Group, Brand, Model, Power, and IP Address**. All other fields will show "N/A"

## Controlling Your devices

The control tab of DMS Local features a panel of functions that allows you to control an individual device or an entire group when they are selected in the device panel and the control button in the action panel is clicked. The control tab also allows users to enter and save control command codes using the BenQ protocol (for BenQ devices), the PJLink protocol or self-input via the protocol port (for non-BenQ projectors) to create custom controls for the device.

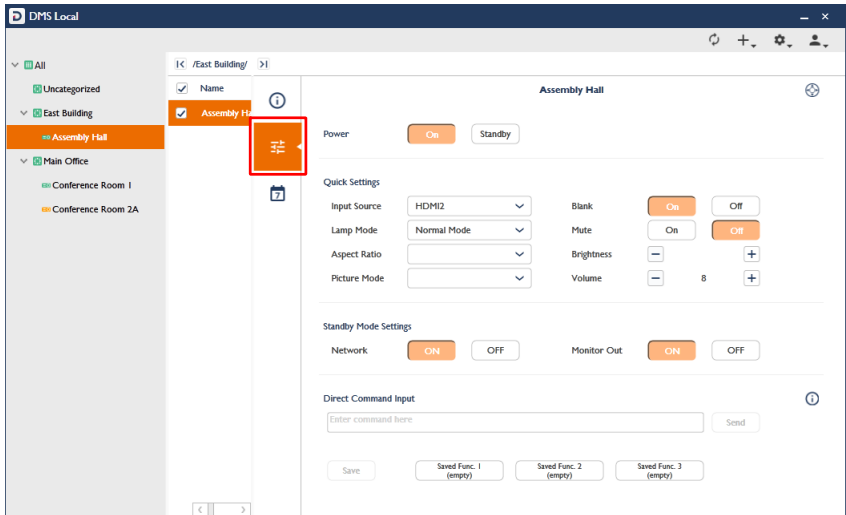

When DMS Local detects a problem with the device's connection to the network, all the buttons and fields in the control tab will be greyed out.

The control tab will show different control items depending on what type of selection is made in the device panel. The possible selections include the following:

- A single BenQ projector
- A single non-BenQ projector
- A single BenQ display
- Multiple projectors in a group
- Multiple displays in a group

The sections below describe the control panel for each of the items above.

## The Control Tab (Single BenQ Projector)

When a single BenQ projector is selected in the projector panel, the control tab features the following items:

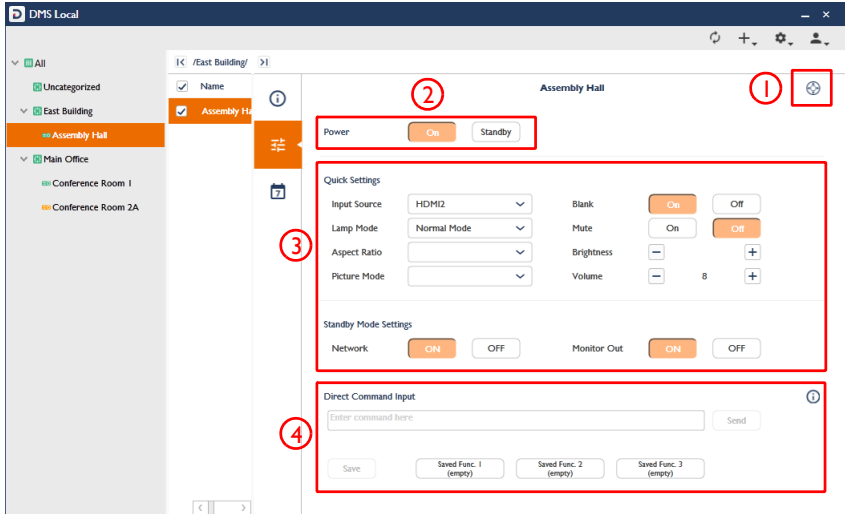

No.	Item	Description
1	Virtual Keypad	Click to view a virtual keypad for the projector. See <a href="#">Quick Settings</a> for more information on the virtual keypad.
2	<b>Power</b>	Powers on the projector or puts it in standby mode.
3	<b>Quick Settings</b>	Features buttons and menus to control your projector. See <a href="#">Quick Settings</a> for more information on the quick settings controls.
4	<b>Direct Command Input</b>	Send or save custom control command codes for the projector using the BenQ protocol for projector control. See <a href="#">Direct Command Input</a> for more information on the basic controls.



## The Control Tab (Single Non-BenQ Projector)

When a single non-BenQ projector is selected in the projector panel, the control tab features the following items:

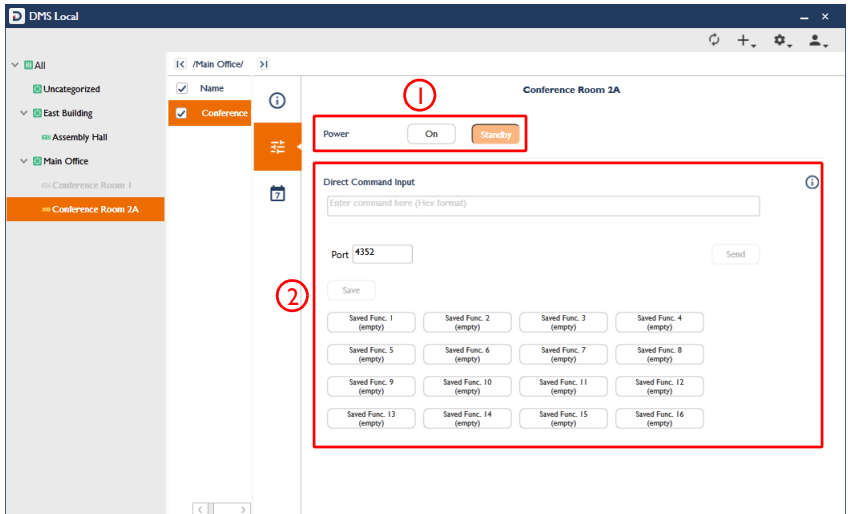



No.	Item	Description
1	<b>Power</b>	Powers on the projector or puts it in standby mode via the PJ Link protocol.
2	<b>Direct Command Input</b>	Send or save custom command control codes for the projector using either the (default) PJLink protocol or direct input via the protocol port. See <a href="#">Direct Command Input</a> for more information on the basic controls.

## The Control Tab (Single BenQ Display)

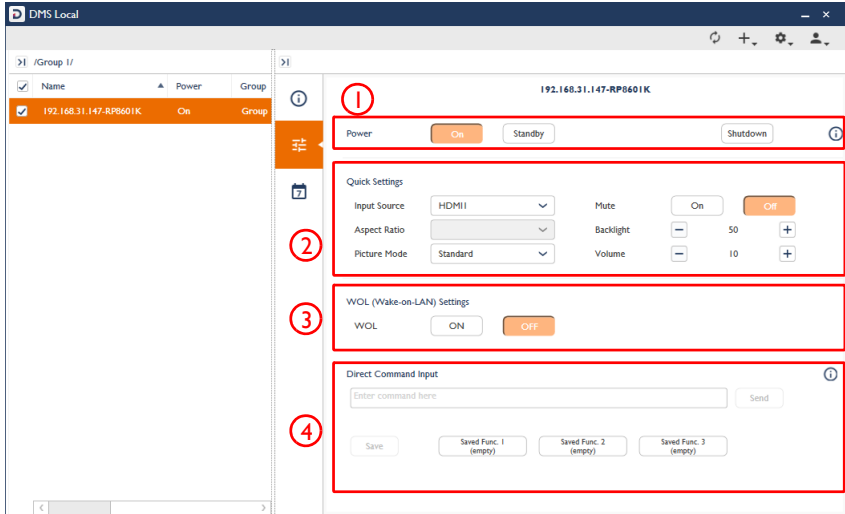
When a single BenQ display is selected in the device panel, the control tab features the following items:





No.	Item	Description
1	<b>Power</b>	<p>Powers on the display, puts it in standby mode, or powers off (shuts down) the display.</p> <p> To power on the display via DMS Local make sure that the <b>WOL (Wake-on-LAN) Settings</b> on the display is enabled and that the display is connected to the network via the LAN (RJ-45) port. Wake-on-LAN does not work over a Wi-Fi connection.</p>
2	<b>Quick Settings</b>	<p>Features buttons and menus to control your display.</p> <p>See <a href="#">Quick Settings</a> for more information on the quick settings controls.</p>
3	<b>WOL (Wake-on-LAN) Settings</b>	<p>Allows the display to be able to be powered on remotely from a shutdown state via the LAN port.</p> <p> The <b>WOL (Wake-on-LAN) Settings</b> function only works on displays that are connected to the network via their LAN (RJ-45) port. Displays that are connected to the network via a Wi-Fi connection will not be able to use the <b>WOL (Wake-on-LAN) Settings</b> function.</p>
4	<b>Direct Command Input</b>	<p>Send or save custom control command codes for the display using the BenQ protocol for display control.</p> <p>See <a href="#">Direct Command Input</a> for more information on the basic controls.</p>

## The Control Tab (Multiple Projectors)

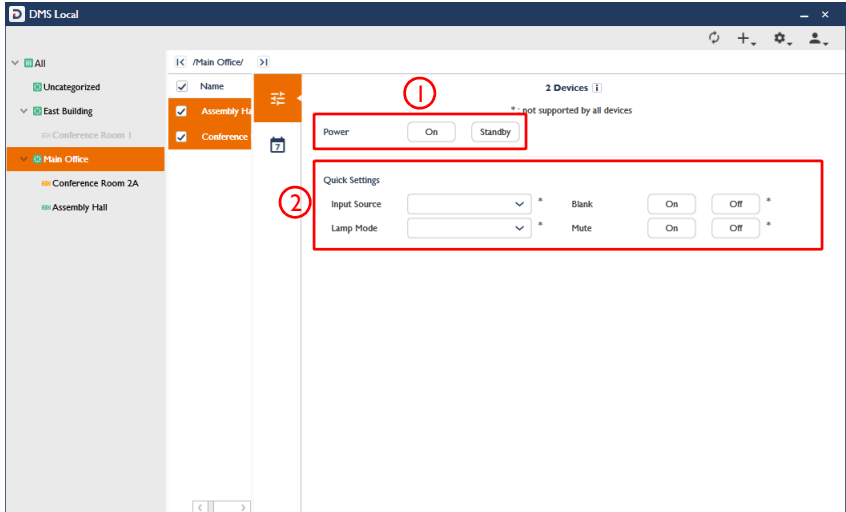
When multiple projectors in a projector group are selected in the projector panel, the control tab features the following items:





No.	Item	Description
1	<b>Power</b>	Powers on the projector or puts it in standby mode.
2	<b>Quick Settings</b>	<p>Features buttons and menus to control your projector. See <a href="#">Quick Settings</a> for more information on the quick settings controls.</p> <p> Only functions supported by all projectors in the group will be supported in the <b>Quick Settings</b> section. Functions that are not supported by all projectors will show an asterisk (*).</p>
		If a non-BenQ projector is part of the group of projectors selected, only the <b>Power</b> function will be available in the control tab.

## The Control Tab (Multiple Displays)

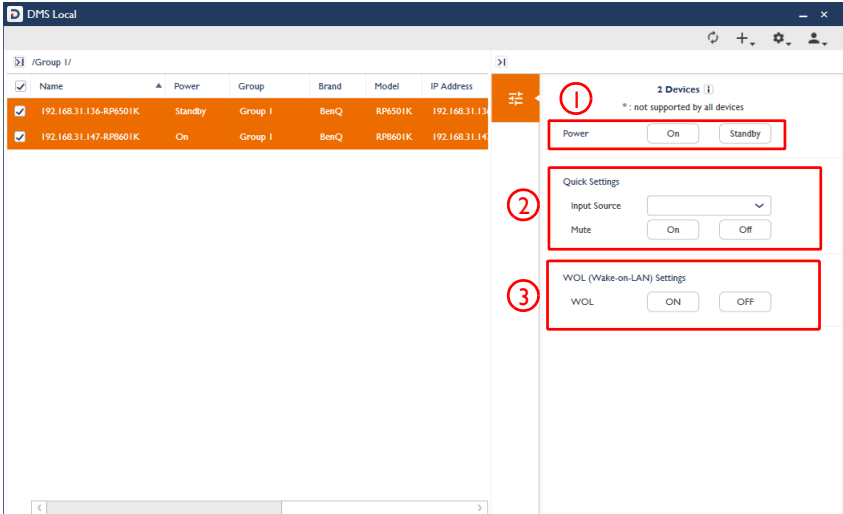
When multiple displays in a display group are selected in the device panel, the control tab features the following items:





No.	Item	Description
1	<b>Power</b>	<p> Powers the display or puts it in standby mode.</p> <p>To power on the display via DMS Local make sure that the <b>WOL (Wake-on-LAN) Settings</b> on the display is enabled and that the display is connected to the network via the LAN (RJ-45) port. Wake-on-LAN does not work over a Wi-Fi connection.</p>
2	<b>Quick Settings</b>	<p>Features buttons and menus to control your display.</p> <p>See <a href="#">Quick Settings</a> for more information on the quick settings controls.</p> <p> Only functions supported by all displays in the group will be supported in the <b>Quick Settings</b> section. Functions that are not supported by all displays will show an asterisk (*).</p>
3	<b>WOL (Wake-on-LAN) Settings</b>	<p>Allows the display to be able to be powered on remotely from a shutdown state via the LAN port.</p> <p> The <b>WOL (Wake-on-LAN) Settings</b> function only works on displays that are connected to the network via their LAN (RJ-45) port. Displays that are connected to the network via a Wi-Fi connection will not be able to use the <b>WOL (Wake-on-LAN) Settings</b> function.</p>

## The Control Tab (Multiple Devices)

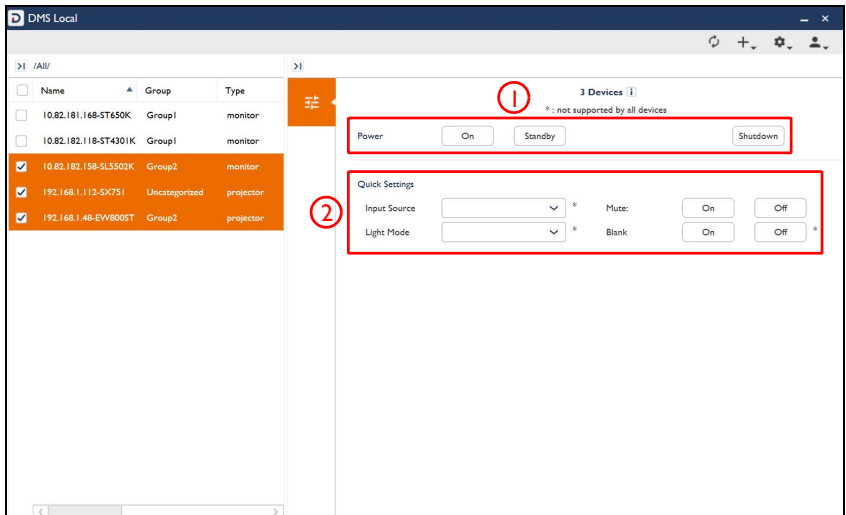
When multiple devices including both projectors and displays are selected in the device panel, the control tab features the following items:



No.	Item	Description
1	<b>Power</b>	<p>Powers on the devices, puts them in standby mode, or powers off (shuts down) the devices.</p> <p> To power on the display via DMS Local make sure that the <b>WOL (Wake-on-LAN) Settings</b> on the display is enabled and that the display is connected to the network via the LAN (RJ-45) port. Wake-on-LAN does not work over a Wi-Fi connection.</p>
2	<b>Quick Settings</b>	<p>Features buttons and menus to control your device. See <a href="#">Quick Settings</a> for more information on the quick settings controls.</p> <p> Only functions supported by all devices in the group will be supported in the <b>Quick Settings</b> section. Functions that are not supported by all displays will show an asterisk (*).</p>

## Quick Settings

The quick settings section of the control tab features the following buttons and menus which help you control your device.

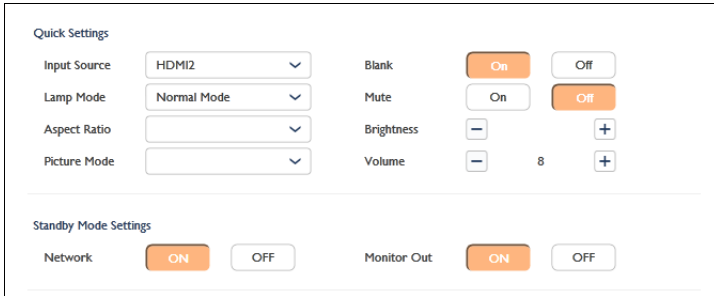

Button	Description
<b>Input Source</b>	Sets the input source for the device.
<b>Blank</b> <sup>2</sup>	Toggles a blank screen for the projector on or off.
<b>Lamp Mode</b> <sup>2</sup>	Select the lamp mode settings for the projector.
<b>Light Mode</b>	Select the light mode settings for the device.
<b>Mute</b>	Mutes or unmutes the audio output.
<b>Aspect Ratio</b> *	Sets the image aspect ratio for the device.
<b>Backlight</b> <sup>1*</sup>	Sets the brightness level of the backlight for the display.
<b>Brightness</b> <sup>2*</sup>	Sets the brightness level for the projector.
<b>Picture Mode</b> *	Sets the picture mode for the device.
<b>Volume</b> *	Adjusts the audio volume.
<b>Network</b> <sup>2*</sup>	Enables/Disables the network function in standby mode.
<b>Monitor Out</b> <sup>2*</sup>	Enables/Disables outputting the signal via the Monitor Out port.
<b>WOL (Wake-on-LAN) Settings</b> <sup>1*</sup>	<p>Allows the display to be able to be powered on remotely from a shutdown state via the LAN port.</p> <p> The <b>WOL (Wake-on-LAN) Settings</b> function only works on displays that are connected to the network via their LAN (RJ-45) port. Displays that are connected to the network via a Wi-Fi connection will not be able to use the <b>WOL (Wake-on-LAN) Settings</b> function.</p>
<p><sup>1</sup> For displays only</p> <p><sup>2</sup> For projectors only</p> <p>*Not available for multiple devices.</p>	



- The fields displayed in the quick settings section may vary depending on the model selected.
  - When the device is in standby mode, all fields in the quick settings section will be empty.
  - When the device is powered on, the fields in the quick settings section will be set to the current configurations of the device.
  - When DMS Local detects a problem with the device's connection to the network, the fields in the quick settings section will be greyed out.
  - When the quick settings section is opened for multiple devices, both control fields and available options that are not supported by all devices will feature an asterisk (\*).
-

## Direct Command Input

The **Direct Command Input** section of the control tab allows you to create custom controls for your device using direct commands. For instance, you can create a command to have your device rotate its screen clockwise 90-degrees.



- Non-BenQ projectors support direct command controls as long as the protocol port is entered.
- Functions available to devices that support direct command controls and their corresponding commands vary by model. Check the specifications and user manual for your device for available functions and commands.
- Direct command controls can only be used on one device at a time.

The **Direct Command Input** section for a BenQ device is shown below:

The **Direct Command Input** section for a non-BenQ projector is shown below:

## Creating a One-Time-Only Direct Command

To create a one-time-only direct command, follow the steps below:

1. For BenQ devices - Enter the direct command code in the **Direct Command Input** field.



For non-BenQ projectors - Enter the direct command code in the **Direct Command Input** field and the TCP port for the projector in the **Port** field.

Direct Command Input

25.31.41.56.4d.54.20.32.31.0d

Port 4352

Send

Save

Saved Func. 1 (empty) Saved Func. 2 (empty) Saved Func. 3 (empty) Saved Func. 4 (empty)

Saved Func. 5 (empty) Saved Func. 6 (empty) Saved Func. 7 (empty) Saved Func. 8 (empty)

Saved Func. 9 (empty) Saved Func. 10 (empty) Saved Func. 11 (empty) Saved Func. 12 (empty)

Saved Func. 13 (empty) Saved Func. 14 (empty) Saved Func. 15 (empty) Saved Func. 16 (empty)



Commands for BenQ projectors must be in ASCII format, while commands for non-BenQ projectors must be in hexadecimal format. For more information on creating direct commands, see [Direct Command Help](#).

2. Click **Send** and wait for a confirmation that the command has been executed successfully.



To prevent quick changes to the device's state, the **Direct Command Input** will be grayed out while DMS Local is confirming whether the direct command is successful. Once the direct command has been confirmed or the confirmation process has timed out, the field will return to its normal state.

## Saving a Custom Direct Command Button

To save a direct command as a custom button, follow the steps below:

1. Click the button you want to customize in the direct command control section.

Direct Command Input

Send

Save

Saved Func. 1 (empty) Saved Func. 2 (empty) Saved Func. 3 (empty)



The direct command control section for BenQ devices features three direct command buttons available for customization, while the direct command control section for non-BenQ devices features 16 direct command buttons available for customization.

- In the **Saved Func.** window that appears click the options button (  ) and select **Edit**.

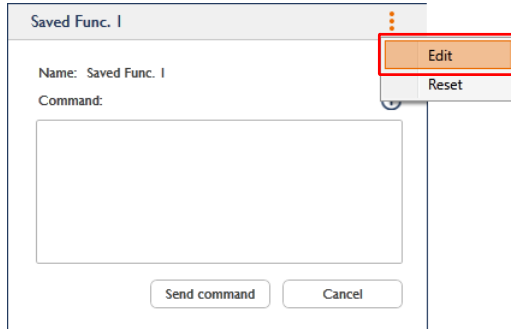

- For BenQ devices - In the **Edit Saved Function** window enter a name for the button in the **Name** field and the direct command code in the **Command** field.

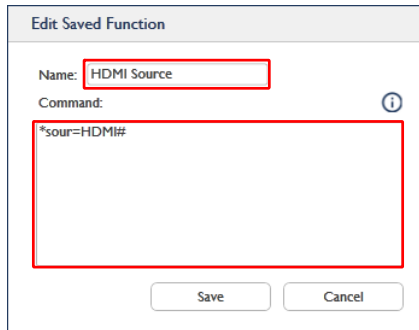

For non-BenQ projectors - In the **Edit Saved Function** window enter a name for the button in the **Name** field, the direct command code in the **Command** field, and the TCP port for the projector in the **Port** field.

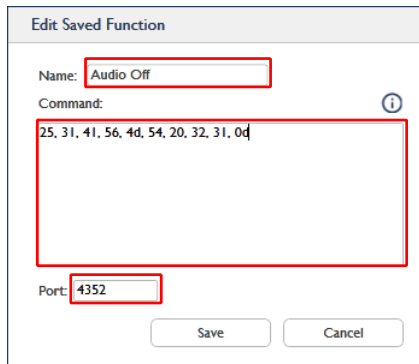

Commands for BenQ projectors must be in ASCII format, while commands for non-BenQ devices must be in hexadecimal format. For more information on creating direct commands, see [Direct Command Help](#).

- Click **Save** in the **Edit Saved Function**, your custom direct command button will appear in the direct command control section of the control panel, which you can click to send the command.

## Direct Command Help

If you need help with creating direct commands in DMS Local, you can click the help button  located in the direct command control section for guidelines on creating direct commands.



Direct Command Input 

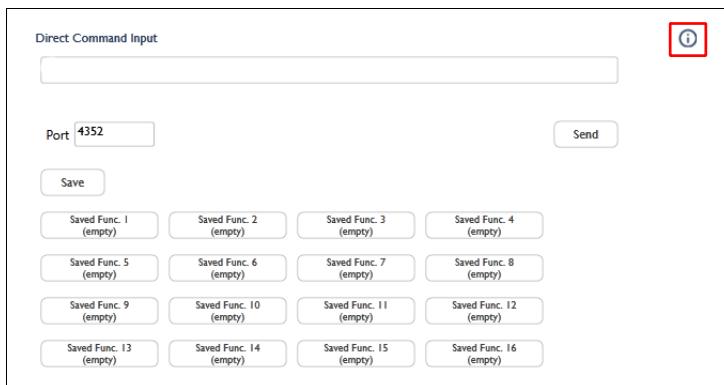

Direct Command Input 

  
Port



## Scheduling a Task for Your Devices

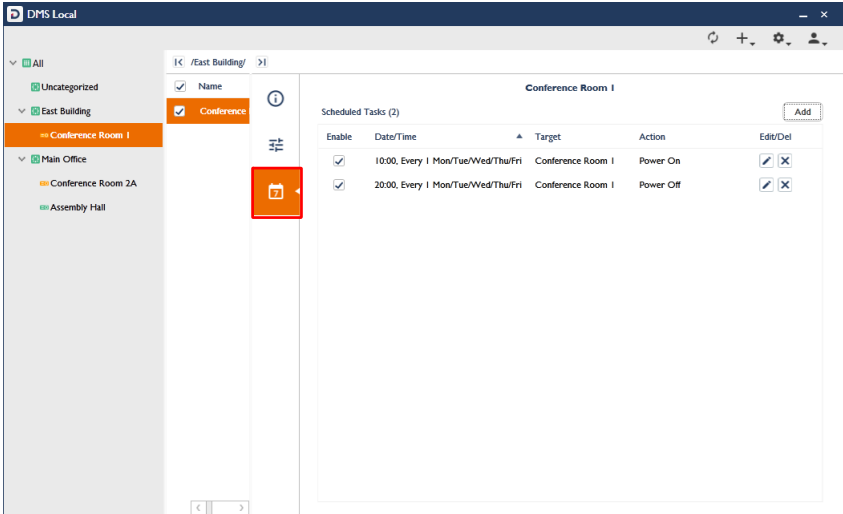

The schedule tab of DMS Local allows you to create scheduled tasks for an individual device or an entire device group when they are selected in the device panel, where the device(s) will automatically perform a certain function at a given day/time.



The schedule tab is not available if the group includes both projectors and displays.

The table below describes the items featured in the schedule tab:

Item	Description
<b>Add</b>	<p>Click to add a new scheduled task. See <a href="#">Creating/Editing a Scheduled Task</a> for more information on adding a scheduled task.</p> <p> Scheduled tasks can be added for a single BenQ/non-BenQ device or a group of BenQ and/or non-BenQ devices.</p>
<b>Enable</b>	<p>Check the box for a scheduled task in this column to enable that task.</p> <p> Scheduled tasks which have an unchecked box are disabled and will be grayed out.</p>
<b>Date/Time*</b>	<p>Shows the day, time, and frequency for a given scheduled task.</p> <p> The format for the <b>Date/Time</b> entry is: [Time], [Frequency (in Weeks)], [Days/Date]. For example, "16:30, Every 3 Mon/Tue" means that the task is scheduled every three weeks on Mondays and Tuesdays at 4:30pm.</p>
<b>Target*</b>	Shows the device(s) that the scheduled task apply to.

Item	Description
<b>Action*</b>	 Shows the scheduled task. Scheduled tasks that are disabled will be grayed out. Scheduled tasks that have already been completed and have no remaining instances scheduled will be grayed and crossed out.
<b>Edit/Del</b>	Click the edit button (  ) to edit the scheduled task; click the delete button (  ) to delete the scheduled task.
*Click the header for this field to sort the list of scheduled tasks based on the field.	

## Creating/Editing a Scheduled Task

To create a scheduled task, follow the steps below:



The schedule tab is not available if the group includes both projectors and displays.

1. Select the device(s) you want the scheduled task to apply to in the device panel and then click the schedule tab.
2. Click the **Add** button in the schedule tab for the device.
3. Configure the following items in the **Add schedule task** menu:

**Add schedule task**

Target: Conference Room 1

Power On AM 10:00  
 Power Off AM 10:04

---

Frequency: Custom

Every 1 Week

S M T W T F S

Start date: 2018/09/03

- a. Check the box next to task you want the device to perform based on the set schedule.
- b. Set the time when you want the task to be performed.
- c. Set the frequency for the task. The available options are **Once** (Default), **Daily**, **Weekly**, **Monthly**, and **Custom**.
- d. If **Custom** is selected in the **Frequency** field, enter how frequently (in weeks) the task will occur and the days in which it will occur.

e. Enter the date when the scheduled task will begin.

4. Click the **Add** button in the **Add schedule task** menu to finish creating the scheduled task. By default the created task will automatically be enabled.

To edit a scheduled task, follow the steps below:

1. Select the device(s) you want to edit the scheduled task for in the device panel and then click the schedule tab.
2. Click the edit button () for the scheduled task you want to edit in the schedule tab for the device.
3. Edit the items in the **Edit schedule task** menu based on the descriptions in step 3 above.
4. Click the **Save** button in the **Edit schedule task** menu to finish editing the scheduled task. The edited task will retain the enabled/disabled setting from before it was edited.

Because most devices do not have built-in date/time record-keeping capabilities, DMS Local must remain open once a scheduled task is created to ensure that the task is executed.

## The App List Tab

For certain devices with compatible Android operating systems, the Action Panel features an app list tab that allows you to view the apps installed on your devices, edit the name and description of the installed apps, install and/or uninstall apps on your device, and update the device's Android operating system.

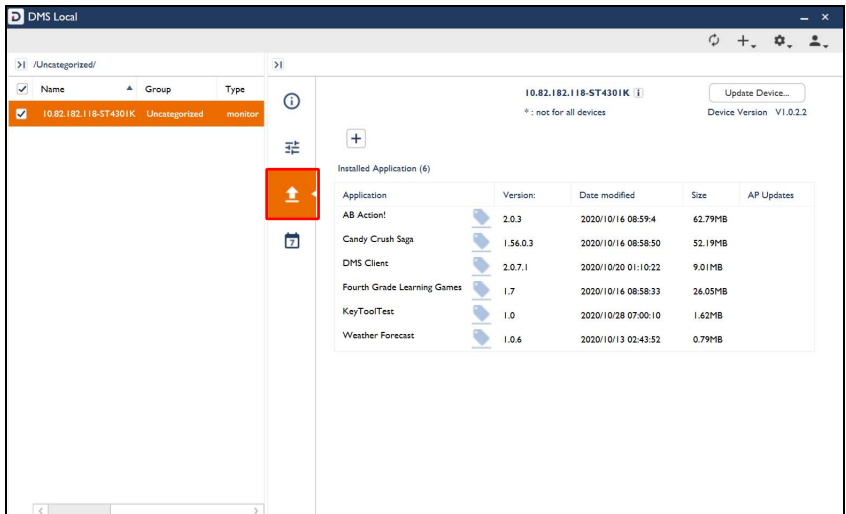

Support for the app list function depends on the version of the Android OS installed on your device. Not all devices with the Android OS will support the app list function.

## Viewing Installed Apps

After selecting the app list button (  ) in the Action Panel, the app list menu will appear displaying a list of the apps installed on your device as well as information such as version number, date modified, and file size for each app.

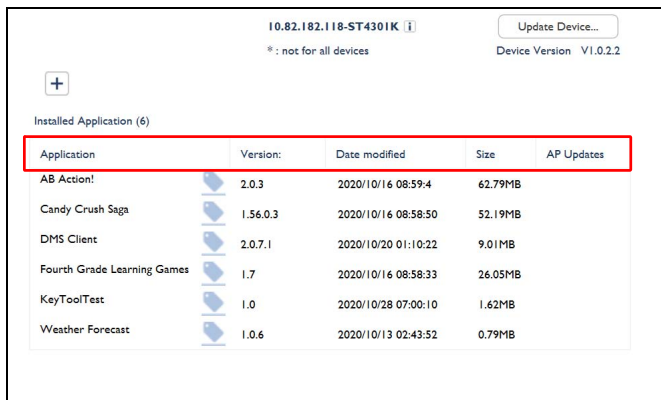







To view a detailed description for each app, select the tag button (  ) to the right of the app name.

10.82.182.118-ST4301K 1 Update Device...

\*: not for all devices Device Version V1.0.2.2

+

Installed Application (6)

Application	Version:	Date modified	Size	AP Updates
AB Action!	2.0.3	2020/10/16 08:59:4	62.79MB	
Candy Crush Saga	1.56.0.3	2020/10/16 08:58:50	52.19MB	
DMS Client	2.0.7.1	2020/10/20 01:10:22	9.01MB	
Fourth Grade Learning Games	1.7	2020/10/16 08:58:33	26.05MB	
KeyToolTest	1.0	2020/10/28 07:00:10	1.62MB	
Weather Forecast	1.0.6	2020/10/13 02:43:52	0.79MB	

Once selected, a window will pop up showing the app's description.

Edit

APP Name 2048

Description To create a tile with 2048.

Version: 3.16.36 (136)

Close



## Editing an App Name and Description

To edit the name and description for an app listed in the app list menu:

1. Select one of the following options:
  - Right-click on an app in the app list and then select **Edit Application Info**.

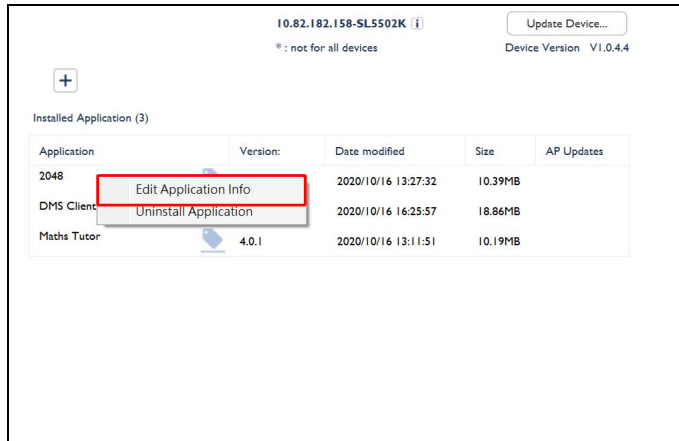

- In the application details window select **Edit**.

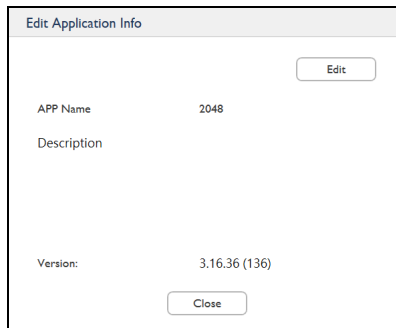

2. In the resulting **Edit Application Info** window enter an app name in the **APP Name** field and/or a description in the **Description** field, and then select **Save**.

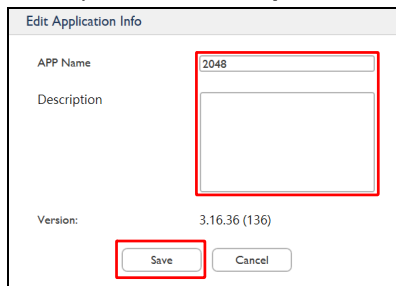

## Installing an App

The app list tab allows you to install apps onto your devices via DMS Local using an APK installation file stored locally.



- Apps can only be installed via an APK installation file. The app list function does not support directly installing apps from Google Play Store.
- Support for the app depends on the compatibility of the app with the version of Android OS installed on your device.

To install an APK app installation file:

1. Select the install button ( **+** ) in the app list.

Application	Version:	Date modified	Size	AP Updates
AB Action!	2.0.3	2020/10/16 08:59:4	62.79MB	
Candy Crush Saga	1.56.0.3	2020/10/16 08:58:50	52.19MB	
DMS Client	2.0.7.1	2020/10/20 01:10:22	9.01MB	
Fourth Grade Learning Games	1.7	2020/10/16 08:58:33	26.05MB	
KeyToolTest	1.0	2020/10/28 07:00:10	1.62MB	

2. Navigate to the location of the APK file located on your computer and select the file. The installation process will begin.
3. Once the installation has successfully finished, the newly installed app will appear in the app list for the device.

Application	Version:	Date modified	Size	AP Updates
AB Action!	2.0.3	2020/10/16 08:59:4	62.79MB	
Candy Crush Saga	1.56.0.3	2020/10/16 08:58:50	52.19MB	
DMS Client	2.0.7.1	2020/10/20 01:10:22	9.01MB	
Fourth Grade Learning Games	1.7	2020/10/16 08:58:33	26.05MB	
KeyToolTest	1.0	2020/10/28 07:00:10	1.62MB	
Weather Forecast	1.0.6	2020/10/13 02:43:52	0.79MB	

If the installed app does not appear shortly after the installation process is complete, select the refresh button (  ) in the DMS Local toolbar.

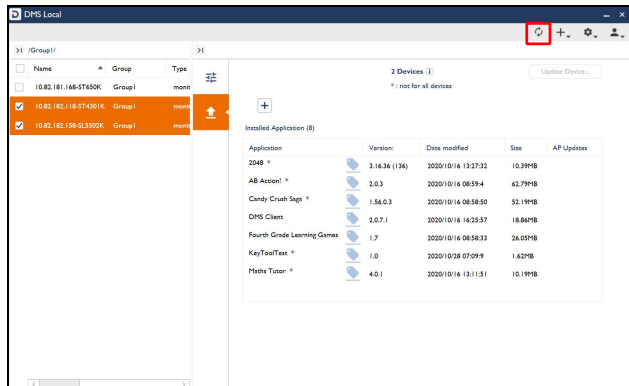

If the app in question does not appear in the app list even after refreshing DMS Local, there may be support issues for the app that resulted in a failed installation process. Support for the app depends on the compatibility of the app with the version of Android OS installed on your device.

## Uninstalling an App

To uninstall an app in the app list, right-click on the app you want to uninstall and then select **Uninstall Application**.

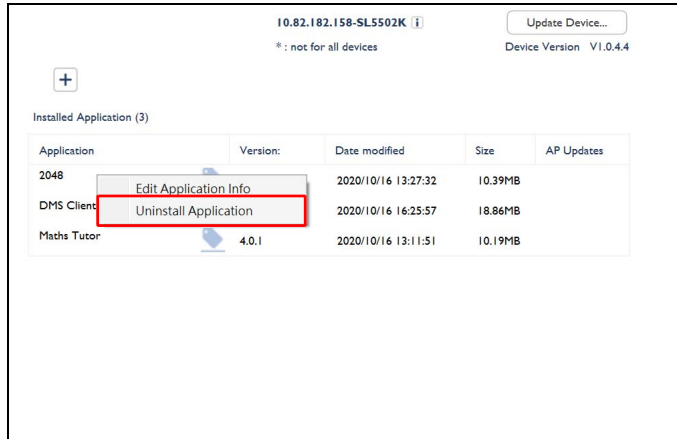

## Updating the Android Operating System on your Device

The app list tab also allows you to update the Android operating system installed on your device via DMS Local using a locally stored installation file.

To update the operating system on your device:

1. Select **Update Device...** in the app list screen.

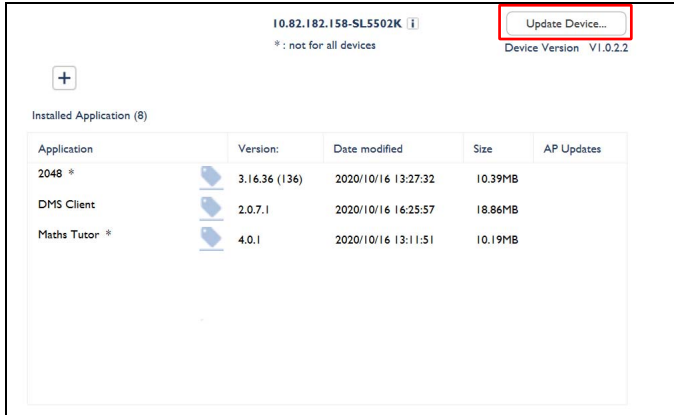

2. Navigate to the location of the update file located on your computer and select the file. The update process will begin.

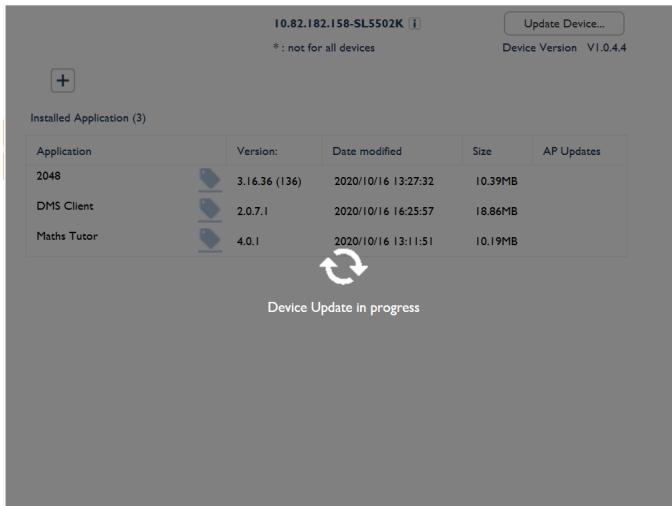

The entire process will take some time, during this time you will not be able to use any other DMS Local functions. Once the update is finished your device will restart.



If the update file is corrupt or an error occurs during the update process, a **Device Update Failed** message will appear. Check with the manufacturer of your device for more information regarding the update file and its compatibility with your device.

## Setting a Login Password for DMS Local

To ensure that access to DMS Local is secure and only for designated personnel, you can set a login password for DMS Local that needs to be entered every time DMS Local is launched. To set a login password for DMS Local, follow the steps below:

1. Click the user button (  ) in the DMS Local main page and select **Change password**.

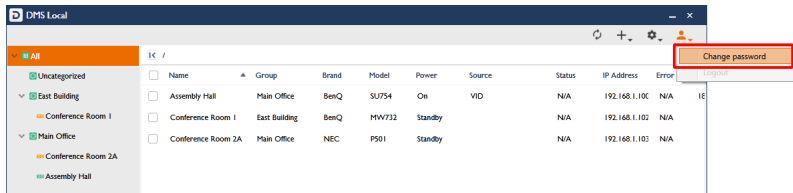

2. In the **Change password** menu enter the password you want to set as the login password in both the **New password** and **Confirm password** fields. If DMS Local already features a login password, enter the current password in the **Current password** field.

Change password

Account ID    User

Current password

New password

Confirm password



If you want to remove the existing password, click the **Remove Password** button in the **Change password** menu.

3. Click **Save** to finish setting a login password for DMS Local.



If you forget your login password for DMS Local, click the **Forget password?** link at the bottom of the login window and contact your local BenQ service team to provide them with the password retrieval code shown in the **Forget password?** prompt.

## Other Functions

DMS Local also allows you to do the following functions to further help you manage your devices:

- Generate error report (for projectors only)
- Export device listings to the cloud
- Update your projector's firmware over the network
- Use a virtual keypad
- Receive error notifications over e-mail
- Backup DMS Local's device listings
- Transfer device listings to DMS Cloud via Agent Mode

## Generating an Error Report (For Projectors Only)

To generate an error report in DMS Local which lists past errors along with information for the projectors that the error(s) occurred on, follow the steps below:



Projectors that do not support sending error messages via the network do not support generating error reports.

1. Click the settings button (⚙️) in the DMS Local main page and select **Error Report**.

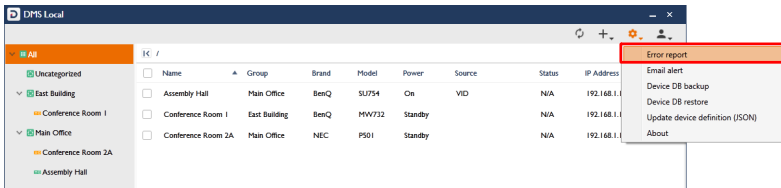

2. If you want to export the error report to a saveable file format, click the **Export** in the **Error Report** pop-up window.

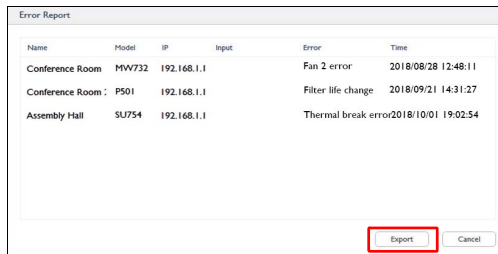

- Error reports will only feature projectors whose error status in the projector panel feature error icons. Projectors whose error status in the projector panel feature no message or an "N/A" message will not be included in error reports.
- The error report will only list the errors that have occurred since the previous error report was generated.

## Exporting Device Listings

To export the list of devices and groups from the DMS Local device tree to the DMS Cloud server so that users of DMS Cloud can import the list of devices directly from the cloud, click the settings button (⚙️) in the DMS Local main page and select **Export for DMS Cloud (CSV)**.

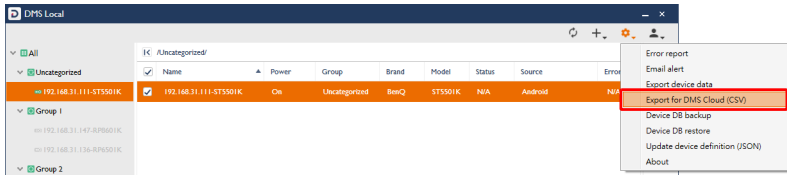

## Updating Firmware (For Projectors Only)

To update the firmware on a projector in DMS Local, follow the steps below:

- This function is only available to BenQ projectors that support firmware update over the network.
- This function requires that the network that your projector is connected to has access to the Internet.
- To update the system firmware for devices running the Android operating system, see [Updating the Android Operating System on your Device](#).

1. Select the projector in the projector panel whose firmware you want to update, and then click the information tab.
2. In the information tab for the projector, click the firmware upgrade button (🔧). The BenQ Easy Firmware Updater window will appear.

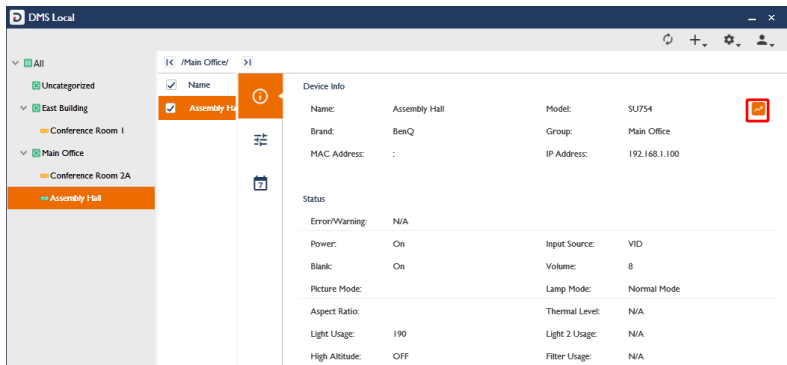

- From the BenQ Easy Firmware Updater window you will be able to update any projector connected to network DMS Local is connected to.

3. Refer to the BenQ Easy Firmware Updater user manual to proceed with the firmware update.

- Contact your BenQ Local Service Center for information on where to download the BenQ Easy Firmware Updater user manual.

## Virtual Keypad (For Projectors Only)

When the virtual keypad button is clicked in the control tab of a BenQ projector, the following digitized version of the hardware keys common to most BenQ projectors will appear.

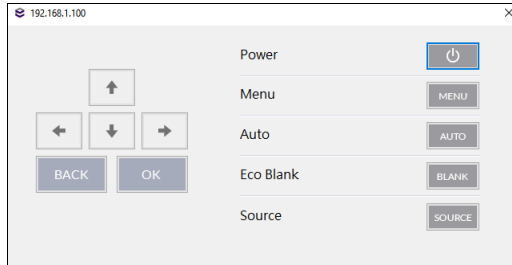

Button	Description
Arrow buttons	Selects or toggles OSD menu items.
<b>Back</b>	Goes to the previous OSD menu.
<b>OK</b>	Confirms the selected OSD menu item.
<b>Power</b>	Powers on the projector or puts it in standby mode.
<b>Menu</b>	Turns on/off the On-Screen Display (OSD) menu.
<b>Auto</b>	Automatically determines the best picture timings for the image shown.
<b>Eco Blank</b>	Makes the projector show a blank screen.
<b>Source</b>	Shows the source selection bar.



## Error Notifications via E-mail (For Projectors Only)

The settings button (⚙️) on the DMS Local main page features a function that allows DMS Local to automatically send e-mail alerts to designated e-mail addresses anytime a specified error has occurred on any of your projectors. The e-mail alert will include the projector's name (the name for the projector in the device tree), model, IP address, input source along with the type of error that occurred, and a timestamp for the error.

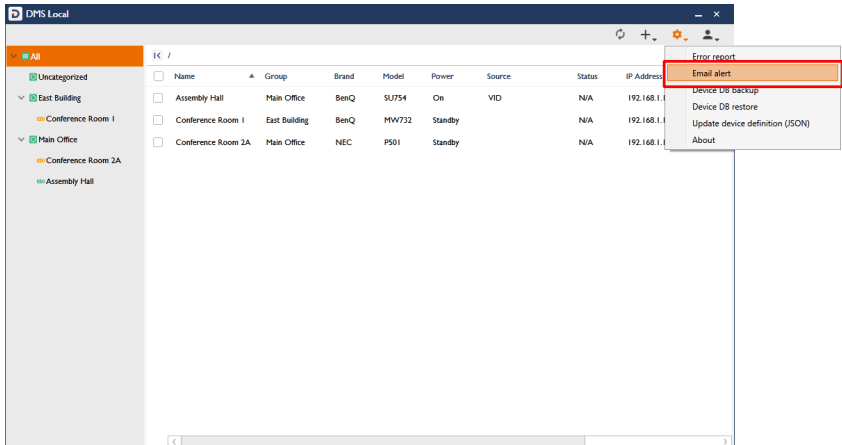

Projectors that do not support sending error messages via the network do not support error notifications via e-mail.

## Creating an E-mail Alert

To create an E-mail alert, follow the steps below:

1. Click the settings button (⚙️) in the DMS Local main page and select **Email alert**.
2. Configure the following items in the **Event receiver** tab of the **Email alert settings** menu:

The screenshot shows the 'Email alert settings' dialog box with the 'Event receiver' tab selected. The 'Notification event' section has four checkboxes: 'System Error', 'Lamp Error', 'Fan Error', and 'Temperature Error'. The 'Email receivers' section has a text input field containing 'itg@benq.com' and a '+' button. Red boxes and letters 'a' and 'b' highlight the checkboxes and the input field respectively.

Event receiver | Email setting

On selected events, notification emails will be sent to receivers  
(Please make sure Email settings are also correctly configured.)

Notification event | Email receivers

System Error  
 Lamp Error  
 Fan Error  
 Temperature Error

itg@benq.com +

Save | Cancel

- a. Check the box next to the type of error you want an e-mail alert sent out for (multiple error types can be checked).
  - b. Enter the e-mail address you want the alert to be sent to and then click the + button (multiple addresses can be entered).
3. Click the **Email setting** tab and then configure the following items:

The screenshot shows the 'Email alert settings' dialog box. The 'Email setting' tab is selected. The dialog contains the following fields and controls:

- Event receiver:** Email setting (highlighted with a red box)
- Configure the outbound and email settings. Email alerts will be sent out from this mail address.**
- Reset** button and **Test** button (circled in red).
- Email server presents:** Gmail (Secure Login, recommended) (circled in red with 'a')
- Outgoing Email address:** it.administrator@gmail.com (circled in red with 'b')
- SMTP server:** smtp.gmail.com (circled in red with 'c')
- SMTP port:** 587 (circled in red with 'c')
- Timeout (second):** 30 (circled in red with 'c')
- SMTP server requires authentication**
- Username:** ITADMIN (circled in red with 'd')
- Password:** [masked] (circled in red with 'd')
- Use an encrypted connection (SSL/TLS)**
- Save** and **Cancel** buttons.

- a. Select the type of e-mail service that the e-mail alert will be using to send the alert. The available options are **Gmail**, **Yahoo**, **Outlook**, **QQ**, and **Custom**.
  - b. Enter the e-mail address that the e-mail alert will be sent from.
  - c. If **Custom** is selected in the **Email server presents** field, enter the server, port, and time-out settings. Consult your IT administrator if you are unsure of these settings.
  - d. Enter the **Username** and **Password** for the e-mail account used in the **Outgoing Email address** field.
  - e. Click the **Test** button if you want to send out a test e-mail alert to ensure that all the configurations are correct. The test e-mail alert will be sent to the e-mail address entered in the **Event receiver** tab.
4. Click **Save** to finish creating the e-mail alert.



Individual e-mail alerts will be sent out for each projector that an error occurs on. For example, if a fan error occurs on two separate projectors, two separate e-mail alerts will be sent out.

An example of an e-mail alert for a thermal sensor error is shown below:

From: DMS Local send a mail to you! <ooo@ooo.com>

To: xxx@xxx.com

Subject: [BenQ DMS Local] From "192.168.1.4-MH733": "Thermal Sensor 1 open error"  
ERROR

Content:

This message is generated automatically by "192.168.1.4-MH733", see below information:

Name: 192.168.1.4-projector  
 Model: MH733  
 IP: 192.168.1.4  
 Input: HDMI-1  
 Error: Thermal Sensor 1 open error  
 Time: 2018/08/28 14:49:23

## Backing Up Device Listings

To backup the list of devices and groups from the DMS Local device tree and their relevant data for data backup purposes or to transfer the list to another computer, follow the steps below:

1. Click the settings button (⚙️) in the DMS Local main page and select **Device DB backup**.

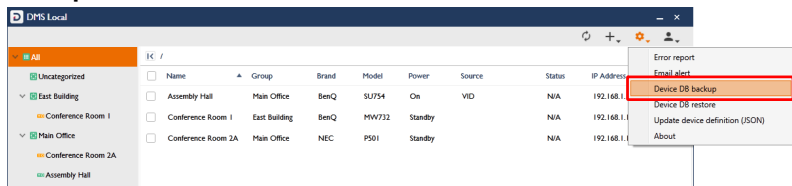

2. Navigate to the folder you want to save the backup to in the pop-up window.



The backup file only saves the device tree and group settings for the devices; it will not save any command controls or scheduled tasks.

To restore the backup file or load the backup file on a new computer, follow the steps below:

1. Click the settings button (⚙️) in the DMS Local main page and select **Device DB restore**.

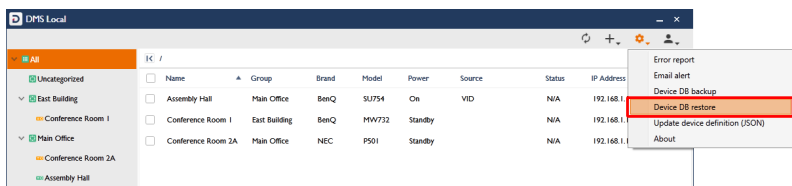

2. Navigate the location where the backup file is located to in the pop-up window.

## Transferring Device Listings to DMS Cloud via Agent Mode

The Agent Mode function in DMS Local allows you to create a pairing code and QR code for your list of devices which can then be entered (for the pairing code) into DMS Cloud or scanned (for the QR code) via the BenQ DMS Tool app to quickly add those same devices into your DMS Cloud device list.

To transfer device listings to DMS Cloud via Agent Mode via a pairing code:

1. Click the settings button (⚙️) in the DMS Local main page and select **Switch to Agent Mode**.

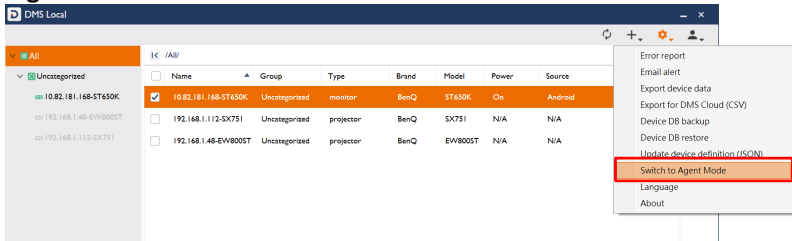

2. A caution will pop up indicating that after switching to Agent Mode, control of your devices will switch from DMS Local to DMS Cloud. Select **Continue**.

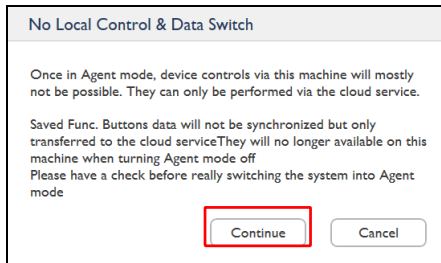

3. Select **Consent & Start Agent Mode** in the data protection consent decree that pops up.

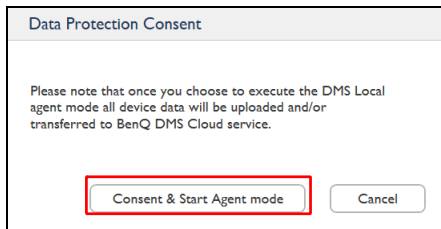

- A window listing information for your DMS Local device and the **Temporary Pairing Code** you will use to transfer your device list to DMS Cloud will appear. Take note of the **Temporary Pairing Code** for use later in this process.



- The **Temporary Pairing Code** will reset after a few minutes of inactivity. Always use the most current **Temporary Pairing Code** when completing this process in DMS Cloud.
- The QR code shown in the Agent Mode window can also be used to transfer your device listings in the BenQ DMS Tool app. For instructions on how to use the QR code, see [Transferring Device Listings to DMS Cloud via the BenQ DMS Tool app](#).

- Log in to DMS Cloud using the login which you want to add the device list to.
- In the DMS Cloud main page select the add button (+) and select **Add Device**.

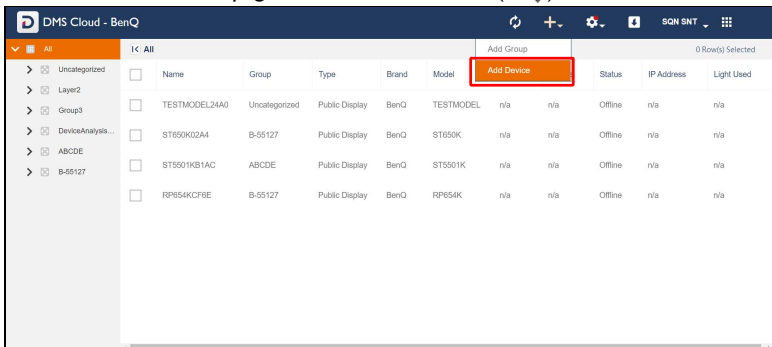

- In the **Add new device** prompt select **Add via Unique ID** and then select **Next**.

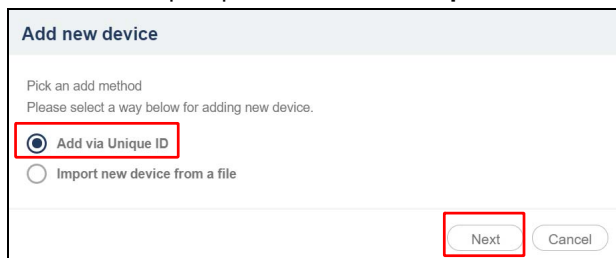

- Enter the **Temporary Pairing Code** into the pop up window that appears and then select **Search**. DMS Cloud will begin searching for the device list that matches the pairing code entered.

**Enter Unique ID**

Please enter the Unique ID for searching.

\*It can be found on the device (via DMS Client application)



The **Temporary Pairing Code** resets after a few minutes of inactivity. Always use the most current **Temporary Pairing Code** when completing this process in DMS Cloud.

- After DMS Cloud is finished searching, the list of devices from your DMS Local account will appear. In the devices list you can choose from the following options:

**Add new device (Local agent)** Total found: 3 | Valid: 3

Selected device(s) to be added  
Checked device(s) will be added. Modify Name/Description fields if needed.

Local agent name: B-54802

	Unique ID ▲	Model Name	Name <b>b</b>	Description <b>c</b>
<input checked="" type="checkbox"/>	MDA6MTg6MjM6NTA6R Dl6N0l=	SX751	SX751D27B	
<input checked="" type="checkbox"/>	QjA6QzU6Q0E8NzA6MD l6QTQ=	ST650K	ST650K02A4	
<input checked="" type="checkbox"/>	UEQxMUowMDAxMTlw MA==	EW800ST	EW800ST1200	

- Check the box next to the device(s) you want to add or check the select all box to select all the devices on the list.
- Enter a name for the device in the **Name** field. If you do not enter a name in the field, the default name for the device (the device's full model name) will be used.
- Enter a description for the display in the **Description** field to provide more detailed information about the device to be viewed in the Information Tab.



The **Name** and **Description** used in DMS Local will not be carried over to DMS Cloud.

- Once you have finished with the options described above, click **Add** to add the selected devices.

**Add new device (Local agent)** Total found: 3 | Valid: 3

Selected device(s) to be added  
Checked device(s) will be added. Modify Name/Description fields if needed.  
Local agent name: B-54802

<input checked="" type="checkbox"/>	Unique ID ▲	Model Name	Name	Description
<input checked="" type="checkbox"/>	MDA6MTg6MjM6NTA6RDI6NDI=	SX751	<input type="text" value="SX751D27B"/>	<input type="text"/>
<input checked="" type="checkbox"/>	QjA6QzU6Q0E6NzA6MDI6QTQ=	ST650K	<input type="text" value="ST650K02A4"/>	<input type="text"/>
<input checked="" type="checkbox"/>	UEQxMUowMDAxMTIwMA==	EW800ST	<input type="text" value="EW800ST1200"/>	<input type="text"/>

- Once you have finished adding the devices, a success message will appear, select **Yes** to continue transferring device lists or **No** to finish the process.

**Success / Add More**

ST650K02A4, EW800ST1200, SX751D27B has been added successfully.  
Would you like to add another device via Unique ID?

## Transferring Device Listings to DMS Cloud via the BenQ DMS Tool app

You can also use the BenQ DMS Tool mobile app to transfer your device lists from DMS Local to DMS Cloud. To transfer the device lists via the BenQ DMS Tool app:

- Search the iOS App Store or Google Play Store for “BenQ DMS Tool” and then install the app on your mobile device.
- Log into the BenQ DMS Tool app using your DMS Cloud login.

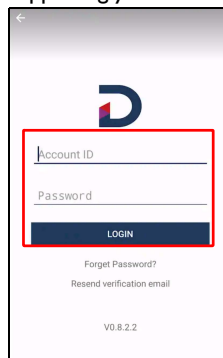

The image shows the login screen of the BenQ DMS Tool app. It features a large 'D' logo at the top. Below the logo are two input fields: 'Account ID' and 'Password', both highlighted with a red rectangular box. Underneath these fields is a dark blue 'LOGIN' button. At the bottom of the screen, there are links for 'Forget Password?' and 'Resend verification email', and the version number 'V0.8.2.2' is displayed at the very bottom.

- Enter Agent Mode on the device running DMS Local by completing steps 1 to 4 in the [Transferring Device Listings to DMS Cloud via Agent Mode](#) section.

4. On the mobile device running the BenQ DMS Tool app scan the QR code shown in the Agent Mode menu on DMS Local.

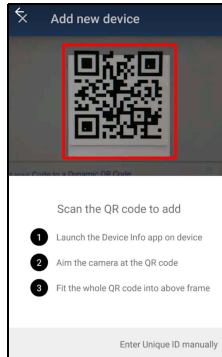

5. Once finished, the device list will be transferred to your DMS Cloud device.



# About DMS Local

For more information regarding DMS Local including software version, click the settings button (⚙️) in the DMS Local main page and select **About**.

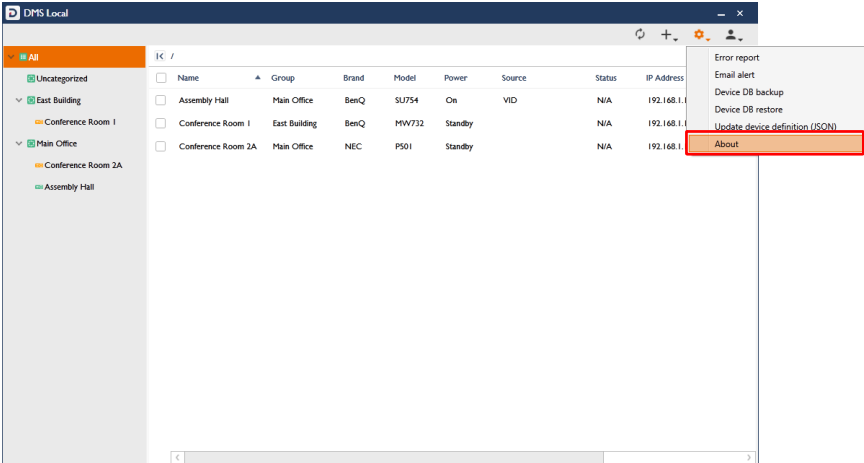

## Troubleshooting

If you encounter problems while using the DMS Local, please refer to the following troubleshooting tips to try to solve the problems by yourself. If the problem persists, please contact BenQ Customer Support for help.

Problem	Solution
Cannot connect to the device(s)	Check the following: <ul style="list-style-type: none"> <li>• Check the cable connection. Is the device correctly connected to the network?</li> <li>• Is the device turned on?</li> <li>• Is the device network setting correct?</li> </ul>
Cannot power on the device via DMS Local	<ul style="list-style-type: none"> <li>• Ensure that <b>WOL (Wake-on-LAN) Settings</b> is enabled on the device.</li> <li>• Ensure that the device is connected to the network via the LAN (RJ-45). Wake-on-LAN does not work over a Wi-Fi connection.</li> </ul>
Cannot add a device into DMS Local	<ul style="list-style-type: none"> <li>• Check if the device supports LAN control.</li> <li>• Update the database of devices (JSON) in DMS Local.</li> </ul>

---

## Appendix: About DMS Cloud

BenQ's cloud-based device management software, DMS Cloud, is also available for management of remote displays. For more information on DMS Cloud and its features see the links below:

- DMS Cloud and its functions  
<https://youtu.be/0jyzb8yqNlk>
- Adding devices using QR code  
[https://youtu.be/uQ\\_WsojPvQc](https://youtu.be/uQ_WsojPvQc)
- Adding devices using unique IDs  
<https://youtu.be/aHHtCbGiIH0>