

Full HD Widescreen LED Monitor

Full HD-Breitbild-LED-Monitor

Moniteur LED Full HD à écran large

Monitor LED Full HD de con pantalla panorámica

Monitor LED Full HD a schermo largo

L238V0

L270V0



PACKAGE INCLUDES

Package Includes

Im Lieferumfang Enthalten

Le paquet contient

El paquete incluye

La confezione contiene

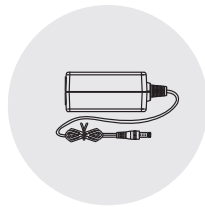
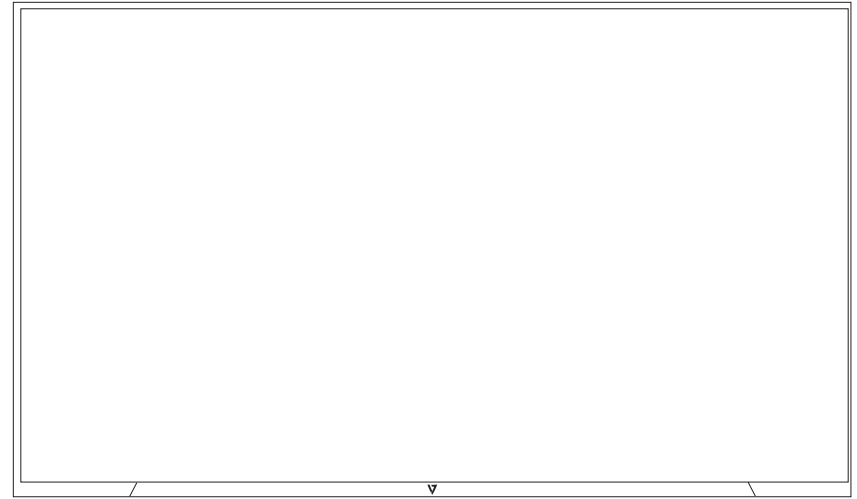

Power Adapter

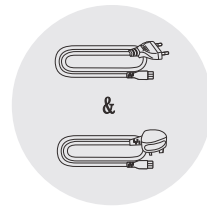

Power Cord

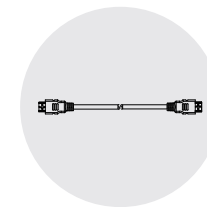

HDMI Cable

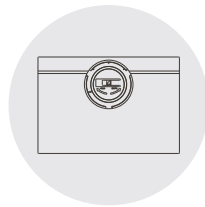

Base

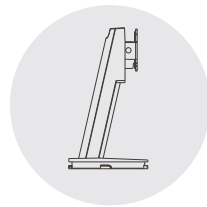

Supporting Column

GETTING STARTED

1. Supporting Column

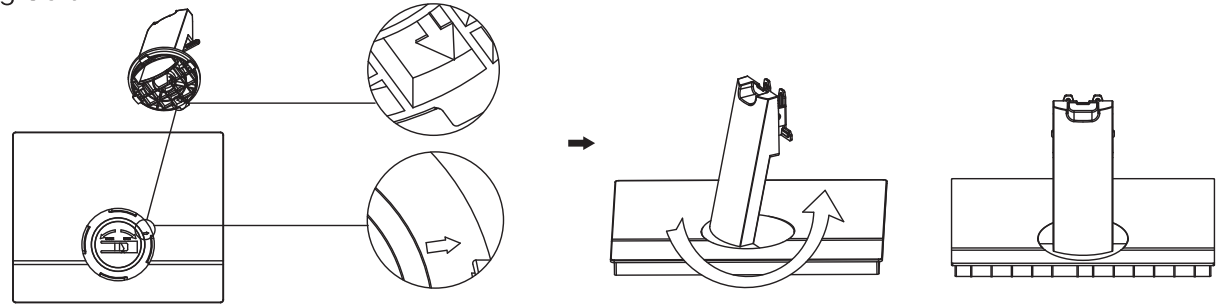

2.

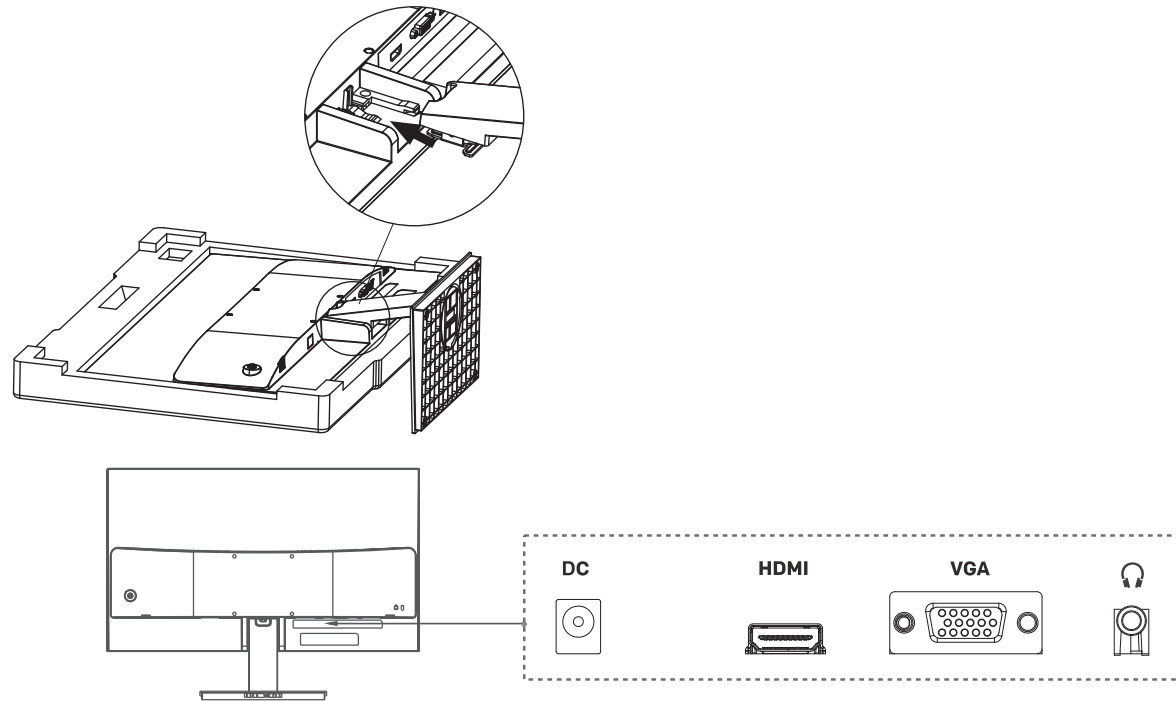



Control Button

Bouton de commande

Botón de control

Pulsante di controllo

Steuerungstaste

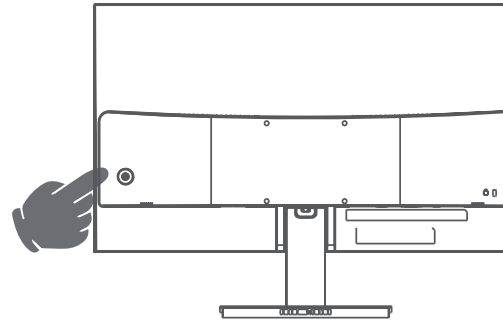

Up	With main menu, move the cursor up to select the submenu or item. Without main menu, call out the pop-up window of brightness settings.
Down	With main menu, move the cursor down to select the submenu or item. Without main menu, call out the pop-up window of brightness settings.
Left	With main menu, return back to the upper-level menu. Without main menu, access the main menu settings.
Right	With main menu, enter the selected submenu or item. Without main menu, access the main menu settings.
Middle	In standby mode, short press middle to turn on the monitor. In working status, long press middle to turn the monitor into standby mode. With main menu in working status, short press middle to confirm or enter the selected submenu or item. Without main menu in working status, short press middle to access main menu settings.

Su	Con il menu principale, spostare il cursore verso l'alto per selezionare il sottomenu o la voce. Senza il menu principale, richiamare la finestra pop-up delle impostazioni di luminosità.
In basso	Con il menu principale, spostare il cursore verso il basso per selezionare il sottomenu o la voce. Senza menu principale, richiamare la finestra pop-up delle impostazioni di luminosità.
Sinistra	Con il menu principale, tornare al menu di livello superiore. Senza menu principale, accedere alle impostazioni del menu principale.
destra	Con il menu principale, accedere al sottomenu o alla voce selezionata. Senza menu principale, accedere alle impostazioni del menu principale.
Centro	In modalità standby, premere brevemente il tasto centrale per accendere il monitor. In stato di lavoro, premere a lungo il tasto centrale per portare il monitor in modalità standby. Con il menu principale in stato di funzionamento, premere brevemente il tasto centrale per confermare o accedere al sottomenu o alla voce selezionata. Senza il menu principale in stato di funzionamento, premere brevemente il tasto centrale per accedere alle impostazioni del menu principale.

Vers le haut	Avec le menu principal, déplacez le curseur vers le haut pour sélectionner le sous-menu ou l'élément. Sans le menu principal, appelez la fenêtre contextuelle des réglages de luminosité.
Vers le bas	Avec le menu principal, déplacez le curseur vers le bas pour sélectionner le sous-menu ou l'élément. Sans le menu principal, appelez la fenêtre contextuelle des réglages de luminosité.
Gauche	Avec le menu principal, revenir au menu supérieur. Sans le menu principal, accéder aux réglages du menu princ
Droite	Avec le menu principal, accéder au sous-menu ou à l'élément sélectionné. Sans le menu principal, accéder aux réglages du menu principal.
Milieu	En mode veille, appuyez brièvement sur le milieu pour allumer le moniteur. En mode travail, appuyez longuement sur le milieu pour mettre le moniteur en mode veille. Avec le menu principal en état de fonctionnement, appuyez brièvement sur le milieu pour confirmer ou entrer dans le sous-menu ou l'élément sélectionné. Sans le menu principal en état de fonctionnement, appuyez brièvement sur le milieu pour accéder aux paramètres du menu principal.



Control Button

Bouton de commande

Botón de control

Pulsante di controllo

Steuerungstaste

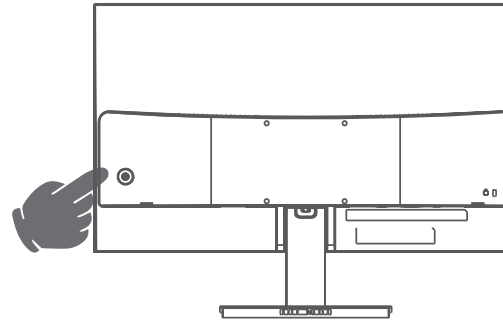

Arriba	Con el menú principal, mueva el cursor hacia arriba para seleccionar el submenú o la opción.
Abajo	Con el menú principal, mueva el cursor hacia abajo para seleccionar el submenú o la opción correspondiente.
Izquierda	Con el menú principal, vuelva al menú superior.Sin el menú principal, acceda a los ajustes del menú principal.
Derecha	Con el menú principal, acceda al submenú o elemento seleccionado.Sin el menú principal, acceda a los ajustes del menú principal
Centro	En modo de espera, realice una pulsación corta en el centro para encender el monitor.En estado de trabajo, realice una pulsación larga en el centro para poner el monitor en modo de espera. Con el menú principal en estado de funcionamiento, pulse brevemente el centro para confirmar o entrar en el submenú o elemento seleccionado.

Oben	Im Hauptmenü bewegen Sie den Cursor nach oben, um das Untermenü oder den Punkt auszuwählen, ohne Hauptmenü rufen Sie das Pop-up-Fenster für die Helligkeitseinstellungen auf.
Ab	Mit dem Hauptmenü bewegen Sie den Cursor nach unten, um das Untermenü oder den Punkt auszuwählen.ohne Hauptmenü rufen Sie das Pop-up-Fenster der Helligkeitseinstellung
Links	Mit dem Hauptmenü kehren Sie zum übergeordneten Menü zurück.ohne Hauptmenü rufen Sie die Einstellungen des Hauptmenüs auf.
Rechts	Mit dem Hauptmenü das ausgewählte Untermenü oder Element aufrufen.ohne Hauptmenü die Einstellungen des Hauptmenüs aufrufen.
Mitte	Im Standby-Modus drücken Sie kurz auf die mittlere Taste, um den Monitor einzuschalten.Im Arbeitsmodus drücken Sie lange auf die mittlere Taste, um den Monitor in den Standby-Modus zu versetzen. Wenn sich das Hauptmenü im Arbeitsmodus befindet, drücken Sie kurz auf die mittlere Taste, um das ausgewählte Untermenü oder Element zu bestätigen oder aufzurufen.Wenn sich das Hauptmenü nicht im Arbeitsmodus befindet, drücken Sie kurz auf die mittlere Taste, um die Einstellungen des Hauptmenüs aufzurufen.

ON-SCREEN DISPLAY

Display

Afficer | Anzeige | Mostrar | Display

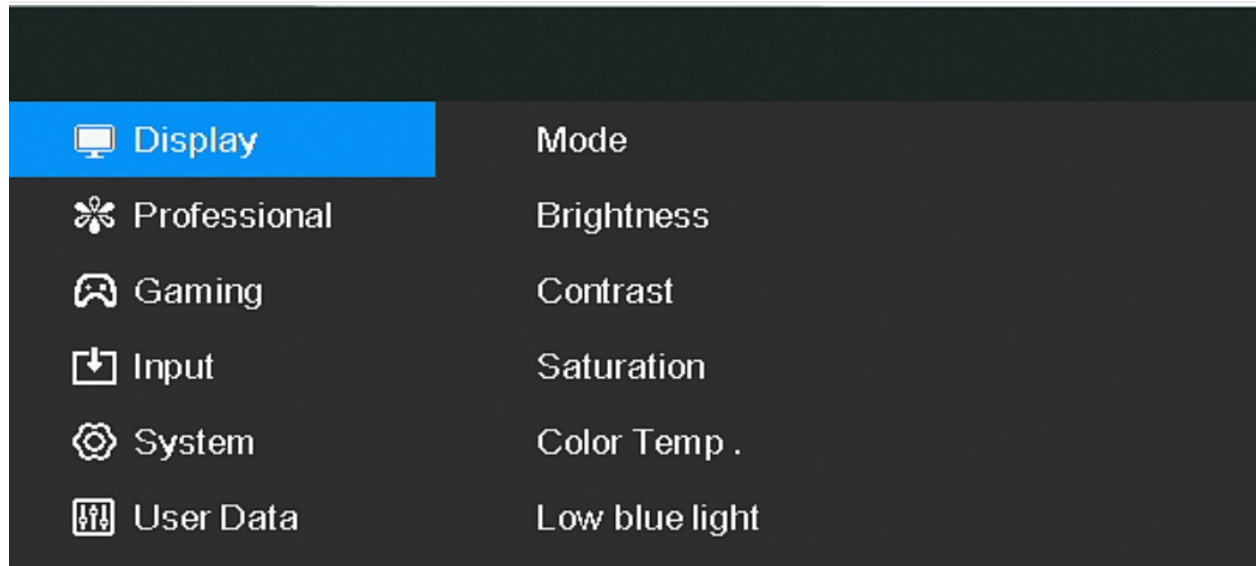

Professional

Professionnel | Professionell | Profesional | Professionale

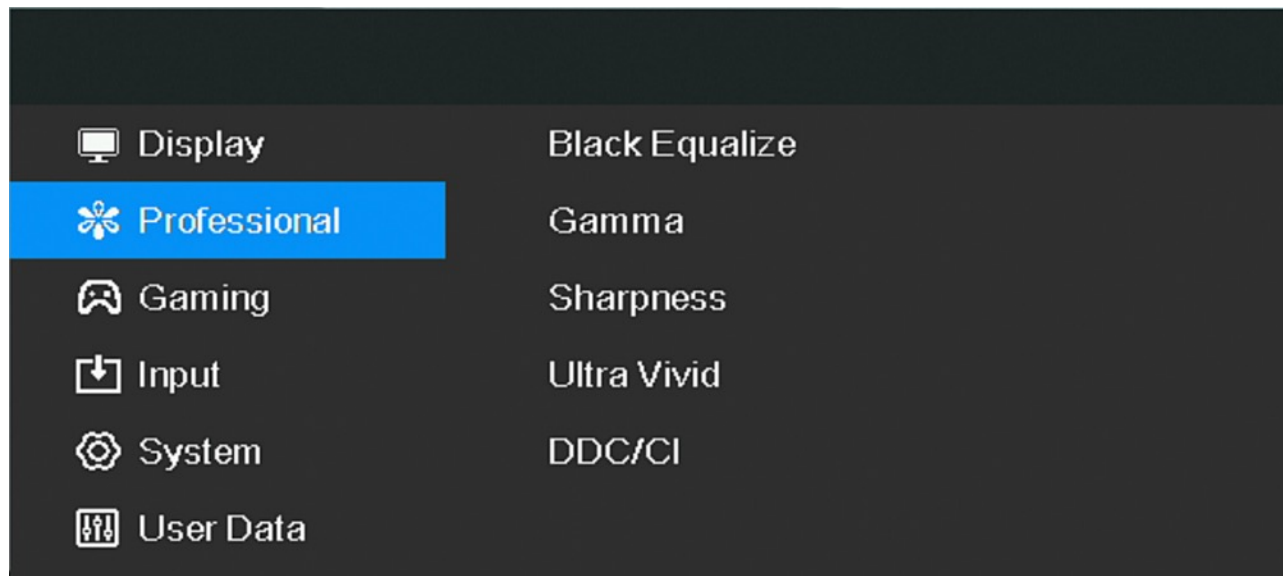

ON-SCREEN DISPLAY

Gaming

Jeux | Spielen | Juegos | Gioco

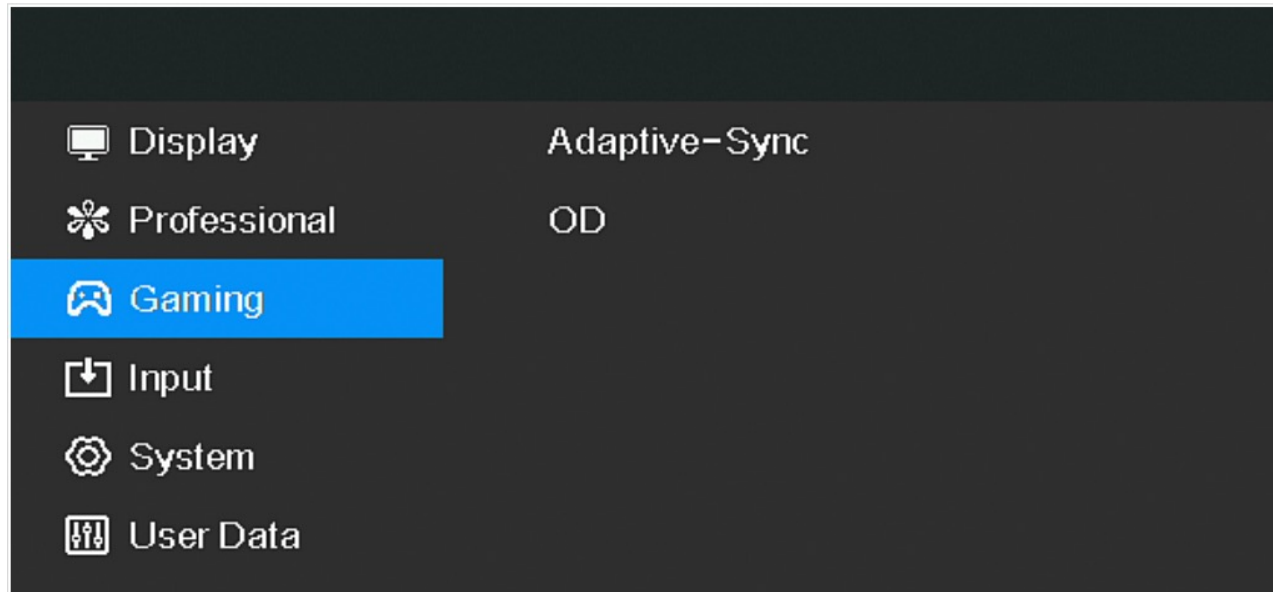

Input

Entrée | Eingabe | Entrada | Ingresso

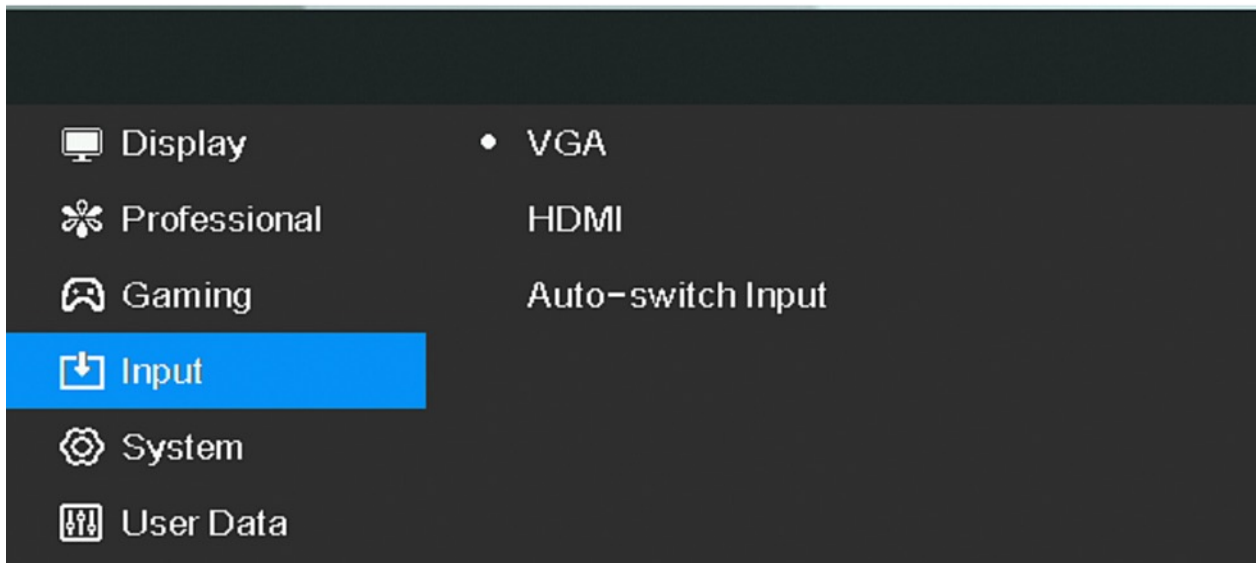

ON-SCREEN DISPLAY

System

Système | System | Sistema | Sistema

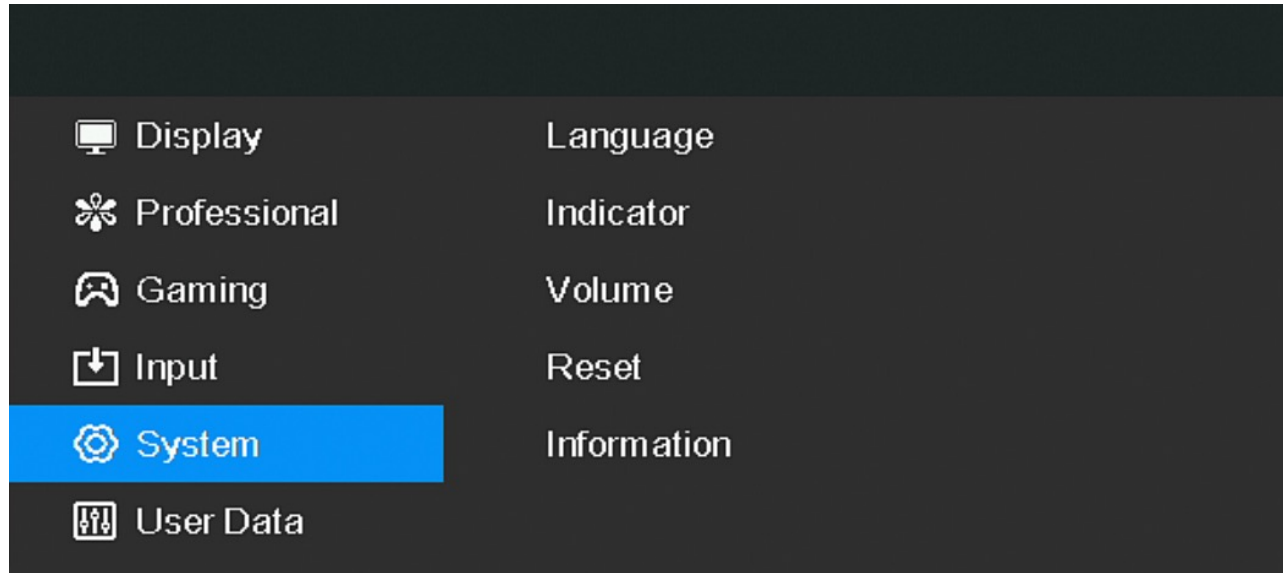

User Data

Données utilisateur | Benutzerdaten | Datos del usuario | Dati utente

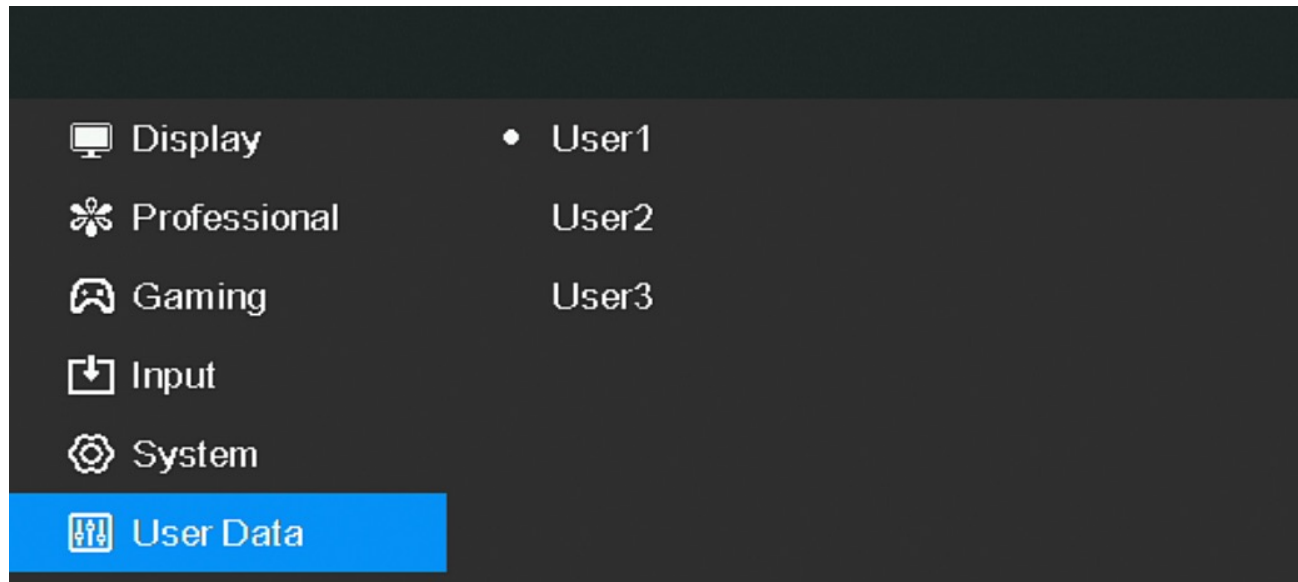

General	Allgemein	Général	General	Generale	
Model	Modell	Modèle	Modelo	Modello	L238V0
Product Dimensions	Produkt Abmessungen	Dimensions du produit	Dimensiones del producto	Dimensioni del prodotto	54.2 x 15.1 x 40.2 cm (21.34 x 5.94 x 15.83 in)
Product Weight	Produktgewicht	Poids du produit	Peso del producto	Peso del prodotto	2.6 kg (5.73 lbs)
Package Dimensions	Abmessungen der Verpackung	Dimensions de l'emballage	Dimensiones del embalaje	Dimensioni dell'imballaggio	59 x 9.5x 41.6 cm (23.23 x 3.74 x 16.38 in)
Package Weight	Gewicht der Verpackung	Poids de l'emballage	Peso del embalaje	Peso dell'imballaggio	3.5 kg (7.72 lbs)
Technical	Technisch	Technique	Técnico	Technique	
Panel Size	Panel-Größe	Taille du panneau	Tamaño del panel	Dimensione del pannello	23.8 Inches
Maximum Resolution	Maximale Auflösung	Résolution maximale	Resolución máxima	Risoluzione massima	1920 x 1080p
Image Quality	Bildqualität	Qualité de l'image	Calidad de imagen	Qualità dell'immagine	FHD
Panel Type	Panel-Typ	Type de panneau	Tipo de panel	Tipo di pannello	IPS
Input	Eingabe	Entrée	Entrada	Ingresso	HDMI 1.4, VGA, 3.5mm Audio
Brightness	Helligkeit	Luminosité	Brillo	Luminosità	250 cd/m ²
Refresh Rate	Bildwiederholrate	Taux de rafraîchissement	Frecuencia de actualización	Frequenza di aggiornamento	100Hz
Response Time	Reaktionszeit	Temps de réponse	Tiempo de respuesta	Tempo di risposta	5ms (OD)
Power Input	Leistungsaufnahme	Puissance d'entrée	Potencia de entrada	Potenza in ingresso	30W (12V 2.5A)
Aspect Ratio	Bildseitenverhältnis	Rapport d'aspect	Relación de aspecto	Rapporto d'aspetto	16:9
Contrast Ratio	Kontrastverhältnis	Rapport de contraste	Relación de contraste	Rapporto di contrasto	1000:1
Viewing Angle	Betrachtungswinkel	Angle de vision	Ángulo de visión	Angolo di visione	178°(H)/178°(V)
Screen Coating	Bildschirm-Beschichtung	Revêtement de l'écran	Revestimiento de la pantalla	Rivestimento dello schermo	Matte
VESA Mount	VESA-Halterung	Montage VESA	Montaje VESA	Montaggio VESA	100 x 100
Stand Dimension	Abmessungen des Standfußes	Dimension du support	Dimensiones del soporte	Dimensioni del supporto	218.6 x 150x 128 mm
Speaker	Lautsprecher	Haut-parleur	Altavoz	Altoparlante	2 x 2W
Pixel Pitch (H/V)	Pixelabstand (H/V)	Pas de pixel (H/V)	Paso de píxeles (H/V)	Passo dei pixel (H/V)	0.2745 x 0.2745mm
MTBF	MTBF	MTBF	MTBF	MTBF	30,000 Hrs
Warranty	Garantie	Garantie	Garantía	Garanzia	3 Years
Compliance	Konformität	Conformité	Conformidad	Conformità	CE, FCC, UKCA, ICES, Energy Star, RoHS, WEE
Country of Origin	Herkunftsland	Pays d'origine	País de origen	Paese di origine	China
Package Includes	Paket enthält	Le paquet comprend	El paquete incluye	La confezione include	Monitor, HDMI cable, Adapter 12V 2.5A, Stand

General	Allgemein	Général	General	Generale	
Model	Modell	Modèle	Modelo	Modello	L270V0
Product Dimensions	Produkt Abmessungen	Dimensions du produit	Dimensiones del producto	Dimensioni del prodotto	61.3 x 17.8 x 44.5 cm (24.13 x 7.01 x 17.52 in)
Product Weight	Produktgewicht	Poids du produit	Peso del producto	Peso del prodotto	3.2 kg (7.05 lbs)
Package Dimensions	Abmessungen der Verpackung	Dimensions de l'emballage	Dimensiones del embalaje	Dimensioni dell'imballaggio	71.7 x 10 x 43 cm (28.23 x 3.94 x 16.93 in)
Package Weight	Gewicht der Verpackung	Poids de l'emballage	Peso del embalaje	Peso dell'imballaggio	4.4 kg (9.7 lbs)
Technical	Technisch	Technique	Técnico	Technique	
Panel Size	Panel-Größe	Taille du panneau	Tamaño del panel	Dimensione del pannello	27 Inches
Maximum Resolution	Maximale Auflösung	Résolution maximale	Resolución máxima	Risoluzione massima	1920 x 1080p
Image Quality	Bildqualität	Qualité de l'image	Calidad de imagen	Qualità dell'immagine	FHD
Panel Type	Panel-Typ	Type de panneau	Tipo de panel	Tipo di pannello	IPS
Input	Eingabe	Entrée	Entrada	Ingresso	HDMI 1.4, VGA, 3.5mm Audio
Brightness	Helligkeit	Luminosité	Brillo	Luminosità	250 cd/m ²
Refresh Rate	Bildwiederholrate	Taux de rafraîchissement	Frecuencia de actualización	Frequenza di aggiornamento	100Hz
Response Time	Reaktionszeit	Temps de réponse	Tiempo de respuesta	Tempo di risposta	5ms (OD)
Power Input	Leistungsaufnahme	Puissance d'entrée	Potencia de entrada	Potenza in ingresso	36W (12V 3A)
Aspect Ratio	Bildseitenverhältnis	Rapport d'aspect	Relación de aspecto	Rapporto d'aspetto	16:9
Contrast Ratio	Kontrastverhältnis	Rapport de contraste	Relación de contraste	Rapporto di contrasto	1000:1
Viewing Angle	Betrachtungswinkel	Angle de vision	Ángulo de visión	Angolo di visione	178°(H)/178°(V)
Screen Coating	Bildschirm-Beschichtung	Revêtement de l'écran	Revestimiento de la pantalla	Rivestimento dello schermo	Matte
VESA Mount	VESA-Halterung	Montage VESA	Montaje VESA	Montaggio VESA	100 x 100
Stand Dimension	Abmessungen des Standfußes	Dimension du support	Dimensiones del soporte	Dimensioni del supporto	200.5 x 191.5 x 128 mm
Speaker	Lautsprecher	Haut-parleur	Altavoz	Altoparlante	2 x 2W
Pixel Pitch (H/V)	Pixelabstand (H/V)	Pas de pixel (H/V)	Paso de píxeles (H/V)	Passo dei pixel (H/V)	0.3114 x 0.3114mm
MTBF	MTBF	MTBF	MTBF	MTBF	30,000 Hrs
Warranty	Garantie	Garantie	Garantía	Garanzia	3 Years
Compliance	Konformität	Conformité	Conformidad	Conformità	CE, FCC, UKCA, ICES, Energy Star, RoHS, WEE
Country of Origin	Herkunftsland	Pays d'origine	País de origen	Paese di origine	China
Package Includes	Paket enthält	Le paquet comprend	El paquete incluye	La confezione include	Monitor, HDMI cable, Adapter 12V 3A, Stand

Care & Safety | Soins et sécurité | Cuidado y seguridad | Pflege und Sicherheit | Cura e sicurezza

- Avoid exposing your monitor directly to sunlight or other heat source. Place your monitor away from the sun to reduce glare.
 - Put your monitor in a well ventilated, clean, dry area.
 - Do not place any heavy things on top of your monitor.
 - Keep your monitor away from magnets, motors, transformers, speakers, and TV sets.
 - If smoke, abnormal noise or odor came out from your monitor, caution you should remove the power cord immediately and call your service center.
 - Never remove the rear cover of your monitor cabinet. The display unit inside contains high-voltage parts and may cause electric shock
 - Never try to repair your monitor yourself. Always call your service center or a qualified technician.
-
- Évitez d'exposer votre moniteur directement à la lumière du soleil ou à une autre source de chaleur. Placez votre moniteur à l'abri du soleil pour réduire les reflets.
 - Placez votre moniteur dans un endroit bien ventilé, propre et sec.
 - Ne placez pas d'objets lourds sur votre moniteur.
 - Éloignez votre moniteur des aimants, des moteurs, des transformateurs, des haut-parleurs et des téléviseurs.
 - Si de la fumée, des bruits ou des odeurs anormales s'échappent de votre moniteur, débranchez immédiatement le cordon d'alimentation et appelez votre centre de service.
 - Ne retirez jamais le couvercle arrière du boîtier de votre moniteur. L'unité d'affichage à l'intérieur contient des pièces à haute tension et peut provoquer un choc électrique.
 - N'essayez jamais de réparer votre moniteur vous-même. Appelez toujours votre centre de service ou un technicien qualifié.
-
- Evite exponer el monitor directamente a la luz solar o a cualquier otra fuente de calor. Coloque el monitor alejado del sol para reducir el deslumbramiento.
 - Coloque el monitor en un lugar bien ventilado, limpio y seco.
 - No coloque objetos pesados encima del monitor.
 - Mantenga el monitor alejado de imanes, motores, transformadores, altavoces y televisores.
 - Si el monitor desprende humo, ruidos u olores anormales, desconecte inmediatamente el cable de alimentación y llame al servicio técnico.
 - No retire nunca la cubierta posterior de la carcasa del monitor. La unidad de visualización que se encuentra en el interior contiene piezas de alta tensión y puede provocar una descarga eléctrica.
 - Nunca intente reparar el monitor usted mismo. Llame siempre a su centro de servicio o a un técnico cualificado.
-
- Vermeiden Sie es, den Monitor direkt dem Sonnenlicht oder anderen Wärmequellen auszusetzen. Stellen Sie den Monitor nicht in die Sonne, um Blendeffekte zu vermeiden.
 - Stellen Sie den Monitor an einem gut belüfteten, sauberen und trockenen Ort auf.
 - Stellen Sie keine schweren Gegenstände auf den Monitor.
 - Halten Sie Ihren Monitor von Magneten, Motoren, Transformatoren, Lautsprechern und Fernsehgeräten fern.
 - Wenn Rauch, abnormale Geräusche oder Gerüche aus dem Monitor austreten, sollten Sie sofort das Netzkabel abziehen und den Kundendienst verständigen.
 - Entfernen Sie niemals die hintere Abdeckung des Monitorgehäuses. Die Anzeigeeinheit im Inneren enthält Hochspannungsteile und kann einen Stromschlag verursachen.
 - Versuchen Sie niemals, Ihren Monitor selbst zu reparieren. Wenden Sie sich immer an Ihr Kundendienstzentrum oder einen qualifizierten Techniker.
-
- Evitare di esporre il monitor direttamente alla luce del sole o ad altre fonti di calore. Posizionare il monitor lontano dal sole per ridurre i riflessi.
 - Collocare il monitor in un'area ben ventilata, pulita e asciutta.
 - Non collocare oggetti pesanti sopra il monitor.
 - Tenere il monitor lontano da magneti, motori, trasformatori, altoparlanti e televisori.
 - Se dal monitor fuoriescono fumo, rumori o odori anomali, è necessario rimuovere immediatamente il cavo di alimentazione e chiamare il centro di assistenza.
 - Non rimuovere mai il coperchio posteriore del monitor. L'unità di visualizzazione all'interno contiene parti ad alta tensione e può causare scosse elettriche.
 - Non cercare mai di riparare il monitor da soli. Rivolgersi sempre al centro di assistenza o a un tecnico qualificato.

SAFETY & FCC WARNING

Safety Precautions

This monitor is manufactured and tested on a ground principle that a user's safety comes first. However, improper use or installation may result danger to the monitor as well as to the user. Carefully go over the following WARNINGS before installation and keep this guide handy.

WARNINGS

- This monitor should be operated only at the correct power sources indicated on the label on the rear end of the monitor. If you're unsure of the power supply in your residence, consult your local dealer or power company.
- Do not try to repair the monitor yourself as it contains no user-serviceable parts. The monitor should only be repaired by a qualified technician.
- Do not remove the monitor cabinet. There is high-voltage parts inside that may cause electric shock to human bodies, even when the power cord is disconnected.
- Stop using the monitor if the cabinet is damaged. Have it checked by a service technician.
- Put your monitor only in a clean, dry environment. Unplug the monitor immediately if gets wet and consult your service technician.
- Always unplug the monitor before cleaning it. Clean the cabinet with a clean, dry cloth. Apply non-ammonia based cleaner onto the cloth, not directly onto the glass screen.
- Keep the monitor away from magnetic objects, motors, TV sets, and transformer.
- Do not place heavy objects on the cable or power cord.
- Due to safety concerns, if the VESA mounting kit is purchased separately, please make sure the mounting kit is UL-Listed, and replaceable only by service personnel.

FCC RADIO FREQUENCY INTERFERENCE STATEMENT WARNING: (FOR FCC CERTIFIED MODELS)

This monitor has been tested and found compliant with the limits for a Class B digital device, pursuant to part 15 of the FCC Rules. These limits are designed to provide proper protection against harmful interference to a residential installation. This monitor generates, uses, and can radiate radio frequency energy. Harmful interference to radio communication may be led as a result if it's not properly installed and used. However, there is no guarantee that interference will not occur in a particular installation. If this monitor does cause serious interference to radio or television reception, resetting the monitor may determine it. Moreover, users are encouraged to correct interference by doing one or more of the following:



- Reorient or relocate the receiving antenna.
- Move the monitor and the receiver further away from each other.
- Connect the monitor into an outlet on a circuit different from that to which the receiver is connected.
- Consult your local dealer or an qualified technician.

FCC Warning:

To assure a continued FCC compliance, a user must use a grounded power supply cord and the provided shielded video interface cable with bonded ferrite cores. Also, any unauthorized changes or modifications to this monitor would void the user's authority to operate this device.

Each country in the European Union should have its collection centers for electrical and electronic equipment recycling. For information about your recycling drop off area, please contact your related electrical and electronic equipment waste management authority or the retailer where you bought the product.

Note: If necessary, shielded interface cables and AC power cord must be used to meet the emission level limits.



According to WEEE regulation, this monitor can't be handled as normal trash in Europe when it is out of usage. Please refer to the recycle information from our website to handle it.

CAN ICES-3(B)/NMB-3(B)

This device complies with Part 15 of the FCC Rules.

Operation is subject to the following two conditions:

- (1) this device may not cause harmful interference, and
- (2) this device must accept any interference received, including interference that may cause undesired operation.