

# WB-CMU-6G

## Masonry Project Wall Boxes

# FSR

## Metal Products Group

WB-CMU-6G



Patent Pending

### DESCRIPTION

The WB-CMU-6G continues our line of solutions for block walls. This is a divisible six-gang wall box for masonry wall construction and is easily reconfigurable after installation. The WB-CMU-6G gives you peace of mind knowing if your initially installed devices become outdated, you will still be able to update them without impacting the installed infrastructure. It features the ability to separate compartments for high and low voltage, and gang plates can be configured in many different electrical plate configuration combinations. See the back page for plate configuration options. The gang plate trim ring comes complete with a divider and spacers; no extra parts are needed. Designed for CMU construction, this wall box has a large volume back box for high-density configurations with multiple KO openings for a 3/4" to 1.25" conduit. The gang plate trim ring provides a recessed gang-plate area to protect the devices from damage due to moving carts and other wall impacts.

### FEATURES

- Fully configurable after installation
- Many different electrical plate configurations
- Ability to separate high and low voltage
- Recessed Gang Plate Trim Ring to protect devices
- No extra parts are needed; divider and spacers provided
- 3/4" to 1.25" KO
- IPS Ready (Sold Separately)

### APPLICATIONS

- Gymnasiums
- Auditoriums
- Stadiums
- Educational Facilities
- Any masonry applications



### FSR Inc.

244 Bergen Boulevard, Woodland Park, NJ 07424

Phone: 973.998.2300 · Fax: 973.785.4207

Web: [www.fsrinc.com](http://www.fsrinc.com) · E-mail: [sales@fsrinc.com](mailto:sales@fsrinc.com)

Order Desk: 1-800-332-FSR1

LIT1862

# WB-CMU-6G

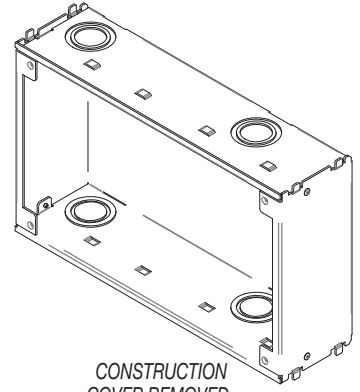
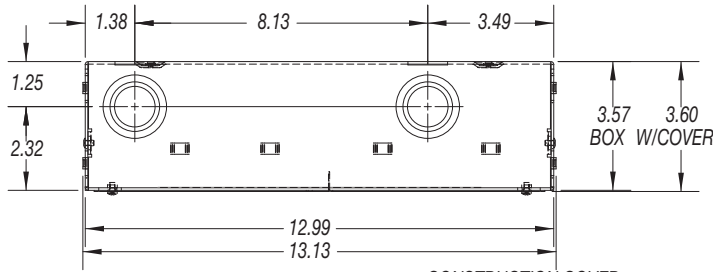

CONSTRUCTION COVER REMOVED

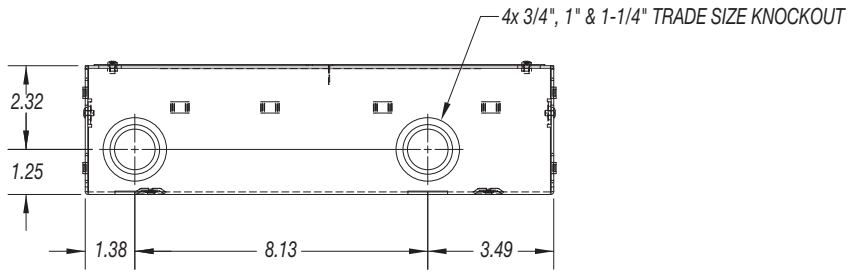
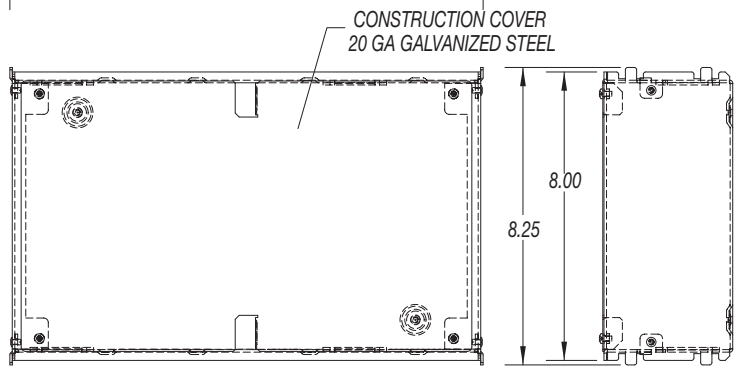
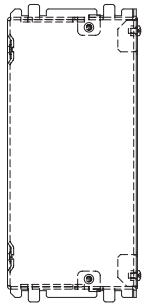

# WB-CMU-6GW-C GANG PLATE TRIM RING

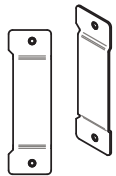
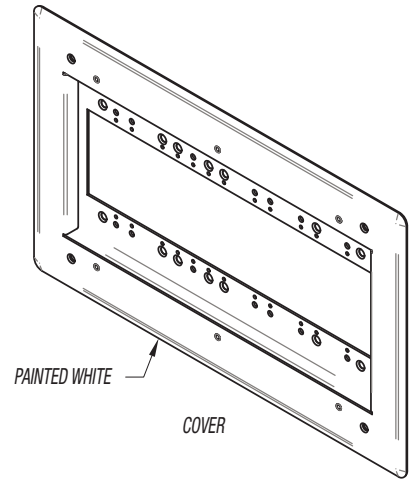
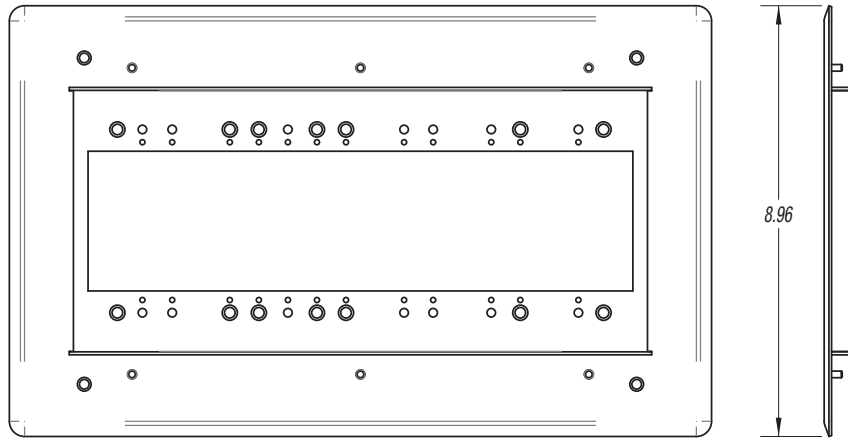
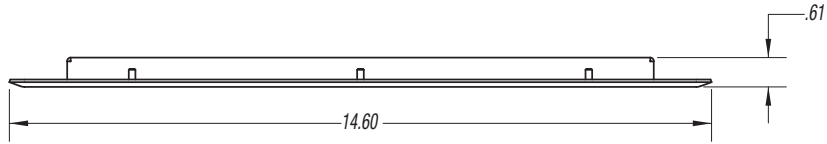

MEDIUM GANG  
SPACER

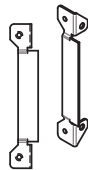

SMALL DIVIDER  
HOLDER

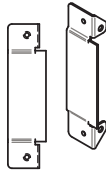

LARGE DIVIDER  
HOLDER

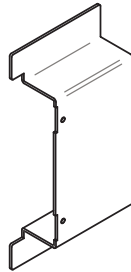

DIVIDER

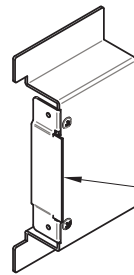

DIVIDER  
ASSEMBLY

DIVIDER

SMALL OR LARGE  
DIVIDER HOLDER

## WB-CMU-6G-B Plate Configurations

**4 Single Gang Plates**

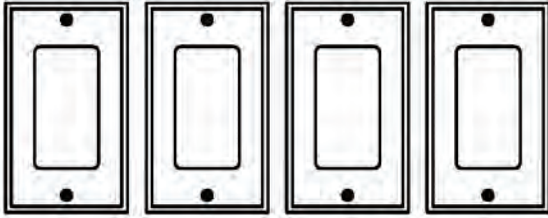

**One 2-Gang and One 3-Gang Plate**

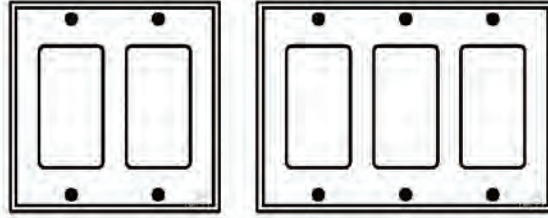

**Two Single Gang and One 2-Gang Plate**

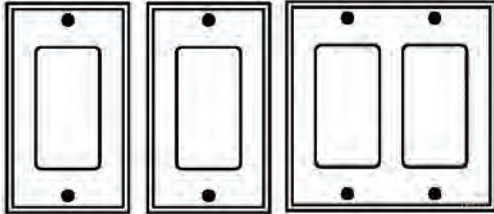

**One Single Gang and One 4-Gang Plate**

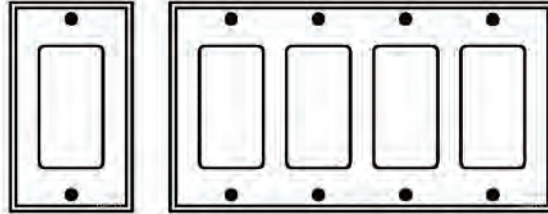

**One Single Gang and One 3-Gang Plate**

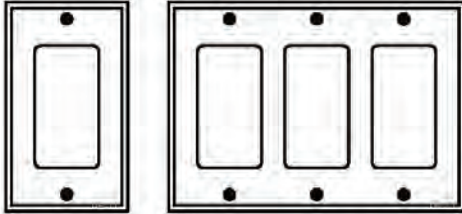

**One 5-Gang Plate**

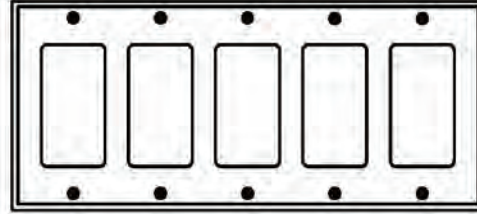

**Two 2-Gang Plates**

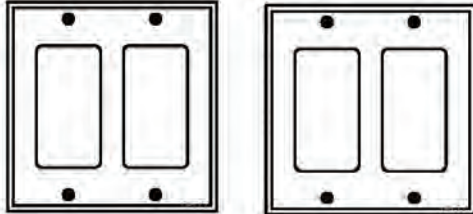

**One 6-Gang Plate**

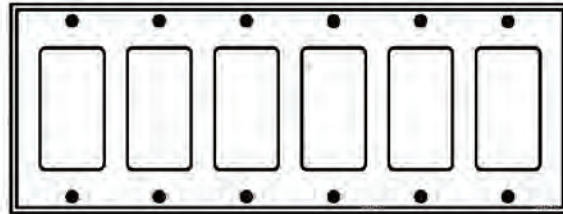

## Ordering Chart

Item #	Part #	Description
18578	WB-CMU-6G-B	BOX ONLY 6 Gang CMU Back Box
18579	WB-CMU-6GW-C	COVER ONLY Configurable Trim Plate 6 Gang



244 Bergen Boulevard, Woodland Park, NJ 07424  
 Phone: 973.998.2300 · Fax: 973.785.4207  
 Web: [www.fsrinc.com](http://www.fsrinc.com) · E-mail: [sales@fsrinc.com](mailto:sales@fsrinc.com)



Specifications are subject to change without notice.