

Yealink

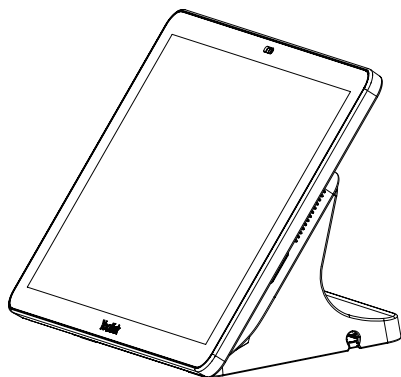

Installation Video



CTP25 Mount Kits Quick Start Guide V1.0

English | DEUTSCH | FRANÇAIS | ESPAÑOL

Content

English.....	1
Deutsch.....	4
Français.....	7
Español.....	10

Package Contents

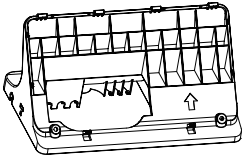

High Stand

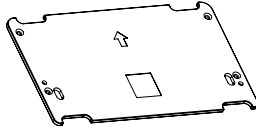

Cable Management Cover

Place on the Table

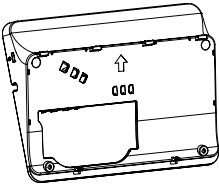

Low Stand
(Lock device)

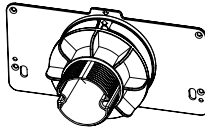
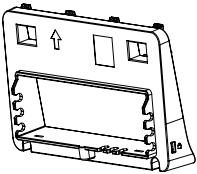
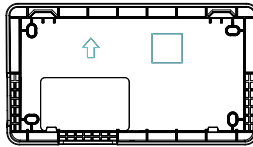

Table Lock Kit

Mount on the Table



Wall Mount-A
(Lock device)



Wall Mount-B
(Wall mount)

Mount on the Wall



× 25

M3 Screw

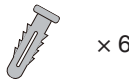

× 6

φ6 * 30 mm, Expansion bolt



× 6

T4×30, Self-tapping screws

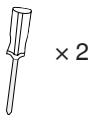

× 2

(WH-85*3.0mm)
Screwdriver



(129.74*96.45mm)
3M Tape

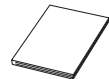

Quick Start Guide

Installation

 The CTP25 and cables shown in the image are included in the CTP25 packaging and need to be purchased separately.

• Place on the Table

- 1 Screw specifications:
M3 screw

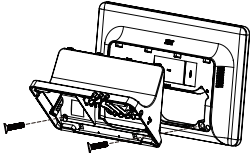

- 2 Recommended cable management method:

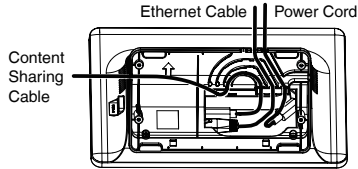

- 3 Screw specifications:
M3 screw

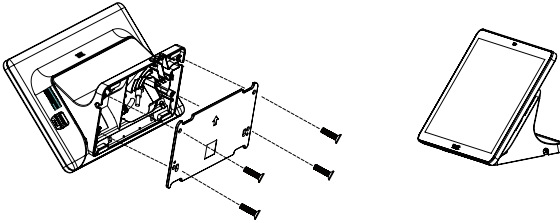

• Mount on the Table

- 1 Screw specifications:
M3 screw

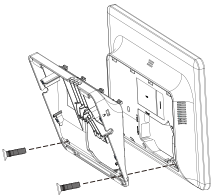

- 2 Recommended cable management method:

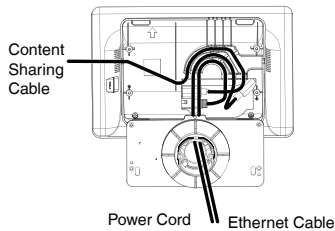

- 3 Screw specifications:
M3 screw

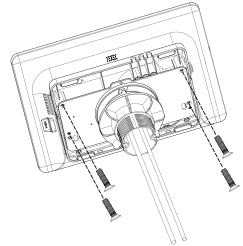

- 4 Make sure the two arrows on the table mount are aligned.

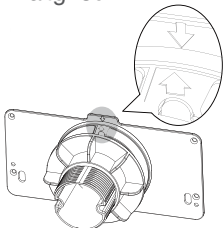

- 5

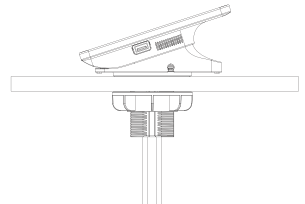
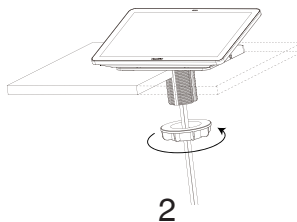

• Mount on the Wall

- The wall mounting height should be determined based on the actual usage scenario, with a recommended range of 1.3 meters to 1.6 meters above the ground.
- If the conference room environment allows, you can also wire through the wall.

- 1 Screw specifications:
φ6 * 30 mm, Expansion bolt

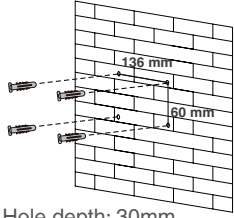

- 2 Screw specifications:
T4×30, Self-tapping screws

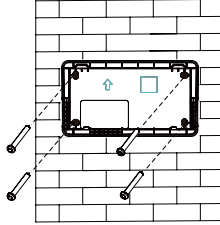

- 3 Screw specifications:
M3 Screw

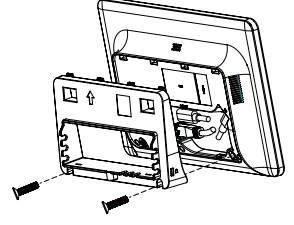

- 4 (Surface-mounted conduit)
Recommended cable management method:

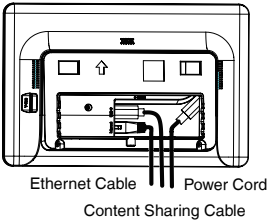

- (Pattress)
Recommended cable management method:

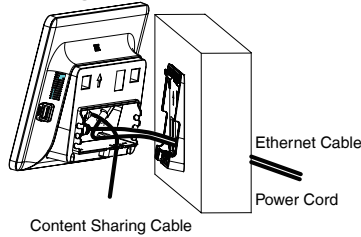

- 5

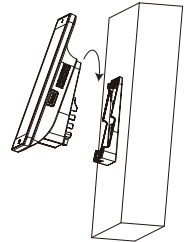

- 6 Screw specifications:
M3 screw

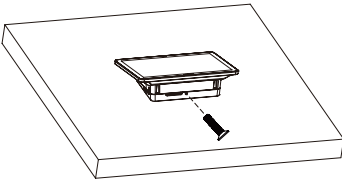

Lieferumfang

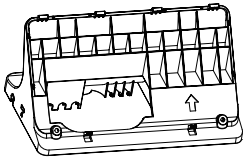

Hochwinkelhalterung

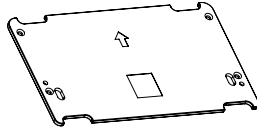

Kabelmanagement-
Abdeckung

Auf den Tisch legen

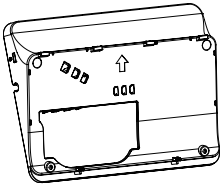

Niedrigwinkelhalterung Tischverriegelungssatz
(Sperrgerät)

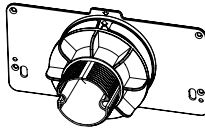

Auf dem Tisch montieren

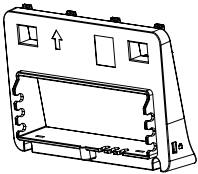

Wandmontage
(Sperrgerät)

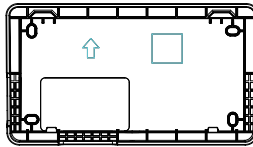

Wandmontage
(Wandhalterung)

An der Wand montieren



× 25

M3 Schraube



× 6

Φ6 * 30 mm, Spreizdübel



× 6

T4x30,
selbstschneidende
Schrauben



× 2

(WH-85*3.0mm)
Schraubendreher



(129,74*96,45 mm)
3M-Klebeband

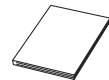

Kurzanleitung

Montage

 Der in der Abbildung gezeigte CTP25 und die Kabel sind im CTP25-Verpackungsmaterial enthalten und müssen separat erworben werden.

• Auf den Tisch legen

- 1** Schraubenspezifikationen: M3-Schraube **2** Empfohlene Kabelmanagement-Methode:

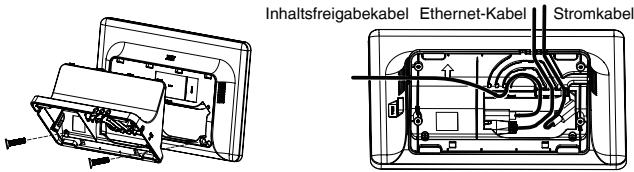

- 3** Schraubenspezifikationen: M3-Schraube

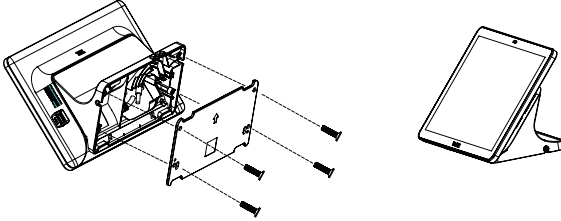

• Auf dem Tisch montieren

- 1** Schraubenspezifikationen: M3-Schraube **2** Empfohlene Kabelmanagement-Methode: **3** Schraubenspezifikationen: M3-Schraube

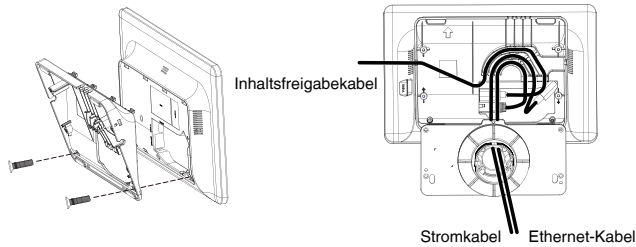

- 4** Stellen Sie sicher, dass die beiden Pfeile auf der Tischhalterung ausgerichtet sind.

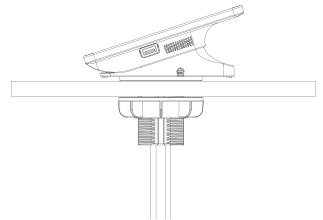
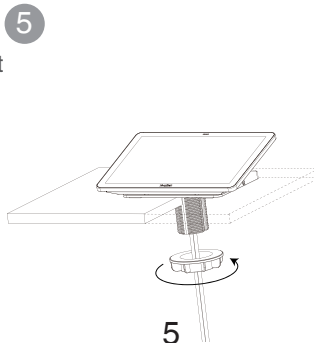
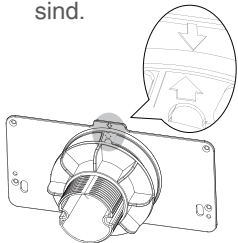

• An der Wand montieren



- Die Wandmontagehöhe sollte je nach tatsächlicher Nutzungssituation festgelegt werden, mit einem empfohlenen Bereich von 1,3 Metern bis 1,6 Metern über dem Boden.
- Wenn es die Konferenzraumumgebung zulässt, können Sie Drahtgebundenes auch durch die Wand leiten.

- 1** Schraubenspezifikationen: $\phi 6 \times 30$ mm, Spreizdübel
- 2** Schraubenspezifikationen: T4x30, selbstschneidende Schrauben
- 3** Schraubenspezifikationen: M3 Schraube

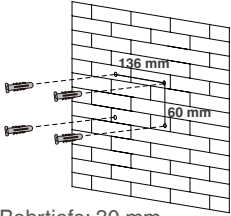

Bohrtiefe: 30 mm
Lochdurchmesser: 6 mm

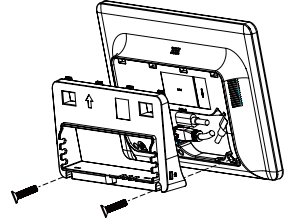
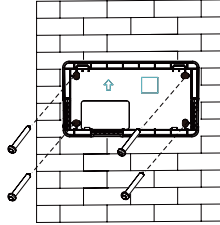

- 4** (Aufputz-Kanalsystem)
Empfohlene
Kabelmanagement-Methode:

- Unterputzdose
Empfohlene
Kabelmanagement-Methode:

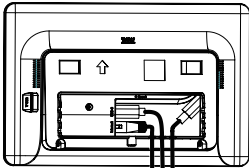

Ethernet-Kabel
Stromkabel
Inhaltsfreigabekabel

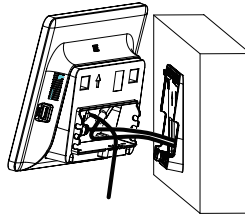

Inhaltsfreigabekabel

Ethernet-Kabel
Stromkabel

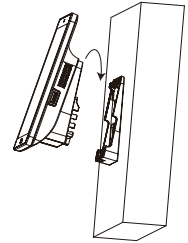

- 6** Schraubenspezifikationen:
M3-Schraube

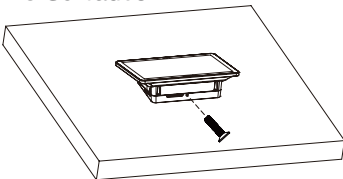

Contenu de la boîte

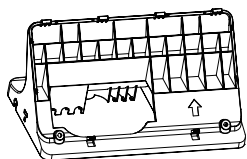

Support à angle élevé

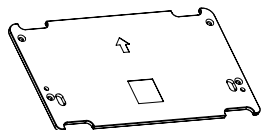

Cache de gestion des câbles

Placer sur la table

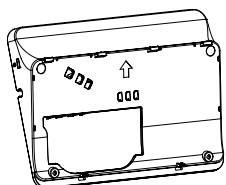

Support à faible angle
(Verrouiller l'appareil)

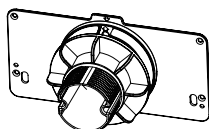

Kit de verrouillage
de table

Fixer sur la table

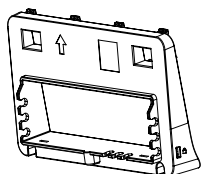

Support mural
(Verrouiller l'appareil)

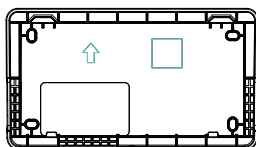

Support mural
(Montage mural)

Monter au mur



× 25

Vis M3



× 6

φ6 * 30 mm, Boulon d'expansion



× 6

Vis autotaraudeuses T4x30



× 2

(WH-85*3.0mm)

Tournevis



(129,74 * 96,45 mm)

Bande adhésive 3M

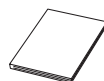

Guide de démarrage rapide

Installation

 Le CTP25 et les câbles illustrés dans l'image sont inclus dans l'emballage CTP25 et doivent être achetés séparément.

• Placer sur la table

- 1 Spécifications des vis:
Vis M3

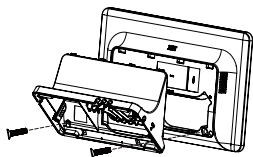

- 2 Méthode recommandée
de gestion des câbles:

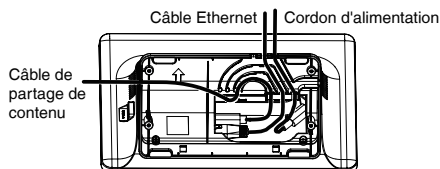

- 3 Spécifications des vis:
Vis M3

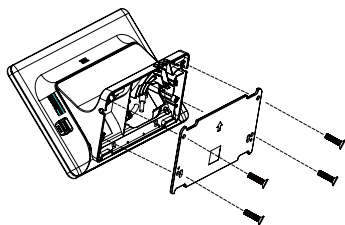

• Fixer sur la table

- 1 Spécifications des vis:
Vis M3

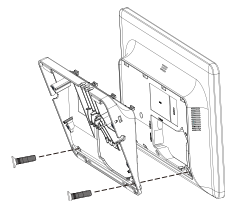

- 2 Méthode recommandée
de gestion des câbles:

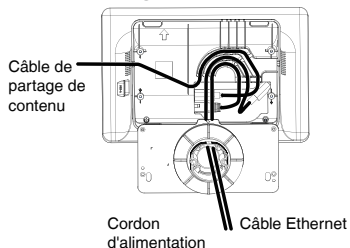

- 3 Spécifications des vis:
Vis M3

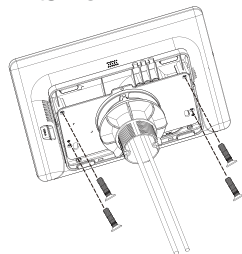

- 4 Assurez-vous que les deux
flèches sur le support de
table sont alignées.

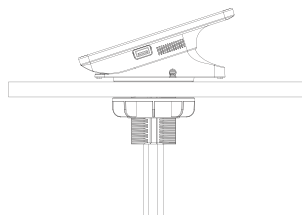
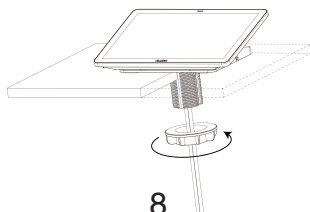
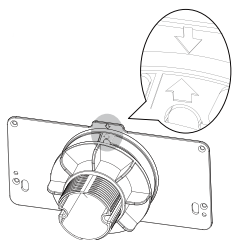

• Monter au mur



- La hauteur de montage mural doit être déterminée en fonction du scénario d'utilisation réel, avec une plage recommandée de 1,3 mètres à 1,6 mètres au-dessus du sol.
- Si l'environnement de la salle de conférence le permet, vous pouvez également faire passer les câbles à travers le mur.

- 1 Spécifications des vis:
Boulon d'expansion $\phi 6$
* 30 mm

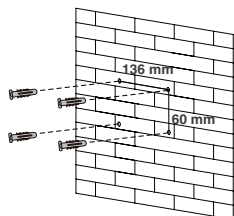

Profondeur du trou : 30 mm

Diamètre du trou : 6 mm

- 2 Spécifications des vis:
Vis autotaraudeuses
T4x30

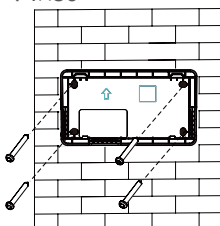

- 3 Spécifications des vis:
Vis M3

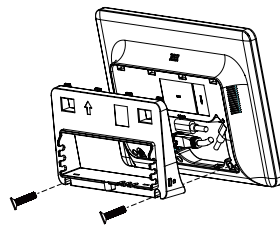

- 4 Méthode recommandée de
gestion des câbles (Conduit
en saillie) :

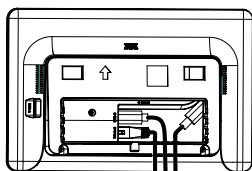

Câble Ethernet Cordon d'alimentation

Câble de partage de contenu

- (Boîte d'encastement)
Méthode recommandée de
gestion des câbles :

5

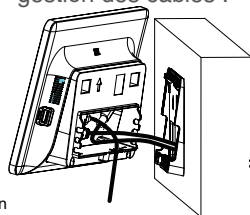

Câble Ethernet

Cordon d'alimentation

Câble de partage de contenu

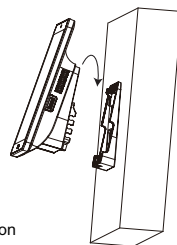

- 6 Spécifications des vis:
Vis M3

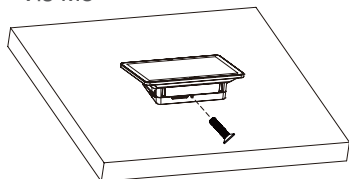

Contenido de la caja

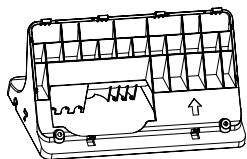

Soporte de ángulo alto

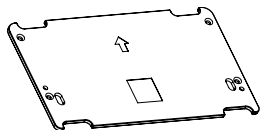

Cubierta de Gestión de Cables

Colocar en la mesa

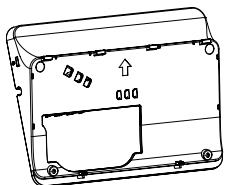

Soporte de ángulo bajo
(Bloquear dispositivo)

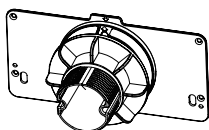

Kit de Bloqueo
para Mesa

Montar en la mesa

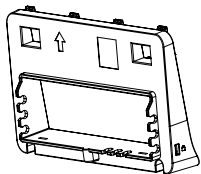

Montaje en Pared-A
(Bloquear dispositivo)

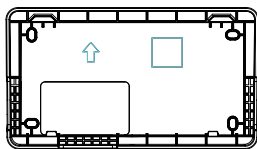

Montaje de pared-B
(Montaje en pared)

Montar en la pared



× 25

Tornillo M3



× 6

φ6 * 30 mm, Perno de expansión



× 6

T4×30, Tornillos auto perforantes



× 2

(WH-85*3.0mm)

Destornillador



(129,74*96,45 mm)

Cinta 3M

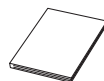

Guía de inicio rápido

Instalación

💡 El CTP25 y los cables mostrados en la imagen se incluyen en el embalaje CTP25 y deben comprarse por separado.

• Colocar en la mesa

- 1 Especificaciones del tornillo: Tornillo M3

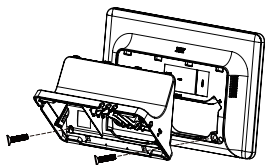

Cable de Compartición de Contenido

- 2 Método recomendado para la gestión de cables:

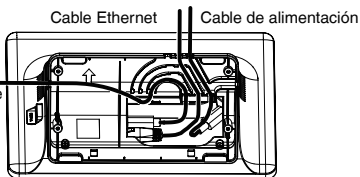

- 3 Especificaciones del tornillo: Tornillo M3

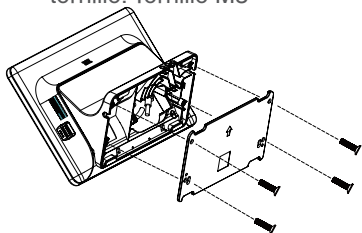

• Montar en la mesa

- 1 Especificaciones del tornillo: Tornillo M3

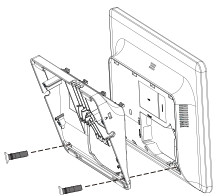

Cable de Compartición de Contenido

- 2 Método recomendado para la gestión de cables:

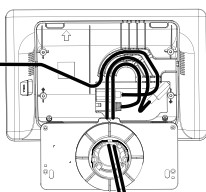

Cable de alimentación Cable Ethernet

- 3 Especificaciones del tornillo: Tornillo M3

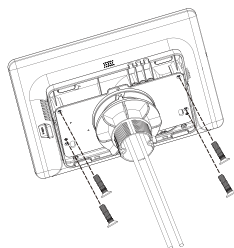

- 4 Asegúrate de que las dos flechas en el soporte de la mesa estén alineadas.

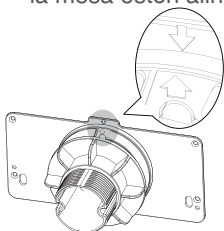

- 5

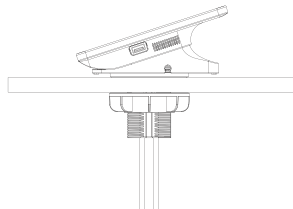
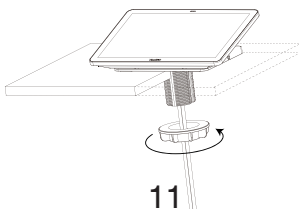

• Montar en la pared



- La altura de montaje en la pared debe determinarse según el escenario de uso real, con un rango recomendado de 1,3 metros a 1,6 metros por encima del suelo.
- Si el entorno de la sala de conferencias lo permite, también puede instalar el cableado a través de la pared.

- 1** Especificaciones del tornillo: $\Phi 6 \times 30$ mm, Perno de expansión

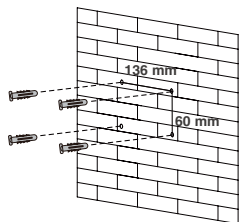

Profundidad del agujero: 30mm
Diámetro del agujero: 6 mm

- 2** Especificaciones del tornillo: T4x30, Tornillos auto perforantes

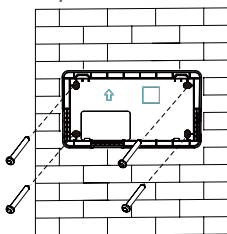

- 3** Especificaciones del tornillo: Tornillo M3

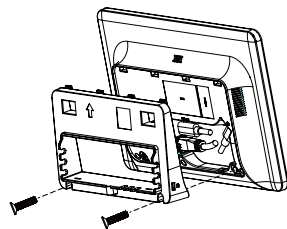

- 4** Método recomendado de gestión de cables (Conducción montada en superficie):

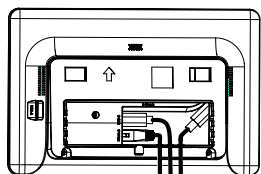

Cable Ethernet
Cable de alimentación
Cable de Compartición de Contenido

- (Caja de empotrar)
Método recomendado para la gestión de cables:

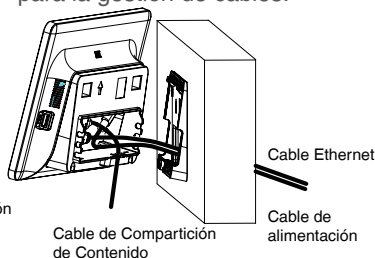

- 5**

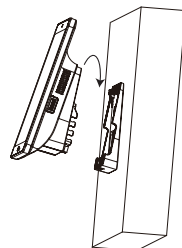

- 6** Especificaciones del tornillo: Tornillo M3

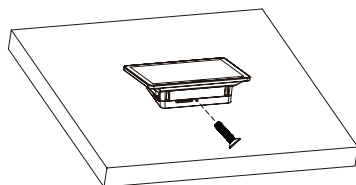

About Yealink

Yealink (Stock Code: 300628) is a global-leading provider of Unified Communication & Collaboration Solutions specialized in video conferencing, voice communications, and collaboration, dedicated to helping every person and organization embrace the power of "Easy Collaboration, High Productivity".

With best-in-class quality, innovative technology, and user-friendly experiences, Yealink is one of the best providers in more than 140 countries and regions, ranks No.1 in the global market share of IP Phone, and is the Top 5 leader in the video conferencing market (Frost & Sullivan, 2021).

For more information about Yealink, click <https://www.yealink.com>.

Copyright

Copyright © 2024 Yealink(Xiamen) Network Technology CO., LTD.

Copyright © 2024 Yealink(Xiamen) Network Technology CO., LTD. All rights reserved. No parts of this publication may be reproduced or transmitted in any form or by any means, electronic or mechanical, photocopying, recording, or otherwise, for any purpose, without the express written permission of Yealink(Xiamen) Network Technology CO., LTD.

Technical Support

Visit Yealink WIKI (<http://support.yealink.com/>) for firmware downloads, product documents, FAQ, and more. For better service, we sincerely recommend you to use Yealink Ticketing system (<https://ticket.yealink.com>) to submit all your technical issues.



430104002780



YEALINK NETWORK TECHNOLOGY CO.,LTD.
No.666 Hu'an Rd.,Huli District Xiamen City, Fujian, P.R. C
Web: www.yealink.com
Copyright©2024 YEALINK(XIAMEN) NETWORK
TECHNOLOGY CO., LTD.All rights reserved.