



Online User's Guide

**DCP-L2600D/DCP-L2620DW/DCP-L2622DW/DCP-L2627DW/
DCP-L2627DWXL/DCP-L2627DWE/DCP-L2640DN/DCP-L2660DW/
DCP-L2665DW/MFC-L2802DN/MFC-L2800DW/MFC-L2802DW/
MFC-L2827DWXL/MFC-L2827DW/MFC-L2835DW/MFC-L2860DWE/
MFC-L2860DW/MFC-L2862DW/MFC-L2922DW/MFC-L2960DW/
MFC-L2980DW**

Table of Contents

| | |
|----------------------------------------------------------------------------------------------------------|-----------|
| Before You Use Your Machine | 1 |
| Definitions of Notes | 2 |
| Trademarks | 3 |
| Open Source Licensing | 4 |
| Copyright and License | 5 |
| Important Notes..... | 6 |
| Introduction to Your Machine | 7 |
| Before Using Your Machine | 8 |
| Control Panel Overview | 9 |
| Touchscreen LCD Overview..... | 15 |
| How to Navigate the Touchscreen LCD | 18 |
| Set the Main Home Screen | 20 |
| Settings Screen Overview | 21 |
| How to Enter Text on Your Machine | 22 |
| Access Brother Utilities (Windows) | 25 |
| Uninstall the Software and Drivers (Windows) | 26 |
| Access Brother iPrint&Scan (Windows/Mac) | 27 |
| Input/Output Port Locations on Your Machine | 29 |
| Paper Handling | 30 |
| Load Paper..... | 31 |
| Load Paper in the Paper Tray | 32 |
| Load and Print Plain Paper, Thin Paper, Recycled Paper and Bond Paper in the Manual Feed Slot | 36 |
| Load and Print on Thick Paper and Labels Using the Manual Feed Slot..... | 38 |
| Load and Print on Envelopes in the Manual Feed Slot | 40 |
| Paper Settings..... | 42 |
| Change the Paper Size and Paper Type..... | 43 |
| Change the Check Paper Setting..... | 44 |
| Recommended Print Media..... | 45 |
| Load Documents | 46 |
| Load Documents in the Automatic Document Feeder (ADF) | 47 |
| Load Documents on the Scanner Glass..... | 49 |
| Unscannable and Unprintable Areas | 50 |
| Using Special Paper..... | 51 |
| Print | 52 |
| Print from Your Computer (Windows)..... | 53 |
| Print a Document (Windows)..... | 54 |
| Print on Both Sides of the Paper (Windows) | 56 |
| Secure Print (Windows)..... | 59 |
| Change the Default Print Settings (Windows) | 60 |
| Print Settings (Windows) | 61 |
| Print a Document Using the BR-Script3 Printer Driver (PostScript® 3™ Language Emulation) (Windows) | 66 |
| Monitor the Status of the Machine from Your Computer (Windows) | 67 |
| Print from Your Computer (Mac) | 68 |

| | |
|-------------------------------------------------------------------------------------|------------|
| Load and Print on Envelopes in the Manual Feed Slot | 69 |
| Print an Email Attachment..... | 71 |
| Change Print Settings Using the Control Panel | 72 |
| Cancel a Print Job | 73 |
| Test Print | 74 |
| Universal Print..... | 75 |
| Universal Print Overview | 76 |
| Register Your Machine with Universal Print Using Web Based Management..... | 77 |
| Assign Universal Print Users via Microsoft Azure Portal..... | 78 |
| Add a Universal Print-enabled Printer to Your Computer | 79 |
| Print Using Universal Print | 80 |
| Deregister Your Machine from Universal Print | 81 |
| Scan..... | 82 |
| Scan Using the Scan Button on Your Machine | 83 |
| Scan Photos and Graphics..... | 84 |
| Scan Single or Multiple Pages to a Folder in a Single PDF File | 86 |
| Scan to an Editable Text File (OCR) | 88 |
| Save Scanned Data as an Email Attachment | 90 |
| Send Scanned Data to an Email Recipient | 92 |
| Scan to FTP | 94 |
| Scan to Network (Windows)..... | 98 |
| Use the Web Services Protocol for Network Scanning (Windows 10 and Windows 11)..... | 104 |
| Change the Scan Button Settings from Brother iPrint&Scan | 108 |
| Configure Certificates for Signed PDFs | 109 |
| Disable Scanning from Your Computer | 111 |
| Scan from Your Computer (Windows)..... | 112 |
| Scan Using Brother iPrint&Scan (Windows/Mac)..... | 113 |
| Scan Using Nuance™ PaperPort™ 14SE or Other Windows Applications..... | 114 |
| Scan Using Windows Fax and Scan | 119 |
| Scan from Your Computer (Mac)..... | 123 |
| Configure Scan Settings Using Web Based Management..... | 124 |
| Set the Scan File Name Using Web Based Management..... | 125 |
| Copy | 126 |
| Copy on One Side of the Paper (1-sided)..... | 127 |
| Copy on Both Sides of the Paper (2-sided)..... | 130 |
| Enlarge or Reduce Copied Images | 133 |
| Make N in 1 Copies Using the Page Layout Feature | 135 |
| Sort Copies | 137 |
| Copy an ID Card | 139 |
| Copy Options | 141 |
| Fax..... | 144 |
| Send a Fax..... | 145 |
| Send a Fax | 146 |
| Send a 2-sided Fax from the ADF | 150 |
| Send a Fax Manually..... | 151 |
| Send a Fax at the End of a Conversation | 152 |
| Send the Same Fax to More than One Recipient (Broadcasting) | 153 |

| | |
|------------------------------------------------------------------------|------------|
| Send a Fax in Real Time | 156 |
| Send a Fax at a Specified Time (Delayed Fax)..... | 158 |
| Add a Cover Page to Your Fax..... | 160 |
| Cancel a Fax in Progress | 163 |
| Check and Cancel a Pending Fax..... | 164 |
| Fax Options | 165 |
| Receive a Fax | 167 |
| Receive Mode Settings | 168 |
| Memory Receive Options | 189 |
| Remote Fax Retrieval..... | 201 |
| Voice Operations and Fax Numbers | 207 |
| Voice Operations | 208 |
| Store Fax Numbers | 210 |
| Dial a Number Using a Shortcut..... | 214 |
| Dial a Number Using Speed Dial | 217 |
| Set up Broadcasting Groups | 220 |
| Combine Address Book Numbers | 227 |
| Telephone Services and External Devices..... | 229 |
| Use BT Call Sign | 230 |
| Caller ID | 232 |
| Set the Telephone Line Type..... | 234 |
| External TAD (Telephone Answering Device)..... | 237 |
| External and Extension Telephones | 240 |
| Multi-line Connections (PBX) | 248 |
| Fax Reports..... | 249 |
| Print a Transmission Verification Report | 250 |
| Print a Fax Journal | 251 |
| PC-FAX | 253 |
| PC-FAX for Windows..... | 254 |
| PC-FAX for Mac | 275 |
| Network | 276 |
| Supported Basic Network Features | 277 |
| Configure Network Settings | 278 |
| Configure Network Details Using the Control Panel..... | 279 |
| Wireless Network Settings | 280 |
| Use the Wireless Network | 281 |
| Use Wi-Fi Direct® | 300 |
| Enable/Disable Wireless LAN | 306 |
| Print the WLAN Report..... | 307 |
| Network Features..... | 311 |
| Enable/Disable Web Based Management Using the Control Panel..... | 312 |
| Configure the Proxy Server Settings Using Web Based Management | 313 |
| Print the Network Configuration Report..... | 314 |
| Configure PC-FAX Receiving Using Web Based Management | 316 |
| Fax Using the Internet (I-Fax) | 317 |
| Use the Send Fax to Server Feature..... | 341 |
| Synchronise Time with the SNTP Server Using Web Based Management | 345 |

| | |
|--------------------------------------------------------------------------------------------------------------------|------------|
| Forward Incoming Faxes to a Network Destination..... | 349 |
| Reset the Network Settings to the Factory Settings..... | 351 |
| Security | 352 |
| Before Using Network Security Features | 353 |
| Disable Unnecessary Protocols | 354 |
| Configure Certificates for Device Security | 355 |
| Supported Security Certificate Features | 356 |
| How to Create and Install a Certificate | 357 |
| Create a Self-signed Certificate | 358 |
| Create a Certificate Signing Request (CSR) and Install a Certificate from a Certificate Authority (CA) | 359 |
| Import and Export the Certificate and Private Key | 363 |
| Import and Export a CA Certificate..... | 366 |
| Manage Multiple Certificates | 369 |
| Use SSL/TLS | 370 |
| Introduction to SSL/TLS | 371 |
| Manage Your Network Machine Securely Using SSL/TLS..... | 374 |
| Print Documents Securely Using SSL/TLS | 379 |
| Use SNMPv3..... | 381 |
| Manage Your Network Machine Securely Using SNMPv3 | 382 |
| Use IPsec..... | 384 |
| Introduction to IPsec..... | 385 |
| Configure IPsec Using Web Based Management | 386 |
| Configure an IPsec Address Template Using Web Based Management | 388 |
| Configure an IPsec Template Using Web Based Management | 390 |
| Use IEEE 802.1x Authentication | 399 |
| What Is IEEE 802.1x Authentication? | 400 |
| Configure IEEE 802.1x Authentication for a Wired or Wireless Network Using Web Based Management (Web Browser)..... | 401 |
| IEEE 802.1x Authentication Methods | 403 |
| Use Active Directory Authentication..... | 404 |
| Introduction to Active Directory Authentication..... | 405 |
| Configure Active Directory Authentication Using Web Based Management..... | 406 |
| Log On to Change the Machine Settings Using the Machine's Control Panel (Active Directory Authentication) | 408 |
| Use LDAP Authentication..... | 409 |
| Introduction to LDAP Authentication | 410 |
| Configure LDAP Authentication Using Web Based Management..... | 411 |
| Log On to Change the Machine Settings Using the Machine's Control Panel (LDAP Authentication) | 412 |
| Use Secure Function Lock 3.0 | 413 |
| Before Using Secure Function Lock 3.0 | 414 |
| Configure Secure Function Lock 3.0 Using Web Based Management | 415 |
| Scan Using Secure Function Lock 3.0 | 416 |
| Configure Public Mode for Secure Function Lock 3.0 | 417 |
| Additional Secure Function Lock 3.0 Features..... | 418 |
| Register a new ID Card Using the Machine's Control Panel..... | 419 |
| Send or Receive an Email Securely..... | 420 |

| | |
|-----------------------------------------------------------------------------------|------------|
| Configure Email Sending or Receiving Using Web Based Management..... | 421 |
| Send an Email with User Authentication | 422 |
| Send or Receive an Email Securely Using SSL/TLS | 423 |
| Store Print Log to Network | 424 |
| Store Print Log to Network Overview | 425 |
| Configure the Store Print Log to Network Settings Using Web Based Management..... | 426 |
| Use the Store Print Log to Network's Error Detection Setting..... | 428 |
| Use Store Print Log to Network with Secure Function Lock 3.0..... | 430 |
| Lock the Machine Settings from the Control Panel..... | 431 |
| Setting Lock Overview..... | 432 |
| Use Global Network Detection Features..... | 436 |
| Enable Global IP Address Detection | 437 |
| Block Communications from the Global Network | 438 |
| Mobile/Web Connect..... | 439 |
| Brother Web Connect..... | 440 |
| Brother Web Connect Overview | 441 |
| Online Services Used with Brother Web Connect..... | 443 |
| Set Up Brother Web Connect..... | 445 |
| Scan and Upload Documents Using Brother Web Connect..... | 453 |
| Download and Print Documents Using Brother Web Connect..... | 454 |
| FaxForward to Cloud or E-mail | 456 |
| AirPrint | 459 |
| AirPrint Overview..... | 460 |
| Before Using AirPrint (macOS) | 461 |
| Print Using AirPrint | 462 |
| Scan Using AirPrint (macOS)..... | 465 |
| Send a Fax Using AirPrint (macOS)..... | 466 |
| Mopria™ Print Service and Mopria™ Scan..... | 467 |
| Brother Mobile Connect | 468 |
| Troubleshooting | 469 |
| Error and Maintenance Messages | 470 |
| Unable to Print or Scan -Transfer Your Faxes..... | 479 |
| Error Messages When Using the Brother Web Connect Feature | 483 |
| Document Jams | 485 |
| Document is Jammed in the Top of the ADF Unit | 486 |
| Document is Jammed under the Document Cover | 487 |
| Remove Small Scraps of Paper Jammed in the ADF | 488 |
| Paper Jams | 489 |
| Clear Paper Jams..... | 490 |
| Paper is Jammed in the Paper Tray | 491 |
| Paper is Jammed in the Output Paper Tray | 493 |
| Paper is Jammed in the Back of the Machine | 494 |
| Paper is Jammed inside the Machine | 496 |
| Paper is Jammed in the 2-sided Tray..... | 498 |
| Printing Problems..... | 500 |
| Improve the Print Quality..... | 503 |
| Telephone and Fax Problems | 508 |







| | |
|--------------------------------------------------------------------------|------------|
| Set Dial Tone Detection | 511 |
| Set Telephone Line Compatibility for Interference and VoIP Systems | 512 |
| Network Problems | 514 |
| Error Messages | 515 |
| Use the Network Connection Repair Tool (Windows) | 518 |
| Check Your Machine's Network Settings..... | 519 |
| If You Are Having Difficulty with Your Machine's Network | 520 |
| AirPrint Problems | 526 |
| Other Problems | 527 |
| Check the Machine Information | 529 |
| Update Your Machine's Firmware | 530 |
| Reset Your Machine | 531 |
| Reset Functions Overview | 533 |
| Routine Maintenance | 535 |
| Replace Supplies | 536 |
| Replace the Toner Cartridge | 538 |
| Replace the Drum Unit..... | 541 |
| Reset the Drum Counter | 543 |
| Clean the Machine | 544 |
| Clean the Scanner..... | 546 |
| Clean the Touchscreen LCD | 547 |
| Clean the Corona Wire..... | 548 |
| Clean the Drum Unit..... | 549 |
| Clean the Paper Pick-up Rollers | 555 |
| Check the Remaining Part Life | 556 |
| Pack and Ship Your Machine | 557 |
| Machine Settings..... | 559 |
| Check Your Machine's Password..... | 560 |
| Change Machine Settings from the Control Panel..... | 561 |
| In the Event of Power Failure (Memory Storage)..... | 562 |
| General Settings..... | 563 |
| Save Your Favourite Settings as a Shortcut..... | 587 |
| Print Reports | 590 |
| Settings and Features Tables..... | 593 |
| Change Machine Settings Using Web Based Management | 640 |
| What is Web Based Management?..... | 641 |
| Access Web Based Management | 643 |
| Change the Login Password Using Web Based Management | 646 |
| Set Up Your Machine's Address Book Using Web Based Management..... | 647 |
| Appendix..... | 648 |
| Specifications | 649 |
| Supplies | 659 |
| Environmental and Compliance Information | 661 |
| Information Regarding Recycled Paper | 662 |
| Availability of Service Parts | 663 |
| Chemical Substances (EU REACH)..... | 664 |
| Brother Help and Customer Support..... | 665 |

Before You Use Your Machine

- [Definitions of Notes](#)
- [Trademarks](#)
- [Open Source Licensing](#)
- [Copyright and License](#)
- [Important Notes](#)

Definitions of Notes

We use the following symbols and conventions throughout this User's Guide:

| | |
|--------------------------------------------------------------------------------------------------|-------------------------------------------------------------------------------------------------------------------------------------------------|
|  WARNING | WARNING indicates a potentially hazardous situation which, if not avoided, could result in death or serious injuries. |
|  CAUTION | CAUTION indicates a potentially hazardous situation which, if not avoided, may result in minor or moderate injuries. |
| IMPORTANT | IMPORTANT indicates a potentially hazardous situation which, if not avoided, may result in damage to property or loss of product functionality. |
| NOTE | NOTE specifies the operating environment, conditions for installation, or special conditions of use. |
|  | Tips icons indicate helpful hints and supplementary information. |
|  | Electrical Hazard icons alert you to possible electrical shock. |
|  | Fire Hazard icons alert you to the possibility of a fire. |
|  | Hot Surface icons warn you not to touch hot machine parts. |
|  | Prohibition icons indicate actions you must not perform. |
| Bold | Bold style identifies buttons on the machine's control panel or computer screen. |
| <i>Italics</i> | Italicised style emphasises an important point or refers you to a related topic. |
| Courier New | Courier New font identifies messages shown on the machine's LCD. |

Related Information

- [Before You Use Your Machine](#)

Trademarks

Apple, App Store, AirPrint, the AirPrint logo, Mac, macOS, iPadOS, iPad, iPhone, iPod touch, and Safari are trademarks of Apple Inc., registered in the U.S. and other countries.

Nuance and PaperPort are trademarks or registered trademarks of Nuance Communications, Inc. or its affiliates in the United States and/or other countries.

Adobe®, Reader®, PostScript and PostScript 3 are either registered trademarks or trademarks of Adobe Systems Incorporated in the United States and/or other countries.

Wi-Fi®, Wi-Fi Alliance®, and Wi-Fi Direct® are registered trademarks of Wi-Fi Alliance®.

WPA™, WPA2™, WPA3™, Wi-Fi CERTIFIED, and Wi-Fi Protected Setup are trademarks of Wi-Fi Alliance®.

Android, Google Drive and Google Play are trademarks of Google LLC. Use of these trademarks is subject to Google Permissions.

Mopria™ and the Mopria™ Logo are registered and/or unregistered trademarks and service marks of Mopria Alliance, Inc. in the United States and other countries. Unauthorised use is strictly prohibited.

EVERNOTE is a trademark of Evernote Corporation and used under a license.

The Bluetooth® word mark is a registered trademark owned by Bluetooth SIG, Inc. and any use of such marks by Brother Industries, Ltd. is under license. Other trademarks and trade names are those of their respective owners.

Each company whose software title is mentioned in this manual has a Software Licence Agreement specific to its proprietary programs.

Software Trademarks

FlashFX® is a registered trademark of Datalight, Inc.

FlashFX® Pro™ is a trademark of Datalight, Inc.

FlashFX® Tera™ is a trademark of Datalight, Inc.

Reliance™ is a trademark of Datalight, Inc.

Reliance Nitro™ is a trademark of Datalight, Inc.

Datalight® is a registered trademark of Datalight, Inc.

Any trade names and product names of companies appearing on Brother products, related documents and any other materials are all trademarks or registered trademarks of those respective companies.



Related Information

- [Before You Use Your Machine](#)

Open Source Licensing

This product includes open source software.

To view Open Source Licensing Remarks and Copyright Information, go to your model's **Manuals** page at support.brother.com/manuals.



Related Information

- [Before You Use Your Machine](#)
-

Copyright and License

©2023 Brother Industries, Ltd. All rights reserved.

This product includes software developed by the following vendors:

This product includes the "KASAGO TCP/IP" software developed by ZUKEN ELMIC, Inc.

Copyright 1989-2020 Datalight, Inc., All Rights Reserved.

FlashFX® Copyright 1998-2020 Datalight, Inc.



Related Information

- [Before You Use Your Machine](#)

Important Notes

- Check support.brother.com/downloads for Brother driver and software updates.
- To keep your machine performance up to date, check support.brother.com/downloads for the latest firmware upgrade. Otherwise, some of your machine's functions may not be available.
- Do not use this product outside the country of purchase as it may violate the wireless telecommunication and power regulations of that country.
- Not all models are available in all countries.
- Before giving your machine to anyone else, replacing it, or disposing of it, we strongly recommend resetting it to its factory settings to remove all personal information.
- Windows 10 in this document represents Windows 10 Home, Windows 10 Pro, Windows 10 Education, and Windows 10 Enterprise.
- Windows 11 in this document represents Windows 11 Home, Windows 11 Pro, Windows 11 Education, and Windows 11 Enterprise.
- In this User's Guide, the LCD messages of the MFC-L2800DW/MFC-L2860DW are used unless otherwise specified.
- In this User's Guide, the illustrations of the MFC-L2860DW are used unless otherwise specified.
- The screens or images in this User's Guide are for illustration purposes only and may differ from those of the actual products.
- Unless otherwise specified, the screens in this manual are from Windows 10. Screens on your computer may vary depending on your operating system.
- The contents of this document and the specifications of this product are subject to change without notice.
- Not all features are available in countries subject to applicable export restrictions.



Related Information

- [Before You Use Your Machine](#)

Introduction to Your Machine

- [Before Using Your Machine](#)
- [Control Panel Overview](#)
- [Touchscreen LCD Overview](#)
- [How to Navigate the Touchscreen LCD](#)
- [Set the Main Home Screen](#)
- [Settings Screen Overview](#)
- [How to Enter Text on Your Machine](#)
- [Access Brother Utilities \(Windows\)](#)
- [Access Brother iPrint&Scan \(Windows/Mac\)](#)
- [Input/Output Port Locations on Your Machine](#)

Before Using Your Machine

Before attempting any printing operation, confirm the following:

- Make sure you have installed the correct software and drivers for your machine.
- For USB or network cable users: Make sure the interface cable is physically secure.

Firewall (Windows)

If your computer is protected by a firewall and you are unable to network print, network scan, or PC-FAX, you may need to configure the firewall settings. If you are using the Windows Firewall and you installed the drivers using the steps in the installer, the necessary firewall settings have been already set. If you are using any other personal firewall software, see the User's Guide for your software or contact the software manufacturer.



Related Information

- [Introduction to Your Machine](#)
-

Control Panel Overview

The control panel may vary depending on your model.

- >> MFC-L2802DN/MFC-L2800DW/MFC-L2802DW/MFC-L2827DWXL/MFC-L2827DW/MFC-L2835DW
- >> DCP-L2600D/DCP-L2620DW/DCP-L2622DW/DCP-L2627DW/DCP-L2627DWXL/DCP-L2627DWE/DCP-L2640DN
- >> DCP-L2660DW/DCP-L2665DW/MFC-L2860DWE/MFC-L2860DW/MFC-L2862DW/MFC-L2922DW/MFC-L2960DW/MFC-L2980DW

MFC-L2802DN/MFC-L2800DW/MFC-L2802DW/MFC-L2827DWXL/MFC-L2827DW/MFC-L2835DW

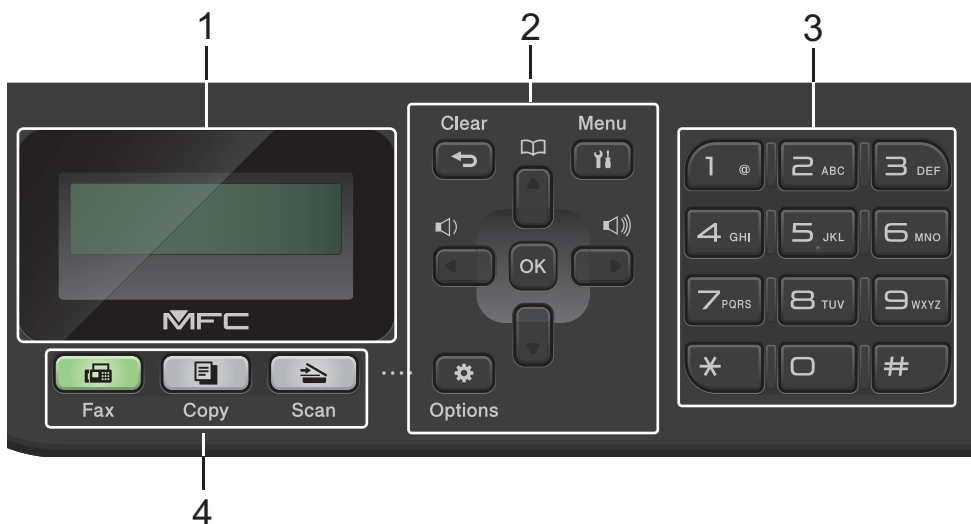

1. Liquid Crystal Display (LCD)

Displays messages to help you set up and use the machine.

If the machine is in Fax Mode, the LCD displays:

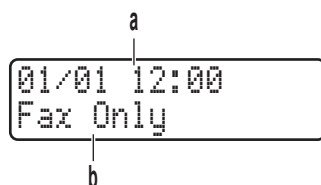

- a. Date & Time
- b. Receive Mode

When you press **Copy**, the LCD displays:

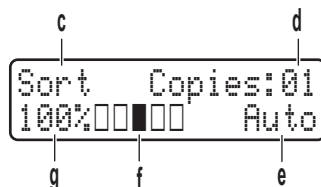

- c. Type of copy
- d. Number of copies
- e. Quality
- f. Contrast
- g. Copy ratio

2. Menu Buttons

Clear

Press to delete entered data or cancel the current setting.

Menu

Press to access the Menu to program your machine settings.

OK

Press to store your machine's settings.

◀ or ▶

Press to scroll back or forward through menu selections.

▲ or ▼

- Press to scroll up or down through menus and options.
- Press to change the resolution in Fax Mode.



Press  to access speed dial numbers.

Options

Press to access temporary settings for faxing, scanning, or copying.

3. Dial Pad

- Use to dial fax and telephone numbers.
- Use as a keyboard to enter text or characters.

4. Mode Buttons

Fax

Press to switch the machine to Fax Mode.

Copy

Press to switch the machine to Copy Mode.

Scan

Press to switch the machine to Scan Mode.

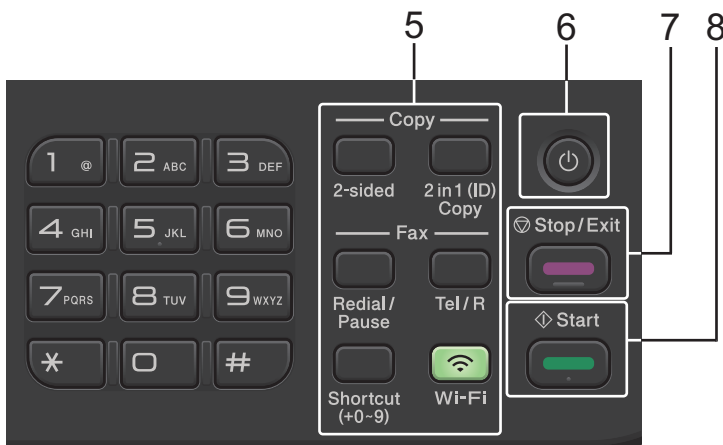

5. Function Buttons

Redial/Pause

Press to dial the last number you called. This button also inserts a pause when programming quick dial numbers or when dialling a number manually.

Tel/R

Press **Tel/R** to have a telephone conversation after picking up the external handset during the F/T fast double-ring.

When connected to a Private Branch exchanger (PBX), use this button to gain access to an outside line, to recall an operator, or to transfer a call to another extension.

Wi-Fi (for wireless models)

Press and hold the **Wi-Fi** button and launch the wireless installer on your computer. Follow the on-screen instructions to set up a wireless connection between your machine and your network.

When the **Wi-Fi** light is on, your machine is connected to a wireless access point. When the **Wi-Fi** light blinks, the wireless connection is down, or your machine is in the process of connecting to a wireless access point.

Resolution (for certain models only)

Press to change the Fax resolution.

2 in 1 (ID) Copy

Press to copy both sides of an identification card onto a single page.

2-sided



Press to copy on both sides of a sheet of paper.

Shortcut Button

Store and recall up to ten fax and telephone numbers.

To access stored Shortcut fax and telephone numbers, hold down the **Shortcut** button and then press the Shortcut number you assigned to the fax or telephone number, using the dial pad.

6. Power On/Off

- Turn the machine on by pressing .
- Turn the machine off by pressing and holding . The LCD displays [Shutting Down] and stays on for a few seconds before turning off. If you have an external telephone or TAD connected, it is always available.

7. Stop/Exit

- Press to stop an operation.
- Press to exit from a menu.

8. Start

- Press to start sending faxes.
- Press to start copying.
- Press to start scanning documents.

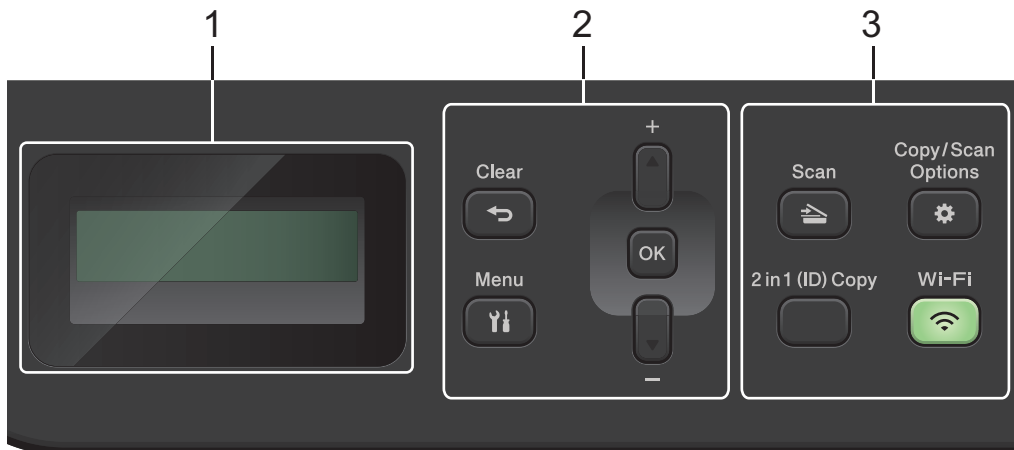

1. Liquid Crystal Display (LCD)

Displays messages to help you set up and use the machine.

If the machine is in Ready Mode or Copy Mode, the LCD displays:

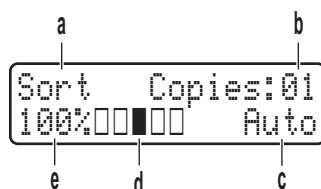

- a. Type of copy
- b. Number of copies
- c. Quality
- d. Contrast
- e. Copy ratio

2. Menu Buttons

Menu

Press to access the menu for programming your machine's settings.

Clear

- Press to delete entered data.
- Press to cancel the current setting.

OK

Press to store your machine's settings.

▲ or ▼

Press to scroll up or down through menus and options.

3. Function Buttons

Copy/Scan Options

Press to access temporary settings for scanning or copying.

Wi-Fi (for wireless models)

Press and hold the **Wi-Fi** button and launch the wireless installer on your computer. Follow the on-screen instructions to set up a wireless connection between your machine and your network.

When the **Wi-Fi** light is on, your machine is connected to a wireless access point. When the **Wi-Fi** light blinks, the wireless connection is down, or your machine is in the process of connecting to a wireless access point.

Scan

Press to switch the machine to Scan Mode.

2 in 1 (ID) Copy

Press to copy both sides of an identification card onto a single page.

2-sided (for certain models only)

Press to copy on both sides of a sheet of paper.

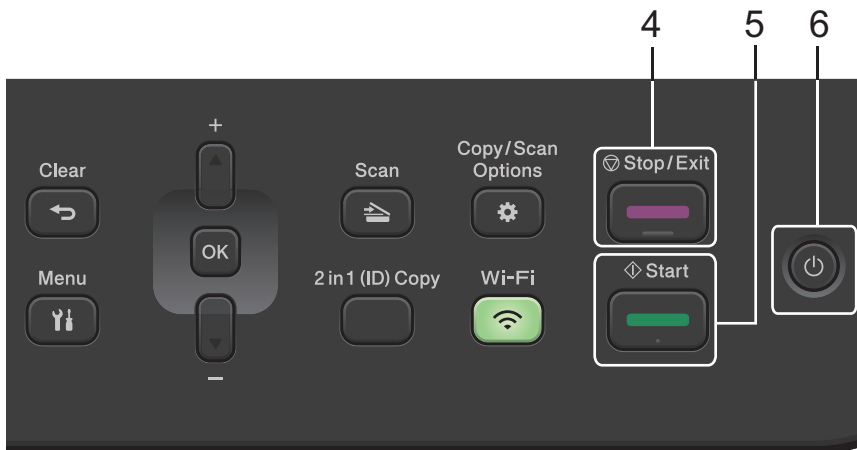

4. Stop/Exit

- Press to stop an operation.
- Press to exit from a menu.

5. Start

- Press to start copying.
- Press to start scanning documents.

6. Power On/Off

- Turn the machine on by pressing .
- Turn the machine off by pressing and holding . The LCD displays [Shutting Down] and stays on for a few seconds before turning off.

**DCP-L2660DW/DCP-L2665DW/MFC-L2860DWE/MFC-L2860DW/MFC-L2862DW/
MFC-L2922DW/MFC-L2960DW/MFC-L2980DW**

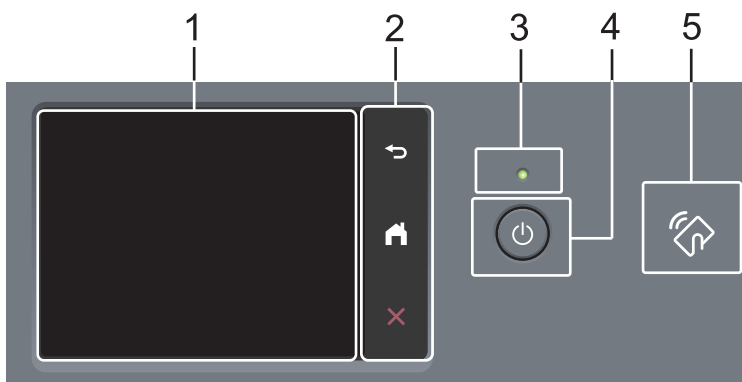

1. Touchscreen Liquid Crystal Display (LCD)

Access menus and options by pressing them on the touchscreen.

2. Touchpanel



Press to go back to the previous menu.

 **(Home)**

Press to return to the Home screen.



 **(Cancel)**

Press to cancel an operation.

3. LED Power Indicator

The LED lights up depending on the machine's power status.

4.  Power On/Off

- Turn the machine on by pressing .
- Turn the machine off by pressing and holding down . The touchscreen LCD displays [Shutting Down] and stays on for a few seconds before turning off. If you have an external telephone or TAD connected, it is always available.

5. Near Field Communication (NFC) (MFC-L2922DW/MFC-L2980DW)

Use card authentication, if applicable, by touching your Integrated Circuit Card (IC Card) to the NFC symbol on the machine.

 **Related Information**

- [Introduction to Your Machine](#)
-

Touchscreen LCD Overview

Related Models: DCP-L2660DW/DCP-L2665DW/MFC-L2860DWE/MFC-L2860DW/MFC-L2862DW/MFC-L2922DW/MFC-L2960DW/MFC-L2980DW

When a Home screen is displayed, press ◀ or ▶ to display the other Home screens.

The Home screen displays the machine's status when the machine is idle. When displayed, this screen indicates that your machine is ready for the next command.



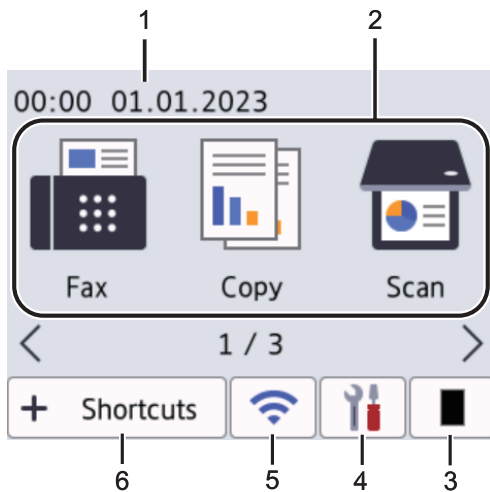



The available features will vary depending on your model.



1. Date & Time

Displays the date and time set on the machine.

2. Modes

-  **[Fax]**
Press to access Fax mode.
-  **[Copy]**
Press to access Copy mode.
-  **[Scan]**
Press to access Scan mode.
-  **[Secure Print]**
Press to access the Secure Print option.
-  **[Web]**
Press to connect the Brother machine to an Internet service.
-  **[Apps]**
Press to connect the Brother machine to the Brother Apps service.
-  **[2 in 1 ID Copy]**
Press to access 2in1(ID) Copy option.

3. Toner

Displays the remaining toner life. Press to access the Toner menu.

4.  [Settings]

Press to access the Settings menu.

If Setting Lock has been turned on, a lock  icon appears on the LCD. You must unlock the machine to use Settings.

5. 

(Wireless Status for wireless models)

Press to configure wireless settings.

If you are using a wireless connection, a four-level indicator in each of the Home screens displays the current wireless signal strength.



6.  [Shortcuts]

Press to create Shortcuts for frequently-used operations, such as sending a fax, making a copy, scanning, and using Web Connect.



Three Shortcuts tabs are available with six Shortcuts on each Shortcuts tab. A total of 18 Shortcuts are available.

Stored Fax(es)

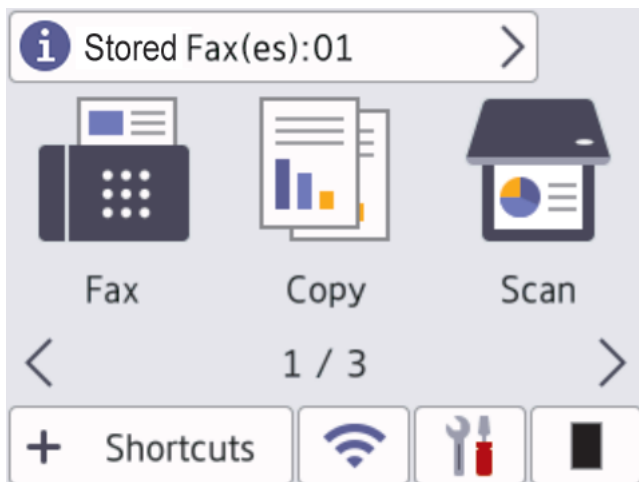



The number of received faxes in memory appears at the top of the screen.

Press , and then press [Yes] to print the faxes.

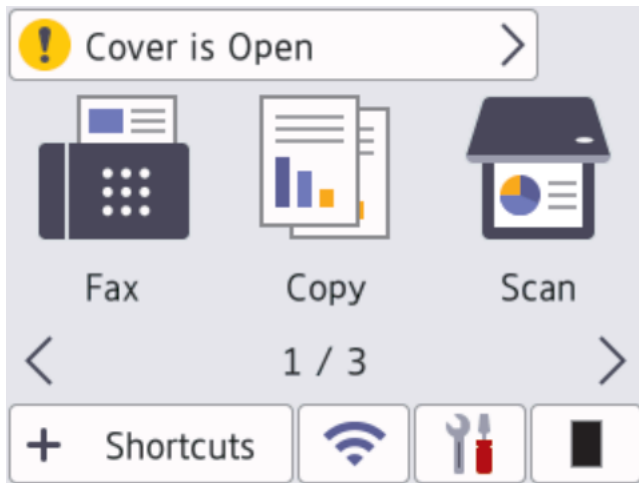
Warning icon



The warning icon  appears when there is an error or maintenance message; press the message area to view it, and then press  to return to Ready Mode.

NOTE

This product adopts the font of ARPHIC TECHNOLOGY CO., LTD.

Related Information

- [Introduction to Your Machine](#)
-

How to Navigate the Touchscreen LCD

Related Models: DCP-L2660DW/DCP-L2665DW/MFC-L2860DWE/MFC-L2860DW/MFC-L2862DW/MFC-L2922DW/MFC-L2960DW/MFC-L2980DW

Press your finger on the LCD to operate it. To display and access all the options, press ◀▶ or ▲▼ on the LCD to scroll through them.

The following steps explain how to navigate through changing a machine setting. In this example, the LCD Backlight setting is changed from [Light] to [Med].

IMPORTANT

DO NOT press the LCD with a sharp object such as a pen or stylus. It may damage the machine.

NOTE

DO NOT touch the LCD immediately after plugging in the power cord or turning on the machine. Doing this may cause an error.

1. Press  ([Settings]).
2. Press [All Settings].
3. Press ▲ or ▼ to display the [General Setup] option, and then press [General Setup].

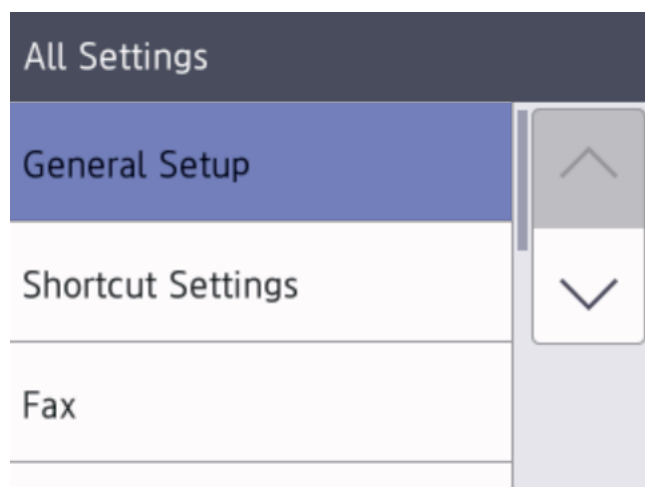

4. Press ▲ or ▼ to display the [LCD Settings] option, and then press [LCD Settings].

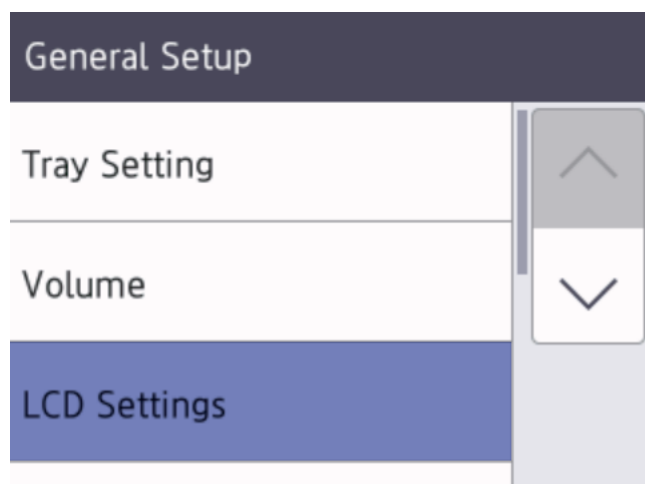

5. Press [Backlight].

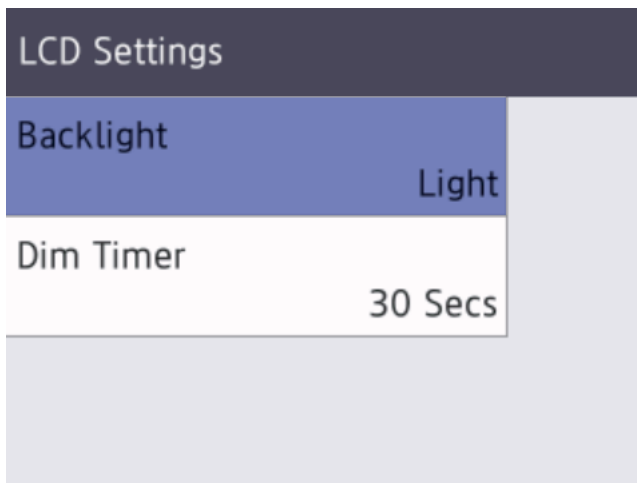

6. Press [Med].

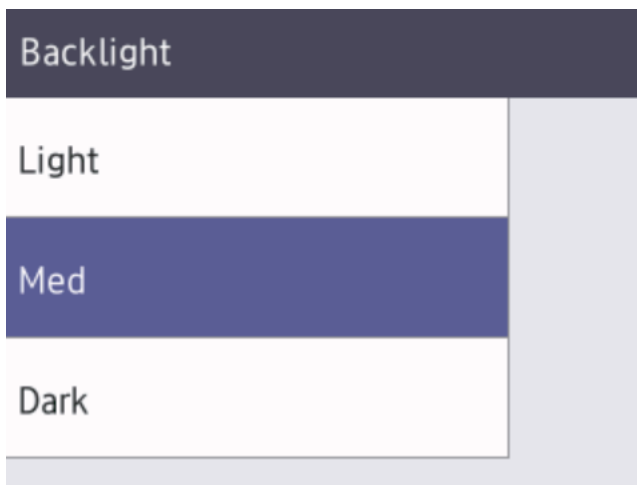

7. Press .

Related Information



- [Introduction to Your Machine](#)

Set the Main Home Screen

Related Models: DCP-L2660DW/DCP-L2665DW/MFC-L2860DWE/MFC-L2860DW/MFC-L2862DW/MFC-L2922DW/MFC-L2960DW/MFC-L2980DW

You can change the LCD to display a specific Home screen or Shortcut screen.

When the machine is idle or you press , the touchscreen will return to the screen you set.

1. Press  [Settings] > [All Settings] > [General Setup] > [Screen Settings] > [Home Screen].
2. Press ▲ or ▼ to display the screen settings, and then press the setting you want.
3. Press .

The LCD displays the screen you selected. You can change this main screen as needed.



Related Information

- [Introduction to Your Machine](#)

Settings Screen Overview

Related Models: DCP-L2660DW/DCP-L2665DW/MFC-L2860DWE/MFC-L2860DW/MFC-L2862DW/MFC-L2922DW/MFC-L2960DW/MFC-L2980DW

Press  to view the current machine status on the LCD.

Use the Settings menu to access all of your machine's settings.



1. Toner

- Displays the remaining toner life.
- Press to access the [Toner] menu.

2. Tray Setting

Press to change the paper size and paper type settings.

3. Eco Mode

Press to access the [Eco Mode] menu.

4. Network

- Press to set up a network connection.
- A four-level indicator on the screen displays the current wireless signal strength if you are using a wireless connection.

5. Fax Preview or Wi-Fi Direct

- Fax Preview (MFC-L2860DWE/MFC-L2860DW/MFC-L2862DW/MFC-L2922DW/MFC-L2960DW/MFC-L2980DW)
Press to access the [Fax Preview] menu.
- Wi-Fi Direct (DCP-L2660DW/DCP-L2665DW)
Press to set up a Wi-Fi Direct® network connection.

6. All Settings

Press to access the menu of all machine settings.

✓ Related Information

- [Introduction to Your Machine](#)

How to Enter Text on Your Machine

>> DCP-L2600D/DCP-L2620DW/DCP-L2622DW/DCP-L2627DW/DCP-L2627DWXL/DCP-L2627DWE/
DCP-L2640DN
>> MFC-L2802DN/MFC-L2800DW/MFC-L2802DW/MFC-L2827DWXL/MFC-L2827DW/MFC-L2835DW
>> DCP-L2660DW/DCP-L2665DW/MFC-L2860DWE/MFC-L2860DW/MFC-L2862DW/MFC-L2922DW/
MFC-L2960DW/MFC-L2980DW

DCP-L2600D/DCP-L2620DW/DCP-L2622DW/DCP-L2627DW/DCP-L2627DWXL/ DCP-L2627DWE/DCP-L2640DN

When text is required, enter characters on the machine. The characters that are available may differ depending on the operation you perform.

- Hold down or repeatedly press ▲ or ▼ to select a character from this list:
0123456789abcdefghijklmnopqrstuvwxyzABCDEFGHIJKLMNOPQRSTUVWXYZ(space)!"#\$%&'()*+,-./:;<=>?
@[^_`{|}~
- Press **OK** when the character or symbol you want is displayed, and then enter the next character.
- Press **Clear** to delete characters entered incorrectly.

MFC-L2802DN/MFC-L2800DW/MFC-L2802DW/MFC-L2827DWXL/MFC-L2827DW/ MFC-L2835DW

When text is required, enter characters on the machine. The characters that are available may differ depending on the operation you perform.

The buttons 0, # and * are used for special characters.

(For Cyrillic letters) The buttons # and * are used for special characters.

- Press the appropriate dial pad button the number of times shown in this reference table to access the character you want.

| Press button | One time | Two times | Three times | Four times | Five times | Six times | Seven times | Eight times | Nine times |
|--------------|----------|-----------|-------------|------------|------------|-----------|-------------|-------------|------------|
| 1 | @ | . | / | 1 | @ | . | / | 1 | @ |
| 2 | a | b | c | A | B | C | 2 | a | b |
| 3 | d | e | f | D | E | F | 3 | d | e |
| 4 | g | h | i | G | H | I | 4 | g | h |
| 5 | j | k | l | J | K | L | 5 | j | k |
| 6 | m | n | o | M | N | O | 6 | m | n |
| 7 | p | q | r | s | P | Q | R | S | 7 |
| 8 | t | u | v | T | U | V | 8 | t | u |
| 9 | w | x | y | z | W | X | Y | Z | 9 |

(For Cyrillic letters)

| Press button | One time | Two times | Three times | Four times | Five times | Six times | Seven times | Eight times | Nine times | Ten times | Eleven times | Twelve times | Thirteen times |
|--------------|----------|-----------|-------------|------------|------------|-----------|-------------|-------------|------------|-----------|--------------|--------------|----------------|
| 2 | A | B | C | a | b | c | A | Б | В | Г | 2 | A | B |
| 3 | D | E | F | d | e | f | Д | Е | Ё | Ж | 3 | D | E |
| 4 | G | H | I | g | h | i | 3 | И | Й | К | 4 | G | H |
| 5 | J | K | L | j | k | l | Л | М | Н | О | 5 | J | K |

| Press button | One time | Two times | Three times | Four times | Five times | Six times | Seven times | Eight times | Nine times | Ten times | Eleven times | Twelve times | Thirteen times |
|--------------|----------|-----------|-------------|------------|------------|-----------|-------------|-------------|------------|-----------|--------------|--------------|----------------|
| 6 | M | N | O | m | n | o | П | P | C | T | 6 | M | N |
| 7 | P | Q | R | S | p | q | r | s | У | Ф | X | Ц | 7 |
| 8 | T | U | V | t | u | v | Ч | Ш | Щ | Ъ | Ы | 8 | T |
| 9 | W | X | Y | Z | w | x | y | z | Ь | Э | Ю | Я | 9 |



- **Inserting spaces**
To enter a space in a fax number, press ► once between numbers. To enter a space in a name, press ► twice between characters.
- **Making corrections**
If you entered a character incorrectly and want to change it, press ◀ or ▶ to move the cursor to the incorrect character, and then press **Clear**.
- **Repeating letters**
To enter a letter on the same button as the previous letter, press ► to move the cursor right before pressing the button again.
- **Special symbols and characters**
Press *, # or 0, then press ◀ or ▶ to move the cursor to the symbol or character you want. Press **OK** to select it. The symbols and characters that are available on dial pad buttons are shown in the table.

| | |
|----------------------------------------------|------------------------------------------|
| Press * | (space) ! " # \$ % & ' () * + , - . / € |
| Press # | :: < = > ? @ [] ^ _ \ ~ ' { } |
| Press 0 (Not available for Cyrillic letters) | Ä È Ö Ü À Ç È É 0 |

DCP-L2660DW/DCP-L2665DW/MFC-L2860DWE/MFC-L2860DW/MFC-L2862DW/MFC-L2922DW/MFC-L2960DW/MFC-L2980DW

- When you must enter text on your machine, a keyboard appears on the LCD.
- The characters that are available may differ depending on your country.
- The keyboard layout may differ depending on the operation you perform.





- Press  to cycle between letters, numbers, and special characters.
- Press  to cycle between lowercase and uppercase letters.
- To move the cursor to the left or right, press ◀ or ▶.

Inserting spaces

- To enter a space, press [Space].

Making corrections

- If you entered a character incorrectly and want to change it, press ◀ or ▶ to move the cursor to the incorrect character and press . Enter the correct character.
- To insert a character, press ◀ or ▶ to move the cursor to the correct place, and then enter the character.
- Press  for each character you want to erase, or press and hold  to erase all the characters.



Related Information



- [Introduction to Your Machine](#)

Related Topics:

- [Configure Your Machine for a Wireless Network Using the Machine's Control Panel Setup Wizard](#)
 - [Configure Your Machine for a Wireless Network When the SSID Is Not Broadcast](#)
 - [Set Your Station ID](#)
 - [Set the Setting Lock Password](#)
 - [Register an Account on Your Brother Machine for Brother Web Connect](#)
 - [Download and Print Using Web Services](#)
-

Access Brother Utilities (Windows)

Brother Utilities is an application launcher that offers convenient access to all Brother applications installed on your computer.

1. Do one of the following:
 - (Windows 11)
Click  > **All apps** > **Brother** > **Brother Utilities**.
 - (Windows 10)
Click  > **Brother** > **Brother Utilities**.
2. Select your machine.

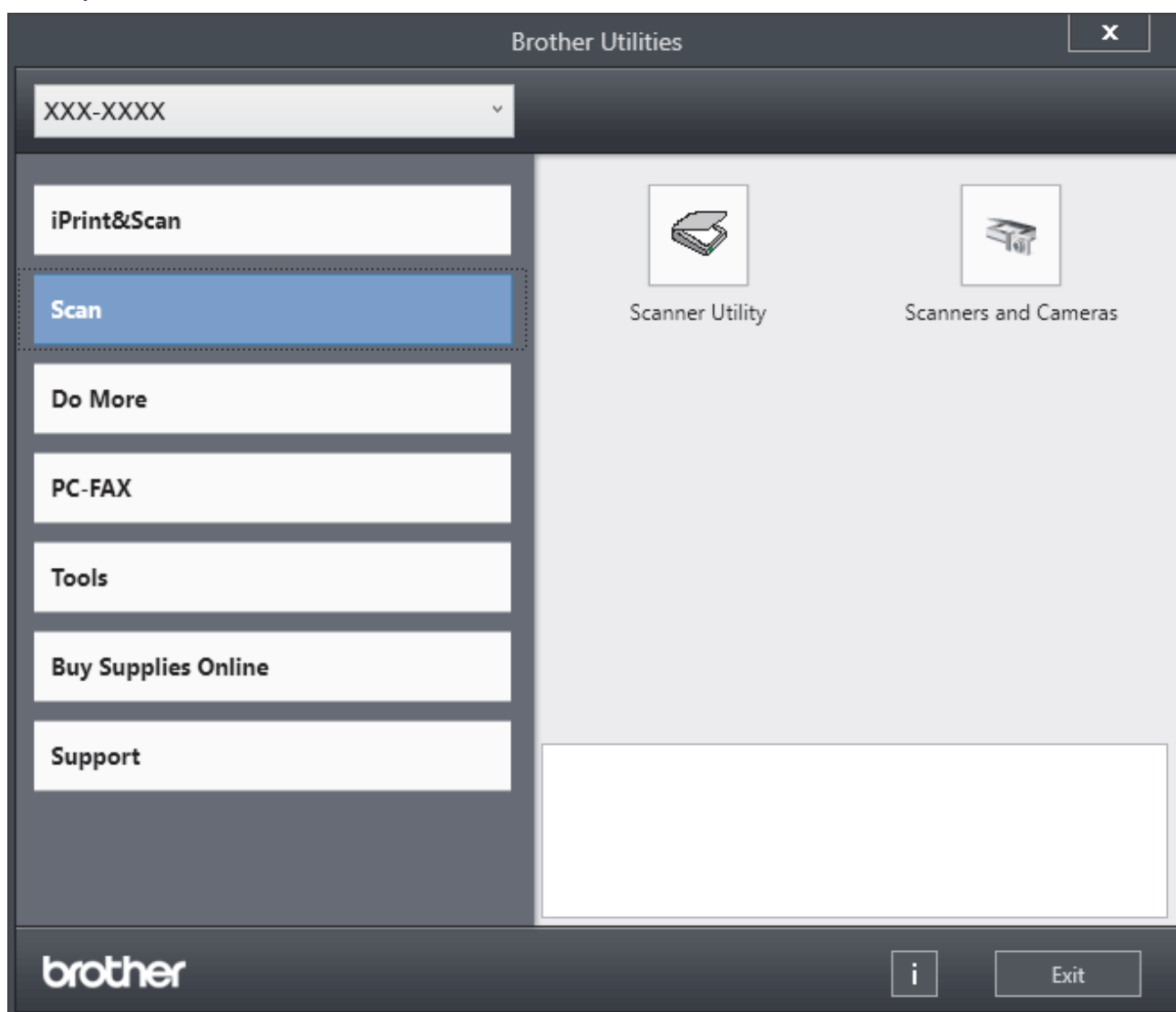



3. Choose the option you want.

✓ Related Information

- [Introduction to Your Machine](#)
 - [Uninstall the Software and Drivers \(Windows\)](#)

Uninstall the Software and Drivers (Windows)

1. Do one of the following:
 - Windows 11
Click  > **All apps** > **Brother** > **Brother Utilities**.
 - Windows 10
Click  > **Brother** > **Brother Utilities**.
2. Select your model from the drop-down list (if it is not already selected).
3. Click **Tools** in the left navigation bar.
 - If the **Software Update Notification** icon is visible, select it, and then click **Check now** > **Check for Software Updates** > **Update**. Follow the on-screen instructions.
 - If the **Software Update Notification** icon is not visible, go to the next step.
4. Click **Uninstall** in the **Tools** section of **Brother Utilities**.
Follow the instructions in the dialog box to uninstall the software and drivers.

Related Information

- [Access Brother Utilities \(Windows\)](#)

Access Brother iPrint&Scan (Windows/Mac)

Use Brother iPrint&Scan for Windows and Mac to print and scan from your computer.

- This function is not available in countries subject to applicable export regulations.
 - **To download the latest version:**
 - For Windows:
Go to your model's **Downloads** page at support.brother.com/downloads, and then download and install Brother iPrint&Scan.
 - For Mac: (DCP-L2620DW/DCP-L2622DW/DCP-L2627DW/DCP-L2627DWXL/DCP-L2627DWE/DCP-L2640DN/DCP-L2660DW/DCP-L2665DW/MFC-L2802DN/MFC-L2800DW/MFC-L2802DW/MFC-L2827DWXL/MFC-L2827DW/MFC-L2835DW/MFC-L2860DWE/MFC-L2860DW/MFC-L2862DW/MFC-L2922DW/MFC-L2960DW/MFC-L2980DW)
Download and install Brother iPrint&Scan from the Apple App Store.
- If prompted, install the driver and software necessary to use your machine. Download your machine's latest driver and software from your model's **Downloads** page at support.brother.com/downloads.

1. Start Brother iPrint&Scan.

- Windows

Double-click the  (Brother iPrint&Scan) icon

- Mac

In the **Finder** menu bar, click **Go > Applications**, and then double-click the iPrint&Scan icon.

The Brother iPrint&Scan screen appears.

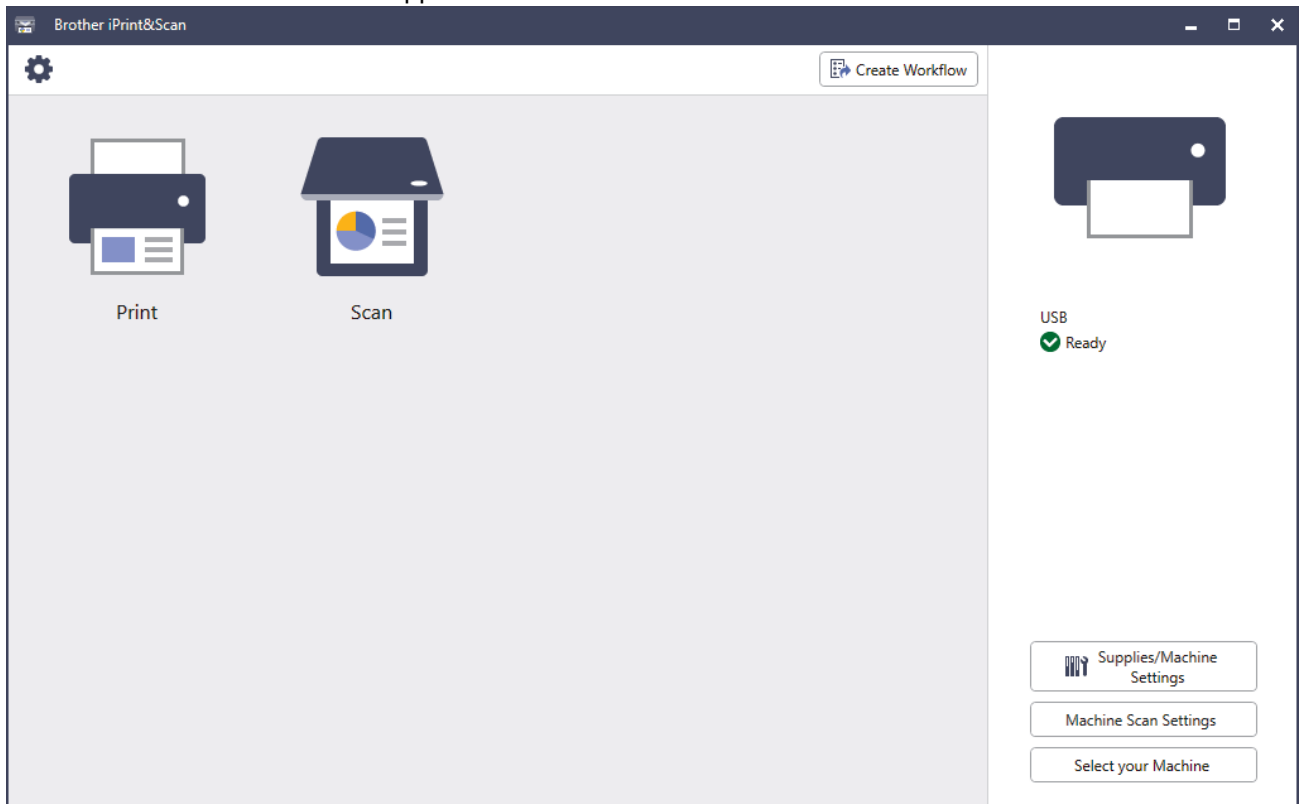

The actual screen may differ depending on the version of the application.

✓ Related Information

- [Introduction to Your Machine](#)

Related Topics:

- [Brother Mobile Connect](#)
 - [Scan Using Brother iPrint&Scan \(Windows/Mac\)](#)
 - [Change the Scan Button Settings from Brother iPrint&Scan](#)
-

Input/Output Port Locations on Your Machine

The input/output ports are located on the front and back of the machine.

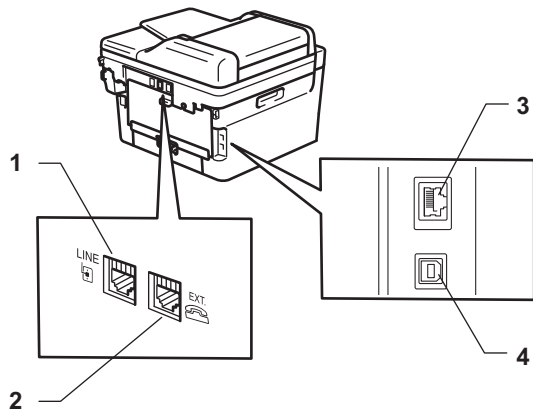

1. LINE socket(For MFC models)
2. EXT. socket(For MFC models)
3. 10BASE-T / 100BASE-TX port (For network models)
4. USB port

When connecting the USB or network cable, follow the instructions in the software/driver installer.

To install driver and software necessary for operating your machine, go to your model's **Downloads** page at support.brother.com/downloads.



Related Information

- [Introduction to Your Machine](#)

Paper Handling

- [Load Paper](#)
- [Paper Settings](#)
- [Recommended Print Media](#)
- [Load Documents](#)
- [Unscannable and Unprintable Areas](#)
- [Using Special Paper](#)

Load Paper

- Load Paper in the Paper Tray
- Load and Print Plain Paper, Thin Paper, Recycled Paper and Bond Paper in the Manual Feed Slot
- Load and Print on Thick Paper and Labels Using the Manual Feed Slot
- Load and Print on Envelopes in the Manual Feed Slot

Load Paper in the Paper Tray

- If, when the Check Paper setting is set to On and you pull the paper tray out of the machine, a message appears on the LCD asking if you want to change the paper size and paper type, change these settings, if needed, following the LCD instructions.
- When you load a different size and type of paper in the tray, you must also change the Paper Size and Paper Type settings on the machine, or on your computer.

1. Pull the paper tray completely out of the machine.

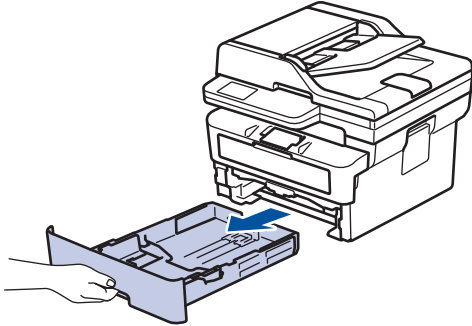

2. Press and slide the paper guides to fit the paper.
Press the green release levers to slide the paper guides.

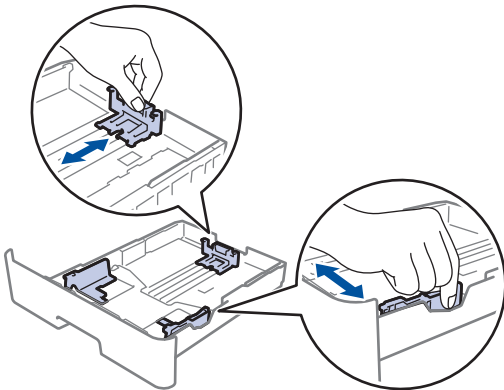

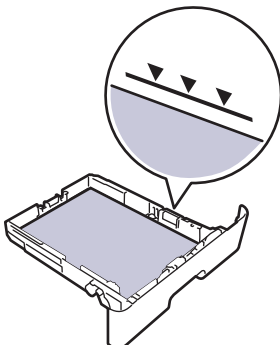

3. Fan the stack of paper well.
4. Load paper in the paper tray with the printing surface *face down*.
5. Make sure the paper is below the maximum paper mark (▼▼▼).
Overfilling the paper tray will cause paper jams.

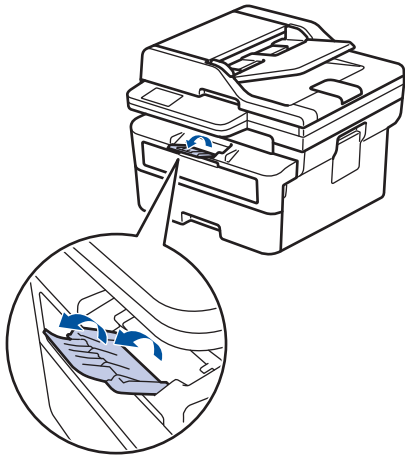

6. Slowly push the paper tray completely into the machine.

7. Lift the support flap to prevent paper from sliding off the output tray.



 **Related Information**

- [Load Paper](#)
 - [Change Machine Settings to Print on Preprinted Paper Using the Paper Tray](#)
-

Change Machine Settings to Print on Preprinted Paper Using the Paper Tray

When you use preprinted paper for 2-sided printing, change the machine's settings.



- DO NOT load different sizes and types of paper in the paper tray at the same time. Doing this may cause the paper to jam or misfeed.
- If the print position is misaligned with the preprinted objects, the print position is adjustable using the Print Position setting for the paper tray.
- Some preprinted paper may cause print stains, depending on the printing method and ink type.

Orientation

| | |
|--|----------------------------------------------------------------------------------------------------------------------------------------------------------------------------------|
| | <p>For 1-sided printing</p> <ul style="list-style-type: none"> • face down • top edge towards the front of the paper tray |
| | <p>For automatic 2-sided printing (long edge binding)</p> <ul style="list-style-type: none"> • face up • bottom edge towards the front of the paper tray |

>> DCP-L2600D/DCP-L2620DW/DCP-L2622DW/DCP-L2627DW/DCP-L2627DWXL/DCP-L2627DWE/
DCP-L2640DN/MFC-L2802DN/MFC-L2800DW/MFC-L2802DW/MFC-L2827DWXL/MFC-L2827DW/
MFC-L2835DW

>> DCP-L2660DW/DCP-L2665DW/MFC-L2860DWE/MFC-L2860DW/MFC-L2862DW/MFC-L2922DW/
MFC-L2960DW/MFC-L2980DW

**DCP-L2600D/DCP-L2620DW/DCP-L2622DW/DCP-L2627DW/DCP-L2627DWXL/
DCP-L2627DWE/DCP-L2640DN/MFC-L2802DN/MFC-L2800DW/MFC-L2802DW/
MFC-L2827DWXL/MFC-L2827DW/MFC-L2835DW**

1. Press **Menu**.
2. Press **▲** or **▼** to select the following:
 - a. Select [Printer]. Press **OK**.
 - b. Select [2-sided]. Press **OK**.
 - c. Select [Single Image]. Press **OK**.
 - d. Select [2-sided Feed]. Press **OK**.
3. Press **Stop/Exit**.

**DCP-L2660DW/DCP-L2665DW/MFC-L2860DWE/MFC-L2860DW/MFC-L2862DW/
MFC-L2922DW/MFC-L2960DW/MFC-L2980DW**

1. Press  [Settings] > [All Settings] > [Printer] > [2-sided] > [Single Image] > [2-sided Feed].

2. Press .



Related Information

- [Load Paper in the Paper Tray](#)
-

Load and Print Plain Paper, Thin Paper, Recycled Paper and Bond Paper in the Manual Feed Slot

When you load a different paper size in the tray, you must change the Paper Size setting in the machine or on your computer at the same time.

1. Lift the support flap to prevent paper from sliding off the face down output tray.

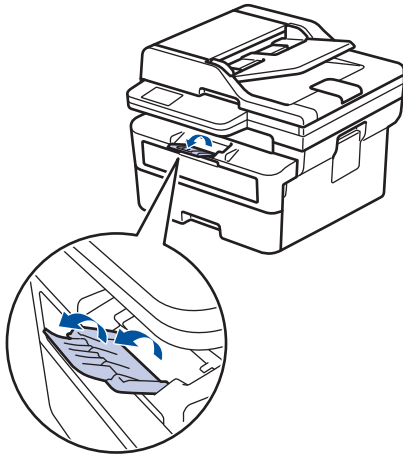

2. Open the manual feed slot cover.

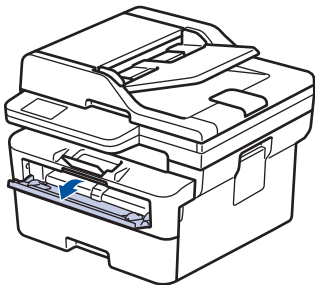

3. Use both hands to slide the manual feed slot paper guides to fit the width of the paper you are using.

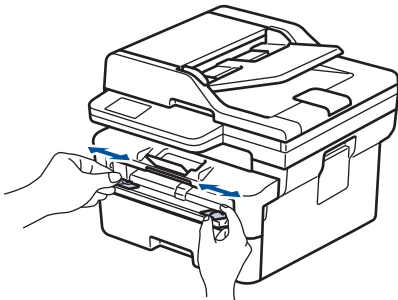

4. Using both hands, place one sheet of paper in the manual feed slot until the front edge touches the paper feed roller. When you feel the machine pull it in, let go.

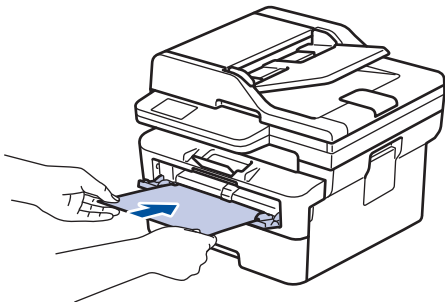



- Load paper into the manual feed slot with the printing surface *facing up*.
- Make sure the paper is straight and in the correct position in the manual feed slot. If it is not, the paper may not be fed correctly, resulting in a skewed printout or a paper jam.
- To remove a small printout from the output tray, use both hands to lift up the scanner cover.

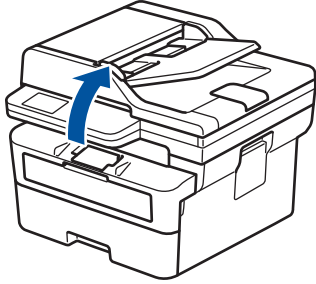

- You can still use the machine while the scanner cover is up. To close the scanner cover, gently push it down with both hands.

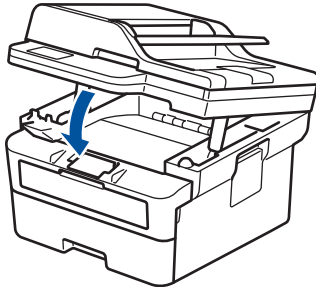

5. Send your print job to the machine.



Change your print preferences in the Print screen.

6. After the printed page comes out from the machine, load the next sheet of paper in the manual feed slot. Repeat for each page that you want to print.



Related Information

- [Load Paper](#)

Load and Print on Thick Paper and Labels Using the Manual Feed Slot

When you load a different paper size in the tray, you must change the Paper Size setting in the machine or on your computer at the same time.

1. Open the machine's back cover (the face up output tray).

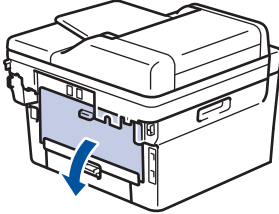

 The machine automatically turns on Manual Feed mode when you load paper in the manual feed slot.

2. On the front of the machine, open the manual feed slot cover.

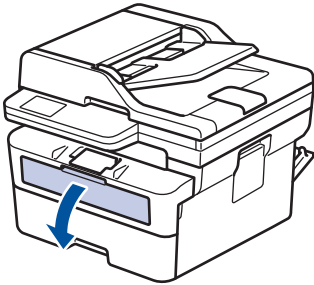

3. Use both hands to slide the manual feed slot paper guides to fit the width of the paper that you are using.

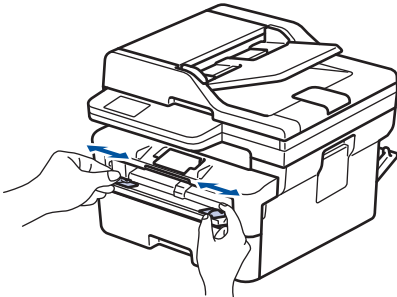

4. Using both hands, place one sheet of paper in the manual feed slot until the front edge touches the paper feed roller. When you feel the machine pull it in, let go.

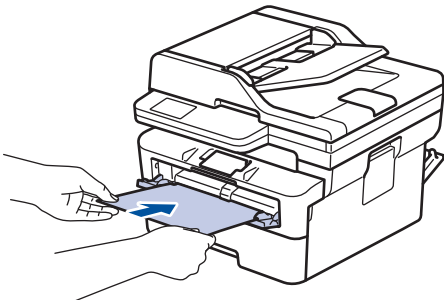

- 
- Load paper into the manual feed slot with the printing surface *facing up*.
 - Pull the paper out completely if you must reload the paper into the manual feed slot.
 - Do not put more than one sheet of paper in the manual feed slot at one time, as it may cause a jam.
 - Make sure the paper is straight and in the correct position in the manual feed slot. If it is not, the paper may not be fed correctly, resulting in a skewed printout or a paper jam.

5. Send your print job to the machine.



Change your print preferences in the Print screen.

6. After the printed page comes out from the back of the machine, load the next sheet of paper in the manual feed slot. Repeat for each page that you want to print.
7. When finished, close the back cover (the face up output tray) until it locks in the closed position.



Related Information

- [Load Paper](#)
-

Load and Print on Envelopes in the Manual Feed Slot

Before loading, press the corners and sides of the envelopes to make them as flat as possible.

When you load a different paper size in the tray, you must change the Paper Size setting in the machine or on your computer at the same time.

1. Open the machine's back cover (the face up output tray).

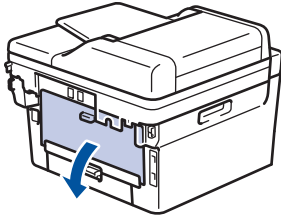

 The machine automatically turns on Manual Feed mode when you load paper in the manual feed slot.

2. Pull down the two green levers as shown in the illustration (applicable to models with green levers).

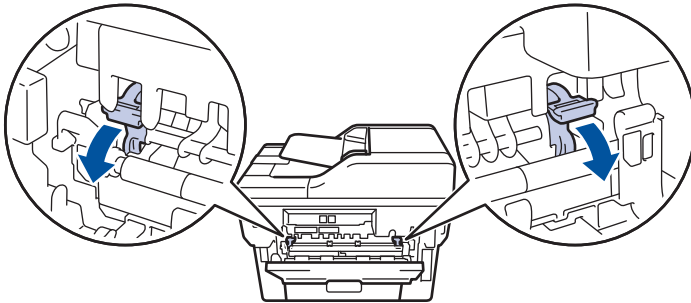

3. On the front of the machine, open the manual feed slot cover.

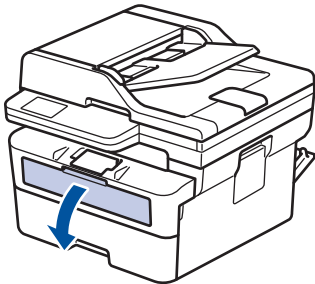

4. Use both hands to slide the manual feed slot paper guides to fit the width of the paper that you are using.

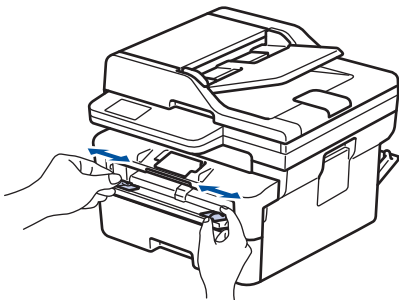

- Using both hands, put one envelope in the manual feed slot until the front edge touches the paper feed roller. When you feel the machine pull it in, let go.

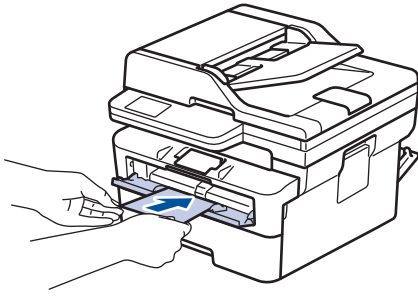

- Load the envelope into the manual feed slot with the printing surface *facing up*.
- Pull the envelope out completely when you reload the envelope into the manual feed slot.
- Do not put more than one envelope in the manual feed slot at one time, as it may cause a jam.
- Make sure the envelope is straight and in the correct position on the manual feed slot. If it is not, the envelope may not be fed correctly, resulting in a skewed printout or a paper jam.

- Send your print job to the machine.



Change your print preferences in the Print dialog box.

| Settings | Options for Envelopes |
|------------|--------------------------------------|
| Paper Size | Com-10 DL C5 Monarch |
| Media Type | Envelopes Env. Thick Env. Thin |

- After the printed envelope comes out of the machine, put in the next envelope. Repeat for each envelope that you want to print.
- When you finish printing, return the two green levers to their original position.
- When finished, close the back cover (the face up output tray) until it locks in the closed position.



Related Information

- [Load Paper](#)
- [Print](#)

Paper Settings

- [Change the Paper Size and Paper Type](#)
- [Change the Check Paper Setting](#)

Change the Paper Size and Paper Type

When you change the size and type of paper you load in the tray, you must also change the Paper Size and Paper Type settings on the LCD.

>> DCP-L2600D/DCP-L2620DW/DCP-L2622DW/DCP-L2627DW/DCP-L2627DWXL/DCP-L2627DWE/
DCP-L2640DN/MFC-L2802DN/MFC-L2800DW/MFC-L2802DW/MFC-L2827DWXL/MFC-L2827DW/
MFC-L2835DW

>> DCP-L2660DW/DCP-L2665DW/MFC-L2860DWE/MFC-L2860DW/MFC-L2862DW/MFC-L2922DW/
MFC-L2960DW/MFC-L2980DW

**DCP-L2600D/DCP-L2620DW/DCP-L2622DW/DCP-L2627DW/DCP-L2627DWXL/
DCP-L2627DWE/DCP-L2640DN/MFC-L2802DN/MFC-L2800DW/MFC-L2802DW/
MFC-L2827DWXL/MFC-L2827DW/MFC-L2835DW**

1. Press **Menu**.
2. Press **▲** or **▼** to display the [General Setup] option, and then press **OK**.
3. Press **▲** or **▼** to display the [Tray Setting] option, and then press **OK**.
4. Press **▲** or **▼** to display the [Paper Type] option, and then press **OK**.
5. Press **▲** or **▼** to display the [Thin Paper], [Plain Paper], [Thick Paper], or [Recycled Paper] option, and then press **OK**.
6. Press **▲** or **▼** to display the [Paper Size] option, and then press **OK**.
7. Press **▲** or **▼** to display the option you want, and then press **OK**.
8. Press **Stop/Exit**.

**DCP-L2660DW/DCP-L2665DW/MFC-L2860DWE/MFC-L2860DW/MFC-L2862DW/
MFC-L2922DW/MFC-L2960DW/MFC-L2980DW**

1. Press  [Settings] > [All Settings] > [General Setup] > [Tray Setting] > [Paper Type].
2. Press **▲** or **▼** to display the paper type options, and press the option you want.



The paper type may vary depending on your model.

3. Press [Paper Size].
4. Press **▲** or **▼** to display the paper size options, and press the option you want.
5. Press .

✓ Related Information

- [Paper Settings](#)

Change the Check Paper Setting

When the Check Paper setting is set to On and you pull the paper tray out of the machine, a message appears on the LCD asking if you want to change the paper size and paper type.



The default setting is On.

>> DCP-L2600D/DCP-L2620DW/DCP-L2622DW/DCP-L2627DW/DCP-L2627DWXL/DCP-L2627DWE/
DCP-L2640DN/MFC-L2802DN/MFC-L2800DW/MFC-L2802DW/MFC-L2827DWXL/MFC-L2827DW/
MFC-L2835DW
>> DCP-L2660DW/DCP-L2665DW/MFC-L2860DWE/MFC-L2860DW/MFC-L2862DW/MFC-L2922DW/
MFC-L2960DW/MFC-L2980DW

**DCP-L2600D/DCP-L2620DW/DCP-L2622DW/DCP-L2627DW/DCP-L2627DWXL/
DCP-L2627DWE/DCP-L2640DN/MFC-L2802DN/MFC-L2800DW/MFC-L2802DW/
MFC-L2827DWXL/MFC-L2827DW/MFC-L2835DW**

1. Press **Menu**.
2. Press **▲** or **▼** to display the [General Setup] option, and then press **OK**.
3. Press **▲** or **▼** to display the [Tray Setting] option, and then press **OK**.
4. Press **▲** or **▼** to display the [Check Paper] option, and then press **OK**.
5. Press **▲** or **▼** to select the [On] or [Off] option, and then press **OK**.
6. Press **Stop/Exit**.

**DCP-L2660DW/DCP-L2665DW/MFC-L2860DWE/MFC-L2860DW/MFC-L2862DW/
MFC-L2922DW/MFC-L2960DW/MFC-L2980DW**

1. Press  [Settings] > [All Settings] > [General Setup] > [Tray Setting] > [Check Paper].
2. Press [On] or [Off].
3. Press .

Related Information

- [Paper Settings](#)

Recommended Print Media

To get the best print quality, we recommend using the paper listed in the table.

| Paper Type | Item |
|----------------|-----------------------------------------------|
| Plain Paper | Xerox Premier TCF 80 g/m ² |
| | Xerox Business 80 g/m ² |
| Recycled Paper | Steinbeis Evolution White 80 g/m ² |
| Labels | Avery laser label L7163 |
| Envelopes | Antalis River series (DL) |



Related Information

- [Paper Handling](#)

Load Documents

- [Load Documents in the Automatic Document Feeder \(ADF\)](#)
- [Load Documents on the Scanner Glass](#)

Load Documents in the Automatic Document Feeder (ADF)

Related Models: DCP-L2640DN/DCP-L2660DW/DCP-L2665DW/MFC-L2802DN/MFC-L2800DW/MFC-L2802DW/MFC-L2827DWXL/MFC-L2827DW/MFC-L2835DW/MFC-L2860DWE/MFC-L2860DW/MFC-L2862DW/MFC-L2922DW/MFC-L2960DW/MFC-L2980DW

Use the ADF when copying or scanning multi page, standard-sized documents.

- The ADF can hold the following sheets and feed each sheet individually:
Up to 50 sheets
- Use standard 80 g/m² paper.
- Make sure documents with correction fluid or written in ink are completely dry.

IMPORTANT

- DO NOT leave thick documents on the scanner glass. If you do this, the ADF may jam.
- DO NOT use paper that is curled, wrinkled, folded, ripped, stapled, paper-clipped, glued together, or taped.
- DO NOT use cardboard, newspaper, or fabric.
- To avoid damaging your machine while using the ADF, DO NOT pull on the document while it is feeding.

Supported Document Sizes

| | |
|---------|----------------------------|
| Length: | 147.3 to 355.6 mm |
| Width: | 105 to 215.9 mm |
| Weight: | 60 to 105 g/m ² |

1. Unfold the ADF document output support flap.

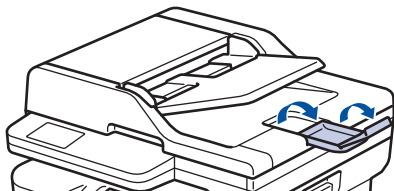

2. Fan the pages well.
3. Stagger the pages of your document and load it into the ADF *face up* and *top edge first*, as shown in the illustration.

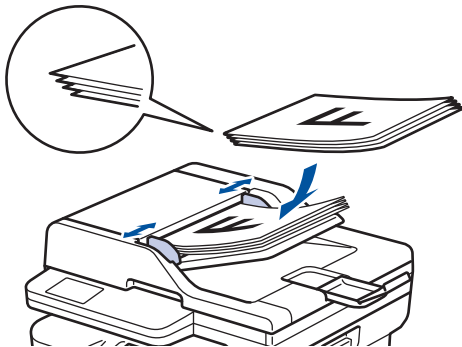

4. Adjust the paper guides to fit the width of your document.



Related Information

- [Load Documents](#)

Load Documents on the Scanner Glass

Use the scanner glass to fax, copy, or scan one page at a time.

Supported Document Sizes

| | |
|---------|----------------|
| Length: | Up to 300 mm |
| Width: | Up to 215.9 mm |
| Weight: | Up to 2kg |

NOTE

(For ADF models) To use the scanner glass, the ADF must be empty.

1. Lift the document cover.
2. Place the document on the scanner glass *face down*.

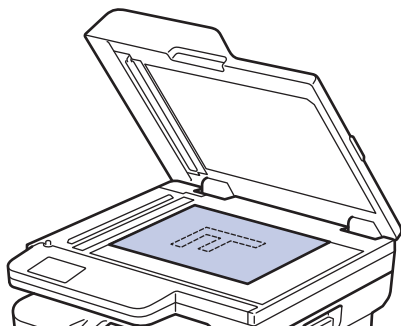

3. Place the corner of the page in the upper left corner of the scanner glass.

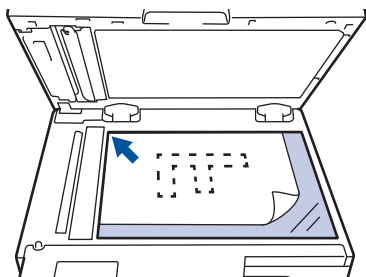

4. Close the document cover.
If the document is a book or is thick, gently press on the document cover.

✓ Related Information

- [Load Documents](#)

Unscannable and Unprintable Areas

The measurements in the table below show maximum unscannable and unprintable areas from the edges of the most commonly-used paper sizes. These measurements may vary depending on the paper size or settings in the application you are using.

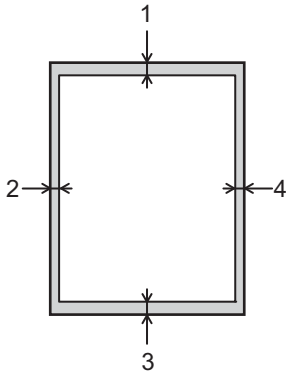

Do not attempt to scan, copy, or print in these areas. Any content included in such areas will not be reflected in the output.

| Usage | Document Size | Top (1) Bottom (3) | Left (2) Right (4) |
|-------------------|---------------|-----------------------|----------------------------------------------|
| Fax (Sending) | Letter, Legal | 2.9 mm | 3.9 mm |
| | A4 | 2.9 mm | (ADF) 1.0 mm (Scanner Glass) 3.0 mm |
| Copy ¹ | Letter, Legal | 4.0 mm | 4.0 mm |
| | A4 | 4.0 mm | 3.0 mm |
| Scan | Letter | 3.0 mm | 3.0 mm |
| | A4 | 3.0 mm | 3.0 mm |
| | Legal | 3.0 mm | 3.0 mm |
| Print | Letter, Legal | 4.2 mm | 4.2 mm |
| | A4 | 4.2 mm | 4.2 mm |

¹ A 1 in 1 copy and 100% document size copy



Related Information

- [Paper Handling](#)

Using Special Paper

Always test paper samples before purchasing them to ensure desirable performance.

- DO NOT use inkjet paper; it may cause a paper jam or damage your machine.
- If you use bond paper, paper with a rough surface, or paper that is wrinkled or creased, the paper may exhibit degraded performance.

Store paper in its original packaging and keep it sealed. Keep the paper flat and away from moisture, direct sunlight, and heat.

IMPORTANT

Some types of paper may not perform well or may cause damage to your machine.

DO NOT use paper:

- that is highly textured
- that is extremely smooth or shiny
- that is curled or warped
- that is coated or has a chemical finish
- that is damaged, creased, or folded
- that exceeds the recommended weight specification in this guide
- with tabs and staples
- that is multipart or carbonless
- that is designed for inkjet printing

If you use any of the types of paper listed above, they may damage your machine. This damage is not covered under any Brother warranty or service agreement.



Related Information

- [Paper Handling](#)

Print

- [Print from Your Computer \(Windows\)](#)
- [Print from Your Computer \(Mac\)](#)
- [Load and Print on Envelopes in the Manual Feed Slot](#)
- [Print an Email Attachment](#)
- [Change Print Settings Using the Control Panel](#)
- [Cancel a Print Job](#)
- [Test Print](#)
- [Universal Print](#)

Print from Your Computer (Windows)

- [Print a Document \(Windows\)](#)
- [Print on Both Sides of the Paper \(Windows\)](#)
- [Secure Print \(Windows\)](#)
- [Change the Default Print Settings \(Windows\)](#)
- [Print Settings \(Windows\)](#)
- [Print a Document Using the BR-Script3 Printer Driver \(PostScript® 3™ Language Emulation\) \(Windows\)](#)
- [Monitor the Status of the Machine from Your Computer \(Windows\)](#)

Print a Document (Windows)

When you change an application's print settings, the changes apply only to documents printed with that application.



- 2-sided printing may be the default depending on your model. For 1-sided printing, turn off the 2-sided printing settings in the printer driver.
- To change print settings for all Windows applications, you must configure the printer driver properties. For more information, see *Related Information: Change the Default Print Settings (Windows)*.

1. Load paper in the paper tray.
2. Select the print command in your application.
3. Select your model's name, and then click the printer's properties or preferences button.

The printer driver window appears.

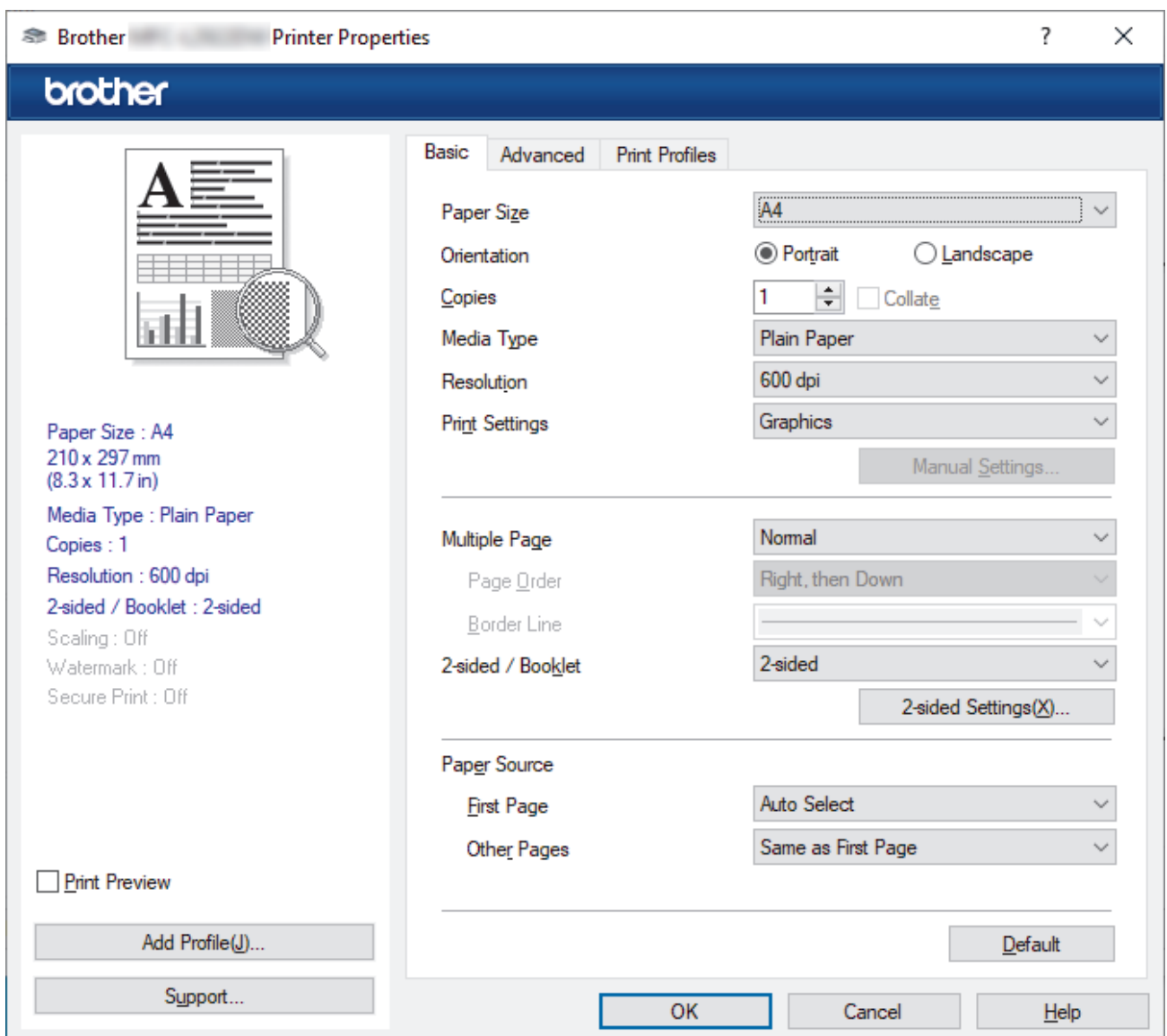

4. Make sure you have loaded the correct size paper in the paper tray.
5. Click the **Paper Size** drop-down list, and then select your paper size.
6. In the **Orientation** field, select the **Portrait** or **Landscape** option to set the orientation of your printout.



If your application contains a similar setting, we recommend that you set the orientation using the application.

-
7. Type the number of copies (1-999) you want in the **Copies** field.
 8. Click the **Media Type** drop-down list, and then select the type of paper you are using.
 9. To print multiple pages on a single sheet of paper or print one page of your document on multiple sheets, click the **Multiple Page** drop-down list, and then select your options.
 10. Click the **2-sided / Booklet** drop-down list, and then select the option you want.
 11. Change other printer settings, if needed.
 12. Click **OK**.
 13. Complete your print operation.



Related Information

- [Print from Your Computer \(Windows\)](#)

Related Topics:

- [Printing Problems](#)
 - [Change the Default Print Settings \(Windows\)](#)
 - [Paper Settings](#)
 - [Print Settings \(Windows\)](#)
-

Print on Both Sides of the Paper (Windows)

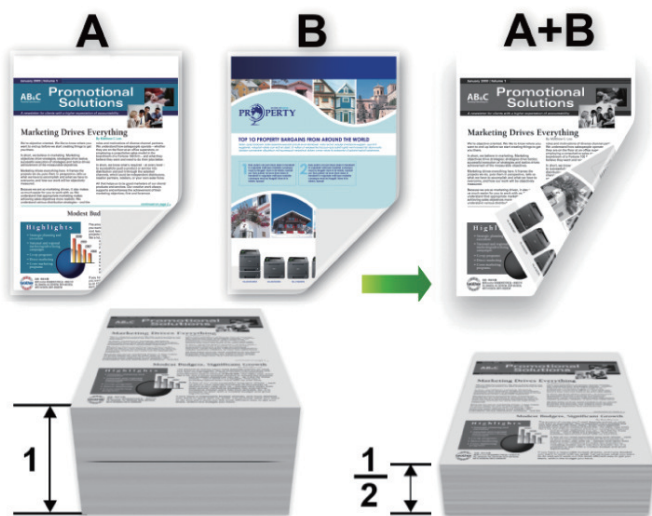

Select A4 sized paper when using the automatic 2-sided printing function.

- Make sure the back cover is closed.
- If paper is curled, straighten it and put it back in the paper tray.
- Use regular paper or thin paper. DO NOT use bond paper.
- If the paper is too thin, it may wrinkle.
- When you use the manual 2-sided printing function, it is possible there may be paper jams or poor print quality.

1. Select the print command in your application.
2. Select your model's name, and then click the printer's properties or preferences button.
The printer driver window appears.
3. In the **Orientation** field, select the **Portrait** or **Landscape** option to set the orientation of your printout.



If your application contains a similar setting, we recommend that you set the orientation using the application.

4. Click the **2-sided / Booklet** drop-down list, and then select the **2-sided** or **2-sided (Manual)** option.

| Option | Description |
|-----------------------------------------------|----------------------------------------------------------------------------------------------------------------------------------------------------------------------|
| 2-sided (available for certain models) | Automatically prints on both sides of the paper. |
| 2-sided (Manual) | The machine prints all the even-numbered pages on one side of the paper first. Then, the printer driver instructs you (with a pop-up message) to reinsert the paper. |

5. Click the **2-sided Settings** button.
6. Select one of the options from the **2-sided Type** menu.
When 2-sided is selected, four types of 2-sided binding are available for each orientation:

| Option for Portrait | Description |
|---------------------|-------------|
|---------------------|-------------|

Long Edge (Left)

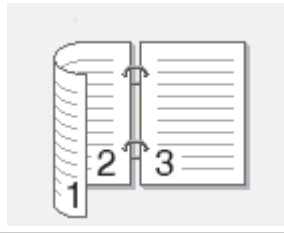

Long Edge (Right)



Short Edge (Top)

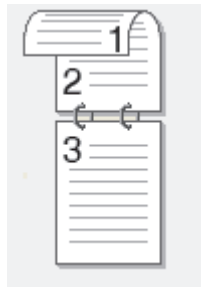

Short Edge (Bottom)

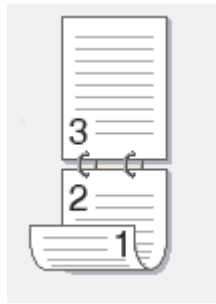

| Option for Landscape | Description |
|----------------------|-------------|
|----------------------|-------------|

Long Edge (Top)

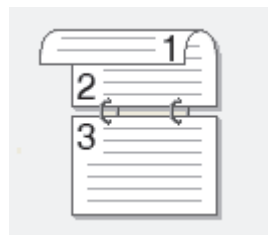

Long Edge (Bottom)

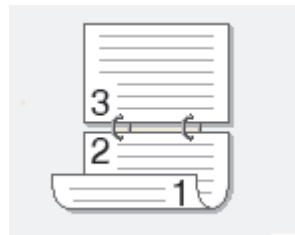

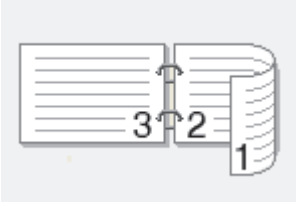
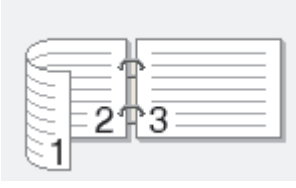
| Option for Landscape | Description |
|----------------------|-----------------------------------------------------------------------------------|
| Short Edge (Right) |  |
| Short Edge (Left) |  |

7. Select the **Binding Offset** checkbox to specify the offset for binding in inches or millimetres.
8. Click **OK**.
9. Change other printer settings, if needed.
10. Do one of the following:
 - For automatic 2-sided printing, click **OK** again, and then complete your print operation.
 - For manual 2-sided printing, click **OK** again and follow the on-screen instructions.

If the paper is not feeding correctly, it may be curled. Remove the paper, straighten it, and put it back in the paper tray.



Related Information

- [Print from Your Computer \(Windows\)](#)
-

Secure Print (Windows)

Related Models: MFC-L2860DWE/MFC-L2860DW/MFC-L2862DW/MFC-L2922DW/MFC-L2960DW/MFC-L2980DW

Use Secure Print to ensure that confidential or sensitive documents do not print until you enter a password on the machine's control panel.

The secure data is deleted from the machine when you turn the machine off.

1. Select the print command in your application.
2. Select your model's name, and then click the printer's properties or preferences button.
The printer driver window appears.
3. Click the **Advanced** tab.
4. Click the **Settings** button in the **Secure Print** field.
5. Select the **Secure Print** checkbox.
6. Type your four-digit password in the **Password** field.
7. Type the user name and job name in the **User Name** and **Job Name** fields, if needed.
8. Click **OK** to close the **Secure Print Settings** window.
9. Click **OK**.
10. Complete your print operation.
11. On the machine's control panel, press ◀ or ▶ to display the [Secure Print] option, and then press [Secure Print].
12. Press ▲ or ▼ to display user names, and then press your user name.
13. Enter your four-digit password, and then press [OK].
The LCD displays the list of secured jobs for your name.
14. Press ▲ or ▼ to display the print job, and then press it.
15. Enter the number of copies you want, and then press [OK].
16. Press [Start].
The machine prints the data.

The secured data will be cleared from the machine's memory after printing.





Related Information

- [Print from Your Computer \(Windows\)](#)

Change the Default Print Settings (Windows)

When you change an application's print settings, the changes apply only to documents printed with that application. To change print settings for all Windows applications, you must configure the printer driver properties.

1. Hold down the  key and press the  key on the computer's keyboard to launch **Run**.
2. Type "**control printers**" in the **Open:** field and click **OK**.

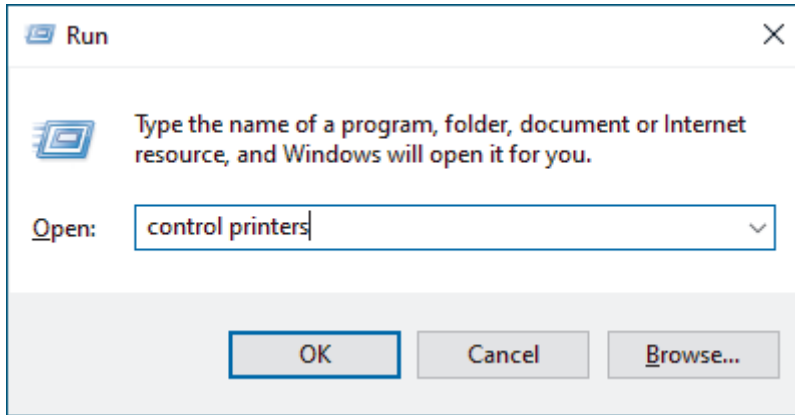

3. Right-click your model's icon, and then select **Printer properties**. (If the printer driver options appear, select your printer driver.)

The printer properties dialog box appears.

4. Click the **General** tab, and then click the **Printing Preferences...** or **Preferences...** button.
The printer driver dialog box appears.



- To configure the tray settings, click the **Device Settings** tab (available for certain models).
- To change the printer port, click the **Ports** tab.

5. Select the print settings you want to use as default for all of your Windows programs.
6. Click **OK**.
7. Close the printer properties dialog box.

✓ Related Information

- [Print from Your Computer \(Windows\)](#)

Related Topics:

- [Printing Problems](#)
- [Print a Document \(Windows\)](#)
- [Print Settings \(Windows\)](#)

Print Settings (Windows)



- When you change an application's print settings, the changes apply only to documents printed with that application.
For more information, see *Related Information: Print a Document (Windows)*.
- To change the default print settings, you must configure the printer driver properties.
For more information, see *Related Information: Change the Default Print Settings (Windows)*.

>> [Basic Tab](#)

>> [Advanced Tab](#)

Basic Tab

1. Paper Size

Select the paper size you want to use. You can either choose from standard paper sizes or create a custom paper size.

2. Orientation

Select the orientation (portrait or landscape) of your printout.

If your application contains a similar setting, we recommend that you set the orientation using the application.

3. Copies

Type the number of copies (1-999) that you want to print in this field.

Collate

Select this option to print sets of multi-page documents in the original page order. When this option is selected, one complete copy of your document will print, and then reprint according to the number of copies you choose. If this option is not selected, then each page will print according to the number of copies chosen before the next page of the document is printed.

4. Media Type

Select the media type you want to use. To achieve the best print results, the machine automatically adjusts its print settings according to the selected media type.

5. Resolution

Select the print resolution. As print resolution and speed are related, the higher the resolution, the longer it will take to print the document.

6. Print Settings

Select the type of document you want to print.

Manual Settings...

Specify additional settings such as brightness, contrast, and other settings.

Graphics

Use Printer Halftone

Select this option to use the printer driver to express halftones.

Brightness

Adjust the brightness.

Contrast

Adjust the contrast.

Graphics Quality

Select either Graphics or Text for the best print quality, based on the type of document you are printing.

Improve Grey Printing

Select this option to improve the image quality of shaded areas.

Improve Pattern Printing

Select this option to improve the pattern printing if printed fills and patterns are different from the fills and patterns you see on your computer screen.

Improve Thin Line

Select this option to improve the image quality of thin lines.

Use System Halftone

Select this option to use Windows to express halftones.

TrueType Mode (available for certain models)

Mode

Select how the fonts are processed for printing.

Use Printer TrueType Fonts

Select whether to use built-in fonts for the font processing.

7. Multiple Page

Select this option to print multiple pages on a single sheet of paper, or print one page of your document on multiple sheets.

Page Order

Select the page order when printing multiple pages on a single sheet of paper.

Border Line

Select the type of border to use when printing multiple pages on a single sheet of paper.

8. 2-sided / Booklet

Select this option to print on both sides of the paper, or print a document in booklet format using 2-sided printing.

2-sided Settings

Click this button to select the type of 2-sided binding. Four types of 2-sided bindings are available for each orientation.

9. Paper Source

Select the paper source setting according to your print conditions or purpose.

First Page

Select the paper source to use for printing the first page.

Other Pages

Select the paper source to use for printing the second and subsequent pages.

Advanced Tab

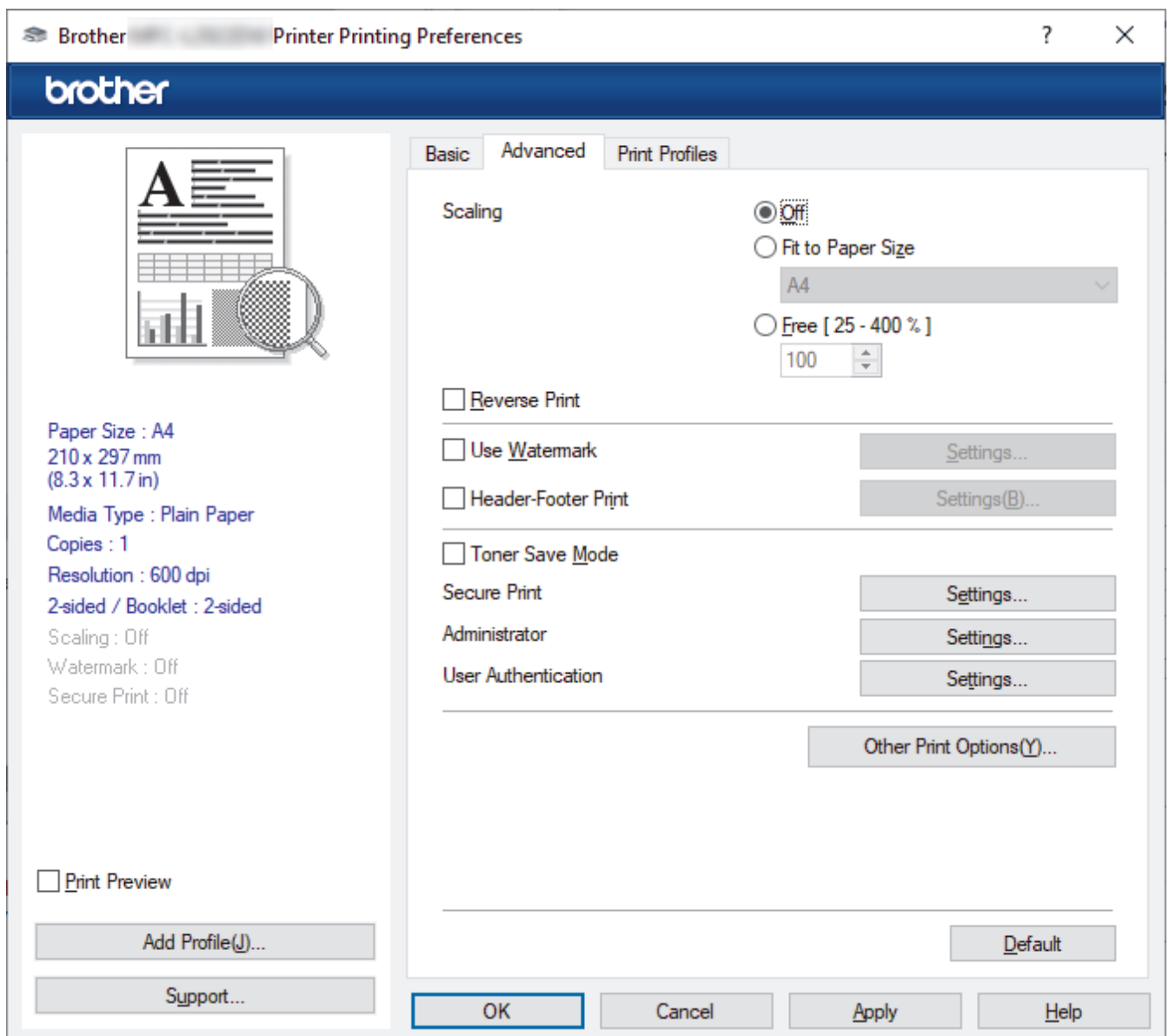

1. Scaling

Select these options to enlarge or reduce the size of the pages in your document.

Fit to Paper Size

Select this option to enlarge or reduce the document pages to fit a specified paper size. When you select this option, select the paper size you want from the drop-down list.

Free [25 - 400%]

Select this option to enlarge or reduce the document pages manually. When you select this option, type a value into the field.

2. Reverse Print

Select this option to rotate the printed image 180 degrees.

3. Use Watermark

Select this option to print a logo or text on your document as a watermark. Select one of the preset watermarks, add a new watermark, or use an image file you have created.

4. Header-Footer Print

Select this option to print the date, time, and login user name on the document.

5. Toner Save Mode

Select this feature to use less toner to print documents; printouts appear lighter, but are still legible.

6. Secure Print (available for certain models)

This feature ensures that confidential or sensitive documents are not printed out until you enter a password on the machine's control panel.

7. Administrator

This feature allows you to change the administrator password and restrict various printing functions.

8. User Authentication (available for certain models)

This feature allows you to confirm the restrictions for each user.

9. Other Print Options

Sleep Time (available for certain models)

Select this option to set the machine to enter sleep mode immediately after printing.

Macro (available for certain models)

Select this feature to print an electronic form (macro), which you have stored in your machine's memory, as an overlay on the print job.

Density Adjustment

Specify the print density.

Improve Print Output

Select this option to reduce the amount of paper curling and improve the toner fixing.

Skip Blank Page

Select this option to allow the printer driver to automatically detect blank pages and exclude them from printing.

Print Text in Black

Select this option when you want to print colour text in black.

Print Archive

Select this option to save the print data as a PDF file to your computer.

Eco settings

Select this option to reduce printing noise.



Related Information

- [Print from Your Computer \(Windows\)](#)

Related Topics:

- [Change the Default Print Settings \(Windows\)](#)
 - [Print a Document \(Windows\)](#)
-

Print a Document Using the BR-Script3 Printer Driver (PostScript® 3™ Language Emulation) (Windows)

Related Models: DCP-L2622DW/DCP-L2640DN/DCP-L2660DW/DCP-L2665DW/MFC-L2860DWE/MFC-L2860DW/MFC-L2862DW/MFC-L2922DW/MFC-L2960DW/MFC-L2980DW

The BR-Script3 printer driver lets you print PostScript® data more clearly.

Go to your model's **Downloads** page at support.brother.com/downloads to install the PS driver (BR-Script3 printer driver).

1. Select the print command in your application.
2. Select your model with **BR-Script3** in the name, and then click the printer's properties or preferences button.

The printer driver window appears.

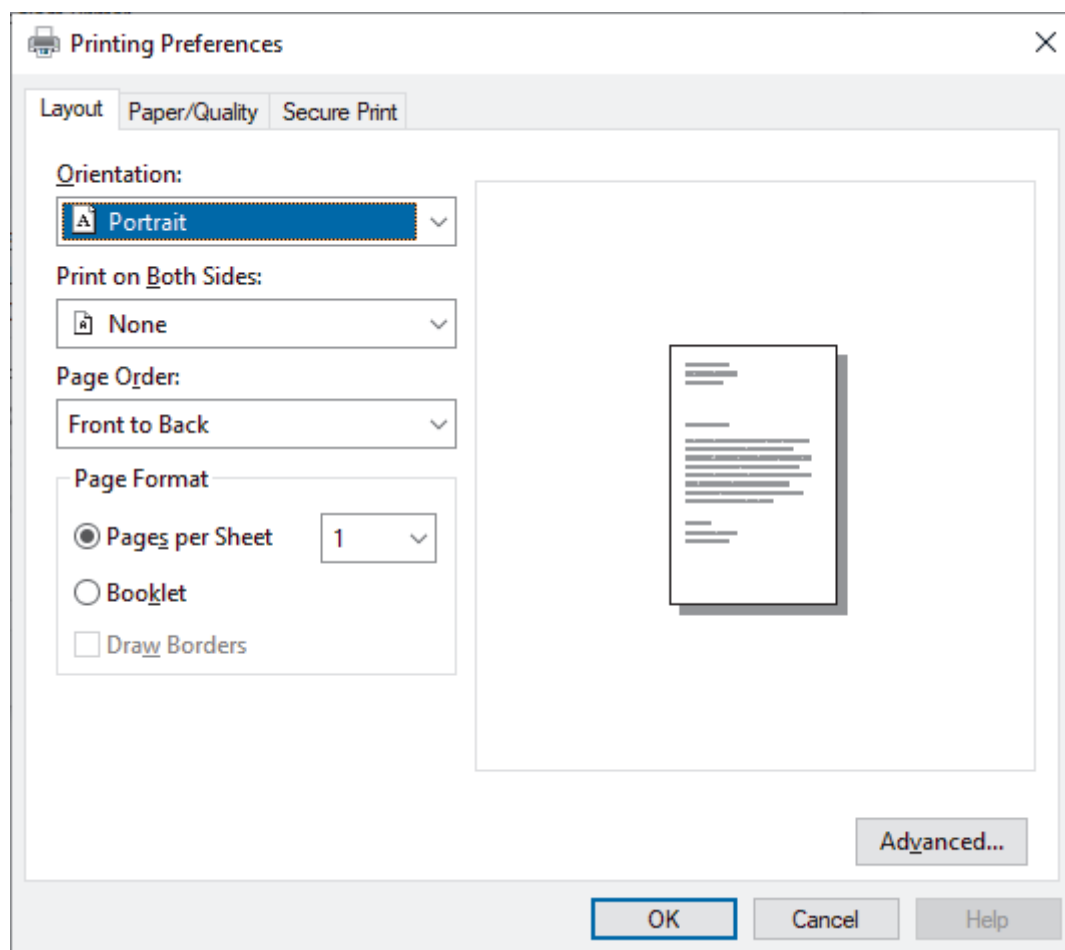

3. Click the **Layout**, **Paper/Quality**, or **Secure Print** tab to change basic print settings. (available for certain models)
Click the **Layout** or **Paper/Quality** tab, and then click the **Advanced...** button to change advanced print settings. Click **OK**.
4. Click **OK**.
5. Complete your print operation.



✓ Related Information

- [Print from Your Computer \(Windows\)](#)

Monitor the Status of the Machine from Your Computer (Windows)

The Status Monitor is a configurable software tool for monitoring the status of one or more machines, allowing you to get immediate notification of errors.

Do one of the following:

- Double-click the  icon in the task tray.
- Launch  (**Brother Utilities**), and then click the drop-down list and select your model's name (if not already selected). Click **Tools** in the left navigation bar, and then click **Status Monitor**.

Troubleshooting

Click the **Troubleshooting** button to access the support website.

Looking for replacement supplies?

Click the **Looking for replacement supplies?** button for more information on Brother genuine supplies.



Related Information

- [Print from Your Computer \(Windows\)](#)

Related Topics:

- [Printing Problems](#)

Print from Your Computer (Mac)

- [Before Using AirPrint \(macOS\)](#)
- [Print Using AirPrint](#)

Load and Print on Envelopes in the Manual Feed Slot

Before loading, press the corners and sides of the envelopes to make them as flat as possible.

When you load a different paper size in the tray, you must change the Paper Size setting in the machine or on your computer at the same time.

1. Open the machine's back cover (the face up output tray).

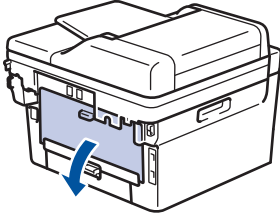

 The machine automatically turns on Manual Feed mode when you load paper in the manual feed slot.

2. Pull down the two green levers as shown in the illustration (applicable to models with green levers).

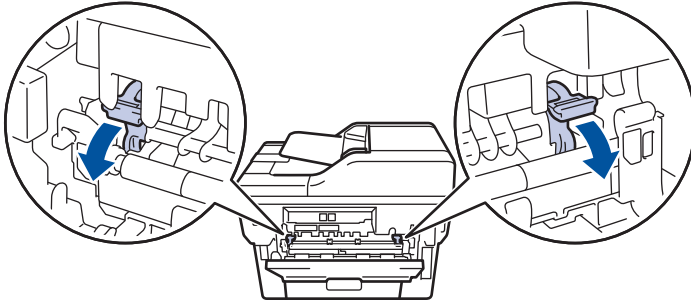

3. On the front of the machine, open the manual feed slot cover.

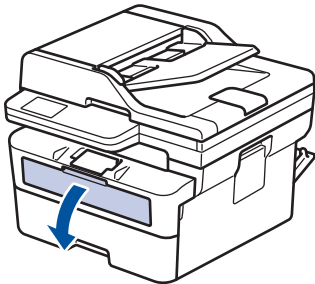

4. Use both hands to slide the manual feed slot paper guides to fit the width of the paper that you are using.

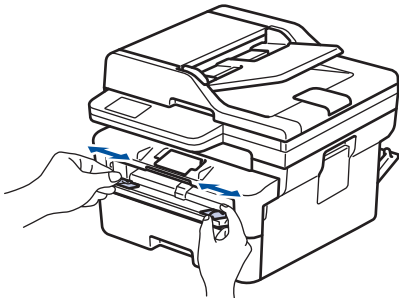

- Using both hands, put one envelope in the manual feed slot until the front edge touches the paper feed roller. When you feel the machine pull it in, let go.

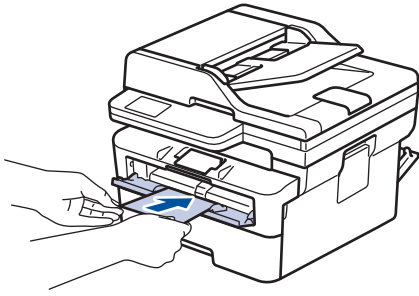

- Load the envelope into the manual feed slot with the printing surface *facing up*.
- Pull the envelope out completely when you reload the envelope into the manual feed slot.
- Do not put more than one envelope in the manual feed slot at one time, as it may cause a jam.
- Make sure the envelope is straight and in the correct position on the manual feed slot. If it is not, the envelope may not be fed correctly, resulting in a skewed printout or a paper jam.

- Send your print job to the machine.



Change your print preferences in the Print dialog box.

| Settings | Options for Envelopes |
|------------|--------------------------------------|
| Paper Size | Com-10 DL C5 Monarch |
| Media Type | Envelopes Env. Thick Env. Thin |

- After the printed envelope comes out of the machine, put in the next envelope. Repeat for each envelope that you want to print.
- When you finish printing, return the two green levers to their original position.
- When finished, close the back cover (the face up output tray) until it locks in the closed position.



Related Information

- [Load Paper](#)
- [Print](#)

Print an Email Attachment

You can print files by emailing them to your Brother machine.

- Make sure Web Based Management is set to On. For more information, see *Related Information*.
- You can attach up to 10 documents, 20 MB in total, to an email.
- This feature supports the following formats:
 - Document files: PDF, TXT, and Microsoft Office files
 - Image files: JPEG, BMP, GIF, PNG, and TIFF
- The machine prints both the email content and attachments by default. To print only email attachments, change the settings as necessary.

1. Start your web browser.
2. Type "https://machine's IP address" in your browser's address bar (where "machine's IP address" is your machine's IP address).

For example:

https://192.168.1.2

3. If required, type the password in the **Login** field, and then click **Login**.



The default password to manage this machine's settings is located on the back of the machine and marked "**Pwd**". Change the default password by following the on-screen instructions when you first log in.

4. In the left navigation bar, click **Online Functions** > **Online Functions Settings**.



- If the left navigation bar is not visible, start navigating from ☰.
- If this function is locked, contact your network administrator for access.

5. Click the **I accept the terms and conditions** button.
6. Go to your machine, and then follow the machine's instructions to enable the settings.
7. On your computer, click **General Settings**.

The **Email Print: General Settings** screen appears.

8. Click the **Enable** button.
The machine prints the instruction sheet.
9. Send your email to the email address included on the sheet. The machine prints the email attachments.



- To change the settings, including email address and printer settings, click the **Online Functions Settings Page** button.
- (DCP-L2660DW/DCP-L2665DW/MFC-L2860DWE/MFC-L2860DW/MFC-L2862DW/MFC-L2922DW/MFC-L2960DW/MFC-L2980DW)
You can also configure the settings from your machine. Press [Apps] > [Online Functions], and then follow the on-screen instructions.



Related Information

- [Print](#)

Related Topics:

- [Enable/Disable Web Based Management Using the Control Panel](#)

Change Print Settings Using the Control Panel

Related Models: DCP-L2622DW/DCP-L2640DN/DCP-L2660DW/DCP-L2665DW/MFC-L2860DWE/MFC-L2860DW/MFC-L2862DW/MFC-L2922DW/MFC-L2960DW/MFC-L2980DW

Select the type of document you want to print.



>> [DCP-L2622DW/DCP-L2640DN](#)

>> [DCP-L2660DW/DCP-L2665DW/MFC-L2860DWE/MFC-L2860DW/MFC-L2862DW/MFC-L2922DW/MFC-L2960DW/MFC-L2980DW](#)

DCP-L2622DW/DCP-L2640DN

1. Press **Menu**.
2. Press **▲** or **▼** to display the [Printer] option, and then press **OK**.
3. Press **▲** or **▼** to display the [Print Settings] option, and then press **OK**.
4. Press **▲** or **▼** to display the [Graphics] or [Text] option, and then choose the option you want.
5. Press **OK**.

DCP-L2660DW/DCP-L2665DW/MFC-L2860DWE/MFC-L2860DW/MFC-L2862DW/MFC-L2922DW/MFC-L2960DW/MFC-L2980DW

1. Press  [Settings] > [All Settings] > [Printer] > [Print Settings].
2. Press [Text] or [Graphics].
3. Press .

Related Information

- [Print](#)

Cancel a Print Job

>> [DCP-L2600D/DCP-L2620DW/DCP-L2622DW/DCP-L2627DW/DCP-L2627DWXL/DCP-L2627DWE/DCP-L2640DN/MFC-L2802DN/MFC-L2800DW/MFC-L2802DW/MFC-L2827DWXL/MFC-L2827DW/MFC-L2835DW](#)
>> [DCP-L2660DW/DCP-L2665DW/MFC-L2860DWE/MFC-L2860DW/MFC-L2862DW/MFC-L2922DW/MFC-L2960DW/MFC-L2980DW](#)

**DCP-L2600D/DCP-L2620DW/DCP-L2622DW/DCP-L2627DW/DCP-L2627DWXL/
DCP-L2627DWE/DCP-L2640DN/MFC-L2802DN/MFC-L2800DW/MFC-L2802DW/
MFC-L2827DWXL/MFC-L2827DW/MFC-L2835DW**

Press **Stop/Exit**.



To cancel multiple print jobs, press and hold **Stop/Exit** for four seconds.

**DCP-L2660DW/DCP-L2665DW/MFC-L2860DWE/MFC-L2860DW/MFC-L2862DW/
MFC-L2922DW/MFC-L2960DW/MFC-L2980DW**

Press .



To cancel multiple print jobs, press and hold  for about four seconds.

Related Information

- [Print](#)

Related Topics:

- [Printing Problems](#)

Test Print

If there are problems with print quality, follow these instructions to do a test print:

>> DCP-L2600D/DCP-L2620DW/DCP-L2627DW/DCP-L2627DWXL/DCP-L2627DWE/MFC-L2802DN/
MFC-L2800DW/MFC-L2802DW/MFC-L2827DWXL/MFC-L2827DW/MFC-L2835DW
>> DCP-L2622DW/DCP-L2640DN
>> DCP-L2660DW/DCP-L2665DW/MFC-L2860DWE/MFC-L2860DW/MFC-L2862DW/MFC-L2922DW/
MFC-L2960DW/MFC-L2980DW



**DCP-L2600D/DCP-L2620DW/DCP-L2627DW/DCP-L2627DWXL/DCP-L2627DWE/
MFC-L2802DN/MFC-L2800DW/MFC-L2802DW/MFC-L2827DWXL/MFC-L2827DW/
MFC-L2835DW**

1. Press **Menu**.
2. Press **▲** or **▼** to display the [Printer] option, and then press **OK**.
3. Press **▲** or **▼** to display the [Test Print] option, and then press **OK**.
4. Press **Start**.
The machine prints a Test Print page.
5. Press **Stop/Exit**.

DCP-L2622DW/DCP-L2640DN

1. Press **Menu**.
2. Press **▲** or **▼** to display the [Printer] option, and then press **OK**.
3. (For Printer Emulation Supported models)
Press **▲** or **▼** to display the [Print Options] option, and then press **OK**.
4. Press **▲** or **▼** to display the [Test Print] option, and then press **OK**.
5. Press **Start**.
The machine prints a Test Print page.
6. Press **Stop/Exit**.

**DCP-L2660DW/DCP-L2665DW/MFC-L2860DWE/MFC-L2860DW/MFC-L2862DW/
MFC-L2922DW/MFC-L2960DW/MFC-L2980DW**

1. Press  [Settings] > [All Settings] > [Printer] > [Print Options] > [Test Print].
2. Press [Yes].
3. Press .

Related Information

- [Print](#)

Related Topics:

- [Improve the Print Quality](#)

Universal Print

Related Models: MFC-L2922DW/MFC-L2960DW/MFC-L2980DW

- [Universal Print Overview](#)
- [Register Your Machine with Universal Print Using Web Based Management](#)
- [Assign Universal Print Users via Microsoft Azure Portal](#)
- [Add a Universal Print-enabled Printer to Your Computer](#)
- [Print Using Universal Print](#)
- [Deregister Your Machine from Universal Print](#)

Universal Print Overview

Related Models: MFC-L2922DW/MFC-L2960DW/MFC-L2980DW

Universal Print is a cloud-based print service from Microsoft. You can print documents, from anywhere on the Internet, without installing a printer driver. Universal Print is available for Azure Active Directory (Azure AD) users with the Microsoft 365 subscription.

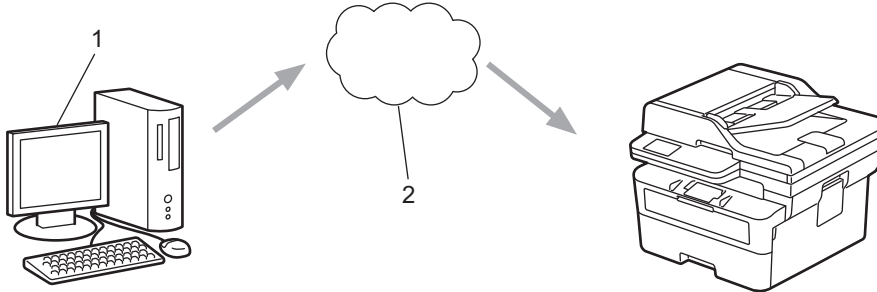

1. Computer running Windows 10 20H1 or greater
2. Cloud server



Related Information

- [Universal Print](#)

Register Your Machine with Universal Print Using Web Based Management

Related Models: MFC-L2922DW/MFC-L2960DW/MFC-L2980DW

- Make sure you set the correct date and time for your time zone.
- If your network uses a proxy server, configure the proxy server settings.

1. Start your web browser.
2. Type "https://machine's IP address" in your browser's address bar (where "machine's IP address" is your machine's IP address).

For example:

https://192.168.1.2

3. If required, type the password in the **Login** field, and then click **Login**.



The default password to manage this machine's settings is located on the back of the machine and marked "Pwd". Change the default password by following the on-screen instructions when you first log in.

4. In the left navigation bar, click **Network > Network > Protocol**.



If the left navigation bar is not visible, start navigating from ☰.

5. Select the **Universal Print** checkbox, and then click **Advanced Settings**.
6. Change your machine's name in the **Device Name** field if necessary.



Using the following characters: ?, /, \, ", :, <, >, | or * may cause a sending error.

7. Click **Register**.



If an error occurs, follow the on-screen instructions.

8. A Universal Print user code appears. Click the **Sign in** button, and then type the user code.
9. Follow the on-screen instructions to finish the registration.



Related Information

- [Universal Print](#)

Related Topics:

- [Configure Date and Time Using Web Based Management](#)
- [Configure the Proxy Server Settings Using Web Based Management](#)

Assign Universal Print Users via Microsoft Azure Portal

Related Models: MFC-L2922DW/MFC-L2960DW/MFC-L2980DW

You can assign users to the Universal Print service only if your machine is registered on the Microsoft Azure portal.

1. Access the Microsoft Azure portal.
URL: portal.azure.com
2. Log in as a Printer Administrator.
3. Select the **Universal Print** service.
4. Select the **Printers** option, and then select your machine from the list.
5. Select the **Share** option.
6. Select the users you want to assign to the Universal Print service, and then click **Share Printer**.





Related Information

- [Universal Print](#)

Add a Universal Print-enabled Printer to Your Computer

Related Models: MFC-L2922DW/MFC-L2960DW/MFC-L2980DW

1. Do one of the following:
 - For Windows 11
Click  > **Settings** > **Bluetooth & devices** > **Printers & scanners** > **Add a printer or scanner**, and then click **Add device**.
 - For Windows 10
Click  >  > **Devices** > **Printers & scanners** > **Add a printer or scanner**.
2. Select your machine registered as a Universal Print-enabled printer from the list, and then click **Add device**.



Related Information

- [Universal Print](#)

Print Using Universal Print

Related Models: MFC-L2922DW/MFC-L2960DW/MFC-L2980DW

1. Select the print command in your application.
2. Select the machine you registered as a Universal Print-enabled printer, and then click the printer's properties or preferences button.
3. Change the printer settings, if needed, and then click **OK**.
4. Complete your print operation.



Related Information

- [Universal Print](#)
-

Deregister Your Machine from Universal Print

Related Models: MFC-L2922DW/MFC-L2960DW/MFC-L2980DW

To deregister your machine, you must delete it from Web Based Management, and then delete it on the Microsoft Azure portal.

1. Start your web browser.
2. Type "https://machine's IP address" in your browser's address bar (where "machine's IP address" is your machine's IP address).

For example:

https://192.168.1.2

3. If required, type the password in the **Login** field, and then click **Login**.



The default password to manage this machine's settings is located on the back of the machine and marked "**Pwd**". Change the default password by following the on-screen instructions when you first log in.

4. In the left navigation bar, click **Network > Network > Protocol**.



If the left navigation bar is not visible, start navigating from ☰.

5. Next to the **Universal Print** checkbox, click **Advanced Settings**.
6. Click **Delete Registration Data**, and then follow the on-screen instructions.
7. Access the Microsoft Azure portal.
URL: portal.azure.com
8. Log in as a Printer Administrator.
9. Select the **Universal Print** service.
10. Select the **Printers** option, and then select your machine from the list.
11. Click **Delete Printer Share**, and then click **OK**.
12. Click **Unregister**, and then click **OK**.



Related Information

- [Universal Print](#)

Scan

- [Scan Using the Scan Button on Your Machine](#)
- [Scan from Your Computer \(Windows\)](#)
- [Scan from Your Computer \(Mac\)](#)
- [Configure Scan Settings Using Web Based Management](#)

Scan Using the Scan Button on Your Machine

- [Scan Photos and Graphics](#)
- [Scan Single or Multiple Pages to a Folder in a Single PDF File](#)
- [Scan to an Editable Text File \(OCR\)](#)
- [Save Scanned Data as an Email Attachment](#)
- [Send Scanned Data to an Email Recipient](#)
- [Scan to FTP](#)
- [Scan to Network \(Windows\)](#)
- [Use the Web Services Protocol for Network Scanning \(Windows 10 and Windows 11\)](#)
- [Change the Scan Button Settings from Brother iPrint&Scan](#)
- [Configure Certificates for Signed PDFs](#)
- [Disable Scanning from Your Computer](#)

Scan Photos and Graphics

Send scanned photos or graphics directly to your computer.

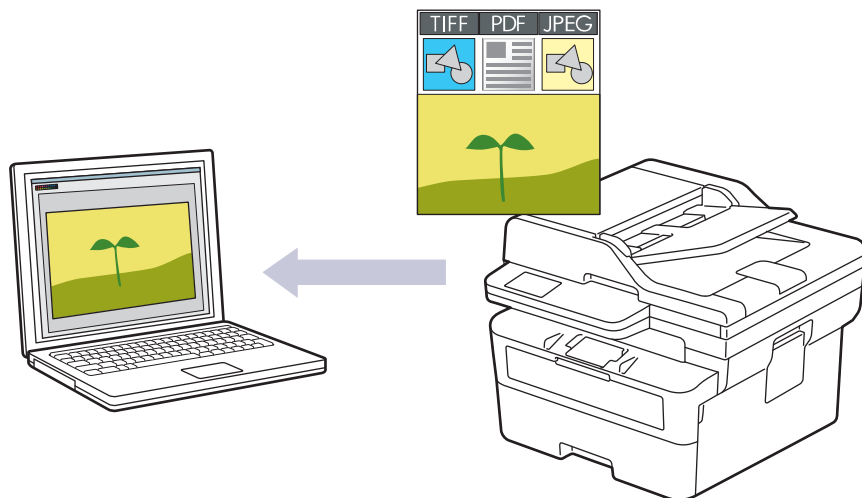

- **To scan from your machine:**
 - You must select your machine using Brother iPrint&Scan.
 - Use Brother iPrint&Scan to change scan settings such as file type and file storage location.For more information, see *Related Information: Change the Scan Button Settings from Brother iPrint&Scan*.
- **To scan from your computer:**
See *Related Information: Scan Using Brother iPrint&Scan (Windows/Mac)*.

>> DCP-L2600D/DCP-L2620DW/DCP-L2622DW/DCP-L2627DW/DCP-L2627DWXL/DCP-L2627DWE/
DCP-L2640DN/MFC-L2802DN/MFC-L2800DW/MFC-L2802DW/MFC-L2827DWXL/MFC-L2827DW/
MFC-L2835DW
>> DCP-L2660DW/DCP-L2665DW/MFC-L2860DWE/MFC-L2860DW/MFC-L2862DW/MFC-L2922DW/
MFC-L2960DW/MFC-L2980DW

**DCP-L2600D/DCP-L2620DW/DCP-L2622DW/DCP-L2627DW/DCP-L2627DWXL/
DCP-L2627DWE/DCP-L2640DN/MFC-L2802DN/MFC-L2800DW/MFC-L2802DW/
MFC-L2827DWXL/MFC-L2827DW/MFC-L2835DW**

1. Load your document.
2. Press  (**Scan**).
3. Press **▲** or **▼** to select the [to PC] option, and then press **OK**.
4. Press **▲** or **▼** to select the [Image] option, and then press **OK**.
5. If the machine is connected over the network, press **▲** or **▼** to select the destination computer.
6. Press **OK**.



If the LCD prompts you to enter a PIN, enter the four-digit PIN for the destination computer on the LCD and then press **OK**.

7. To change the scan settings for this document, press **Options** or **Copy/Scan Options**, press **▲** or **▼** to select the option you want, and then press **OK** to continue to the next scan setting. Skip this step if you want to use the default scan settings.
 - [Colour Setting]
 - [Resolution]
 - [File Type]

- [Document Size]
- [ADF Auto Deskew] (available only for certain models)
- [Remove Bkg Clr] (available only for certain settings)



To change the scan settings, a computer with Brother iPrint&Scan installed must be connected to the machine.

8. Press **Start**.

The machine starts scanning. If using the machine's scanner glass, follow the LCD instructions to complete the scanning job.

DCP-L2660DW/DCP-L2665DW/MFC-L2860DWE/MFC-L2860DW/MFC-L2862DW/ MFC-L2922DW/MFC-L2960DW/MFC-L2980DW

1. Load your document.
2. Press [Scan] > [to PC] > [to Image].
3. If the machine is connected over the network, press ▲ or ▼ to display the computer where you want to send data, and then press the computer name.



If the LCD prompts you to enter a PIN for the computer, enter the four-digit PIN on the LCD and then press [OK].

4. To change the scan settings, press  [Options], and then select the scan settings you want to change. Skip this step if you want to use the default scan settings.

- [2-sided Scan] (available for certain models)
- [Scan Settings]
- [Colour Setting]
- [Resolution]
- [File Type]
- [Document Size]
- [Brightness]
- [Contrast] (available only for certain settings)
- [ADF Auto Deskew] (available for certain models)
- [Remove Background Colour] (available only for certain settings)



- To change the scan settings, a computer with Brother iPrint&Scan installed must be connected to your machine.
- When your machine displays the [OK] button, press [OK].
- To save the settings as a shortcut, press [Save as Shortcut].

5. Press [Start].

The machine starts scanning. If using the machine's scanner glass, follow the LCD instructions to complete the scanning job.



Related Information

- [Scan Using the Scan Button on Your Machine](#)

Related Topics:

- [Change the Scan Button Settings from Brother iPrint&Scan](#)
- [Scan Using Brother iPrint&Scan \(Windows/Mac\)](#)

Scan Single or Multiple Pages to a Folder in a Single PDF File

Combine multiple pages into a single PDF document.

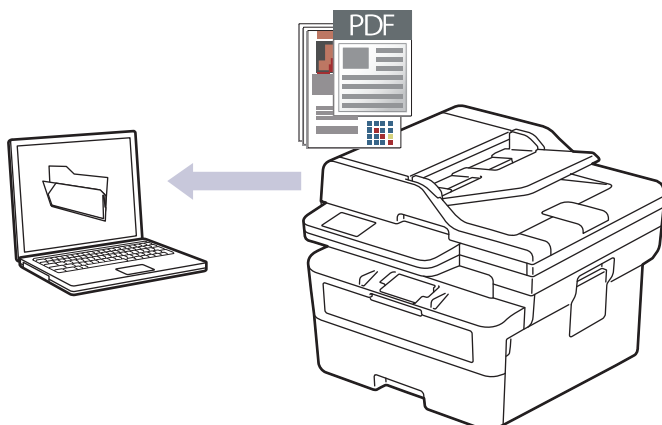

- **To scan from your machine:**
 - You must select your machine using Brother iPrint&Scan.
 - Use Brother iPrint&Scan to change scan settings such as file type and file storage location.For more information, see *Related Information: Change the Scan Button Settings from Brother iPrint&Scan*.
- **To scan from your computer:**

See *Related Information: Scan Using Brother iPrint&Scan (Windows/Mac)*.



When scanning multiple pages to a PDF file, set the file type on your machine to [PDF Multi-Page].

>> DCP-L2600D/DCP-L2620DW/DCP-L2622DW/DCP-L2627DW/DCP-L2627DWXL/DCP-L2627DWE/
DCP-L2640DN/MFC-L2802DN/MFC-L2800DW/MFC-L2802DW/MFC-L2827DWXL/MFC-L2827DW/
MFC-L2835DW
>> DCP-L2660DW/DCP-L2665DW/MFC-L2860DWE/MFC-L2860DW/MFC-L2862DW/MFC-L2922DW/
MFC-L2960DW/MFC-L2980DW

**DCP-L2600D/DCP-L2620DW/DCP-L2622DW/DCP-L2627DW/DCP-L2627DWXL/
DCP-L2627DWE/DCP-L2640DN/MFC-L2802DN/MFC-L2800DW/MFC-L2802DW/
MFC-L2827DWXL/MFC-L2827DW/MFC-L2835DW**

1. Load your document.
2. Press  (**Scan**).
3. Press ▲ or ▼ to select the [to PC] option, and then press **OK**.
4. Press ▲ or ▼ to select the [File] option, and then press **OK**.
5. If the machine is connected over the network, press ▲ or ▼ to select the destination computer.
6. Press **OK**.



If the LCD prompts you to enter a PIN, enter the four-digit PIN for the destination computer on the LCD and then press **OK**.

7. To change the scan settings for this document, press **Options** or **Copy/Scan Options**, press ▲ or ▼ to select the option you want, and then press **OK** to continue to the next scan setting. Skip this step if you want to use the default scan settings.
 - [Colour Setting]
 - [Resolution]

- [File Type]
- [Document Size]
- [ADF Auto Deskew] (available only for certain models)
- [Remove Bkg Clr] (available only for certain settings)



To change the scan settings, a computer with Brother iPrint&Scan installed must be connected to the machine.

8. Press **Start**.

The machine starts scanning. If using the machine's scanner glass, follow the LCD instructions to complete the scanning job.

DCP-L2660DW/DCP-L2665DW/MFC-L2860DWE/MFC-L2860DW/MFC-L2862DW/ MFC-L2922DW/MFC-L2960DW/MFC-L2980DW

1. [Load your document](#).
2. Press [Scan] > [to PC] > [to File].
3. If the machine is connected over the network, press ▲ or ▼ to display the computer where you want to send data, and then press the computer name.



If the LCD prompts you to enter a PIN for the computer, enter the four-digit PIN on the LCD and then press [OK].

4. To change the scan settings, press  [Options], and then select the scan settings you want to change. Skip this step if you want to use the default scan settings.

- [2-sided Scan] (available for certain models)
- [Scan Settings]
- [Colour Setting]
- [Resolution]
- [File Type]
- [Document Size]
- [Brightness]
- [Contrast] (available only for certain settings)
- [ADF Auto Deskew] (available for certain models)
- [Remove Background Colour] (available only for certain settings)



- To change the scan settings, a computer with Brother iPrint&Scan installed must be connected to your machine.
- When your machine displays the [OK] button, press [OK].
- To save the settings as a shortcut, press [Save as Shortcut].

5. Press [Start].

The machine starts scanning. If using the machine's scanner glass, follow the LCD instructions to complete the scanning job.



Related Information

- [Scan Using the Scan Button on Your Machine](#)

Related Topics:

- [Change the Scan Button Settings from Brother iPrint&Scan](#)
- [Scan Using Brother iPrint&Scan \(Windows/Mac\)](#)

Scan to an Editable Text File (OCR)

Your machine can convert characters in a scanned document to text using the optical character recognition (OCR) technology. You can edit this text using your preferred text-editing application.

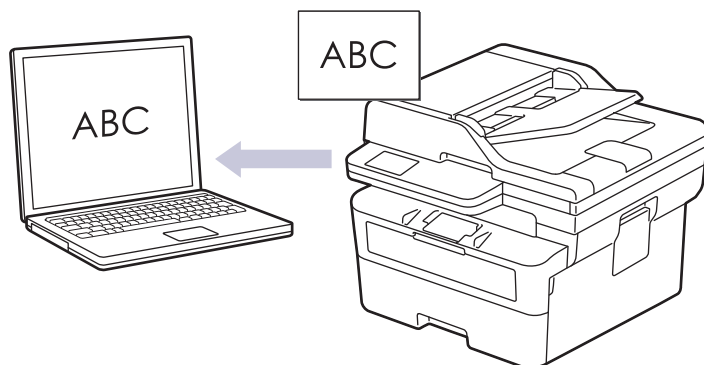

- The Scan to OCR feature is available only for certain languages.
- Use the Scan button on the machine to make temporary changes to the scan settings. To make permanent changes, use Brother iPrint&Scan.

>> DCP-L2600D/DCP-L2620DW/DCP-L2622DW/DCP-L2627DW/DCP-L2627DWXL/DCP-L2627DWE/
DCP-L2640DN/MFC-L2802DN/MFC-L2800DW/MFC-L2802DW/MFC-L2827DWXL/MFC-L2827DW/
MFC-L2835DW
>> DCP-L2660DW/DCP-L2665DW/MFC-L2860DWE/MFC-L2860DW/MFC-L2862DW/MFC-L2922DW/
MFC-L2960DW/MFC-L2980DW

**DCP-L2600D/DCP-L2620DW/DCP-L2622DW/DCP-L2627DW/DCP-L2627DWXL/
DCP-L2627DWE/DCP-L2640DN/MFC-L2802DN/MFC-L2800DW/MFC-L2802DW/
MFC-L2827DWXL/MFC-L2827DW/MFC-L2835DW**

1. Load your document.
2. Press  (**Scan**).
3. Press ▲ or ▼ to select the [to PC] option, and then press **OK**.
4. Press ▲ or ▼ to select the [OCR] option, and then press **OK**.
5. If the machine is connected over the network, press ▲ or ▼ to select the destination computer.
6. Press **OK**.



If the LCD prompts you to enter a PIN, enter the four-digit PIN for the destination computer on the LCD and then press **OK**.

7. To change the scan settings for this document, press **Options** or **Copy/Scan Options**, press ▲ or ▼ to select the option you want, and then press **OK** to continue to the next scan setting. Skip this step if you want to use the default scan settings.
 - [Colour Setting]
 - [Resolution]
 - [File Type]
 - [Document Size]
 - [ADF Auto Deskew] (available only for certain models)
 - [Remove Bkg Clr] (available only for certain settings)



To change the scan settings, a computer with Brother iPrint&Scan installed must be connected to the machine.

8. Press **Start**.

The machine starts scanning. If you are using the machine's scanner glass, follow the LCD instructions to complete the scanning job.

DCP-L2660DW/DCP-L2665DW/MFC-L2860DWE/MFC-L2860DW/MFC-L2862DW/ MFC-L2922DW/MFC-L2960DW/MFC-L2980DW

1. [Load your document.](#)
2. Press [Scan] > [to PC] > [to OCR].
3. If the machine is connected over the network, press ▲ or ▼ to display the computer where you want to send data, and then press the computer name.



If the LCD prompts you to enter a PIN for the computer, enter the four-digit PIN on the LCD and then press [OK].

4. To change the scan settings, press  [Options], and then select the scan settings you want to change. Skip this step if you want to use the default scan settings.
 - [2-sided Scan] (available for certain models)
 - [Scan Settings]
 - [Colour Setting]
 - [Resolution]
 - [File Type]
 - [Document Size]
 - [Brightness]
 - [Contrast] (available only for certain settings)
 - [ADF Auto Deskew] (available for certain models)
 - [Remove Background Colour] (available only for certain settings)



- To change the scan settings, a computer with Brother iPrint&Scan installed must be connected to your machine.
- When your machine displays the [OK] button, press [OK].
- To save the settings as a shortcut, press [Save as Shortcut].

5. Press [Start].

The machine starts scanning. If using the machine's scanner glass, follow the LCD instructions to complete the scanning job.

Related Information

- [Scan Using the Scan Button on Your Machine](#)

Related Topics:

- [Change the Scan Button Settings from Brother iPrint&Scan](#)

Save Scanned Data as an Email Attachment

Send the scanned data from your machine to your email application as an attachment.

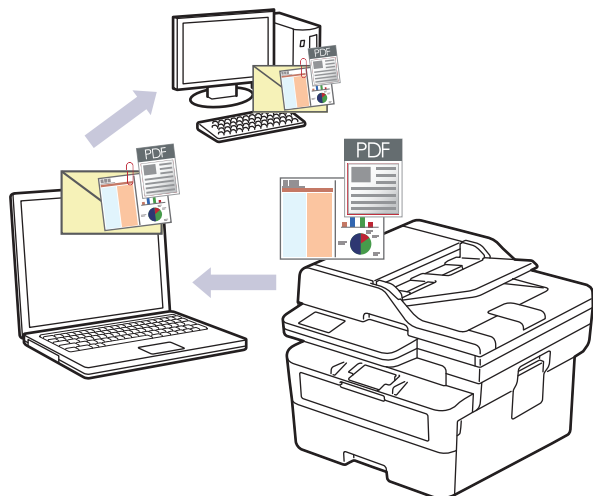

- Use the Scan button on the machine to make temporary changes to the scan settings. To make permanent changes, use Brother iPrint&Scan.
- To use this feature with your machine's Scan button, make sure you select one of these applications in Brother iPrint&Scan:
 - Windows: Microsoft Outlook
 - Mac: Apple MailFor other applications and Webmail services, use the Scan to Image or Scan to File feature to scan a document, and then attach the scanned file to an email message.

>> DCP-L2600D/DCP-L2620DW/DCP-L2622DW/DCP-L2627DW/DCP-L2627DWXL/DCP-L2627DWE/
DCP-L2640DN/MFC-L2802DN/MFC-L2800DW/MFC-L2802DW/MFC-L2827DWXL/MFC-L2827DW/
MFC-L2835DW
>> DCP-L2660DW/DCP-L2665DW/MFC-L2860DWE/MFC-L2860DW/MFC-L2862DW/MFC-L2922DW/
MFC-L2960DW/MFC-L2980DW

**DCP-L2600D/DCP-L2620DW/DCP-L2622DW/DCP-L2627DW/DCP-L2627DWXL/
DCP-L2627DWE/DCP-L2640DN/MFC-L2802DN/MFC-L2800DW/MFC-L2802DW/
MFC-L2827DWXL/MFC-L2827DW/MFC-L2835DW**

1. Load your document.
2. Press  (Scan).
3. Press ▲ or ▼ to select the [to PC] option, and then press **OK**.
4. Press ▲ or ▼ to select the [E-mail] option, and then press **OK**.
5. If the machine is connected over the network, press ▲ or ▼ to select the destination computer.
6. Press **OK**.



If the LCD prompts you to enter a PIN, enter the four-digit PIN for the destination computer on the LCD and then press **OK**.

7. To change the scan settings for this document, press **Options** or **Copy/Scan Options**, press ▲ or ▼ to select the option you want, and then press **OK** to continue to the next scan setting. Skip this step if you want to use the default scan settings.
 - [Colour Setting]
 - [Resolution]

- [File Type]
- [Document Size]
- [ADF Auto Deskew] (available only for certain models)
- [Remove Bkg Clr] (available only for certain settings)



To change the scan settings, a computer with Brother iPrint&Scan installed must be connected to the machine.

8. Press **Start**.

The machine scans the document and saves it as a file attachment. It then launches your email application and opens a new, blank email message with the scanned file attached.

DCP-L2660DW/DCP-L2665DW/MFC-L2860DWE/MFC-L2860DW/MFC-L2862DW/ MFC-L2922DW/MFC-L2960DW/MFC-L2980DW

1. [Load your document](#).
2. Press [Scan] > [to PC] > [to E-mail].
3. If the machine is connected over the network, press ▲ or ▼ to display the computer where you want to send data, and then press the computer name.



If the LCD prompts you to enter a PIN for the computer, enter the four-digit PIN on the LCD and then press [OK].

4. To change the scan settings, press  [Options], and then select the scan settings you want to change. Skip this step if you want to use the default scan settings.

- [2-sided Scan] (available for certain models)
- [Scan Settings]
- [Colour Setting]
- [Resolution]
- [File Type]
- [Document Size]
- [Brightness]
- [Contrast] (available only for certain settings)
- [ADF Auto Deskew] (available for certain models)
- [Remove Background Colour] (available only for certain settings)



- To change the scan settings, a computer with Brother iPrint&Scan installed must be connected to your machine.
- When your machine displays the [OK] button, press [OK].
- To save the settings as a shortcut, press [Save as Shortcut].

5. Press [Start].

The machine starts scanning. If using the machine's scanner glass, follow the LCD instructions to complete the scanning job.



Related Information

- [Scan Using the Scan Button on Your Machine](#)

Related Topics:

- [Change the Scan Button Settings from Brother iPrint&Scan](#)

Send Scanned Data to an Email Recipient

Related Models: MFC-L2802DN/MFC-L2800DW/MFC-L2802DW/MFC-L2827DWXL/MFC-L2827DW/
MFC-L2835DW/MFC-L2860DWE/MFC-L2860DW/MFC-L2862DW/MFC-L2922DW/MFC-L2960DW/
MFC-L2980DW

Send scanned data directly from your machine to an email recipient without using a computer. This function allows your machine to scan documents and send them to an email address without your machine being connected to a computer. To send the scanned data as an attachment directly to your default email application using the iPrint&Scan software on your computer or the Scan button on your machine, use the "Scan to Email Attachment" function instead.

- To send scanned data to an email recipient, you must configure your machine to communicate with your network and email server, which is used to send and receive emails.
- Configure these items from the machine's control panel or Web Based Management.
- To use the Scan to Email Server function, connect your machine to the network and access an SMTP server. Set up the following SMTP email settings:
 - Server address
 - Port number
 - User name
 - Encryption type (SSL or TLS)
 - Email server certificate (if used)

If you do not know these settings, contact your email service provider or network administrator.

>> [MFC-L2802DN/MFC-L2800DW/MFC-L2802DW/MFC-L2827DWXL/MFC-L2827DW/MFC-L2835DW](#)
>> [MFC-L2860DWE/MFC-L2860DW/MFC-L2862DW/MFC-L2922DW/MFC-L2960DW/MFC-L2980DW](#)

MFC-L2802DN/MFC-L2800DW/MFC-L2802DW/MFC-L2827DWXL/MFC-L2827DW/ MFC-L2835DW

1. [Load your document.](#)
2. Press  (**Scan**).
3. Press **▲** or **▼** to select the [Scan to E-mail] option, and then press **OK**.
4. To change the scan settings for this document, press **Options** or **Copy/Scan Options**, press **▲** or **▼** to select the option you want, and then press **OK** to continue to the next scan setting. Skip this step if you want to use the default scan settings.
 - [Colour Setting]
 - [Resolution]
 - [File Type]
 - [Document Size]
 - [File Size] (available only for certain settings)
 - [ADF Auto Des skew] (available only for certain models)
 - [Remove Bkg Clr] (available only for certain settings)
5. Select [Enter Address], and then press **OK**.
6. The LCD prompts you to enter an email address. Use the **Shortcut** button or Speed Dial number to select the email address you want.



To specify the destination email address, make sure you have added the email address to the Speed Dial or Shortcut using Web Based Management.

7. Press **Start**.

The machine starts scanning. If using the machine's scanner glass, follow the LCD instructions to complete the scanning job.

MFC-L2860DWE/MFC-L2860DW/MFC-L2862DW/MFC-L2922DW/MFC-L2960DW/MFC-L2980DW

1. [Load your document.](#)
2. Press [Scan] > [to E-mail Server].
3. Do one of the following to enter the destination email address:
 - To enter the email address manually, press [Manual], and then enter the email address using the character buttons on the LCD. When finished, press [OK].
 - If the email address is stored in the machine's address book, press [Address Book], and then select the email address.
Press [OK].
4. Confirm the email address, and then press [Next].
5. To change the settings, press  [Options], and then select the button you want to change. Skip this step if you want to use the default settings.
 - [2-sided Scan] (available only for certain models)
 - [Colour Setting]
 - [Resolution]
 - [File Type]
 - [Document Size]
 - [Brightness]
 - [Contrast] (available only for certain settings)
 - [File Name] (available only for certain settings)
 - [File Name Style]
 - [File Size] (available only for certain settings)
 - [ADF Auto Des skew] (available only for certain models)
 - [Remove Background Colour] (available only for certain settings)
 - [Document Separation]



-
- When your machine displays the [OK] button, press [OK].
 - To set your own default settings: after making changes to settings, press the [Set New Default] option, and then press [Yes].
 - To restore the factory settings: press [Factory Reset], and then press [Yes].
 - To save the settings as a shortcut, press [Save as Shortcut].
-

6. Press [Start].

The machine starts scanning. If using the machine's scanner glass, follow the LCD instructions to complete the scanning job.

Related Information

- [Scan Using the Scan Button on Your Machine](#)
-

Scan to FTP

Related Models: DCP-L2640DN/DCP-L2660DW/DCP-L2665DW/MFC-L2860DWE/MFC-L2860DW/
MFC-L2862DW/MFC-L2922DW/MFC-L2960DW/MFC-L2980DW

Scan documents directly to an FTP server when you need to share the scanned information. For added convenience, configure different profiles to save your favourite Scan to FTP destinations.

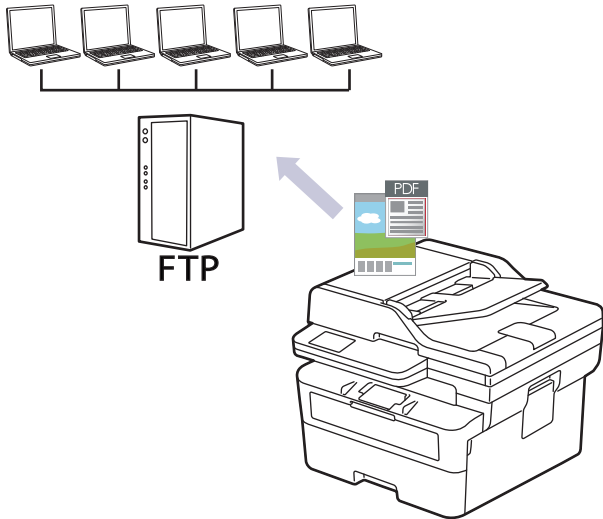

- [Set up a Scan to FTP Profile](#)
- [Upload Scanned Data to an FTP Server](#)

Set up a Scan to FTP Profile

Related Models: DCP-L2640DN/DCP-L2660DW/DCP-L2665DW/MFC-L2860DWE/MFC-L2860DW/MFC-L2862DW/MFC-L2922DW/MFC-L2960DW/MFC-L2980DW

Set up a Scan to FTP Profile to scan and upload the scanned data directly to an FTP location.

- We recommend using the latest version of the following web browsers:
 - Microsoft Edge, Firefox, and Google Chrome™ for Windows
 - Safari, Firefox, and Google Chrome™ for Mac
 - Google Chrome™ for Android™
 - Safari and Google Chrome™ for iOS
- Ensure that JavaScript and Cookies are always enabled, regardless of which browser you use.

1. Start your web browser.
2. Type "https://machine's IP address" in your browser's address bar (where "machine's IP address" is your machine's IP address).

For example:

https://192.168.1.2

3. If required, type the password in the **Login** field, and then click **Login**.



The default password to manage this machine's settings is located on the back of the machine and marked "Pwd". Change the default password by following the on-screen instructions when you first log in.

4. In the left navigation bar, click **Scan > Scan to FTP/Network**.



If the left navigation bar is not visible, start navigating from ☰.

5. Select the **FTP** option, and then click **Submit**.
6. In the left navigation bar, click **Scan > Scan to FTP/Network Profile**.
7. Select the profile you want to set up or change.



Using the following characters: ?, /, \, ", :, <, >, | or * may cause a sending error.

| Option | Description |
|---------------------|------------------------------------------------------------------------------------------------------------------------------------------------------------------------------|
| Profile Name | Type a name for this server profile (up to 15 alphanumeric characters). The machine will display this name on the LCD. |
| Host Address | Type the Host Address (for example: ftp.example.com; up to 64 characters) or the IP address (for example: 192.23.56.189). |
| Port Number | Change the Port Number setting used to access the FTP server. The default setting is port 21. In most cases this setting does not need to be changed. |
| Username | Type a user name (up to 32 characters) of a user that has permission to write data to the FTP server. |
| Password | Type the password (up to 32 characters) associated with the user name you entered in the Username field. Type the password again in the Retype password field. |
| SSL/TLS | Set the SSL/TLS option to scan securely using SSL/TLS communication. Change the CA Certificate setting, if needed. |

| Option | Description |
|----------------------------------------------------------------------------------------------------------------------------------------------|------------------------------------------------------------------------------------------------------------------------------------------------------------------------------------------------------------------------------------------------------------------------------------------------------------|
| Store Directory | Type the path (up to 60 characters) to the folder on the FTP server where you want to send your scanned data. Do not type a slash mark at the beginning of the path (correct example: brother/abc). |
| File Name | Select a file name prefix from the preset names provided, or from user-defined names. The file name used for the scanned document will be the file name prefix you select, followed by the last six digits of the flatbed/ADF scanner counter and the file extension (for example: "Estimate_098765.pdf"). |
| Quality | Select a quality setting. If you choose the User Select option, the machine will prompt users to select a setting each time they use the scan profile. |
| File Type | Select the file type you want to use for the scanned document. If you choose the User Select option, the machine will prompt users to select a setting each time they use the scan profile. |
| Document Size | Select your document size from the list. This is necessary to make sure the scanned file is the correct size. If you choose the User Select option, the machine will prompt users to select a setting each time they use the scan profile. |
| File Size | Select your file size from the list. If you choose the User Select option, the machine will prompt users to select a setting each time they use the scan profile. |
| Auto Deskew or ADF Auto Deskew | Select the Auto option to set the machine to correct document skewing automatically as the pages are scanned. |
| 2-sided Scan (MFC-L2922DW/ MFC-L2960DW/MFC-L2980DW) | Select the Long Edge or Short Edge option to scan both sides of the document, depending on the layout of your original. |
| Remove Background Colour | Change the amount of background colour that is removed. |
| Document Separation (DCP-L2660DW/DCP-L2665DW/ MFC-L2860DWE/MFC-L2860DW/ MFC-L2862DW/MFC-L2922DW/ MFC-L2960DW/MFC-L2980DW) | Split a scanned image. When multiple documents have been scanned, you can split and save the documents separately by using this function. |
| Brightness | Select the brightness level. |
| Contrast | Select the contrast level. |
| Passive Mode | Set the Passive Mode option to off or on depending on your FTP server and network firewall configuration. The default setting is on. In most cases, this setting does not need to be changed. |

8. Click **Submit**.



Related Information

- [Scan to FTP](#)

Upload Scanned Data to an FTP Server

Related Models: DCP-L2640DN/DCP-L2660DW/DCP-L2665DW/MFC-L2860DWE/MFC-L2860DW/MFC-L2862DW/MFC-L2922DW/MFC-L2960DW/MFC-L2980DW

Share scanned information by saving it to your FTP server.

>> [DCP-L2640DN](#)

>> [DCP-L2660DW/DCP-L2665DW/MFC-L2860DWE/MFC-L2860DW/MFC-L2862DW/MFC-L2922DW/MFC-L2960DW/MFC-L2980DW](#)

DCP-L2640DN

1. [Load your document.](#)
2. Press  (**Scan**).
3. Press **▲** or **▼** to select the [to FTP] option, and then press **OK**.
4. Press **▲** or **▼** to select one of the profiles listed, and then press **OK**.

If the profile is not complete (for example, if the logon account name and password are missing or if the quality or file type is not specified), you will be prompted to enter any missing information.

5. Press **Start**.

The LCD shows the message [Connecting]. When the connection to the FTP server is successful, the machine starts scanning. If you are using the machine's scanner glass, follow the LCD instructions to complete the scanning job.

DCP-L2660DW/DCP-L2665DW/MFC-L2860DWE/MFC-L2860DW/MFC-L2862DW/MFC-L2922DW/MFC-L2960DW/MFC-L2980DW

1. [Load your document.](#)
2. Press [Scan] > [to FTP].
3. Press **▲** or **▼** to select one of the network server profiles listed. If the profile is not complete (for example, if the logon account name and password are missing, or if the quality or file type is not specified), you will be prompted to enter any missing information.
4. Press [Start].

The machine starts scanning. If using the machine's scanner glass, follow the LCD instructions to complete the scanning job.

Related Information

- [Scan to FTP](#)

Scan to Network (Windows)

Related Models: MFC-L2922DW/MFC-L2960DW/MFC-L2980DW

Scan documents directly to a CIFS server on your local network. For added convenience, you can configure different profiles to save your favourite Scan to Network destinations.

- [Set up a Scan to Network Profile](#)
- [Upload Scanned Data to a CIFS Server](#)

Set up a Scan to Network Profile

Related Models: MFC-L2922DW/MFC-L2960DW/MFC-L2980DW

Set up a Scan to Network Profile to scan and upload scanned data directly to a folder on a CIFS server.

- We recommend using the latest version of the following web browsers:
 - Microsoft Edge, Firefox, and Google Chrome™ for Windows
 - Safari, Firefox, and Google Chrome™ for Mac
 - Google Chrome™ for Android™
 - Safari and Google Chrome™ for iOS
- Ensure that JavaScript and Cookies are always enabled, regardless of which browser you use.

1. Start your web browser.
2. Type "https://machine's IP address" in your browser's address bar (where "machine's IP address" is your machine's IP address).

For example:

https://192.168.1.2

3. If required, type the password in the **Login** field, and then click **Login**.



The default password to manage this machine's settings is located on the back of the machine and marked "Pwd". Change the default password by following the on-screen instructions when you first log in.

4. In the left navigation bar, click **Scan > Scan to FTP/Network**.



If the left navigation bar is not visible, start navigating from ☰.

5. Select the **Network** option, and then click **Submit**.



If you want to send the data to your designated folder on the CIFS server, select **On** for the **Send to My Folder** option.

6. In the left navigation bar, click **Scan > Scan to FTP/Network Profile**.
7. Select the profile you want to set up or change.



Using the following characters: ?, /, \, ", :, <, >, | or * may cause a sending error.

| Option | Description |
|----------------------------|------------------------------------------------------------------------------------------------------------------------------------------------------------------------------------------------------------------------------------------------------------------------------------------------------------|
| Profile Name | Type a name for this server profile (up to 15 alphanumeric characters). The machine will display this name on the LCD. |
| Network Folder Path | Type the path to the folder on the CIFS server where you want to send your scanned data. |
| File Name | Select a file name prefix from the preset names provided, or from user-defined names. The file name used for the scanned document will be the file name prefix you select, followed by the last six digits of the flatbed/ADF scanner counter and the file extension (for example: "Estimate_098765.pdf"). |
| Quality | Select a quality setting. If you choose the User Select option, the machine will prompt users to select a setting each time they use the scan profile. |

| Option | Description |
|---------------------------------------|----------------------------------------------------------------------------------------------------------------------------------------------------------------------------------------------------------------------------------------------------------------------------------------------------------------------------------------------------|
| File Type | Select the file type you want to use for the scanned document. If you choose the User Select option, the machine will prompt users to select a setting each time they use the scan profile. |
| Document Size | Select your document size from the list. This is necessary to make sure the scanned file is the correct size. If you choose the User Select option, the machine will prompt users to select a setting each time they use the scan profile. |
| File Size | Select your file size from the list. If you choose the User Select option, the machine will prompt users to select a setting each time they use the scan profile. |
| Auto Deskew or ADF Auto Deskew | Select the Auto option to set the machine to correct document skewing automatically as the pages are scanned. |
| 2-sided Scan | Select the Long Edge or Short Edge option to scan both sides of the document, depending on the layout of your original. |
| Remove Background Colour | Change the amount of background colour that is removed. |
| Document Separation | Split a scanned image. When multiple documents have been scanned, you can split and save the documents separately by using this function. |
| Brightness | Select the brightness level. |
| Contrast | Select the contrast level. |
| Use PIN for Authentication | To PIN-protect this profile, select On and type a four-digit PIN in the PIN Code field. |
| Auth. Method | To set your authentication method, select Auto , Kerberos , or NTLMv2 . |
| Username | Type a user name (up to 96 characters) of a user that has permission to write data to the folder specified in the Network Folder Path field. If the user name is part of a domain, enter the user name in one of the following styles: <ul style="list-style-type: none"> • user@domain • domain\user |
| Password | Type the password (up to 32 characters) associated with the user name you entered in the Username field. Type the password again in the Retype password field. |
| Kerberos Server Address | When you select Kerberos for the Auth. Method option, you must type the Kerberos Server Address (for example: kerberos.example.com; up to 64 characters). |

- Click **Submit**.
- You must configure the SNTP protocol (network time server) or set the date, time and time zone correctly on the control panel for all authentication methods. The machine's time must match the time used by the Kerberos Server and CIFS Server.



Related Information

- [Scan to Network \(Windows\)](#)
 - [Set the Date and Time Using Web Based Management](#)

Set the Date and Time Using Web Based Management

Make sure the date and time and the time zone settings are set correctly using Web Based Management or the control panel. The machine's time must match the time used by the server providing authentication.

- We recommend using the latest version of the following web browsers:
 - Microsoft Edge, Firefox, and Google Chrome™ for Windows
 - Safari, Firefox, and Google Chrome™ for Mac
 - Google Chrome™ for Android™
 - Safari and Google Chrome™ for iOS
- Ensure that JavaScript and Cookies are always enabled, regardless of which browser you use.
- Ignore step 1, if you already have a Web Based Management window open.

1. Start your web browser.
2. Type "https://machine's IP address" in your browser's address bar (where "machine's IP address" is your machine's IP address).

For example:

https://192.168.1.2

3. If required, type the password in the **Login** field, and then click **Login**.



The default password to manage this machine's settings is located on the back of the machine and marked "**Pwd**". Change the default password by following the on-screen instructions when you first log in.

4. In the left navigation bar, click **Administrator > Date&Time**.



If the left navigation bar is not visible, start navigating from ☰.

Date&Time

Date

██ / ██ / ████

Clock Type

12h Clock
 24h Clock

Time

██ : ██ (24 hr.)

Time Zone

UTC ▾

Auto Daylight

Off
 On

Synchronize with SNTP server

To synchronize the "Date&Time" with your SNTP server, you must configure the SNTP server settings.

[SNTP>>](#)

Cancel Submit

5. Clear the **Synchronize with SNTP server** checkbox.
6. In the **Date** fields, enter the date.
7. Select the clock type from the **Clock Type** field.
8. In the **Time** fields, enter the time.
9. Select the time difference between your location and UTC from the **Time Zone** drop-down list. For example, the time zone for Eastern time in the USA and Canada is UTC-05:00.
10. In the **Auto Daylight** field, click **On** to set the machine to change automatically to Daylight Saving Time. It will reset itself forward one hour in the spring, and back one hour in the autumn (available only for some countries).
11. Click **Submit**.



Related Information

- [Set up a Scan to Network Profile](#)

Upload Scanned Data to a CIFS Server

Related Models: MFC-L2922DW/MFC-L2960DW/MFC-L2980DW

1. [Load your document.](#)
2. Press [Scan] > [to Network].



- If you registered your user ID, the [to My Folder] option appears when you log on to the machine using Active Directory Authentication or LDAP Authentication.
- To send scanned data to your designated folder on the CIFS server, press [to My Folder].
- To enable this feature in Web Based Management, in the left navigation bar, click **Scan > Scan to FTP/Network**. In the **Send to My Folder** field, select **On**.

3. When the server profiles you set up using Web Based Management appear, select the profile you want. If the profile is not complete (for example, if the logon account name and password are missing, or if the quality or file type is not specified), you will be prompted to enter any missing information.
4. Press [Start].

The machine starts scanning. If using the machine's scanner glass, follow the LCD instructions to complete the scanning job.



Related Information

- [Scan to Network \(Windows\)](#)

Use the Web Services Protocol for Network Scanning (Windows 10 and Windows 11)



The Web Services protocol enables Windows 10 and Windows 11 users to scan using a Brother machine on the network. You must install the driver via Web Services.

- [Use the Web Services Protocol to Install the Scanner Driver \(Windows 10 and Windows 11\)](#)
- [Scan From Your Machine Using the Web Services Protocol \(Windows 10 and Windows 11\)](#)
- [Configure Scan Settings for the Web Services Protocol](#)

Use the Web Services Protocol to Install the Scanner Driver (Windows 10 and Windows 11)

Related Models: DCP-L2620DW/DCP-L2622DW/DCP-L2627DW/DCP-L2627DWXL/DCP-L2627DWE/DCP-L2640DN/DCP-L2660DW/DCP-L2665DW/MFC-L2802DN/MFC-L2800DW/MFC-L2802DW/MFC-L2827DWXL/MFC-L2827DW/MFC-L2835DW/MFC-L2860DWE/MFC-L2860DW/MFC-L2862DW/MFC-L2922DW/MFC-L2960DW/MFC-L2980DW

- Make sure you have installed the correct software and drivers for your machine.
- Verify that the host computer and the Brother machine are on the same subnet, or that the router is correctly configured to pass data between the two devices.
- You must configure the IP address on your Brother machine before you configure this setting.

1. Hold down the  key and press the  key on the computer's keyboard to launch **Run**.
2. Type "control printers" in the **Open:** field and click **OK**.

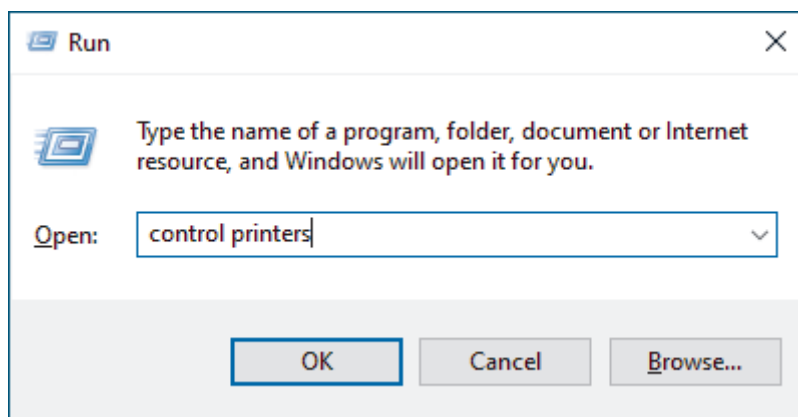

3. Click **Add a device**.



- The Web Services Name for the Brother machine is your model's name and the MAC Address.
- Move your mouse over the machine's name to display the machine's information.

4. Select the machine you want to install, and then follow the on-screen instructions.



To uninstall the drivers, click **Uninstall** or  (**Remove device**).



Related Information

- [Use the Web Services Protocol for Network Scanning \(Windows 10 and Windows 11\)](#)

Scan From Your Machine Using the Web Services Protocol (Windows 10 and Windows 11)

Related Models: DCP-L2620DW/DCP-L2622DW/DCP-L2627DW/DCP-L2627DWXL/DCP-L2627DWE/DCP-L2640DN/DCP-L2660DW/DCP-L2665DW/MFC-L2802DN/MFC-L2800DW/MFC-L2802DW/MFC-L2827DWXL/MFC-L2827DW/MFC-L2835DW/MFC-L2860DWE/MFC-L2860DW/MFC-L2862DW/MFC-L2922DW/MFC-L2960DW/MFC-L2980DW

If you have installed the scanner driver via Web Services, you can access the Web Services scanning menu on your machine's LCD.

Certain characters in the messages displayed on the LCD may be replaced with spaces if the language settings of your operating system and your machine are different.

>> DCP-L2620DW/DCP-L2622DW/DCP-L2627DW/DCP-L2627DWXL/DCP-L2627DWE/DCP-L2640DN/MFC-L2802DN/MFC-L2800DW/MFC-L2802DW/MFC-L2827DWXL/MFC-L2827DW/MFC-L2835DW
>> DCP-L2660DW/DCP-L2665DW/MFC-L2860DWE/MFC-L2860DW/MFC-L2862DW/MFC-L2922DW/MFC-L2960DW/MFC-L2980DW

**DCP-L2620DW/DCP-L2622DW/DCP-L2627DW/DCP-L2627DWXL/DCP-L2627DWE/
DCP-L2640DN/MFC-L2802DN/MFC-L2800DW/MFC-L2802DW/MFC-L2827DWXL/
MFC-L2827DW/MFC-L2835DW**

1. [Load your document.](#)
2. Press  (**Scan**).
3. Press ▲ or ▼ to select the [Web Service] option, and then press **OK**.
4. Press ▲ or ▼ to select the type of scan you want to do, and then press **OK**.
5. Select the destination computer where you want to send the scan, and then press **OK**.
6. Press **Start**.

The machine starts scanning.

**DCP-L2660DW/DCP-L2665DW/MFC-L2860DWE/MFC-L2860DW/MFC-L2862DW/
MFC-L2922DW/MFC-L2960DW/MFC-L2980DW**

1. [Load your document.](#)
2. Press [Scan] > [WS Scan].
3. Press ▲ or ▼ to display the scan options, and then press the type of scan.
4. Press ▲ or ▼ to display the computer name where you want to send data, and then press the computer name.
5. Press [Start].



The machine starts scanning.

Related Information

- [Use the Web Services Protocol for Network Scanning \(Windows 10 and Windows 11\)](#)

Configure Scan Settings for the Web Services Protocol

Related Models: DCP-L2620DW/DCP-L2622DW/DCP-L2627DW/DCP-L2627DWXL/DCP-L2627DWE/DCP-L2640DN/DCP-L2660DW/DCP-L2665DW/MFC-L2802DN/MFC-L2800DW/MFC-L2802DW/MFC-L2827DWXL/MFC-L2827DW/MFC-L2835DW/MFC-L2860DWE/MFC-L2860DW/MFC-L2862DW/MFC-L2922DW/MFC-L2960DW/MFC-L2980DW

1. Hold down the  key and press the  key on the computer's keyboard to launch **Run**.
2. Type "**control printers**" in the **Open:** field and click **OK**.

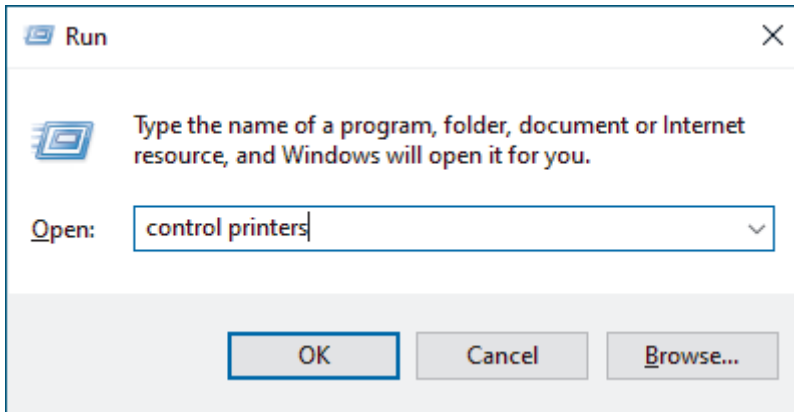

3. Right-click the machine icon, and then select **Scan profiles....** The **Scan Profiles** dialog box appears.
4. Select the scan profile you want to use.
5. Make sure the scanner selected in the **Scanner** list is a machine that supports Web Services for scanning, and then click the **Set as Default** button.
6. Click **Edit...**
The **Edit Default Profile** dialog box appears.
7. Select the **Source**, **Paper size**, **Colour format**, **File type**, **Resolution (DPI)**, **Brightness** and **Contrast** settings.
8. Click the **Save Profile** button.
These settings will be applied when you scan using the Web Services protocol.

If the machine prompts you to select a scanning application, select Windows Fax and Scan from the list.

Related Information

- [Use the Web Services Protocol for Network Scanning \(Windows 10 and Windows 11\)](#)

Change the Scan Button Settings from Brother iPrint&Scan

Brother iPrint&Scan allows you to change the machine's Scan Button settings.

1. Start Brother iPrint&Scan.

- Windows:

Double-click the  (Brother iPrint&Scan) icon on your computer's desktop.

For more information, see *Related Information*.

- Mac: (DCP-L2620DW/DCP-L2622DW/DCP-L2627DW/DCP-L2627DWXL/DCP-L2627DWE/DCP-L2640DN/DCP-L2660DW/DCP-L2665DW/MFC-L2802DN/MFC-L2800DW/MFC-L2802DW/MFC-L2827DWXL/MFC-L2827DW/MFC-L2835DW/MFC-L2860DWE/MFC-L2860DW/MFC-L2862DW/MFC-L2922DW/MFC-L2960DW/MFC-L2980DW)

In the **Finder** menu bar, click **Go > Applications**, and then double-click the iPrint&Scan icon.

The Brother iPrint&Scan screen appears.

NOTE

To download the latest application:

- For Windows:

Go to your model's **Downloads** page at support.brother.com/downloads, and then download and install Brother iPrint&Scan.

- For Mac: (DCP-L2620DW/DCP-L2622DW/DCP-L2627DW/DCP-L2627DWXL/DCP-L2627DWE/DCP-L2640DN/DCP-L2660DW/DCP-L2665DW/MFC-L2802DN/MFC-L2800DW/MFC-L2802DW/MFC-L2827DWXL/MFC-L2827DW/MFC-L2835DW/MFC-L2860DWE/MFC-L2860DW/MFC-L2862DW/MFC-L2922DW/MFC-L2960DW/MFC-L2980DW)

Download and install Brother iPrint&Scan from the Apple App Store.

2. If your Brother machine is not selected, click the **Select your Machine** button, and then follow the on-screen instructions to select your Brother machine.
3. Click the **Machine Scan Settings** button, and then follow the on-screen instructions to change the scan settings, such as document size, colour, and resolution.



Related Information

- [Scan Using the Scan Button on Your Machine](#)

Related Topics:

- [Scan Using Brother iPrint&Scan \(Windows/Mac\)](#)
- [Access Brother iPrint&Scan \(Windows/Mac\)](#)
- [Scan Photos and Graphics](#)
- [Scan Single or Multiple Pages to a Folder in a Single PDF File](#)
- [Scan to an Editable Text File \(OCR\)](#)
- [Save Scanned Data as an Email Attachment](#)

Configure Certificates for Signed PDFs

If you select Signed PDF for Scan features, you must configure a certificate on your machine using Web Based Management.

To use Signed PDF, you must install a certificate on your machine and your computer.

1. Start your web browser.
2. Type "https://machine's IP address" in your browser's address bar (where "machine's IP address" is your machine's IP address).

For example:

https://192.168.1.2

3. If required, type the password in the **Login** field, and then click **Login**.



The default password to manage this machine's settings is located on the back of the machine and marked "Pwd". Change the default password by following the on-screen instructions when you first log in.

4. In the left navigation bar, click **Administrator** > **Signed PDF**.



If the left navigation bar is not visible, start navigating from ☰.

Signed PDF

Select the Certificate

(To use the Signed PDF, you need to configure the certificate.
You can configure the certificate by clicking the link below.)

[Certificate>>](#)

5. Click the **Select the Certificate** drop-down list, and then select the certificate.
6. Click **Submit**.



Related Information

- [Scan Using the Scan Button on Your Machine](#)
-

Disable Scanning from Your Computer

Related Models: DCP-L2620DW/DCP-L2622DW/DCP-L2627DW/DCP-L2627DWXL/DCP-L2627DWE/DCP-L2640DN/DCP-L2660DW/DCP-L2665DW/MFC-L2802DN/MFC-L2800DW/MFC-L2802DW/MFC-L2827DWXL/MFC-L2827DW/MFC-L2835DW/MFC-L2860DWE/MFC-L2860DW/MFC-L2862DW/MFC-L2922DW/MFC-L2960DW/MFC-L2980DW

To disable the scan function on your computer, disable the Pull Scan setting using Web Based Management.

1. Start your web browser.
2. Type "https://machine's IP address" in your browser's address bar (where "machine's IP address" is your machine's IP address).

For example:

https://192.168.1.2

3. If required, type the password in the **Login** field, and then click **Login**.



The default password to manage this machine's settings is located on the back of the machine and marked "**Pwd**". Change the default password by following the on-screen instructions when you first log in.

4. In the left navigation bar, click **Scan > Scan from PC**.



If the left navigation bar is not visible, start navigating from ☰.

5. In the **Pull Scan** field, click **Disabled**.
6. Click **Submit**.



Related Information

- [Scan Using the Scan Button on Your Machine](#)

Scan from Your Computer (Windows)

There are several ways you can use your computer to scan photos and documents on your machine. Use the software applications we provide or use your favourite scanning application.

- [Scan Using Brother iPrint&Scan \(Windows/Mac\)](#)
- [Scan Using Nuance™ PaperPort™ 14SE or Other Windows Applications](#)
- [Scan Using Windows Fax and Scan](#)

Scan Using Brother iPrint&Scan (Windows/Mac)

1. Load your document.
2. Start Brother iPrint&Scan.

- Windows:

Double-click the  (Brother iPrint&Scan) icon on your computer's desktop.

For more information, see *Related Information*.

- Mac: (DCP-L2620DW/DCP-L2622DW/DCP-L2627DW/DCP-L2627DWXL/DCP-L2627DWE/DCP-L2640DN/DCP-L2660DW/DCP-L2665DW/MFC-L2802DN/MFC-L2800DW/MFC-L2802DW/MFC-L2827DWXL/MFC-L2827DW/MFC-L2835DW/MFC-L2860DWE/MFC-L2860DW/MFC-L2862DW/MFC-L2922DW/MFC-L2960DW/MFC-L2980DW)

In the **Finder** menu bar, click **Go > Applications**, and then double-click the iPrint&Scan icon.

The Brother iPrint&Scan screen appears.

NOTE

To download the latest application:

- For Windows:

Go to your model's **Downloads** page at support.brother.com/downloads, and then download and install Brother iPrint&Scan.

- For Mac: (DCP-L2620DW/DCP-L2622DW/DCP-L2627DW/DCP-L2627DWXL/DCP-L2627DWE/DCP-L2640DN/DCP-L2660DW/DCP-L2665DW/MFC-L2802DN/MFC-L2800DW/MFC-L2802DW/MFC-L2827DWXL/MFC-L2827DW/MFC-L2835DW/MFC-L2860DWE/MFC-L2860DW/MFC-L2862DW/MFC-L2922DW/MFC-L2960DW/MFC-L2980DW)

Download and install Brother iPrint&Scan from the Apple App Store.

3. If your Brother machine is not selected, click the **Select your Machine** button, and then select your model's name from the list. Click **OK**.
4. Click the **Scan** icon.
5. Configure the scan settings, and then click the **Scan** button to start scanning.
6. After all the documents have been scanned, select the option for saving and sharing scanned data.
7. Configure detailed settings, including the **File Name** and the **File Type**.



To combine multiple scans into a file, select PDF as the **File Type**.

8. Complete the scanning process.



Related Information

- [Scan from Your Computer \(Windows\)](#)

Related Topics:

- [Access Brother iPrint&Scan \(Windows/Mac\)](#)
- [Scan Photos and Graphics](#)
- [Scan Single or Multiple Pages to a Folder in a Single PDF File](#)



Scan Using Nuance™ PaperPort™ 14SE or Other Windows Applications

You can use the Nuance™ PaperPort™ 14SE application for scanning.

- This function is not available in countries subject to applicable export regulations.
- To download the Nuance™ PaperPort™ 14SE application, click  (**Brother Utilities**), select **Do More** in the left navigation bar, and then click **PaperPort**.
- Nuance™ PaperPort™ 14SE supports Windows 10 and Windows 11.
- For detailed instructions on using each application, click the application's **Help** menu, and then click **Getting Started Guide** in the **Help** ribbon.



The instructions for scanning in these steps are for PaperPort™ 14SE. For other Windows applications, the steps will be similar. PaperPort™ 14SE supports both TWAIN and WIA drivers; the TWAIN driver (recommended) is used in these steps.

1. [Load your document.](#)
2. Start PaperPort™ 14SE.
Do one of the following:
 - Windows 11
Click  > **All apps** > **Nuance PaperPort 14** > **PaperPort**.
 - Windows 10
Click  > **Nuance PaperPort 14** > **PaperPort**.
3. Click the **Desktop** menu, and then click **Scan Settings** in the **Desktop** ribbon.
The **Scan or Get Photo** panel appears on the left side of the screen.
4. Click **Select**.
5. From the available Scanners list, select your model with **TWAIN: TW** in the name.
6. Click **OK**.
7. Select the **Display scanner dialog box** checkbox in the **Scan or Get Photo** panel.
8. Click **Scan**.
The Scanner Setup dialog box appears.

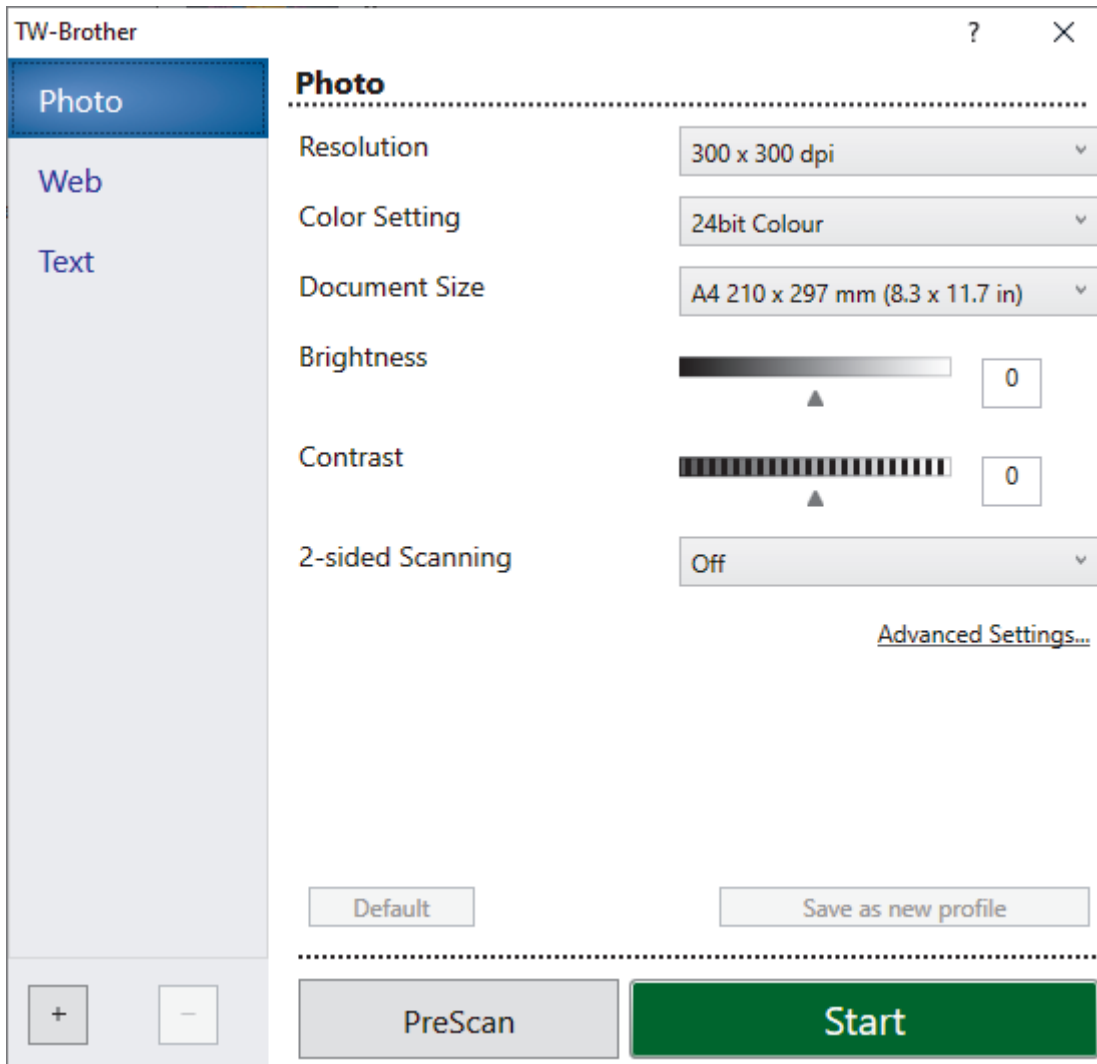

- Adjust the settings in the Scanner Setup dialog box, if needed.
- Click the **Document Size** drop-down list, and then select your document size.



To scan both sides of the document (MFC-L2922DW/MFC-L2960DW/MFC-L2980DW):
Automatic 2-sided scan is available only when using the ADF.
You cannot use PreScan to preview the scanned image.

- Click **PreScan** to preview your image and crop unwanted portions before scanning.
- Click **Start**.
The machine starts scanning.



Related Information

- [Scan from Your Computer \(Windows\)](#)
 - [TWAIN Driver Settings \(Windows\)](#)

TWAIN Driver Settings (Windows)

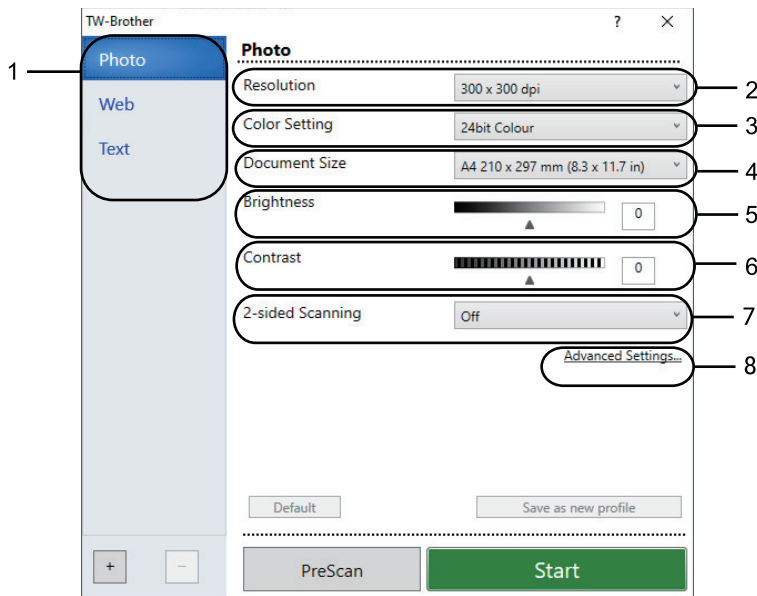

- Note that the item names and assignable values will vary depending on the machine.
- The **Contrast** option is available only when selecting the **Grey (Error Diffusion)**, **True Grey**, or **24bit Colour** options from the **Color Setting** drop-down list.

1. Scan

Select the **Photo**, **Web**, or **Text** option depending on the type of document you want to scan.

| Scan (Image Type) | | Resolution | Colour Setting |
|-------------------|------------------------------------------------|---------------|--------------------------|
| Photo | Use for scanning photo images. | 300 x 300 dpi | 24bit Colour |
| Web | Use for attaching scanned images to web pages. | 100 x 100 dpi | 24bit Colour |
| Text | Use for scanning text documents. | 200 x 200 dpi | Black & White |

2. Resolution

Select a scanning resolution from the **Resolution** drop-down list. Higher resolutions take more memory and transfer time, but produce a finer scanned image.

3. Color Setting

Select from a range of scan colour depths.

- Black & White**
Use for text or line art images.
- Grey (Error Diffusion)**
Use for photographic images or graphics. (Error Diffusion is a method for creating simulated grey images without using true grey dots. Black dots are arranged in a specific pattern to give a grey appearance.)
- True Grey**
Use for photographic images or graphics. This mode is more accurate because it uses up to 256 shades of grey.
- 24bit Colour**
Use to create an image with the most accurate colour reproduction. This mode uses up to 16.8 million colours to scan the image, but it requires the most memory and has the longest transfer time.

4. Document Size

Select the exact size of your document from a selection of preset scan sizes.

If you select **Custom**, the **Custom Document Size** dialog box appears and you can specify the document size.

5. Brightness

Set the brightness level by dragging the slider to the right or left to lighten or darken the image. If the scanned image is too light, set a lower brightness level and scan the document again. If the image is too dark, set a higher brightness level and scan the document again. You can also type a value in the field to set the brightness level.

6. Contrast

Increase or decrease the contrast level by moving the slider to the right or left. An increase emphasises dark and light areas of the image, while a decrease reveals more details in grey areas. You can also type a value in the field to set the contrast level.

7. 2-sided Scanning (MFC-L2922DW/MFC-L2960DW/MFC-L2980DW)

Scan both sides of the document. When using the Automatic 2-sided Scan feature, you must select the **Long-edge binding** or **Short-edge binding** option from the **2-sided Scanning** drop-down list, so that when you turn the pages, they are facing the way you want.

8. Advanced Settings

Configure advanced settings by clicking the **Advanced Settings** button in the Scan Settings dialog box.

- **Document Correction**

- **Auto Deskew**

- Set the machine to correct document skewing automatically as the pages are scanned.

- **Detect End of Page (ADF)**

- Detects the end of page and automatically adjusts the size of a page when the length of the document scanned from the ADF is shorter than the selected document size.

- **Rotate Image**

- Rotate the scanned image.

- **Fill With Color**

- Fill in the edges on four sides of the scanned image using the selected colour and range.

- **Image Quality**

- **Background Processing**

- **Remove Bleed-through / Pattern**

- Prevent bleed-through.

- **Remove Background Colour**

- Remove the base colour of documents to make the scanned data more legible.

- **Colour Drop**

- Select a colour to remove from the scanned image.

- **Edge Emphasis**

- Make the characters of the original sharper.

- **Reduce Noise**

- Improve the quality of your scanned images with this selection. The **Reduce Noise** option is available when selecting the **24bit Colour** option and the **300 x 300 dpi**, **400 x 400 dpi**, or **600 x 600 dpi** scan resolution.

- **B&W Image Quality**

- **Character Correction**

- **Blurred Character Correction**

- Correct the broken or incomplete characters of the original to make them easier to read.

- **Boldface Formatting**

- Emphasise the characters of the original by making them bold.

- **B&W Inversion**

Invert black and white in the monochrome image.

- **Feed Control**

- **Layout** (DCP-L2640DN/DCP-L2660DW/DCP-L2665DW/MFC-L2802DN/MFC-L2800DW/MFC-L2802DW/MFC-L2827DWXL/MFC-L2827DW/MFC-L2835DW/MFC-L2860DWE/MFC-L2860DW/MFC-L2862DW/MFC-L2922DW/MFC-L2960DW/MFC-L2980DW)

Select the layout.

- **Continuous Scan**

Select this option to scan multiple pages. After a page is scanned, select whether to continue scanning or finish.



Related Information

- [Scan Using Nuance™ PaperPort™ 14SE or Other Windows Applications](#)
-

Scan Using Windows Fax and Scan

The Windows Fax and Scan application is another option that you can use for scanning.

- Windows Fax and Scan uses the WIA scanner driver.
- To crop a portion of a page after pre-scanning a document, you must scan using the scanner glass (also called the flatbed).

1. [Load your document](#).
2. Launch Windows Fax and Scan.
3. Click **File > New > Scan**.
4. Select the scanner you want to use.
5. Click **OK**.

The **New Scan** dialog box appears.

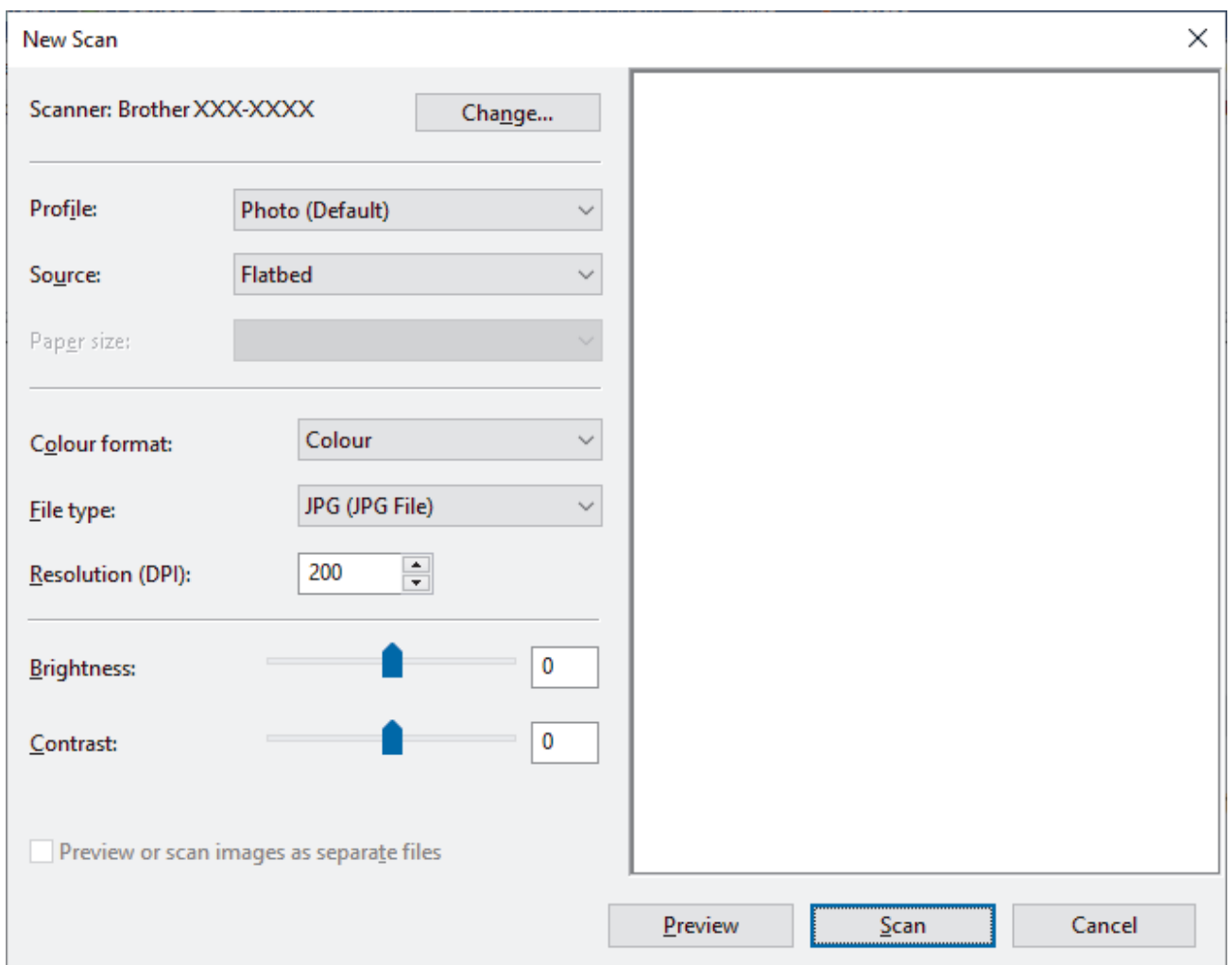

6. Adjust the settings in the dialog box, if needed.

The scanner resolution can be set to a maximum of 1200 dpi. If you want to scan at higher resolutions, use the **Scanner Utility** software from **Brother Utilities**.

If your machine supports 2-sided scanning and you want to scan both sides of your document, select **Feeder (Scan both sides)** from the **Source** drop-down list.

7. Click **Scan**.

The machine starts scanning the document.



Related Information

- [Scan from Your Computer \(Windows\)](#)
 - [WIA Driver Settings \(Windows\)](#)
-

WIA Driver Settings (Windows)

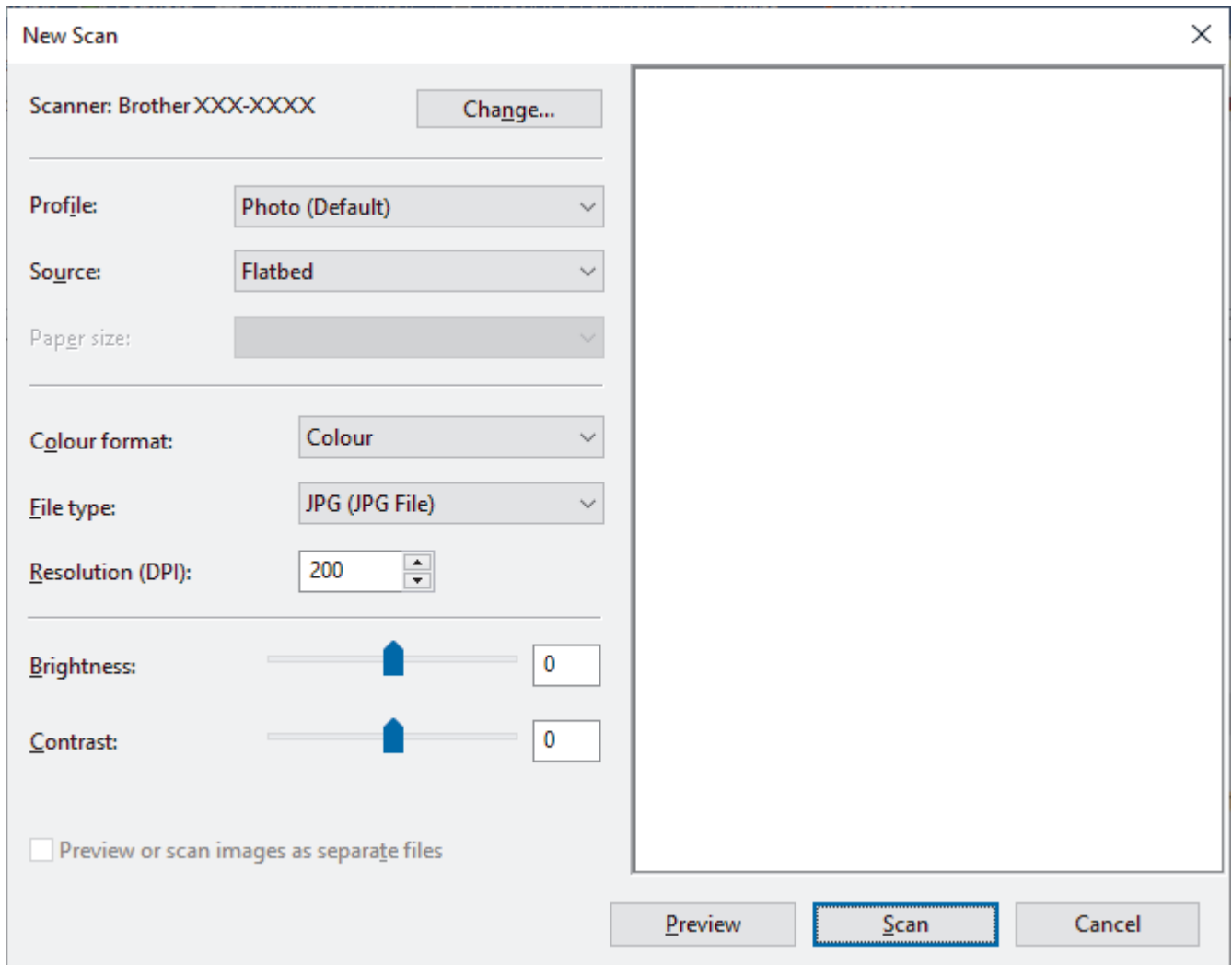

Profile

Select the scan profile you want to use from the **Profile** drop-down list.

Source

Select the **Flatbed**, **Feeder (Scan one side)**, or **Feeder (Scan both sides)** option from the drop-down list.

Paper size

The **Paper size** option is available if you select the **Feeder (Scan one side)** or **Feeder (Scan both sides)** option from the **Source** drop-down list.

Colour format

Select a scan colour format from the **Colour format** drop-down list.

File type

Select a file format from the **File type** drop-down list.

Resolution (DPI)

Set a scanning resolution in the **Resolution (DPI)** field. Higher resolutions take more memory and transfer time, but produce a finer scanned image.

Brightness

Set the brightness level by dragging the slider to the right or left to lighten or darken the image. If the scanned image is too light, set a lower brightness level and scan the document again. If the image is too dark, set a

higher brightness level and scan the document again. You can also type a value in the field to set the brightness level.

Contrast

Increase or decrease the contrast level by moving the slider to the right or left. An increase emphasises dark and light areas of the image, while a decrease reveals more details in grey areas. You can also type a value in the field to set the contrast level.



Related Information

- [Scan Using Windows Fax and Scan](#)

Scan from Your Computer (Mac)

- [Scan Using Brother iPrint&Scan \(Windows/Mac\)](#)
- [Scan Using AirPrint \(macOS\)](#)

Configure Scan Settings Using Web Based Management

- [Set the Scan File Name Using Web Based Management](#)

Set the Scan File Name Using Web Based Management

Set up a file name for scanned data using Web Based Management.

1. Start your web browser.
2. Type "https://machine's IP address" in your browser's address bar (where "machine's IP address" is your machine's IP address).

For example:

https://192.168.1.2

3. If required, type the password in the **Login** field, and then click **Login**.



The default password to manage this machine's settings is located on the back of the machine and marked "Pwd". Change the default password by following the on-screen instructions when you first log in.

4. In the left navigation bar, click **Scan > Scan File Name**.



If the left navigation bar is not visible, start navigating from ☰.

5. Select the **File Name Style** from the drop-down list.
6. If you selected the option to include the date in **File Name Style** field, select the date format from the drop-down list.
7. In the **Time** field, select **On** to include the time information in the file name.
8. In the **Counter** field, select **Continuous** or **Reset after each job**.



If you select **Reset after each job**, duplication of file names may occur.

9. If you want to create a user-defined file name prefix, type a file name in the user-defined fields of each scan function.



Do not use the following characters: ? / \ *

10. Click **Submit**.



Related Information

- [Configure Scan Settings Using Web Based Management](#)

Copy

- [Copy on One Side of the Paper \(1-sided\)](#)
- [Copy on Both Sides of the Paper \(2-sided\)](#)
- [Enlarge or Reduce Copied Images](#)
- [Make N in 1 Copies Using the Page Layout Feature](#)
- [Sort Copies](#)
- [Copy an ID Card](#)
- [Copy Options](#)

Copy on One Side of the Paper (1-sided)

>> DCP-L2600D/DCP-L2620DW/DCP-L2622DW/DCP-L2627DW/DCP-L2627DWXL/DCP-L2627DWE/
DCP-L2640DN/MFC-L2802DN/MFC-L2800DW/MFC-L2802DW/MFC-L2827DWXL/MFC-L2827DW/
MFC-L2835DW
>> DCP-L2660DW/DCP-L2665DW/MFC-L2860DWE/MFC-L2860DW/MFC-L2862DW/MFC-L2922DW/
MFC-L2960DW/MFC-L2980DW

**DCP-L2600D/DCP-L2620DW/DCP-L2622DW/DCP-L2627DW/DCP-L2627DWXL/
DCP-L2627DWE/DCP-L2640DN/MFC-L2802DN/MFC-L2800DW/MFC-L2802DW/
MFC-L2827DWXL/MFC-L2827DW/MFC-L2835DW**

1. Make sure you have loaded the correct size paper in the paper tray.
2. Do one of the following:
 - Place the document *face up* in the ADF. (available only for certain models)
(If you are copying multiple pages, we recommend using the ADF.)

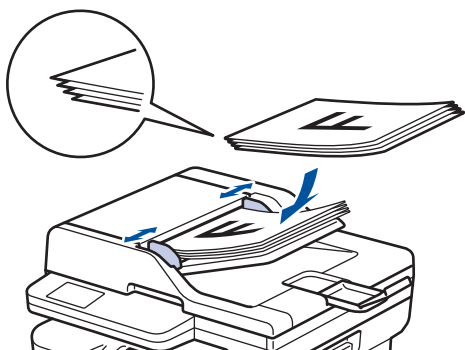

- Place the document *face down* on the scanner glass.

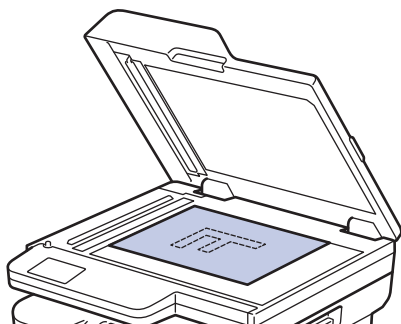

NOTE

For important or fragile documents, use the machine's scanner glass.

3. Do one of the following:
 - For MFC models
Press  (**Copy**).
Use the dial pad to enter the number of copies you want.
 - For DCP models
Press ▲ or ▼ to enter the number of copies you want.

The LCD displays:

```
Sort   Copies:01  
100%■■■■ Auto
```

4. Press **Start**.

**DCP-L2660DW/DCP-L2665DW/MFC-L2860DWE/MFC-L2860DW/MFC-L2862DW/
MFC-L2922DW/MFC-L2960DW/MFC-L2980DW**

1. Make sure you have loaded the correct size paper in the paper tray.
2. Do one of the following:
 - Place the document *face up* in the ADF.
(If you are copying multiple pages, we recommend using the ADF.)

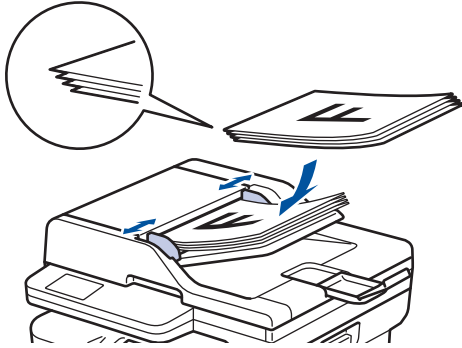

- Place the document *face down* on the scanner glass.

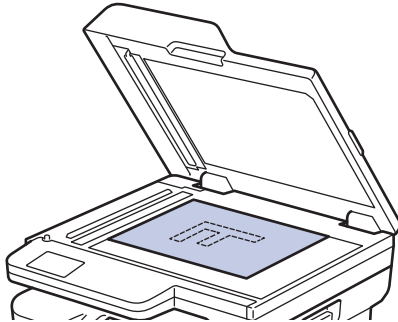

NOTE

For important or fragile documents, use the machine's scanner glass.

3. Press  ([Copy]).

The LCD displays:

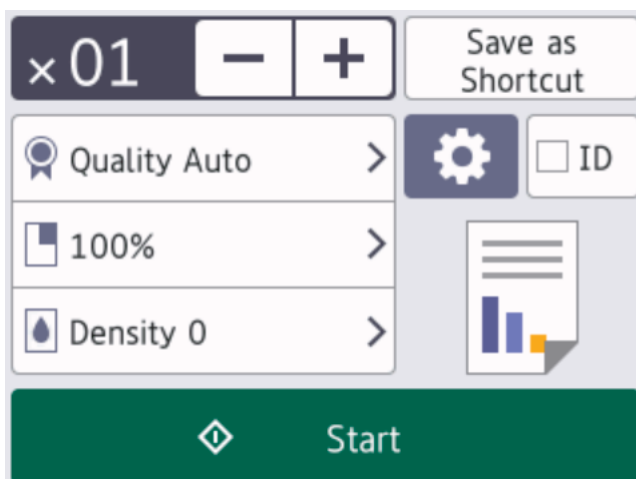

4. To enter the number of copies you want, do one of the following:
 - Press [-] or [+] using the LCD.
 - Press **x01** to display a numeric keypad on the LCD, and then enter the number of copies. Press [OK].
5. Press [Start].



Related Information

- [Copy](#)
-

Copy on Both Sides of the Paper (2-sided)

Reduce the amount of paper you use by copying onto both sides of the paper.

- You must choose a 2-sided copy layout from the following options before you can start 2-sided copying.
- The layout of your original document determines which 2-sided copy layout you should choose.
- (For ADF models) For important or fragile documents, use the machine's scanner glass.
- (For ADF models) To use the automatic 2-sided copy feature, you must load your document in the ADF.
- When you manually make 2-sided copies from a 2-sided document, use the scanner glass.
- Select A4 sized paper when using the 2-sided copy option.

Portrait

2-sided to 2-sided

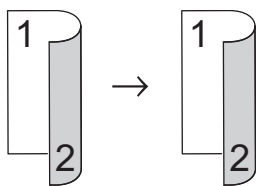

1-sided to 2-sided (Long Edge Flip)

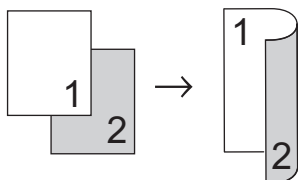

1-sided to 2-sided (Short Edge Flip)

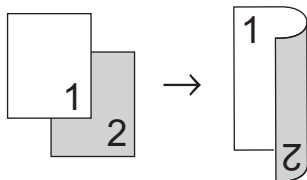

Landscape

2-sided to 2-sided

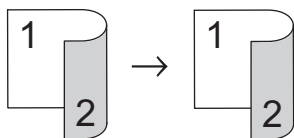

1-sided to 2-sided (Long Edge Flip)

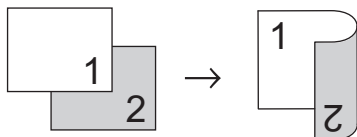

1-sided to 2-sided (Short Edge Flip)

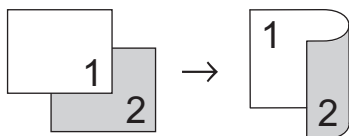

>> [DCP-L2600D/DCP-L2620DW/DCP-L2622DW/DCP-L2627DW/DCP-L2627DWXL/DCP-L2627DWE/DCP-L2640DN/MFC-L2802DN/MFC-L2800DW/MFC-L2802DW/MFC-L2827DWXL/MFC-L2827DW/MFC-L2835DW](#)
>> [DCP-L2660DW/DCP-L2665DW/MFC-L2860DWE/MFC-L2860DW/MFC-L2862DW/MFC-L2922DW/MFC-L2960DW/MFC-L2980DW](#)

**DCP-L2600D/DCP-L2620DW/DCP-L2622DW/DCP-L2627DW/DCP-L2627DWXL/
DCP-L2627DWE/DCP-L2640DN/MFC-L2802DN/MFC-L2800DW/MFC-L2802DW/
MFC-L2827DWXL/MFC-L2827DW/MFC-L2835DW**

1. [Load your document.](#)
2. Do one of the following:
 - For MFC models
Press  (**Copy**).
Use the dial pad to enter the number of copies you want.
 - For DCP models
Press ▲ or ▼ to enter the number of copies you want.
3. Do one of the following:
 - Press **2-sided**.
 - Press **Options** or **Copy/Scan Options**.
Press ▲ or ▼ to select [2-sided], and then press **OK**.
4. Press ▲ or ▼ to display [Layout Long] or [Layout Short], and then press **OK**.
5. Select flip on long edge or flip on short edge.
6. Press ▲ or ▼ to display [Long Edge] or [Short Edge], and then press **OK**.

NOTE

(For DCP-L2600D/DCP-L2620DW/DCP-L2622DW/DCP-L2627DW/DCP-L2627DWXL/DCP-L2627DWE/
DCP-L2640DN/MFC-L2802DN/MFC-L2800DW/MFC-L2802DW/MFC-L2827DWXL/MFC-L2827DW/
MFC-L2835DW) If you select [Long Edge], you cannot use the ADF. Use the scanner glass.

7. Press **Start**.
If you placed the document in the ADF, the machine scans the pages and starts printing.
If you are using the scanner glass, go to the next step.
8. After the machine scans the page, place the next page on the scanner glass, and then press ▲ to scan the next page.
9. After scanning all the pages, press ▼ to select the [No] option.

**DCP-L2660DW/DCP-L2665DW/MFC-L2860DWE/MFC-L2860DW/MFC-L2862DW/
MFC-L2922DW/MFC-L2960DW/MFC-L2980DW**

1. [Load your document.](#)
2. Press  ([Copy]).
3. Enter the number of copies.
4. Press [Options].
5. Press ▲ or ▼ to display the [2-sided Copy] option, and then press [2-sided Copy].
6. Press ▲ or ▼ to display the layout options, and then press the option you want.

NOTE

(For DCP-L2660DW/DCP-L2665DW/MFC-L2860DWE/MFC-L2860DW/MFC-L2862DW) If you select [2-sided⇒2-sided], you cannot use the ADF. Use the scanner glass.

7. When finished, press [OK].
8. Press [Start]. If you placed the document in the ADF, the machine scans the pages and starts printing.
If you are using the scanner glass, go to the next step.

-
9. After the machine scans the page, place the next page on the scanner glass, and then press [Continue] to scan the next page.
 10. When finished, press [Finish] to finish.



Related Information

- [Copy](#)
-

Enlarge or Reduce Copied Images

Select an enlargement or reduction ratio to resize your copied data.

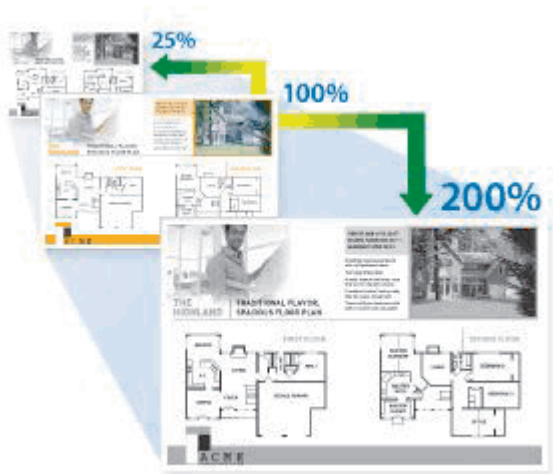

>> DCP-L2600D/DCP-L2620DW/DCP-L2622DW/DCP-L2627DW/DCP-L2627DWXL/DCP-L2627DWE/
DCP-L2640DN/MFC-L2802DN/MFC-L2800DW/MFC-L2802DW/MFC-L2827DWXL/MFC-L2827DW/
MFC-L2835DW
>> DCP-L2660DW/DCP-L2665DW/MFC-L2860DWE/MFC-L2860DW/MFC-L2862DW/MFC-L2922DW/
MFC-L2960DW/MFC-L2980DW

**DCP-L2600D/DCP-L2620DW/DCP-L2622DW/DCP-L2627DW/DCP-L2627DWXL/
DCP-L2627DWE/DCP-L2640DN/MFC-L2802DN/MFC-L2800DW/MFC-L2802DW/
MFC-L2827DWXL/MFC-L2827DW/MFC-L2835DW**

1. Load your document.
2. Do one of the following:
 - For MFC models
Press  (Copy).
Use the dial pad to enter the number of copies you want.
 - For DCP models
Press ▲ or ▼ to enter the number of copies you want.
3. Press **Options** or **Copy/Scan Options**.
4. Press ▲ or ▼ to select [Enlarge/Reduce], and then press **OK**.
5. Press ▲ or ▼ to select the enlargement or reduction ratio you want, and then press **OK**.
If you select [Custom (25-400%)], use the dial pad, or press ▲ or ▼ to enter an enlargement or reduction ratio from [25%] to [400%] and then press **OK**.
6. Press **Start**.



- [Auto] sets the machine to calculate the reduction ratio that best fits the size of paper.
- [Auto] is only available when using the ADF.

**DCP-L2660DW/DCP-L2665DW/MFC-L2860DWE/MFC-L2860DW/MFC-L2862DW/
MFC-L2922DW/MFC-L2960DW/MFC-L2980DW**

1. Load your document.
2. Press  ([Copy]).

-
3. Enter the number of copies.
 4. Press [Options].
 5. Press ▲ or ▼ to display the [Enlarge/Reduce] option, and then press [Enlarge/Reduce].
 6. Press ▲ or ▼ to display the available options, and then press the option you want to change.
 7. Do one of the following:
 - If you select [Enlarge] or [Reduce], press the enlargement or reduction ratio you want to use.
 - If you select [Custom (25-400%)], press  (backspace) to erase the displayed percentage, or press ◀ to move the cursor, and then enter an enlargement or reduction ratio from [25%] to [400%]. Press [OK].
 - If you selected [100%] or the [Auto] option, go to the next step.
 8. When finished, press [OK].
 9. Press [Start].



-
- [Auto] sets the machine to calculate the reduction ratio that best fits the size of paper.
 - [Auto] is only available when using the ADF.
-



Related Information

- [Copy](#)
-

Make N in 1 Copies Using the Page Layout Feature

The N in 1 copy feature saves paper by copying two or four pages of your document onto one page of the copy.



>> DCP-L2600D/DCP-L2620DW/DCP-L2622DW/DCP-L2627DW/DCP-L2627DWXL/DCP-L2627DWE/
DCP-L2640DN/MFC-L2802DN/MFC-L2800DW/MFC-L2802DW/MFC-L2827DWXL/MFC-L2827DW/
MFC-L2835DW
>> DCP-L2660DW/DCP-L2665DW/MFC-L2860DWE/MFC-L2860DW/MFC-L2862DW/MFC-L2922DW/
MFC-L2960DW/MFC-L2980DW



**DCP-L2600D/DCP-L2620DW/DCP-L2622DW/DCP-L2627DW/DCP-L2627DWXL/
DCP-L2627DWE/DCP-L2640DN/MFC-L2802DN/MFC-L2800DW/MFC-L2802DW/
MFC-L2827DWXL/MFC-L2827DW/MFC-L2835DW**

1. Load your document.
2. Do one of the following:
 - For MFC models
Press  (Copy).
Use the dial pad to enter the number of copies you want.
 - For DCP models
Press ▲ or ▼ to enter the number of copies you want.
3. Press **Options** or **Copy/Scan Options**.
4. Press ▲ or ▼ to select [Page Layout], and then press **OK**.
5. Press ▲ or ▼ to select [Off(1 in 1)], [2 in 1(P)], [2 in 1(L)], [4 in 1(P)] or [4 in 1(L)], and then press **OK**.
6. Press **Start**.
If you placed the document in the ADF, the machine scans the pages and starts printing.
If you are using the scanner glass, go to the next step.
7. After the machine scans the page, place the next page on the scanner glass, and then press ▲ to scan the next page.
8. After scanning all the pages, press ▼ to select the [No] option.

**DCP-L2660DW/DCP-L2665DW/MFC-L2860DWE/MFC-L2860DW/MFC-L2862DW/
MFC-L2922DW/MFC-L2960DW/MFC-L2980DW**

1. Load your document.

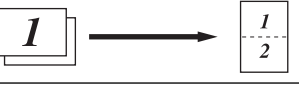
2. Press  ([Copy]).
3. Enter the number of copies.
4. Press [Options].
5. Press ▲ or ▼ to display the [Page Layout] option, and then press [Page Layout].
6. Press ▲ or ▼ to display the options, and then press the option you want.

| Option | Description |
|------------------|-----------------------------------------------------------------------------------|
| 2in1 (Portrait) |  |
| 2in1 (Landscape) |  |
| 4in1 (Portrait) |  |
| 4in1 (Landscape) |  |

7. When finished, press [OK].
8. Press [Start]. If you placed the document in the ADF, the machine scans the pages and starts printing.
If you are using the scanner glass, go to the next step.
9. After the machine scans the page, place the next page on the scanner glass, and then press [Continue] to scan the next page.
10. When finished, press [Finish] to finish.

✓ Related Information

- [Copy](#)

Sort Copies

Sort multiple copies. Pages will be stacked in the order they are fed, that is: 1, 2, 3, and so on.

>> DCP-L2600D/DCP-L2620DW/DCP-L2622DW/DCP-L2627DW/DCP-L2627DWXL/DCP-L2627DWE/
DCP-L2640DN/MFC-L2802DN/MFC-L2800DW/MFC-L2802DW/MFC-L2827DWXL/MFC-L2827DW/
MFC-L2835DW

>> DCP-L2660DW/DCP-L2665DW/MFC-L2860DWE/MFC-L2860DW/MFC-L2862DW/MFC-L2922DW/
MFC-L2960DW/MFC-L2980DW

**DCP-L2600D/DCP-L2620DW/DCP-L2622DW/DCP-L2627DW/DCP-L2627DWXL/
DCP-L2627DWE/DCP-L2640DN/MFC-L2802DN/MFC-L2800DW/MFC-L2802DW/
MFC-L2827DWXL/MFC-L2827DW/MFC-L2835DW**

1. [Load your document.](#)
2. Do one of the following:
 - For MFC models
Press  (**Copy**).
Use the dial pad to enter the number of copies you want.
 - For DCP models
Press ▲ or ▼ to enter the number of copies you want.
3. Press **Options** or **Copy/Scan Options**.
4. Press ▲ or ▼ to select [Stack/Sort], and then press **OK**.
5. Press ▲ or ▼ to select [Sort], and then press **OK**.
6. Press **Start**.
If you placed the document in the ADF, the machine scans the pages and starts printing.
If you are using the scanner glass, go to the next step.
7. After the machine scans the page, place the next page on the scanner glass, and then press ▲ to scan the next page.
8. After scanning all the pages, press ▼ to select the [No] option.

**DCP-L2660DW/DCP-L2665DW/MFC-L2860DWE/MFC-L2860DW/MFC-L2862DW/
MFC-L2922DW/MFC-L2960DW/MFC-L2980DW**

1. [Load your document.](#)
2. Press  ([Copy]).
3. Enter the number of copies.
4. Press [Options].
5. Press ▲ or ▼ to display the [Stack/Sort] option, and then press [Stack/Sort].
6. Press [Sort].
7. When finished, press [OK].
8. Press [Start]. If you placed the document in the ADF, the machine scans the pages and starts printing.
If you are using the scanner glass, go to the next step.
9. After the machine scans the page, place the next page on the scanner glass, and then press [Continue] to scan the next page.
10. When finished, press [Finish] to finish.



Related Information

- [Copy](#)
-

Copy an ID Card

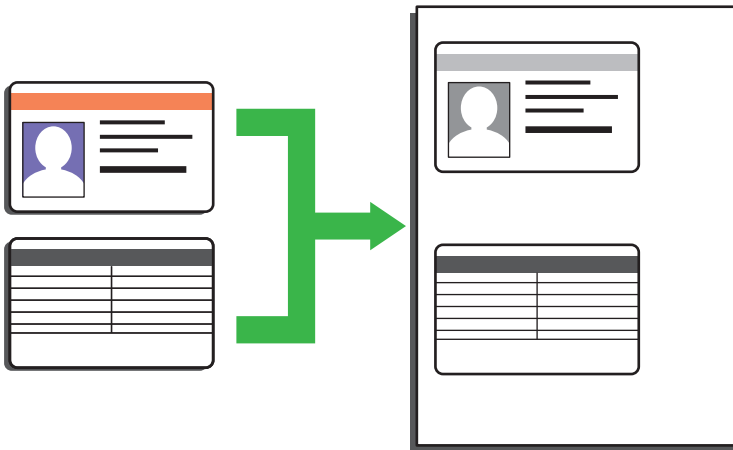

You may copy an identification card only to the extent permitted under applicable laws. For more detailed information, see the *Product Safety Guide*.

>> DCP-L2600D/DCP-L2620DW/DCP-L2622DW/DCP-L2627DW/DCP-L2627DWXL/DCP-L2627DWE/
DCP-L2640DN/MFC-L2802DN/MFC-L2800DW/MFC-L2802DW/MFC-L2827DWXL/MFC-L2827DW/
MFC-L2835DW

>> DCP-L2660DW/DCP-L2665DW/MFC-L2860DWE/MFC-L2860DW/MFC-L2862DW/MFC-L2922DW/
MFC-L2960DW/MFC-L2980DW

**DCP-L2600D/DCP-L2620DW/DCP-L2622DW/DCP-L2627DW/DCP-L2627DWXL/
DCP-L2627DWE/DCP-L2640DN/MFC-L2802DN/MFC-L2800DW/MFC-L2802DW/
MFC-L2827DWXL/MFC-L2827DW/MFC-L2835DW**

1. (For MFC models)

Press  (**Copy**).

2. Place an identification card *face down* near the upper left corner of the scanner glass.

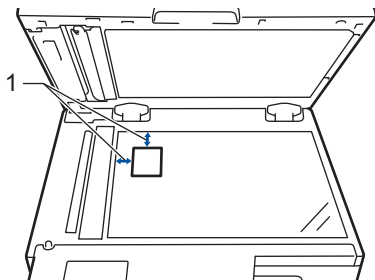

1 4.0 mm or greater (top, left)

3. Press **2 in 1 (ID) Copy**.

4. Do one of the following:

- For MFC models
Use the dial pad to enter the number of copies you want.
- For DCP models
Press ▲ or ▼ to enter the number of copies you want.

5. Press **Start**.

The machine scans one side of the identification card.

6. After the machine has scanned the first side, turn over the identification card.

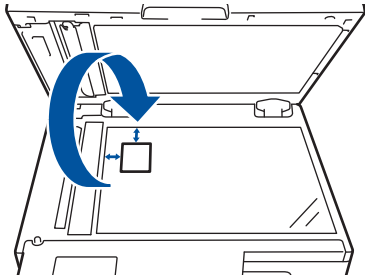

7. Press **Start** to scan the other side.

**DCP-L2660DW/DCP-L2665DW/MFC-L2860DWE/MFC-L2860DW/MFC-L2862DW/
MFC-L2922DW/MFC-L2960DW/MFC-L2980DW**

1. Place your identification card *face down* near the upper left corner of the scanner glass.

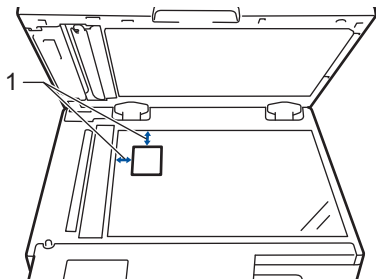

1 4.0 mm or greater (top, left)

2. Press  ([Copy]).

3. Press [ID].

4. Enter the number of copies.

5. Press [Start].

The machine scans one side of the identification card.

6. After the machine has scanned the first side, turn over the identification card and press [Continue] to scan the other side.

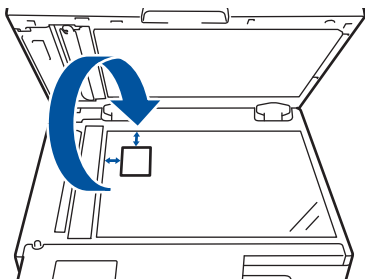

 **Related Information**

- [Copy](#)

Copy Options

>> DCP-L2600D/DCP-L2620DW/DCP-L2622DW/DCP-L2627DW/DCP-L2627DWXL/DCP-L2627DWE/
 DCP-L2640DN/MFC-L2802DN/MFC-L2800DW/MFC-L2802DW/MFC-L2827DWXL/MFC-L2827DW/
 MFC-L2835DW
 >> DCP-L2660DW/DCP-L2665DW/MFC-L2860DWE/MFC-L2860DW/MFC-L2862DW/MFC-L2922DW/
 MFC-L2960DW/MFC-L2980DW

DCP-L2600D/DCP-L2620DW/DCP-L2622DW/DCP-L2627DW/DCP-L2627DWXL/ DCP-L2627DWE/DCP-L2640DN/MFC-L2802DN/MFC-L2800DW/MFC-L2802DW/ MFC-L2827DWXL/MFC-L2827DW/MFC-L2835DW

To change Copy settings, press the **Options** or **Copy/Scan Options** button.

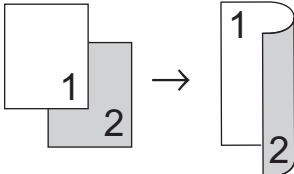
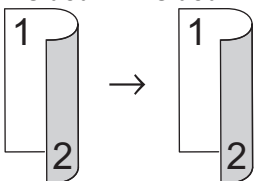
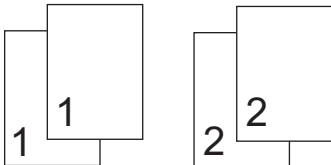
| Menu selections | Options | |
|-------------------------------------------------------|----------------------------------------------------------------------------------------------------------------------------------------------------------------------------------------------------------------------------------------------------------------------------------|-----------------------------------------------------------|
| Quality | Select the copy quality for your type of document. | |
| Enlarge/Reduce | 100% | - |
| | Enlarge | Select an enlargement ratio for the next copy. |
| | Reduce | Select a reduction ratio for the next copy. |
| | Auto (available only for certain models) | Adjusts the copy size to fit the paper size you have set. |
| | Custom (25-400%) | Enter an enlargement or reduction ratio. |
| Density | Increase the density to make the text darker. Decrease the density to make the text lighter. | |
| 2-sided (available only for certain models) | Select to copy on both sides of the paper. 1-sided → 2-sided  2-sided → 2-sided  | |
| Contrast | Increase the contrast to make an image clearer. Decrease the contrast to make an image more subdued. | |
| Stack/Sort | Select to stack or sort multiple copies. Stack  | |

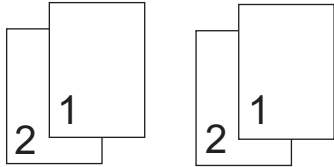
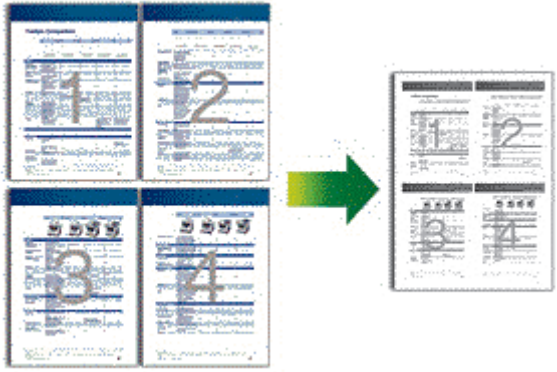
| Menu selections | Options |
|--------------------|----------------------------------------------------------------------------------------------------------------------------|
| | Sort  |
| Page Layout | Make N in 1 copies. 4 in 1  |

**DCP-L2660DW/DCP-L2665DW/MFC-L2860DWE/MFC-L2860DW/MFC-L2862DW/
MFC-L2922DW/MFC-L2960DW/MFC-L2980DW**

To change Copy settings, press [Options].

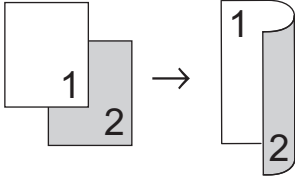
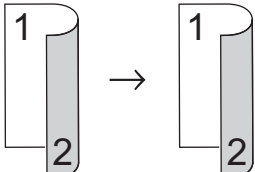
| Menu selections | Options | |
|-----------------------|----------------------------------------------------------------------------------------------------------------------------------------------------------------------------------------------------------------------------------------------------------------------------------|-----------------------------------------------------------|
| Quality | Select the copy quality for your type of document. | |
| Enlarge/Reduce | 100% | - |
| | Enlarge | Select an enlargement ratio for the next copy. |
| | Reduce | Select a reduction ratio for the next copy. |
| | Auto (available for certain models) | Adjusts the copy size to fit the paper size you have set. |
| | Custom (25-400%) | Enter an enlargement or reduction ratio. |
| Density | Increase the density to make the text darker. Decrease the density to make the text lighter. | |
| 2-sided Copy | Select to copy on both sides of the paper. 1-sided → 2-sided  2-sided → 2-sided  | |

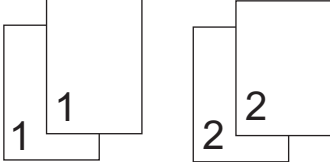
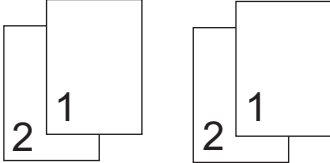
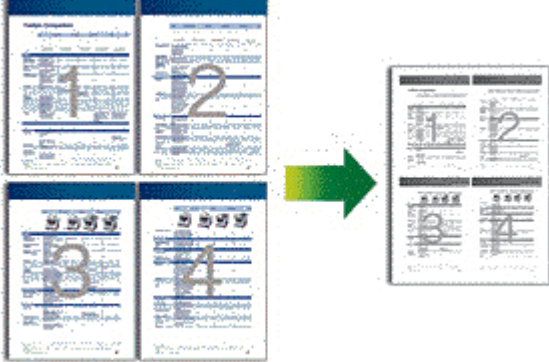
| Menu selections | Options |
|--------------------------------------------------------------------------|---------------------------------------------------------------------------------------------------------------------------------------------------------------------------------------------------------------------------------------------------|
| | The available options will vary depending on your model. |
| 2-sided Copy Page Layout (available only for certain settings) | Select long edge or short edge. |
| Contrast | Increase the contrast to make an image clearer. Decrease the contrast to make an image more subdued. |
| Stack/Sort | Select to stack or sort multiple copies. Stack  Sort  |
| Page Layout | Make N in 1 copies. 4 in 1  |

 **Related Information**

- [Copy](#)

Fax

Related Models: MFC-L2802DN/MFC-L2800DW/MFC-L2802DW/MFC-L2827DWXL/MFC-L2827DW/
MFC-L2835DW/MFC-L2860DWE/MFC-L2860DW/MFC-L2862DW/MFC-L2922DW/MFC-L2960DW/
MFC-L2980DW

- [Send a Fax](#)
- [Receive a Fax](#)
- [Voice Operations and Fax Numbers](#)
- [Telephone Services and External Devices](#)
- [Fax Reports](#)
- [PC-FAX](#)

Send a Fax

Related Models: MFC-L2802DN/MFC-L2800DW/MFC-L2802DW/MFC-L2827DWXL/MFC-L2827DW/
MFC-L2835DW/MFC-L2860DWE/MFC-L2860DW/MFC-L2862DW/MFC-L2922DW/MFC-L2960DW/
MFC-L2980DW

- [Send a Fax](#)
- [Send a 2-sided Fax from the ADF](#)
- [Send a Fax Manually](#)
- [Send a Fax at the End of a Conversation](#)
- [Send the Same Fax to More than One Recipient \(Broadcasting\)](#)
- [Send a Fax in Real Time](#)
- [Send a Fax at a Specified Time \(Delayed Fax\)](#)
- [Add a Cover Page to Your Fax](#)
- [Cancel a Fax in Progress](#)
- [Check and Cancel a Pending Fax](#)
- [Fax Options](#)

Send a Fax

Related Models: MFC-L2802DN/MFC-L2800DW/MFC-L2802DW/MFC-L2827DWXL/MFC-L2827DW/
MFC-L2835DW/MFC-L2860DWE/MFC-L2860DW/MFC-L2862DW/MFC-L2922DW/MFC-L2960DW/
MFC-L2980DW

>> [MFC-L2802DN/MFC-L2800DW/MFC-L2802DW/MFC-L2827DWXL/MFC-L2827DW/MFC-L2835DW](#)
>> [MFC-L2860DWE/MFC-L2860DW/MFC-L2862DW/MFC-L2922DW/MFC-L2960DW/MFC-L2980DW](#)

MFC-L2802DN/MFC-L2800DW/MFC-L2802DW/MFC-L2827DWXL/MFC-L2827DW/ MFC-L2835DW

1. Press  (Fax).
2. Do one of the following:
 - Place the document *face up* in the ADF.
(If you are faxing multiple pages, we recommend using the ADF.)

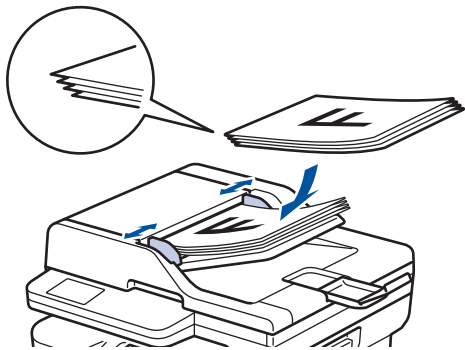

- Place the document *face down* on the scanner glass.

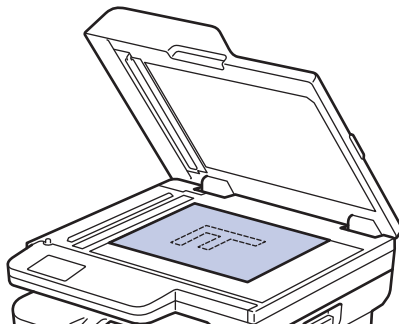

3. Enter the fax number.

- **Using the dial pad**

Enter the fax number using the dial pad.



- **Using the Shortcut Button**

Hold down the **Shortcut** button, and then enter the Shortcut number using the dial pad.

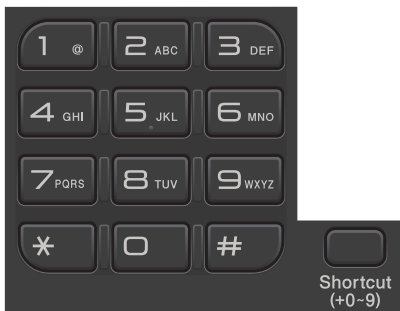

- **Using the Speed Dial Codes**

Press  twice, and then enter the three-digit Speed Dial code. Press **OK**.

4. Press **Start**.

The machine scans and sends the document.

If you placed the document on the scanner glass, follow the instructions in the table:

| Option | Description |
|-----------|---------------------------------------------------------------------------------------------------------------------------------------------------------|
| Yes | To scan the next page, press ▲ to select the Yes option, and then place the next page on the scanner glass. Press OK to scan the page. |
| No (Send) | When you have scanned the last page, press ▼ to select the No (Send) option (or press Start again). The machine sends the document. |

To stop faxing, press **Stop/Exit**.

MFC-L2860DWE/MFC-L2860DW/MFC-L2862DW/MFC-L2922DW/MFC-L2960DW/ MFC-L2980DW

1. Do one of the following:

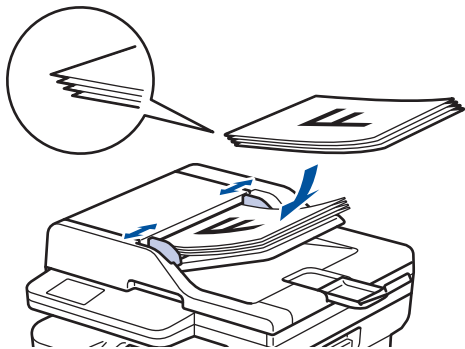

- Place the document *face up* in the ADF.
(If you are faxing multiple pages, we recommend using the ADF.)

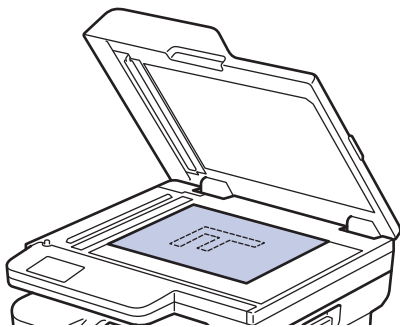

- Place the document *face down* on the scanner glass.



2. Do one of the following:

- If Fax Preview is set to [Off], press  ([Fax]).
- If Fax Preview is set to [On], press  ([Fax]), and then press [Send a fax].

3. Enter the fax number.

- **Using the dial pad**

Press the digits to enter the fax number.

| | | |
|---|---|---|
| 1 | 2 | 3 |
| 4 | 5 | 6 |
| 7 | 8 | 9 |
| * | 0 | # |

- **Using the Address Book**

Press  Address Book ([Address Book]), and then do one of the following:

- Press ▲ or ▼ to display the number you want, and then press it.
- Press , and then enter the name and press [OK]. Press the name you want to dial.

When finished, press [Apply].

- **Using the call history**

Press  Call History ([Call History]), and then press the [Outgoing Call] option.

Press ▲ or ▼ to display the fax number you want, and then press it.

To send a fax, press [Apply].

4. Press [Fax Start].

The machine scans and sends the document.

If you placed the document on the scanner glass, follow the instructions in the table.

| Option | Description |
|--------|----------------------------------------------------------------------------------------------------------------------------|
| Yes | To scan the next page, press the Yes option, and then place the next page on the scanner glass. Press OK to scan the page. |
| No | After you have scanned the last page, press the No option. The machine sends the document. |

To stop faxing, press .

When the LCD displays [Cancel Job?], press [Yes].



Related Information

- [Send a Fax](#)

Send a 2-sided Fax from the ADF

Related Models: MFC-L2922DW/MFC-L2960DW/MFC-L2980DW

You must select a 2-sided scanning format before sending a 2-sided fax. Select either the Long Edge or Short Edge option, depending on the layout of your document.

1. [Load your document.](#)
2. Do one of the following:
 - If Fax Preview is set to [Off], press  ([Fax]).
 - If Fax Preview is set to [On], press  ([Fax]), and then press [Send a fax].
3. Press  [Options] > [2-sided Fax].
4. Do one of the following:
 - If your document is flipped on the long edge, press the [2-sided Scan: Long Edge] option.
 - If your document is flipped on the short edge, press the [2-sided Scan: Short Edge] option.
5. Press [OK]
6. Enter the fax number.
7. Press [Fax Start].



Related Information

- [Send a Fax](#)

Send a Fax Manually

Related Models: MFC-L2802DN/MFC-L2800DW/MFC-L2802DW/MFC-L2827DWXL/MFC-L2827DW/MFC-L2835DW/MFC-L2860DWE/MFC-L2860DW/MFC-L2862DW/MFC-L2922DW/MFC-L2960DW/MFC-L2980DW

Manual fax transmission lets you hear the dialling, ringing and fax-receiving tones while sending a fax.





>> [MFC-L2802DN/MFC-L2800DW/MFC-L2802DW/MFC-L2827DWXL/MFC-L2827DW/MFC-L2835DW](#)

>> [MFC-L2860DWE/MFC-L2860DW/MFC-L2862DW/MFC-L2922DW/MFC-L2960DW/MFC-L2980DW](#)

MFC-L2802DN/MFC-L2800DW/MFC-L2802DW/MFC-L2827DWXL/MFC-L2827DW/MFC-L2835DW

1. Press  (**Fax**).
2. [Load your document](#).
3. Pick up the handset of the external telephone.
4. Dial the fax number you want to call.
5. When you hear the fax tone, press **Start**.
If you are using the scanner glass, press ▲.
6. Replace the handset of the external telephone.

MFC-L2860DWE/MFC-L2860DW/MFC-L2862DW/MFC-L2922DW/MFC-L2960DW/MFC-L2980DW

1. [Load your document](#).
2. Do one of the following:
 - If Fax Preview is set to [Off], press  ([Fax]).
 - If Fax Preview is set to [On], press  ([Fax]), and then press [Send a fax].
3. Pick up the handset of the external telephone.
4. Dial the fax number you want to call.
5. When you hear the fax tone, press  or , and then press [Fax Start].
If you are using the scanner glass, press [Send].
6. Replace the handset of the external telephone.

Related Information

- [Send a Fax](#)

Send a Fax at the End of a Conversation

Related Models: MFC-L2802DN/MFC-L2800DW/MFC-L2802DW/MFC-L2827DWXL/MFC-L2827DW/
MFC-L2835DW/MFC-L2860DWE/MFC-L2860DW/MFC-L2862DW/MFC-L2922DW/MFC-L2960DW/
MFC-L2980DW

At the end of a conversation, you can send a fax to the other party before you both hang up.

>> [MFC-L2802DN/MFC-L2800DW/MFC-L2802DW/MFC-L2827DWXL/MFC-L2827DW/MFC-L2835DW](#)

>> [MFC-L2860DWE/MFC-L2860DW/MFC-L2862DW/MFC-L2922DW/MFC-L2960DW/MFC-L2980DW](#)

MFC-L2802DN/MFC-L2800DW/MFC-L2802DW/MFC-L2827DWXL/MFC-L2827DW/ MFC-L2835DW

1. Ask the other party to wait for fax tones (beeps) and then to press the Start button before hanging up.
2. [Load your document](#).
3. Press **Start**.
If you are using the scanner glass, press ▲.
4. Replace the handset.

MFC-L2860DWE/MFC-L2860DW/MFC-L2862DW/MFC-L2922DW/MFC-L2960DW/ MFC-L2980DW

1. Ask the other party to wait for fax tones (beeps) and then to press the Start button before hanging up.
2. [Load your document](#).
3. Press [Fax Start].
If you are using the scanner glass, press [Send].
4. Replace the handset.

Related Information

- [Send a Fax](#)

Send the Same Fax to More than One Recipient (Broadcasting)

Related Models: MFC-L2802DN/MFC-L2800DW/MFC-L2802DW/MFC-L2827DWXL/MFC-L2827DW/MFC-L2835DW/MFC-L2860DWE/MFC-L2860DW/MFC-L2862DW/MFC-L2922DW/MFC-L2960DW/MFC-L2980DW

Use the Broadcasting feature to send the same fax to multiple fax numbers at the same time.

- The same broadcast can include Groups, Address Book numbers (Shortcut numbers and Speed Dial numbers in some models), and up to 50 manually dialed numbers.
- Address Book numbers (Shortcut numbers and Speed Dial numbers in some models) must be stored in the machine's memory before they can be used in a broadcast.
- Group numbers must also be stored in the machine's memory before they can be used in a broadcast. Group numbers include many stored Address Book numbers (Shortcut numbers and Speed Dial numbers in some models) for easier dialling.

>> [MFC-L2802DN/MFC-L2800DW/MFC-L2802DW/MFC-L2827DWXL/MFC-L2827DW/MFC-L2835DW](#)
>> [MFC-L2860DWE/MFC-L2860DW/MFC-L2862DW/MFC-L2922DW/MFC-L2960DW/MFC-L2980DW](#)

MFC-L2802DN/MFC-L2800DW/MFC-L2802DW/MFC-L2827DWXL/MFC-L2827DW/MFC-L2835DW



If you did not use any of the Shortcut numbers and the Speed Dial numbers for Groups, you can broadcast faxes to as many as 260 different numbers.

1. Press  (**Fax**).

2. [Load your document](#).

3. Enter a number, and press **OK**.

You can use Shortcut, Speed Dial, Group numbers and numbers manually entered using the dial pad.

Repeat this step to enter the all the numbers you want to broadcast to.

4. Press **Start**.



MFC-L2860DWE/MFC-L2860DW/MFC-L2862DW/MFC-L2922DW/MFC-L2960DW/MFC-L2980DW



If you did not use any of the Address Book numbers for Groups, you can broadcast faxes to as many as 250 different numbers.

1. [Load your document](#).

2. Do one of the following:

- If Fax Preview is set to [Off], press  ([Fax]).
- If Fax Preview is set to [On], press  ([Fax]), and then press [Send a fax].

3. Press  [Options] > [Broadcasting].

4. Press [Add Number].

You can add numbers to the broadcast in the following ways;

- Press [Add Number] and enter a fax number using the LCD.
Press [OK].
- Press [Add from Address book] to select numbers, and then press [OK].

- Press [Search in Address book] to search for a number.
Enter a name using the LCD, and then press [OK].
Select a name and a number you want to add.
- To broadcast using an email address, press , enter the email address, and press [OK].
(On certain models, you must download Internet Fax to use the Internet Fax feature and the Scan to Email server feature.)

5. When finished, press [OK].

6. Press [Fax Start].

7. Do one of the following:

- If you are using the ADF, the machine scans and sends the document.
- If you are using the scanner glass, the machine scans the first page.
When the LCD displays [Next page?], press an option shown in the table.

| Option | Description |
|--------|------------------------------------------------------------------------------------------------------------------------------------------|
| Yes | Select Yes to scan the next page. Place the Next page on the Scanner Glass, and then press OK. Repeat this step to scan all pages. |
| No | Select No to send the document. |



- The machine's available memory will vary depending on the types of jobs in the memory and the numbers used for broadcasting. If you broadcast to the maximum number available, you cannot use dual access and delayed fax.
- If the [Out of Memory] message appears, press  or [Quit] to cancel or [Send Now] to send the pages scanned so far.



Related Information

- [Send a Fax](#)
- [Cancel a Broadcast in Progress](#)

Cancel a Broadcast in Progress

Related Models: MFC-L2802DN/MFC-L2800DW/MFC-L2802DW/MFC-L2827DWXL/MFC-L2827DW/MFC-L2835DW/MFC-L2860DWE/MFC-L2860DW/MFC-L2862DW/MFC-L2922DW/MFC-L2960DW/MFC-L2980DW

While broadcasting multiple faxes, you can cancel just the fax currently being transmitted or cancel the whole broadcast job.

>> [MFC-L2802DN/MFC-L2800DW/MFC-L2802DW/MFC-L2827DWXL/MFC-L2827DW/MFC-L2835DW](#)
>> [MFC-L2860DWE/MFC-L2860DW/MFC-L2862DW/MFC-L2922DW/MFC-L2960DW/MFC-L2980DW](#)

MFC-L2802DN/MFC-L2800DW/MFC-L2802DW/MFC-L2827DWXL/MFC-L2827DW/MFC-L2835DW

1. Press **Menu**.
2. Press **▲** or **▼** to display the [Fax] option, and then press **OK**.
3. Press **▲** or **▼** to display the [Remaining Jobs] option, and then press **OK**.



The LCD will display the Broadcast job number followed by the fax number being dialled (for example, [#001123456789]) and the broadcast job number (for example, [Broadcast#001]).

4. Press **▲** or **▼** to display the fax number being dialled or the broadcast job number, and then press **OK**.
5. Press the option shown in the table to cancel or exit the cancel process.

| Option | Description |
|----------|---------------------------------------------------------------|
| ▲ | The machine cancels the fax currently being sent. |
| ▼ | The machine exits from the cancel process without cancelling. |

6. Press **Stop/Exit**.

MFC-L2860DWE/MFC-L2860DW/MFC-L2862DW/MFC-L2922DW/MFC-L2960DW/MFC-L2980DW

1. Press .
2. Do one of the following:
 - To cancel the entire broadcast, press [Entire Broadcast]. Press [Yes] to confirm or press [No] to exit without cancelling the broadcast.
 - To cancel the current job, press the name or number being cancelled on the LCD. Press [Yes] to confirm or press [No] to exit without cancelling the fax being sent.
 - To exit without cancelling, press .

Related Information

- [Send the Same Fax to More than One Recipient \(Broadcasting\)](#)

Send a Fax in Real Time

Related Models: MFC-L2802DN/MFC-L2800DW/MFC-L2802DW/MFC-L2827DWXL/MFC-L2827DW/
MFC-L2835DW/MFC-L2860DWE/MFC-L2860DW/MFC-L2862DW/MFC-L2922DW/MFC-L2960DW/
MFC-L2980DW

When sending a fax, the machine scans the document into the memory before sending it. As soon as the telephone line is free, the machine starts dialling and sending. If you want to send an important document immediately without waiting for the machine to retrieve the scan from its memory, turn [Real Time TX] on.



- If the memory is full and you are sending a fax from the ADF, the machine sends the document in real time (even if [Real Time TX] is set to [Off]). If the memory is full, faxes from the scanner glass cannot be sent until you clear some of the memory.
- In Real Time Transmission, the automatic redial feature does not work when using the scanner glass.
- If [Real Time TX] is set to on, the option to scan 2-sided documents is not available.

>> [MFC-L2802DN/MFC-L2800DW/MFC-L2802DW/MFC-L2827DWXL/MFC-L2827DW/MFC-L2835DW](#)
>> [MFC-L2860DWE/MFC-L2860DW/MFC-L2862DW/MFC-L2922DW/MFC-L2960DW/MFC-L2980DW](#)

MFC-L2802DN/MFC-L2800DW/MFC-L2802DW/MFC-L2827DWXL/MFC-L2827DW/ MFC-L2835DW

1. Press  (Fax).
2. Load your document.
3. Press **Menu**.
4. Press **▲** or **▼** to display the [Fax] option, and then press **OK**.
5. Press **▲** or **▼** to display the [Setup Send] option, and then press **OK**.
6. Press **▲** or **▼** to display the [Real Time TX] option, and then press **OK**.
7. Press **▲** or **▼** to display the [On] option, and then press **OK**.
8. When finished, press **Stop/Exit**.
9. Enter the fax number.
10. Press **Start**.

MFC-L2860DWE/MFC-L2860DW/MFC-L2862DW/MFC-L2922DW/MFC-L2960DW/ MFC-L2980DW

1. Load your document.
2. Do one of the following:
 - If Fax Preview is set to [Off], press  ([Fax]).
 - If Fax Preview is set to [On], press  ([Fax]), and then press [Send a fax].
3. Press  [Options] > [Real Time TX].
4. Press [On] or [Off].
5. Press [OK].
6. Enter the fax number.
7. Press [Fax Start].



Related Information

- [Send a Fax](#)
-

Send a Fax at a Specified Time (Delayed Fax)

Related Models: MFC-L2802DN/MFC-L2800DW/MFC-L2802DW/MFC-L2827DWXL/MFC-L2827DW/
MFC-L2835DW/MFC-L2860DWE/MFC-L2860DW/MFC-L2862DW/MFC-L2922DW/MFC-L2960DW/
MFC-L2980DW

You can store up to 50 faxes in the machine's memory to be sent within the next twenty-four hour period.

>> [MFC-L2802DN/MFC-L2800DW/MFC-L2802DW/MFC-L2827DWXL/MFC-L2827DW/MFC-L2835DW](#)

>> [MFC-L2860DWE/MFC-L2860DW/MFC-L2862DW/MFC-L2922DW/MFC-L2960DW/MFC-L2980DW](#)





MFC-L2802DN/MFC-L2800DW/MFC-L2802DW/MFC-L2827DWXL/MFC-L2827DW/ MFC-L2835DW

1. Press  (Fax).
2. Load your document.
3. Press **Options**.
4. Press **▲** or **▼** to display the [Delayed Fax] option, and then press **OK**.
5. Enter the time you want the fax to be sent.
 - If you set [12h Clock] in the [Date & Time] setting, enter the time in 12-hour format, and then press **OK**.
Press **▲** or **▼** to display the [AM] or [PM] option, and then press **OK**.
 - If you set [24h Clock] in the [Date & Time] setting, enter the time in 24-hour format, and then press **OK**.
(For example, enter 19:45 for 7:45 PM.)
6. Enter the fax number.
7. Press **Start**.



The number of pages you can scan into the memory depends on the amount of data printed on each page.

MFC-L2860DWE/MFC-L2860DW/MFC-L2862DW/MFC-L2922DW/MFC-L2960DW/ MFC-L2980DW

1. Load your document.
2. Do one of the following:
 - If Fax Preview is set to [Off], press  ([Fax]).
 - If Fax Preview is set to [On], press  ([Fax]), and then press [Send a fax].
3. Press  [Options] > [Delayed Fax] > [Delayed Fax].
4. Press [On].
5. Press [Set Time].
6. Enter the time you want the fax to be sent.
 - If you set [12h Clock] in the [Date & Time] setting, enter the time in 12-hour format.
Press the  button to select [AM] or [PM], and then press [OK].
 - If you set [24h Clock] in the [Date & Time] setting, enter the time in 24-hour format and then press [OK].
(For example, enter 19:45 for 7:45 PM.)
7. Press [OK]

-
8. Enter the fax number.
 9. Press [Fax Start].



Related Information

- [Send a Fax](#)
-

Add a Cover Page to Your Fax

Related Models: MFC-L2802DN/MFC-L2800DW/MFC-L2802DW/MFC-L2827DWXL/MFC-L2827DW/
MFC-L2835DW/MFC-L2860DWE/MFC-L2860DW/MFC-L2862DW/MFC-L2922DW/MFC-L2960DW/
MFC-L2980DW

You can add a cover page to the next fax or every outgoing fax.

- This feature will not work unless you have set up your Station ID.
- The cover page includes your Station ID, a comment, and the name stored in the Address Book, Shortcut, or Speed Dial (in some models).





>> [MFC-L2802DN/MFC-L2800DW/MFC-L2802DW/MFC-L2827DWXL/MFC-L2827DW/MFC-L2835DW](#)

>> [MFC-L2860DWE/MFC-L2860DW/MFC-L2862DW/MFC-L2922DW/MFC-L2960DW/MFC-L2980DW](#)

MFC-L2802DN/MFC-L2800DW/MFC-L2802DW/MFC-L2827DWXL/MFC-L2827DW/ MFC-L2835DW

1. Press  (**Fax**).
2. [Load your document](#).
3. Press **Options**.
4. Press **▲** or **▼** to display the [Coverpage] option, and then press **OK**.
5. Press **▲** or **▼** to display the [On] option, and then press **OK**.
6. Press **▲** or **▼** to display comment options, and then press **OK**.
7. Enter the number of total pages using the dial pad, and then press **OK**.
8. When finished, press **Stop/Exit**.
9. Enter the fax number.
10. Press **Start**.

MFC-L2860DWE/MFC-L2860DW/MFC-L2862DW/MFC-L2922DW/MFC-L2960DW/ MFC-L2980DW

1. [Load your document](#).
2. Do one of the following:
 - If Fax Preview is set to [Off], press  ([Fax]).
 - If Fax Preview is set to [On], press  ([Fax]), and then press [Send a fax].
3. Press  [Options] > [Coverpage Setup] > [Coverpage Setup].
4. Press [On].
5. Press [Coverpage Note].
6. Press **▲** or **▼** to display comment you want, and then press it.
7. Press [Total Pages].
8. Enter the number of total pages, and then press [OK].
9. Press .
10. Press [OK].
11. Enter the fax number.
12. Press [Fax Start].

The cover page will be added to the next fax. If you want to add the cover page to every outgoing fax, set the settings as the new default.



Related Information

- [Send a Fax](#)
 - [Create a Cover Page Message](#)
-

Create a Cover Page Message

Related Models: MFC-L2802DN/MFC-L2800DW/MFC-L2802DW/MFC-L2827DWXL/MFC-L2827DW/
MFC-L2835DW/MFC-L2860DWE/MFC-L2860DW/MFC-L2862DW/MFC-L2922DW/MFC-L2960DW/
MFC-L2980DW

Create up to two custom cover page messages to add to outgoing faxes.



>> [MFC-L2802DN/MFC-L2800DW/MFC-L2802DW/MFC-L2827DWXL/MFC-L2827DW/MFC-L2835DW](#)

>> [MFC-L2860DWE/MFC-L2860DW/MFC-L2862DW/MFC-L2922DW/MFC-L2960DW/MFC-L2980DW](#)

MFC-L2802DN/MFC-L2800DW/MFC-L2802DW/MFC-L2827DWXL/MFC-L2827DW/ MFC-L2835DW

1. Press  (Fax).
2. Press **Menu**.
3. Press **▲** or **▼** to display the [Fax] option, and then press **OK**.
4. Press **▲** or **▼** to display the [Setup Send] option, and then press **OK**.
5. Press **▲** or **▼** to display the [Coverpage Note] option to store your own comment, and then press **OK**.
6. Press **▲** or **▼** to display the [5.] or [6.] option to store your own comment, and then press **OK**.
7. Enter your own comment using the dial pad, and then press **OK**.
8. Press **Stop/Exit**.

MFC-L2860DWE/MFC-L2860DW/MFC-L2862DW/MFC-L2922DW/MFC-L2960DW/ MFC-L2980DW

1. Press  [Settings] > [All Settings] > [Fax] > [Setup Send] > [Coverpage Note].
2. Press [5.] or [6.] to store your own comment.
3. Enter your own comment using the LCD, and then press [OK].
4. Press .

Related Information

- [Add a Cover Page to Your Fax](#)

Cancel a Fax in Progress

Related Models: MFC-L2802DN/MFC-L2800DW/MFC-L2802DW/MFC-L2827DWXL/MFC-L2827DW/
MFC-L2835DW/MFC-L2860DWE/MFC-L2860DW/MFC-L2862DW/MFC-L2922DW/MFC-L2960DW/
MFC-L2980DW

>> [MFC-L2802DN/MFC-L2800DW/MFC-L2802DW/MFC-L2827DWXL/MFC-L2827DW/MFC-L2835DW](#)
>> [MFC-L2860DWE/MFC-L2860DW/MFC-L2862DW/MFC-L2922DW/MFC-L2960DW/MFC-L2980DW](#)

MFC-L2802DN/MFC-L2800DW/MFC-L2802DW/MFC-L2827DWXL/MFC-L2827DW/ MFC-L2835DW

1. Press **Stop/Exit** while the machine is dialling or sending a fax.
2. Press an option in the table to cancel or continue the fax job in progress.

| Option | Description |
|--------|------------------------------------------|
| ▲ | The machine cancels sending the fax job. |
| ▼ | The machine does not cancel the fax job. |

MFC-L2860DWE/MFC-L2860DW/MFC-L2862DW/MFC-L2922DW/MFC-L2960DW/ MFC-L2980DW

1. Press  while the machine is dialling or sending a fax.
The LCD will display [Cancel Job?].
2. Press an option in the table to cancel or continue the fax job in progress.

| Option | Description |
|--------|------------------------------------------|
| Yes | The machine cancels sending the fax job. |
| No | The machine does not cancel the fax job. |

Related Information

- [Send a Fax](#)

Check and Cancel a Pending Fax

Related Models: MFC-L2802DN/MFC-L2800DW/MFC-L2802DW/MFC-L2827DWXL/MFC-L2827DW/
MFC-L2835DW/MFC-L2860DWE/MFC-L2860DW/MFC-L2862DW/MFC-L2922DW/MFC-L2960DW/
MFC-L2980DW

You can cancel a fax job before it is sent, while it is stored in the memory.

>> [MFC-L2802DN/MFC-L2800DW/MFC-L2802DW/MFC-L2827DWXL/MFC-L2827DW/MFC-L2835DW](#)
>> [MFC-L2860DWE/MFC-L2860DW/MFC-L2862DW/MFC-L2922DW/MFC-L2960DW/MFC-L2980DW](#)



MFC-L2802DN/MFC-L2800DW/MFC-L2802DW/MFC-L2827DWXL/MFC-L2827DW/ MFC-L2835DW

1. Press  (Fax).
2. Press **Menu**.
3. Press **▲** or **▼** to display the [Fax] option, and then press **OK**.
4. Press **▲** or **▼** to display the [Remaining Jobs] option, and then press **OK**.
The LCD displays the number of jobs waiting in the memory to be sent.
5. Press **▲** or **▼** to display the job you want to cancel, and then press **OK**.
6. Press the options in the following table to cancel or exit the cancel process.

| Option | Description |
|----------|---------------------------------------------------------------|
| ▲ | The machine cancels the job. |
| ▼ | The machine exits from the cancel process without cancelling. |

7. Press **Stop/Exit**.

MFC-L2860DWE/MFC-L2860DW/MFC-L2862DW/MFC-L2922DW/MFC-L2960DW/ MFC-L2980DW

1. Press  [Settings] > [All Settings] > [Fax] > [Remaining Jobs].
2. Do the following steps for each job you want to check or cancel:
 - a. Press **▲** or **▼** to scroll through the waiting jobs, and then press the job you want to cancel.
 - b. Press [OK].
 - c. Press [Yes] to cancel the fax job or press [No] to exit without cancelling.
3. When finished cancelling jobs, press .

Related Information

- [Send a Fax](#)

Fax Options

Related Models: MFC-L2802DN/MFC-L2800DW/MFC-L2802DW/MFC-L2827DWXL/MFC-L2827DW/
MFC-L2835DW/MFC-L2860DWE/MFC-L2860DW/MFC-L2862DW/MFC-L2922DW/MFC-L2960DW/
MFC-L2980DW

>> [MFC-L2802DN/MFC-L2800DW/MFC-L2802DW/MFC-L2827DWXL/MFC-L2827DW/MFC-L2835DW](#)
>> [MFC-L2860DWE/MFC-L2860DW/MFC-L2862DW/MFC-L2922DW/MFC-L2960DW/MFC-L2980DW](#)

MFC-L2802DN/MFC-L2800DW/MFC-L2802DW/MFC-L2827DWXL/MFC-L2827DW/ MFC-L2835DW

To change the fax-sending settings, press the **Options** button.

| Option | Description |
|----------------|-------------------------------------------------------------------------------------------------------------------------|
| Fax Resolution | Set the resolution for outgoing faxes. The fax quality often can be improved by changing the Fax Resolution. |
| Contrast | Adjust the contrast. If your document is very light or very dark, changing the contrast may improve the fax quality. |
| Glass ScanSize | Adjust the scan area of the scanner glass to the size of the document. |
| Delayed Fax | Set the time of day the delayed faxes will be sent. |
| Real Time TX | Send a fax immediately without waiting for the machine to retrieve the scan from its memory. |
| Coverpage | Set the machine to automatically send a pre-programmed cover page. |
| Overseas Mode | Set to On if you have difficulty sending faxes overseas. |

MFC-L2860DWE/MFC-L2860DW/MFC-L2862DW/MFC-L2922DW/MFC-L2960DW/ MFC-L2980DW

To change the fax-sending settings, press  [Options].

| Option | Description |
|--------------------------------------------------------|-------------------------------------------------------------------------------------------------------------------------|
| Fax Resolution | Set the resolution for outgoing faxes. The fax quality often can be improved by changing the Fax Resolution. |
| Contrast | Adjust the contrast. If your document is very light or very dark, changing the contrast may improve the fax quality. |
| 2-sided Fax (For automatic 2-sided scanning models) | Set the 2-sided scanning format. |
| Glass Scan Size | Adjust the scan area of the scanner glass to the size of the document. |
| Broadcasting | Send the same fax message to more than one fax number at the same time. |
| Delayed Fax | Set the time of day the delayed faxes will be sent. |

| Option | Description |
|-----------------|----------------------------------------------------------------------------------------------|
| Real Time TX | Send a fax immediately without waiting for the machine to retrieve the scan from its memory. |
| Coverpage Setup | Set the machine to automatically send a pre-programmed cover page. |
| Overseas Mode | Set to On if you have difficulty sending faxes overseas. |
| Call History | Select a number from the Call History. |
| Address Book | Select a number from the Address Book. |
| Set New Default | Save your settings as the default. |
| Factory Reset | Restore all settings back to the factory settings. |



You can save the current settings by pressing [Save as Shortcut].



Related Information

- [Send a Fax](#)

Receive a Fax

Related Models: MFC-L2802DN/MFC-L2800DW/MFC-L2802DW/MFC-L2827DWXL/MFC-L2827DW/
MFC-L2835DW/MFC-L2860DWE/MFC-L2860DW/MFC-L2862DW/MFC-L2922DW/MFC-L2960DW/
MFC-L2980DW

- [Receive Mode Settings](#)
- [Memory Receive Options](#)
- [Remote Fax Retrieval](#)

Receive Mode Settings

Related Models: MFC-L2802DN/MFC-L2800DW/MFC-L2802DW/MFC-L2827DWXL/MFC-L2827DW/
MFC-L2835DW/MFC-L2860DWE/MFC-L2860DW/MFC-L2862DW/MFC-L2922DW/MFC-L2960DW/
MFC-L2980DW

- [Receive Modes Overview](#)
- [Choose the Correct Receive Mode](#)
- [Set the Number of Rings Before the Machine Answers \(Ring Delay\)](#)
- [Set the F/T Ring Time \(Fast Double-ring\)](#)
- [Set Fax Detect](#)
- [Shrink Page Size of an Oversized Incoming Fax](#)
- [Set the 2-sided Printing for Received Faxes](#)
- [Set the Fax Receive Stamp](#)
- [Receive a Fax at the End of a Telephone Conversation](#)
- [Restrict Incoming Faxes](#)

Receive Modes Overview

Related Models: MFC-L2802DN/MFC-L2800DW/MFC-L2802DW/MFC-L2827DWXL/MFC-L2827DW/
MFC-L2835DW/MFC-L2860DWE/MFC-L2860DW/MFC-L2862DW/MFC-L2922DW/MFC-L2960DW/
MFC-L2980DW

Some receive modes answer automatically (Fax Only Mode and Fax/Tel Mode). You may want to change the Ring Delay before using these modes.

Fax Only Mode

([Fax Only] in the machine's menu)

Fax Only Mode automatically answers every call as a fax.

Fax/Tel Mode

([Fax/Tel] in the machine's menu)

Fax/Tel Mode helps you manage incoming calls, by recognising whether they are fax or voice calls and handling them in the following ways:

- Faxes will be received automatically.
- Voice calls will start the F/T ring to tell you to pick up the call. The F/T ring is a fast pseudo/double-ring made by your machine.

Manual Mode

([Manual] in the machine's menu)

Manual Mode turns off all automatic answering operations unless you are using the BT Call Sign feature.

To receive a fax in Manual Mode, lift the handset of the external telephone connected to the machine.

When you hear fax tones (short repeating beeps), press the buttons in the table to receive a fax. Use the Fax Detect feature to receive faxes when you have lifted a handset on the same line as the machine.

| Applicable Models | To receive a fax |
|-------------------------------------------------------------------------------|----------------------------|
| MFC-L2802DN/MFC-L2800DW/MFC-L2802DW/MFC-L2827DWXL/ MFC-L2827DW/MFC-L2835DW | Start and then ▼ |
| MFC-L2860DWE/MFC-L2860DW/MFC-L2862DW/MFC-L2922DW/ MFC-L2960DW/MFC-L2980DW | Fax Start and then Receive |

External TAD Mode

([External TAD] in the machine's menu)

External TAD Mode lets an external answering device manage your incoming calls.

Incoming calls will be handled in the following ways:

- Faxes will be received automatically.
- Voice callers can record a message on the external TAD.

✓ Related Information

- [Receive Mode Settings](#)

Choose the Correct Receive Mode

Related Models: MFC-L2802DN/MFC-L2800DW/MFC-L2802DW/MFC-L2827DWXL/MFC-L2827DW/
MFC-L2835DW/MFC-L2860DWE/MFC-L2860DW/MFC-L2862DW/MFC-L2922DW/MFC-L2960DW/
MFC-L2980DW

You must choose a Receive Mode depending on the external devices and telephone services you have on your line.

By default, your machine will automatically receive any faxes that are sent to it. The diagram below will help you select the correct mode.

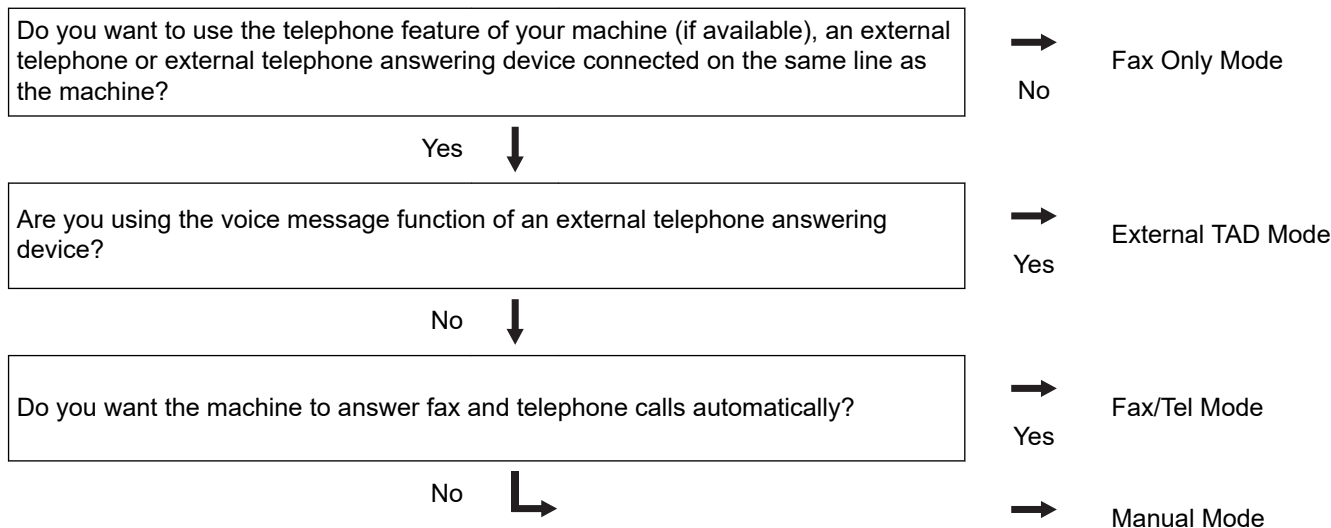

>> [MFC-L2802DN/MFC-L2800DW/MFC-L2802DW/MFC-L2827DWXL/MFC-L2827DW/MFC-L2835DW](#)
>> [MFC-L2860DWE/MFC-L2860DW/MFC-L2862DW/MFC-L2922DW/MFC-L2960DW/MFC-L2980DW](#)

MFC-L2802DN/MFC-L2800DW/MFC-L2802DW/MFC-L2827DWXL/MFC-L2827DW/ MFC-L2835DW

1. Press  (Fax).
2. Press **Menu**.
3. Press ▲ or ▼ to display the [Fax] option, and then press **OK**.
4. Press ▲ or ▼ to display the [Setup Receive] option, and then press **OK**.
5. Press ▲ or ▼ to display the [Receive Mode] option, and then press **OK**.



(U.K. only) If you cannot change the [Receive Mode] option, make sure the BT Call Sign feature is set to Off.

6. Press ▲ or ▼ to select the [Fax Only], [Fax/Tel], [External TAD], or [Manual] option, and then press **OK**.
7. Press **Stop/Exit**.

MFC-L2860DWE/MFC-L2860DW/MFC-L2862DW/MFC-L2922DW/MFC-L2960DW/ MFC-L2980DW

1. Press  [Settings] > [All Settings] > [Fax] > [Setup Receive] > [Receive Mode].



(U.K. only) If you cannot change the [Receive Mode], make sure the BT Call Sign feature is set to Off.

-
2. Press ▲ or ▼ to display the [Fax Only], [Fax/Tel], [External TAD], or [Manual] option, and then press the option you want.
 3. Press .

Related Information

- [Receive Mode Settings](#)

Related Topics:

- [Telephone and Fax Problems](#)
-

Set the Number of Rings Before the Machine Answers (Ring Delay)

Related Models: MFC-L2802DN/MFC-L2800DW/MFC-L2802DW/MFC-L2827DWXL/MFC-L2827DW/MFC-L2835DW/MFC-L2860DWE/MFC-L2860DW/MFC-L2862DW/MFC-L2922DW/MFC-L2960DW/MFC-L2980DW

When somebody calls your machine, you will hear the normal telephone ring sound. The number of rings is set in the Ring Delay option.

- The Ring Delay setting sets the number of times the machine rings before it answers in the Fax Only and Fax/Tel Modes.
- If you have external or extension telephones on the same line as the machine, choose the maximum number of rings.

>> [MFC-L2802DN/MFC-L2800DW/MFC-L2802DW/MFC-L2827DWXL/MFC-L2827DW/MFC-L2835DW](#)
>> [MFC-L2860DWE/MFC-L2860DW/MFC-L2862DW/MFC-L2922DW/MFC-L2960DW/MFC-L2980DW](#)

MFC-L2802DN/MFC-L2800DW/MFC-L2802DW/MFC-L2827DWXL/MFC-L2827DW/MFC-L2835DW

1. Press  (Fax).
2. Press **Menu**.
3. Press **▲** or **▼** to display the [Fax] option, and then press **OK**.
4. Press **▲** or **▼** to display the [Setup Receive] option, and then press **OK**.
5. Press **▲** or **▼** to display the [Ring Delay] option, and then press **OK**.
6. Press **▲** or **▼** to select the number of rings you want the line to ring before the machine answers, and then press **OK**.
7. Press **Stop/Exit**.



If you select [00], the machine will answer immediately and the line will not ring at all (available only for some countries).

MFC-L2860DWE/MFC-L2860DW/MFC-L2862DW/MFC-L2922DW/MFC-L2960DW/MFC-L2980DW

1. Press  [Settings] > [All Settings] > [Fax] > [Setup Receive] > [Ring Delay].
2. Press the number of rings you want the line to ring before the machine answers.



If you select [0], the machine will answer immediately and the line will not ring at all (available only for some countries).

3. Press .



Related Information

- [Receive Mode Settings](#)

Related Topics:

- [Telephone and Fax Problems](#)

Set the F/T Ring Time (Fast Double-ring)

Related Models: MFC-L2802DN/MFC-L2800DW/MFC-L2802DW/MFC-L2827DWXL/MFC-L2827DW/
MFC-L2835DW/MFC-L2860DWE/MFC-L2860DW/MFC-L2862DW/MFC-L2922DW/MFC-L2960DW/
MFC-L2980DW

When you set the Receive Mode to Fax/Tel Mode, if the call is a fax, your machine will automatically receive it. However, if it is a voice call, the machine will sound the F/T ring (fast double-ring) for the time you set in the F/T Ring Time option. When you hear the F/T ring, it means that a voice caller is on the line.

The F/T Ring Time feature works when you set Fax/Tel Mode as the Receive Mode.

Because the F/T ring is made by the machine, extension and external telephones will not ring; however, you can still answer the call on any telephone.

>> [MFC-L2802DN/MFC-L2800DW/MFC-L2802DW/MFC-L2827DWXL/MFC-L2827DW/MFC-L2835DW](#)
>> [MFC-L2860DWE/MFC-L2860DW/MFC-L2862DW/MFC-L2922DW/MFC-L2960DW/MFC-L2980DW](#)



MFC-L2802DN/MFC-L2800DW/MFC-L2802DW/MFC-L2827DWXL/MFC-L2827DW/ MFC-L2835DW

1. Press  (Fax).
2. Press **Menu**.
3. Press **▲** or **▼** to display the [Fax] option, and then press **OK**.
4. Press **▲** or **▼** to display the [Setup Receive] option, and then press **OK**.
5. Press **▲** or **▼** to display the [F/T Ring Time] option, and then press **OK**.
6. Press **▲** or **▼** to display how long the machine will ring to alert you that you have a voice call, and then press **OK**.
7. Press **Stop/Exit**.



Even if the caller hangs up during the pseudo/double-ringing, the machine will continue to ring for the set time.

MFC-L2860DWE/MFC-L2860DW/MFC-L2862DW/MFC-L2922DW/MFC-L2960DW/ MFC-L2980DW

1. Press  [Settings] > [All Settings] > [Fax] > [Setup Receive] > [F/T Ring Time].
2. Press **▲** or **▼** to display how long you want the machine to ring to alert you that you have a voice call.
3. Press .



Even if the caller hangs up during the pseudo/double-ringing, the machine will continue to ring for the set time.

✓ Related Information

- [Receive Mode Settings](#)

Set Fax Detect

Related Models: MFC-L2802DN/MFC-L2800DW/MFC-L2802DW/MFC-L2827DWXL/MFC-L2827DW/MFC-L2835DW/MFC-L2860DWE/MFC-L2860DW/MFC-L2862DW/MFC-L2922DW/MFC-L2960DW/MFC-L2980DW

If Fax Detect is On: The machine receives a fax call automatically, even if you answer the call. When you see [Receiving] on the LCD or when you hear “chirps” through the handset you are using, just replace the handset. Your machine will do the rest.

If Fax Detect is Off: If you are at the machine and answer a fax call by lifting the handset, press the buttons in the following table to receive the fax. If you answered at an extension or external telephone, press *51.

| Applicable Models | To receive a fax |
|---------------------------------------------------------------------------|-------------------------|
| MFC-L2802DN/MFC-L2800DW/MFC-L2802DW/MFC-L2827DWXL/MFC-L2827DW/MFC-L2835DW | Start and then ▼ |
| MFC-L2860DWE/MFC-L2860DW/MFC-L2862DW/MFC-L2922DW/MFC-L2960DW/MFC-L2980DW | Fax Start > Receive |





- If this feature is set to [On], but your machine does not connect a fax call when you lift an extension or external telephone handset, press the remote activation code *51.
- If you send faxes from a computer on the same telephone line and the machine intercepts them, set Fax Detect to [Off].

>> [MFC-L2802DN/MFC-L2800DW/MFC-L2802DW/MFC-L2827DWXL/MFC-L2827DW/MFC-L2835DW](#)
 >> [MFC-L2860DWE/MFC-L2860DW/MFC-L2862DW/MFC-L2922DW/MFC-L2960DW/MFC-L2980DW](#)

MFC-L2802DN/MFC-L2800DW/MFC-L2802DW/MFC-L2827DWXL/MFC-L2827DW/MFC-L2835DW

1. Press  (Fax).
2. Press **Menu**.
3. Press ▲ or ▼ to display the [Fax] option, and then press **OK**.
4. Press ▲ or ▼ to display the [Setup Receive] option, and then press **OK**.
5. Press ▲ or ▼ to display the [Fax Detect] option, and then press **OK**.
6. Press ▲ or ▼ to display the [On] (or [Off]) option, and then press **OK**.
7. Press **Stop/Exit**.

MFC-L2860DWE/MFC-L2860DW/MFC-L2862DW/MFC-L2922DW/MFC-L2960DW/MFC-L2980DW

1. Press  [Settings] > [All Settings] > [Fax] > [Setup Receive] > [Fax Detect].
2. Press [On] or [Off].
3. Press .

✓ Related Information

- [Receive Mode Settings](#)

Shrink Page Size of an Oversized Incoming Fax

Related Models: MFC-L2802DN/MFC-L2800DW/MFC-L2802DW/MFC-L2827DWXL/MFC-L2827DW/
MFC-L2835DW/MFC-L2860DWE/MFC-L2860DW/MFC-L2862DW/MFC-L2922DW/MFC-L2960DW/
MFC-L2980DW

If you enable the auto reduction function, the machine reduces each page of an incoming fax to fit on your paper. The machine calculates the reduction ratio by using the fax page size and your Paper Size setting.



>> [MFC-L2802DN/MFC-L2800DW/MFC-L2802DW/MFC-L2827DWXL/MFC-L2827DW/MFC-L2835DW](#)

>> [MFC-L2860DWE/MFC-L2860DW/MFC-L2862DW/MFC-L2922DW/MFC-L2960DW/MFC-L2980DW](#)

MFC-L2802DN/MFC-L2800DW/MFC-L2802DW/MFC-L2827DWXL/MFC-L2827DW/ MFC-L2835DW

1. Press  (Fax).
2. Press **Menu**.
3. Press **▲** or **▼** to display the [Fax] option, and then press **OK**.
4. Press **▲** or **▼** to display the [Setup Receive] option, and then press **OK**.
5. Press **▲** or **▼** to display the [Auto Reduction] option, and then press **OK**.
6. Press **▲** or **▼** to display the [On] (or [Off]) option, and then press **OK**.
7. Press **Stop/Exit**.

MFC-L2860DWE/MFC-L2860DW/MFC-L2862DW/MFC-L2922DW/MFC-L2960DW/ MFC-L2980DW

1. Press  [Settings] > [All Settings] > [Fax] > [Setup Receive] > [Auto Reduction].
2. Press [On] or [Off].
3. Press .

Related Information

- [Receive Mode Settings](#)

Set the 2-sided Printing for Received Faxes

Related Models: MFC-L2802DN/MFC-L2800DW/MFC-L2802DW/MFC-L2827DWXL/MFC-L2827DW/
MFC-L2835DW/MFC-L2860DWE/MFC-L2860DW/MFC-L2862DW/MFC-L2922DW/MFC-L2960DW/
MFC-L2980DW

Your machine prints received faxes on both sides of the paper when [2-sided] is set to [On].

- Use A4 size paper (60 to 105 g/m²) for this function.
- When 2-sided printing is enabled, incoming faxes are automatically reduced to fit the paper in the paper tray.



>> [MFC-L2802DN/MFC-L2800DW/MFC-L2802DW/MFC-L2827DWXL/MFC-L2827DW/MFC-L2835DW](#)

>> [MFC-L2860DWE/MFC-L2860DW/MFC-L2862DW/MFC-L2922DW/MFC-L2960DW/MFC-L2980DW](#)

MFC-L2802DN/MFC-L2800DW/MFC-L2802DW/MFC-L2827DWXL/MFC-L2827DW/ MFC-L2835DW

1. Press  (Fax).
2. Press **Menu**.
3. Press ▲ or ▼ to display the [Fax] option, and then press **OK**.
4. Press ▲ or ▼ to display the [Setup Receive] option, and then press **OK**.
5. Press ▲ or ▼ to display the [2-sided] option, and then press **OK**.
6. Press ▲ or ▼ to display the [On] (or [Off]) option, and then press **OK**.
7. Press **Stop/Exit**.

MFC-L2860DWE/MFC-L2860DW/MFC-L2862DW/MFC-L2922DW/MFC-L2960DW/ MFC-L2980DW

1. Press  [Settings] > [All Settings] > [Fax] > [Setup Receive] > [2-sided].
2. Press [On] or [Off].
3. Press .

Related Information

- [Receive Mode Settings](#)

Set the Fax Receive Stamp

Related Models: MFC-L2802DN/MFC-L2800DW/MFC-L2802DW/MFC-L2827DWXL/MFC-L2827DW/
MFC-L2835DW/MFC-L2860DWE/MFC-L2860DW/MFC-L2862DW/MFC-L2922DW/MFC-L2960DW/
MFC-L2980DW

You can set the machine to print the received date and time at the top centre of each received fax page.



- Make sure you have set the current date and time on the machine.
- The received time and date will not appear when using Internet Fax.

>> [MFC-L2802DN/MFC-L2800DW/MFC-L2802DW/MFC-L2827DWXL/MFC-L2827DW/MFC-L2835DW](#)
>> [MFC-L2860DWE/MFC-L2860DW/MFC-L2862DW/MFC-L2922DW/MFC-L2960DW/MFC-L2980DW](#)

MFC-L2802DN/MFC-L2800DW/MFC-L2802DW/MFC-L2827DWXL/MFC-L2827DW/ MFC-L2835DW

1. Press  (**Fax**).
2. Press **Menu**.
3. Press **▲** or **▼** to display the [**Fax**] option, and then press **OK**.
4. Press **▲** or **▼** to display the [**Setup Receive**] option, and then press **OK**.
5. Press **▲** or **▼** to display the [**Fax Rx Stamp**] option, and then press **OK**.
6. Press **▲** or **▼** to display the [**On**] (or [**Off**]) option, and then press **OK**.
7. Press **Stop/Exit**.

MFC-L2860DWE/MFC-L2860DW/MFC-L2862DW/MFC-L2922DW/MFC-L2960DW/ MFC-L2980DW

1. Press  [**Settings**] > [**All Settings**] > [**Fax**] > [**Setup Receive**] > [**Fax Rx Stamp**].
2. Press [**On**] or [**Off**].
3. Press .

✓ Related Information

- [Receive Mode Settings](#)

Receive a Fax at the End of a Telephone Conversation

Related Models: MFC-L2802DN/MFC-L2800DW/MFC-L2802DW/MFC-L2827DWXL/MFC-L2827DW/MFC-L2835DW/MFC-L2860DWE/MFC-L2860DW/MFC-L2862DW/MFC-L2922DW/MFC-L2960DW/MFC-L2980DW

If you are speaking on the telephone connected to your machine and the other party is also speaking on a telephone connected to his fax machine, at the end of the conversation, the other party can send you a fax before you both hang up.

Your machine's ADF must be empty.

>> [MFC-L2802DN/MFC-L2800DW/MFC-L2802DW/MFC-L2827DWXL/MFC-L2827DW/MFC-L2835DW](#)
>> [MFC-L2860DWE/MFC-L2860DW/MFC-L2862DW/MFC-L2922DW/MFC-L2960DW/MFC-L2980DW](#)

MFC-L2802DN/MFC-L2800DW/MFC-L2802DW/MFC-L2827DWXL/MFC-L2827DW/MFC-L2835DW

1. Ask the other party to place the document in their machine and to press the Start or Send button.
2. When you hear the CNG tones (slowly repeating beeps), press **Start**.
3. Press ▼ to receive a fax.
4. Replace the handset.

MFC-L2860DWE/MFC-L2860DW/MFC-L2862DW/MFC-L2922DW/MFC-L2960DW/MFC-L2980DW

1. Ask the other party to place the document in their machine and to press the Start or Send button.
2. When you hear the CNG tones (slowly repeating beeps), press [Fax Start].



- If the LCD is dark for Sleep Mode, touch it to display [Fax] option, and then press [Fax Start].
- If the machine is in Automatic Redial, wait until it is finished and try again.

3. Press [Receive] to receive a fax.
4. Replace the handset.

✓ Related Information

- [Receive Mode Settings](#)

Restrict Incoming Faxes

Related Models: MFC-L2800DW/MFC-L2827DWXL/MFC-L2827DW/MFC-L2835DW/MFC-L2860DWE/
MFC-L2860DW/MFC-L2960DW/MFC-L2980DW

- [Select a Method for Incoming Fax Restriction](#)
- [Accept Incoming Faxes Only from Registered Numbers](#)
- [Avoid Incoming Fax from Specific Numbers](#)

Select a Method for Incoming Fax Restriction

Related Models: MFC-L2860DWE/MFC-L2860DW/MFC-L2960DW/MFC-L2980DW

Your machine has two methods for incoming fax restriction. To accept receiving faxes from only specific numbers, use the Allow List. To avoid receiving faxes from specific numbers, use the Block List.

You must apply for the Caller ID service at your local telephone company to use the allow list and the block list functions.

1. Press  [Settings] > [All Settings] > [Fax] > [Incoming limit] > [Limit method].
2. Press one of the following options:

| Option | Description |
|------------|------------------------------------------------------------------------|
| Off | Select Off if you do not use the incoming fax function. |
| Allow List | Select Allow List to receive faxes only from the registered numbers. |
| Block List | Select Block List to avoid receiving faxes from any registered number. |

3. Press .

Related Information

- [Restrict Incoming Faxes](#)

Accept Incoming Faxes Only from Registered Numbers

Related Models: MFC-L2860DWE/MFC-L2860DW/MFC-L2960DW/MFC-L2980DW

- [Register a Number in the Allow List](#)
- [Delete a Number from the Allow List](#)
- [Print the Allow List](#)

Register a Number in the Allow List

Related Models: MFC-L2860DWE/MFC-L2860DW/MFC-L2960DW/MFC-L2980DW

If you want to accept receiving faxes only from the known numbers, register the numbers to the allow list.

- You must apply for the Caller ID service at your local telephone company.
- This feature blocks incoming calls and receiving faxes.
- The Caller ID feature is not available in some countries.

1. Press  [Settings] > [All Settings] > [Fax] > [Incoming limit] > [Allow List] > [Register].
2. Press one of the following options you want.

| Option | Description |
|----------------|----------------------------------------------------------------------------------------------------------------------------------------------------------------------------|
| Sync Addr Book | Select Sync Addr Book to synchronize the allow list with the address book. Follow the instruction on the LCD to activate or deactivate the synchronous function. |
| Manual Input | Select Manual Input to add numbers to the allow list manually. Follow the instruction on the LCD to register the number to the allow list. |
| From Outgoing | Select From Outgoing to add a number from the outgoing call history. Follow the instruction on the LCD to register the number to the allow list. |
| From Incoming | Select From Incoming to add a number from the incoming call history. Follow the instruction on the LCD to register the number to the allow list. |



3. Press .

Related Information

- [Accept Incoming Faxes Only from Registered Numbers](#)

Delete a Number from the Allow List

Related Models: MFC-L2860DWE/MFC-L2860DW/MFC-L2960DW/MFC-L2980DW

1. Press  [Settings] > [All Settings] > [Fax] > [Incoming limit] > [Allow List] > [Delete].
2. Press ▲ or ▼ to display the number you want to delete, press the number to select it, and then press [OK].
3. Press [Yes].
4. Press .





Related Information

- [Accept Incoming Faxes Only from Registered Numbers](#)

Print the Allow List

Related Models: MFC-L2860DWE/MFC-L2860DW/MFC-L2960DW/MFC-L2980DW

1. Press  [Settings] > [All Settings] > [Fax] > [Incoming limit] > [Allow List] > [Print Report].
2. Press [Yes].
3. Press .

Related Information

- [Accept Incoming Faxes Only from Registered Numbers](#)

Avoid Incoming Fax from Specific Numbers

Related Models: MFC-L2800DW/MFC-L2827DWXL/MFC-L2827DW/MFC-L2835DW/MFC-L2860DWE/
MFC-L2860DW/MFC-L2960DW/MFC-L2980DW

- [Register a Number in the Block List](#)
- [Delete a Number from the Block List](#)
- [Print the Block List](#)

Register a Number in the Block List

Related Models: MFC-L2800DW/MFC-L2827DWXL/MFC-L2827DW/MFC-L2835DW/MFC-L2860DWE/MFC-L2860DW/MFC-L2960DW/MFC-L2980DW

If you do not want to receive faxes or calls from specific numbers, register the numbers to the block list. The machine can register up to 100 fax or telephone numbers from the caller ID memory.

- You must apply for the Caller ID service at your local telephone company.
- The number you want to register must be stored in the caller ID memory.
- The Caller ID feature is not available in some countries.

>> [MFC-L2800DW/MFC-L2827DWXL/MFC-L2827DW/MFC-L2835DW](#)

>> [MFC-L2860DWE/MFC-L2860DW/MFC-L2960DW/MFC-L2980DW](#)

MFC-L2800DW/MFC-L2827DWXL/MFC-L2827DW/MFC-L2835DW



1. Press  (Fax).
2. Press **Menu**.
3. Press ▲ or ▼ to display the [Fax] option, and then press **OK**.
4. Press ▲ or ▼ to display the [Block List] option, and then press **OK**.
5. Press ▲ or ▼ to display the [Register] option, and then press **OK**.
The machine displays the numbers in the caller ID memory.
6. Press ▲ or ▼ to display the number you want to register, and then press **OK**.
7. Press ▲ to register the number.



To go back without registering the number, press ▼.

8. Press **Stop/Exit**.

MFC-L2860DWE/MFC-L2860DW/MFC-L2960DW/MFC-L2980DW

1. Press  [Settings] > [All Settings] > [Fax] > [Incoming limit] > [Block List] > [Register].
The machine displays the numbers in the caller ID memory.
2. Press ▲ or ▼ to display the number you want to register, and then press it.
3. Press [Yes].
4. Press .

✓ Related Information

- [Avoid Incoming Fax from Specific Numbers](#)

Delete a Number from the Block List



Related Models: MFC-L2800DW/MFC-L2827DWXL/MFC-L2827DW/MFC-L2835DW/MFC-L2860DWE/
MFC-L2860DW/MFC-L2960DW/MFC-L2980DW

>> [MFC-L2800DW/MFC-L2827DWXL/MFC-L2827DW/MFC-L2835DW](#)
>> [MFC-L2860DWE/MFC-L2860DW/MFC-L2960DW/MFC-L2980DW](#)

MFC-L2800DW/MFC-L2827DWXL/MFC-L2827DW/MFC-L2835DW

1. Press  (Fax).
2. Press **Menu**.
3. Press ▲ or ▼ to display the [Fax] option, and then press **OK**.
4. Press ▲ or ▼ to display the [Block List] option, and then press **OK**.
5. Press ▲ or ▼ to display the [Delete] option, and then press **OK**.
6. Press ▲ or ▼ to display the number you want to delete, and then press **OK**.
7. Press ▲ to delete the number.
8. Press **Stop/Exit**.

MFC-L2860DWE/MFC-L2860DW/MFC-L2960DW/MFC-L2980DW

1. Press  [Settings] > [All Settings] > [Fax] > [Incoming limit] > [Block List] > [Delete].
2. Press ▲ or ▼ to display the number you want to delete, and then press it.
3. Press [OK].
4. Press [Yes].
5. Press .

✓ Related Information

- [Avoid Incoming Fax from Specific Numbers](#)

Print the Block List

Related Models: MFC-L2800DW/MFC-L2827DWXL/MFC-L2827DW/MFC-L2835DW/MFC-L2860DWE/
MFC-L2860DW/MFC-L2960DW/MFC-L2980DW



>> [MFC-L2800DW/MFC-L2827DWXL/MFC-L2827DW/MFC-L2835DW](#)

>> [MFC-L2860DWE/MFC-L2860DW/MFC-L2960DW/MFC-L2980DW](#)

MFC-L2800DW/MFC-L2827DWXL/MFC-L2827DW/MFC-L2835DW

1. Press  (Fax).
2. Press **Menu**.
3. Press ▲ or ▼ to display the [Fax] option, and then press **OK**.
4. Press ▲ or ▼ to display the [Block List] option, and then press **OK**.
5. Press ▲ or ▼ to display the [Print Report] option, and then press **OK**. Follow the on-screen menus.
6. Press **Stop/Exit**.

MFC-L2860DWE/MFC-L2860DW/MFC-L2960DW/MFC-L2980DW

1. Press  [Settings] > [All Settings] > [Fax] > [Incoming limit] > [Block List] > [Print Report].
2. Press [Yes].
3. Press .

✓ Related Information

- [Avoid Incoming Fax from Specific Numbers](#)

Memory Receive Options

Related Models: MFC-L2802DN/MFC-L2800DW/MFC-L2802DW/MFC-L2827DWXL/MFC-L2827DW/
MFC-L2835DW/MFC-L2860DWE/MFC-L2860DW/MFC-L2862DW/MFC-L2922DW/MFC-L2960DW/
MFC-L2980DW

Use the Memory Receive options to direct incoming faxes while you are away from the machine. You can use only one Memory Receive option at a time.

Memory Receive can be set to:

- PC-Fax Receive
 - Fax Forwarding
 - Fax Storage
 - Forward to Cloud (The machine forwards your received faxes to online services.)
 - Forward to Network (The machine forwards your received faxes to a network destination.)
 - Off
-
- [Use PC-Fax Receive to Transfer Received Faxes to Your Computer \(Windows only\)](#)
 - [Forward Incoming Faxes to Another Machine](#)
 - [Store Incoming Faxes in the Machine's Memory](#)
 - [Change Memory Receive Options](#)
 - [Turn Memory Receive Off](#)
 - [Print a Fax Stored in the Machine's Memory](#)
 - [Forward Incoming Faxes to a Network Destination](#)
 - [Forward Incoming Faxes to a Network Destination](#)

Use PC-Fax Receive to Transfer Received Faxes to Your Computer (Windows only)

Related Models: MFC-L2802DN/MFC-L2800DW/MFC-L2802DW/MFC-L2827DWXL/MFC-L2827DW/MFC-L2835DW/MFC-L2860DWE/MFC-L2860DW/MFC-L2862DW/MFC-L2922DW/MFC-L2960DW/MFC-L2980DW

Turn the PC-Fax Receive feature on to automatically store incoming faxes to your machine's memory, and then send them to your computer. Use your computer to view and store these faxes.

To transfer the received faxes to your computer you must have the PC-FAX Receiving software running on your computer.

Even if you have turned computer off (at night or on the weekend, for example), your machine will receive and store your faxes in its memory.

When you start your computer and the PC-FAX Receiving software runs, your machine transfers your faxes to your computer automatically.

If you selected [Backup Print: On], the machine will also print the fax.

>> [MFC-L2802DN/MFC-L2800DW/MFC-L2802DW/MFC-L2827DWXL/MFC-L2827DW/MFC-L2835DW](#)

>> [MFC-L2860DWE/MFC-L2860DW/MFC-L2862DW/MFC-L2922DW/MFC-L2960DW/MFC-L2980DW](#)

MFC-L2802DN/MFC-L2800DW/MFC-L2802DW/MFC-L2827DWXL/MFC-L2827DW/MFC-L2835DW

1. Press  (**Fax**).
2. Press **Menu**.
3. Press **▲** or **▼** to display the [Fax] option, and then press **OK**.
4. Press **▲** or **▼** to display the [Memory Receive] option, and then press **OK**.
5. Press **▲** or **▼** to display the [PC Fax Receive] option, and then press **OK**.



- PC-Fax Receive is not available for macOS.
- If you get an error message and the machine cannot print the faxes in the memory, you can use this setting to transfer your faxes to your computer.

6. Press **▲** or **▼** to display [On], and then press **OK**.
7. Press **OK**.
8. Press **▲** or **▼** to display [<USB>] or your computer name, and then press **OK**.
9. Press **▲** or **▼** to display [On] or [Off] for the Backup Print setting, and then press **OK**.
10. Press **Stop/Exit**.

MFC-L2860DWE/MFC-L2860DW/MFC-L2862DW/MFC-L2922DW/MFC-L2960DW/MFC-L2980DW

1. Press  [Settings] > [All Settings] > [Fax] > [Setup Receive] > [PC Fax Receive].
2. Press [On].



- PC-Fax Receive is not available for macOS.
- If you get an error message and the machine cannot print the faxes in the memory, you can use this setting to transfer your faxes to your computer.

-
3. Press [OK].
 4. Press [<USB>] or the name of the computer you want to receive faxes if you are on a network, and then press [OK].
 5. Press [Backup Print: On] or [Backup Print: Off].
 6. Press .



Related Information

- [Memory Receive Options](#)
-

Forward Incoming Faxes to Another Machine

Related Models: MFC-L2802DN/MFC-L2800DW/MFC-L2802DW/MFC-L2827DWXL/MFC-L2827DW/
MFC-L2835DW/MFC-L2860DWE/MFC-L2860DW/MFC-L2862DW/MFC-L2922DW/MFC-L2960DW/
MFC-L2980DW

Use the Fax Forwarding feature to automatically forward your incoming faxes to another machine.

>> [MFC-L2802DN/MFC-L2800DW/MFC-L2802DW/MFC-L2827DWXL/MFC-L2827DW/MFC-L2835DW](#)

>> [MFC-L2860DWE/MFC-L2860DW/MFC-L2862DW/MFC-L2922DW/MFC-L2960DW/MFC-L2980DW](#)

MFC-L2802DN/MFC-L2800DW/MFC-L2802DW/MFC-L2827DWXL/MFC-L2827DW/ MFC-L2835DW

1. Press **Menu**.
2. Press **▲** or **▼** to display the [Fax] option, and then press **OK**.
3. Press **▲** or **▼** to display the [Memory Receive] option, and then press **OK**.
4. Press **▲** or **▼** to display the [Forward/Store] option, and then press **OK**.
5. Press **▲** or **▼** to display the [Fax Forward] option, and then press **OK**.
The LCD will ask you to enter the fax number you want your faxes to be forwarded to.
6. Enter the forwarding number using the dial pad (up to 20 digits), hold down the **Shortcut** button and press the one-digit code, or  and the three-digit code, and then press **OK**.



- You can enter an email address if your machine has been configured for the Internet Fax feature.
- If you stored a Group on a **Shortcut** key or in a Speed Dial code, the faxes will be forwarded to multiple fax numbers.

7. Press **▲** or **▼** to select on or off for the Backup Print setting.
8. Press **Stop/Exit**.

MFC-L2860DWE/MFC-L2860DW/MFC-L2862DW/MFC-L2922DW/MFC-L2960DW/ MFC-L2980DW

1. Press  [Settings] > [All Settings] > [Fax] > [Setup Receive] > [Memory Receive].
2. Press [Fax Forward].
3. Do one of the following:
 - Press [Manual] to enter the forwarding fax number (up to 20 digits) using the LCD.
Press [OK].
 - Press [Address Book].
Press **▲** or **▼** to display the destination fax number where you want to your faxes forwarded.
Press the fax number you want.

NOTE

Press [Backup Print: On] or [Backup Print: Off]. If you select [Backup Print: On], the machine also prints a copy of received faxes at your machine.



To forward a fax using an email address, press , enter the email address, and press [OK].

(On certain models, you must download Internet Fax to use the Internet Fax feature and the Scan to Email server feature.)

4. Press .



Related Information

- [Memory Receive Options](#)
-

Store Incoming Faxes in the Machine's Memory

Related Models: MFC-L2802DN/MFC-L2800DW/MFC-L2802DW/MFC-L2827DWXL/MFC-L2827DW/
MFC-L2835DW/MFC-L2860DWE/MFC-L2860DW/MFC-L2862DW/MFC-L2922DW/MFC-L2960DW/
MFC-L2980DW

Use the Fax Storage feature to store incoming faxes in the machine's memory. Retrieve your stored fax messages from your fax machine when you are at another location using the Remote Retrieval commands. Your machine will print a backup copy of each stored fax.

>> [MFC-L2802DN/MFC-L2800DW/MFC-L2802DW/MFC-L2827DWXL/MFC-L2827DW/MFC-L2835DW](#)

>> [MFC-L2860DWE/MFC-L2860DW/MFC-L2862DW/MFC-L2922DW/MFC-L2960DW/MFC-L2980DW](#)

MFC-L2802DN/MFC-L2800DW/MFC-L2802DW/MFC-L2827DWXL/MFC-L2827DW/ MFC-L2835DW

1. Press **Menu**.
2. Press **▲** or **▼** to display the [Fax] option, and then press **OK**.
3. Press **▲** or **▼** to display the [Memory Receive] option, and then press **OK**.
4. Press **▲** or **▼** to display the [Forward/Store] option, and then press **OK**.
5. Press **▲** or **▼** to display the [Fax Storage] option, and then press **OK**.
6. Press **Stop/Exit**.

MFC-L2860DWE/MFC-L2860DW/MFC-L2862DW/MFC-L2922DW/MFC-L2960DW/ MFC-L2980DW

1. Press  [Settings] > [All Settings] > [Fax] > [Setup Receive] > [Memory Receive].
2. Press the [Fax Storage] option.

NOTE

Press [Backup Print: On] or [Backup Print: Off]. If you select [Backup Print: On], the machine also prints a copy of received faxes. (available for certain models)

3. Press .

✓ Related Information

- [Memory Receive Options](#)

Change Memory Receive Options

Related Models: MFC-L2802DN/MFC-L2800DW/MFC-L2802DW/MFC-L2827DWXL/MFC-L2827DW/
MFC-L2835DW/MFC-L2860DWE/MFC-L2860DW/MFC-L2862DW/MFC-L2922DW/MFC-L2960DW/
MFC-L2980DW

>> MFC-L2802DN/MFC-L2800DW/MFC-L2802DW/MFC-L2827DWXL/MFC-L2827DW/MFC-L2835DW
>> MFC-L2860DWE/MFC-L2860DW/MFC-L2862DW/MFC-L2922DW/MFC-L2960DW/MFC-L2980DW

MFC-L2802DN/MFC-L2800DW/MFC-L2802DW/MFC-L2827DWXL/MFC-L2827DW/ MFC-L2835DW

If there are faxes in your machine's memory when you change any Memory Receive option, the LCD displays one of the following questions:

If received faxes have already been printed, the LCD displays [Erase all doc?]

- Do one of the following:
 - If you press ▲, faxes in the memory will be erased before the setting changes.
 - If you press ▼, faxes in the memory will not be erased and the setting will be unchanged.

If unprinted faxes are in the memory, the LCD displays [Print all faxes?]

- Do one of the following:
 - If you press ▲, faxes in the memory will be printed before the setting changes. If a backup copy has already been printed, it will not be printed again.
 - If you press ▼, faxes in the memory will not be printed and the setting will be unchanged.

If received faxes are left in the machine's memory when you change to [PC Fax Receive] from another option (such as [Fax Forward], or [Fax Storage]).

- Select [<USB>] or the name of the computer if you are on a network, and then press **OK**.

The LCD displays:

[Send Fax to PC?]

- If you press ▲, faxes in the memory will be sent to your computer before the setting changes. You will be asked if you want to turn on Backup Print.
- If you press ▼, faxes in the memory will not be erased and the setting will be unchanged.

MFC-L2860DWE/MFC-L2860DW/MFC-L2862DW/MFC-L2922DW/MFC-L2960DW/ MFC-L2980DW

If received faxes are in your machine's memory when you change the Remote Fax operations, the LCD will ask you one of the following questions:

If received faxes have already been printed, the LCD displays [Erase all documents?]

- Do one of the following:
 - If you press [Yes], faxes in the memory will be erased before the setting changes.
 - If you press [No], faxes in the memory will not be erased and the setting will be unchanged.

If unprinted faxes are in the machine's memory, the LCD displays [Print all faxes?]

- Do one of the following:
 - If you press [Yes], faxes in the memory will be printed before the setting changes.
 - If you press [No], faxes in the memory will not be printed and the setting will be unchanged.

If received faxes are left in the machine's memory when you change to [PC Fax Receive] from another option ([Fax Forward], [Fax Storage], [Forward to Cloud] or [Forward to Network]).

- Press [<USB>] or the name of the computer if you are on a network, and then press [OK]. You will be asked if you want to turn on Backup Print.

The LCD displays:

[Send Fax to PC?]

- If you press [Yes], faxes in the memory will be sent to your computer before the setting changes.
- If you press [No], faxes in the memory will not be erased and the setting will be unchanged.



Related Information

- [Memory Receive Options](#)
-

Turn Memory Receive Off

Related Models: MFC-L2802DN/MFC-L2800DW/MFC-L2802DW/MFC-L2827DWXL/MFC-L2827DW/
MFC-L2835DW/MFC-L2860DWE/MFC-L2860DW/MFC-L2862DW/MFC-L2922DW/MFC-L2960DW/
MFC-L2980DW

Turn Memory Receive off if you do not want the machine to save or transfer incoming faxes.

>> [MFC-L2802DN/MFC-L2800DW/MFC-L2802DW/MFC-L2827DWXL/MFC-L2827DW/MFC-L2835DW](#)

>> [MFC-L2860DWE/MFC-L2860DW/MFC-L2862DW/MFC-L2922DW/MFC-L2960DW/MFC-L2980DW](#)

MFC-L2802DN/MFC-L2800DW/MFC-L2802DW/MFC-L2827DWXL/MFC-L2827DW/ MFC-L2835DW

1. Press **Menu**.
2. Press **▲** or **▼** to display the [Fax] option, and then press **OK**.
3. Press **▲** or **▼** to display the [Memory Receive] option, and then press **OK**.
4. Press **▲** or **▼** to display the [Forward/Store] option, and then press **OK**.
5. Press **▲** or **▼** to display the [Off] option, and then press **OK**.



The LCD displays options if there are received faxes still in your machine's memory.

6. Press **Stop/Exit**.

MFC-L2860DWE/MFC-L2860DW/MFC-L2862DW/MFC-L2922DW/MFC-L2960DW/ MFC-L2980DW

1. Press  [Settings] > [All Settings] > [Fax] > [Setup Receive] > [Memory Receive].
2. Press [Off].



The LCD displays options if there are received faxes still in your machine's memory.

3. Press .

✓ Related Information

- [Memory Receive Options](#)

Print a Fax Stored in the Machine's Memory

Related Models: MFC-L2802DN/MFC-L2800DW/MFC-L2802DW/MFC-L2827DWXL/MFC-L2827DW/
MFC-L2835DW/MFC-L2860DWE/MFC-L2860DW/MFC-L2862DW/MFC-L2922DW/MFC-L2960DW/
MFC-L2980DW

If you select [Fax Storage], you can still print a fax from the machine's memory.

>> [MFC-L2802DN/MFC-L2800DW/MFC-L2802DW/MFC-L2827DWXL/MFC-L2827DW/MFC-L2835DW](#)

>> [MFC-L2860DWE/MFC-L2860DW/MFC-L2862DW/MFC-L2922DW/MFC-L2960DW/MFC-L2980DW](#)

MFC-L2802DN/MFC-L2800DW/MFC-L2802DW/MFC-L2827DWXL/MFC-L2827DW/ MFC-L2835DW

1. Press **Menu**.
2. Press **▲** or **▼** to display the [Fax] option, and then press **OK**.
3. Press **▲** or **▼** to display the [Memory Receive] option, and then press **OK**.
4. Press **▲** or **▼** to display the [Print Document] option, and then press **OK**.
5. Press **Start**.

MFC-L2860DWE/MFC-L2860DW/MFC-L2862DW/MFC-L2922DW/MFC-L2960DW/ MFC-L2980DW

1. Press  [Settings] > [All Settings] > [Fax] > [Print Document].
2. Press [Yes].

Related Information

- [Memory Receive Options](#)

Related Topics:

- [Error and Maintenance Messages](#)

Forward Incoming Faxes to a Network Destination

Related Models: MFC-L2922DW/MFC-L2960DW/MFC-L2980DW

Set up a profile to forward incoming faxes directly to a folder on an FTP or CIFS server.

- We recommend using the latest version of the following web browsers:
 - Microsoft Edge, Firefox, and Google Chrome™ for Windows
 - Safari, Firefox, and Google Chrome™ for Mac
 - Google Chrome™ for Android™
 - Safari and Google Chrome™ for iOS
- Ensure that JavaScript and Cookies are always enabled, regardless of which browser you use.

1. Start your web browser.
2. Type "https://machine's IP address" in your browser's address bar (where "machine's IP address" is your machine's IP address).

For example:

https://192.168.1.2

3. If required, type the password in the **Login** field, and then click **Login**.



The default password to manage this machine's settings is located on the back of the machine and marked "Pwd". Change the default password by following the on-screen instructions when you first log in.

4. In the left navigation bar, click **Administrator > Network Profile**.



If the left navigation bar is not visible, start navigating from ☰.

5. Click the protocol option next to the Profile number.
6. Select the **FTP** or **Network** option, and then click **Submit**.
7. Set up the profile for your server, using one of the following tables:



Using the following characters: ?, /, \, ", :, <, >, | or * may cause a sending error.

FTP

| Option | Description |
|---------------------|------------------------------------------------------------------------------------------------------------------------------------------------------------------------------|
| Profile Name | Type a name for this server profile (up to 15 alphanumeric characters). The machine will display this name on the LCD. |
| Host Address | Type the Host Address (for example: ftp.example.com; up to 64 characters) or the IP address (for example: 192.23.56.189). |
| Port Number | Change the Port Number setting used to access the FTP server. The default setting is port 21. In most cases this setting does not need to be changed. |
| Username | Type a user name (up to 32 characters) of a user that has permission to write data to the FTP server. |
| Password | Type the password (up to 32 characters) associated with the user name you entered in the Username field. Type the password again in the Retype password field. |
| SSL/TLS | Set the SSL/TLS option to forward incoming faxes securely using SSL/TLS communication. Change the CA Certificate setting, if needed. |

| Option | Description |
|------------------------|------------------------------------------------------------------------------------------------------------------------------------------------------------------------------------------------------|
| Store Directory | Type the path (up to 255 characters) to the folder on the FTP server where you want to forward incoming faxes. Do not type a slash mark at the beginning of the path (correct example: brother/abc). |
| Passive Mode | Set the Passive Mode option to off or on depending on your FTP server and network firewall configuration. The default setting is on. In most cases, this setting does not need to be changed. |

Network

| Option | Description |
|--------------------------------|--------------------------------------------------------------------------------------------------------------------------------------------------------------------------------------------------------------------------------------------------------------------------------|
| Profile Name | Type a name for this server profile (up to 15 alphanumeric characters). The machine will display this name on the LCD. |
| Network Folder Path | Type the path to the folder on the CIFS server where you want to forward incoming faxes. |
| Auth. Method | To set your authentication method, select Auto , Kerberos , or NTLMv2 . |
| Username | Type a user name (up to 96 characters) that has permission to write data to the folder specified in the Network Folder Path field. If the user name is part of a domain, type the user name in one of the following styles: user@domain domain\user |
| Password | Type the password (up to 32 characters) associated with the user name you entered in the Username field. Type the password again in the Retype password field. |
| Kerberos Server Address | When you select Kerberos for the Auth. Method option, you must type the Kerberos Server Address (for example: kerberos.example.com; up to 64 characters). |



You must configure the SNTP (network time server) or you must set the date, time and time zone correctly on the control panel. The time must match the time used by the Kerberos Server and CIFS Server.

8. Click **Submit**.
9. To set the Fax Forward feature, in the left navigation bar, click **Fax > Remote Fax Options**.
10. Select **Forward to Network** from the **Fwd/Store/Cloud/Network** drop-down list.
11. Select the file type you want to use.
12. To print a backup copy of incoming faxes, select **On** for **Backup print**.
13. Select the profile you want to use from the **Network Profile** drop-down list.
14. Type a three-digit Remote Access Code in the **Remote Access Code** field, if needed.



- You can use the numbers 0 through 9, *, or # for the Remote Access Code.
- The Remote Access Code must be different from the remote codes for the Fax features.

15. Click **Submit**.



Related Information

- [Memory Receive Options](#)
- [Network Features](#)

Remote Fax Retrieval

Related Models: MFC-L2802DN/MFC-L2800DW/MFC-L2802DW/MFC-L2827DWXL/MFC-L2827DW/
MFC-L2835DW/MFC-L2860DWE/MFC-L2860DW/MFC-L2862DW/MFC-L2922DW/MFC-L2960DW/
MFC-L2980DW

Use Remote Retrieval to call your machine from any touch-tone telephone or fax machine, and use a remote access code and remote commands to retrieve fax messages.

- [Set a Remote Access Code](#)
- [Use Your Remote Access Code](#)
- [Remote Retrieval Commands](#)
- [Forward Faxes Remotely](#)
- [Change the Fax Forwarding Number](#)

Set a Remote Access Code

Related Models: MFC-L2802DN/MFC-L2800DW/MFC-L2802DW/MFC-L2827DWXL/MFC-L2827DW/
MFC-L2835DW/MFC-L2860DWE/MFC-L2860DW/MFC-L2862DW/MFC-L2922DW/MFC-L2960DW/
MFC-L2980DW

Set a Remote Access Code to access and control your machine even when you are away from it.

Before you can use the remote access and retrieval features, you must set up your own code. The factory default code is the inactive code (---*).

>> MFC-L2802DN/MFC-L2800DW/MFC-L2802DW/MFC-L2827DWXL/MFC-L2827DW/MFC-L2835DW
>> MFC-L2860DWE/MFC-L2860DW/MFC-L2862DW/MFC-L2922DW/MFC-L2960DW/MFC-L2980DW

MFC-L2802DN/MFC-L2800DW/MFC-L2802DW/MFC-L2827DWXL/MFC-L2827DW/ MFC-L2835DW

1. Press **Menu**.
2. Press **▲** or **▼** to display the [Fax] option, and then press **OK**.
3. Press **▲** or **▼** to display the [Memory Receive] option, and then press **OK**.
4. Press **▲** or **▼** to display the [Remote Access] option, and then press **OK**.
5. Enter a three-digit code using the numbers **0** to **9**, ***** or **#** using the dial pad, and then press **OK**.



- To make your code inactive, press **Clear** to delete the three-digit code in this step. Then press **OK**.
- You cannot change the preset *.
- DO NOT use the same code used for your Remote Activation Code (*51) or Remote Deactivation Code (#51).

6. Press **Stop/Exit**.

MFC-L2860DWE/MFC-L2860DW/MFC-L2862DW/MFC-L2922DW/MFC-L2960DW/ MFC-L2980DW

1. Press  [Settings] > [All Settings] > [Fax] > [Remote Access].
2. Enter a three-digit code using the numbers [0] to [9], [*] or [#] using the the LCD (The preset '*' cannot be changed), and then press [OK].



- DO NOT use the same code used for your Remote Activation Code (*51) or Remote Deactivation Code (#51).
- To make your code inactive, press and hold  to restore the inactive setting (---*), and then press [OK].

3. Press .

Related Information

- [Remote Fax Retrieval](#)

Use Your Remote Access Code

Related Models: MFC-L2802DN/MFC-L2800DW/MFC-L2802DW/MFC-L2827DWXL/MFC-L2827DW/
MFC-L2835DW/MFC-L2860DWE/MFC-L2860DW/MFC-L2862DW/MFC-L2922DW/MFC-L2960DW/
MFC-L2980DW

1. Dial your fax number from a telephone or another fax machine using touch tone.
2. When your machine answers, immediately enter your Remote Access Code (three digits followed by *).
3. The machine signals if it has received messages:
 - One long beep -- Fax messages
 - No beeps -- No messages
4. When the machine gives two short beeps, enter a command.
 - The machine will hang up if you wait longer than 30 seconds to enter a command.
 - The machine will beep three times if you enter an invalid command.
5. Press 9 0 to reset the machine when you are finished.
6. Hang up.

This function may not be available in some countries or supported by your local telephone company.



Related Information

- [Remote Fax Retrieval](#)

Remote Retrieval Commands

Related Models: MFC-L2802DN/MFC-L2800DW/MFC-L2802DW/MFC-L2827DWXL/MFC-L2827DW/
MFC-L2835DW/MFC-L2860DWE/MFC-L2860DW/MFC-L2862DW/MFC-L2922DW/MFC-L2960DW/
MFC-L2980DW

Use the Remote Commands in this table to access fax commands and options when you are away from your machine. When you call the machine and enter your remote access code (three digits followed by *), the system will sound two short beeps and you must enter a Remote Command (column 1), followed by one of the options (column 2) for that command.

| Remote Command | Option | Description |
|----------------|-----------------------------------------------------------|-----------------------------------------------------------------------------------------------------------------------------------------------------------------------------------------------------------------------------------------------------------------------------------------------------------------------------------------------------|
| 95 | Change the Fax Forwarding, or Fax Storage settings | |
| | 1 OFF | You can select <i>Off</i> after you retrieve or erase all your messages. |
| | 2 Fax Forwarding | One long beep means the change is accepted. If you hear three short beeps, you cannot make a change because one of the settings may not be configured correctly (for example, a Fax Forwarding number has not been registered). You can register your Fax Forwarding number by entering 4. After you register the number, Fax Forwarding will work. |
| | 4 Fax Forwarding number | |
| 6 Fax Storage | | |
| 96 | Retrieve a fax | |
| | 2 Retrieve all faxes | Enter the fax number of a remote fax machine to receive stored fax messages. |
| | 3 Erase faxes from memory | If you hear one long beep, fax messages have been erased from memory. |
| 97 | Check the receiving status | |
| | 1 Fax | Check whether your machine has received any faxes. If yes, you will hear one long beep. If not, you will hear three short beeps. |
| 98 | Change the Receive Mode | |
| | 1 External TAD | One long beep means the change has been accepted. |
| | 2 Fax/Tel | |
| 3 Fax Only | | |
| 90 | Exit | Press 9 0 to stop remote retrieval. Wait for the long beep, then hang up. |



Related Information

- [Remote Fax Retrieval](#)

Forward Faxes Remotely

Related Models: MFC-L2802DN/MFC-L2800DW/MFC-L2802DW/MFC-L2827DWXL/MFC-L2827DW/
MFC-L2835DW/MFC-L2860DWE/MFC-L2860DW/MFC-L2862DW/MFC-L2922DW/MFC-L2960DW/
MFC-L2980DW

Call your machine from any touch-tone telephone or fax machine to forward incoming faxes to another machine.

You must turn Fax Storage on to use this feature.

1. Dial your fax number.
2. When your machine answers, enter your Remote Access Code (three digits followed by *). If you hear one long beep, you have messages.
3. When you hear two short beeps, press 9 6 2.
4. Wait for the long beep, and then use the dial pad to enter the number of the remote fax machine where you want your fax messages sent, followed by # # (up to 20 digits).



You cannot use * and # as dial numbers. However, press # if you want to create a pause.

5. Hang up after you hear your machine beep. Your machine will call the other fax machine, which will then print your fax messages.



Related Information

- [Remote Fax Retrieval](#)

Change the Fax Forwarding Number

Related Models: MFC-L2802DN/MFC-L2800DW/MFC-L2802DW/MFC-L2827DWXL/MFC-L2827DW/
MFC-L2835DW/MFC-L2860DWE/MFC-L2860DW/MFC-L2862DW/MFC-L2922DW/MFC-L2960DW/
MFC-L2980DW

You can change your fax forwarding number from another touch-tone telephone or fax machine.

1. Dial your fax number.
2. When your machine answers, enter your Remote Access Code (three digits followed by *). If you hear one long beep, you have messages.
3. When you hear two short beeps, press 9 5 4.
4. Wait for the long beep, enter the new number (up to 20 digits) of the remote fax machine you want your fax messages forwarded to using the dial pad, then enter # #.

You will hear one long beep.



You cannot use * and # as dial numbers. However, press # if you want to create a pause.

5. When you hear two short beeps, press 9 0 to stop Remote Access when you have finished.
6. Hang up after you hear your machine beep.



Related Information

- [Remote Fax Retrieval](#)

Voice Operations and Fax Numbers

Related Models: MFC-L2802DN/MFC-L2800DW/MFC-L2802DW/MFC-L2827DWXL/MFC-L2827DW/
MFC-L2835DW/MFC-L2860DWE/MFC-L2860DW/MFC-L2862DW/MFC-L2922DW/MFC-L2960DW/
MFC-L2980DW

- [Voice Operations](#)
- [Store Fax Numbers](#)
- [Dial a Number Using a Shortcut](#)
- [Dial a Number Using Speed Dial](#)
- [Set up Broadcasting Groups](#)
- [Combine Address Book Numbers](#)

Voice Operations

Related Models: MFC-L2802DN/MFC-L2800DW/MFC-L2802DW/MFC-L2827DWXL/MFC-L2827DW/
MFC-L2835DW/MFC-L2860DWE/MFC-L2860DW/MFC-L2862DW/MFC-L2922DW/MFC-L2960DW/
MFC-L2980DW

- [Pick up a Voice Call in Fax/Tel Receive Mode](#)

Pick up a Voice Call in Fax/Tel Receive Mode

Related Models: MFC-L2802DN/MFC-L2800DW/MFC-L2802DW/MFC-L2827DWXL/MFC-L2827DW/MFC-L2835DW/MFC-L2860DWE/MFC-L2860DW/MFC-L2862DW/MFC-L2922DW/MFC-L2960DW/MFC-L2980DW

When the machine is in Fax/Tel mode, it will use the F/T Ring (fast double-ring) to alert you to pick up a voice call.

If you are at the machine, lift the external telephone's handset, and then press the button in the following table to answer:

| Applicable Models | To pick up a voice call |
|-------------------------------------------------------------------------------|-------------------------|
| MFC-L2802DN/MFC-L2800DW/MFC-L2802DW/ MFC-L2827DWXL/MFC-L2827DW/MFC-L2835DW | Tel/R |
| MFC-L2860DWE/MFC-L2860DW/MFC-L2862DW/ MFC-L2922DW/MFC-L2960DW/MFC-L2980DW | Pickup |

If you are at an extension telephone, lift the handset during the F/T Ring, and then press #51 between the fast double-rings. If no one is on the line, or if someone wants to send you a fax, send the call back to the machine by pressing *51.



Related Information

- [Voice Operations](#)

Store Fax Numbers

Related Models: MFC-L2860DWE/MFC-L2860DW/MFC-L2862DW/MFC-L2922DW/MFC-L2960DW/
MFC-L2980DW

- [Store Address Book Numbers](#)
- [Change or Delete Address Book Names or Numbers](#)

Store Address Book Numbers

Related Models: MFC-L2860DWE/MFC-L2860DW/MFC-L2862DW/MFC-L2922DW/MFC-L2960DW/MFC-L2980DW

1. Press  [(Fax)] > [Address Book].
2. Do the following steps:
 - a. Press [Edit].
 - b. Press [Add New Address].
 - c. Press [Name].
 - d. Enter the name using the LCD (up to 16 characters), and then press [OK].
 - e. Press [Address].
 - f. Enter the number using the LCD (up to 20 digits), and then press [OK].



- Be sure to include the area code when entering a fax or telephone number. Depending on the country, the Caller ID names and history may not be displayed correctly if the area code is not registered with the fax or telephone number.
- To store an Email address to use with Internet Fax or Scan to Email server, press  and enter the Email address and press [OK].
(On certain models, you must download Internet Fax to use the Internet Fax feature and the Scan to Email server feature.)

g. Press [OK].

To store another Address Book number, repeat these steps.

3. Press .



Related Information

- [Store Fax Numbers](#)
 - [Save Outgoing Call Numbers to the Address Book](#)

Save Outgoing Call Numbers to the Address Book

Related Models: MFC-L2860DWE/MFC-L2860DW/MFC-L2862DW/MFC-L2922DW/MFC-L2960DW/MFC-L2980DW

You can copy numbers from your Outgoing Call history and save them in your Address Book.

1. Press  [(Fax)] > [Call History] > [Outgoing Call].
2. Press the number you want.
3. Press [Edit] > [Add to Address Book] > [Name].



To delete the number, press [Edit] > [Delete]. Press [Yes] to confirm.

4. Enter the name using the LCD (up to 16 characters).
5. Press [OK].
6. Press [OK] to confirm the fax or telephone number you want to store.
7. Press .



Related Information

- [Store Address Book Numbers](#)

Change or Delete Address Book Names or Numbers

Related Models: MFC-L2860DWE/MFC-L2860DW/MFC-L2862DW/MFC-L2922DW/MFC-L2960DW/MFC-L2980DW

1. Press  [(Fax)] > [Address Book] > [Edit].
2. Do one of the following:
Press [Change] to edit the names of fax or telephone numbers.
Press ▲ or ▼ to display the number you want to change, and then press it.
 - To change the name, press [Name]. Enter the new name (up to 16 characters) using the LCD, and then press [OK].
 - To change the fax or telephone number, press [Address]. Enter the new fax or telephone number (up to 20 digits) using the LCD, and then press [OK].Press [OK] to finish.



How to enter text:

To change a character, press ◀ or ▶ to position the cursor to highlight the character you want to change, and then press . Enter the new character.

To delete numbers, press ▲ or ▼ to display [Delete], and then press [Delete].

Select the fax or telephone numbers you want to delete by pressing them to display a check mark, and then press [OK].

3. Press .



Related Information

- [Store Fax Numbers](#)

Dial a Number Using a Shortcut

Related Models: MFC-L2802DN/MFC-L2800DW/MFC-L2802DW/MFC-L2827DWXL/MFC-L2827DW/
MFC-L2835DW

1. Press  (**Fax**).
2. [Load your document.](#)
3. Hold down the **Shortcut** button and press the one-digit code assigned to the fax or telephone number you want to dial.
4. Press **Start**.



Related Information

- [Voice Operations and Fax Numbers](#)
 - [Create Shortcuts for Fax Numbers](#)
 - [Change or Delete Shortcuts to Fax Numbers](#)

Create Shortcuts for Fax Numbers

Related Models: MFC-L2802DN/MFC-L2800DW/MFC-L2802DW/MFC-L2827DWXL/MFC-L2827DW/MFC-L2835DW

You can store ten Shortcuts to fax numbers and access them using the **Shortcut** button.

1. Press  (**Fax**).
2. Hold down the **Shortcut** button and press one number on the dial pad. This number is now the one-digit Shortcut code for the fax number you want to save.
If a fax number is not already stored under this one-digit code, the LCD displays [Register Now?].
3. Press ▲.

NOTE

The Internet Fax (I-Fax) and its settings are available to store.

(On certain models, you must download Internet Fax to use the Internet Fax feature and the Scan to Email server feature.)

4. Enter the telephone or fax number (up to 20 digits), and then press **OK**.
5. Do one of the following:
 - Enter the name using the dial pad (up to 16 characters), and then press **OK**.
 - To store the number without a name, press **OK**.



Related Information

- [Dial a Number Using a Shortcut](#)

Change or Delete Shortcuts to Fax Numbers

Related Models: MFC-L2802DN/MFC-L2800DW/MFC-L2802DW/MFC-L2827DWXL/MFC-L2827DW/MFC-L2835DW

1. Press  (**Fax**).
2. Press **▲** three times.
3. Press **▲** or **▼** to display the [Shortcut] option, and then press **OK**.
4. Hold down the **Shortcut** button and use the dial pad to press the one-digit Shortcut code that you want to change or delete.
5. Do one of the following:
 - To change the stored name and number:
 - a. Press **▲**.
 - b. Edit the name and number:

To edit the stored name or number, press **◀** or **▶** to move the cursor to the character you want to change, and then press **Clear**.

Enter the correct character, and then press **OK**.
 - To delete the stored name and number:
 - a. Press **▼**.
 - b. Press **▲** to confirm.
 - To exit without making a change, press **Stop/Exit**.
6. Press **Stop/Exit**.





Related Information

- [Dial a Number Using a Shortcut](#)

Dial a Number Using Speed Dial

Related Models: MFC-L2802DN/MFC-L2800DW/MFC-L2802DW/MFC-L2827DWXL/MFC-L2827DW/MFC-L2835DW

1. Press  (**Fax**).
2. [Load your document](#).
3. Do one of the following:
 - Press  twice and enter the three-digit Speed Dial code.
 - Press .
Press the dial pad buttons for the first few letters of the name, and then press **OK**.
Press **▲** or **▼** to scroll until you find the name you are looking for, and then press **OK**.
4. Press **OK**.
5. Press **Start**.





Related Information

- [Voice Operations and Fax Numbers](#)
 - [Store Speed Dial Numbers](#)
 - [Change or Delete Speed Dial Numbers](#)

Store Speed Dial Numbers

Related Models: MFC-L2802DN/MFC-L2800DW/MFC-L2802DW/MFC-L2827DWXL/MFC-L2827DW/MFC-L2835DW

Use the Speed Dial numbers to store up to 200 numbers with a name.

1. Press  (**Fax**).
2. Press  twice and enter a three-digit Speed Dial code (001 - 200). Press **OK**.
If a number is not stored there, the LCD displays [Register Now?].
3. Press **▲**.

NOTE

The Internet Fax (I-Fax) and its settings are available to store.
(On certain models, you must download Internet Fax to use the Internet Fax feature and the Scan to Email server feature.)

4. Enter the telephone or fax number (up to 20 digits), and then press **OK**.
5. Do one of the following:
 - Enter the name using the dial pad (up to 16 characters), and then press **OK**.
 - To store the number without a name, press **OK**.



Related Information

- [Dial a Number Using Speed Dial](#)

Change or Delete Speed Dial Numbers

Related Models: MFC-L2802DN/MFC-L2800DW/MFC-L2802DW/MFC-L2827DWXL/MFC-L2827DW/MFC-L2835DW

You can change or delete Speed Dial Codes.

1. Press  (**Fax**).
2. Press **▲** three times.
3. Press **▲** or **▼** to display the [Speed Dial] option, and then press **OK**.
4. Enter the Speed Dial code you want to change or delete, and then press **OK**.
5. Do one of the following:
 - To change the stored fax or telephone number and name:
 - a. Press **▲**.
 - b. Edit the number and name:

To edit the stored number or name, press **◀** or **▶** to move the cursor to the character you want to change, and then press **Clear**.

Enter the correct character, and then press **OK**.
 - To delete the stored fax or telephone number and name:
 - a. Press **▼**.
 - b. Press **▲** to confirm.
 - To exit without making a change, press **Stop/Exit**.
6. Press **Stop/Exit**.



Related Information

- [Dial a Number Using Speed Dial](#)

Set up Broadcasting Groups

Related Models: MFC-L2802DN/MFC-L2800DW/MFC-L2802DW/MFC-L2827DWXL/MFC-L2827DW/MFC-L2835DW/MFC-L2860DWE/MFC-L2860DW/MFC-L2862DW/MFC-L2922DW/MFC-L2960DW/MFC-L2980DW



Create a broadcasting group if you want to send a single fax message to many fax numbers at the same time. You can store broadcasting groups in your machine's Address Book, Shortcut, or Speed Dial, depending on your model.

First, you must store each fax number in the Address Book. Then you can include them as numbers in the Group. Each Group uses up an Address Book (a Shortcut, or a Speed Dial in some models) number.

| Applicable Models | Maximum number of groups | Maximum numbers in a group |
|-----------------------------------------------------------------------------------|--------------------------|----------------------------|
| MFC-L2802DN/MFC-L2800DW/ MFC-L2802DW/MFC-L2827DWXL/ MFC-L2827DW/MFC-L2835DW | 20 | 209 |
| MFC-L2860DWE/MFC-L2860DW/ MFC-L2862DW/MFC-L2922DW/ MFC-L2960DW/MFC-L2980DW | 20 | 199 |

>> [MFC-L2802DN/MFC-L2800DW/MFC-L2802DW/MFC-L2827DWXL/MFC-L2827DW/MFC-L2835DW](#)
>> [MFC-L2860DWE/MFC-L2860DW/MFC-L2862DW/MFC-L2922DW/MFC-L2960DW/MFC-L2980DW](#)

MFC-L2802DN/MFC-L2800DW/MFC-L2802DW/MFC-L2827DWXL/MFC-L2827DW/MFC-L2835DW

- Press  (**Fax**).
- Press **▲** three times.
- Press **▲** or **▼** to display the [Setup Groups] option, and then press **OK**.
- Do one of the following:
 - To store a Group in a Speed Dial location:
Press  and then enter the three-digit Speed Dial location, and then press **OK**.
 - To store a Group in a Shortcut location:
Hold down the **Shortcut** button and then enter the one-digit Shortcut number using the dial pad.
- Use the dial pad to enter a Group number (01 to 20), and then press **OK**.

NOTE

The Internet Fax (I-Fax) and its setting are selectable.

(On certain models, you must download Internet Fax to use the Internet Fax feature and the Scan to Email server feature.)

- Add numbers to the Group:
 - To add Speed Dial Numbers:
Press  and then enter the three-digit Speed Dial location.
 - To add Shortcut Numbers:
Hold down the **Shortcut** button and then enter the one-digit Shortcut number using the dial pad.

The LCD will display selected Speed Dial numbers with a # and Shortcut numbers with a * (for example *006, #009).

-
7. Press **OK** when you finish adding numbers.
 8. Enter the Group name using the dial pad (up to 16 characters).
 9. Press **OK**.
 10. Press **Stop/Exit**.

MFC-L2860DWE/MFC-L2860DW/MFC-L2862DW/MFC-L2922DW/MFC-L2960DW/ MFC-L2980DW

1. Press  [(Fax)] > [Address Book].
2. Do the following steps:
 - a. Press [Edit] > [Setup Groups] > [Name].
 - b. Enter the Group name (up to 16 characters) using the LCD, and then press [OK].
 - c. Press [Add/Delete].
 - d. Add Address Book numbers to the Group by pressing them to display a checkmark, and then press [OK].
 - e. Read and confirm the displayed list of names and numbers you have selected, and then press [OK] to save your Group.

To store another Group for broadcasting, repeat these steps.

3. Press .

Related Information



- [Voice Operations and Fax Numbers](#)
 - [Change a Broadcasting Group Name](#)
 - [Delete a Broadcasting Group](#)
 - [Add or Delete a Broadcasting Group Member](#)

Change a Broadcasting Group Name

Related Models: MFC-L2802DN/MFC-L2800DW/MFC-L2802DW/MFC-L2827DWXL/MFC-L2827DW/MFC-L2835DW/MFC-L2860DWE/MFC-L2860DW/MFC-L2862DW/MFC-L2922DW/MFC-L2960DW/MFC-L2980DW

>> MFC-L2802DN/MFC-L2800DW/MFC-L2802DW/MFC-L2827DWXL/MFC-L2827DW/MFC-L2835DW
>> MFC-L2860DWE/MFC-L2860DW/MFC-L2862DW/MFC-L2922DW/MFC-L2960DW/MFC-L2980DW

MFC-L2802DN/MFC-L2800DW/MFC-L2802DW/MFC-L2827DWXL/MFC-L2827DW/MFC-L2835DW

1. Press  (Fax).
2. Press ▲ three times.
3. Press ▲ or ▼ to display the [Setup Groups] option, and then press **OK**.
4. Do one of the following:
 - To change the Group name of a Group stored in a Speed Dial location:
Press  and then enter the three-digit Speed Dial location, and then press **OK**.
 - To change the Group name of a Group stored in a Shortcut location:
Hold down the **Shortcut** button and then enter the one-digit Shortcut number using the dial pad.
5. Press ▲ to change the stored Group information.

NOTE

The Internet Fax (I-Fax) and its settings are available to store.

(On certain models, you must download Internet Fax to use the Internet Fax feature and the Scan to Email server feature.)

6. Press **OK**.
7. To edit the name, press ◀ or ▶ position the cursor under the character you want to change. Then press **Clear** to delete it, and enter the correct character using the dial pad.
When you are finished editing, press **OK**.
8. Press **Stop/Exit**.

MFC-L2860DWE/MFC-L2860DW/MFC-L2862DW/MFC-L2922DW/MFC-L2960DW/MFC-L2980DW

1. Press  [(Fax)] > [Address Book] > [Edit] > [Change].
2. Press ▲ or ▼ to display the Group you want, and then press it.
3. Press [Name].
4. Enter the new Group name (up to 16 characters) using the LCD, and then press [OK].



How to change the stored name:

To change a character, press ◀ or ▶ to position the cursor to highlight the incorrect character, and then press .

Enter the new character.

5. Press [OK].

6. Press .



Related Information



- [Set up Broadcasting Groups](#)
-

Delete a Broadcasting Group



Related Models: MFC-L2802DN/MFC-L2800DW/MFC-L2802DW/MFC-L2827DWXL/MFC-L2827DW/
MFC-L2835DW/MFC-L2860DWE/MFC-L2860DW/MFC-L2862DW/MFC-L2922DW/MFC-L2960DW/
MFC-L2980DW

>> [MFC-L2802DN/MFC-L2800DW/MFC-L2802DW/MFC-L2827DWXL/MFC-L2827DW/MFC-L2835DW](#)
>> [MFC-L2860DWE/MFC-L2860DW/MFC-L2862DW/MFC-L2922DW/MFC-L2960DW/MFC-L2980DW](#)

MFC-L2802DN/MFC-L2800DW/MFC-L2802DW/MFC-L2827DWXL/MFC-L2827DW/ MFC-L2835DW

1. Press  (Fax).
2. Press ▲ three times.
3. Press ▲ or ▼ to display the [Setup Groups] option, and then press **OK**.
4. Do one of the following:
 - To delete a Group stored in a Speed Dial location:
Press  and then enter the three-digit Speed Dial location, and then press **OK**.
 - To delete a Group stored in a Shortcut location:
Hold down the **Shortcut** button and then enter the one-digit Shortcut number using the dial pad.
5. Press ▼ to delete the Group.
6. Press ▲ to confirm.
7. Press **Stop/Exit**.

MFC-L2860DWE/MFC-L2860DW/MFC-L2862DW/MFC-L2922DW/MFC-L2960DW/ MFC-L2980DW

1. Press  [(Fax)] > [Address Book] > [Edit] > [Delete].
2. Press ▲ or ▼ to display the Group you want, and then press it.
3. Press [OK].
4. Press .

✓ Related Information



- [Set up Broadcasting Groups](#)

Add or Delete a Broadcasting Group Member

Related Models: MFC-L2802DN/MFC-L2800DW/MFC-L2802DW/MFC-L2827DWXL/MFC-L2827DW/
MFC-L2835DW/MFC-L2860DWE/MFC-L2860DW/MFC-L2862DW/MFC-L2922DW/MFC-L2960DW/
MFC-L2980DW

>> MFC-L2802DN/MFC-L2800DW/MFC-L2802DW/MFC-L2827DWXL/MFC-L2827DW/MFC-L2835DW
>> MFC-L2860DWE/MFC-L2860DW/MFC-L2862DW/MFC-L2922DW/MFC-L2960DW/MFC-L2980DW

MFC-L2802DN/MFC-L2800DW/MFC-L2802DW/MFC-L2827DWXL/MFC-L2827DW/ MFC-L2835DW

1. Press  (**Fax**).
2. Press **▲** three times.
3. Press **▲** or **▼** to display the [Setup Groups] option, and then press **OK**.
4. Do one of the following:
 - To change the numbers of a Group stored in a Speed Dial location:
Press  and then enter the three-digit Speed Dial location, and then press **OK**.
 - To change the numbers of a Group stored in a Shortcut location:
Hold down the **Shortcut** button and then enter the one-digit Shortcut number using the dial pad.
5. Press **▲** to change the numbers stored in the Group.

NOTE

The Internet Fax (I-Fax) and its settings are available to store.

(On certain models, you must download Internet Fax to use the Internet Fax feature and the Scan to Email server feature.)

6. Add or delete Shortcut or Speed Dial numbers
 - To add Shortcut numbers:
Press **◀** or **▶** to position the cursor just after the last number.
Then hold down the **Shortcut** button and then enter the one-digit Shortcut location of the number you want to add.
 - To add Speed Dial numbers:
Press **◀** or **▶** to position the cursor just after the last number.
Then press  and then enter the three-digit Speed Dial location of the number you want to add.
 - To delete Shortcut or Speed Dial numbers, press **◀** or **▶** to position the cursor under the number you want to delete, and then press **Clear**.

When you are finished editing, press **OK**.
7. Press **OK**.
8. Press **Stop/Exit**.

MFC-L2860DWE/MFC-L2860DW/MFC-L2862DW/MFC-L2922DW/MFC-L2960DW/ MFC-L2980DW

1. Press  [(Fax)] > [Address Book] > [Edit] > [Change].
2. Press **▲** or **▼** to display the Group you want, and then press it.

-
3. Press ▲ or ▼ to display [Add/Delete], and then press it.
 4. Press ▲ or ▼ to display the number you want to add or delete.
 5. Do the following for each number you want to change:
 - To add a number to the Group, press the checkbox of the number to add a check mark.
 - To delete a number from the Group, press the checkbox of the number to remove the check mark.
 6. Press [OK].
 7. Press [OK].
 8. Press .



Related Information

- [Set up Broadcasting Groups](#)
-

Combine Address Book Numbers

Related Models: MFC-L2802DN/MFC-L2800DW/MFC-L2802DW/MFC-L2827DWXL/MFC-L2827DW/MFC-L2835DW/MFC-L2860DWE/MFC-L2860DW/MFC-L2862DW/MFC-L2922DW/MFC-L2960DW/MFC-L2980DW

Sometimes you may want to choose from several long-distance carriers when you send a fax. Rates may vary depending on the time and destination. To take advantage of low rates, you can store the access codes of long-distance carriers and credit card numbers as Address Book numbers.

You can store these long dialling sequences by dividing them and setting them up as separate Address Book numbers in any combination. You can even include manual dialling using the dial pad.



For example: You might have stored '01632' and '960555' in your machine as shown in the following table.

| Applicable Models | '01632' stored in | '960555' stored in |
|-----------------------------------------------------------------------------------|-------------------------|-------------------------|
| MFC-L2802DN/MFC-L2800DW/ MFC-L2802DW/MFC-L2827DWXL/ MFC-L2827DW/MFC-L2835DW | Quick Dial: 003 | Quick Dial: 002 |
| MFC-L2860DWE/MFC-L2860DW/ MFC-L2862DW/MFC-L2922DW/ MFC-L2960DW/MFC-L2980DW | Address Book: Brother 1 | Address Book: Brother 2 |

You can use them both to dial '01632-960555' by using the following procedure.

>> MFC-L2802DN/MFC-L2800DW/MFC-L2802DW/MFC-L2827DWXL/MFC-L2827DW/MFC-L2835DW
>> MFC-L2860DWE/MFC-L2860DW/MFC-L2862DW/MFC-L2922DW/MFC-L2960DW/MFC-L2980DW

MFC-L2802DN/MFC-L2800DW/MFC-L2802DW/MFC-L2827DWXL/MFC-L2827DW/MFC-L2835DW

1. Press  (Fax).
2. Press  twice, 003.
3. Press **OK**.
4. Press  twice, 002.
5. Press **OK**.
6. Press **Start**.

The machine will dial '01632-960555'.

To temporarily change a number, you can substitute part of the number by pressing it using the dial pad. For example, to change the number to '01632-960556', you could enter the number (01632) using Quick Dial 003, and then press 960556 using the dial pad.



If you must wait for another dial tone or signal at any point in the dialling sequence, create a pause in the number by pressing **Redial/Pause**.

MFC-L2860DWE/MFC-L2860DW/MFC-L2862DW/MFC-L2922DW/MFC-L2960DW/MFC-L2980DW

1. Press  [(Fax)] > [Address Book].
2. Press ▲ or ▼ to display the number of Brother 1.
3. Press the number.
4. Press [Apply].

-
5. Press [Options].
 6. Press ▲ or ▼ to display the [Address Book] option, and then press it.
 7. Press [OK].
 8. Press ▲ or ▼ to display the number of Brother 2.
 9. Press the number.
 10. Press [Apply].
 11. Press [Fax Start].

The machine will dial '01632-960555'.

To temporarily change a number, you can substitute part of the number by pressing it using the LCD. For example, to change the number to '01632-960556', you could enter the number (Brother 1: 01632) using the Address Book, press [Apply], and then enter 960556 using the LCD.



If you must wait for another dial tone or signal at any point in the dialling sequence, create a pause in the number by pressing [Pause].



Related Information

- [Voice Operations and Fax Numbers](#)
-

Telephone Services and External Devices

Related Models: MFC-L2802DN/MFC-L2800DW/MFC-L2802DW/MFC-L2827DWXL/MFC-L2827DW/
MFC-L2835DW/MFC-L2860DWE/MFC-L2860DW/MFC-L2862DW/MFC-L2922DW/MFC-L2960DW/
MFC-L2980DW

- [Use BT Call Sign](#)
- [Caller ID](#)
- [Set the Telephone Line Type](#)
- [External TAD \(Telephone Answering Device\)](#)
- [External and Extension Telephones](#)
- [Multi-line Connections \(PBX\)](#)

Use BT Call Sign

Related Models: MFC-L2802DN/MFC-L2800DW/MFC-L2802DW/MFC-L2827DWXL/MFC-L2827DW/
MFC-L2835DW/MFC-L2860DWE/MFC-L2860DW/MFC-L2862DW/MFC-L2922DW/MFC-L2960DW/
MFC-L2980DW

This feature lets you use the BT Call Sign subscriber service which allows you to have at least two separate telephone numbers on one telephone line. Each telephone number has its own distinctive ringing pattern, so you know which telephone number is ringing. This is one way you can have a separate telephone number for your machine.

Your machine has a BT Call Sign compatible distinctive ringing function, allowing you to dedicate a second telephone number (on the same telephone line) just for receiving faxes.



- This feature is available only in the U.K.
- You can switch BT Call Sign Off temporarily, then turn it back on. When you get a new fax number, make sure you reset this function. This machine will automatically answer incoming calls that use your new fax number.
- When you set the BT Call Sign feature to On, the receive mode is set to [Manual] automatically. The [Manual] mode will not respond to incoming telephone calls, because the number you use for telephone calls will use the normal ring pattern.



Related Information

- [Telephone Services and External Devices](#)
 - [Enable the Machine to Work with BT Call Sign](#)

Enable the Machine to Work with BT Call Sign

Related Models: MFC-L2802DN/MFC-L2800DW/MFC-L2802DW/MFC-L2827DWXL/MFC-L2827DW/
MFC-L2835DW/MFC-L2860DWE/MFC-L2860DW/MFC-L2862DW/MFC-L2922DW/MFC-L2960DW/
MFC-L2980DW

- This feature is available only in the U.K.
- This feature will only work with your external phone.



>> [MFC-L2802DN/MFC-L2800DW/MFC-L2802DW/MFC-L2827DWXL/MFC-L2827DW/MFC-L2835DW](#)
>> [MFC-L2860DWE/MFC-L2860DW/MFC-L2862DW/MFC-L2922DW/MFC-L2960DW/MFC-L2980DW](#)

MFC-L2802DN/MFC-L2800DW/MFC-L2802DW/MFC-L2827DWXL/MFC-L2827DW/ MFC-L2835DW

1. Press  (Fax).
2. Press **Menu**.
3. Press **▲** or **▼** to display the [Fax] option, and then press **OK**.
4. Press **▲** or **▼** to display the [Miscellaneous] option, and then press **OK**.
5. Press **▲** or **▼** to display the [BT Call Sign] option, and then press **OK**.
6. Press **▲** or **▼** to display the [On] (or [Off]) option, and then press **OK**.
7. Press **Stop/Exit**.

If you turn off BT Call Sign, the receive mode stays in Manual mode. You will need to set the receive mode again.

MFC-L2860DWE/MFC-L2860DW/MFC-L2862DW/MFC-L2922DW/MFC-L2960DW/ MFC-L2980DW

1. Press  [Settings] > [All Settings] > [Fax] > [Miscellaneous] > [BT Call Sign].
2. Press [On] (or [Off]).
3. Press .

If you turn off BT Call Sign, the receive mode stays in Manual mode. You will need to set the receive mode again.

Related Information

- [Use BT Call Sign](#)

Caller ID

Related Models: MFC-L2802DN/MFC-L2800DW/MFC-L2802DW/MFC-L2827DWXL/MFC-L2827DW/
MFC-L2835DW/MFC-L2860DWE/MFC-L2860DW/MFC-L2862DW/MFC-L2922DW/MFC-L2960DW/
MFC-L2980DW

The Caller ID feature lets you use the Caller ID subscriber service offered by many local telephone companies. This service displays the telephone number, or name if it is available, of your caller as the line rings.

- The [ID Unknown] message means the call originated outside your Caller ID service area.
- The [ID Withheld] message means the caller has intentionally blocked transmission of Caller ID information.

Call your telephone company for more information.

Once you answer a call, the Caller ID information disappears from the LCD and is stored in Caller ID memory.

View the list or select a number and add it to the Address Book (the Speed Dial or the Shortcut in some models), or delete it from the history.

You can print a list of the Caller ID information received by your machine.



- This feature is not available in some countries.
- The Caller ID service varies with different carriers. Contact your local telephone company to learn about the service available in your area.



Related Information

- [Telephone Services and External Devices](#)
 - [Set Caller ID to On](#)

Set Caller ID to On

Related Models: MFC-L2802DN/MFC-L2800DW/MFC-L2802DW/MFC-L2827DWXL/MFC-L2827DW/
MFC-L2835DW/MFC-L2860DWE/MFC-L2860DW/MFC-L2862DW/MFC-L2922DW/MFC-L2960DW/
MFC-L2980DW

This feature is available only in the U.K. and Ireland.

If you subscribe to the Caller ID service on your phone line, set Caller ID to On to display the caller's telephone number on the LCD as the telephone rings.

>> [MFC-L2802DN/MFC-L2800DW/MFC-L2802DW/MFC-L2827DWXL/MFC-L2827DW/MFC-L2835DW](#)
>> [MFC-L2860DWE/MFC-L2860DW/MFC-L2862DW/MFC-L2922DW/MFC-L2960DW/MFC-L2980DW](#)

MFC-L2802DN/MFC-L2800DW/MFC-L2802DW/MFC-L2827DWXL/MFC-L2827DW/ MFC-L2835DW



1. Press **Menu**.
2. Press **▲** or **▼** to display the [Fax] option, and then press **OK**.
3. Press **▲** or **▼** to display the [Miscellaneous] option, and then press **OK**.
4. Press **▲** or **▼** to display the [Caller ID] option, and then press **OK**.
5. Press **▲** or **▼** to display the [On] (or [Off]) option, and then press **OK**.



- To view the Caller ID list on the LCD, select the [Display#] option in this step.
- To print the Caller ID list, select the [Print Report] option in this step.

6. Press **Stop/Exit**.

MFC-L2860DWE/MFC-L2860DW/MFC-L2862DW/MFC-L2922DW/MFC-L2960DW/ MFC-L2980DW

1. Press  [Settings] > [All Settings] > [Fax] > [Miscellaneous] > [Caller ID].
2. Press [On] (or [Off]).
3. Press .

Related Information

- [Caller ID](#)

Set the Telephone Line Type

Related Models: MFC-L2802DN/MFC-L2800DW/MFC-L2802DW/MFC-L2827DWXL/MFC-L2827DW/
MFC-L2835DW/MFC-L2860DWE/MFC-L2860DW/MFC-L2862DW/MFC-L2922DW/MFC-L2960DW/
MFC-L2980DW

If you are connecting the machine to a line that features PBX or ISDN to send and receive faxes, you must select a Telephone Line Type that matches your line's features.

>> MFC-L2802DN/MFC-L2800DW/MFC-L2802DW/MFC-L2827DWXL/MFC-L2827DW/MFC-L2835DW

>> MFC-L2860DWE/MFC-L2860DW/MFC-L2862DW/MFC-L2922DW/MFC-L2960DW/MFC-L2980DW

MFC-L2802DN/MFC-L2800DW/MFC-L2802DW/MFC-L2827DWXL/MFC-L2827DW/ MFC-L2835DW

1. Press **Menu**.
2. Press **▲** or **▼** to display the [Initial Setup] option, and then press **OK**.
3. Press **▲** or **▼** to display the [Phone Line Set] option, and then press **OK**.
4. Press **▲** or **▼** to display the [Normal], [PBX], or [ISDN] option, and then press **OK**.
5. If you selected [PBX], do one of the following:
 - If you want to change the current prefix number, press **▲**.
Enter the prefix number (up to 5 digits) on the dial pad, and then press **OK**.
Press **▲** or **▼** to display the [On] or [Always] option, and then press **OK**.
 - If you do not want to change the current prefix number, press **▲** and then **OK**.
Press **▲** or **▼** to display the [On] or [Always] option, and then press **OK**.



- Use the numbers 0 to 9, #, * and ! for the prefix number. (Press **Tel/R** to display "!".)
- If you select [On], the machine dials a prefix number before the fax number only when **Tel/R** is pressed.
- If you select [Always], the machine always dials a prefix number before the fax number.

6. Press **Stop/Exit**.

MFC-L2860DWE/MFC-L2860DW/MFC-L2862DW/MFC-L2922DW/MFC-L2960DW/ MFC-L2980DW

1. Press  [Settings] > [All Settings] > [Initial Setup] > [Phone Line Set].
2. Press [Normal], [PBX], or [ISDN].
3. If you selected [PBX], do the following:
 - a. Press [On] or [Always].



- If you select [On], the machine dials a prefix number before the fax number only when [R] is pressed.
- If you select [Always], the machine always dials a prefix number before the fax number.

- b. Press [Dial Prefix].
- c. Enter the prefix number using the LCD, and then press [OK].



Use the numbers 0 to 9, #, * and !. You cannot use ! with any other numbers or characters.

4. Press .



Related Information

- Telephone Services and External Devices
 - PBX and TRANSFER
-

PBX and TRANSFER

Related Models: MFC-L2802DN/MFC-L2800DW/MFC-L2802DW/MFC-L2827DWXL/MFC-L2827DW/MFC-L2835DW/MFC-L2860DWE/MFC-L2860DW/MFC-L2862DW/MFC-L2922DW/MFC-L2960DW/MFC-L2980DW

The machine's [Phone Line Set] default setting is [Normal], which lets the machine connect to a standard Public Switched Telephone Network (PSTN) line. However, many offices use a central telephone system or Private Branch Exchange (PBX). Your machine can be connected to most types of PBX. The machine's recall feature supports timed break recall only (TBR). TBR will work with most PBX systems allowing you to gain access to an outside line, or transfer calls to another extension. To use this feature, press the button in the table.

| Applicable Models | To use the machine's recall feature |
|---------------------------------------------------------------------------|-------------------------------------|
| MFC-L2802DN/MFC-L2800DW/MFC-L2802DW/MFC-L2827DWXL/MFC-L2827DW/MFC-L2835DW | Tel/R |
| MFC-L2860DWE/MFC-L2860DW/MFC-L2862DW/MFC-L2922DW/MFC-L2960DW/MFC-L2980DW | R |



Assign a telephone number to the button stored in the Address Book (Shortcut and Speed Dial in some models). When programming the Address Book number (Shortcut number and Speed Dial number in some models), press the button first (the LCD displays '!'), then enter the telephone number. This avoids having to press the button each time before you dial from the Address Book (Shortcut or Speed Dial). Your Telephone Line Type must be set to PBX on the machine to use this feature.



Related Information

- [Set the Telephone Line Type](#)

External TAD (Telephone Answering Device)

Related Models: MFC-L2802DN/MFC-L2800DW/MFC-L2802DW/MFC-L2827DWXL/MFC-L2827DW/
MFC-L2835DW/MFC-L2860DWE/MFC-L2860DW/MFC-L2862DW/MFC-L2922DW/MFC-L2960DW/
MFC-L2980DW

Connect an external Telephone Answering Device (TAD) to the same line as your machine. When the TAD answers a call, your machine will “listen” for the CNG (fax calling) tones sent by a sending fax machine. If it hears them it will take over the call and receive the fax. If it does not hear them, it will let your TAD take a voice message and the LCD will show [Telephone].

The external TAD must answer within four rings (we recommend setting it to two rings). This is because your machine cannot hear the CNG tones until the external TAD has picked up the call. The sending machine will send CNG tones for only eight to ten seconds longer. We do not recommend using the toll saver feature on your external TAD if it needs more than four rings to activate it.

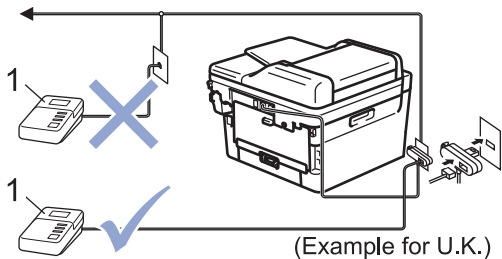

1 TAD

IMPORTANT

DO NOT connect a TAD elsewhere on the same telephone line.



If you have problems receiving faxes, reduce the Ring Delay setting on your external TAD.



Related Information

- [Telephone Services and External Devices](#)
 - [Connect an External TAD](#)
 - [Record an Outgoing Message \(OGM\) on the External TAD](#)

Connect an External TAD

Related Models: MFC-L2802DN/MFC-L2800DW/MFC-L2802DW/MFC-L2827DWXL/MFC-L2827DW/MFC-L2835DW/MFC-L2860DWE/MFC-L2860DW/MFC-L2862DW/MFC-L2922DW/MFC-L2960DW/MFC-L2980DW

1. Set your external TAD to the minimum number of rings allowed. For more information, contact your telephone provider. (The machine's Ring Delay setting does not apply.)
2. Record an outgoing message on your external TAD.
3. Set the TAD to answer calls.
4. Set the Receive Mode on your machine to [External TAD].



Related Information

- [External TAD \(Telephone Answering Device\)](#)

Record an Outgoing Message (OGM) on the External TAD

Related Models: MFC-L2802DN/MFC-L2800DW/MFC-L2802DW/MFC-L2827DWXL/MFC-L2827DW/MFC-L2835DW/MFC-L2860DWE/MFC-L2860DW/MFC-L2862DW/MFC-L2922DW/MFC-L2960DW/MFC-L2980DW

1. Record five seconds of silence at the beginning of your message. This allows your machine time to listen for fax tones.
2. Limit your speaking to 20 seconds.
3. End your 20-second message by giving your Remote Activation Code for those who may need to send faxes manually. For example: "After the beep, leave a message or press *51 and start to send a fax."

NOTE

We recommend beginning your OGM with an initial five-second silence because the machine cannot hear fax tones over a loud voice. You may try leaving out this pause, but if your machine has trouble receiving faxes, then you should re-record the OGM to include it.



Related Information

- [External TAD \(Telephone Answering Device\)](#)

External and Extension Telephones

Related Models: MFC-L2802DN/MFC-L2800DW/MFC-L2802DW/MFC-L2827DWXL/MFC-L2827DW/
MFC-L2835DW/MFC-L2860DWE/MFC-L2860DW/MFC-L2862DW/MFC-L2922DW/MFC-L2960DW/
MFC-L2980DW

- [Connect an External or Extension Telephone](#)
- [Operation from External and Extension Telephones](#)
- [Use Extension Telephones](#)
- [If You Use a Non-Brother Cordless External Handset](#)
- [Use the Remote Codes](#)

Connect an External or Extension Telephone

Related Models: MFC-L2802DN/MFC-L2800DW/MFC-L2802DW/MFC-L2827DWXL/MFC-L2827DW/MFC-L2835DW/MFC-L2860DWE/MFC-L2860DW/MFC-L2862DW/MFC-L2922DW/MFC-L2960DW/MFC-L2980DW

You can connect a separate telephone to your machine as shown in the diagram below.

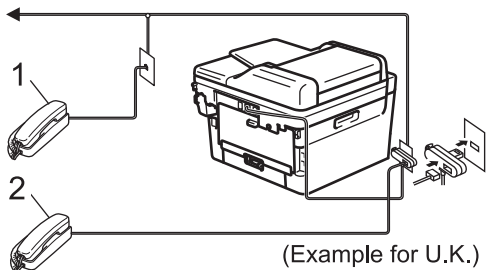

- 1 Extension telephone
- 2 External telephone



Make sure you use an external telephone with a cable no more than three metres long.



Related Information

- [External and Extension Telephones](#)

Operation from External and Extension Telephones

Related Models: MFC-L2802DN/MFC-L2800DW/MFC-L2802DW/MFC-L2827DWXL/MFC-L2827DW/MFC-L2835DW/MFC-L2860DWE/MFC-L2860DW/MFC-L2862DW/MFC-L2922DW/MFC-L2960DW/MFC-L2980DW

If you answer a fax call at an extension or an external telephone, you can make your machine take the call by using the Remote Activation Code. When you press the Remote Activation Code ***51**, the machine starts to receive the fax.

If the machine answers a voice call and pseudo/double-rings for you to take over, you can take the call at an extension telephone by pressing the Remote Deactivation Code **#51**.

If you answer a call and no one is on the line:

You are receiving a manual fax.

Press ***51** and wait for the chirp or until the LCD displays [Receiving], and then hang up.



You can also use the Fax Detect feature to make your machine automatically take the call.



Related Information

- [External and Extension Telephones](#)

Use Extension Telephones

Related Models: MFC-L2802DN/MFC-L2800DW/MFC-L2802DW/MFC-L2827DWXL/MFC-L2827DW/MFC-L2835DW/MFC-L2860DWE/MFC-L2860DW/MFC-L2862DW/MFC-L2922DW/MFC-L2960DW/MFC-L2980DW

Your premises may already be wired with parallel extension telephones, or you may plan to add extension telephones to your line, as well as your machine. While the simplest arrangement is a straightforward parallel connection, there are some problems with this. The most obvious is inadvertent interruption of a fax transmission caused by someone picking up an extension telephone to make an outgoing call. Also, the remote activation code feature may not operate reliably in such a simple configuration.

This machine may also be set to make a delayed transmission (a transmission at a preset time). This preset job may coincide with someone picking up an extension handset.

These problems can be eliminated, if you arrange modification of your extension wiring circuit, such that extension devices are connected “downstream” of your machine in a master/slave configuration (see Figure 1). In this configuration the machine can always detect whether a telephone is in use. Thus it will not attempt to use the line during that time. This is known as “telephone off-hook detection.”

The inadvisable configuration is shown in figure 2, and the recommended master/slave configuration is shown in figure 1.

This new connection configuration can be arranged by contacting BT, Kingston upon Hull Telecommunications, your PBX maintainer, or a qualified telephone installation company. The extension telephone circuit should be terminated on a normal modular plug (BT 431A style), which in turn should be put into the modular socket of the white “T”-shaped connector provided as part of the line cord assembly.

Connection of Extension Sockets: Recommended (Figure 1)

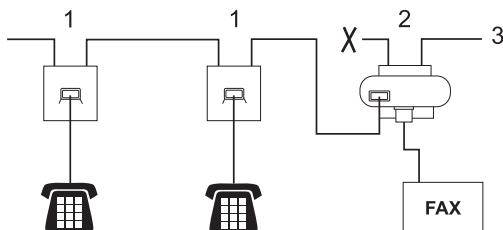

1. Extension socket
2. Master socket
3. Incoming line

Connection of Extension Sockets: Not Recommended (Figure 2)

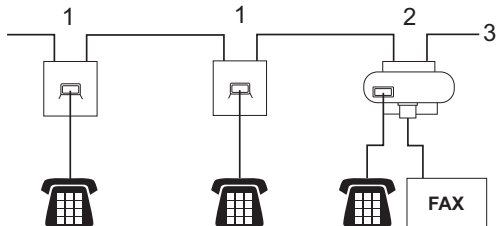

1. Extension socket
2. Master socket
3. Incoming line

The fax machine must be plugged into the master socket.



These telephones are now connected as external devices, because they are connected to the machine via the T-connector.



Related Information

- [External and Extension Telephones](#)
-

If You Use a Non-Brother Cordless External Handset

Related Models: MFC-L2802DN/MFC-L2800DW/MFC-L2802DW/MFC-L2827DWXL/MFC-L2827DW/MFC-L2835DW/MFC-L2860DWE/MFC-L2860DW/MFC-L2862DW/MFC-L2922DW/MFC-L2960DW/MFC-L2980DW

If your non-Brother cordless telephone is connected to the telephone line cord and you typically carry the cordless handset elsewhere, it is easier to answer calls during the Ring Delay.

If you let the machine answer first, you must go to the machine so you can press [Pickup] or **Tei/R** to transfer the call to the cordless handset.



Related Information

- [External and Extension Telephones](#)

Use the Remote Codes

Related Models: MFC-L2802DN/MFC-L2800DW/MFC-L2802DW/MFC-L2827DWXL/MFC-L2827DW/MFC-L2835DW/MFC-L2860DWE/MFC-L2860DW/MFC-L2862DW/MFC-L2922DW/MFC-L2960DW/MFC-L2980DW

Remote Activation Code

If you answer a fax call on an extension or external telephone, you can tell your machine to receive it by pressing the Remote Activation Code ***51**. Wait for the chirping sounds, and then replace the handset.

If you answer a fax call at the external telephone, you can make the machine receive the fax by pressing the buttons in the following table:

| Applicable Models | To make the machine receive a fax |
|---------------------------------------------------------------------------|-----------------------------------|
| MFC-L2802DN/MFC-L2800DW/MFC-L2802DW/MFC-L2827DWXL/MFC-L2827DW/MFC-L2835DW | Start and then ▼ |
| MFC-L2860DWE/MFC-L2860DW/MFC-L2862DW/MFC-L2922DW/MFC-L2960DW/MFC-L2980DW | Fax Start and then Receive |

Remote Deactivation Code

If you receive a voice call and the machine is in F/T mode, it will start to sound the F/T ring (fast double-ring) after the initial ring delay. If you pick up the call on an extension telephone you can turn the F/T ring off by pressing **#51** (make sure you press this between the rings).

If the machine answers a voice call and fast double-rings for you to take over, you can take the call at the external telephone by pressing the button in the following table:

| Applicable Models | To pick up a voice call |
|---------------------------------------------------------------------------|-------------------------|
| MFC-L2802DN/MFC-L2800DW/MFC-L2802DW/MFC-L2827DWXL/MFC-L2827DW/MFC-L2835DW | Tel/R |
| MFC-L2860DWE/MFC-L2860DW/MFC-L2862DW/MFC-L2922DW/MFC-L2960DW/MFC-L2980DW | Pickup |



Related Information

- [External and Extension Telephones](#)
 - [Change the Remote Codes](#)

Change the Remote Codes

Related Models: MFC-L2802DN/MFC-L2800DW/MFC-L2802DW/MFC-L2827DWXL/MFC-L2827DW/MFC-L2835DW/MFC-L2860DWE/MFC-L2860DW/MFC-L2862DW/MFC-L2922DW/MFC-L2960DW/MFC-L2980DW

The preset Remote Activation Code is *51. The preset Remote Deactivation Code is #51. If you are always disconnected when accessing your External TAD remotely, try changing the three-digit remote codes using the numbers 0-9, * or #.

>> MFC-L2802DN/MFC-L2800DW/MFC-L2802DW/MFC-L2827DWXL/MFC-L2827DW/MFC-L2835DW
>> MFC-L2860DWE/MFC-L2860DW/MFC-L2862DW/MFC-L2922DW/MFC-L2960DW/MFC-L2980DW

MFC-L2802DN/MFC-L2800DW/MFC-L2802DW/MFC-L2827DWXL/MFC-L2827DW/MFC-L2835DW



1. Press  (Fax).
2. Press **Menu**.
3. Press **▲** or **▼** to display the [Fax] option, and then press **OK**.
4. Press **▲** or **▼** to display the [Setup Receive] option, and then press **OK**.
5. Press **▲** or **▼** to display the [Remote Codes] option, and then press **OK**.
6. Press **▲** or **▼** to display the [On] option, and then press **OK**.



To turn off Remote Codes, select the [Off] option.

7. Enter the new Remote Activation Code, and then press **OK**.
8. Enter the new Remote Deactivation Code, and then press **OK**.
9. Press **Stop/Exit**.

MFC-L2860DWE/MFC-L2860DW/MFC-L2862DW/MFC-L2922DW/MFC-L2960DW/MFC-L2980DW

1. Press  [Settings] > [All Settings] > [Fax] > [Setup Receive] > [Remote Codes].
2. Do one of the following:
 - To change the Remote Activation Code, press [Act. Code]. Enter the new code, and then press [OK].
 - To change the Remote Deactivation Code, press [Deact. Code]. Enter the new code, and then press [OK].
 - If you do not want to change the Codes, go to the next step.
 - To turn off (or turn on) the Remote Codes, press [Remote Codes], and then press [Off] (or [On]).
3. Press .

✓ Related Information

- [Use the Remote Codes](#)

Multi-line Connections (PBX)

Related Models: MFC-L2802DN/MFC-L2800DW/MFC-L2802DW/MFC-L2827DWXL/MFC-L2827DW/
MFC-L2835DW/MFC-L2860DWE/MFC-L2860DW/MFC-L2862DW/MFC-L2922DW/MFC-L2960DW/
MFC-L2980DW

We suggest you ask the company that installed your PBX to connect your machine. If you have a multi-line system we suggest you ask the installer to connect the unit to the last line on the system. This prevents the machine from being activated each time the system receives telephone calls. If all incoming calls are answered by a switchboard operator, we recommend setting the Receive Mode to [Manual].

We cannot guarantee that your machine will operate correctly under all circumstances when connected to a PBX. Any difficulties with sending or receiving faxes should be reported first to the company that handles your PBX.



Related Information

- [Telephone Services and External Devices](#)

Fax Reports

Related Models: MFC-L2802DN/MFC-L2800DW/MFC-L2802DW/MFC-L2827DWXL/MFC-L2827DW/
MFC-L2835DW/MFC-L2860DWE/MFC-L2860DW/MFC-L2862DW/MFC-L2922DW/MFC-L2960DW/
MFC-L2980DW

- [Print a Transmission Verification Report](#)
- [Print a Fax Journal](#)

Print a Transmission Verification Report

Related Models: MFC-L2802DN/MFC-L2800DW/MFC-L2802DW/MFC-L2827DWXL/MFC-L2827DW/MFC-L2835DW/MFC-L2860DWE/MFC-L2860DW/MFC-L2862DW/MFC-L2922DW/MFC-L2960DW/MFC-L2980DW

You can use the Transmission Verification Report as proof that you sent a fax. This report lists the receiving party's name or fax number, the time and date of transmission, duration of transmission, number of pages sent, and whether or not the transmission was successful.

There are several settings available for the Transmission Verification Report:



| | |
|---------------------|--------------------------------------------------------------------------------------------------------------------------------------|
| On | Prints a report after every fax you send. |
| On (+Image) | Prints a report after every fax you send. A portion of the fax's first page appears on the report. |
| Error only | Prints a report if your fax is unsuccessful due to a transmission error. |
| Error only (+Image) | Prints a report if your fax is unsuccessful due to a transmission error. A portion of the fax's first page appears on the report. |
| Off | Your machine does not print any reports after sending faxes. |

>> [MFC-L2802DN/MFC-L2800DW/MFC-L2802DW/MFC-L2827DWXL/MFC-L2827DW/MFC-L2835DW](#)
>> [MFC-L2860DWE/MFC-L2860DW/MFC-L2862DW/MFC-L2922DW/MFC-L2960DW/MFC-L2980DW](#)

MFC-L2802DN/MFC-L2800DW/MFC-L2802DW/MFC-L2827DWXL/MFC-L2827DW/MFC-L2835DW

1. Press **Menu**.
2. Press **▲** or **▼** to display the [Fax] option, and then press **OK**.
3. Press **▲** or **▼** to display the [Report Setting] option, and then press **OK**.
4. Press **▲** or **▼** to display the [XMIT Report] option, and then press **OK**.
5. Press **▲** or **▼** to display the [Error Only], [ErrorOnly+Image], [Off], [On], or [On (+Image)] option, and press **OK**.
6. Press **Stop/Exit**.

MFC-L2860DWE/MFC-L2860DW/MFC-L2862DW/MFC-L2922DW/MFC-L2960DW/MFC-L2980DW

1. Press  [Settings] > [All Settings] > [Fax] > [Report Setting] > [XMIT Report].
 2. Press **▲** or **▼** to select the option you want.
If you select [On (+Image)] or [Error only (+Image)], the image will not appear on the Transmission Verification Report if Real Time Transmission is set to [On].
 3. Press .
- If the transmission is successful, OK appears next to RESULT on the Transmission Verification Report. If the transmission is not successful, ERROR appears next to RESULT.

Related Information

- [Fax Reports](#)

Print a Fax Journal

Related Models: MFC-L2802DN/MFC-L2800DW/MFC-L2802DW/MFC-L2827DWXL/MFC-L2827DW/
MFC-L2835DW/MFC-L2860DWE/MFC-L2860DW/MFC-L2862DW/MFC-L2922DW/MFC-L2960DW/
MFC-L2980DW

You can set the machine to print a Fax Journal at specific intervals (every 50 faxes, 6, 12 or 24 hours, 2 or 7 days).

>> [MFC-L2802DN/MFC-L2800DW/MFC-L2802DW/MFC-L2827DWXL/MFC-L2827DW/MFC-L2835DW](#)

>> [MFC-L2860DWE/MFC-L2860DW/MFC-L2862DW/MFC-L2922DW/MFC-L2960DW/MFC-L2980DW](#)

MFC-L2802DN/MFC-L2800DW/MFC-L2802DW/MFC-L2827DWXL/MFC-L2827DW/ MFC-L2835DW

1. Press **Menu**.
2. Press **▲** or **▼** to display the [Fax] option, and then press **OK**.
3. Press **▲** or **▼** to display the [Report Setting] option, and then press **OK**.
4. Press **▲** or **▼** to display the [Journal Period] option, and then press **OK**.
5. Press **▲** or **▼** to display the [Every 50 Faxes], [Every 6 Hours], [Every 12 Hours], [Every 24 Hours], [Every 2 Days], [Every 7 Days], or [Off] option, and then press **OK**.
 - 6, 12, 24 hours, 2 or 7 days
The machine will print the report at the selected time and then erase all jobs from its memory. If the machine's memory becomes full with 200 jobs before the time you selected has passed, the machine will print the Journal early and then erase all jobs from the memory. If you want an extra report before it is due to print, you can print it without erasing the jobs from the memory.
 - Every 50 Faxes
The machine will print the Journal when the machine has stored 50 jobs.
6. If you chose Every 7 Days, press **▲** or **▼** to display the [Every Monday], [Every Tuesday], [Every Wednesday], [Every Thursday], [Every Friday], [Every Saturday] or [Every Sunday] option, and then press **OK**.
7. If you selected 6, 12, 24 hours, 2 or 7 days, do one of the following to enter the time to start printing:
 - If you selected [12h Clock] in the Date&Time setting, enter the time in 12-hour format, and then press **OK**.
Press **▲** or **▼** to display the [AM] or [PM] option, and then press **OK**.
 - If you selected [24h Clock] in the Date&Time setting, enter the time in 24-hour format, and then press **OK**.
(For example, enter 19:45 for 7:45 PM.)
8. Press **Stop/Exit**.

MFC-L2860DWE/MFC-L2860DW/MFC-L2862DW/MFC-L2922DW/MFC-L2960DW/ MFC-L2980DW

1. Press  [Settings] > [All Settings] > [Fax] > [Report Setting] > [Journal Period] > [Journal Period].
2. Press **▲** or **▼** to select the interval you want, and then press it.
 - 6, 12, 24 hours, 2 or 7 days
The machine will print the report at the selected time and then erase all jobs from its memory. If the machine's memory becomes full with 200 jobs before the time you selected has passed, the machine will print the Journal early and then erase all jobs from the memory. If you want an extra report before it is due to print, you can print it without erasing the jobs from the memory.

-
- Every 50 Faxes

The machine will print the Journal when the machine has stored 50 jobs.

3. If you selected 6, 12, 24 hours, 2 or 7 days, press [Time] and enter the time using the LCD, and then press [OK].
4. If you selected [Every 7 Days], press [Day].
5. Press ▲ or ▼ to display the [Every Monday], [Every Tuesday], [Every Wednesday], [Every Thursday], [Every Friday], [Every Saturday] or [Every Sunday] option, and then press the first day of the 7-day countdown.
6. Press .



Related Information

- [Fax Reports](#)
-

PC-FAX

Related Models: MFC-L2802DN/MFC-L2800DW/MFC-L2802DW/MFC-L2827DWXL/MFC-L2827DW/
MFC-L2835DW/MFC-L2860DWE/MFC-L2860DW/MFC-L2862DW/MFC-L2922DW/MFC-L2960DW/
MFC-L2980DW

- [PC-FAX for Windows](#)
- [PC-FAX for Mac](#)

PC-FAX for Windows

Related Models: MFC-L2802DN/MFC-L2800DW/MFC-L2802DW/MFC-L2827DWXL/MFC-L2827DW/
MFC-L2835DW/MFC-L2860DWE/MFC-L2860DW/MFC-L2862DW/MFC-L2922DW/MFC-L2960DW/
MFC-L2980DW

- [PC-FAX Overview \(Windows\)](#)
- [Send a Fax Using PC-FAX \(Windows\)](#)
- [Receive Faxes on Your Computer \(Windows\)](#)

PC-FAX Overview (Windows)

Related Models: MFC-L2802DN/MFC-L2800DW/MFC-L2802DW/MFC-L2827DWXL/MFC-L2827DW/
MFC-L2835DW/MFC-L2860DWE/MFC-L2860DW/MFC-L2862DW/MFC-L2922DW/MFC-L2960DW/
MFC-L2980DW

Reduce paper consumption and save time by using the Brother PC-FAX software to send faxes directly from your computer.

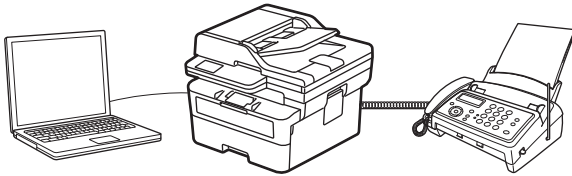

- [Configure PC-FAX \(Windows\)](#)
- [Configure your PC-Fax Address Book \(Windows\)](#)

Configure PC-FAX (Windows)

Related Models: MFC-L2802DN/MFC-L2800DW/MFC-L2802DW/MFC-L2827DWXL/MFC-L2827DW/MFC-L2835DW/MFC-L2860DWE/MFC-L2860DW/MFC-L2862DW/MFC-L2922DW/MFC-L2960DW/MFC-L2980DW

Before sending faxes using PC-FAX, personalise the send options in each tab of the **PC-FAX Setup** dialog box.

1. Launch  (**Brother Utilities**), and then click the drop-down list and select your model name (if not already selected).
2. Click **PC-FAX** in the left navigation bar, and then click **Setup Sending**.

The **PC-FAX Setup** dialog box appears.

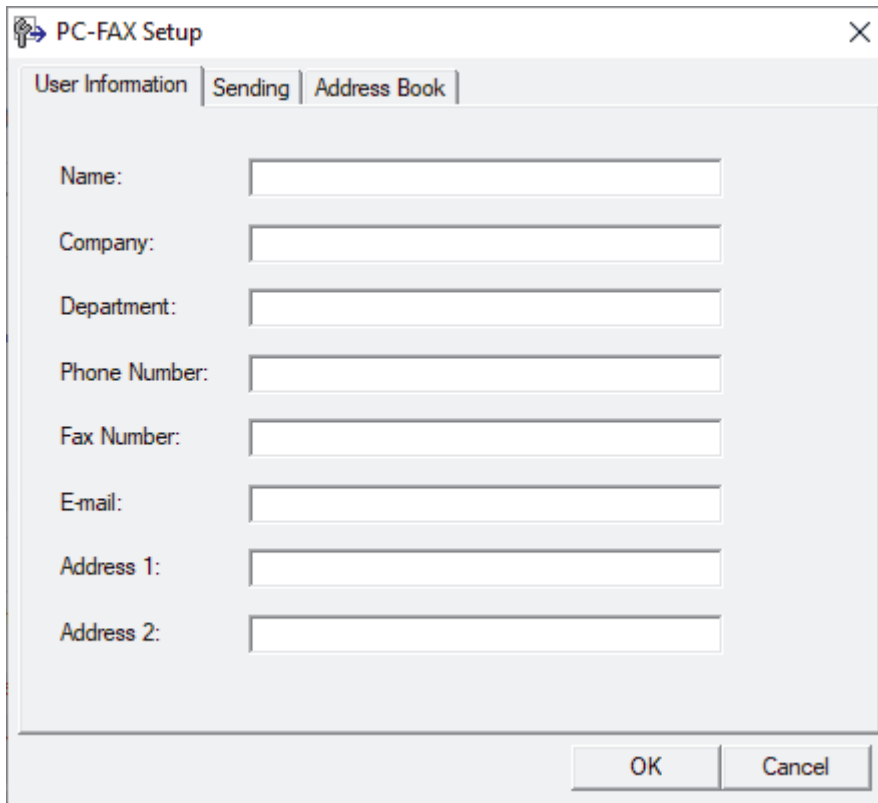

3. Do one of the following:
 - Click the **User Information** tab, and then type your user information in the fields.



Each Microsoft account can have its own customised **User Information** screen for custom fax headers and cover pages.

- Click the **Sending** tab, and then type the number needed to access an outside line (if needed) in the **Outside line access** field. Select the **Include header** checkbox to include the header information.
 - Click the **Address Book** tab, and then select the address book you want to use for PC-FAX from the **Select Address Book** drop-down list.
4. Click **OK**.



Related Information

- [PC-FAX Overview \(Windows\)](#)

Configure your PC-Fax Address Book (Windows)

Related Models: MFC-L2802DN/MFC-L2800DW/MFC-L2802DW/MFC-L2827DWXL/MFC-L2827DW/MFC-L2835DW/MFC-L2860DWE/MFC-L2860DW/MFC-L2862DW/MFC-L2922DW/MFC-L2960DW/MFC-L2980DW

Add, edit, and delete members and groups to personalise your **Address Book**.

- [Add a Member to your PC-FAX Address Book \(Windows\)](#)
- [Create a Group in your PC-FAX Address Book \(Windows\)](#)
- [Edit Member or Group Information in your PC-FAX Address Book \(Windows\)](#)
- [Delete a Member or Group in your PC-FAX Address Book \(Windows\)](#)
- [Export your PC-FAX Address Book \(Windows\)](#)
- [Import Information to your PC-FAX Address Book \(Windows\)](#)

Add a Member to your PC-FAX Address Book (Windows)

Related Models: MFC-L2802DN/MFC-L2800DW/MFC-L2802DW/MFC-L2827DWXL/MFC-L2827DW/MFC-L2835DW/MFC-L2860DWE/MFC-L2860DW/MFC-L2862DW/MFC-L2922DW/MFC-L2960DW/MFC-L2980DW

Add new people and their fax information to the PC-Fax Address Book if you want to send a fax using the Brother PC-Fax software.

1. Launch  (**Brother Utilities**), and then click the drop-down list and select your model name (if not already selected).
2. Click **PC-FAX** in the left navigation bar, and then click **Address Book (Send)**.

The **Address Book** dialog box appears.

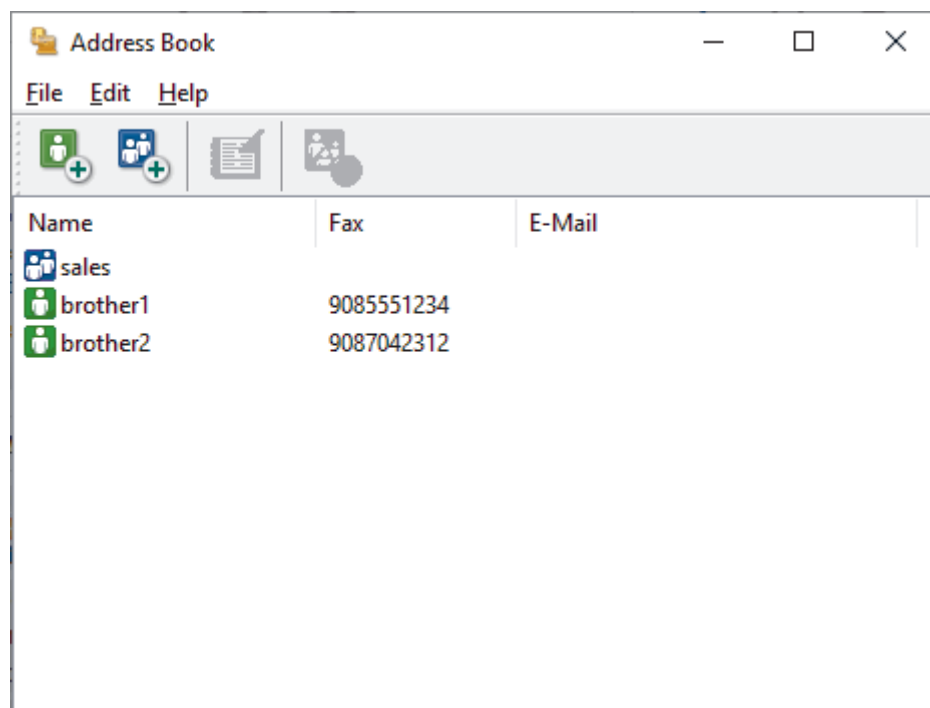

3. Click  to add new members.
The **Address Book Member Setup** dialog box appears.
4. Type the member's information in the corresponding fields. The **Name** field is required.
5. Click **OK**.

Related Information

- [Configure your PC-Fax Address Book \(Windows\)](#)

Create a Group in your PC-FAX Address Book (Windows)

Related Models: MFC-L2802DN/MFC-L2800DW/MFC-L2802DW/MFC-L2827DWXL/MFC-L2827DW/MFC-L2835DW/MFC-L2860DWE/MFC-L2860DW/MFC-L2862DW/MFC-L2922DW/MFC-L2960DW/MFC-L2980DW

Create a group to broadcast the same PC-FAX to several recipients at once.

1. Launch  (**Brother Utilities**), and then click the drop-down list and select your model name (if not already selected).
2. Click **PC-FAX** in the left navigation bar, and then click **Address Book (Send)**.

The **Address Book** dialog box appears.

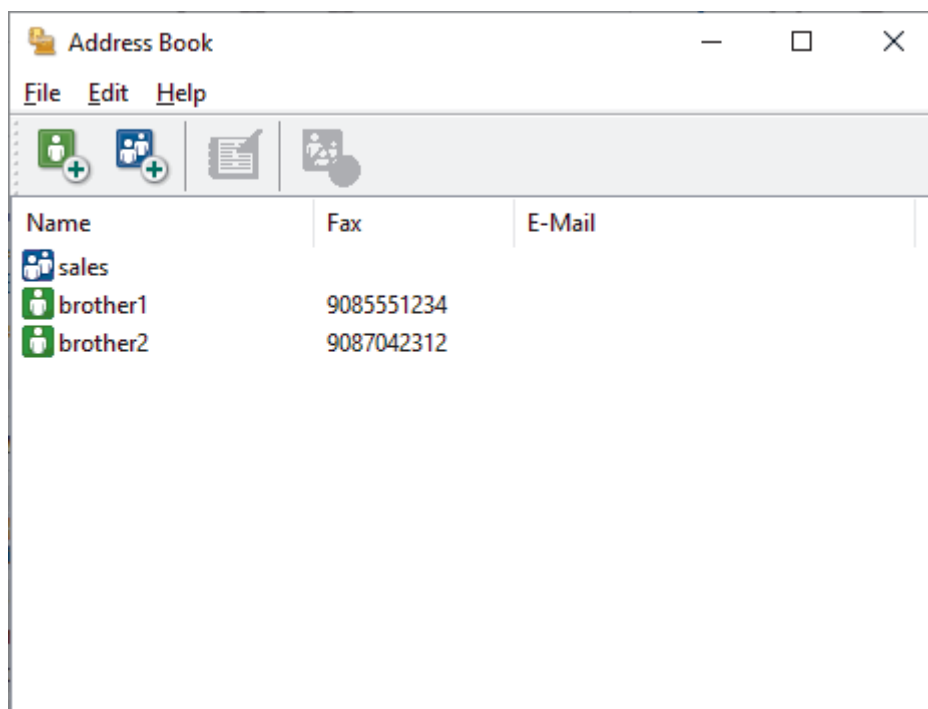

3. Click  to add a new group.
The **Address Book Group Setup** dialog box appears.
4. Type the name of the new group in the **Group Name** field.
5. In the **Available Names** field, select each name you want to include in the group, and then click **Add >>**.
Members added to the group appear in the **Group Members** box.
6. When finished, click **OK**.



Each group can contain up to 50 members.



Related Information

- [Configure your PC-Fax Address Book \(Windows\)](#)

Edit Member or Group Information in your PC-FAX Address Book (Windows)

Related Models: MFC-L2802DN/MFC-L2800DW/MFC-L2802DW/MFC-L2827DWXL/MFC-L2827DW/MFC-L2835DW/MFC-L2860DWE/MFC-L2860DW/MFC-L2862DW/MFC-L2922DW/MFC-L2960DW/MFC-L2980DW

1. Launch  (**Brother Utilities**), and then click the drop-down list and select your model name (if not already selected).
2. Click **PC-FAX** in the left navigation bar, and then click **Address Book (Send)**.

The **Address Book** dialog box appears.

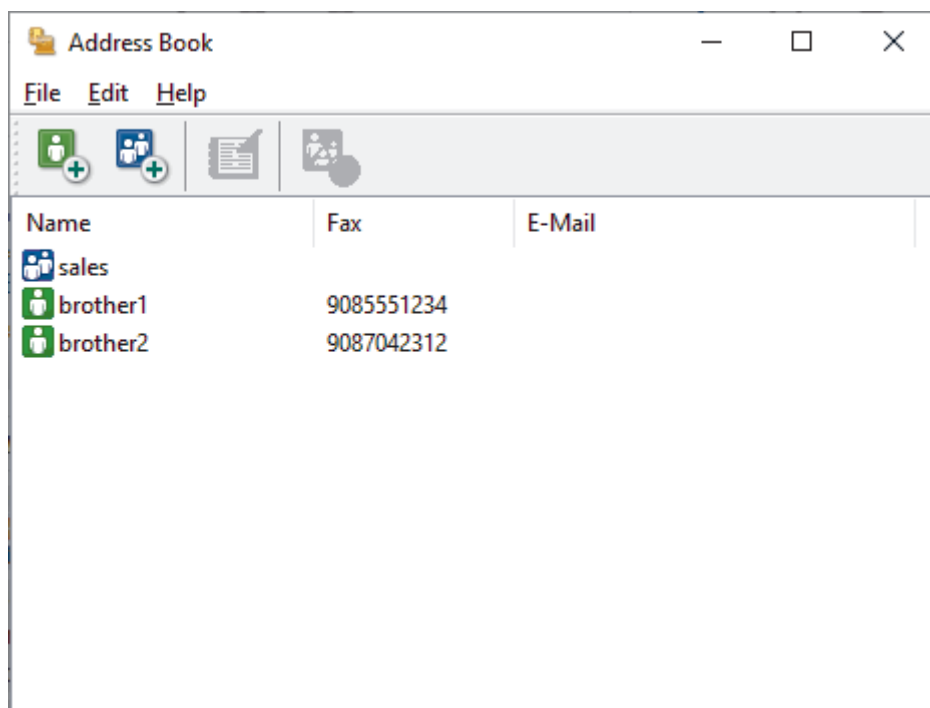

3. Select the member or group you want to edit.
4. Click  (**Properties**).
5. Change the member or group information.
6. Click **OK**.

Related Information

- [Configure your PC-Fax Address Book \(Windows\)](#)

Delete a Member or Group in your PC-FAX Address Book (Windows)

Related Models: MFC-L2802DN/MFC-L2800DW/MFC-L2802DW/MFC-L2827DWXL/MFC-L2827DW/MFC-L2835DW/MFC-L2860DWE/MFC-L2860DW/MFC-L2862DW/MFC-L2922DW/MFC-L2960DW/MFC-L2980DW

1. Launch  (**Brother Utilities**), and then click the drop-down list and select your model name (if not already selected).
2. Click **PC-FAX** in the left navigation bar, and then click **Address Book (Send)**.
The **Address Book** dialog box appears.

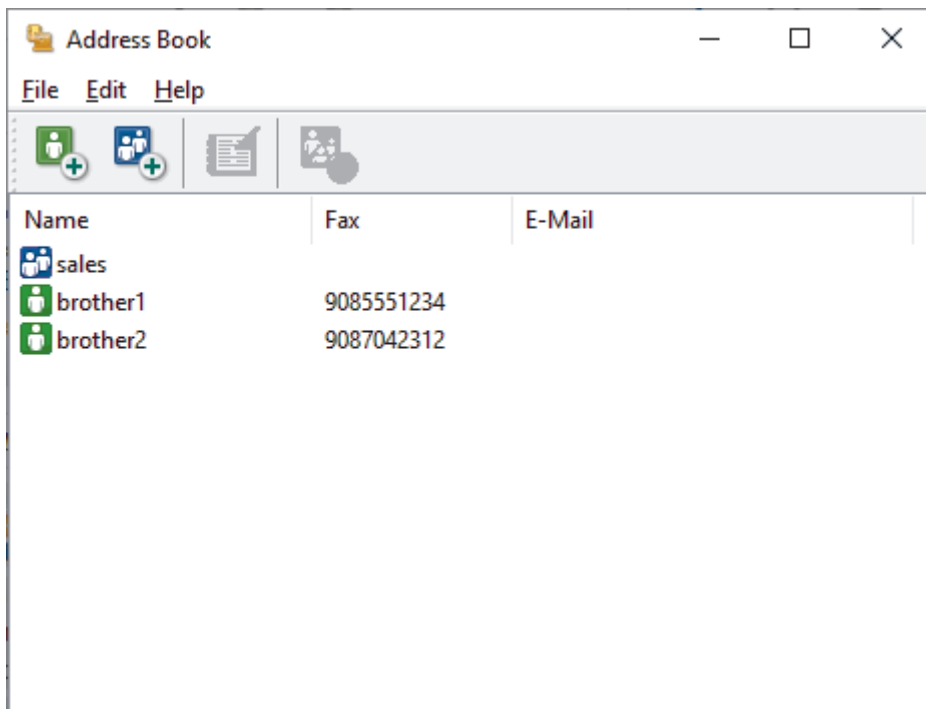

3. Select the member or group you want to delete.
4. Click  (**Delete**).
5. When the confirmation dialog box appears, click **OK**.

Related Information

- [Configure your PC-Fax Address Book \(Windows\)](#)

Export your PC-FAX Address Book (Windows)

Related Models: MFC-L2802DN/MFC-L2800DW/MFC-L2802DW/MFC-L2827DWXL/MFC-L2827DW/MFC-L2835DW/MFC-L2860DWE/MFC-L2860DW/MFC-L2862DW/MFC-L2922DW/MFC-L2960DW/MFC-L2980DW

You can export the Address Book as an ASCII text file (*.csv) or a vCard (an electronic business card) and save it on your computer.

You cannot export the group settings when you export the **Address Book** data.

1. Launch  (**Brother Utilities**), and then click the drop-down list and select your model name (if not already selected).
2. Click **PC-FAX** in the left navigation bar, and then click **Address Book (Send)**.

The **Address Book** dialog box appears.

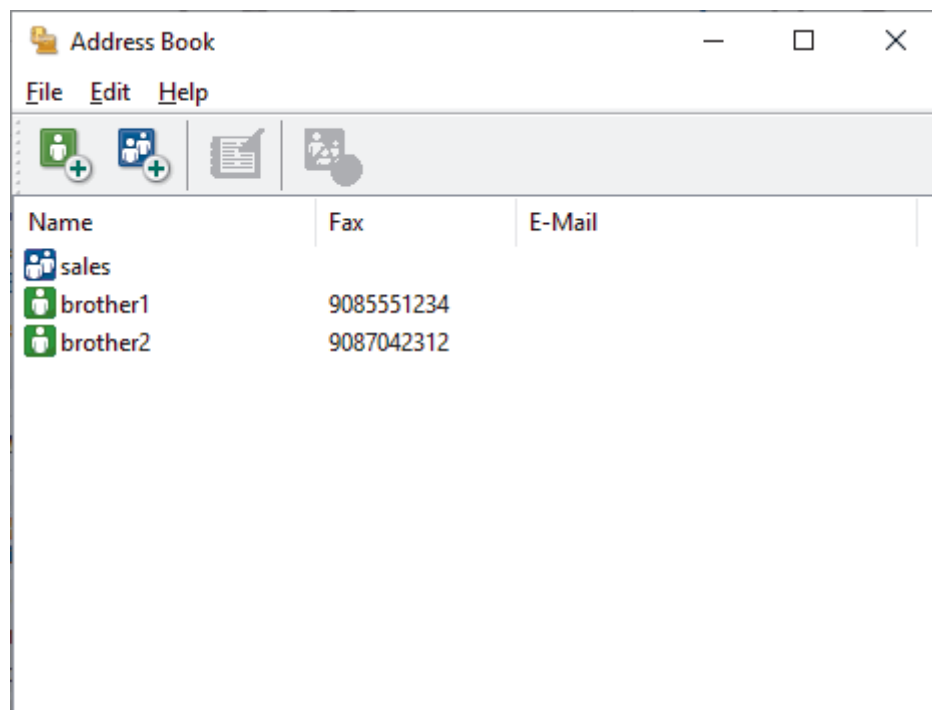

3. Click **File > Export**.
4. Select one of the following:
 - **Text**
The **Select Items** dialog box appears. Go to the next step.
 - **vCard**
You must select the member you want to export from your address book before selecting this option.
Browse to the folder where you want to save the vCard, type the vCard name in the **File name** field, and then click **Save**.
5. In the **Available Items** field, select the data you want to export, and then click **Add >>**.



Select and add the items in the order you want them listed.

6. If you are exporting to an ASCII file, under the **Divide Character** section, select the **Tab** or **Comma** option to separate the data fields.
7. Click **OK**.

-
8. Browse to the folder on your computer where you want to save the data, type the file name, and then click **Save**.



Related Information

- [Configure your PC-Fax Address Book \(Windows\)](#)
-

Import Information to your PC-FAX Address Book (Windows)

Related Models: MFC-L2802DN/MFC-L2800DW/MFC-L2802DW/MFC-L2827DWXL/MFC-L2827DW/MFC-L2835DW/MFC-L2860DWE/MFC-L2860DW/MFC-L2862DW/MFC-L2922DW/MFC-L2960DW/MFC-L2980DW

You can import ASCII text files (*.csv) or vCards (electronic business cards) into your Address Book.

1. Launch  (**Brother Utilities**), and then click the drop-down list and select your model name (if not already selected).
2. Click **PC-FAX** in the left navigation bar, and then click **Address Book (Send)**.

The **Address Book** dialog box appears.

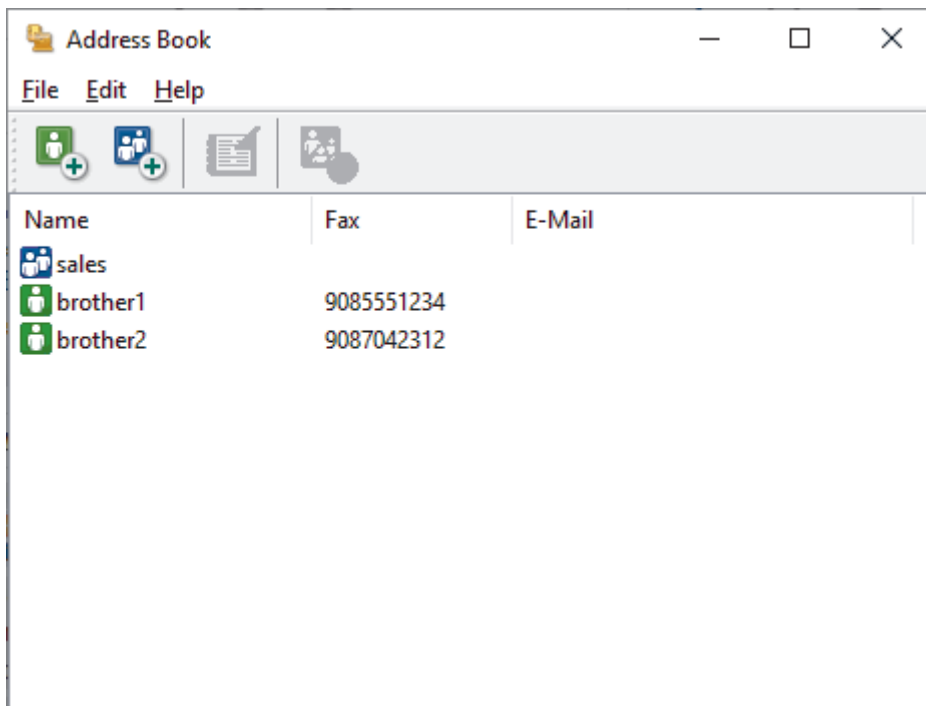

3. Click **File > Import**.
4. Select one of the following:
 - **Text**
The **Select Items** dialog box appears. Go to step 5.
 - **vCard**
Go to step 8.
5. In the **Available Items** field, select the data you want to import, and then click **Add >>**.



You must select and add fields from the **Available Items** list in the same order they are listed in the import text file.

6. If you are importing an ASCII file, under the **Divide Character** section, select the **Tab** or **Comma** option to separate the data fields.
7. Click **OK**.
8. Browse to the folder where you want to import the data, type the file name, and then click **Open**.



Related Information

- [Configure your PC-Fax Address Book \(Windows\)](#)

Send a Fax Using PC-FAX (Windows)

Related Models: MFC-L2802DN/MFC-L2800DW/MFC-L2802DW/MFC-L2827DWXL/MFC-L2827DW/
MFC-L2835DW/MFC-L2860DWE/MFC-L2860DW/MFC-L2862DW/MFC-L2922DW/MFC-L2960DW/
MFC-L2980DW

PC-FAX supports only monochrome faxes. A monochrome fax will be sent even if the original data is in colour and the receiving fax machine supports colour faxes.

1. Create a file in any application on your computer.
2. Select the print command in your application.
3. Select **Brother PC-FAX** as your printer, and then complete your print operation.

The **Brother PC-FAX** dialog box appears.

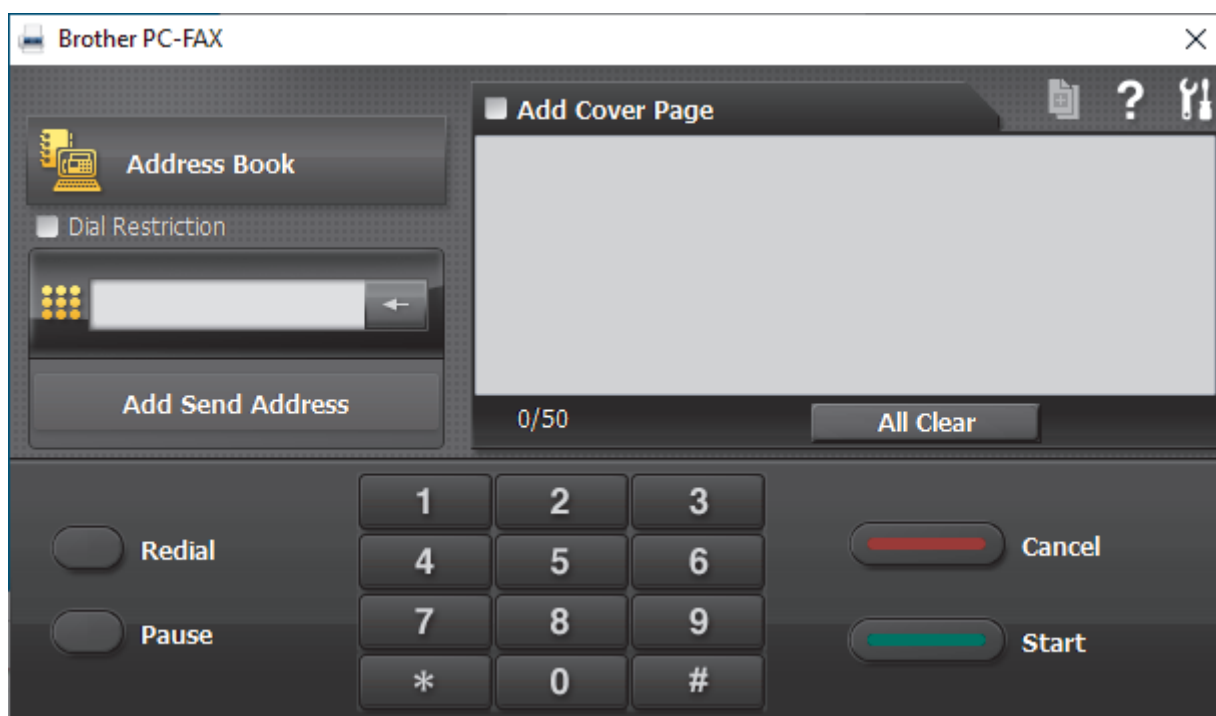

4. Type a fax number using one of the following methods:
 - Click the numbers on the dial pad to type the number, and then click **Add Send Address**.



If you select the **Dial Restriction** checkbox, a confirmation dialog box will appear for you to re-type the fax number using the keyboard. This feature helps to prevent transmissions to the wrong destination.

- Click the **Address Book** button, and then select a member or group from the Address Book.



If you make a mistake, click **All Clear** to delete all entries.

5. To include a cover page, select the **Add Cover Page** checkbox. You can also click  to create or edit a cover page.
6. Click **Start** to send the fax.



- To cancel the fax, click **Cancel**.
- To redial a number, click **Redial** to show the last five fax numbers, select a number, and then click **Start**.



Related Information

- [PC-FAX for Windows](#)
-

Receive Faxes on Your Computer (Windows)

Related Models: MFC-L2802DN/MFC-L2800DW/MFC-L2802DW/MFC-L2827DWXL/MFC-L2827DW/
MFC-L2835DW/MFC-L2860DWE/MFC-L2860DW/MFC-L2862DW/MFC-L2922DW/MFC-L2960DW/
MFC-L2980DW

Use the Brother PC-FAX software to receive faxes on your computer, view them, and print only those faxes you want.

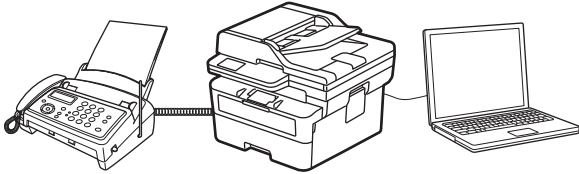

- [Receive Faxes Using PC-FAX Receive \(Windows\)](#)

Receive Faxes Using PC-FAX Receive (Windows)

Related Models: MFC-L2802DN/MFC-L2800DW/MFC-L2802DW/MFC-L2827DWXL/MFC-L2827DW/MFC-L2835DW/MFC-L2860DWE/MFC-L2860DW/MFC-L2862DW/MFC-L2922DW/MFC-L2960DW/MFC-L2980DW

The Brother PC-FAX Receive software lets you view and store faxes on your computer. It is automatically installed when you install your machine's software and drivers and works on locally or network-connected machines.

PC-FAX Receive supports only monochrome faxes.

When you turn your computer off, your machine will continue to receive and store faxes in your machine's memory. The machine's LCD will display the number of stored faxes received. When you start this application, the software will transfer all received faxes to your computer at once. You can enable the Backup Print option if you want the machine to print a copy of the fax before the fax is sent to your computer, or before the computer is switched off. You can configure the Backup Print settings from your machine.



Related Information

- [Receive Faxes on Your Computer \(Windows\)](#)
 - [Run the Brother PC-FAX Receive on Your Computer \(Windows\)](#)
 - [View Received PC-FAX Messages \(Windows\)](#)

Run the Brother PC-FAX Receive on Your Computer (Windows)

Related Models: MFC-L2802DN/MFC-L2800DW/MFC-L2802DW/MFC-L2827DWXL/MFC-L2827DW/MFC-L2835DW/MFC-L2860DWE/MFC-L2860DW/MFC-L2862DW/MFC-L2922DW/MFC-L2960DW/MFC-L2980DW

If the PC-FAX receiving is disabled on your machine, enable the setting before trying to run the PC-FAX receiving.

For information on how to enable this function, see *Related Information: Configure PC-FAX Receiving Using Web Based Management*.



We recommend selecting the **Start PC-FAX Receive on computer startup** checkbox so that the software runs automatically and transfers any faxes when you turn your computer on.

1. Launch  (**Brother Utilities**), and then click the drop-down list and select your model name (if not already selected).
2. Click **PC-FAX** in the left navigation bar, and then click **Receive**.
3. Confirm the message and click **Yes**.

The **PC-FAX Receive** window appears. The  (**PC-Fax Receive (Ready)**) icon also appears in your computer task tray.



Related Information

- [Receive Faxes Using PC-FAX Receive \(Windows\)](#)
 - [Set Up PC-FAX Receive on Your Computer \(Windows\)](#)
 - [Add Your Machine to PC-FAX Receive Devices \(Windows\)](#)

Related Topics:

- [Configure PC-FAX Receiving Using Web Based Management](#)

Set Up PC-FAX Receive on Your Computer (Windows)

Related Models: MFC-L2802DN/MFC-L2800DW/MFC-L2802DW/MFC-L2827DWXL/MFC-L2827DW/MFC-L2835DW/MFC-L2860DWE/MFC-L2860DW/MFC-L2862DW/MFC-L2922DW/MFC-L2960DW/MFC-L2980DW

1. Double-click the  (**PC-Fax Receive (Ready)**) icon in your computer task tray.

The **PC-FAX Receive** window appears.

2. Click **Settings**.
3. Configure these options as needed:

Preferences

Configure to start PC-FAX Receive automatically when you start Windows.

Save

Configure the path to save PC-FAX files and select the received document format.

Upload to

Configure the path to the server and select the option to upload automatically or manually (available only for administrators).

Device

Select the machine where you want to receive PC-FAX files.

Lock (available only for administrators)

Restrict users who do not have administrator privileges from configuring the settings options shown above.

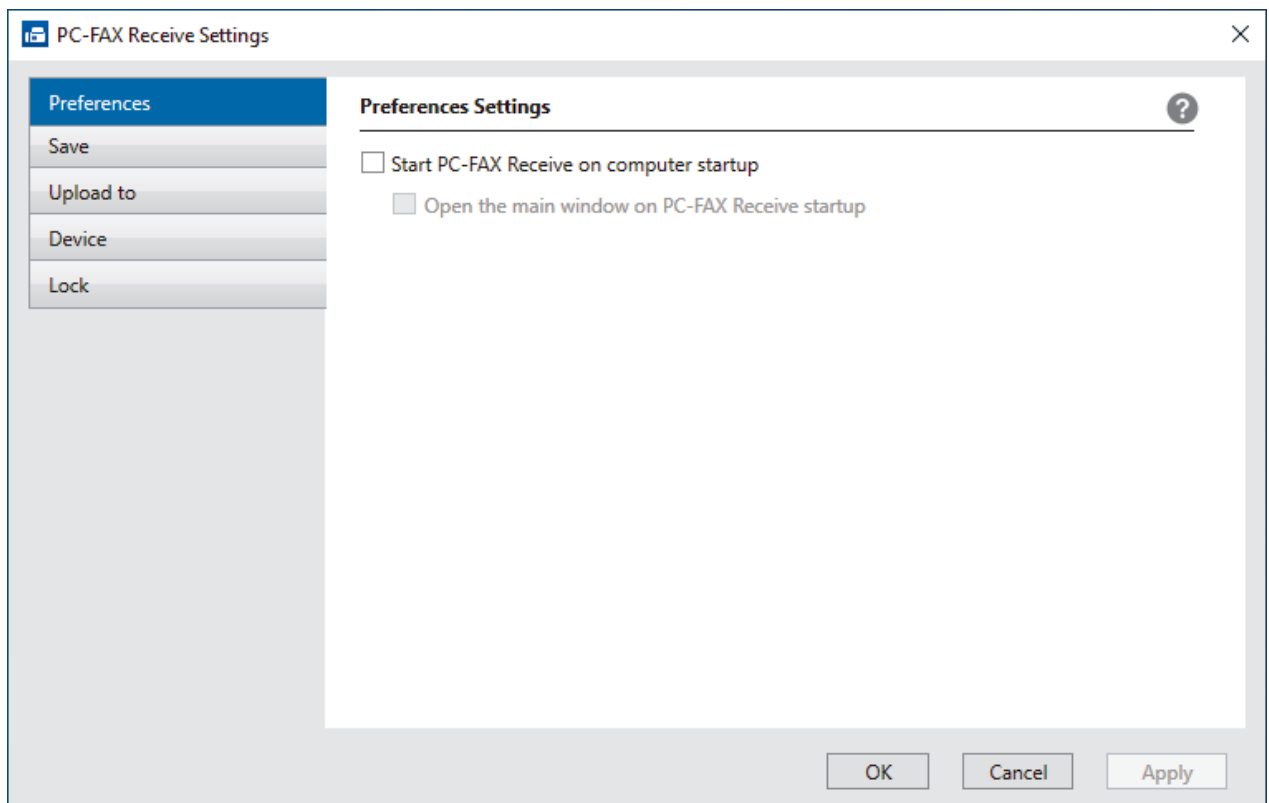

4. Click **OK**.



Related Information

- [Run the Brother PC-FAX Receive on Your Computer \(Windows\)](#)
-

Add Your Machine to PC-FAX Receive Devices (Windows)

Related Models: MFC-L2802DN/MFC-L2800DW/MFC-L2802DW/MFC-L2827DWXL/MFC-L2827DW/MFC-L2835DW/MFC-L2860DWE/MFC-L2860DW/MFC-L2862DW/MFC-L2922DW/MFC-L2960DW/MFC-L2980DW

If you installed your machine following the on-screen instructions, the machine should be ready for use.

1. Double-click the  (**PC-Fax Receive (Ready)**) icon in your computer task tray.
The **PC-FAX Receive** window appears.
2. Click **Settings**.
3. Click **Device > Add**.

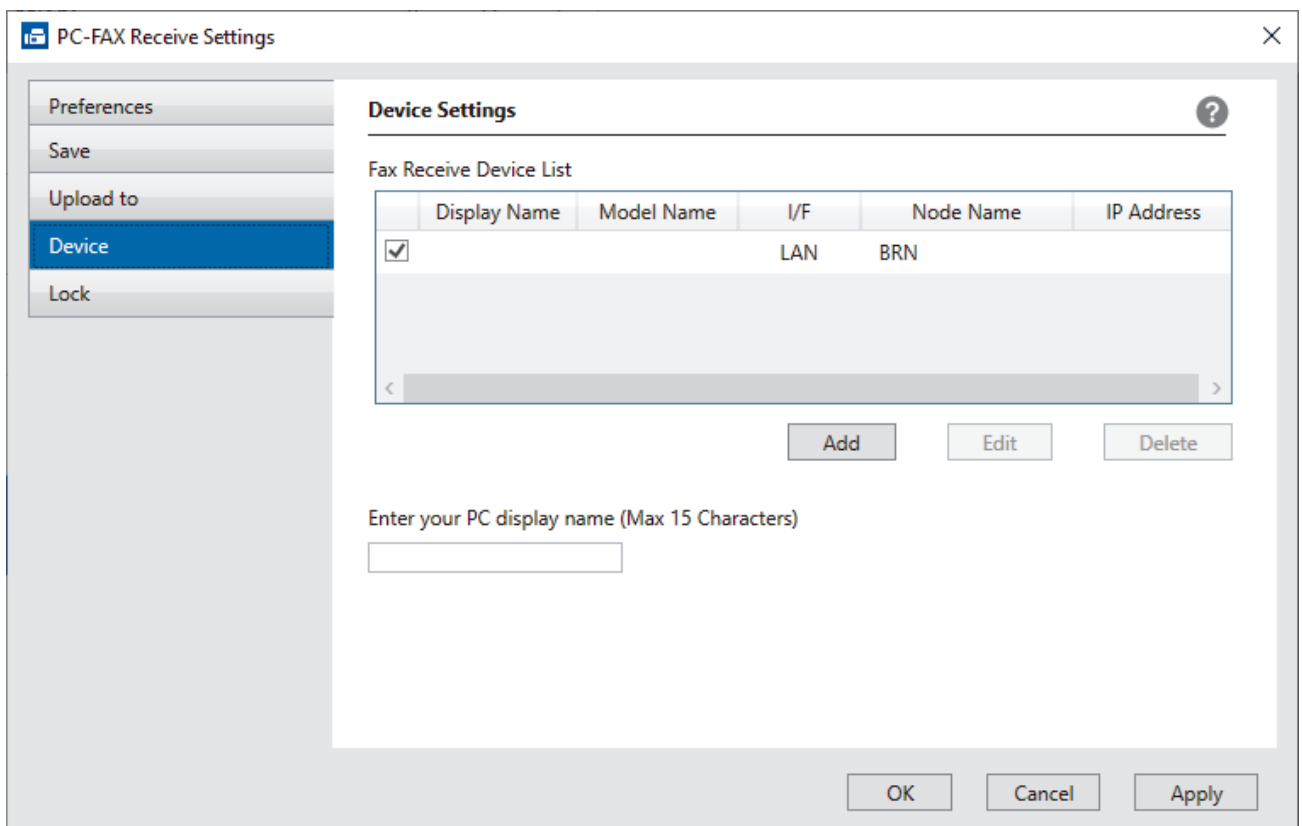

4. Select the correct connection method.
Select your machine from the automatic search results below.
A list of connected machines appears. Select the machine you want. Click **OK**.
Specify your machine by IP address
Type the machine's IP address in the **IP Address** field, and then click **OK**.
5. To change the computer name that will appear on the machine's LCD, type the new name in the **Enter your PC display name (Max 15 Characters)** field.
6. Click **OK**.



Related Information

- [Run the Brother PC-FAX Receive on Your Computer \(Windows\)](#)

View Received PC-FAX Messages (Windows)

Related Models: MFC-L2802DN/MFC-L2800DW/MFC-L2802DW/MFC-L2827DWXL/MFC-L2827DW/MFC-L2835DW/MFC-L2860DWE/MFC-L2860DW/MFC-L2862DW/MFC-L2922DW/MFC-L2960DW/MFC-L2980DW

Receiving Status

| Icon | Status |
|-----------------------------------------------------------------------------------|--------------------------------------|
|  | Standby mode No unread messages |
|  | Receiving messages |
|  | Messages received Unread messages |

1. Double-click the  (**PC-Fax Receive (Ready)**) icon in your computer task tray.

The **PC-FAX Receive** window appears.

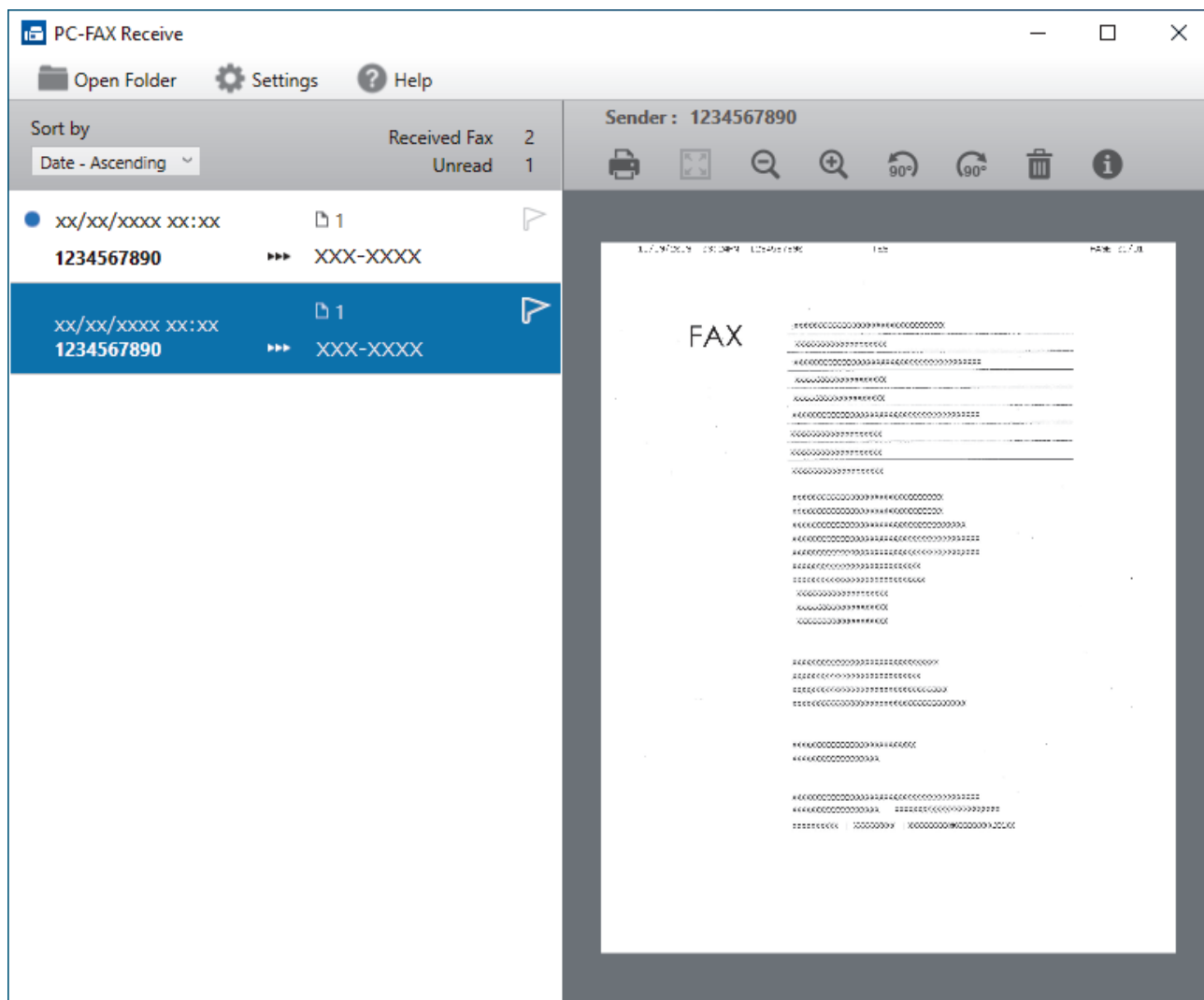

2. Click any faxes in the list to view them.
3. When finished, close the window.



Even after closing the window, PC-FAX Receive is active and the  (PC-Fax Receive (Ready)) icon will remain in your computer task tray. To close PC-FAX Receive, click the icon in the computer task tray and click **Close**.



Related Information

- [Receive Faxes Using PC-FAX Receive \(Windows\)](#)
-

PC-FAX for Mac

Related Models: MFC-L2802DN/MFC-L2800DW/MFC-L2802DW/MFC-L2827DWXL/MFC-L2827DW/
MFC-L2835DW/MFC-L2860DWE/MFC-L2860DW/MFC-L2862DW/MFC-L2922DW/MFC-L2960DW/
MFC-L2980DW

- [Send a Fax Using AirPrint \(macOS\)](#)

Network

Related Models: DCP-L2620DW/DCP-L2622DW/DCP-L2627DW/DCP-L2627DWXL/DCP-L2627DWE/
DCP-L2640DN/DCP-L2660DW/DCP-L2665DW/MFC-L2802DN/MFC-L2800DW/MFC-L2802DW/
MFC-L2827DWXL/MFC-L2827DW/MFC-L2835DW/MFC-L2860DWE/MFC-L2860DW/MFC-L2862DW/
MFC-L2922DW/MFC-L2960DW/MFC-L2980DW

- [Supported Basic Network Features](#)
- [Configure Network Settings](#)
- [Wireless Network Settings](#)
- [Network Features](#)

Supported Basic Network Features

Related Models: DCP-L2620DW/DCP-L2622DW/DCP-L2627DW/DCP-L2627DWXL/DCP-L2627DWE/DCP-L2640DN/DCP-L2660DW/DCP-L2665DW/MFC-L2802DN/MFC-L2800DW/MFC-L2802DW/MFC-L2827DWXL/MFC-L2827DW/MFC-L2835DW/MFC-L2860DWE/MFC-L2860DW/MFC-L2862DW/MFC-L2922DW/MFC-L2960DW/MFC-L2980DW

The machine supports various features depending on the operating system. Use this table to see which network features and connections are supported by each operating system.

| Operating Systems | Windows | Windows Server | macOS |
|-----------------------------------------------|---------|----------------|-------|
| Printing | Yes | Yes | Yes |
| Scanning | Yes | | Yes |
| PC Fax Send (available for certain models) | Yes | | Yes |
| PC Fax Receive (available for certain models) | Yes | | |
| Web Based Management ¹ | Yes | Yes | Yes |
| Status Monitor | Yes | | |
| Driver Deployment Wizard | Yes | Yes | |

¹ The default password to manage your machine's settings is located on the back of the machine and marked "Pwd". We recommend immediately changing the default password to protect your machine from unauthorised access.



- When connecting your machine to an outside network such as the Internet, make sure your network environment is protected by a separate firewall or other means in order to prevent information leaks due to inadequate settings or unauthorised access by malicious third parties.
- When your machine is connected to the global network, a warning appears. When you see this warning, we strongly recommend confirming your network settings, and then re-connecting to a secure network.
- Enabling your machine's global network communication filtering feature blocks access from the global network. The global network communication filtering feature may prevent the machine from receiving certain print or scan jobs from a computer or mobile device that uses a global IP address.



Related Information

- [Network](#)

Related Topics:

- [Change the Login Password Using Web Based Management](#)

Configure Network Settings

Related Models: DCP-L2620DW/DCP-L2622DW/DCP-L2627DW/DCP-L2627DWXL/DCP-L2627DWE/
DCP-L2640DN/DCP-L2660DW/DCP-L2665DW/MFC-L2802DN/MFC-L2800DW/MFC-L2802DW/
MFC-L2827DWXL/MFC-L2827DW/MFC-L2835DW/MFC-L2860DWE/MFC-L2860DW/MFC-L2862DW/
MFC-L2922DW/MFC-L2960DW/MFC-L2980DW

- [Configure Network Details Using the Control Panel](#)
- [Change Machine Settings Using Web Based Management](#)

Configure Network Details Using the Control Panel

Related Models: DCP-L2620DW/DCP-L2622DW/DCP-L2627DW/DCP-L2627DWXL/DCP-L2627DWE/DCP-L2640DN/DCP-L2660DW/DCP-L2665DW/MFC-L2802DN/MFC-L2800DW/MFC-L2802DW/MFC-L2827DWXL/MFC-L2827DW/MFC-L2835DW/MFC-L2860DWE/MFC-L2860DW/MFC-L2862DW/MFC-L2922DW/MFC-L2960DW/MFC-L2980DW

To configure the machine for your network, use the control panel's [Network] menu selections.



- For information about the network settings you can configure using the control panel, see *Related Information: Settings Tables*.
- You can also use Web Based Management, to configure and change your machine's network settings.

>> DCP-L2620DW/DCP-L2622DW/DCP-L2627DW/DCP-L2627DWXL/DCP-L2627DWE/DCP-L2640DN/
MFC-L2802DN/MFC-L2800DW/MFC-L2802DW/MFC-L2827DWXL/MFC-L2827DW/MFC-L2835DW
>> DCP-L2660DW/DCP-L2665DW/MFC-L2860DWE/MFC-L2860DW/MFC-L2862DW/MFC-L2922DW/
MFC-L2960DW/MFC-L2980DW

**DCP-L2620DW/DCP-L2622DW/DCP-L2627DW/DCP-L2627DWXL/DCP-L2627DWE/
DCP-L2640DN/MFC-L2802DN/MFC-L2800DW/MFC-L2802DW/MFC-L2827DWXL/
MFC-L2827DW/MFC-L2835DW**

1. Press **Menu**.
2. Press **▲** or **▼** to select the [Network] option, and then press **OK**.
3. Press **▲** or **▼** to select the network option you want, and then press **OK**. Repeat this step until you access the menu you want to configure, and then follow the LCD instructions.

**DCP-L2660DW/DCP-L2665DW/MFC-L2860DWE/MFC-L2860DW/MFC-L2862DW/
MFC-L2922DW/MFC-L2960DW/MFC-L2980DW**

1. Press  [Settings] > [All Settings] > [Network].
2. Press **▲** or **▼** to display the network option you want, and then press it. Repeat this step until you access the menu you want to configure, and then follow the LCD instructions.

Related Information

- [Configure Network Settings](#)

Related Topics:

- [Settings Tables \(2 Line LCD MFC models\)](#)
- [Settings Tables \(2 Line LCD DCP models\)](#)
- [Settings Tables \(2.7" Touch Panel MFC models and 3.5" Touch Panel MFC models\)](#)
- [Settings Tables \(2.7" Touch Panel DCP models\)](#)
- [Supported Basic Network Features](#)

Wireless Network Settings

Related Models: DCP-L2620DW/DCP-L2622DW/DCP-L2627DW/DCP-L2627DWXL/DCP-L2627DWE/
DCP-L2660DW/DCP-L2665DW/MFC-L2800DW/MFC-L2802DW/MFC-L2827DWXL/MFC-L2827DW/
MFC-L2835DW/MFC-L2860DWE/MFC-L2860DW/MFC-L2862DW/MFC-L2922DW/MFC-L2960DW/
MFC-L2980DW

- [Use the Wireless Network](#)
- [Use Wi-Fi Direct®](#)
- [Enable/Disable Wireless LAN](#)
- [Print the WLAN Report](#)

Use the Wireless Network

Related Models: DCP-L2620DW/DCP-L2622DW/DCP-L2627DW/DCP-L2627DWXL/DCP-L2627DWE/DCP-L2660DW/DCP-L2665DW/MFC-L2800DW/MFC-L2802DW/MFC-L2827DWXL/MFC-L2827DW/MFC-L2835DW/MFC-L2860DWE/MFC-L2860DW/MFC-L2862DW/MFC-L2922DW/MFC-L2960DW/MFC-L2980DW

- [Before Configuring Your Machine for a Wireless Network](#)
- [Configure Your Machine for a Wireless Network Using the Setup Wizard from Your Computer](#)
- [Configure Your Machine for a Wireless Network Using the Machine's Control Panel Setup Wizard](#)
- [Configure Your Machine for a Wireless Network Using the One Push Method of Wi-Fi Protected Setup™ \(WPS\)](#)
- [Configure Your Machine for a Wireless Network Using the PIN Method of Wi-Fi Protected Setup™ \(WPS\)](#)
- [Configure Your Machine for a Wireless Network When the SSID Is Not Broadcast](#)
- [Configure Your Machine for an Enterprise Wireless Network](#)

Before Configuring Your Machine for a Wireless Network

Related Models: DCP-L2620DW/DCP-L2622DW/DCP-L2627DW/DCP-L2627DWXL/DCP-L2627DWE/DCP-L2660DW/DCP-L2665DW/MFC-L2800DW/MFC-L2802DW/MFC-L2827DWXL/MFC-L2827DW/MFC-L2835DW/MFC-L2860DWE/MFC-L2860DW/MFC-L2862DW/MFC-L2922DW/MFC-L2960DW/MFC-L2980DW

Before attempting to configure a wireless network, confirm the following:

- If you are using an enterprise wireless network, you must know the User ID and Password.
- To achieve optimum results with normal everyday document printing, place your machine as close to the wireless LAN access point/router as possible with minimal obstructions. Large objects and walls between the two devices and interference from other electronic devices can affect the data transfer speed of your documents.

Due to these factors, wireless may not be the best method of connection for all types of documents and applications. If you are printing large files, such as multi-page documents with mixed text and large graphics, you may want to consider selecting wired Ethernet for faster data transfer (supported models only), or USB for the fastest throughput speed.

- Although your machine can be used in a wired and wireless network (supported models only), only one connection method can be used at a time. However, a wireless network connection and Wi-Fi Direct connection, or a wired network connection (supported models only) and Wi-Fi Direct connection can be used at the same time.
- If there is a signal in the vicinity, wireless LAN allows you to freely make a LAN connection. However, if security settings are not correctly configured, the signal may be intercepted by malicious third-parties, possibly resulting in:
 - Theft of personal or confidential information
 - Improper transmission of information to parties impersonating the specified individuals
 - Dissemination of transcribed communication contents that were intercepted



Make sure you know your wireless router/access point's Network Name (SSID) and Network Key (Password). If you cannot find this information, consult the manufacturer of your wireless router/access point, your system administrator, or Internet provider. Brother cannot provide this information.



Related Information

- [Use the Wireless Network](#)

Configure Your Machine for a Wireless Network Using the Setup Wizard from Your Computer

Related Models: DCP-L2620DW/DCP-L2622DW/DCP-L2627DW/DCP-L2627DWXL/DCP-L2627DWE/DCP-L2660DW/DCP-L2665DW/MFC-L2800DW/MFC-L2802DW/MFC-L2827DWXL/MFC-L2827DW/MFC-L2835DW/MFC-L2860DWE/MFC-L2860DW/MFC-L2862DW/MFC-L2922DW/MFC-L2960DW/MFC-L2980DW

1. Download the installer from your model's **Downloads** page at support.brother.com/downloads.
2. Start the installer, and then follow the on-screen instructions.
3. Select **Wireless Network Connection (Wi-Fi)**, and then click **Next**.
4. Follow the on-screen instructions.

You have completed the wireless network setup.



Related Information

- [Use the Wireless Network](#)

Configure Your Machine for a Wireless Network Using the Machine's Control Panel Setup Wizard

Related Models: DCP-L2620DW/DCP-L2622DW/DCP-L2627DW/DCP-L2627DWXL/DCP-L2627DWE/
DCP-L2660DW/DCP-L2665DW/MFC-L2800DW/MFC-L2802DW/MFC-L2827DWXL/MFC-L2827DW/
MFC-L2835DW/MFC-L2860DWE/MFC-L2860DW/MFC-L2862DW/MFC-L2922DW/MFC-L2960DW/
MFC-L2980DW

>> [DCP-L2620DW/DCP-L2622DW/DCP-L2627DW/DCP-L2627DWXL/DCP-L2627DWE/MFC-L2800DW/
MFC-L2802DW/MFC-L2827DWXL/MFC-L2827DW/MFC-L2835DW](#)
>> [DCP-L2660DW/DCP-L2665DW/MFC-L2860DWE/MFC-L2860DW/MFC-L2862DW/MFC-L2922DW/
MFC-L2960DW/MFC-L2980DW](#)

**DCP-L2620DW/DCP-L2622DW/DCP-L2627DW/DCP-L2627DWXL/DCP-L2627DWE/
MFC-L2800DW/MFC-L2802DW/MFC-L2827DWXL/MFC-L2827DW/MFC-L2835DW**

Before configuring your machine, we recommend writing down your wireless network settings. You will need this information before you continue with the configuration.

1. Check and record the current wireless network settings of the computer to which you are connecting.

Network Name (SSID)

Network Key

For example:

Network Name (SSID)

HELLO

Network Key

12345



- Your access point/router may support the use of multiple WEP keys, but your Brother machine supports the use of only the first WEP key.
- If you need assistance during setup and want to contact Brother customer service, make sure you have your SSID (Network Name) and Network Key (Password) ready. We cannot assist you in locating this information.
- If you do not know this information (SSID and Network Key), you cannot continue the wireless setup.

How can I find this information?

- Check the documentation provided with your wireless access point/router.
- The initial SSID could be the manufacturer's name or the model name.
- If you do not know the security information, consult the router manufacturer, your system administrator, or your Internet provider.

2. Press **Menu**.
3. Press **▲** or **▼** to select the [Network] option, and then press **OK**.
4. Press **▲** or **▼** to select the [WLAN (Wi-Fi)] option, and then press **OK**.
5. Press **▲** or **▼** to select the [Find Network] option, and then press **OK**.

6. When [WLAN Enable?] appears, select On.

This will start the wireless setup wizard.

7. The machine will search for your network and display a list of available SSIDs. When a list of SSIDs appears, press ▲ or ▼ to select the SSID you want.

8. Press **OK**.

9. Do one of the following:

- If you are using an authentication and encryption method that requires a Network Key, enter the Network Key you wrote down in the first step.

When you have entered all the characters, press **OK**.

To apply the settings, select [Yes].

- If your authentication method is Open System and your encryption mode is None, go to the next step.

10. The machine attempts to connect to the wireless device you have selected.

If your wireless device is connected successfully, the machine's LCD displays [Connected].

You have completed the wireless network setup. To install the drivers and software necessary to use your machine, go to your model's **Downloads** page at support.brother.com/downloads.

DCP-L2660DW/DCP-L2665DW/MFC-L2860DWE/MFC-L2860DW/MFC-L2862DW/ MFC-L2922DW/MFC-L2960DW/MFC-L2980DW

Before configuring your machine, we recommend writing down your wireless network settings. You will need this information before you continue with the configuration.

1. Check and record the current wireless network settings of the computer to which you are connecting.

| Network Name (SSID) |
|---------------------|
| |

| Network Key |
|-------------|
| |

For example:

| Network Name (SSID) |
|---------------------|
| HELLO |

| Network Key |
|-------------|
| 12345 |

- 
- Your access point/router may support the use of multiple WEP keys, but your Brother machine supports the use of only the first WEP key.
 - If you need assistance during setup and want to contact Brother customer service, make sure you have your SSID (Network Name) and Network Key (Password) ready. We cannot assist you in locating this information.
 - If you do not know this information (SSID and Network Key), you cannot continue the wireless setup.

How can I find this information?

- Check the documentation provided with your wireless access point/router.
- The initial SSID could be the manufacturer's name or the model name.
- If you do not know the security information, consult the router manufacturer, your system administrator, or your Internet provider.

-
2. Press  [Settings] > [All Settings] > [Network] > [WLAN (Wi-Fi)] > [Find Wi-Fi Network].
 3. When [Switch Network interface to wireless?] appears, press [Yes].
This will start the wireless setup wizard. To cancel, press [No].
 4. The machine will search for your network and display a list of available SSIDs.
If a list of SSIDs is displayed, press ▲ or ▼ to display the SSID to which you want to connect, and then press the SSID.
 5. Press [OK].
 6. Do one of the following:
 - If you are using an authentication and encryption method that requires a Network Key, enter the Network Key you wrote down in the first step.
When you have entered all the characters, press [OK].
 - If your authentication method is Open System and your encryption mode is None, go to the next step.
 7. The machine attempts to connect to the wireless device you have selected.

If your wireless device is connected successfully, the machine's LCD displays [Connected].

You have completed the wireless network setup. To install the drivers and software necessary to use your machine, go to your model's **Downloads** page at support.brother.com/downloads.



Related Information

- [Use the Wireless Network](#)

Related Topics:

- [How to Enter Text on Your Machine](#)
 - [Wireless LAN Report Error Codes](#)
-

Configure Your Machine for a Wireless Network Using the One Push Method of Wi-Fi Protected Setup™ (WPS)

Related Models: DCP-L2620DW/DCP-L2622DW/DCP-L2627DW/DCP-L2627DWXL/DCP-L2627DWE/DCP-L2660DW/DCP-L2665DW/MFC-L2800DW/MFC-L2802DW/MFC-L2827DWXL/MFC-L2827DW/MFC-L2835DW/MFC-L2860DWE/MFC-L2860DW/MFC-L2862DW/MFC-L2922DW/MFC-L2960DW/MFC-L2980DW

If your wireless access point/router supports WPS (PBC: Push Button Configuration), you can use WPS from your machine's control panel menu to configure your wireless network settings.

>> [DCP-L2620DW/DCP-L2622DW/DCP-L2627DW/DCP-L2627DWXL/DCP-L2627DWE/MFC-L2800DW/MFC-L2802DW/MFC-L2827DWXL/MFC-L2827DW/MFC-L2835DW](#)
>> [DCP-L2660DW/DCP-L2665DW/MFC-L2860DWE/MFC-L2860DW/MFC-L2862DW/MFC-L2922DW/MFC-L2960DW/MFC-L2980DW](#)

DCP-L2620DW/DCP-L2622DW/DCP-L2627DW/DCP-L2627DWXL/DCP-L2627DWE/MFC-L2800DW/MFC-L2802DW/MFC-L2827DWXL/MFC-L2827DW/MFC-L2835DW

1. Press **Menu**.
2. Press **▲** or **▼** to select the [Network] option, and then press **OK**.
3. Press **▲** or **▼** to select the [WLAN (Wi-Fi)] option, and then press **OK**.
4. Press **▲** or **▼** to select the [WPS/PushButton] option, and then press **OK**.
5. When [WLAN Enable?] appears, select On.
This will start the wireless setup wizard.
6. When the LCD displays [Press Key on rtr], press the WPS button on your wireless access point/router. Then follow the LCD instructions on your machine. Your machine will automatically detect your wireless access point/router and try to connect to your wireless network.

If your wireless device is connected successfully, the machine's LCD displays [Connected].

You have completed the wireless network setup. To install the drivers and software necessary to use your machine, go to your model's **Downloads** page at support.brother.com/downloads.

DCP-L2660DW/DCP-L2665DW/MFC-L2860DWE/MFC-L2860DW/MFC-L2862DW/MFC-L2922DW/MFC-L2960DW/MFC-L2980DW

1. Press  [Settings] > [All Settings] > [Network] > [WLAN (Wi-Fi)] > [WPS/Push Button].
2. When [Switch Network interface to wireless?] appears, press [Yes].
This will start the wireless setup wizard. To cancel, press [No].
3. When the touchscreen displays [Start WPS on your wireless access point/router, then press [OK].], press the WPS button on your wireless access point/router. Then press [OK] on your machine. Your machine will automatically detect your wireless access point/router and try to connect to your wireless network.

If your wireless device is connected successfully, the machine's LCD displays [Connected].

You have completed the wireless network setup. To install the drivers and software necessary to use your machine, go to your model's **Downloads** page at support.brother.com/downloads.

Related Information

- [Use the Wireless Network](#)

Related Topics:

- [Wireless LAN Report Error Codes](#)
-

Configure Your Machine for a Wireless Network Using the PIN Method of Wi-Fi Protected Setup™ (WPS)

Related Models: DCP-L2620DW/DCP-L2622DW/DCP-L2627DW/DCP-L2627DWXL/DCP-L2627DWE/DCP-L2660DW/DCP-L2665DW/MFC-L2800DW/MFC-L2802DW/MFC-L2827DWXL/MFC-L2827DW/MFC-L2835DW/MFC-L2860DWE/MFC-L2860DW/MFC-L2862DW/MFC-L2922DW/MFC-L2960DW/MFC-L2980DW

If your wireless LAN access point/router supports WPS, you can use the Personal Identification Number (PIN) Method to configure your wireless network settings.

The PIN Method is one of the connection methods developed by the Wi-Fi Alliance®. By submitting a PIN created by an Enrollee (your machine) to the Registrar (a device that manages the wireless LAN), you can set up the wireless network and security settings. For more information on how to access WPS mode, see the instructions provided with your wireless access point/router.

Type A

Connection when the wireless LAN access point/router (1) doubles as the Registrar:

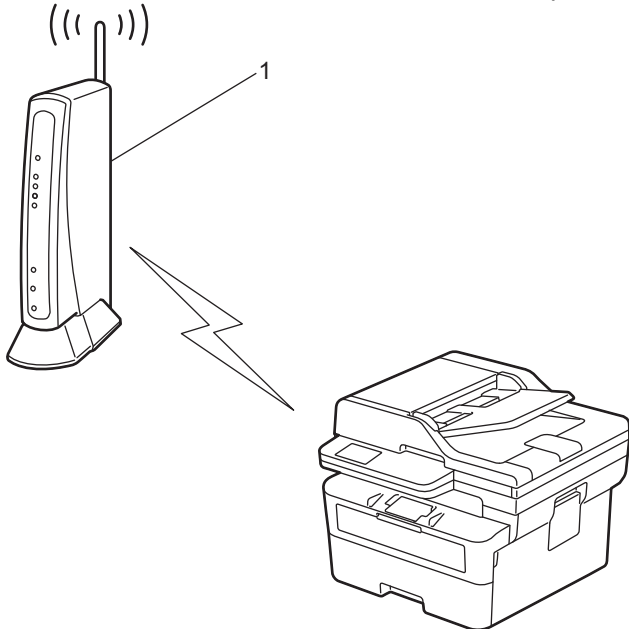

Type B

Connection when another device (2), such as a computer, is used as the Registrar:

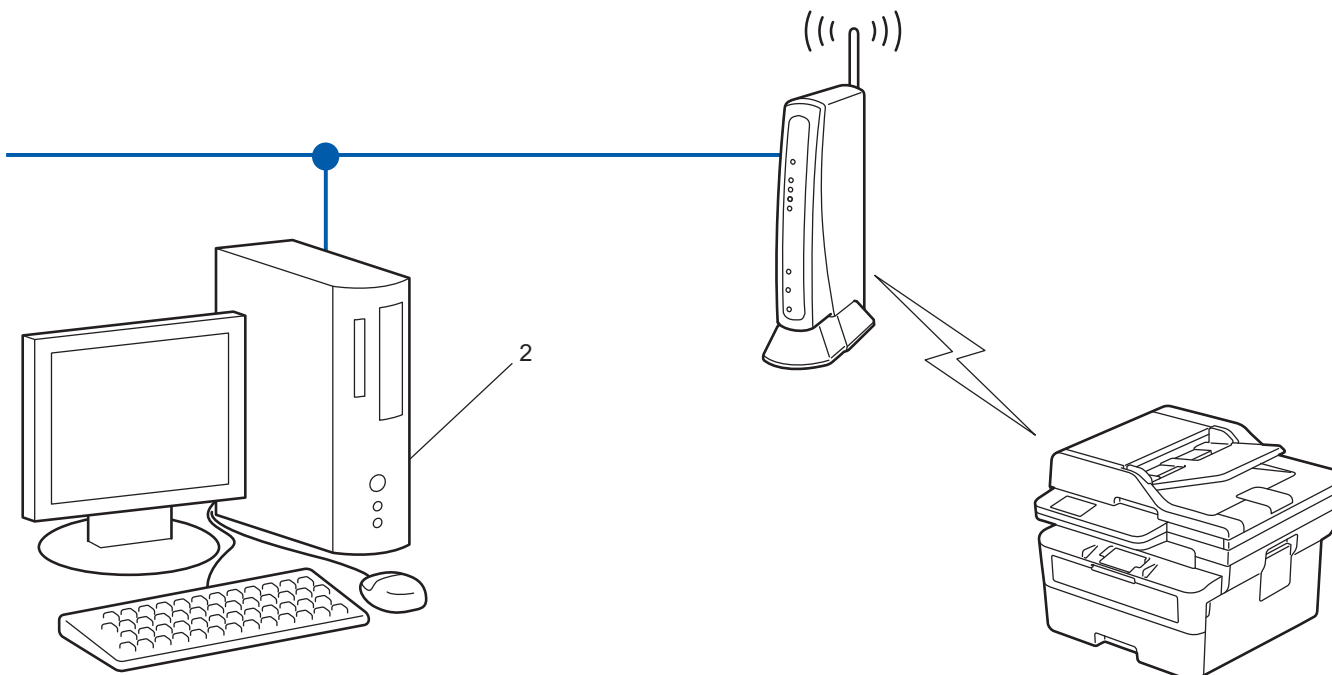

>> DCP-L2620DW/DCP-L2622DW/DCP-L2627DW/DCP-L2627DWXL/DCP-L2627DWE/MFC-L2800DW/
MFC-L2802DW/MFC-L2827DWXL/MFC-L2827DW/MFC-L2835DW
>> DCP-L2660DW/DCP-L2665DW/MFC-L2860DWE/MFC-L2860DW/MFC-L2862DW/MFC-L2922DW/
MFC-L2960DW/MFC-L2980DW

**DCP-L2620DW/DCP-L2622DW/DCP-L2627DW/DCP-L2627DWXL/DCP-L2627DWE/
MFC-L2800DW/MFC-L2802DW/MFC-L2827DWXL/MFC-L2827DW/MFC-L2835DW**

1. Press **Menu**.
2. Press **▲** or **▼** to select the [Network] option, and then press **OK**.
3. Press **▲** or **▼** to select the [WLAN (Wi-Fi)] option, and then press **OK**.
4. Press **▲** or **▼** to select the [WPS/PIN Code] option, and then press **OK**.
5. When [WLAN Enable?] appears, select On.
This will start the wireless setup wizard.
6. The LCD displays an eight-digit PIN and the machine starts searching for a wireless LAN access point/router.
7. Using a computer connected to the network, in your browser's address bar, type the IP address of the device you are using as the Registrar (for example: http://192.168.1.2).
8. Go to the WPS settings page and type the PIN, and then follow the on-screen instructions.



- The Registrar is usually the wireless LAN access point/router.
- The settings page may differ depending on the brand of wireless LAN access point/router. For more information, see the instructions supplied with your wireless LAN access point/router.

If you are using a Windows 10 or Windows 11 computer as a Registrar, complete the following steps:

9. Hold down the  key and press the  key on the computer's keyboard to launch **Run**.

10. Type "control printers" in the **Open:** field and click **OK**.

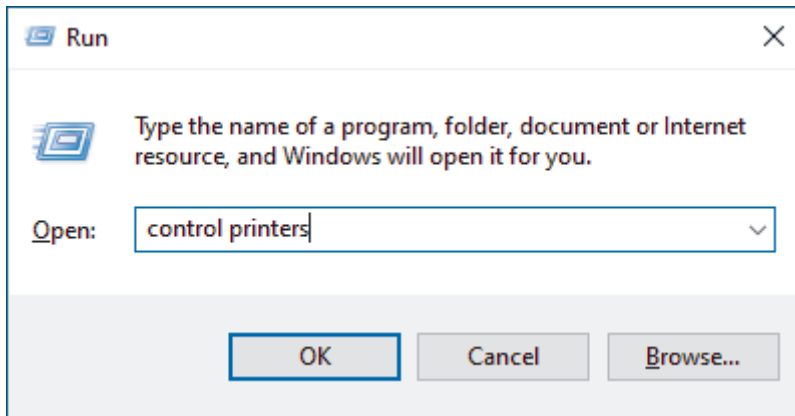

11. Click **Add a device**.



- To use a Windows 10 or Windows 11 computer as a Registrar, you must register it to your network in advance. For more information, see the instructions supplied with your wireless LAN access point/router.
- If you use Windows 10 or Windows 11 as a Registrar, you can install the printer driver after the wireless configuration by following the on-screen instructions. To install the driver and software necessary to use your machine, go to your model's **Downloads** page at support.brother.com/downloads.

12. Select your machine and click **Next**.

13. Type the PIN displayed on the machine's LCD, and then click **Next**.

14. Click **Close**.

If your wireless device is connected successfully, the machine's LCD displays [Connected].

You have completed the wireless network setup. To install the drivers and software necessary to use your machine, go to your model's **Downloads** page at support.brother.com/downloads.

DCP-L2660DW/DCP-L2665DW/MFC-L2860DWE/MFC-L2860DW/MFC-L2862DW/ MFC-L2922DW/MFC-L2960DW/MFC-L2980DW

1. Press  [Settings] > [All Settings] > [Network] > [WLAN (Wi-Fi)] > [WPS/PIN Code].
2. When [Switch Network interface to wireless?] appears, press [Yes].
This will start the wireless setup wizard. To cancel, press [No].
3. The LCD displays an eight-digit PIN and the machine starts searching for a wireless LAN access point/router.
4. Using a computer connected to the network, in your browser's address bar, type the IP address of the device you are using as the Registrar (for example: <http://192.168.1.2>).
5. Go to the WPS settings page and type the PIN, and then follow the on-screen instructions.



- The Registrar is usually the wireless LAN access point/router.
- The settings page may differ depending on the brand of wireless LAN access point/router. For more information, see the instructions supplied with your wireless LAN access point/router.

If you are using a Windows 10 or Windows 11 computer as a Registrar, complete the following steps:

6. Hold down the  key and press the  key on the computer's keyboard to launch **Run**.

7. Type "control printers" in the **Open:** field and click **OK**.

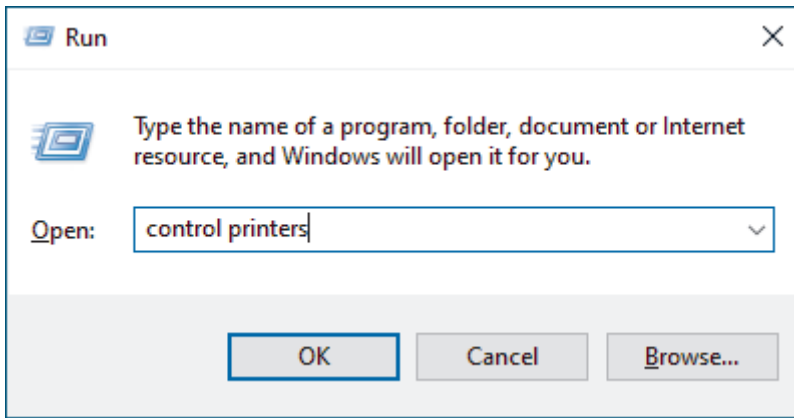

8. Click **Add a device**.



- To use a Windows 10 or Windows 11 computer as a Registrar, you must register it to your network in advance. For more information, see the instructions supplied with your wireless LAN access point/router.
- If you use Windows 10 or Windows 11 as a Registrar, you can install the printer driver after the wireless configuration by following the on-screen instructions. To install the driver and software necessary to use your machine, go to your model's **Downloads** page at support.brother.com/downloads.

9. Select your machine and click **Next**.

10. Type the PIN displayed on the machine's LCD, and then click **Next**.

11. Click **Close**.

If your wireless device is connected successfully, the machine's LCD displays [Connected].

You have completed the wireless network setup. To install the drivers and software necessary to use your machine, go to your model's **Downloads** page at support.brother.com/downloads.



Related Information

- [Use the Wireless Network](#)

Related Topics:

- [Wireless LAN Report Error Codes](#)

Configure Your Machine for a Wireless Network When the SSID Is Not Broadcast

Related Models: DCP-L2620DW/DCP-L2622DW/DCP-L2627DW/DCP-L2627DWXL/DCP-L2627DWE/
DCP-L2660DW/DCP-L2665DW/MFC-L2800DW/MFC-L2802DW/MFC-L2827DWXL/MFC-L2827DW/
MFC-L2835DW/MFC-L2860DWE/MFC-L2860DW/MFC-L2862DW/MFC-L2922DW/MFC-L2960DW/
MFC-L2980DW

>> [DCP-L2620DW/DCP-L2622DW/DCP-L2627DW/DCP-L2627DWXL/DCP-L2627DWE/MFC-L2800DW/
MFC-L2802DW/MFC-L2827DWXL/MFC-L2827DW/MFC-L2835DW](#)
>> [DCP-L2660DW/DCP-L2665DW/MFC-L2860DWE/MFC-L2860DW/MFC-L2862DW/MFC-L2922DW/
MFC-L2960DW/MFC-L2980DW](#)

**DCP-L2620DW/DCP-L2622DW/DCP-L2627DW/DCP-L2627DWXL/DCP-L2627DWE/
MFC-L2800DW/MFC-L2802DW/MFC-L2827DWXL/MFC-L2827DW/MFC-L2835DW**

Before configuring your machine, we recommend writing down your wireless network settings. You will need this information before you continue with the configuration.

1. Check and write down the current wireless network settings.

| Network Name (SSID) | | |
|---------------------|--|--|
| | | |

| Authentication Method | Encryption Mode | Network Key |
|-----------------------|-----------------|-------------|
| Open System | NONE | - |
| | WEP | |
| Shared Key | WEP | |
| WPA/WPA2-PSK | AES | |
| | TKIP | |
| WPA3-SAE | AES | |

For example:

| Network Name (SSID) | | |
|---------------------|--|--|
| HELLO | | |

| Authentication Method | Encryption Mode | Network Key |
|-----------------------|-----------------|-------------|
| WPA2-PSK | AES | 12345678 |



If your router uses WEP encryption, enter the key used as the first WEP key. Your Brother machine supports the use of the first WEP key only.

2. Press **Menu**.
3. Press **▲** or **▼** to select the [Network] option, and then press **OK**.
4. Press **▲** or **▼** to select the [WLAN (Wi-Fi)] option, and then press **OK**.
5. Press **▲** or **▼** to select the [Find Network] option, and then press **OK**.
6. When [WLAN Enable?] appears, select On.

This will start the wireless setup wizard.

7. The machine will search for your network and display a list of available SSIDs. Press ▲ or ▼ to select the [<New SSID>] option, and then press **OK**.
8. Enter the SSID name, and then press **OK**.
9. Press ▲ or ▼ to select the Authentication Method you want, and then press **OK**.
10. Do one of the following:
 - If you selected the [Open System] option, press ▲ or ▼ to select the Encryption Type [None] or [WEP], and then press **OK**.
If you selected the [WEP] option for Encryption Type, enter the WEP key, and then press **OK**.
 - If you selected the [Shared Key] option, enter the WEP key, and then press **OK**.
 - If you selected the [WPA-Personal] option, press ▲ or ▼ to select the Encryption Type [TKIP+AES] or [AES], and then press **OK**.
Enter the WPA™ key, and then press **OK**.
 - If you selected the [WPA3-SAE] option, select the Encryption Type [AES], and then press **OK**.
Enter the WPA™ key, and then press **OK**.



Your Brother machine supports the use of the first WEP key only.

11. To apply the settings, select [Yes]. To cancel, select [No].
12. The machine attempts to connect to the wireless device you have selected.

If your wireless device is connected successfully, the machine's LCD displays [Connected].

You have completed the wireless network setup. To install the drivers and software necessary to use your machine, go to your model's **Downloads** page at support.brother.com/downloads.

DCP-L2660DW/DCP-L2665DW/MFC-L2860DWE/MFC-L2860DW/MFC-L2862DW/ MFC-L2922DW/MFC-L2960DW/MFC-L2980DW

Before configuring your machine, we recommend writing down your wireless network settings. You will need this information before you continue with the configuration.

1. Check and write down the current wireless network settings.

| Network Name (SSID) | | |
|-----------------------|-----------------|-------------|
| | | |
| Authentication Method | Encryption Mode | Network Key |
| Open System | NONE | - |
| | WEP | |
| Shared Key | WEP | |
| WPA/WPA2-PSK | AES | |
| | TKIP | |
| WPA3-SAE | AES | |

For example:

| Network Name (SSID) | | |
|-----------------------|-----------------|-------------|
| HELLO | | |
| Authentication Method | Encryption Mode | Network Key |
| WPA2-PSK | AES | 12345678 |



If your router uses WEP encryption, enter the key used as the first WEP key. Your Brother machine supports the use of the first WEP key only.

2. Press  [Settings] > [All Settings] > [Network] > [WLAN (Wi-Fi)] > [Find Wi-Fi Network].
3. When [Switch Network interface to wireless?] appears, press [Yes].
This will start the wireless setup wizard. To cancel, press [No].
4. The machine will search for your network and display a list of available SSIDs. Press ▲ or ▼ to display [<New SSID>]. Press [<New SSID>], and then press [OK].
5. Enter the SSID name, and then press [OK].
6. Select the Authentication Method.
7. Do one of the following:
 - If you selected the [Open System] option, press [None] or [WEP].
If you selected the [WEP] option for Encryption type, enter the WEP key, and then press [OK].
 - If you selected the [Shared Key] option, enter the WEP key, and then press [OK].
 - If you selected the [WPA/WPA2-PSK/WPA3-SAE] option, press [TKIP+AES] or [AES].
Enter the WPA™ key, and then press [OK].
 - If you selected the [WPA3-SAE] option, press [AES].
Enter the WPA™ key, and then press [OK].



Your Brother machine supports the use of the first WEP key only.

8. The machine attempts to connect to the wireless device you have selected.

If your wireless device is connected successfully, the machine's LCD displays [Connected].

You have completed the wireless network setup. To install the drivers and software necessary to use your machine, go to your model's **Downloads** page at support.brother.com/downloads.



Related Information

- [Use the Wireless Network](#)

Related Topics:

- [I Cannot Complete the Wireless Network Setup Configuration](#)
 - [How to Enter Text on Your Machine](#)
 - [Wireless LAN Report Error Codes](#)
-

Configure Your Machine for an Enterprise Wireless Network

Related Models: DCP-L2620DW/DCP-L2622DW/DCP-L2627DW/DCP-L2627DWXL/DCP-L2627DWE/DCP-L2660DW/DCP-L2665DW/MFC-L2800DW/MFC-L2802DW/MFC-L2827DWXL/MFC-L2827DW/MFC-L2835DW/MFC-L2860DWE/MFC-L2860DW/MFC-L2862DW/MFC-L2922DW/MFC-L2960DW/MFC-L2980DW

>> DCP-L2620DW/DCP-L2622DW/DCP-L2627DW/DCP-L2627DWXL/DCP-L2627DWE/MFC-L2800DW/MFC-L2802DW/MFC-L2827DWXL/MFC-L2827DW/MFC-L2835DW
 >> DCP-L2660DW/DCP-L2665DW/MFC-L2860DWE/MFC-L2860DW/MFC-L2862DW/MFC-L2922DW/MFC-L2960DW/MFC-L2980DW

DCP-L2620DW/DCP-L2622DW/DCP-L2627DW/DCP-L2627DWXL/DCP-L2627DWE/MFC-L2800DW/MFC-L2802DW/MFC-L2827DWXL/MFC-L2827DW/MFC-L2835DW

Before configuring your machine, we recommend writing down your wireless network settings. You will need this information before you continue with the configuration.

1. Check and record the current wireless network settings.

| Network Name (SSID) |
|---------------------|
| |

| Authentication Method | Encryption Mode | User ID | Password |
|-----------------------|-----------------|---------|----------|
| EAP-FAST/NONE | AES | | |
| | TKIP | | |
| EAP-FAST/MS-CHAPv2 | AES | | |
| | TKIP | | |
| EAP-FAST/GTC | AES | | |
| | TKIP | | |
| PEAP/MS-CHAPv2 | AES | | |
| | TKIP | | |
| PEAP/GTC | AES | | |
| | TKIP | | |
| EAP-TTLS/CHAP | AES | | |
| | TKIP | | |
| EAP-TTLS/MS-CHAP | AES | | |
| | TKIP | | |
| EAP-TTLS/MS-CHAPv2 | AES | | |
| | TKIP | | |
| EAP-TTLS/PAP | AES | | |
| | TKIP | | |
| EAP-TLS | AES | | - |
| | TKIP | | - |

For example:

| Network Name (SSID) | | | |
|---------------------|--|--|--|
| HELLO | | | |

| Authentication Method | Encryption Mode | User ID | Password |
|-----------------------|-----------------|---------|----------|
| EAP-FAST/MS-CHAPv2 | AES | Brother | 12345678 |



- If you configure your machine using EAP-TLS authentication, you must install the client certificate issued by a CA before you start configuration. Contact your network administrator about the client certificate. If you have installed more than one certificate, we recommend writing down the certificate name you want to use.
- If you verify your machine using the common name of the server certificate, we recommend writing down the common name before you start configuration. Contact your network administrator about the common name of the server certificate.

2. Press **Menu**.
3. Press **▲** or **▼** to select the following:
 - a. Select [Network]. Press **OK**.
 - b. Select [WLAN (Wi-Fi)]. Press **OK**.
 - c. Select [Find Network]. Press **OK**.
4. When [WLAN Enable?] appears, select On.
This will start the wireless setup wizard.
5. The machine will search for your network and display a list of available SSIDs. Press **▲** or **▼** to select the [<New SSID>] option, and then press **OK**.
6. Enter the SSID name, and then press **OK**.
7. Press **▲** or **▼** to select the Authentication Method you want, and then press **OK**.
8. Do one of the following:
 - If you selected the [EAP-FAST], [PEAP] or [EAP-TTLS] option, press **▲** or **▼** to select the Inner Authentication Method [NONE], [CHAP], [MS-CHAP], [MS-CHAPv2], [GTC] or [PAP], and then press **OK**.



Depending on your Authentication Method, the Inner Authentication Method selections differ.

Press **▲** or **▼** to select the Encryption Type [TKIP+AES] or [AES], and then press **OK**.

Press **▲** or **▼** to select the Verification Method [No Verification], [CA] or [CA+Server ID], and then press **OK**.

- If you selected the [CA+Server ID] option, enter the server ID, user ID and password (if required), and then press **OK** for each option.
- For other selections, enter the user ID and the Password (if required), and then press **OK** for each option.



If you have not imported a CA certificate into your machine, the machine will display the message [No Verification].

- If you selected the [EAP-TLS] option, press **▲** or **▼** to select the Encryption Type [TKIP+AES] or [AES], and then press **OK**.
When the machine displays a list of available Client Certificates, select the certificate you want, and then press **OK**.
Press **▲** or **▼** to select the Verification Method [No Verification], [CA] or [CA+Server ID], and then press **OK**.
 - If you selected the [CA+Server ID] option, enter the server ID and user ID, and then press **OK** for each option.
 - For other selections, enter the user ID, and then press **OK**.
9. To apply the settings, select [Yes]. To cancel, select [No].

10. The machine will attempt to connect to the wireless device you have selected.

If your wireless device is connected successfully, the machine's LCD displays [Connected].

You have completed the wireless network setup. To install the drivers or the application necessary for operating your machine, go to your model's **Downloads** page at support.brother.com/downloads.

**DCP-L2660DW/DCP-L2665DW/MFC-L2860DWE/MFC-L2860DW/MFC-L2862DW/
MFC-L2922DW/MFC-L2960DW/MFC-L2980DW**

Before configuring your machine, we recommend writing down your wireless network settings. You will need this information before you continue with the configuration.

1. Check and record the current wireless network settings.

| Network Name (SSID) | | | |
|-----------------------|-----------------|---------|----------|
| | | | |
| Authentication Method | Encryption Mode | User ID | Password |
| EAP-FAST/NONE | AES | | |
| | TKIP | | |
| EAP-FAST/MS-CHAPv2 | AES | | |
| | TKIP | | |
| EAP-FAST/GTC | AES | | |
| | TKIP | | |
| PEAP/MS-CHAPv2 | AES | | |
| | TKIP | | |
| PEAP/GTC | AES | | |
| | TKIP | | |
| EAP-TTLS/CHAP | AES | | |
| | TKIP | | |
| EAP-TTLS/MS-CHAP | AES | | |
| | TKIP | | |
| EAP-TTLS/MS-CHAPv2 | AES | | |
| | TKIP | | |
| EAP-TTLS/PAP | AES | | |
| | TKIP | | |
| EAP-TLS | AES | | - |
| | TKIP | | - |

For example:

| Network Name (SSID) | | | |
|-----------------------|-----------------|---------|----------|
| HELLO | | | |
| Authentication Method | Encryption Mode | User ID | Password |
| EAP-FAST/MS-CHAPv2 | AES | Brother | 12345678 |



- If you configure your machine using EAP-TLS authentication, you must install the client certificate issued by a CA before you start configuration. Contact your network administrator about the client certificate. If you have installed more than one certificate, we recommend writing down the certificate name you want to use.
- If you verify your machine using the common name of the server certificate, we recommend writing down the common name before you start configuration. Contact your network administrator about the common name of the server certificate.

2. Press  [Settings] > [All Settings] > [Network] > [WLAN (Wi-Fi)] > [Find Wi-Fi Network].
3. When [Switch Network interface to wireless?] appears, press [Yes].
This will start the wireless setup wizard. To cancel, press [No].
4. The machine will search for your network and display a list of available SSIDs. Press ▲ or ▼ to display [<New SSID>]. Press [<New SSID>], and then press [OK].
5. Enter the SSID name, and then press [OK].
6. Select the Authentication Method.
7. Do one of the following:
 - If you selected the [EAP-FAST], [PEAP] or [EAP-TTLS] option, select the Inner Authentication method [None], [CHAP], [MS-CHAP], [MS-CHAPv2], [GTC] or [PAP].



Depending on your Authentication method, the Inner Authentication method selections may differ.

Select the encryption type [TKIP+AES] or [AES].

Select the verification method [No Verification], [CA] or [CA + Server ID].

- If you selected the [CA + Server ID] option, enter the server ID, user ID, and password (if required), and then press [OK] for each option.
- For other selections, enter the user ID and Password (if required), and then press [OK] for each option.



If you have not imported a CA certificate into your machine, the machine displays [No Verification].

- If you selected the [EAP-TLS] option, select the encryption type [TKIP+AES] or [AES].
The machine will display a list of available Client Certificates, and then select the certificate.
Select the verification method [No Verification], [CA] or [CA + Server ID].
 - If you selected the [CA + Server ID] option, enter the server ID and user ID, and then press [OK] for each option.
 - For other selections, enter the user ID, and then press [OK].

8. The machine attempts to connect to the wireless device you have selected.

If your wireless device is connected successfully, the machine's LCD displays [Connected].

You have completed the wireless network setup. To install the drivers or the application necessary for operating your machine, go to your model's **Downloads** page at support.brother.com/downloads.



Related Information

- [Use the Wireless Network](#)

Related Topics:

- [Wireless LAN Report Error Codes](#)

Use Wi-Fi Direct®

Related Models: DCP-L2620DW/DCP-L2622DW/DCP-L2627DW/DCP-L2627DWXL/DCP-L2627DWE/
DCP-L2660DW/DCP-L2665DW/MFC-L2800DW/MFC-L2802DW/MFC-L2827DWXL/MFC-L2827DW/
MFC-L2835DW/MFC-L2860DWE/MFC-L2860DW/MFC-L2862DW/MFC-L2922DW/MFC-L2960DW/
MFC-L2980DW

- [Wi-Fi Direct Overview](#)
- [Configure Your Wi-Fi Direct Network Manually](#)
- [Configure Wi-Fi Direct Network Using the Push Button Method](#)

Wi-Fi Direct Overview

Related Models: DCP-L2620DW/DCP-L2622DW/DCP-L2627DW/DCP-L2627DWXL/DCP-L2627DWE/DCP-L2660DW/DCP-L2665DW/MFC-L2800DW/MFC-L2802DW/MFC-L2827DWXL/MFC-L2827DW/MFC-L2835DW/MFC-L2860DWE/MFC-L2860DW/MFC-L2862DW/MFC-L2922DW/MFC-L2960DW/MFC-L2980DW

Wi-Fi Direct is one of the wireless configuration methods developed by the Wi-Fi Alliance®. It allows you to securely connect your mobile device to your machine without using a wireless router/access point.

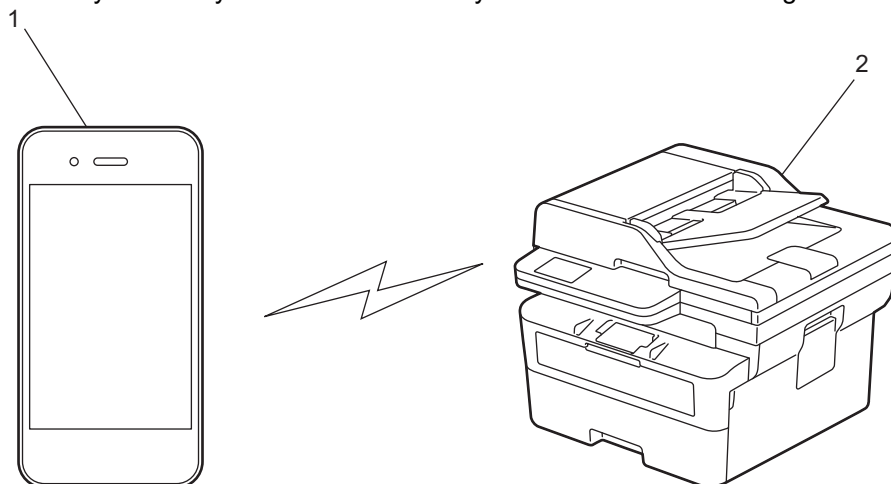

1. Mobile device
2. Your machine



- You can use Wi-Fi Direct with the wired or wireless network connection at the same time.
- The Wi-Fi Direct-supported device can become a Group Owner. When configuring the Wi-Fi Direct network, the Group Owner serves as an access point.



Related Information

- [Use Wi-Fi Direct®](#)

Related Topics:

- [Configure Your Wi-Fi Direct Network Manually](#)
- [Configure Wi-Fi Direct Network Using the Push Button Method](#)

Configure Your Wi-Fi Direct Network Manually

Related Models: DCP-L2620DW/DCP-L2622DW/DCP-L2627DW/DCP-L2627DWXL/DCP-L2627DWE/
DCP-L2660DW/DCP-L2665DW/MFC-L2800DW/MFC-L2802DW/MFC-L2827DWXL/MFC-L2827DW/
MFC-L2835DW/MFC-L2860DWE/MFC-L2860DW/MFC-L2862DW/MFC-L2922DW/MFC-L2960DW/
MFC-L2980DW

>> DCP-L2620DW/DCP-L2622DW/DCP-L2627DW/DCP-L2627DWXL/DCP-L2627DWE/MFC-L2800DW/
MFC-L2802DW/MFC-L2827DWXL/MFC-L2827DW/MFC-L2835DW
>> DCP-L2660DW/DCP-L2665DW/MFC-L2860DWE/MFC-L2860DW/MFC-L2862DW/MFC-L2922DW/
MFC-L2960DW/MFC-L2980DW

DCP-L2620DW/DCP-L2622DW/DCP-L2627DW/DCP-L2627DWXL/DCP-L2627DWE/ MFC-L2800DW/MFC-L2802DW/MFC-L2827DWXL/MFC-L2827DW/MFC-L2835DW

If your mobile device does not support Wi-Fi Direct or WPS, you must configure a Wi-Fi Direct network manually.



When the machine receives a Wi-Fi Direct request from your mobile device, the message [Connect?] appears on the LCD. Select OK to connect.

1. Press **Menu**.
2. Press **▲** or **▼** to select the [Network] option, and then press **OK**.
3. Press **▲** or **▼** to select the [Wi-Fi Direct] option, and then press **OK**.
4. Press **▲** or **▼** to select the [Manual] option, and then press **OK**.
5. When [Wi-Fi Direct On?] appears, select On.
6. The machine will display the SSID name and Password. Go to your mobile device's wireless network settings screen, select the SSID name, and then enter the password.
7. If your mobile device connects successfully, the machine's LCD displays [Connected]. You have completed the Wi-Fi Direct network setup.

DCP-L2660DW/DCP-L2665DW/MFC-L2860DWE/MFC-L2860DW/MFC-L2862DW/ MFC-L2922DW/MFC-L2960DW/MFC-L2980DW

If your mobile device does not support Wi-Fi Direct or WPS, you must configure a Wi-Fi Direct network manually.



When the machine receives the Wi-Fi Direct request from your mobile device, the message [Wi-Fi Direct connection request received.Press [OK] to connect.] will appear on the LCD. Press [OK] to connect.

1. Press  [Settings] > [All Settings] > [Network] > [Wi-Fi Direct] > [Manual].
2. The machine will display the SSID name and Password for two minutes. Go to your mobile device's wireless network settings screen, select the SSID name, and then enter the password.
3. If your mobile device connects successfully, the machine's LCD displays [Connected]. You have completed the Wi-Fi Direct network setup.

✓ Related Information

- [Use Wi-Fi Direct®](#)

Related Topics:

- [Wi-Fi Direct Overview](#)

-
- Configure Wi-Fi Direct Network Using the Push Button Method
-

Configure Wi-Fi Direct Network Using the Push Button Method

Related Models: DCP-L2620DW/DCP-L2622DW/DCP-L2627DW/DCP-L2627DWXL/DCP-L2627DWE/
DCP-L2660DW/DCP-L2665DW/MFC-L2800DW/MFC-L2802DW/MFC-L2827DWXL/MFC-L2827DW/
MFC-L2835DW/MFC-L2860DWE/MFC-L2860DW/MFC-L2862DW/MFC-L2922DW/MFC-L2960DW/
MFC-L2980DW

>> DCP-L2620DW/DCP-L2622DW/DCP-L2627DW/DCP-L2627DWXL/DCP-L2627DWE/MFC-L2800DW/
MFC-L2802DW/MFC-L2827DWXL/MFC-L2827DW/MFC-L2835DW
>> DCP-L2660DW/DCP-L2665DW/MFC-L2860DWE/MFC-L2860DW/MFC-L2862DW/MFC-L2922DW/
MFC-L2960DW/MFC-L2980DW

DCP-L2620DW/DCP-L2622DW/DCP-L2627DW/DCP-L2627DWXL/DCP-L2627DWE/ MFC-L2800DW/MFC-L2802DW/MFC-L2827DWXL/MFC-L2827DW/MFC-L2835DW

If your mobile device supports Wi-Fi Direct, follow these steps to configure a Wi-Fi Direct network:



1. Press **Menu**.
2. Press **▲** or **▼** to select the [Network] option, and then press **OK**.
3. Press **▲** or **▼** to select the [Wi-Fi Direct] option, and then press **OK**.
4. Press **▲** or **▼** to select the [Push Button] option, and then press **OK**.
5. When [Wi-Fi Direct On?] appears, select On.
6. Activate Wi-Fi Direct on your mobile device (see your mobile device's user's guide for instructions) when [Activate Wi-Fi Direct on other device and press OK.] appears on the machine's LCD. Press **OK** on your machine.
This will start the Wi-Fi Direct setup.
7. Do one of the following:
 - If your mobile device displays a list of machines with Wi-Fi Direct enabled, select your Brother machine.
 - If your Brother machine displays a list of mobile devices with Wi-Fi Direct enabled, select your mobile device. Press **▲** or **▼** to select the mobile device you want to connect to and press **OK**. To search for available devices again, select [<Rescan>], and then press **OK**.
8. If your mobile device connects successfully, the machine's LCD displays [Connected]. You have completed the Wi-Fi Direct network setup.

DCP-L2660DW/DCP-L2665DW/MFC-L2860DWE/MFC-L2860DW/MFC-L2862DW/ MFC-L2922DW/MFC-L2960DW/MFC-L2980DW

If your mobile device supports Wi-Fi Direct, follow these steps to configure a Wi-Fi Direct network:



When the machine receives the Wi-Fi Direct request from your mobile device, the message [Wi-Fi Direct connection request received.Press [OK] to connect.] will appear on the LCD. Press [OK] to connect.

1. Press  [Settings] > [All Settings] > [Network] > [Wi-Fi Direct] > [Push Button].
2. Activate Wi-Fi Direct on your mobile device (see your mobile device's user's guide for instructions) when [Activate Wi-Fi Direct on other device. Then Press [OK].] appears on the machine's LCD. Press [OK] on your machine.
This will start the Wi-Fi Direct setup. To cancel, press .
3. Do one of the following:
 - If your mobile device displays a list of machines with Wi-Fi Direct enabled, select your Brother machine.

-
- If your Brother machine displays a list of mobile devices with Wi-Fi Direct enabled, select your mobile device. Select the mobile device you want to connect to. Search for available devices again by pressing [Rescan].
4. If your mobile device connects successfully, the machine's LCD displays [Connected]. You have completed the Wi-Fi Direct network setup.



Related Information

- [Use Wi-Fi Direct®](#)

Related Topics:

- [Wi-Fi Direct Overview](#)
 - [Configure Your Wi-Fi Direct Network Manually](#)
-

Enable/Disable Wireless LAN



Related Models: DCP-L2620DW/DCP-L2622DW/DCP-L2627DW/DCP-L2627DWXL/DCP-L2627DWE/
DCP-L2660DW/DCP-L2665DW/MFC-L2800DW/MFC-L2802DW/MFC-L2827DWXL/MFC-L2827DW/
MFC-L2835DW/MFC-L2860DWE/MFC-L2860DW/MFC-L2862DW/MFC-L2922DW/MFC-L2960DW/
MFC-L2980DW

>> DCP-L2620DW/DCP-L2622DW/DCP-L2627DW/DCP-L2627DWXL/DCP-L2627DWE/MFC-L2800DW/
MFC-L2802DW/MFC-L2827DWXL/MFC-L2827DW/MFC-L2835DW
>> DCP-L2660DW/DCP-L2665DW/MFC-L2860DWE/MFC-L2860DW/MFC-L2862DW/MFC-L2922DW/
MFC-L2960DW/MFC-L2980DW

**DCP-L2620DW/DCP-L2622DW/DCP-L2627DW/DCP-L2627DWXL/DCP-L2627DWE/
MFC-L2800DW/MFC-L2802DW/MFC-L2827DWXL/MFC-L2827DW/MFC-L2835DW**

1. Press **Menu**.
2. Press **▲** or **▼** to select the [Network] option, and then press **OK**.
3. Press **▲** or **▼** to select the [WLAN (Wi-Fi)] option, and then press **OK**.
4. Press **▲** or **▼** to select the [WLAN Enable] option, and then press **OK**.
5. Do one of the following:
 - To enable Wi-Fi, select [On].
 - To disable Wi-Fi, select [Off].
6. Press **OK**.

**DCP-L2660DW/DCP-L2665DW/MFC-L2860DWE/MFC-L2860DW/MFC-L2862DW/
MFC-L2922DW/MFC-L2960DW/MFC-L2980DW**

1. Press  [Settings] > [All Settings] > [Network] > [WLAN (Wi-Fi)].
2. Press **▲** or **▼** to select the [WLAN Enable] option. Press [WLAN Enable].
3. Do one of the following:
 - To enable Wi-Fi, select [On].
 - To disable Wi-Fi, select [Off].
4. Press .

Related Information

- [Wireless Network Settings](#)

Print the WLAN Report

Related Models: DCP-L2620DW/DCP-L2622DW/DCP-L2627DW/DCP-L2627DWXL/DCP-L2627DWE/
DCP-L2660DW/DCP-L2665DW/MFC-L2800DW/MFC-L2802DW/MFC-L2827DWXL/MFC-L2827DW/
MFC-L2835DW/MFC-L2860DWE/MFC-L2860DW/MFC-L2862DW/MFC-L2922DW/MFC-L2960DW/
MFC-L2980DW

The WLAN Report shows your machine's wireless status. If the wireless connection fails, check the error code on the printed report.

>> DCP-L2620DW/DCP-L2622DW/DCP-L2627DW/DCP-L2627DWXL/DCP-L2627DWE/MFC-L2800DW/
MFC-L2802DW/MFC-L2827DWXL/MFC-L2827DW/MFC-L2835DW
>> DCP-L2660DW/DCP-L2665DW/MFC-L2860DWE/MFC-L2860DW/MFC-L2862DW/MFC-L2922DW/
MFC-L2960DW/MFC-L2980DW

**DCP-L2620DW/DCP-L2622DW/DCP-L2627DW/DCP-L2627DWXL/DCP-L2627DWE/
MFC-L2800DW/MFC-L2802DW/MFC-L2827DWXL/MFC-L2827DW/MFC-L2835DW**

1. Press **Menu**.
2. Press **▲** or **▼** to display the [Print Reports] option, and then press **OK**.
3. Press **▲** or **▼** to select the [WLAN Report] option, and then press **OK**.
4. Press **Start**.

The machine will print the WLAN Report.

**DCP-L2660DW/DCP-L2665DW/MFC-L2860DWE/MFC-L2860DW/MFC-L2862DW/
MFC-L2922DW/MFC-L2960DW/MFC-L2980DW**

1. Press  [Settings] > [All Settings] > [Print Reports] > [WLAN Report].
2. Press [Yes].

The machine will print the WLAN Report.

If the WLAN Report does not print, check your machine for errors. If there are no visible errors, wait for one minute and then try to print the report again.

Related Information

- [Wireless Network Settings](#)
 - [Wireless LAN Report Error Codes](#)

Related Topics:

- [My Machine Cannot Print, Scan, or Use the PC-FAX Receive Function over the Network](#)
- [I Want to Check that My Network Devices are Working Correctly](#)

Wireless LAN Report Error Codes

Related Models: DCP-L2620DW/DCP-L2622DW/DCP-L2627DW/DCP-L2627DWXL/DCP-L2627DWE/DCP-L2660DW/DCP-L2665DW/MFC-L2800DW/MFC-L2802DW/MFC-L2827DWXL/MFC-L2827DW/MFC-L2835DW/MFC-L2860DWE/MFC-L2860DW/MFC-L2862DW/MFC-L2922DW/MFC-L2960DW/MFC-L2980DW

If the Wireless LAN Report shows that the connection failed, check the error code on the printed report and see the corresponding instructions in the table:

| Error Code | Problem and Recommended Solutions |
|------------|-----------------------------------------------------------------------------------------------------------------------------------------------------------------------------------------------------------------------------------------------------------------------------------------------------------------------------------------------------------------------------------------------------------------------------------------------------------------------------------------------------------------------------------------------------------------------------------------------------------------------------------------------------------------------------------------------------------------------------------------------------------------------------------------------------------------------------------------------------------------------------------------------------------------------------------------------------------------------------------------------------------------------------------------------------------------------------------------------------------------------------------------------------------------------------------|
| TS-01 | <p>The WLAN (Wi-Fi) is not enabled.</p> <p>Check the following points and try to set up your wireless connection again:</p> <ul style="list-style-type: none">• Enable the WLAN setting on your machine.• If a network cable is connected to your machine, disconnect it. |
| TS-02 | <p>The wireless router/access point cannot be detected.</p> <p>Check the following points and try to set up your wireless connection again:</p> <ul style="list-style-type: none">• Make sure the wireless router/access point is on.• Temporarily place your machine closer to the wireless router/access point when you are configuring the wireless settings.• If your wireless router/access point is using MAC address filtering, confirm that the MAC address of the machine is allowed in the filter. You can find the MAC address by printing the Network Configuration Report.• If you manually entered the Network Name (SSID) and security information (authentication method/encryption method), the information may be incorrect. Check the Network Name and security information again and re-enter the correct information.• Restart your wireless router/access point. If you cannot find the Network Name (SSID) and security information, see the documentation provided with your wireless router/access point, or contact the router manufacturer, your system administrator, or Internet service provider. |
| TS-03 | <p>The wireless enterprise network and security settings you entered may be incorrect.</p> <p>Check the following points and try to set up your wireless connection again:</p> <p>Verify the following information:</p> <ul style="list-style-type: none">- Network Name (SSID) you selected to configure your machine.- Security information you selected to configure your machine (such as the authentication method, encryption method, or User ID). <p>If you still cannot find the Network Name (SSID) and security information, see the documentation provided with your wireless router/access point, or contact the router manufacturer, your system administrator, or Internet service provider.</p> |

| Error Code | Problem and Recommended Solutions |
|------------|--------------------------------------------------------------------------------------------------------------------------------------------------------------------------------------------------------------------------------------------------------------------------------------------------------------------------------------------------------------------------------------------------------------------------------------------------------------------------------------------------------------------------------------------------------------------------------------------------------------------------------------------------------------------------------------------------------------------------------------------------------------------------------------------------------------------------------------------------------------------------------------------------------------------------------------------------------------------------------------------------------------------------------------------------------------------------------------------------------------------------|
| TS-04 | <p>Your machine does not support the authentication and encryption methods used by the selected wireless router/access point.</p> <p>For infrastructure mode (Most common)</p> <p>Change the authentication and encryption methods of the wireless router/access point. Your machine supports the following authentication and encryption methods:</p> <ul style="list-style-type: none"> • WPA-Personal: TKIP / AES • WPA2-Personal: TKIP / AES • WPA3-Personal: AES • OPEN: WEP / NONE (without encryption) • Shared key: WEP <p>If your issue is not solved, the Network Name (SSID) or security settings you entered may be incorrect. Check that all wireless network settings are correct for your network.</p> |
| TS-05 | <p>The Network Name (SSID) and Network Key (Password) are incorrect.</p> <p>Check the following points and try to set up your wireless connection again:</p> <ul style="list-style-type: none"> • Confirm the Network Name (SSID) and Network Key (Password). • If your Network Key contains upper-case and lower-case letters, make sure you type them correctly. • If you cannot find the Network Name (SSID) and security information, see the documentation provided with your wireless router/access point, or contact the router manufacturer, your system administrator, or Internet service provider. • If your wireless router/access point uses WEP encryption with multiple WEP keys, write down and use only the first WEP key. |
| TS-06 | <p>The wireless security information (authentication method/encryption method/Network Key (Password)) is incorrect.</p> <p>Check the following points and try to set up your wireless connection again:</p> <ul style="list-style-type: none"> • Confirm the Network Key. If your Network Key contains upper-case and lower-case letters, make sure you type them correctly. • Confirm whether the authentication method entered and the authentication method or encryption method supported by the wireless router/access point are the same. • If the network key, authentication method, and encryption method have been confirmed, restart your wireless router/access point and the machine. • If your wireless router/access point's Stealth Mode is on, you may need to disable it to connect to the wireless network. <p>If you cannot find the Network Name (SSID) and security information, see the documentation provided with your wireless router/access point, or contact the router manufacturer, your system administrator, or Internet service provider.</p> |
| TS-07 | <p>The machine cannot detect a wireless router/access point that has WPS (Wi-Fi Protected Setup) enabled.</p> <p>Check the following points and try again:</p> <ul style="list-style-type: none"> • To check if your wireless router/access point supports WPS, look for the WPS symbol displayed on the router/access point. For more information, see the documentation provided with your wireless router/access point. • To set up your wireless connection using WPS, you must configure both your machine and the wireless router/access point. For more information, see the user's guide. • If you do not know how to set up your wireless router/access point using WPS, see the documentation provided with your wireless router/access point, or contact the router manufacturer, your system administrator, or Internet service provider. |

| Error Code | Problem and Recommended Solutions |
|------------|-----------------------------------------------------------------------------------------------------------------------------------------------------------------------------------------------------------------------------------------------------------------------------------------------------------------------------------------------------------------------------------------------------------------------------|
| TS-08 | <p>Two or more wireless routers or access points that have WPS enabled are detected.</p> <p>Check the following points and try again:</p> <ul style="list-style-type: none"> • Make sure that only one wireless router/access point within range has WPS enabled, and then try to connect again. • Try to connect again after a few minutes to avoid interference from other access points/routers. |



How to confirm wireless security information (SSID/authentication method/encryption method/Network Key) of your WLAN access point/router:

1. The default security settings may be provided on a label attached to the WLAN access point/router. Or the manufacturer's name or model number of the WLAN access point/router may be used as the default security settings.
2. See the documentation provided with your WLAN access point/router for information on how to find the security settings.
 - If the WLAN access point/router is set to not broadcast the SSID, the SSID will not automatically be detected. You will have to manually enter the SSID name.
 - The Network Key may also be described as the Password, Security Key, or Encryption Key.

If you do not know the SSID and wireless security settings of your WLAN access point/router or how to change the configuration, see the documentation provided with your WLAN access point/router, ask the manufacturer of your access point/router or ask your Internet provider or network administrator.



Related Information

- [Print the WLAN Report](#)

Related Topics:

- [My Machine Cannot Print, Scan, or Use the PC-FAX Receive Function over the Network](#)
- [I Want to Check that My Network Devices are Working Correctly](#)
- [Configure Your Machine for a Wireless Network Using the One Push Method of Wi-Fi Protected Setup™ \(WPS\)](#)
- [Configure Your Machine for a Wireless Network Using the PIN Method of Wi-Fi Protected Setup™ \(WPS\)](#)
- [Configure Your Machine for a Wireless Network Using the Machine's Control Panel Setup Wizard](#)
- [Configure Your Machine for a Wireless Network When the SSID Is Not Broadcast](#)
- [Configure Your Machine for an Enterprise Wireless Network](#)

Network Features

Related Models: DCP-L2620DW/DCP-L2622DW/DCP-L2627DW/DCP-L2627DWXL/DCP-L2627DWE/
DCP-L2640DN/DCP-L2660DW/DCP-L2665DW/MFC-L2802DN/MFC-L2800DW/MFC-L2802DW/
MFC-L2827DWXL/MFC-L2827DW/MFC-L2835DW/MFC-L2860DWE/MFC-L2860DW/MFC-L2862DW/
MFC-L2922DW/MFC-L2960DW/MFC-L2980DW

- [Enable/Disable Web Based Management Using the Control Panel](#)
- [Configure the Proxy Server Settings Using Web Based Management](#)
- [Print the Network Configuration Report](#)
- [Configure PC-FAX Receiving Using Web Based Management](#)
- [Fax Using the Internet \(I-Fax\)](#)
- [Use the Send Fax to Server Feature](#)
- [Synchronise Time with the SNTP Server Using Web Based Management](#)
- [Forward Incoming Faxes to a Network Destination](#)
- [Reset the Network Settings to the Factory Settings](#)

Enable/Disable Web Based Management Using the Control Panel

Related Models: DCP-L2620DW/DCP-L2622DW/DCP-L2627DW/DCP-L2627DWXL/DCP-L2627DWE/
DCP-L2640DN/DCP-L2660DW/DCP-L2665DW/MFC-L2802DN/MFC-L2800DW/MFC-L2802DW/
MFC-L2827DWXL/MFC-L2827DW/MFC-L2835DW/MFC-L2860DWE/MFC-L2860DW/MFC-L2862DW/
MFC-L2922DW/MFC-L2960DW/MFC-L2980DW

>> DCP-L2620DW/DCP-L2622DW/DCP-L2627DW/DCP-L2627DWXL/DCP-L2627DWE/DCP-L2640DN/
MFC-L2802DN/MFC-L2800DW/MFC-L2802DW/MFC-L2827DWXL/MFC-L2827DW/MFC-L2835DW
>> DCP-L2660DW/DCP-L2665DW/MFC-L2860DWE/MFC-L2860DW/MFC-L2862DW/MFC-L2922DW/
MFC-L2960DW/MFC-L2980DW

**DCP-L2620DW/DCP-L2622DW/DCP-L2627DW/DCP-L2627DWXL/DCP-L2627DWE/
DCP-L2640DN/MFC-L2802DN/MFC-L2800DW/MFC-L2802DW/MFC-L2827DWXL/
MFC-L2827DW/MFC-L2835DW**

1. Press **Menu**.
2. Press **▲** or **▼** to select the [Network] option, and then press **OK**.
3. Press **▲** or **▼** to select the [Web Based Mgmt] option, and then press **OK**.
4. Press **▲** or **▼** to select the option you want, and then press **OK**.



If you enable this function, make sure you specify the connection method to use Web Based Management.

**DCP-L2660DW/DCP-L2665DW/MFC-L2860DWE/MFC-L2860DW/MFC-L2862DW/
MFC-L2922DW/MFC-L2960DW/MFC-L2980DW**

1. Press  [Settings] > [All Settings] > [Network] > [Web Based Mgmt].
2. Press to select the option you want.



If you enable this function, make sure you specify the connection method to use Web Based Management.

Related Information

- [Network Features](#)

Related Topics:

- [Print an Email Attachment](#)

Configure the Proxy Server Settings Using Web Based Management

Related Models: DCP-L2660DW/DCP-L2665DW/MFC-L2860DWE/MFC-L2860DW/MFC-L2862DW/MFC-L2922DW/MFC-L2960DW/MFC-L2980DW

If your network uses a proxy server, the following proxy server information must be configured using Web Based Management:

- Proxy server address
- Port number
- User Name
- Password



- We recommend using the latest version of the following web browsers:
 - Microsoft Edge, Firefox, and Google Chrome™ for Windows
 - Safari, Firefox, and Google Chrome™ for Mac
 - Google Chrome™ for Android™
 - Safari and Google Chrome™ for iOS
- Ensure that JavaScript and Cookies are always enabled, regardless of which browser you use.

1. Start your web browser.
2. Type "https://machine's IP address" in your browser's address bar (where "machine's IP address" is your machine's IP address).

For example:

https://192.168.1.2

3. If required, type the password in the **Login** field, and then click **Login**.



The default password to manage this machine's settings is located on the back of the machine and marked "Pwd". Change the default password by following the on-screen instructions when you first log in.

4. In the left navigation bar, click **Network > Network > Protocol**.



If the left navigation bar is not visible, start navigating from ☰.

5. Make sure the **Proxy** checkbox is selected, and then click **Submit**.
6. In the **Proxy** field, click **Advanced Settings**.
7. Enter the proxy server information.
8. Click **Submit**.



Related Information

- [Network Features](#)

Related Topics:

- [Register Your Machine with Universal Print Using Web Based Management](#)
- [Configure the Proxy Server Settings Using the Machine's Control Panel](#)

Print the Network Configuration Report

Related Models: DCP-L2620DW/DCP-L2622DW/DCP-L2627DW/DCP-L2627DWXL/DCP-L2627DWE/DCP-L2640DN/DCP-L2660DW/DCP-L2665DW/MFC-L2802DN/MFC-L2800DW/MFC-L2802DW/MFC-L2827DWXL/MFC-L2827DW/MFC-L2835DW/MFC-L2860DWE/MFC-L2860DW/MFC-L2862DW/MFC-L2922DW/MFC-L2960DW/MFC-L2980DW

The Network Configuration Report lists the network configuration, including the network print server settings.



- The Node Name appears on the Network Configuration Report. The default Node Name is "BRN123456abcdef" for a wired network or "BRW123456abcdef" for a wireless network (where "123456abcdef" is your machine's MAC Address / Ethernet Address.)
- If the IP Address on the Network Configuration Report shows 0.0.0.0, wait for one minute and try printing it again.
- You can find your machine's settings, such as the IP address, subnet mask, node name, and MAC Address on the report, for example:
 - IP address: 192.168.0.5
 - Subnet mask: 255.255.255.0
 - Node name: BRN000ca0000499
 - MAC Address: 00-0c-a0-00-04-99

>> DCP-L2620DW/DCP-L2622DW/DCP-L2627DW/DCP-L2627DWXL/DCP-L2627DWE/DCP-L2640DN/MFC-L2802DN/MFC-L2800DW/MFC-L2802DW/MFC-L2827DWXL/MFC-L2827DW/MFC-L2835DW
>> DCP-L2660DW/DCP-L2665DW/MFC-L2860DWE/MFC-L2860DW/MFC-L2862DW/MFC-L2922DW/MFC-L2960DW/MFC-L2980DW

**DCP-L2620DW/DCP-L2622DW/DCP-L2627DW/DCP-L2627DWXL/DCP-L2627DWE/
DCP-L2640DN/MFC-L2802DN/MFC-L2800DW/MFC-L2802DW/MFC-L2827DWXL/
MFC-L2827DW/MFC-L2835DW**

1. Press **Menu**.
2. Press **▲** or **▼** to display the [Print Reports] option, and then press **OK**.
3. Press **▲** or **▼** to select the [Network Config] option, and then press **OK**.
4. Press **Start**.

**DCP-L2660DW/DCP-L2665DW/MFC-L2860DWE/MFC-L2860DW/MFC-L2862DW/
MFC-L2922DW/MFC-L2960DW/MFC-L2980DW**

1. Press  [Settings] > [All Settings] > [Print Reports] > [Network Configuration].
2. Press [Yes].
The machine prints the Network Configuration Report.

Related Information

- [Network Features](#)

Related Topics:

- [Check Your Machine's Network Settings](#)
- [Use the Network Connection Repair Tool \(Windows\)](#)
- [Error Messages](#)
- [I Want to Check that My Network Devices are Working Correctly](#)

-
- Access Web Based Management
-

Configure PC-FAX Receiving Using Web Based Management

Related Models: MFC-L2802DN/MFC-L2800DW/MFC-L2802DW/MFC-L2827DWXL/MFC-L2827DW/MFC-L2835DW/MFC-L2860DWE/MFC-L2860DW/MFC-L2862DW/MFC-L2922DW/MFC-L2960DW/MFC-L2980DW

Use Web Based Management to configure your PC Fax Receiving in a web browser.

1. Start your web browser.
2. Type "https://machine's IP address" in your browser's address bar (where "machine's IP address" is your machine's IP address).

For example:

https://192.168.1.2

3. If required, type the password in the **Login** field, and then click **Login**.



The default password to manage this machine's settings is located on the back of the machine and marked "**Pwd**". Change the default password by following the on-screen instructions when you first log in.

4. In the left navigation bar, click **Network > Network > Protocol**.



If the left navigation bar is not visible, start navigating from ☰.

5. Select the **PC Fax Receive** checkbox, and then click **Submit**.
6. Restart your Brother machine to activate the configuration.



Related Information

- [Network Features](#)

Related Topics:

- [Run the Brother PC-FAX Receive on Your Computer \(Windows\)](#)

Fax Using the Internet (I-Fax)

Related Models: MFC-L2802DN/MFC-L2800DW/MFC-L2802DW/MFC-L2827DWXL/MFC-L2827DW/MFC-L2835DW/MFC-L2860DWE/MFC-L2860DW/MFC-L2862DW/MFC-L2922DW/MFC-L2960DW/MFC-L2980DW

With Internet Fax (I-Fax), you can send and receive fax documents using the Internet. Documents are transmitted in email messages as attached TIFF-F files. Your computer can send and receive documents as long as it has an application that can create and view TIFF-F files. You can use any TIFF-F viewer application. Documents sent via the machine will be converted into a TIFF-F format automatically. To send and receive messages to and from your machine, your computer's email application must support Multipurpose Internet Mail Extensions (MIME).

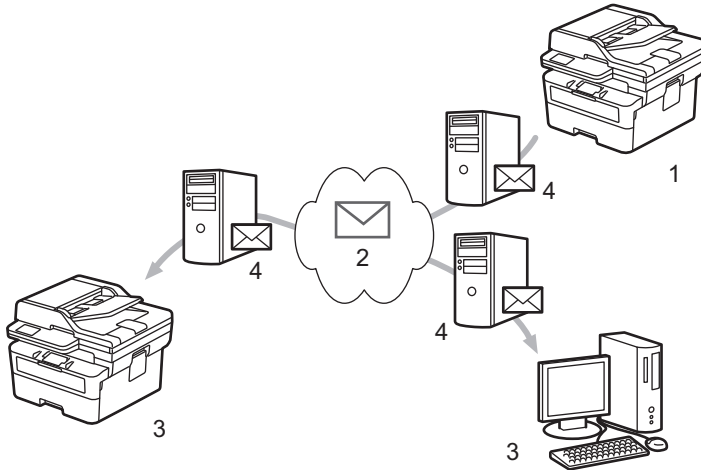

1. Sender
2. Internet
3. Receiver
4. Email server



I-Fax supports sending and receiving documents in Letter or A4 format and in monochrome only.

✓ Related Information

- [Network Features](#)
 - [Important Information about Internet Fax \(I-Fax\)](#)
 - [Configure the Brother Machine for Email or Internet Fax \(I-Fax\)](#)
 - [Send an Internet Fax \(I-Fax\)](#)
 - [Poll the Server Manually](#)
 - [I-Fax Options](#)

Related Topics:

- [Forward Received Email and Fax Messages](#)

Important Information about Internet Fax (I-Fax)

Related Models: MFC-L2802DN/MFC-L2800DW/MFC-L2802DW/MFC-L2827DWXL/MFC-L2827DW/MFC-L2835DW/MFC-L2860DWE/MFC-L2860DW/MFC-L2862DW/MFC-L2922DW/MFC-L2960DW/MFC-L2980DW

I-Fax communication on a LAN is very similar to communication via email; however, it is different from fax communication using standard phone lines. Make sure you read the following information about using I-Fax:

- Factors such as the receiver's location, structure of the LAN and how busy the circuit (such as the Internet) is may cause the system to take longer than usual to send an error mail.
- When sending confidential documents, we recommend using standard phone lines instead of the Internet (due to its low level of security).
- If the receiver's mail system is not MIME-compatible, you cannot use I-Fax to send documents. If possible, check this in advance, and note that some servers will not send an error reply.
- If a document is too large to send via I-Fax, it may not reach the receiver.
- You cannot change the font or size of the text in any Internet mail you receive.



Related Information

- [Fax Using the Internet \(I-Fax\)](#)

Configure the Brother Machine for Email or Internet Fax (I-Fax)

Related Models: MFC-L2802DN/MFC-L2800DW/MFC-L2802DW/MFC-L2827DWXL/MFC-L2827DW/MFC-L2835DW/MFC-L2860DWE/MFC-L2860DW/MFC-L2862DW/MFC-L2922DW/MFC-L2960DW/MFC-L2980DW

Before using I-Fax, configure your Brother machine to communicate with your network and mail server. You can configure these items using the machine's control panel or Web Based Management. Make sure the following items are configured on your machine:

- IP address (If you are already using your machine on your network, the machine's IP address has been configured correctly.)
- Email address
- SMTP, POP3, IMAP4 server address/port/Authentication method/Encryption method/Server Certificate Verification
- Mailbox name and password

If you are unsure of any of these items, contact your system administrator.



Related Information

- [Fax Using the Internet \(I-Fax\)](#)
 - [Initial Setup for Email or Internet Fax \(I-Fax\)](#)
 - [How Received I-Faxes Appear on a Computer](#)

Related Topics:

- [I-Fax Options](#)

Initial Setup for Email or Internet Fax (I-Fax)

Related Models: MFC-L2802DN/MFC-L2800DW/MFC-L2802DW/MFC-L2827DWXL/MFC-L2827DW/MFC-L2835DW/MFC-L2860DWE/MFC-L2860DW/MFC-L2862DW/MFC-L2922DW/MFC-L2960DW/MFC-L2980DW

Before sending your I-Fax, use the control panel or Web Based Management to configure the following optional items:

- **E-mail Subject**
- **E-mail Message**
- **Size Limit**
- **Request Delivery Notification (Send)**

E-mail Send

E-mail Subject

Internet Fax Job

E-mail Message

Image data has been attached.

Size Limit

- Off
 On

Maximum Size

1 MB

Request Delivery Notification (Send)

- Off
 On

[POP3/IMAP4/SMTP Client>>](#)

Cancel

Submit

If you are unsure of any of these items, contact your system administrator.



Related Information

- [Configure the Brother Machine for Email or Internet Fax \(I-Fax\)](#)
 - [How Your Brother Machine Receives an Internet Fax \(I-Fax\)](#)

Related Topics:

- [Forward Received Email and Fax Messages](#)
-

How Your Brother Machine Receives an Internet Fax (I-Fax)

Related Models: MFC-L2802DN/MFC-L2800DW/MFC-L2802DW/MFC-L2827DWXL/MFC-L2827DW/MFC-L2835DW/MFC-L2860DWE/MFC-L2860DW/MFC-L2862DW/MFC-L2922DW/MFC-L2960DW/MFC-L2980DW

When your Brother machine receives an incoming I-Fax, it will print the I-Fax automatically. To receive an I-Fax, we recommend using the control panel or Web Based Management to configure the following optional items:

- **Auto Polling**
- **Polling Frequency**
- **Print Mail Header**
- **Delete/Read Receive Error Mail**
- **Send Delivery Notification (Receive)**

E-mail Receive

Auto Polling

- Off
 On

Polling Frequency

10 Mins

Print Mail Header

None

Delete/Read Receive Error Mail

- Off
 On

Send Delivery Notification (Receive)

Off

[POP3/IMAP4/SMTP Client>>](#)

Cancel

Submit

There are two ways you can receive email messages:

-
- POP3/IMAP4 receiving at regular intervals
 - POP3/IMAP4 receiving, manually initiated

When using POP3/IMAP4 receiving, the machine polls your email server to receive data. Polling can occur at set intervals (for example, you can configure the machine to poll the email server every ten minutes) or you can manually poll the server.



-
- If your machine starts to receive email data, the LCD displays [Receiving]. The email will be printed automatically.
 - If your machine is out of paper when receiving data, the received data will be held in the machine's memory. This data will be printed automatically after paper is reloaded in the paper tray.
 - When the machine's Temporary Fax Backup Function is turned on, received data will be stored for a certain period of time.
 - If the received mail is not in a plain text format, or an attached file is not in the TIFF-F format, the error message "**ATTACHED FILE FORMAT NOT SUPPORTED.**" will be printed.
 - If the received mail is too large, the error message "**E-MAIL FILE TOO LARGE.**" will be printed.
 - If **Delete/Read Receive Error Mail** is **On** (default), then the error mail will be deleted from the email server automatically.
-



Related Information

- [Initial Setup for Email or Internet Fax \(I-Fax\)](#)

Related Topics:

- [How Received I-Faxes Appear on a Computer](#)
 - [Forward Received Email and Fax Messages](#)
-

How Received I-Faxes Appear on a Computer

Related Models: MFC-L2802DN/MFC-L2800DW/MFC-L2802DW/MFC-L2827DWXL/MFC-L2827DW/MFC-L2835DW/MFC-L2860DWE/MFC-L2860DW/MFC-L2862DW/MFC-L2922DW/MFC-L2960DW/MFC-L2980DW

When a computer receives an I-Fax document, the document is attached to an email message that notifies you in its Subject field that your email server has received an I-Fax. You can either wait for your Brother machine to poll the email server, or you can manually poll the email server to receive the incoming data.



Related Information

- [Configure the Brother Machine for Email or Internet Fax \(I-Fax\)](#)

Related Topics:

- [How Your Brother Machine Receives an Internet Fax \(I-Fax\)](#)

Send an Internet Fax (I-Fax)

Related Models: MFC-L2802DN/MFC-L2800DW/MFC-L2802DW/MFC-L2827DWXL/MFC-L2827DW/
MFC-L2835DW/MFC-L2860DWE/MFC-L2860DW/MFC-L2862DW/MFC-L2922DW/MFC-L2960DW/
MFC-L2980DW

Sending an I-Fax is like sending a normal fax. Make sure that your recipient's information is saved in your email address book, and load the document you want to I-Fax into your Brother machine.



- If the computer to which you want to send a document is not running Windows Server 2012/2012 R2/2016/2019/2022, Windows 10 or Windows 11, ask the computer's owner to install software that can view TIFF files.
- To send multiple pages, use the ADF.

>> [MFC-L2802DN/MFC-L2800DW/MFC-L2802DW/MFC-L2827DWXL/MFC-L2827DW/MFC-L2835DW](#)
>> [MFC-L2860DWE/MFC-L2860DW/MFC-L2862DW/MFC-L2922DW/MFC-L2960DW/MFC-L2980DW](#)

MFC-L2802DN/MFC-L2800DW/MFC-L2802DW/MFC-L2827DWXL/MFC-L2827DW/ MFC-L2835DW

1. Press  (**Fax**).
2. [Load your document](#).
3. To change the fax-sending settings, press **Menu** and then press **▲** or **▼** to display the [Fax] option, and then press **OK**.
4. Press **▲** or **▼** to display the [Setup Send] option, and then press **OK**. When you have finished changing settings, press **OK**.
5. Select a Speed Dial or Shortcut number.



Before specifying a recipient's email address, make sure you have added their email address to Speed Dial or a Shortcut using Web Based Management.

6. Press **Start**.
The machine starts scanning. After the document is scanned, it is transmitted to the recipient via your SMTP server. You can cancel the send operation by pressing **Stop/Exit** during scanning. When the transmission is finished, the machine will enter standby mode.

MFC-L2860DWE/MFC-L2860DW/MFC-L2862DW/MFC-L2922DW/MFC-L2960DW/ MFC-L2980DW

1. [Load your document](#).
2. Do one of the following:
 - If Fax Preview is set to [Off], press [Fax].
 - If Fax Preview is set to [On], press [Fax], and then press [Send a fax].
3. To change the fax-sending settings, press [Options].
4. Press **▲** or **▼** to scroll through the fax settings. When the setting you want appears, press it and select your preference. When you have finished changing settings, press [OK].
5. Do one of the following:
 - Press , enter the email address, and then press [OK].
 - Press [Address Book], select the email address of your recipient, and then press [Apply].
6. Press [Fax Start].

The machine starts scanning. After the document is scanned, it is transmitted to the recipient via your SMTP server. You can cancel the send operation by pressing  during scanning. When the transmission is finished, the machine will enter standby mode.



Related Information

- [Fax Using the Internet \(I-Fax\)](#)
-

Poll the Server Manually

Related Models: MFC-L2802DN/MFC-L2800DW/MFC-L2802DW/MFC-L2827DWXL/MFC-L2827DW/
MFC-L2835DW/MFC-L2860DWE/MFC-L2860DW/MFC-L2862DW/MFC-L2922DW/MFC-L2960DW/
MFC-L2980DW

>> [MFC-L2802DN/MFC-L2800DW/MFC-L2802DW/MFC-L2827DWXL/MFC-L2827DW/MFC-L2835DW](#)
>> [MFC-L2860DWE/MFC-L2860DW/MFC-L2862DW/MFC-L2922DW/MFC-L2960DW/MFC-L2980DW](#)

MFC-L2802DN/MFC-L2800DW/MFC-L2802DW/MFC-L2827DWXL/MFC-L2827DW/ MFC-L2835DW

1. Press **Menu**.
2. Press **▲** or **▼** to select the [Network] option, and then press **OK**.
3. Press **▲** or **▼** to select the [E-mail/IFAX] option, and then press **OK**.
4. Press **▲** or **▼** to select the [Manual Receive] option, and then press **OK**.
5. The LCD displays [Receiving] and your machine will print the data from the email server.

MFC-L2860DWE/MFC-L2860DW/MFC-L2862DW/MFC-L2922DW/MFC-L2960DW/ MFC-L2980DW

1. Press  [Settings] > [All Settings] > [Network] > [E-mail/IFAX] > [Manual Receive].
2. Press [Yes] to confirm.
3. The LCD displays [Receiving] and your machine will print the data from the email server.

Related Information

- [Fax Using the Internet \(I-Fax\)](#)

I-Fax Options

Related Models: MFC-L2802DN/MFC-L2800DW/MFC-L2802DW/MFC-L2827DWXL/MFC-L2827DW/
MFC-L2835DW/MFC-L2860DWE/MFC-L2860DW/MFC-L2862DW/MFC-L2922DW/MFC-L2960DW/
MFC-L2980DW

- [Forward Received Email and Fax Messages](#)
- [Relay Broadcast](#)
- [Internet Fax \(I-Fax\) Verification Mail](#)
- [Configure the Brother Machine for Email or Internet Fax \(I-Fax\)](#)

Forward Received Email and Fax Messages

Related Models: MFC-L2802DN/MFC-L2800DW/MFC-L2802DW/MFC-L2827DWXL/MFC-L2827DW/MFC-L2835DW/MFC-L2860DWE/MFC-L2860DW/MFC-L2862DW/MFC-L2922DW/MFC-L2960DW/MFC-L2980DW

Use Brother's I-Fax feature to forward email or standard fax messages to another computer, to a fax machine, or to another I-Fax machine. Enable the Forwarding feature using your machine's control panel.

>> [MFC-L2802DN/MFC-L2800DW/MFC-L2802DW/MFC-L2827DWXL/MFC-L2827DW/MFC-L2835DW](#)
>> [MFC-L2860DWE/MFC-L2860DW/MFC-L2862DW/MFC-L2922DW/MFC-L2960DW/MFC-L2980DW](#)

MFC-L2802DN/MFC-L2800DW/MFC-L2802DW/MFC-L2827DWXL/MFC-L2827DW/MFC-L2835DW

1. Press **Menu**.
2. Press **▲** or **▼** to display the [Fax] option, and then press **OK**.
3. Press **▲** or **▼** to display the [Memory Receive] option, and then press **OK**.
4. Press **▲** or **▼** to display the [Forward/Store] option, and then press **OK**.
5. Press **▲** or **▼** to display the [Fax Forward] option, and then press **OK**.
6. Enter the recipient's fax number or email address.
7. Press **OK**.
8. If you select the email address, press **▲** or **▼** to select the file type you want, and then press **OK**.



To print received faxes at your machine so you will have a copy, press **▲** or **▼** to display the [Backup Print] option, and then press **OK**. Press **▲** or **▼** to select [On] option, and then press **OK**.

9. Press **Stop/Exit**.

MFC-L2860DWE/MFC-L2860DW/MFC-L2862DW/MFC-L2922DW/MFC-L2960DW/MFC-L2980DW

To enable email forwarding using your machine's control panel:

1. Press  [Settings] > [All Settings] > [Fax] > [Setup Receive] > [Memory Receive].
2. Press [Fax Forward].
3. Do one of the following:
 - Press [Manual] to enter the recipient's fax number (up to 20 digits) or email address using the LCD. Press [OK].
 - Press [Address Book].
Press **▲** or **▼** to display the fax number or email address where you want your faxes to be forwarded. Press the fax number or email address you want.
4. If you select the email address, select the file type you want.



Press [Backup Print: On] to print received faxes at your machine so you will have a copy.

5. Press .

Related Information

- [I-Fax Options](#)

Related Topics:

- [Fax Using the Internet \(I-Fax\)](#)
 - [Initial Setup for Email or Internet Fax \(I-Fax\)](#)
 - [How Your Brother Machine Receives an Internet Fax \(I-Fax\)](#)
-

Relay Broadcast

Related Models: MFC-L2802DN/MFC-L2800DW/MFC-L2802DW/MFC-L2827DWXL/MFC-L2827DW/
MFC-L2835DW/MFC-L2860DWE/MFC-L2860DW/MFC-L2862DW/MFC-L2922DW/MFC-L2960DW/
MFC-L2980DW

A Relay Broadcast is when your Brother machine receives a message over the Internet and then relays it to another fax machine using conventional telephone lines. If you must fax a document over a long distance or abroad, use the Relay Broadcast Function to save the communication fee.

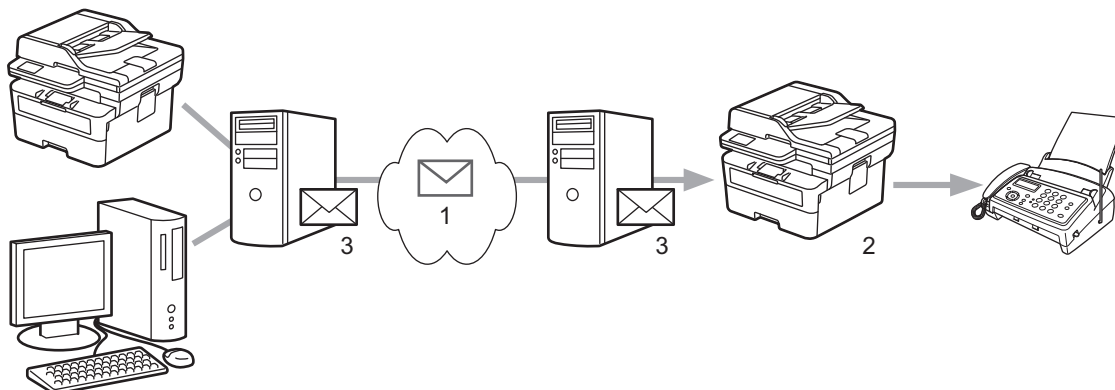

1. The Internet
2. Telephone line
3. Email server

Use the Brother machine's control panel or Web Based Management to configure the following items:

- **Relay Broadcast Function**

Set the **Relay Broadcast Function** to **On**.

- **Relay Domain**

Configure your machine's domain name on the machine that will broadcast the document to the conventional fax machine. If you wish to use your machine as a relay broadcast device, you must specify the trusted domain name (the portion of the name after the "@" sign) at the machine. Use care in selecting a trusted domain: any user on a trusted domain will be able to send a relay broadcast. You can register up to ten domain names.

- **Relay Broadcast Report**

Specify whether or not you want a report to print after the machine completes the relay broadcast.

Relay Function

Relay Broadcast Function

- Off
 On
-

Relay Domain

Relay Broadcast Report

- Off
 On
-

Related Information

- [I-Fax Options](#)
 - [Relay Broadcast from Your Brother Machine](#)
 - [Relay Broadcast from Your Computer](#)
-

Relay Broadcast from Your Brother Machine

Related Models: MFC-L2802DN/MFC-L2800DW/MFC-L2802DW/MFC-L2827DWXL/MFC-L2827DW/MFC-L2835DW/MFC-L2860DWE/MFC-L2860DW/MFC-L2862DW/MFC-L2922DW/MFC-L2960DW/MFC-L2980DW

Use the Relay Broadcast Function to send an email from your machine to a conventional fax machine.

Confirm the **POP3/IMAP4/SMTP Client** and **SMTP Server** checkboxes are selected in Web Based Management. If the **POP3/IMAP4/SMTP Client** and **SMTP Server** checkboxes are not selected, select the **POP3/IMAP4/SMTP Client** and **SMTP Server** checkboxes. Click **Submit**, and then restart your machine.

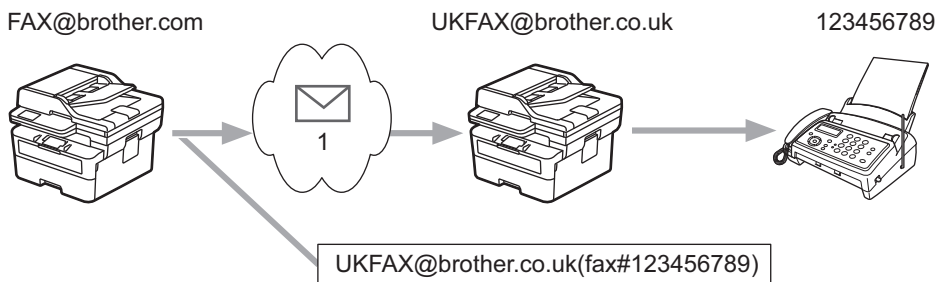



1. The Internet

In this example, your machine's email address is FAX@brother.com and you want to send a document from your machine to a standard fax machine in England with the email address UKFAX@brother.co.uk, and you want your machine to send the document using a conventional telephone line.

>> [MFC-L2802DN/MFC-L2800DW/MFC-L2802DW/MFC-L2827DWXL/MFC-L2827DW/MFC-L2835DW](#)
>> [MFC-L2860DWE/MFC-L2860DW/MFC-L2862DW/MFC-L2922DW/MFC-L2960DW/MFC-L2980DW](#)

MFC-L2802DN/MFC-L2800DW/MFC-L2802DW/MFC-L2827DWXL/MFC-L2827DW/MFC-L2835DW

To use this feature, you must register the email addresses as the Shortcut numbers or Speed Dial numbers.

1. Press  (**Fax**).
2. [Load your document](#).
3. Do one of the following:
 - Hold down the **Shortcut** button, and then enter the one-digit Shortcut number.
 - Press  (Address Book), and then enter the three-digit Speed Dial number you have registered.
Press **OK**.
4. Press **Start**.

MFC-L2860DWE/MFC-L2860DW/MFC-L2862DW/MFC-L2922DW/MFC-L2960DW/MFC-L2980DW

1. [Load your document](#).
2. Do one of the following:
 - If Fax Preview is set to [Off], press [Fax].
 - If Fax Preview is set to [On], press [Fax], and then press [Send a fax].
3. Press [Options].
4. Press ▲ or ▼ to display the [Broadcasting] option.

5. Press [Broadcasting].

6. Press [Add Number].

7. You can add email addresses to the broadcast in the following ways:

- Press [Add Number]. Press , enter the email address and press [OK].
- Press [Add from Address book]. Press the checkbox of the email address you want to add to the broadcast. After you have checked all the email addresses you want, press [OK].
- Press [Search in Address book]. Enter the name and press [OK]. The search results will be displayed. Press the name and then press the email address you want to add to the broadcast.

The following is an example of how to enter the email address and phone number:

UKFAX@brother.co.uk(fax#123456789)



The word "fax#" must be included with the phone number inside the parenthesis.

After you have entered all of the fax numbers, press [OK].

8. Press [Fax Start].



Related Information

- [Relay Broadcast](#)
-

Relay Broadcast from Your Computer

Related Models: MFC-L2802DN/MFC-L2800DW/MFC-L2802DW/MFC-L2827DWXL/MFC-L2827DW/MFC-L2835DW/MFC-L2860DWE/MFC-L2860DW/MFC-L2862DW/MFC-L2922DW/MFC-L2960DW/MFC-L2980DW

Use the Relay Broadcast Function to send an email from your computer to a conventional fax machine.

- Some email applications do not support sending an email to multiple fax numbers. If your email application cannot support multiple fax numbers, you can relay to only one fax machine at a time.

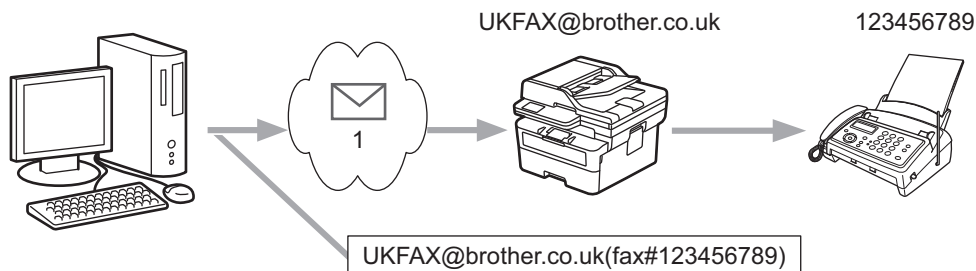

1. The Internet

- Confirm the **POP3/IMAP4/SMTP Client** and **SMTP Server** checkboxes are selected in Web Based Management. If the **POP3/IMAP4/SMTP Client** and **SMTP Server** checkboxes are not selected, select the **POP3/IMAP4/SMTP Client** and **SMTP Server** checkboxes. Click **Submit**, and then restart your machine.

If you are sending an email to a conventional fax machine, the method of entering the fax machine's fax number will vary, depending on the mail application you are using.

- In your email application, create a new email message and type the email address of the relay machine and fax number of the first fax machine in the "TO" box.

The following is an example of how to enter the email address and fax number:

UKFAX@brother.co.uk(fax#123456789)

email address Fax Phone Number

The word "fax#" must be included with the phone number inside the parenthesis.



For Microsoft Outlook, the address information must be entered into the address book as follows:

Name: fax#123456789

Email address: UKFAX@brother.co.uk

- Type the email address of the relay machine and fax number of the second fax machine in the "TO" box.
- Send the email.



Related Information

- [Relay Broadcast](#)

Internet Fax (I-Fax) Verification Mail

Related Models: MFC-L2802DN/MFC-L2800DW/MFC-L2802DW/MFC-L2827DWXL/MFC-L2827DW/MFC-L2835DW/MFC-L2860DWE/MFC-L2860DW/MFC-L2862DW/MFC-L2922DW/MFC-L2960DW/MFC-L2980DW

- Verification Mail for sending allows you to request notification from the receiving station where your I-Fax or email was received and processed.
- Verification Mail for receiving allows you to transmit a default report back to the sending station after successfully receiving and processing an I-Fax or email.

To use this feature, set the [Notification] options in the [Setup Mail RX] and [Setup Mail TX] options of your machine's control panel menu.



Related Information

- [I-Fax Options](#)
 - [Enable Send Notifications for TX Verification Mail](#)
 - [Enable Receive Notification for TX Verification Mail](#)
 - [I-Fax Error Mail](#)

Enable Send Notifications for TX Verification Mail

Related Models: MFC-L2802DN/MFC-L2800DW/MFC-L2802DW/MFC-L2827DWXL/MFC-L2827DW/MFC-L2835DW/MFC-L2860DWE/MFC-L2860DW/MFC-L2862DW/MFC-L2922DW/MFC-L2960DW/MFC-L2980DW

>> MFC-L2802DN/MFC-L2800DW/MFC-L2802DW/MFC-L2827DWXL/MFC-L2827DW/MFC-L2835DW
>> MFC-L2860DWE/MFC-L2860DW/MFC-L2862DW/MFC-L2922DW/MFC-L2960DW/MFC-L2980DW

MFC-L2802DN/MFC-L2800DW/MFC-L2802DW/MFC-L2827DWXL/MFC-L2827DW/MFC-L2835DW

1. Press **Menu**.
2. Press **▲** or **▼** to display the [Network] option, and then press **OK**.
3. Press **▲** or **▼** to display the [E-mail/IFAX] option, and then press **OK**.
4. Press **▲** or **▼** to display the [Setup Mail TX] option, and then press **OK**.
5. Press **▲** or **▼** to display the [Notification] option, and then press **OK**.
6. Select [On] or [Off] to enable or disable the Send Notification feature, and then press **OK**.
When Send Notification is On, the fax includes an additional field, named Message Disposition Notification (MDN), that contains message delivery information.



Your fax recipient's machine must support the MDN field in order to send a notification report.

7. Press **Stop/Exit**.

MFC-L2860DWE/MFC-L2860DW/MFC-L2862DW/MFC-L2922DW/MFC-L2960DW/MFC-L2980DW

1. Press  [Settings] > [All Settings] > [Network] > [E-mail/IFAX] > [Setup Mail TX] > [Notification].
2. Select [On] or [Off] to enable or disable the Send Notification feature.
When Send Notification is On, the fax includes an additional field, named Message Disposition Notification (MDN), that contains message delivery information.



Your fax recipient's machine must support the MDN field in order to send a notification report.

3. Press .

✓ Related Information

- [Internet Fax \(I-Fax\) Verification Mail](#)

Enable Receive Notification for TX Verification Mail

Related Models: MFC-L2802DN/MFC-L2800DW/MFC-L2802DW/MFC-L2827DWXL/MFC-L2827DW/
MFC-L2835DW/MFC-L2860DWE/MFC-L2860DW/MFC-L2862DW/MFC-L2922DW/MFC-L2960DW/
MFC-L2980DW

>> MFC-L2802DN/MFC-L2800DW/MFC-L2802DW/MFC-L2827DWXL/MFC-L2827DW/MFC-L2835DW
>> MFC-L2860DWE/MFC-L2860DW/MFC-L2862DW/MFC-L2922DW/MFC-L2960DW/MFC-L2980DW

MFC-L2802DN/MFC-L2800DW/MFC-L2802DW/MFC-L2827DWXL/MFC-L2827DW/ MFC-L2835DW

1. Press **Menu**.
2. Press **▲** or **▼** to display the [Network] option, and then press **OK**.
3. Press **▲** or **▼** to display the [E-mail/IFAX] option, and then press **OK**.
4. Press **▲** or **▼** to display the [Setup Mail RX] option, and then press **OK**.
5. Press **▲** or **▼** to display the [Notification] option, and then press **OK**.
6. Press one of the three possible settings:

| Option | Description |
|--------------------------|------------------------------------------------------------------------------------------------------------------------------------------------------------------------------------------------------------------------------------------------------------------|
| Receive Notification On | When Receive Notification is On, a template is sent back to the sender to indicate successful reception and processing of the message. These templates depend on the operation requested by the sender. Example: SUCCESS : Received From <Mail Address> |
| Receive Notification MDN | When Receive Notification is MDN, a report to indicate successful reception and processing is sent back to the sender if the originating station sent a request confirmation to the MDN (Message Disposition Notification) field. |
| Receive Notification Off | When Receive Notification is Off, all forms of receive notification are disabled and no message is sent back to the sender regardless of the request. |



- To send TX verification mail, the Sender must configure these settings:
 - Switch [Notification] in [Setup Mail TX] to [On].
 - Switch [Header] in [Setup Mail RX] to [All] or [Subject+From+To].
- To receive TX verification mail, the Receiver must configure these settings:
Switch [Notification] in [Setup Mail RX] to [On].

7. Press **Stop/Exit**.

MFC-L2860DWE/MFC-L2860DW/MFC-L2862DW/MFC-L2922DW/MFC-L2960DW/ MFC-L2980DW

1. Press  [Settings] > [All Settings] > [Network] > [E-mail/IFAX] > [Setup Mail RX] > [Notification].
2. Press one of the three possible settings:

| Option | Description |
|--------------------------|------------------------------------------------------------------------------------------------------------------------------------------------------------------------------------------------------------------------------------------------------------------|
| Receive Notification On | When Receive Notification is On, a template is sent back to the sender to indicate successful reception and processing of the message. These templates depend on the operation requested by the sender. Example: SUCCESS : Received From <Mail Address> |
| Receive Notification MDN | When Receive Notification is MDN, a report to indicate successful reception and processing is sent back to the sender if the originating station sent a request confirmation to the MDN (Message Disposition Notification) field. |
| Receive Notification Off | When Receive Notification is Off, all forms of receive notification are disabled and no message is sent back to the sender regardless of the request. |



- To send TX verification mail, the Sender must configure these settings:
 - Switch [Notification] in [Setup Mail TX] to [On].
 - Switch [Header] in [Setup Mail RX] to [All] or [Subject+From+To].
- To receive TX verification mail, the Receiver must configure these settings:
Switch [Notification] in [Setup Mail RX] to [On].

3. Press .



Related Information

- [Internet Fax \(I-Fax\) Verification Mail](#)

I-Fax Error Mail

Related Models: MFC-L2802DN/MFC-L2800DW/MFC-L2802DW/MFC-L2827DWXL/MFC-L2827DW/MFC-L2835DW/MFC-L2860DWE/MFC-L2860DW/MFC-L2862DW/MFC-L2922DW/MFC-L2960DW/MFC-L2980DW

If there is a delivery error while sending an I-Fax, the mail server will send an error message back to the Brother machine and the error message will be printed.

If there is an error while receiving an I-Fax, an error message will be printed, for example, "The message being sent to the machine was not in a TIFF format."

To receive the error mail and have these printed on your machine, in [Setup Mail RX], switch the [Header] option to [All] or to [Subject+From+To].



Related Information

- [Internet Fax \(I-Fax\) Verification Mail](#)

Use the Send Fax to Server Feature

Related Models: MFC-L2802DN/MFC-L2800DW/MFC-L2802DW/MFC-L2827DWXL/MFC-L2827DW/
MFC-L2835DW/MFC-L2860DWE/MFC-L2860DW/MFC-L2862DW/MFC-L2922DW/MFC-L2960DW/
MFC-L2980DW

The Fax to Server feature allows the machine to scan a document and send it over the network to a separate fax server. The document will then be sent from the server as fax data to the destination fax number over standard phone lines. When the Fax to Server feature is set to On, all automatic fax transmissions from the machine will be sent to the fax server for fax transmission.

You can send a fax directly from the machine using the manual fax feature when the Send to Server feature is on.



Related Information

- [Network Features](#)
 - [Before Sending a Fax to the Fax Server](#)
 - [Enable Fax to Server](#)
 - [Operate Fax to Server](#)

Before Sending a Fax to the Fax Server

Related Models: MFC-L2802DN/MFC-L2800DW/MFC-L2802DW/MFC-L2827DWXL/MFC-L2827DW/MFC-L2835DW/MFC-L2860DWE/MFC-L2860DW/MFC-L2862DW/MFC-L2922DW/MFC-L2960DW/MFC-L2980DW

To send a document to the fax server, the correct syntax for that server must be used. The destination fax number must be sent with a prefix and a suffix that match the parameters used by the fax server. In most cases, the syntax for the prefix is “fax=” and the syntax for the suffix would be the domain name of the fax server email gateway. The suffix must also include the “@” symbol at the beginning of the suffix. The prefix and the suffix information must be stored in the machine before you can use the Fax to Server function. Destination fax numbers can be saved in the address book or entered using the dial pad (up to 40-digit numbers). For example: if you wanted to send a document to a destination fax number of 123-555-0001, use the following syntax:

Prefix Suffix

fax=123-555-0001@faxserver.companyname.com

Destination fax number



Your fax server application must support an email gateway.



Related Information

- [Use the Send Fax to Server Feature](#)

Enable Fax to Server

Related Models: MFC-L2802DN/MFC-L2800DW/MFC-L2802DW/MFC-L2827DWXL/MFC-L2827DW/
MFC-L2835DW/MFC-L2860DWE/MFC-L2860DW/MFC-L2862DW/MFC-L2922DW/MFC-L2960DW/
MFC-L2980DW

>> MFC-L2802DN/MFC-L2800DW/MFC-L2802DW/MFC-L2827DWXL/MFC-L2827DW/MFC-L2835DW
>> MFC-L2860DWE/MFC-L2860DW/MFC-L2862DW/MFC-L2922DW/MFC-L2960DW/MFC-L2980DW



MFC-L2802DN/MFC-L2800DW/MFC-L2802DW/MFC-L2827DWXL/MFC-L2827DW/ MFC-L2835DW

Store the prefix/suffix address for the fax server in your Brother machine.

1. Press **Menu**.
2. Press **▲** or **▼** to display the [Network] option, and then press **OK**.
3. Press **▲** or **▼** to display the [Fax to Server] option, and then press **OK**.
4. Press **▲** or **▼** to display the [On] option, and then press **OK**.
5. Press **▲** or **▼** to display the [Prefix] option, and then press **OK**.
6. Enter the prefix using the machine's control panel, and then press **OK**.
7. Press **▲** or **▼** to display the [Suffix] option, and then press **OK**.
8. Enter the suffix using the machine's control panel, and then press **OK**.
9. Press **Stop/Exit**.

MFC-L2860DWE/MFC-L2860DW/MFC-L2862DW/MFC-L2922DW/MFC-L2960DW/ MFC-L2980DW

Store the prefix/suffix address for the fax server in your Brother machine.

1. Press  [Settings] > [All Settings] > [Network] > [Fax to Server].
2. Press [Fax to Server], and then press [On].
3. Press [Prefix].
4. Enter the prefix using the keyboard on the LCD, and then press [OK].
5. Press [Suffix].
6. Enter the suffix using the keyboard on the LCD, and then press [OK].
7. Press .

Related Information

- [Use the Send Fax to Server Feature](#)

Operate Fax to Server

Related Models: MFC-L2802DN/MFC-L2800DW/MFC-L2802DW/MFC-L2827DWXL/MFC-L2827DW/
MFC-L2835DW/MFC-L2860DWE/MFC-L2860DW/MFC-L2862DW/MFC-L2922DW/MFC-L2960DW/
MFC-L2980DW

>> [MFC-L2802DN/MFC-L2800DW/MFC-L2802DW/MFC-L2827DWXL/MFC-L2827DW/MFC-L2835DW](#)
>> [MFC-L2860DWE/MFC-L2860DW/MFC-L2862DW/MFC-L2922DW/MFC-L2960DW/MFC-L2980DW](#)

MFC-L2802DN/MFC-L2800DW/MFC-L2802DW/MFC-L2827DWXL/MFC-L2827DW/ MFC-L2835DW

1. Place the document in the ADF or on the scanner glass.
2. Enter the fax number.
3. Press **Start**.

The machine will send the message over a TCP/IP network to the fax server.

MFC-L2860DWE/MFC-L2860DW/MFC-L2862DW/MFC-L2922DW/MFC-L2960DW/ MFC-L2980DW

1. Place the document in the ADF or on the scanner glass.
2. Enter the fax number.
3. Press [Fax Start].

The machine will send the message over a TCP/IP network to the fax server.

Related Information

- [Use the Send Fax to Server Feature](#)

Synchronise Time with the SNTP Server Using Web Based Management

Related Models: DCP-L2620DW/DCP-L2622DW/DCP-L2627DW/DCP-L2627DWXL/DCP-L2627DWE/DCP-L2640DN/DCP-L2660DW/DCP-L2665DW/MFC-L2802DN/MFC-L2800DW/MFC-L2802DW/MFC-L2827DWXL/MFC-L2827DW/MFC-L2835DW/MFC-L2860DWE/MFC-L2860DW/MFC-L2862DW/MFC-L2922DW/MFC-L2960DW/MFC-L2980DW

The Simple Network Time Protocol (SNTP) is used to synchronise the time used by the machine for authentication with the SNTP time server. (This is not the time displayed on the machine's LCD.) You can automatically or manually synchronise the machine's time with the Coordinated Universal Time (UTC) provided by the SNTP time server.

- [Configure Date and Time Using Web Based Management](#)
- [Configure the SNTP Protocol Using Web Based Management](#)

Configure Date and Time Using Web Based Management

Related Models: DCP-L2620DW/DCP-L2622DW/DCP-L2627DW/DCP-L2627DWXL/DCP-L2627DWE/DCP-L2640DN/DCP-L2660DW/DCP-L2665DW/MFC-L2802DN/MFC-L2800DW/MFC-L2802DW/MFC-L2827DWXL/MFC-L2827DW/MFC-L2835DW/MFC-L2860DWE/MFC-L2860DW/MFC-L2862DW/MFC-L2922DW/MFC-L2960DW/MFC-L2980DW

Configure date and time to synchronise the time used by the machine with the SNTP time server.

This feature is not available in some countries.

1. Start your web browser.
2. Type "https://machine's IP address" in your browser's address bar (where "machine's IP address" is your machine's IP address).

For example:

https://192.168.1.2

3. If required, type the password in the **Login** field, and then click **Login**.



The default password to manage this machine's settings is located on the back of the machine and marked "**Pwd**". Change the default password by following the on-screen instructions when you first log in.

4. In the left navigation bar, click **Administrator** > **Date&Time**.



If the left navigation bar is not visible, start navigating from .

5. Verify the **Time Zone** settings.



Select the time difference between your location and UTC from the **Time Zone** drop-down list. For example, the time zone for Eastern Time in the USA and Canada is UTC-05:00.

6. Select the **Synchronize with SNTP server** checkbox.
7. Click **Submit**.



You can also configure date and time manually.



Related Information

- [Synchronise Time with the SNTP Server Using Web Based Management](#)

Related Topics:

- [Register Your Machine with Universal Print Using Web Based Management](#)

Configure the SNTP Protocol Using Web Based Management

Related Models: DCP-L2620DW/DCP-L2622DW/DCP-L2627DW/DCP-L2627DWXL/DCP-L2627DWE/DCP-L2640DN/DCP-L2660DW/DCP-L2665DW/MFC-L2802DN/MFC-L2800DW/MFC-L2802DW/MFC-L2827DWXL/MFC-L2827DW/MFC-L2835DW/MFC-L2860DWE/MFC-L2860DW/MFC-L2862DW/MFC-L2922DW/MFC-L2960DW/MFC-L2980DW

Configure the SNTP protocol to synchronise the time the machine uses for authentication with the time kept by the SNTP time server.

1. Start your web browser.
2. Type "https://machine's IP address" in your browser's address bar (where "machine's IP address" is your machine's IP address).

For example:

https://192.168.1.2

3. If required, type the password in the **Login** field, and then click **Login**.



The default password to manage this machine's settings is located on the back of the machine and marked "Pwd". Change the default password by following the on-screen instructions when you first log in.

4. In the left navigation bar, click **Network > Network > Protocol**.



If the left navigation bar is not visible, start navigating from .

5. Select the **SNTP** checkbox to activate the settings.
6. Click **Submit**.
7. Restart your Brother machine to activate the configuration.
8. Next to the SNTP checkbox, click **Advanced Settings**.
9. Configure the settings.

| Option | Description |
|----------------------------------------------------------------------------|---------------------------------------------------------------------------------------------------------------------------------------------------------------------------------------------------------------------------------------------------------------------------------------------|
| Status | Displays whether the SNTP protocol is enabled or disabled. |
| Synchronization Status | Confirm the latest synchronisation status. |
| SNTP Server Method | Select AUTO or STATIC . <ul style="list-style-type: none"> • AUTO If you have a DHCP server on your network, the SNTP server will obtain the address from that server automatically. • STATIC Type the address you want to use. |
| Primary SNTP Server Address Secondary SNTP Server Address | Type the server's address (up to 64 characters). The secondary SNTP server's address is used as a backup to the primary SNTP server's address. If the primary server is unavailable, the machine will contact the secondary SNTP server. |
| Primary SNTP Server Port Secondary SNTP Server Port | Type the port number (1-65535). The secondary SNTP server port is used as a backup to the primary SNTP server port. If the primary port is unavailable, the machine will contact the secondary SNTP port. |
| Synchronization Interval | Type the number of hours between server synchronisation attempts (1-168 hours). |

10. Click **Submit**.



Related Information

- [Synchronise Time with the SNTP Server Using Web Based Management](#)

Forward Incoming Faxes to a Network Destination

Related Models: MFC-L2922DW/MFC-L2960DW/MFC-L2980DW

Set up a profile to forward incoming faxes directly to a folder on an FTP or CIFS server.

- We recommend using the latest version of the following web browsers:
 - Microsoft Edge, Firefox, and Google Chrome™ for Windows
 - Safari, Firefox, and Google Chrome™ for Mac
 - Google Chrome™ for Android™
 - Safari and Google Chrome™ for iOS
- Ensure that JavaScript and Cookies are always enabled, regardless of which browser you use.

1. Start your web browser.
2. Type "https://machine's IP address" in your browser's address bar (where "machine's IP address" is your machine's IP address).

For example:

https://192.168.1.2

3. If required, type the password in the **Login** field, and then click **Login**.

 The default password to manage this machine's settings is located on the back of the machine and marked "Pwd". Change the default password by following the on-screen instructions when you first log in.

4. In the left navigation bar, click **Administrator > Network Profile**.

 If the left navigation bar is not visible, start navigating from ☰.

5. Click the protocol option next to the Profile number.
6. Select the **FTP** or **Network** option, and then click **Submit**.
7. Set up the profile for your server, using one of the following tables:

 Using the following characters: ?, /, \, ", :, <, >, | or * may cause a sending error.

FTP

| Option | Description |
|---------------------|------------------------------------------------------------------------------------------------------------------------------------------------------------------------------|
| Profile Name | Type a name for this server profile (up to 15 alphanumeric characters). The machine will display this name on the LCD. |
| Host Address | Type the Host Address (for example: ftp.example.com; up to 64 characters) or the IP address (for example: 192.23.56.189). |
| Port Number | Change the Port Number setting used to access the FTP server. The default setting is port 21. In most cases this setting does not need to be changed. |
| Username | Type a user name (up to 32 characters) of a user that has permission to write data to the FTP server. |
| Password | Type the password (up to 32 characters) associated with the user name you entered in the Username field. Type the password again in the Retype password field. |
| SSL/TLS | Set the SSL/TLS option to forward incoming faxes securely using SSL/TLS communication. Change the CA Certificate setting, if needed. |

| Option | Description |
|------------------------|------------------------------------------------------------------------------------------------------------------------------------------------------------------------------------------------------|
| Store Directory | Type the path (up to 255 characters) to the folder on the FTP server where you want to forward incoming faxes. Do not type a slash mark at the beginning of the path (correct example: brother/abc). |
| Passive Mode | Set the Passive Mode option to off or on depending on your FTP server and network firewall configuration. The default setting is on. In most cases, this setting does not need to be changed. |

Network

| Option | Description |
|--------------------------------|--------------------------------------------------------------------------------------------------------------------------------------------------------------------------------------------------------------------------------------------------------------------------------|
| Profile Name | Type a name for this server profile (up to 15 alphanumeric characters). The machine will display this name on the LCD. |
| Network Folder Path | Type the path to the folder on the CIFS server where you want to forward incoming faxes. |
| Auth. Method | To set your authentication method, select Auto , Kerberos , or NTLMv2 . |
| Username | Type a user name (up to 96 characters) that has permission to write data to the folder specified in the Network Folder Path field. If the user name is part of a domain, type the user name in one of the following styles: user@domain domain\user |
| Password | Type the password (up to 32 characters) associated with the user name you entered in the Username field. Type the password again in the Retype password field. |
| Kerberos Server Address | When you select Kerberos for the Auth. Method option, you must type the Kerberos Server Address (for example: kerberos.example.com; up to 64 characters). |



You must configure the SNTP (network time server) or you must set the date, time and time zone correctly on the control panel. The time must match the time used by the Kerberos Server and CIFS Server.

8. Click **Submit**.
9. To set the Fax Forward feature, in the left navigation bar, click **Fax > Remote Fax Options**.
10. Select **Forward to Network** from the **Fwd/Store/Cloud/Network** drop-down list.
11. Select the file type you want to use.
12. To print a backup copy of incoming faxes, select **On** for **Backup print**.
13. Select the profile you want to use from the **Network Profile** drop-down list.
14. Type a three-digit Remote Access Code in the **Remote Access Code** field, if needed.



- You can use the numbers 0 through 9, *, or # for the Remote Access Code.
- The Remote Access Code must be different from the remote codes for the Fax features.

15. Click **Submit**.



Related Information

- [Memory Receive Options](#)
- [Network Features](#)

Reset the Network Settings to the Factory Settings

Related Models: DCP-L2620DW/DCP-L2622DW/DCP-L2627DW/DCP-L2627DWXL/DCP-L2627DWE/
DCP-L2640DN/DCP-L2660DW/DCP-L2665DW/MFC-L2802DN/MFC-L2800DW/MFC-L2802DW/
MFC-L2827DWXL/MFC-L2827DW/MFC-L2835DW/MFC-L2860DWE/MFC-L2860DW/MFC-L2862DW/
MFC-L2922DW/MFC-L2960DW/MFC-L2980DW

Use your machine's control panel to reset the machine's network settings to its default factory settings. This resets all information except the administrator password.



You can also reset the print server to its factory settings using Web Based Management.

>> DCP-L2620DW/DCP-L2622DW/DCP-L2627DW/DCP-L2627DWXL/DCP-L2627DWE/DCP-L2640DN/
MFC-L2802DN/MFC-L2800DW/MFC-L2802DW/MFC-L2827DWXL/MFC-L2827DW/MFC-L2835DW
>> DCP-L2660DW/DCP-L2665DW/MFC-L2860DWE/MFC-L2860DW/MFC-L2862DW/MFC-L2922DW/
MFC-L2960DW/MFC-L2980DW

**DCP-L2620DW/DCP-L2622DW/DCP-L2627DW/DCP-L2627DWXL/DCP-L2627DWE/
DCP-L2640DN/MFC-L2802DN/MFC-L2800DW/MFC-L2802DW/MFC-L2827DWXL/
MFC-L2827DW/MFC-L2835DW**

1. Press **Menu**.
2. Press **▲** or **▼** to display the [Network] option, and then press **OK**.
3. Press **▲** or **▼** to display the [Network Reset] option, and then press **OK**.
4. Follow the machine's instruction to reset the network settings.

The machine will restart.

**DCP-L2660DW/DCP-L2665DW/MFC-L2860DWE/MFC-L2860DW/MFC-L2862DW/
MFC-L2922DW/MFC-L2960DW/MFC-L2980DW**

1. Press  [Settings] > [All Settings] > [Network] > [Network Reset].
2. [Machine will reboot after resetting. Press [OK] for 2 seconds to confirm.] will be displayed. Press [OK] for two seconds to confirm.

The machine will restart.

✓ Related Information

- [Network Features](#)

Related Topics:

- [Reset Your Machine](#)

Security

Related Models: DCP-L2620DW/DCP-L2622DW/DCP-L2627DW/DCP-L2627DWXL/DCP-L2627DWE/DCP-L2640DN/DCP-L2660DW/DCP-L2665DW/MFC-L2802DN/MFC-L2800DW/MFC-L2802DW/MFC-L2827DWXL/MFC-L2827DW/MFC-L2835DW/MFC-L2860DWE/MFC-L2860DW/MFC-L2862DW/MFC-L2922DW/MFC-L2960DW/MFC-L2980DW

- [Before Using Network Security Features](#)
- [Configure Certificates for Device Security](#)
- [Use SSL/TLS](#)
- [Use SNMPv3](#)
- [Use IPsec](#)
- [Use IEEE 802.1x Authentication](#)
- [Use Active Directory Authentication](#)
- [Use LDAP Authentication](#)
- [Use Secure Function Lock 3.0](#)
- [Send or Receive an Email Securely](#)
- [Store Print Log to Network](#)
- [Lock the Machine Settings from the Control Panel](#)
- [Use Global Network Detection Features](#)

Before Using Network Security Features

Related Models: DCP-L2620DW/DCP-L2622DW/DCP-L2627DW/DCP-L2627DWXL/DCP-L2627DWE/DCP-L2640DN/DCP-L2660DW/DCP-L2665DW/MFC-L2802DN/MFC-L2800DW/MFC-L2802DW/MFC-L2827DWXL/MFC-L2827DW/MFC-L2835DW/MFC-L2860DWE/MFC-L2860DW/MFC-L2862DW/MFC-L2922DW/MFC-L2960DW/MFC-L2980DW

Your machine employs some of the latest network security and encryption protocols available today. These network features can be integrated into your overall network security plan to help protect your data and prevent unauthorised access to the machine.



We recommend disabling the FTP server and TFTP protocols. Accessing the machine using these protocols is not secure. However, note that if you disable FTP server, the Scan to FTP feature will be disabled.



Related Information

- [Security](#)
 - [Disable Unnecessary Protocols](#)

Disable Unnecessary Protocols

Related Models: DCP-L2620DW/DCP-L2622DW/DCP-L2627DW/DCP-L2627DWXL/DCP-L2627DWE/DCP-L2640DN/DCP-L2660DW/DCP-L2665DW/MFC-L2802DN/MFC-L2800DW/MFC-L2802DW/MFC-L2827DWXL/MFC-L2827DW/MFC-L2835DW/MFC-L2860DWE/MFC-L2860DW/MFC-L2862DW/MFC-L2922DW/MFC-L2960DW/MFC-L2980DW

1. Start your web browser.
2. Type "https://machine's IP address" in your browser's address bar (where "machine's IP address" is your machine's IP address).

For example:

https://192.168.1.2

3. If required, type the password in the **Login** field, and then click **Login**.



The default password to manage this machine's settings is located on the back of the machine and marked "Pwd". Change the default password by following the on-screen instructions when you first log in.

4. In the left navigation bar, click **Network > Network > Protocol**.



If the left navigation bar is not visible, start navigating from ☰.

5. Clear any unnecessary protocol checkboxes to disable them.
6. Click **Submit**.
7. Restart your Brother machine to activate the configuration.



Related Information

- [Before Using Network Security Features](#)

Configure Certificates for Device Security

Related Models: DCP-L2620DW/DCP-L2622DW/DCP-L2627DW/DCP-L2627DWXL/DCP-L2627DWE/
DCP-L2640DN/DCP-L2660DW/DCP-L2665DW/MFC-L2802DN/MFC-L2800DW/MFC-L2802DW/
MFC-L2827DWXL/MFC-L2827DW/MFC-L2835DW/MFC-L2860DWE/MFC-L2860DW/MFC-L2862DW/
MFC-L2922DW/MFC-L2960DW/MFC-L2980DW

You must configure a certificate to manage your networked machine securely using SSL/TLS. You must use Web Based Management to configure a certificate.

- [Supported Security Certificate Features](#)
- [How to Create and Install a Certificate](#)
- [Create a Self-signed Certificate](#)
- [Create a Certificate Signing Request \(CSR\) and Install a Certificate from a Certificate Authority \(CA\)](#)
- [Import and Export the Certificate and Private Key](#)
- [Import and Export a CA Certificate](#)
- [Manage Multiple Certificates](#)

Supported Security Certificate Features

Related Models: DCP-L2620DW/DCP-L2622DW/DCP-L2627DW/DCP-L2627DWXL/DCP-L2627DWE/DCP-L2640DN/DCP-L2660DW/DCP-L2665DW/MFC-L2802DN/MFC-L2800DW/MFC-L2802DW/MFC-L2827DWXL/MFC-L2827DW/MFC-L2835DW/MFC-L2860DWE/MFC-L2860DW/MFC-L2862DW/MFC-L2922DW/MFC-L2960DW/MFC-L2980DW

Your machine supports the use of multiple security certificates, which allows secure management, authentication, and communication with the machine. The following security certificate features can be used with the machine:

- SSL/TLS communication
- SSL communication for SMTP/POP3/IMAP4 (only available for certain models)
- IEEE 802.1x authentication
- IPsec

Your machine supports the following:

- Pre-installed certificate

Your machine has a pre-installed self-signed certificate. This certificate enables you to use SSL/TLS communication without creating or installing a different certificate.



The pre-installed self-signed certificate protects your communication up to a certain level. We recommend using a certificate that is issued by a trusted organisation for better security.

- Self-signed certificate

This print server issues its own certificate. Using this certificate, you can easily use the SSL/TLS communication without creating or installing a different certificate from a CA.

- Certificate from a Certificate Authority (CA)

There are two methods for installing a certificate from a CA. If you already have a certificate from a CA or if you want to use a certificate from an external trusted CA:

- When using a Certificate Signing Request (CSR) from this print server.
- When importing a certificate and a private key.

- Certificate Authority (CA) Certificate

To use a CA certificate that identifies the CA and owns its private key, you must import that CA certificate from the CA before configuring the security features of the Network.



- If you are going to use SSL/TLS communication, we recommend contacting your system administrator first.
 - When you reset the print server back to its default factory settings, the certificate and the private key that are installed will be deleted. If you want to keep the same certificate and the private key after resetting the print server, export them before resetting, and then reinstall them.
-



Related Information

- [Configure Certificates for Device Security](#)
-

How to Create and Install a Certificate

Related Models: DCP-L2620DW/DCP-L2622DW/DCP-L2627DW/DCP-L2627DWXL/DCP-L2627DWE/
DCP-L2640DN/DCP-L2660DW/DCP-L2665DW/MFC-L2802DN/MFC-L2800DW/MFC-L2802DW/
MFC-L2827DWXL/MFC-L2827DW/MFC-L2835DW/MFC-L2860DWE/MFC-L2860DW/MFC-L2862DW/
MFC-L2922DW/MFC-L2960DW/MFC-L2980DW

There are two options when choosing a security certificate: use a self-signed certificate or use a certificate from a Certificate Authority (CA).

Option 1

Self-Signed Certificate

1. Create a self-signed certificate using Web Based Management.
2. Install the self-signed certificate on your computer.

Option 2

Certificate from a CA

1. Create a Certificate Signing Request (CSR) using Web Based Management.
2. Install the certificate issued by the CA on your Brother machine using Web Based Management.
3. Install the certificate on your computer.



Related Information

- [Configure Certificates for Device Security](#)

Create a Self-signed Certificate

Related Models: DCP-L2620DW/DCP-L2622DW/DCP-L2627DW/DCP-L2627DWXL/DCP-L2627DWE/DCP-L2640DN/DCP-L2660DW/DCP-L2665DW/MFC-L2802DN/MFC-L2800DW/MFC-L2802DW/MFC-L2827DWXL/MFC-L2827DW/MFC-L2835DW/MFC-L2860DWE/MFC-L2860DW/MFC-L2862DW/MFC-L2922DW/MFC-L2960DW/MFC-L2980DW

1. Start your web browser.
2. Type "https://machine's IP address" in your browser's address bar (where "machine's IP address" is your machine's IP address).

For example:

https://192.168.1.2



- If you are using a Domain Name System or enable a NetBIOS name, you can type another name, such as "SharedPrinter" instead of the IP address.

For example: https://SharedPrinter

- If you enable a NetBIOS name, you can also use the node name.
For example: https://brn123456abcdef
- The NetBIOS name can be found in the Network Configuration Report.

3. If required, type the password in the **Login** field, and then click **Login**.



The default password to manage this machine's settings is located on the back of the machine and marked "**Pwd**". Change the default password by following the on-screen instructions when you first log in.

4. In the left navigation bar, click **Network > Security > Certificate**.



If the left navigation bar is not visible, start navigating from ☰.

5. Click **Create Self-Signed Certificate**.
6. Enter a **Common Name** and a **Valid Date**.
 - The length of the **Common Name** is less than 64 bytes. Enter an identifier, such as an IP address, node name, or domain name to use when accessing this machine through SSL/TLS communication. The node name is displayed by default.
 - A warning will appear if you use the IPPS or HTTPS protocol and enter a different name in the URL than the **Common Name** that was used for the self-signed certificate.
7. Select your setting from the **Public Key Algorithm** drop-down list. The default setting is **EC(256bit)**.
8. Select your setting from the **Digest Algorithm** drop-down list. The default setting is **SHA256**.
9. Click **Submit**.



Related Information

- [Configure Certificates for Device Security](#)

Create a Certificate Signing Request (CSR) and Install a Certificate from a Certificate Authority (CA)

Related Models: DCP-L2620DW/DCP-L2622DW/DCP-L2627DW/DCP-L2627DWXL/DCP-L2627DWE/DCP-L2640DN/DCP-L2660DW/DCP-L2665DW/MFC-L2802DN/MFC-L2800DW/MFC-L2802DW/MFC-L2827DWXL/MFC-L2827DW/MFC-L2835DW/MFC-L2860DWE/MFC-L2860DW/MFC-L2862DW/MFC-L2922DW/MFC-L2960DW/MFC-L2980DW

If you already have a certificate from an external trusted Certificate Authority (CA), you can store the certificate and private key on the machine and manage them by importing and exporting. If you do not have a certificate from an external trusted CA, create a Certificate Signing Request (CSR), send it to a CA for authentication, and install the returned certificate on your machine.

- [Create a Certificate Signing Request \(CSR\)](#)
- [Install a Certificate on Your Machine](#)

Create a Certificate Signing Request (CSR)

Related Models: DCP-L2620DW/DCP-L2622DW/DCP-L2627DW/DCP-L2627DWXL/DCP-L2627DWE/DCP-L2640DN/DCP-L2660DW/DCP-L2665DW/MFC-L2802DN/MFC-L2800DW/MFC-L2802DW/MFC-L2827DWXL/MFC-L2827DW/MFC-L2835DW/MFC-L2860DWE/MFC-L2860DW/MFC-L2862DW/MFC-L2922DW/MFC-L2960DW/MFC-L2980DW

A Certificate Signing Request (CSR) is a request sent to a Certificate Authority (CA) to authenticate the credentials contained within the certificate.

We recommend installing a Root Certificate from the CA on your computer before creating the CSR.

1. Start your web browser.
2. Type "https://machine's IP address" in your browser's address bar (where "machine's IP address" is your machine's IP address).

For example:

https://192.168.1.2



- If you are using a Domain Name System or enable a NetBIOS name, you can type another name, such as "SharedPrinter" instead of the IP address.

For example: https://SharedPrinter

- If you enable a NetBIOS name, you can also use the node name.

For example: https://brn123456abcdef

- The NetBIOS name can be found in the Network Configuration Report.

3. If required, type the password in the **Login** field, and then click **Login**.



The default password to manage this machine's settings is located on the back of the machine and marked "**Pwd**". Change the default password by following the on-screen instructions when you first log in.

4. In the left navigation bar, click **Network > Security > Certificate**.



If the left navigation bar is not visible, start navigating from .

5. Click **Create CSR**.

6. Type a **Common Name** (required) and add other information about your **Organization** (optional).



- Your company details are required so that a CA can confirm your identity and verify it to the outside world.
- The length of the **Common Name** must be less than 64 bytes. Enter an identifier, such as an IP address, node name, or domain name to use when accessing this machine through SSL/TLS communication. The node name is displayed by default. The **Common Name** is required.
- A warning will appear if you type a different name in the URL than the Common Name that was used for the certificate.
- The length of the **Organization**, the **Organization Unit**, the **City/Locality**, and the **State/Province** must be less than 64 bytes.
- The **Country/Region** should be a two-character ISO 3166 country code.
- If you are configuring an X.509v3 certificate extension, select the **Configure extended partition** checkbox, and then select **Auto (Register IPv4)** or **Manual**.

7. Select your setting from the **Public Key Algorithm** drop-down list. The default setting is **EC(256bit)**.

8. Select your setting from the **Digest Algorithm** drop-down list. The default setting is **SHA256**.

9. Click **Submit**.

The CSR appears on your screen. Save the CSR as a file or copy and paste it into an online CSR form offered by a Certificate Authority.

10. Click **Save**.



-
- Follow your CA's policy regarding the method to send a CSR to your CA.
 - If you are using the Enterprise root CA of Windows Server 2012/2012 R2/2016/2019/2022, we recommend using the Web Server for the certificate template to securely create the Client Certificate. If you are creating a Client Certificate for an IEEE 802.1x environment with EAP-TLS authentication, we recommend using User for the certificate template.
-



Related Information

- [Create a Certificate Signing Request \(CSR\) and Install a Certificate from a Certificate Authority \(CA\)](#)
-

Install a Certificate on Your Machine

Related Models: DCP-L2620DW/DCP-L2622DW/DCP-L2627DW/DCP-L2627DWXL/DCP-L2627DWE/DCP-L2640DN/DCP-L2660DW/DCP-L2665DW/MFC-L2802DN/MFC-L2800DW/MFC-L2802DW/MFC-L2827DWXL/MFC-L2827DW/MFC-L2835DW/MFC-L2860DWE/MFC-L2860DW/MFC-L2862DW/MFC-L2922DW/MFC-L2960DW/MFC-L2980DW

When you receive a certificate from a Certificate Authority (CA), follow the steps below to install it on the print server:

Only a certificate issued with your machine's Certificate Signing Request (CSR) can be installed on your machine. When you want to create another CSR, make sure that the certificate is installed before creating the new CSR. Create another CSR only after installing the certificate on the machine, otherwise the CSR created before installing the new CSR will be invalid.

1. Start your web browser.
2. Type "https://machine's IP address" in your browser's address bar (where "machine's IP address" is your machine's IP address).

For example:

https://192.168.1.2



- If you are using a Domain Name System or enable a NetBIOS name, you can type another name, such as "SharedPrinter" instead of the IP address.

For example: https://SharedPrinter

- If you enable a NetBIOS name, you can also use the node name.

For example: https://brn123456abcdef

- The NetBIOS name can be found in the Network Configuration Report.

3. If required, type the password in the **Login** field, and then click **Login**.



The default password to manage this machine's settings is located on the back of the machine and marked "Pwd". Change the default password by following the on-screen instructions when you first log in.

4. In the left navigation bar, click **Network > Security > Certificate**.



If the left navigation bar is not visible, start navigating from ☰.

5. Click **Install Certificate**.
6. Browse to the file that contains the certificate issued by the CA, and then click **Submit**.

The certificate has been created and saved in your machine's memory successfully.

To use SSL/TLS communication, the Root Certificate from the CA must be installed on your computer. Contact your network administrator.



Related Information

- [Create a Certificate Signing Request \(CSR\) and Install a Certificate from a Certificate Authority \(CA\)](#)

Import and Export the Certificate and Private Key

Related Models: DCP-L2620DW/DCP-L2622DW/DCP-L2627DW/DCP-L2627DWXL/DCP-L2627DWE/DCP-L2640DN/DCP-L2660DW/DCP-L2665DW/MFC-L2802DN/MFC-L2800DW/MFC-L2802DW/MFC-L2827DWXL/MFC-L2827DW/MFC-L2835DW/MFC-L2860DWE/MFC-L2860DW/MFC-L2862DW/MFC-L2922DW/MFC-L2960DW/MFC-L2980DW

Store the certificate and private key on your machine and manage them by importing and exporting them.

- [Import a Certificate and Private Key](#)
- [Export the Certificate and Private Key](#)

Import a Certificate and Private Key

Related Models: DCP-L2620DW/DCP-L2622DW/DCP-L2627DW/DCP-L2627DWXL/DCP-L2627DWE/DCP-L2640DN/DCP-L2660DW/DCP-L2665DW/MFC-L2802DN/MFC-L2800DW/MFC-L2802DW/MFC-L2827DWXL/MFC-L2827DW/MFC-L2835DW/MFC-L2860DWE/MFC-L2860DW/MFC-L2862DW/MFC-L2922DW/MFC-L2960DW/MFC-L2980DW

1. Start your web browser.
2. Type "https://machine's IP address" in your browser's address bar (where "machine's IP address" is your machine's IP address).

For example:

https://192.168.1.2



- If you are using a Domain Name System or enable a NetBIOS name, you can type another name, such as "SharedPrinter" instead of the IP address.

For example: https://SharedPrinter

- If you enable a NetBIOS name, you can also use the node name.
For example: https://brn123456abcdef
- The NetBIOS name can be found in the Network Configuration Report.

3. If required, type the password in the **Login** field, and then click **Login**.



The default password to manage this machine's settings is located on the back of the machine and marked "Pwd". Change the default password by following the on-screen instructions when you first log in.

4. In the left navigation bar, click **Network > Security > Certificate**.



If the left navigation bar is not visible, start navigating from ☰.

5. Click **Import Certificate and Private Key**.
6. Browse to the file you want to import.
7. Type the password if the file is encrypted, and then click **Submit**.

The certificate and private key are imported to your machine.



Related Information

- [Import and Export the Certificate and Private Key](#)

Export the Certificate and Private Key

Related Models: DCP-L2620DW/DCP-L2622DW/DCP-L2627DW/DCP-L2627DWXL/DCP-L2627DWE/DCP-L2640DN/DCP-L2660DW/DCP-L2665DW/MFC-L2802DN/MFC-L2800DW/MFC-L2802DW/MFC-L2827DWXL/MFC-L2827DW/MFC-L2835DW/MFC-L2860DWE/MFC-L2860DW/MFC-L2862DW/MFC-L2922DW/MFC-L2960DW/MFC-L2980DW

1. Start your web browser.
2. Type "https://machine's IP address" in your browser's address bar (where "machine's IP address" is your machine's IP address).

For example:

https://192.168.1.2



- If you are using a Domain Name System or enable a NetBIOS name, you can type another name, such as "SharedPrinter" instead of the IP address.

For example: https://SharedPrinter

- If you enable a NetBIOS name, you can also use the node name.
For example: https://brn123456abcdef
- The NetBIOS name can be found in the Network Configuration Report.

3. If required, type the password in the **Login** field, and then click **Login**.



The default password to manage this machine's settings is located on the back of the machine and marked "Pwd". Change the default password by following the on-screen instructions when you first log in.

4. In the left navigation bar, click **Network > Security > Certificate**.



If the left navigation bar is not visible, start navigating from ☰.

5. Click **Export** shown with **Certificate List**.
6. Enter the password if you want to encrypt the file.
If a blank password is used, the output is not encrypted.
7. Enter the password again for confirmation, and then click **Submit**.
8. Click **Save**.

The certificate and private key are exported to your computer.

You can also import the certificate to your computer.



Related Information

- [Import and Export the Certificate and Private Key](#)

Import and Export a CA Certificate

Related Models: DCP-L2620DW/DCP-L2622DW/DCP-L2627DW/DCP-L2627DWXL/DCP-L2627DWE/
DCP-L2640DN/DCP-L2660DW/DCP-L2665DW/MFC-L2802DN/MFC-L2800DW/MFC-L2802DW/
MFC-L2827DWXL/MFC-L2827DW/MFC-L2835DW/MFC-L2860DWE/MFC-L2860DW/MFC-L2862DW/
MFC-L2922DW/MFC-L2960DW/MFC-L2980DW

You can import, export, and store CA certificates on your Brother machine.

- [Import a CA Certificate](#)
- [Export a CA Certificate](#)

Import a CA Certificate

Related Models: DCP-L2620DW/DCP-L2622DW/DCP-L2627DW/DCP-L2627DWXL/DCP-L2627DWE/DCP-L2640DN/DCP-L2660DW/DCP-L2665DW/MFC-L2802DN/MFC-L2800DW/MFC-L2802DW/MFC-L2827DWXL/MFC-L2827DW/MFC-L2835DW/MFC-L2860DWE/MFC-L2860DW/MFC-L2862DW/MFC-L2922DW/MFC-L2960DW/MFC-L2980DW

1. Start your web browser.
2. Type "https://machine's IP address" in your browser's address bar (where "machine's IP address" is your machine's IP address).

For example:

https://192.168.1.2



- If you are using a Domain Name System or enable a NetBIOS name, you can type another name, such as "SharedPrinter" instead of the IP address.

For example: https://SharedPrinter

- If you enable a NetBIOS name, you can also use the node name.
For example: https://brn123456abcdef
- The NetBIOS name can be found in the Network Configuration Report.

3. If required, type the password in the **Login** field, and then click **Login**.



The default password to manage this machine's settings is located on the back of the machine and marked "Pwd". Change the default password by following the on-screen instructions when you first log in.

4. In the left navigation bar, click **Network > Security > CA Certificate**.



If the left navigation bar is not visible, start navigating from ☰.

5. Click **Import CA Certificate**.
6. Browse to the file you want to import.
7. Click **Submit**.



Related Information

- [Import and Export a CA Certificate](#)

Export a CA Certificate

Related Models: DCP-L2620DW/DCP-L2622DW/DCP-L2627DW/DCP-L2627DWXL/DCP-L2627DWE/DCP-L2640DN/DCP-L2660DW/DCP-L2665DW/MFC-L2802DN/MFC-L2800DW/MFC-L2802DW/MFC-L2827DWXL/MFC-L2827DW/MFC-L2835DW/MFC-L2860DWE/MFC-L2860DW/MFC-L2862DW/MFC-L2922DW/MFC-L2960DW/MFC-L2980DW

1. Start your web browser.
2. Type "https://machine's IP address" in your browser's address bar (where "machine's IP address" is your machine's IP address).

For example:

https://192.168.1.2



- If you are using a Domain Name System or enable a NetBIOS name, you can type another name, such as "SharedPrinter" instead of the IP address.

For example: https://SharedPrinter

- If you enable a NetBIOS name, you can also use the node name.
For example: https://brn123456abcdef
- The NetBIOS name can be found in the Network Configuration Report.

3. If required, type the password in the **Login** field, and then click **Login**.



The default password to manage this machine's settings is located on the back of the machine and marked "**Pwd**". Change the default password by following the on-screen instructions when you first log in.

4. In the left navigation bar, click **Network > Security > CA Certificate**.



If the left navigation bar is not visible, start navigating from ☰.

5. Select the certificate you want to export and click **Export**.
6. Click **Submit**.



Related Information

- [Import and Export a CA Certificate](#)

Manage Multiple Certificates

Related Models: DCP-L2620DW/DCP-L2622DW/DCP-L2627DW/DCP-L2627DWXL/DCP-L2627DWE/DCP-L2640DN/DCP-L2660DW/DCP-L2665DW/MFC-L2802DN/MFC-L2800DW/MFC-L2802DW/MFC-L2827DWXL/MFC-L2827DW/MFC-L2835DW/MFC-L2860DWE/MFC-L2860DW/MFC-L2862DW/MFC-L2922DW/MFC-L2960DW/MFC-L2980DW

The multiple certificate feature allows you to use Web Based Management to manage each certificate installed on your machine. In Web Based Management, navigate to the **Certificate** or **CA Certificate** screen to view certificate content, delete, or export your certificates.

| | Maximum Number of Certificates Stored on Brother Machine |
|-------------------------------------------------------|----------------------------------------------------------|
| Self-signed Certificate or Certificate Issued by a CA | 6 |
| CA Certificate | 9 |

We recommend storing fewer certificates than allowed, reserving an empty spot in case of certificate expiration. When a certificate expires, import a new certificate into the reserved spot, and then delete the expired certificate. This ensures that you avoid configuration failure.



- When you use HTTPS/IPPS, IEEE 802.1x, or Signed PDF, you must select which certificate you are using.
- When you use SSL for SMTP/POP3/IMAP4 communications (only available for certain models), you do not have to choose the certificate. The necessary certificate will be chosen automatically.



Related Information

- [Configure Certificates for Device Security](#)

Use SSL/TLS

Related Models: DCP-L2620DW/DCP-L2622DW/DCP-L2627DW/DCP-L2627DWXL/DCP-L2627DWE/
DCP-L2640DN/DCP-L2660DW/DCP-L2665DW/MFC-L2802DN/MFC-L2800DW/MFC-L2802DW/
MFC-L2827DWXL/MFC-L2827DW/MFC-L2835DW/MFC-L2860DWE/MFC-L2860DW/MFC-L2862DW/
MFC-L2922DW/MFC-L2960DW/MFC-L2980DW

- [Introduction to SSL/TLS](#)
- [Manage Your Network Machine Securely Using SSL/TLS](#)
- [Print Documents Securely Using SSL/TLS](#)
- [Send or Receive an Email Securely](#)

Introduction to SSL/TLS

Related Models: DCP-L2620DW/DCP-L2622DW/DCP-L2627DW/DCP-L2627DWXL/DCP-L2627DWE/
DCP-L2640DN/DCP-L2660DW/DCP-L2665DW/MFC-L2802DN/MFC-L2800DW/MFC-L2802DW/
MFC-L2827DWXL/MFC-L2827DW/MFC-L2835DW/MFC-L2860DWE/MFC-L2860DW/MFC-L2862DW/
MFC-L2922DW/MFC-L2960DW/MFC-L2980DW

Secure Socket Layer (SSL) or Transport Layer Security (TLS) is an effective method of protecting data sent over a local or wide area network (LAN or WAN). It works by encrypting data, such as a print job, sent over a network, so anyone trying to capture it will not be able to read it.

SSL/TLS can be configured on both wired and wireless networks and will work with other forms of security such as WPA keys and firewalls.



Related Information

- [Use SSL/TLS](#)
 - [Brief History of SSL/TLS](#)
 - [Benefits of Using SSL/TLS](#)

Brief History of SSL/TLS

Related Models: DCP-L2620DW/DCP-L2622DW/DCP-L2627DW/DCP-L2627DWXL/DCP-L2627DWE/DCP-L2640DN/DCP-L2660DW/DCP-L2665DW/MFC-L2802DN/MFC-L2800DW/MFC-L2802DW/MFC-L2827DWXL/MFC-L2827DW/MFC-L2835DW/MFC-L2860DWE/MFC-L2860DW/MFC-L2862DW/MFC-L2922DW/MFC-L2960DW/MFC-L2980DW

SSL/TLS was originally created to secure web traffic information, particularly data sent between web browsers and servers. SSL is now used with additional applications, such as Telnet, printer, and FTP software, in order to become a universal solution for online security. Its original design intentions are still being used today by many online retailers and banks to secure sensitive data, such as credit card numbers, customer records, etc.

SSL/TLS uses extremely high levels of encryption and is trusted by banks all over the world.



Related Information

- [Introduction to SSL/TLS](#)

Benefits of Using SSL/TLS

Related Models: DCP-L2620DW/DCP-L2622DW/DCP-L2627DW/DCP-L2627DWXL/DCP-L2627DWE/DCP-L2640DN/DCP-L2660DW/DCP-L2665DW/MFC-L2802DN/MFC-L2800DW/MFC-L2802DW/MFC-L2827DWXL/MFC-L2827DW/MFC-L2835DW/MFC-L2860DWE/MFC-L2860DW/MFC-L2862DW/MFC-L2922DW/MFC-L2960DW/MFC-L2980DW

The primary benefit of using SSL/TLS is to guarantee secure printing over an IP network by restricting unauthorised users from reading data sent to the machine. SSL's most important benefit is that it can be used to print confidential data securely. For example, a Human Resource (HR) Department in a large company may be printing wage slips on a regular basis. Without encryption, the data contained on these wages slips can be read by other network users. However, with SSL/TLS, anyone trying to capture the data will see a page of code and not the actual wage slip.



Related Information

- [Introduction to SSL/TLS](#)

Manage Your Network Machine Securely Using SSL/TLS

Related Models: DCP-L2620DW/DCP-L2622DW/DCP-L2627DW/DCP-L2627DWXL/DCP-L2627DWE/
DCP-L2640DN/DCP-L2660DW/DCP-L2665DW/MFC-L2802DN/MFC-L2800DW/MFC-L2802DW/
MFC-L2827DWXL/MFC-L2827DW/MFC-L2835DW/MFC-L2860DWE/MFC-L2860DW/MFC-L2862DW/
MFC-L2922DW/MFC-L2960DW/MFC-L2980DW

- [Configure a Certificate for SSL/TLS and Available Protocols](#)
- [Access Web Based Management Using SSL/TLS](#)
- [Install the Self-signed Certificate for Windows Users as Administrators](#)
- [Configure Certificates for Device Security](#)

Configure a Certificate for SSL/TLS and Available Protocols

Related Models: DCP-L2620DW/DCP-L2622DW/DCP-L2627DW/DCP-L2627DWXL/DCP-L2627DWE/DCP-L2640DN/DCP-L2660DW/DCP-L2665DW/MFC-L2802DN/MFC-L2800DW/MFC-L2802DW/MFC-L2827DWXL/MFC-L2827DW/MFC-L2835DW/MFC-L2860DWE/MFC-L2860DW/MFC-L2862DW/MFC-L2922DW/MFC-L2960DW/MFC-L2980DW

Configure a certificate on your machine using Web Based Management before you use SSL/TLS communication.

1. Start your web browser.
2. Type "https://machine's IP address" in your browser's address bar (where "machine's IP address" is your machine's IP address).

For example:

https://192.168.1.2



- If you are using a Domain Name System or enable a NetBIOS name, you can type another name, such as "SharedPrinter" instead of the IP address.

For example: https://SharedPrinter

- If you enable a NetBIOS name, you can also use the node name.

For example: https://brn123456abcdef

- The NetBIOS name can be found in the Network Configuration Report.

3. If required, type the password in the **Login** field, and then click **Login**.



The default password to manage this machine's settings is located on the back of the machine and marked "**Pwd**". Change the default password by following the on-screen instructions when you first log in.

4. In the left navigation bar, click **Network > Network > Protocol**.



If the left navigation bar is not visible, start navigating from ☰.

5. Click **HTTP Server Settings**.
6. Select the certificate you want to configure from the **Select the Certificate** drop-down list.
7. Click **Submit**.
8. Click **Yes** to restart your print server.



Related Information

- [Manage Your Network Machine Securely Using SSL/TLS](#)

Access Web Based Management Using SSL/TLS

Related Models: DCP-L2620DW/DCP-L2622DW/DCP-L2627DW/DCP-L2627DWXL/DCP-L2627DWE/DCP-L2640DN/DCP-L2660DW/DCP-L2665DW/MFC-L2802DN/MFC-L2800DW/MFC-L2802DW/MFC-L2827DWXL/MFC-L2827DW/MFC-L2835DW/MFC-L2860DWE/MFC-L2860DW/MFC-L2862DW/MFC-L2922DW/MFC-L2960DW/MFC-L2980DW

To manage your network machine securely, use Web Based Management with the HTTPS protocol.



- To use HTTPS protocol, HTTPS must be enabled on your machine. The HTTPS protocol is enabled by default.
- You can change the HTTPS protocol settings using Web Based Management.

1. Start your web browser.
2. Type "https://Common Name" in your browser's address bar (where "Common Name" is the Common Name that you assigned to the certificate; this could be your IP address, node name, or domain name).
3. If required, type the password in the **Login** field, and then click **Login**.



The default password to manage this machine's settings is located on the back of the machine and marked "**Pwd**". Change the default password by following the on-screen instructions when you first log in.

4. You can now access the machine using HTTPS.



Related Information

- [Manage Your Network Machine Securely Using SSL/TLS](#)

Install the Self-signed Certificate for Windows Users as Administrators

Related Models: DCP-L2620DW/DCP-L2622DW/DCP-L2627DW/DCP-L2627DWXL/DCP-L2627DWE/DCP-L2640DN/DCP-L2660DW/DCP-L2665DW/MFC-L2802DN/MFC-L2800DW/MFC-L2802DW/MFC-L2827DWXL/MFC-L2827DW/MFC-L2835DW/MFC-L2860DWE/MFC-L2860DW/MFC-L2862DW/MFC-L2922DW/MFC-L2960DW/MFC-L2980DW

- The following steps are for Microsoft Edge. If you use another web browser, refer to your web browser's documentation or online help for instructions on how to install certificates.
- Make sure you have created your self-signed certificate using Web Based Management.

1. Right-click the **Microsoft Edge** icon, and then click **Run as administrator**.

If the **User Account Control** screen appears, click **Yes**.

2. Type "https://machine's IP address" in your browser's address bar (where "machine's IP address" is your machine's IP address).

For example:

https://192.168.1.2



- If you are using a Domain Name System or enable a NetBIOS name, you can type another name, such as "SharedPrinter" instead of the IP address.

For example: https://SharedPrinter

- If you enable a NetBIOS name, you can also use the node name.

For example: https://brn123456abcdef

- The NetBIOS name can be found in the Network Configuration Report.

3. If your connection is not private, click the **Advanced** button, and then continue to the web page.
4. If required, type the password in the **Login** field, and then click **Login**.



The default password to manage this machine's settings is located on the back of the machine and marked "**Pwd**". Change the default password by following the on-screen instructions when you first log in.

5. In the left navigation bar, click **Network > Security > Certificate**.



If the left navigation bar is not visible, start navigating from ☰.

6. Click **Export**.
7. To encrypt the output file, type a password in the **Enter password** field. If the **Enter password** field is blank, your output file will not be encrypted.
8. Type the password again in the **Retype password** field, and then click **Submit**.
9. Click the downloaded file to open.
10. When the **Certificate Import Wizard** appears, click **Next**.
11. Click **Next**.
12. If required, type a password, and then click **Next**.
13. Select **Place all certificates in the following store**, and then click **Browse....**
14. Select the **Trusted Root Certification Authorities**, and then click **OK**.
15. Click **Next**.
16. Click **Finish**.
17. Click **Yes**, if the fingerprint (thumbprint) is correct.
18. Click **OK**.



Related Information

- [Manage Your Network Machine Securely Using SSL/TLS](#)
-

Print Documents Securely Using SSL/TLS

Related Models: DCP-L2620DW/DCP-L2622DW/DCP-L2627DW/DCP-L2627DWXL/DCP-L2627DWE/
DCP-L2640DN/DCP-L2660DW/DCP-L2665DW/MFC-L2802DN/MFC-L2800DW/MFC-L2802DW/
MFC-L2827DWXL/MFC-L2827DW/MFC-L2835DW/MFC-L2860DWE/MFC-L2860DW/MFC-L2862DW/
MFC-L2922DW/MFC-L2960DW/MFC-L2980DW

- [Print Documents Using IPPS](#)
- [Configure a Certificate for SSL/TLS and Available Protocols](#)
- [Configure Certificates for Device Security](#)

Print Documents Using IPPS

Related Models: DCP-L2620DW/DCP-L2622DW/DCP-L2627DW/DCP-L2627DWXL/DCP-L2627DWE/DCP-L2640DN/DCP-L2660DW/DCP-L2665DW/MFC-L2802DN/MFC-L2800DW/MFC-L2802DW/MFC-L2827DWXL/MFC-L2827DW/MFC-L2835DW/MFC-L2860DWE/MFC-L2860DW/MFC-L2862DW/MFC-L2922DW/MFC-L2960DW/MFC-L2980DW

To print documents securely with IPP protocol, use the IPPS protocol.

1. Start your web browser.
2. Type "https://machine's IP address" in your browser's address bar (where "machine's IP address" is your machine's IP address).

For example:

https://192.168.1.2



- If you are using a Domain Name System or enable a NetBIOS name, you can type another name, such as "SharedPrinter" instead of the IP address.

For example: https://SharedPrinter

- If you enable a NetBIOS name, you can also use the node name.

For example: https://brn123456abcdef

- The NetBIOS name can be found in the Network Configuration Report.

3. If required, type the password in the **Login** field, and then click **Login**.



The default password to manage this machine's settings is located on the back of the machine and marked "**Pwd**". Change the default password by following the on-screen instructions when you first log in.

4. In the left navigation bar, click **Network > Network > Protocol**.



If the left navigation bar is not visible, start navigating from ☰.

5. Make sure the **IPP** checkbox is selected.



If the **IPP** checkbox is not selected, select the **IPP** checkbox, and then click **Submit**.

Restart your machine to activate the configuration.

After the machine restarts, return to the machine's web page, type the password, and then in the left navigation bar, click **Network > Network > Protocol**.

6. Click **HTTP Server Settings**.
7. Select the **HTTPS** checkbox in the **IPP** area, and then click **Submit**.
8. Restart your machine to activate the configuration.

Communication using IPPS cannot prevent unauthorised access to the print server.



Related Information

- [Print Documents Securely Using SSL/TLS](#)

Use SNMPv3

Related Models: DCP-L2620DW/DCP-L2622DW/DCP-L2627DW/DCP-L2627DWXL/DCP-L2627DWE/
DCP-L2640DN/DCP-L2660DW/DCP-L2665DW/MFC-L2802DN/MFC-L2800DW/MFC-L2802DW/
MFC-L2827DWXL/MFC-L2827DW/MFC-L2835DW/MFC-L2860DWE/MFC-L2860DW/MFC-L2862DW/
MFC-L2922DW/MFC-L2960DW/MFC-L2980DW

- [Manage Your Network Machine Securely Using SNMPv3](#)

Manage Your Network Machine Securely Using SNMPv3

Related Models: DCP-L2620DW/DCP-L2622DW/DCP-L2627DW/DCP-L2627DWXL/DCP-L2627DWE/DCP-L2640DN/DCP-L2660DW/DCP-L2665DW/MFC-L2802DN/MFC-L2800DW/MFC-L2802DW/MFC-L2827DWXL/MFC-L2827DW/MFC-L2835DW/MFC-L2860DWE/MFC-L2860DW/MFC-L2862DW/MFC-L2922DW/MFC-L2960DW/MFC-L2980DW

The Simple Network Management Protocol version 3 (SNMPv3) provides user authentication and data encryption to manage network devices securely.

1. Start your web browser.
2. Type "https://Common Name" in your browser's address bar (where "Common Name" is the Common Name that you assigned to the certificate; this could be your IP address, node name, or domain name).
3. If required, type the password in the **Login** field, and then click **Login**.



The default password to manage this machine's settings is located on the back of the machine and marked "Pwd". Change the default password by following the on-screen instructions when you first log in.

4. In the left navigation bar, click **Network > Network > Protocol**.



If the left navigation bar is not visible, start navigating from ☰.

5. Make sure the **SNMP** setting is enabled, and then click **Advanced Settings**.
6. Configure the SNMPv1/v2c mode settings.

| Option | Description |
|--------------------------------------|-----------------------------------------------------------------------------------------------------------------------------------------------------------------------------------------------------------------------------------------------------------|
| SNMP v1/v2c read-write access | The print server uses version 1 and version 2c of the SNMP protocol. You can use all of your machine's applications in this mode. However, it is not secure since it will not authenticate the user and data will not be encrypted. |
| SNMP v1/v2c read-only access | The print server uses the read-only access of version 1 and version 2c of the SNMP protocol. |
| Disabled | Disable version 1 and version 2c of the SNMP protocol. All applications that use SNMPv1/v2c will be restricted. To allow the use of SNMPv1/v2c applications, use the SNMP v1/v2c read-only access or SNMP v1/v2c read-write access mode. |

7. Configure the SNMPv3 mode settings.

| Option | Description |
|-----------------|---------------------------------------------------------------------------------------------------------------------------------------------------------------|
| Enabled | The print server uses version 3 of the SNMP protocol. To manage the print server securely, use the SNMPv3 mode. |
| Disabled | Disable version 3 of the SNMP protocol. All applications that use SNMPv3 will be restricted. To allow the use of SNMPv3 applications, use the SNMPv3 mode. |

8. Click **Submit**.



If your machine displays the protocol setting options, select the options you want.

9. Restart your machine to activate the configuration.



Related Information

- [Use SNMPv3](#)
-

Use IPsec

Related Models: MFC-L2922DW/MFC-L2960DW/MFC-L2980DW

- [Introduction to IPsec](#)
- [Configure IPsec Using Web Based Management](#)
- [Configure an IPsec Address Template Using Web Based Management](#)
- [Configure an IPsec Template Using Web Based Management](#)

Introduction to IPsec

Related Models: MFC-L2922DW/MFC-L2960DW/MFC-L2980DW

IPsec (Internet Protocol Security) is a security protocol that uses an optional Internet Protocol function to prevent data manipulation and ensure the confidentiality of data transmitted as IP packets. IPsec encrypts data carried over a network, such as print data sent from computers to a printer. Because the data is encrypted at the network layer, applications that employ a higher-level protocol use IPsec even if the user is not aware of its use.

IPsec supports the following functions:

- IPsec transmissions

According to the IPsec setting conditions, a network-connected computer sends data to and receives data from a specified device using IPsec. When devices start communicating using IPsec, keys are exchanged using Internet Key Exchange (IKE) first, and then the encrypted data is transmitted using the keys.

In addition, IPsec has two operation modes: the Transport mode and Tunnel mode. The Transport mode is used mainly for communication between devices and the Tunnel mode is used in environments such as a Virtual Private Network (VPN).



For IPsec transmissions, the following conditions are necessary:

- A computer that can communicate using IPsec is connected to the network.
- Your machine is configured for IPsec communication.
- The computer connected to your machine is configured for IPsec connections.

- IPsec settings

The settings that are necessary for connections using IPsec. These settings can be configured using Web Based Management.



To configure the IPsec settings, you must use the browser on a computer that is connected to the network.



Related Information

- [Use IPsec](#)

Configure IPsec Using Web Based Management

Related Models: MFC-L2922DW/MFC-L2960DW/MFC-L2980DW

The IPsec connection conditions comprise two **Template** types: **Address** and **IPsec**. You can configure up to 10 connection conditions.

1. Start your web browser.
2. Type "https://machine's IP address" in your browser's address bar (where "machine's IP address" is your machine's IP address).

For example:

https://192.168.1.2

3. If required, type the password in the **Login** field, and then click **Login**.



The default password to manage this machine's settings is located on the back of the machine and marked "**Pwd**". Change the default password by following the on-screen instructions when you first log in.

4. In the left navigation bar, click **Network > Security > IPsec**.



If the left navigation bar is not visible, start navigating from .

5. Configure the settings.

| Option | Description |
|-----------------------------------|-------------------------------------------------------------------------------------------------------------------------------------------------------------------------------------------------------------------------------------------------------------------------------------------------------------------------------------------------------------------------------------------------------------------------------------------------------------------------------------------------------------------------------------------------------------------------------------------------------------|
| Status | Enable or disable IPsec. |
| Negotiation Mode | Select Negotiation Mode for IKE Phase 1. IKE is a protocol that is used to exchange encryption keys in order to carry out encrypted communication using IPsec. In the Main mode, the processing speed is slow, but the security is high. In the Aggressive mode, the processing speed is faster than in the Main mode, but the security is lower. |
| All Non-IPsec Traffic | Select the action to be taken for non-IPsec packets. When using Web Services, you must select Allow for All Non-IPsec Traffic . If you select Drop , Web Services cannot be used. |
| Broadcast/Multicast Bypass | Select Enabled or Disabled . |
| Protocol Bypass | Select the checkboxes for the option or options you want. |
| Rules | Select the Enabled checkbox to activate the template. When you select multiple checkboxes, the lower numbered checkboxes have priority if the settings for the selected checkboxes conflict. Click the corresponding drop-down list to select the Address Template that is used for the IPsec connection conditions. To add an Address Template , click Add Template . Click the corresponding drop-down list to select the IPsec Template that is used for the IPsec connection conditions. To add an IPsec Template , click Add Template . |

6. Click **Submit**.

If the machine must be restarted to activate the new settings, the restart confirmation screen will appear.

If there is a blank item in the template you enabled in the **Rules** table, an error message appears. Confirm your choices and click **Submit** again.



Related Information

- [Use IPsec](#)

Related Topics:

- [Configure Certificates for Device Security](#)
-

Configure an IPsec Address Template Using Web Based Management

Related Models: MFC-L2922DW/MFC-L2960DW/MFC-L2980DW

1. Start your web browser.
2. Type "https://machine's IP address" in your browser's address bar (where "machine's IP address" is your machine's IP address).
For example:
https://192.168.1.2
3. If required, type the password in the **Login** field, and then click **Login**.

 The default password to manage this machine's settings is located on the back of the machine and marked "Pwd". Change the default password by following the on-screen instructions when you first log in.

4. In the left navigation bar, click **Network > Security > IPsec Address Template**.

 If the left navigation bar is not visible, start navigating from ☰.

5. Click the **Delete** button to delete an **Address Template**. When an **Address Template** is in use, it cannot be deleted.
6. Click the **Address Template** that you want to create. The **IPsec Address Template** appears.
7. Configure the settings.

| Option | Description |
|--------------------------|--------------------------------------------------------------------------------------------------------------------------------------------------------------------------------------------------------------------------------------------------------------------------------------------------------------------------------------------------------------------------------------------------------------------------------------------------------------------------------------------------------------------------------------------------------------------------------------------------------------------------------------------------------------------------------------------------------------------------------------------------------------------------------------------------------------------------------------------------------------------------------------------------------------------|
| Template Name | Type a name for the template (up to 16 characters). |
| Local IP Address | <ul style="list-style-type: none"> • IP Address Specify the IP address. Select ALL IPv4 Address, ALL IPv6 Address, ALL Link Local IPv6, or Custom from the drop-down list. If you select Custom from the drop-down list, type the IP address (IPv4 or IPv6) in the text box. • IP Address Range Type the starting and ending IP addresses for the IP address range in the text boxes. If the starting and ending IP addresses are not standardised to IPv4 or IPv6, or the ending IP address is smaller than the starting address, an error will occur. • IP Address / Prefix Specify the IP address using CIDR notation. For example: 192.168.1.1/24 Because the prefix is specified in the form of a 24-bit subnet mask (255.255.255.0) for 192.168.1.1, the addresses 192.168.1.### are valid. |
| Remote IP Address | <ul style="list-style-type: none"> • Any If you select Any, all IP addresses are enabled. • IP Address Type the specified IP address (IPv4 or IPv6) in the text box. • IP Address Range Type the first and last IP addresses for the IP address range. If the first and last IP addresses are not standardised to IPv4 or IPv6, or the last IP address is smaller than the first address, an error will occur. • IP Address / Prefix Specify the IP address using CIDR notation. |

| Option | Description |
|--------|----------------------------------------------------------------------------------------------------------------------------------------------------------------------------|
| | For example: 192.168.1.1/24 Because the prefix is specified in the form of a 24-bit subnet mask (255.255.255.0) for 192.168.1.1, the addresses 192.168.1.### are valid. |

8. Click **Submit**.



When you change the settings for the template currently in use, restart your machine to activate the configuration.



Related Information

- [Use IPsec](#)
-

Configure an IPsec Template Using Web Based Management

Related Models: MFC-L2922DW/MFC-L2960DW/MFC-L2980DW

1. Start your web browser.
2. Type "https://machine's IP address" in your browser's address bar (where "machine's IP address" is your machine's IP address).
For example:
https://192.168.1.2
3. If required, type the password in the **Login** field, and then click **Login**.



The default password to manage this machine's settings is located on the back of the machine and marked "Pwd". Change the default password by following the on-screen instructions when you first log in.

4. In the left navigation bar, click **Network > Security > IPsec Template**.



If the left navigation bar is not visible, start navigating from ☰.

5. Click the **Delete** button to delete an **IPsec Template**. When an **IPsec Template** is in use, it cannot be deleted.
6. Click the **IPsec Template** that you want to create. The **IPsec Template** screen appears. The configuration fields differ based on the **Use Prefixed Template** and **Internet Key Exchange (IKE)** settings you select.
7. In the **Template Name** field, type a name for the template (up to 16 characters).
8. If you selected **Custom** in the **Use Prefixed Template** drop-down list, select the **Internet Key Exchange (IKE)** options, and then change the settings if needed.
9. Click **Submit**.





Related Information

- [Use IPsec](#)
 - [IKEv1 Settings for an IPsec Template](#)
 - [IKEv2 Settings for an IPsec Template](#)
 - [Manual Settings for an IPsec Template](#)

IKEv1 Settings for an IPsec Template

Related Models: MFC-L2922DW/MFC-L2960DW/MFC-L2980DW

| Option | Description |
|-----------------------------|---------------------------------------------------------------------------------------------------------------------------------------------------------------------------------------------------------------------------------------------------------------------------------------------------------------------------------------------------------------------------------------------------------------------------------------------------------------------------------------------------------------------------------------------------------------------------------------------------------------------------------------------------------------------------------------------------------------------------------------------------------------------------------------------------------------------------------------------------------------------------------------------------------------------------------------------------------------------------------------------------------------------------------------------------------------------------------------------------------------------------------------------------------------------------------------------------------------------------------------------------------------------------------------------------------------------------------------------------------------------------------------------------------------------------------------------------|
| Template Name | Type a name for the template (up to 16 characters). |
| Use Prefixed Template | Select Custom , IKEv1 High Security or IKEv1 Medium Security . The setting items are different depending on the selected template. |
| Internet Key Exchange (IKE) | <p>IKE is a communication protocol that is used to exchange encryption keys in order to carry out encrypted communication using IPsec. To carry out encrypted communication for that time only, the encryption algorithm that is necessary for IPsec is determined and the encryption keys are shared. For IKE, the encryption keys are exchanged using the Diffie-Hellman key exchange method, and encrypted communication that is limited to IKE is carried out.</p> <p>If you selected Custom in Use Prefixed Template, select IKEv1.</p> |
| Authentication Type | <ul style="list-style-type: none"> • Diffie-Hellman Group This key exchange method allows secret keys to be securely exchanged over an unprotected network. The Diffie-Hellman key exchange method uses a discrete logarithm problem, not the secret key, to send and receive open information that was generated using a random number and the secret key. Select Group1, Group2, Group5, or Group14. • Encryption Select DES, 3DES, AES-CBC 128, or AES-CBC 256. • Hash Select MD5, SHA1, SHA256, SHA384 or SHA512. • SA Lifetime Specify the IKE SA lifetime. Type the time (seconds) and number of kilobytes (KByte). |
| Encapsulating Security | <ul style="list-style-type: none"> • Protocol Select ESP, AH, or AH+ESP. <hr/> <ul style="list-style-type: none"> -  ESP is a protocol for carrying out encrypted communication using IPsec. ESP encrypts the payload (communicated contents) and adds additional information. The IP packet comprises the header and the encrypted payload, which follows the header. In addition to the encrypted data, the IP packet also includes information regarding the encryption method and encryption key, the authentication data, and so on. - AH is part of the IPsec protocol that authenticates the sender and prevents manipulation (ensures the completeness) of the data. In the IP packet, the data is inserted immediately after the header. In addition, the packets include hash values, which are calculated using an equation from the communicated contents, secret key, and so on, in order to prevent the falsification of the sender and manipulation of the data. Unlike ESP, the communicated contents are not encrypted, and the data is sent and received as plain text. <hr/> <ul style="list-style-type: none"> • Encryption (Not available for the AH option.) Select DES, 3DES, AES-CBC 128, or AES-CBC 256. |

| Option | Description |
|--------------------------------------|-------------------------------------------------------------------------------------------------------------------------------------------------------------------------------------------------------------------------------------------------------------------------------------------------------------------------------------------------------------------------------------------------------------------------------------------------------------------------------------------------------------------------------------------------------------------------------------------------------------------------------------------------------------------------------------------------------------------------------------------------------------------------------------------------------------------------------------------------------------------------------------------------------------------------------------------------------------------------------------------------------------------------------------------------------------------------------------------------------------------------------------------------------------------------------------------------------------------------------------------------------------------------------------------------------------------------------------|
| | <ul style="list-style-type: none"> • Hash Select None, MD5, SHA1, SHA256, SHA384, or SHA512. None can be selected only when ESP is selected for Protocol. • SA Lifetime Specify the IKE SA lifetime. Type the time (seconds) and number of kilobytes (KByte). • Encapsulation Mode Select Transport or Tunnel. • Remote Router IP-Address Type the IP address (IPv4 or IPv6) of the remote router. Enter this information only when the Tunnel mode is selected. <hr/>  SA (Security Association) is an encrypted communication method using IPsec or IPv6 that exchanges and shares information, such as the encryption method and encryption key, in order to establish a secure communication channel before communication begins. SA may also refer to a virtual encrypted communication channel that has been established. The SA used for IPsec establishes the encryption method, exchanges the keys, and carries out mutual authentication according to the IKE (Internet Key Exchange) standard procedure. In addition, the SA is updated periodically. |
| Perfect Forward Secrecy (PFS) | <p>PFS does not derive keys from previous keys that were used to encrypt messages. In addition, if a key that is used to encrypt a message was derived from a parent key, that parent key is not used to derive other keys. Therefore, even if a key is compromised, the damage will be limited only to the messages that were encrypted using that key.</p> <p>Select Enabled or Disabled.</p> |
| Authentication Method | <p>Select the authentication method. Select Pre-Shared Key or Certificates.</p> |
| Pre-Shared Key | <p>When encrypting communication, the encryption key is exchanged and shared beforehand using another channel.</p> <p>If you selected Pre-Shared Key for the Authentication Method, type the Pre-Shared Key (up to 32 characters).</p> <ul style="list-style-type: none"> • Local/ID Type/ID Select the sender's ID type, and then type the ID. Select IPv4 Address, IPv6 Address, FQDN, E-mail Address, or Certificate for the type. If you select Certificate, type the common name of the certificate in the ID field. • Remote/ID Type/ID Select the recipient's ID type, and then type the ID. Select IPv4 Address, IPv6 Address, FQDN, E-mail Address, or Certificate for the type. If you select Certificate, type the common name of the certificate in the ID field. |
| Certificate | <p>If you selected Certificates for Authentication Method, select the certificate.</p> <hr/>  You can select only the certificates that were created using the Certificate page of Web Based Management's Security configuration screen. |





Related Information

- [Configure an IPsec Template Using Web Based Management](#)
-

IKEv2 Settings for an IPsec Template

Related Models: MFC-L2922DW/MFC-L2960DW/MFC-L2980DW

| Option | Description |
|------------------------------------|-------------------------------------------------------------------------------------------------------------------------------------------------------------------------------------------------------------------------------------------------------------------------------------------------------------------------------------------------------------------------------------------------------------------------------------------------------------------------------------------------------------------------------------------------------------------------------------------------------------------------------------------------------------------------------------------------------------------------------------------------------------------------------------------------------------------------------------------------------------------------------------------------------------------------------------------------------------------------------------------------------------------------------------------------------------------------------------------------------|
| Template Name | Type a name for the template (up to 16 characters). |
| Use Prefixed Template | Select Custom , IKEv2 High Security , or IKEv2 Medium Security . The setting items are different depending on the selected template. |
| Internet Key Exchange (IKE) | IKE is a communication protocol that is used to exchange encryption keys in order to carry out encrypted communication using IPsec. To carry out encrypted communication for that time only, the encryption algorithm that is necessary for IPsec is determined and the encryption keys are shared. For IKE, the encryption keys are exchanged using the Diffie-Hellman key exchange method, and encrypted communication that is limited to IKE is carried out. If you selected Custom in Use Prefixed Template , select IKEv2 . |
| Authentication Type | <ul style="list-style-type: none"> • Diffie-Hellman Group This key exchange method allows secret keys to be securely exchanged over an unprotected network. The Diffie-Hellman key exchange method uses a discrete logarithm problem, not the secret key, to send and receive open information that was generated using a random number and the secret key. Select Group1, Group2, Group5, or Group14. • Encryption Select DES, 3DES, AES-CBC 128, or AES-CBC 256. • Hash Select MD5, SHA1, SHA256, SHA384 or SHA512. • SA Lifetime Specify the IKE SA lifetime. Type the time (seconds) and number of kilobytes (KByte). |
| Encapsulating Security | <ul style="list-style-type: none"> • Protocol Select ESP. <hr/> <p> ESP is a protocol for carrying out encrypted communication using IPsec. ESP encrypts the payload (communicated contents) and adds additional information. The IP packet comprises the header and the encrypted payload, which follows the header. In addition to the encrypted data, the IP packet also includes information regarding the encryption method and encryption key, the authentication data, and so on.</p> <hr/> <ul style="list-style-type: none"> • Encryption Select DES, 3DES, AES-CBC 128, or AES-CBC 256. • Hash Select MD5, SHA1, SHA256, SHA384, or SHA512. • SA Lifetime Specify the IKE SA lifetime. Type the time (seconds) and number of kilobytes (KByte). • Encapsulation Mode Select Transport or Tunnel. |

| Option | Description |
|--------------------------------------|------------------------------------------------------------------------------------------------------------------------------------------------------------------------------------------------------------------------------------------------------------------------------------------------------------------------------------------------------------------------------------------------------------------------------------------------------------------------------------------------------------------------------------------------------------------------------------------------------------------------------------------------------------------------------------------------------------------------------------------------------------------------------------------------------------------------------------------------------------------------------------------------------------------------------------------------------------------------------------------------------------------------------------------------------|
| | <ul style="list-style-type: none"> Remote Router IP-Address Type the IP address (IPv4 or IPv6) of the remote router. Enter this information only when the Tunnel mode is selected. <hr/>  SA (Security Association) is an encrypted communication method using IPsec or IPv6 that exchanges and shares information, such as the encryption method and encryption key, in order to establish a secure communication channel before communication begins. SA may also refer to a virtual encrypted communication channel that has been established. The SA used for IPsec establishes the encryption method, exchanges the keys, and carries out mutual authentication according to the IKE (Internet Key Exchange) standard procedure. In addition, the SA is updated periodically. |
| Perfect Forward Secrecy (PFS) | <p>PFS does not derive keys from previous keys that were used to encrypt messages. In addition, if a key that is used to encrypt a message was derived from a parent key, that parent key is not used to derive other keys. Therefore, even if a key is compromised, the damage will be limited only to the messages that were encrypted using that key.</p> <p>Select Enabled or Disabled.</p> |
| Authentication Method | <p>Select the authentication method. Select Pre-Shared Key, Certificates, EAP - MD5, or EAP - MS-CHAPv2.</p> <hr/>  EAP is an authentication protocol that is an extension of PPP. By using EAP with IEEE802.1x, a different key is used for user authentication during each session. <p>The following settings are necessary only when EAP - MD5 or EAP - MS-CHAPv2 is selected in Authentication Method:</p> <ul style="list-style-type: none"> Mode Select Server-Mode or Client-Mode. Certificate Select the certificate. User Name Type the user name (up to 32 characters). Password Type the password (up to 32 characters). The password must be entered two times for confirmation. |
| Pre-Shared Key | <p>When encrypting communication, the encryption key is exchanged and shared beforehand using another channel.</p> <p>If you selected Pre-Shared Key for the Authentication Method, type the Pre-Shared Key (up to 32 characters).</p> <ul style="list-style-type: none"> Local/ID Type/ID Select the sender's ID type, and then type the ID. Select IPv4 Address, IPv6 Address, FQDN, E-mail Address, or Certificate for the type. If you select Certificate, type the common name of the certificate in the ID field. Remote/ID Type/ID Select the recipient's ID type, and then type the ID. Select IPv4 Address, IPv6 Address, FQDN, E-mail Address, or Certificate for the type. If you select Certificate, type the common name of the certificate in the ID field. |
| Certificate | <p>If you selected Certificates for Authentication Method, select the certificate.</p> |

| Option | Description |
|--------|-------------------------------------------------------------------------------------------------------------------------------------------------------------------------------------------------------------------------------------|
| |  You can select only the certificates that were created using the Certificate page of Web Based Management's Security configuration screen. |







Related Information

- [Configure an IPsec Template Using Web Based Management](#)
-

Manual Settings for an IPsec Template

Related Models: MFC-L2922DW/MFC-L2960DW/MFC-L2980DW

| Option | Description |
|------------------------------|------------------------------------------------------------------------------------------------------------------------------------------------------------------------------------------------------------------------------------------------------------------------------------------------------------------------------------------------------------------------------------------------------------------------------------------------------------------------------------------------------------------------------------------------------------------------------------------------------------------------------------------------------------------------------------------------------------------------------------------------------------------------------------------------------------------------------------------------------------------------------------------------------------------------------------------------------------------------------------------------------------------------------------------------------------------------------------------|
| Template Name | Type a name for the template (up to 16 characters). |
| Use Prefixed Template | Select Custom . |
| Internet Key Exchange (IKE) | <p>IKE is a communication protocol that is used to exchange encryption keys in order to carry out encrypted communication using IPsec. To carry out encrypted communication for that time only, the encryption algorithm that is necessary for IPsec is determined and the encryption keys are shared. For IKE, the encryption keys are exchanged using the Diffie-Hellman key exchange method, and encrypted communication that is limited to IKE is carried out.</p> <p>Select Manual.</p> |
| Authentication Key (ESP, AH) | <p>Type the In/Out values.</p> <p>These settings are necessary when Custom is selected for Use Prefixed Template, Manual is selected for Internet Key Exchange (IKE), and a setting other than None is selected for Hash for Encapsulating Security section.</p> <hr/> <p> The number of characters you can set differs depending on the setting you chose for Hash in the Encapsulating Security section.</p> <p>If the length of the specified authentication key is different than the selected hash algorithm, an error will occur.</p> <ul style="list-style-type: none"> • MD5: 128 bits (16 bytes) • SHA1: 160 bits (20 bytes) • SHA256: 256 bits (32 bytes) • SHA384: 384 bits (48 bytes) • SHA512: 512 bits (64 bytes) <p>When you specify the key in ASCII Code, enclose the characters in double quotation marks (").</p> <hr/> |
| Code key (ESP) | <p>Type the In/Out values.</p> <p>These settings are necessary when Custom is selected for Use Prefixed Template, Manual is selected for Internet Key Exchange (IKE), and ESP is selected for Protocol in Encapsulating Security.</p> <hr/> <p> The number of characters you can set differs depending on the setting you chose for Encryption in the Encapsulating Security section.</p> <p>If the length of the specified code key is different than the selected encryption algorithm, an error will occur.</p> <ul style="list-style-type: none"> • DES: 64 bits (8 bytes) • 3DES: 192 bits (24 bytes) • AES-CBC 128: 128 bits (16 bytes) • AES-CBC 256: 256 bits (32 bytes) <p>When you specify the key in ASCII Code, enclose the characters in double quotation marks (").</p> <hr/> |
| SPI | These parameters are used to identify security information. Generally, a host has multiple Security Associations (SAs) for several types of IPsec communication. Therefore, it is necessary to identify the applicable SA |

| Option | Description |
|-------------------------------|---------------------------------------------------------------------------------------------------------------------------------------------------------------------------------------------------------------------------------------------------------------------------------------------------------------------------------------------------------------------------------------------------------------------------------------------------------------------------------------------------------------------------------------------------------------------------------------------------------------------------------------------------------------------------------------------------------------------------------------------------------------------------------------------------------------------------------------------------------------------------------------------------------------------------------------------------------------------------------------------------------------------------------------------------------------------------------------------------------------------------------------------------------------------------------------------------------------------------------------------------------------------------------------------------------------------------------------------------------------------------------------------------------------------------------------------------------------------------------------------------------------------------------------------------------------------------------------------------------------------------------------------------------------------------------------------------------------------------------------------------------------------------------------------------------------------------------------------------------------------------------------------------------------------------------------------------------------------------------------------------------------------------------------------------------------------------------------------------------------------------------------------------------------------------------------------------------------------------------------------------------------------------------------------------------------------------------------------------------------------------------------------------------------------------------------------------------------------------------------------------------------------------------------------------------------------------------------------------------------------------------------------------------------------------------------------------------------------------------------------------------------------------------------------------------------------------------------------------------|
| | <p>when an IPsec packet is received. The SPI parameter, which identifies the SA, is included in the Authentication Header (AH) and Encapsulating Security Payload (ESP) header.</p> <p>These settings are necessary when Custom is selected for Use Prefixed Template, and Manual is selected for Internet Key Exchange (IKE).</p> <p>Enter the In/Out values. (3-10 characters)</p> |
| Encapsulating Security | <ul style="list-style-type: none"> • Protocol Select ESP or AH. <hr/> <ul style="list-style-type: none">  <ul style="list-style-type: none"> - ESP is a protocol for carrying out encrypted communication using IPsec. ESP encrypts the payload (communicated contents) and adds additional information. The IP packet comprises the header and the encrypted payload, which follows the header. In addition to the encrypted data, the IP packet also includes information regarding the encryption method and encryption key, the authentication data, and so on. - AH is part of the IPsec protocol that authenticates the sender and prevents manipulation of the data (ensures the completeness of the data). In the IP packet, the data is inserted immediately after the header. In addition, the packets include hash values, which are calculated using an equation from the communicated contents, secret key, and so on, in order to prevent the falsification of the sender and manipulation of the data. Unlike ESP, the communicated contents are not encrypted, and the data is sent and received as plain text. <hr/> <ul style="list-style-type: none"> • Encryption (Not available for the AH option.) Select DES, 3DES, AES-CBC 128, or AES-CBC 256. • Hash Select None, MD5, SHA1, SHA256, SHA384, or SHA512. None can be selected only when ESP is selected for Protocol. • SA Lifetime Specify the IKE SA lifetime. Type the time (seconds) and number of kilobytes (KByte). • Encapsulation Mode Select Transport or Tunnel. • Remote Router IP-Address Type the IP address (IPv4 or IPv6) of the remote router. Enter this information only when the Tunnel mode is selected. <hr/> <ul style="list-style-type: none">  <p>SA (Security Association) is an encrypted communication method using IPsec or IPv6 that exchanges and shares information, such as the encryption method and encryption key, in order to establish a secure communication channel before communication begins. SA may also refer to a virtual encrypted communication channel that has been established. The SA used for IPsec establishes the encryption method, exchanges the keys, and carries out mutual authentication according to the IKE (Internet Key Exchange) standard procedure. In addition, the SA is updated periodically.</p> |



Related Information

- [Configure an IPsec Template Using Web Based Management](#)

Use IEEE 802.1x Authentication

Related Models: DCP-L2620DW/DCP-L2622DW/DCP-L2627DW/DCP-L2627DWXL/DCP-L2627DWE/
DCP-L2640DN/DCP-L2660DW/DCP-L2665DW/MFC-L2802DN/MFC-L2800DW/MFC-L2802DW/
MFC-L2827DWXL/MFC-L2827DW/MFC-L2835DW/MFC-L2860DWE/MFC-L2860DW/MFC-L2862DW/
MFC-L2922DW/MFC-L2960DW/MFC-L2980DW

- [What Is IEEE 802.1x Authentication?](#)
- [Configure IEEE 802.1x Authentication for a Wired or Wireless Network Using Web Based Management \(Web Browser\)](#)
- [IEEE 802.1x Authentication Methods](#)

What Is IEEE 802.1x Authentication?

Related Models: DCP-L2620DW/DCP-L2622DW/DCP-L2627DW/DCP-L2627DWXL/DCP-L2627DWE/DCP-L2640DN/DCP-L2660DW/DCP-L2665DW/MFC-L2802DN/MFC-L2800DW/MFC-L2802DW/MFC-L2827DWXL/MFC-L2827DW/MFC-L2835DW/MFC-L2860DWE/MFC-L2860DW/MFC-L2862DW/MFC-L2922DW/MFC-L2960DW/MFC-L2980DW

IEEE 802.1x is an IEEE standard that limits access from unauthorised network devices. Your Brother machine sends an authentication request to a RADIUS server (Authentication server) through your access point or hub. After your request has been verified by the RADIUS server, your machine can access the network.



Related Information

- [Use IEEE 802.1x Authentication](#)

Configure IEEE 802.1x Authentication for a Wired or Wireless Network Using Web Based Management (Web Browser)

Related Models: DCP-L2620DW/DCP-L2622DW/DCP-L2627DW/DCP-L2627DWXL/DCP-L2627DWE/DCP-L2640DN/DCP-L2660DW/DCP-L2665DW/MFC-L2802DN/MFC-L2800DW/MFC-L2802DW/MFC-L2827DWXL/MFC-L2827DW/MFC-L2835DW/MFC-L2860DWE/MFC-L2860DW/MFC-L2862DW/MFC-L2922DW/MFC-L2960DW/MFC-L2980DW

- If you configure your machine using EAP-TLS authentication, you must install the client certificate issued by a CA before you start configuration. Contact your network administrator about the client certificate. If you have installed more than one certificate, we recommend writing down the certificate name you want to use.
- Before you verify the server certificate, you must import the CA certificate issued by the CA that signed the server certificate. Contact your network administrator or your Internet Service Provider (ISP) to confirm whether a CA certificate import is necessary.



You can also configure IEEE 802.1x authentication using the Wireless Setup Wizard from the control panel (Wireless network).

1. Start your web browser.
2. Type "https://machine's IP address" in your browser's address bar (where "machine's IP address" is your machine's IP address).

For example:

https://192.168.1.2



- If you are using a Domain Name System or enable a NetBIOS name, you can type another name, such as "SharedPrinter" instead of the IP address.

For example: https://SharedPrinter

- If you enable a NetBIOS name, you can also use the node name.

For example: https://brn123456abcdef

- The NetBIOS name can be found in the Network Configuration Report.

3. If required, type the password in the **Login** field, and then click **Login**.



The default password to manage this machine's settings is located on the back of the machine and marked "**Pwd**". Change the default password by following the on-screen instructions when you first log in.

4. In the left navigation bar, click **Network**.



If the left navigation bar is not visible, start navigating from ☰.

5. Do one of the following:
 - For the wired network
Click **Wired** > **Wired 802.1x Authentication**.
 - For the wireless network
Click **Wireless** > **Wireless (Enterprise)**.
6. Configure the IEEE 802.1x authentication settings.



- To enable IEEE 802.1x authentication for wired networks, select **Enabled** for **Wired 802.1x status** on the **Wired 802.1x Authentication** page.
- If you are using **EAP-TLS** authentication, you must select the client certificate installed (shown with certificate name) for verification from the **Client Certificate** drop-down list.
- If you select **EAP-FAST**, **PEAP**, **EAP-TTLS**, or **EAP-TLS** authentication, select the verification method from the **Server Certificate Verification** drop-down list. Verify the server certificate using the CA certificate, imported to the machine in advance, issued by the CA that signed the server certificate.

Select one of the following verification methods from the **Server Certificate Verification** drop-down list:

| Option | Description |
|----------------------------|--------------------------------------------------------------------------------------------------------------------------------------------------------------|
| No Verification | The server certificate can always be trusted. The verification is not performed. |
| CA Cert. | The verification method to check the CA reliability of the server certificate, using the CA certificate issued by the CA that signed the server certificate. |
| CA Cert. + ServerID | The verification method to check the common name ¹ value of the server certificate, in addition to the CA reliability of the server certificate. |

7. When finished with configuration, click **Submit**.

For wired networks: After configuring, connect your machine to the IEEE 802.1x supported network. After a few minutes, print the Network Configuration Report to check the **<Wired IEEE 802.1x>** status.

| Option | Description |
|----------------|----------------------------------------------------------------------------------|
| Success | The wired IEEE 802.1x function is enabled and the authentication was successful. |
| Failed | The wired IEEE 802.1x function is enabled; however, the authentication failed. |
| Off | The wired IEEE 802.1x function is not available. |



Related Information

- [Use IEEE 802.1x Authentication](#)

Related Topics:

- [Configure Certificates for Device Security](#)

¹ The common name verification compares the common name of the server certificate to the character string configured for the **Server ID**. Before you use this method, contact your system administrator about the server certificate's common name and then configure **Server ID**.

IEEE 802.1x Authentication Methods

Related Models: DCP-L2620DW/DCP-L2622DW/DCP-L2627DW/DCP-L2627DWXL/DCP-L2627DWE/DCP-L2640DN/DCP-L2660DW/DCP-L2665DW/MFC-L2802DN/MFC-L2800DW/MFC-L2802DW/MFC-L2827DWXL/MFC-L2827DW/MFC-L2835DW/MFC-L2860DWE/MFC-L2860DW/MFC-L2862DW/MFC-L2922DW/MFC-L2960DW/MFC-L2980DW

EAP-FAST

Extensible Authentication Protocol-Flexible Authentication via Secured Tunneling (EAP-FAST) has been developed by Cisco Systems, Inc., which uses a user ID and password for authentication, and symmetric key algorithms to achieve a tunnelled authentication process.

Your Brother machine supports the following inner authentication methods:

- EAP-FAST/NONE
- EAP-FAST/MS-CHAPv2
- EAP-FAST/GTC

EAP-MD5 (Wired network)

Extensible Authentication Protocol-Message Digest Algorithm 5 (EAP-MD5) uses a user ID and password for challenge-response authentication.

PEAP

Protected Extensible Authentication Protocol (PEAP) is a version of EAP method developed by Cisco Systems, Inc., Microsoft Corporation and RSA Security. PEAP creates an encrypted Secure Sockets Layer (SSL)/Transport Layer Security (TLS) tunnel between a client and an authentication server, for sending a user ID and password. PEAP provides mutual authentication between the server and the client.

Your Brother machine supports the following inner authentication methods:

- PEAP/MS-CHAPv2
- PEAP/GTC

EAP-TTLS

Extensible Authentication Protocol-Tunneled Transport Layer Security (EAP-TTLS) has been developed by Funk Software and Certicom. EAP-TTLS creates a similar encrypted SSL tunnel to PEAP, between a client and an authentication server, for sending a user ID and password. EAP-TTLS provides mutual authentication between the server and the client.

Your Brother machine supports the following inner authentication methods:

- EAP-TTLS/CHAP
- EAP-TTLS/MS-CHAP
- EAP-TTLS/MS-CHAPv2
- EAP-TTLS/PAP

EAP-TLS

Extensible Authentication Protocol-Transport Layer Security (EAP-TLS) requires digital certificate authentication both at a client and an authentication server.



Related Information

- [Use IEEE 802.1x Authentication](#)

Use Active Directory Authentication

Related Models: MFC-L2922DW/MFC-L2960DW/MFC-L2980DW

- [Introduction to Active Directory Authentication](#)
- [Configure Active Directory Authentication Using Web Based Management](#)
- [Log On to Change the Machine Settings Using the Machine's Control Panel \(Active Directory Authentication\)](#)

Introduction to Active Directory Authentication

Related Models: MFC-L2922DW/MFC-L2960DW/MFC-L2980DW

Active Directory Authentication restricts the use of your machine. If Active Directory Authentication is enabled, the machine's control panel will be locked. You cannot change the machine's settings until you enter a User ID and password.

Active Directory Authentication offers the following features:

- Stores incoming print data
- Stores incoming fax data (For MFC models)
- Obtains the email address from the Active Directory server based on your User ID, when sending scanned data to an email server.

To use this feature, select the **On** option for the **Get Mail Address** setting and **LDAP + kerberos** or **LDAP + NTLMv2** authentication method. Your email address will be set as the sender when the machine sends scanned data to an email server, or as the recipient if you want to send the scanned data to your email address.

When Active Directory Authentication is enabled, your machine stores all incoming fax data. After you log on, the machine prints the stored fax data. (For MFC models)

You can change the Active Directory Authentication settings using Web Based Management.



Related Information

- [Use Active Directory Authentication](#)

Configure Active Directory Authentication Using Web Based Management

Related Models: MFC-L2922DW/MFC-L2960DW/MFC-L2980DW

Active Directory authentication supports Kerberos authentication and NTLMv2 authentication. You must configure the SNTP protocol (network time server) and DNS server configuration for authentication.

1. Start your web browser.
2. Type "https://machine's IP address" in your browser's address bar (where "machine's IP address" is your machine's IP address).

For example:

https://192.168.1.2

3. If required, type the password in the **Login** field, and then click **Login**.



The default password to manage this machine's settings is located on the back of the machine and marked "Pwd". Change the default password by following the on-screen instructions when you first log in.

4. In the left navigation bar, click **Administrator > User Restriction Function** or **Restriction Management**.



If the left navigation bar is not visible, start navigating from .

5. Select **Active Directory Authentication**.
6. Click **Submit**.
7. Click **Active Directory Authentication**.
8. Configure the following settings:

| Option | Description |
|---------------------------------------------|-----------------------------------------------------------------------------------------------------------------------------------------------------------------------------------------|
| Storage Fax RX Data | Select this option to store incoming fax data. You can print all incoming fax data after you log on to the machine. |
| Remember User ID | Select this option to save your User ID. |
| Active Directory Server Address | Type the IP address or the server name (for example: ad.example.com) of the Active Directory Server. |
| Active Directory Domain Name | Type the Active Directory domain name. |
| Protocol & Authentication Method | Select the protocol and authentication method. |
| SSL/TLS | Select the SSL/TLS option. |
| LDAP Server Port | Type the port number to connect the Active Directory server via LDAP (available only for LDAP + kerberos or LDAP + NTLMv2 authentication method). |
| LDAP Search Root | Type the LDAP search root (available only for LDAP + kerberos or LDAP + NTLMv2 authentication method). |
| Get Mail Address | Select this option to obtain logged on user's email address from the Active Directory server. (available only for LDAP + kerberos or LDAP + NTLMv2 authentication method) |

| Option | Description |
|----------------------------------|--------------------------------------------------------------------------------------------------------------------------------------------------------------------------------|
| Get User's Home Directory | Select this option to obtain your home directory as the Scan to Network destination. (available only for LDAP + kerberos or LDAP + NTLMv2 authentication method) |

9. Click **Submit**.

Related Information

- [Use Active Directory Authentication](#)
-

Log On to Change the Machine Settings Using the Machine's Control Panel (Active Directory Authentication)

Related Models: MFC-L2922DW/MFC-L2960DW/MFC-L2980DW

When Active Directory Authentication is enabled, the machine's control panel will be locked until you enter your User ID and password on the machine's control panel.

1. On the machine's control panel, use the touchscreen to enter your User ID and Password.
2. Press [OK].
3. When authentication is successful, the machine's control panel unlocks and the LCD displays the Home screen.



Related Information

- [Use Active Directory Authentication](#)

Use LDAP Authentication

Related Models: MFC-L2922DW/MFC-L2960DW/MFC-L2980DW

- [Introduction to LDAP Authentication](#)
- [Configure LDAP Authentication Using Web Based Management](#)
- [Log On to Change the Machine Settings Using the Machine's Control Panel \(LDAP Authentication\)](#)

Introduction to LDAP Authentication

Related Models: MFC-L2922DW/MFC-L2960DW/MFC-L2980DW

LDAP Authentication restricts the use of your machine. If LDAP Authentication is enabled, the machine's control panel will be locked. You cannot change the machine's settings until you enter a User ID and password.

LDAP Authentication offers the following features:

- Stores incoming print data
- Stores incoming fax data (For MFC models)
- Obtains the email address from the LDAP server based on your User ID, when sending scanned data to an email server.

To use this feature, select the **On** option for the **Get Mail Address** setting. Your email address will be set as the sender when the machine sends scanned data to an email server, or as the recipient if you want to send the scanned data to your email address.

When LDAP Authentication is enabled, your machine stores all incoming fax data. After you log on, the machine prints the stored fax data. (For MFC models)

You can change the LDAP Authentication settings using Web Based Management.



Related Information

- [Use LDAP Authentication](#)

Configure LDAP Authentication Using Web Based Management

Related Models: MFC-L2922DW/MFC-L2960DW/MFC-L2980DW

1. Start your web browser.
2. Type "https://machine's IP address" in your browser's address bar (where "machine's IP address" is your machine's IP address).
For example:
https://192.168.1.2
3. If required, type the password in the **Login** field, and then click **Login**.



The default password to manage this machine's settings is located on the back of the machine and marked "Pwd". Change the default password by following the on-screen instructions when you first log in.

4. In the left navigation bar, click **Administrator > User Restriction Function** or **Restriction Management**.



If the left navigation bar is not visible, start navigating from ☰.

5. Select **LDAP Authentication**.
6. Click **Submit**.
7. Click the **LDAP Authentication** menu.
8. Configure the following settings:

| Option | Description |
|---------------------------------------|---------------------------------------------------------------------------------------------------------------------|
| Storage Fax RX Data | Select this option to store incoming fax data. You can print all incoming fax data after you log on to the machine. |
| Remember User ID | Select this option to save your User ID. |
| LDAP Server Address | Type the IP address or the server name (for example: ldap.example.com) of the LDAP server. |
| SSL/TLS | Select the SSL/TLS option to use LDAP over SSL/TLS. |
| LDAP Server Port | Type the LDAP server port number. |
| LDAP Search Root | Type the LDAP search root directory. |
| Attribute of Name (Search Key) | Type the attribute you want to use as a search key. |
| Get Mail Address | Select this option to obtain the logged user's email address from the LDAP server. |
| Get User's Home Directory | Select this option to obtain your home directory as the Scan to Network destination. |

9. Click **Submit**.



Related Information

- [Use LDAP Authentication](#)

Log On to Change the Machine Settings Using the Machine's Control Panel (LDAP Authentication)

Related Models: MFC-L2922DW/MFC-L2960DW/MFC-L2980DW

When LDAP Authentication is enabled, the machine's control panel will be locked until you enter your User ID and password on the machine's control panel.

1. On the machine's control panel, enter your User ID.
2. Press [OK].
3. Enter your password.
4. Press [OK].
5. Press [OK] again.
6. When authentication is successful, the machine's control panel unlocks and the LCD displays the Home screen.



Related Information

- [Use LDAP Authentication](#)

Use Secure Function Lock 3.0

Related Models: MFC-L2860DWE/MFC-L2860DW/MFC-L2862DW/MFC-L2922DW/MFC-L2960DW/
MFC-L2980DW

Secure Function Lock 3.0 increases security by restricting the functions available on your machine.

- [Before Using Secure Function Lock 3.0](#)
- [Configure Secure Function Lock 3.0 Using Web Based Management](#)
- [Scan Using Secure Function Lock 3.0](#)
- [Configure Public Mode for Secure Function Lock 3.0](#)
- [Additional Secure Function Lock 3.0 Features](#)
- [Register a new ID Card Using the Machine's Control Panel](#)

Before Using Secure Function Lock 3.0

Related Models: MFC-L2860DWE/MFC-L2860DW/MFC-L2862DW/MFC-L2922DW/MFC-L2960DW/MFC-L2980DW

Use Secure Function Lock to configure passwords, set specific user page limits, and grant access to some or all of the functions listed here.

You can configure and change the following Secure Function Lock 3.0 settings using Web Based Management:

- **Print**

Print includes print jobs sent via AirPrint, Brother iPrint&Scan, and Brother Mobile Connect.

If you register user login names in advance, the users do not need to enter their passwords when they use the print function.

- **Copy**

- **Scan**

Scan includes scan jobs sent via Brother iPrint&Scan and Brother Mobile Connect.

- **Send** (supported models only)

- **Receive** (supported models only)

- **Web Connect** (supported models only)

- **Apps** (supported models only)

- **Page Limits**

- **Page Counters**

- **Card ID (NFC ID)** (supported models only)

If you register user Card IDs in advance, registered users can activate the machine by touching their registered cards to the machine's NFC symbol.



Touchscreen LCD models:

When Secure Function Lock is enabled, the machine automatically enters Public Mode and some of the machine's functions become restricted to authorised users only. To access the restricted machine functions, press , select your user name, and enter your password.



Related Information

- [Use Secure Function Lock 3.0](#)

Configure Secure Function Lock 3.0 Using Web Based Management

Related Models: MFC-L2860DWE/MFC-L2860DW/MFC-L2862DW/MFC-L2922DW/MFC-L2960DW/MFC-L2980DW

1. Start your web browser.
2. Type "https://machine's IP address" in your browser's address bar (where "machine's IP address" is your machine's IP address).
For example:
https://192.168.1.2
3. If required, type the password in the **Login** field, and then click **Login**.



The default password to manage this machine's settings is located on the back of the machine and marked "Pwd". Change the default password by following the on-screen instructions when you first log in.

4. In the left navigation bar, click **Administrator > User Restriction Function** or **Restriction Management**.



If the left navigation bar is not visible, start navigating from ☰.

5. Select **Secure Function Lock**.
6. Click **Submit**.
7. Click the **Restricted Functions** menu.
8. In the **User List / Restricted Functions** field, type a group name or user name.
9. In the **Print** and the other columns, select a checkbox to allow, or clear a checkbox to restrict, the function listed.
10. To configure the maximum page count, select the **On** checkbox in the **Page Limits** column, and then type the maximum number in the **Max. Pages** field.
11. Click **Submit**.
12. Click the **User List** menu.
13. In the **User List** field, type the user name.
14. In the **Password** field, type a password.



The number of characters you can set differs depending on your model.

15. (MFC-L2922DW/MFC-L2960DW/MFC-L2980DW) In the **E-mail Address** field, type the user's email address.
16. To register the user's Card ID, type the card number in the **Card ID (NFC ID)** field (available for certain models).
17. Select **User List / Restricted Functions** from the drop-down list for each user.
18. Click **Submit**.



You can also change the user list lockout settings in the **Secure Function Lock** menu.



Related Information

- [Use Secure Function Lock 3.0](#)

Scan Using Secure Function Lock 3.0

Related Models: MFC-L2860DWE/MFC-L2860DW/MFC-L2862DW/MFC-L2922DW/MFC-L2960DW/MFC-L2980DW

Setting Scan restrictions (for administrators)

Secure Function Lock 3.0 allows an administrator to restrict which users are allowed to scan. When the Scan feature is set to Off for the public user setting, only users who have the **Scan** checkbox selected will be able to scan.

Using the Scan feature (for restricted users)

- To scan using the machine's control panel:
Restricted users must enter their passwords on the machine's control panel to access Scan mode.
- To scan from a computer:
Restricted users must enter their passwords on the machine's control panel before scanning from their computers. If the password is not entered on the machine's control panel, an error message will appear on the user's computer.



Related Information

- [Use Secure Function Lock 3.0](#)

Configure Public Mode for Secure Function Lock 3.0

Related Models: MFC-L2860DWE/MFC-L2860DW/MFC-L2862DW/MFC-L2922DW/MFC-L2960DW/MFC-L2980DW

Use the Secure Function Lock screen to set up Public Mode, which limits the functions available to public users. Public users will not need to enter a password to access the features made available through Public Mode settings.



Public Mode includes print jobs sent via Brother iPrint&Scan and Brother Mobile Connect.

1. Start your web browser.
2. Type "https://machine's IP address" in your browser's address bar (where "machine's IP address" is your machine's IP address).

For example:

https://192.168.1.2

3. If required, type the password in the **Login** field, and then click **Login**.



The default password to manage this machine's settings is located on the back of the machine and marked "Pwd". Change the default password by following the on-screen instructions when you first log in.

4. In the left navigation bar, click **Administrator > User Restriction Function** or **Restriction Management**.



If the left navigation bar is not visible, start navigating from ☰.

5. Select **Secure Function Lock**.
6. Click **Submit**.
7. Click the **Restricted Functions** menu.
8. In the **Public Mode** row, select a checkbox to allow, or clear a checkbox to restrict, the function listed.
9. Click **Submit**.



Related Information

- [Use Secure Function Lock 3.0](#)

Additional Secure Function Lock 3.0 Features

Related Models: MFC-L2860DWE/MFC-L2860DW/MFC-L2862DW/MFC-L2922DW/MFC-L2960DW/MFC-L2980DW

Configure the following features in the Secure Function Lock screen:

All Counter Reset

Click **All Counter Reset**, in the **Page Counters** column, to reset the page counter.

Export to CSV file

Click **Export to CSV file**, to export the current and last page counter including **User List / Restricted Functions** information as a CSV file.

Card ID (NFC ID) (supported models only)

Click the **User List** menu, and then type a user's Card ID in the **Card ID (NFC ID)** field. You can use your IC card for authentication.

Last Counter Record

Click **Last Counter Record** if you want the machine to retain the page count after the counter has been reset.



Related Information

- [Use Secure Function Lock 3.0](#)

Register a new ID Card Using the Machine's Control Panel

Related Models: MFC-L2922DW/MFC-L2980DW

1. Touch the Near-Field Communication (NFC) symbol on the machine with a registered Integrated Circuit Card (IC Card).
2. Touch your user ID on the machine.
3. Press [Register Card].
4. Touch a new IC Card to the NFC symbol.
The new IC Card's number is registered to the machine.
5. Press [OK].



Related Information

- [Use Secure Function Lock 3.0](#)

Send or Receive an Email Securely

Related Models: DCP-L2620DW/DCP-L2622DW/DCP-L2627DW/DCP-L2627DWXL/DCP-L2627DWE/
DCP-L2640DN/DCP-L2660DW/DCP-L2665DW/MFC-L2802DN/MFC-L2800DW/MFC-L2802DW/
MFC-L2827DWXL/MFC-L2827DW/MFC-L2835DW/MFC-L2860DWE/MFC-L2860DW/MFC-L2862DW/
MFC-L2922DW/MFC-L2960DW/MFC-L2980DW

- [Configure Email Sending or Receiving Using Web Based Management](#)
- [Send an Email with User Authentication](#)
- [Send or Receive an Email Securely Using SSL/TLS](#)

Configure Email Sending or Receiving Using Web Based Management

Related Models: DCP-L2620DW/DCP-L2622DW/DCP-L2627DW/DCP-L2627DWXL/DCP-L2627DWE/DCP-L2640DN/DCP-L2660DW/DCP-L2665DW/MFC-L2802DN/MFC-L2800DW/MFC-L2802DW/MFC-L2827DWXL/MFC-L2827DW/MFC-L2835DW/MFC-L2860DWE/MFC-L2860DW/MFC-L2862DW/MFC-L2922DW/MFC-L2960DW/MFC-L2980DW

We recommend using Web Based Management to configure secured email sending with user authentication, or email sending and receiving using SSL/TLS.

1. Start your web browser.
2. Type "https://machine's IP address" in your browser's address bar (where "machine's IP address" is your machine's IP address).

For example:

https://192.168.1.2

3. If required, type the password in the **Login** field, and then click **Login**.



The default password to manage this machine's settings is located on the back of the machine and marked "**Pwd**". Change the default password by following the on-screen instructions when you first log in.

4. In the left navigation bar, click **Network > Network > Protocol**.



If the left navigation bar is not visible, start navigating from ☰.

5. In the **POP3/IMAP4/SMTP Client** field, click **Advanced Settings** and make sure the status of **POP3/IMAP4/SMTP Client** is **Enabled**.



If the **Authentication Method** selection screen appears, select your authentication method, and then follow the on-screen instructions.

6. Configure the **POP3/IMAP4/SMTP Client** settings.
 - Confirm that the email settings are correct after configuration by sending a test email.
 - If you do not know the POP3/IMAP4/SMTP server settings, contact your network administrator or Internet Service Provider (ISP).
7. When finished, click **Submit**.

The **Test Send/Receive E-mail Configuration** dialog box appears.
8. Follow the instructions in the dialog box to test the current settings.



Related Information

- [Send or Receive an Email Securely](#)

Send an Email with User Authentication

Related Models: DCP-L2620DW/DCP-L2622DW/DCP-L2627DW/DCP-L2627DWXL/DCP-L2627DWE/DCP-L2640DN/DCP-L2660DW/DCP-L2665DW/MFC-L2802DN/MFC-L2800DW/MFC-L2802DW/MFC-L2827DWXL/MFC-L2827DW/MFC-L2835DW/MFC-L2860DWE/MFC-L2860DW/MFC-L2862DW/MFC-L2922DW/MFC-L2960DW/MFC-L2980DW

Your machine sends email via an email server that requires user authentication. This method prevents unauthorised users from accessing the email server.

You can send email notification, email reports and I-Fax using user authentication. (For MFC models)



We recommend using Web Based Management to configure the SMTP authentication.

Email Server Settings

You must configure your machine's SMTP authentication method to match the method used by your email server. For details about your email server settings, contact your network administrator or Internet Service Provider (ISP).



To enable SMTP server authentication using Web Based Management, select your authentication method under **Server Authentication Method** on the **POP3/IMAP4/SMTP Client** screen.



Related Information

- [Send or Receive an Email Securely](#)

Send or Receive an Email Securely Using SSL/TLS

Related Models: DCP-L2620DW/DCP-L2622DW/DCP-L2627DW/DCP-L2627DWXL/DCP-L2627DWE/DCP-L2640DN/DCP-L2660DW/DCP-L2665DW/MFC-L2802DN/MFC-L2800DW/MFC-L2802DW/MFC-L2827DWXL/MFC-L2827DW/MFC-L2835DW/MFC-L2860DWE/MFC-L2860DW/MFC-L2862DW/MFC-L2922DW/MFC-L2960DW/MFC-L2980DW

Your machine supports SSL/TLS communication methods. To use an email server that is using SSL/TLS communication, you must configure the following settings.



We recommend using Web Based Management to configure SSL/TLS.

Verify Server Certificate

Under **SSL/TLS**, if you choose **SSL** or **TLS**, the **Verify Server Certificate** checkbox will be selected automatically.



- Before you verify the server certificate, you must import the CA certificate issued by the CA that signed the server certificate. Contact your network administrator or your Internet Service Provider (ISP) to confirm if importing a CA certificate is necessary.
- If you do not need to verify the server certificate, clear the **Verify Server Certificate** checkbox.

Port Number

If you select **SSL**, or **TLS**, the **Port** value will be changed to match the protocol. To change the port number manually, type the port number after you select **SSL/TLS** settings.

You must configure your machine's communication method to match the method used by your email server. For details about your email server settings, contact your network administrator or your ISP.

In most cases, the secured webmail services require the following settings:

| | | |
|-------|-------------------------------------|------------------|
| SMTP | Port | 587 |
| | Server Authentication Method | SMTP-AUTH |
| | SSL/TLS | TLS |
| POP3 | Port | 995 |
| | SSL/TLS | SSL |
| IMAP4 | Port | 993 |
| | SSL/TLS | SSL |



Related Information

- [Send or Receive an Email Securely](#)

Related Topics:

- [Configure Certificates for Device Security](#)

Store Print Log to Network

Related Models: MFC-L2922DW/MFC-L2960DW/MFC-L2980DW

- [Store Print Log to Network Overview](#)
- [Configure the Store Print Log to Network Settings Using Web Based Management](#)
- [Use the Store Print Log to Network's Error Detection Setting](#)
- [Use Store Print Log to Network with Secure Function Lock 3.0](#)

Store Print Log to Network Overview

Related Models: MFC-L2922DW/MFC-L2960DW/MFC-L2980DW

The Store Print Log to Network feature allows you to save the print log file from your machine to a network server using the Common Internet File System (CIFS) protocol. You can record the ID, type of print job, job name, user name, date, time and the number of printed pages for every print job. CIFS is a protocol that runs over TCP/IP, allowing computers on a network to share files over an intranet or the Internet.

The following print functions are recorded in the print log:

- Print jobs from your computer
- Copy
- Received Fax (supported models only)
- Web Connect Print (supported models only)



- The Store Print Log to Network feature supports Kerberos authentication and NTLMv2 authentication. You must configure the SNTP protocol (network time server), or you must set the date, time and time zone correctly on the control panel for authentication.
- You can set the file type to TXT or CSV when storing a file to the server.



Related Information

- [Store Print Log to Network](#)

Configure the Store Print Log to Network Settings Using Web Based Management

Related Models: MFC-L2922DW/MFC-L2960DW/MFC-L2980DW

1. Start your web browser.
2. Type "https://machine's IP address" in your browser's address bar (where "machine's IP address" is your machine's IP address).

For example:

https://192.168.1.2

3. If required, type the password in the **Login** field, and then click **Login**.





The default password to manage this machine's settings is located on the back of the machine and marked "Pwd". Change the default password by following the on-screen instructions when you first log in.

4. In the left navigation bar, click **Administrator > Store Print Log to Network**.



If the left navigation bar is not visible, start navigating from ☰.

5. In the **Print Log** field, click **On**.
6. Configure the following settings:

| Option | Description |
|----------------------------|------------------------------------------------------------------------------------------------------------------------------------------------------------------------------------------------------------------------------------------------------------------------------------------------------------------------------------------------------------------------------------------------------------------------------------------------------------------------------------------------------------------------------------------------------------------------------------------------------------------------------------------------------------------------------------------------------------------------------------------------------------------------------------------------------------------------------------------------------------------------------------------------------------------------------------------------------------------------------------------------------------------------------------------------------------------------------------------------------------------------------------|
| Network Folder Path | Type the destination folder where your print log will be stored on the CIFS server (for example: \\ComputerName\SharedFolder). |
| File Name | Type the file name you want to use for the print log (up to 32 characters). |
| File Type | Select the TXT or CSV option for the print log file type. |
| Time Source for Log | Select the time source for the print log. |
| Auth. Method | <p>Select the authentication method required for access to the CIFS server: Auto, Kerberos, or NTLMv2. Kerberos is an authentication protocol which allows devices or individuals to securely prove their identity to network servers using a single sign-on. NTLMv2 is the authentication method used by Windows to log into servers.</p> <ul style="list-style-type: none">• Auto: If you select Auto, NTLMv2 will be used to the authentication method.• Kerberos: Select the Kerberos option to use Kerberos authentication only.• NTLMv2: Select the NTLMv2 option to use NTLMv2 authentication only. <p> For the Kerberos and NTLMv2 authentication, you must also configure the Date&Time settings or the SNTP protocol (network time server) and DNS server.</p> <ul style="list-style-type: none">• You can also configure the Date & Time settings from the machine's control panel. |
| Username | Type the user name for the authentication (up to 96 characters). |
| | <p> If the user name is part of a domain, enter the user name in one of the following styles: user@domain or domain\user.</p> |

| Option | Description |
|-----------------------------------------------|---------------------------------------------------------------------------------------------------------------------------------------------------------------|
| Password | Type the password for the authentication (up to 32 characters). |
| Kerberos Server Address (if needed) | Type the Key Distribution Center (KDC) host address (for example: kerberos.example.com; up to 64 characters) or the IP address (for example: 192.168.56.189). |
| Error Detection Setting | Choose what action should be taken when the print log cannot be stored to the server due to a network error. |

- In the **Connection Status** field, confirm the last log status.



You can also confirm the error status on the LCD of your machine.

- Click **Submit** to display the **Test Print Log to Network** page.
To test your settings, click **Yes** and then go to the next step.
To skip the test, click **No**. Your settings will be submitted automatically.
- The machine will test your settings.
- If your settings are accepted, **Test OK** appears on the screen.
If **Test Error** appears, check all settings, and then click **Submit** to display the Test page again.



Related Information

- [Store Print Log to Network](#)
-

Use the Store Print Log to Network's Error Detection Setting

Related Models: MFC-L2922DW/MFC-L2960DW/MFC-L2980DW

Use Error Detection Settings to determine the action that is taken when the print log cannot be stored to the server due to a network error.

1. Start your web browser.
2. Type "https://machine's IP address" in your browser's address bar (where "machine's IP address" is your machine's IP address).

For example:

https://192.168.1.2

3. If required, type the password in the **Login** field, and then click **Login**.



The default password to manage this machine's settings is located on the back of the machine and marked "Pwd". Change the default password by following the on-screen instructions when you first log in.

4. In the left navigation bar, click **Administrator** > **Store Print Log to Network**.



If the left navigation bar is not visible, start navigating from ☰.

5. In the **Error Detection Setting** section, select the **Cancel Print** or **Ignore Log & Print** option.

| Option | Description |
|---------------------|--------------------------------------------------------------------------------------------------------------------------------------------------------------------------------------------------------------------------------------------------------------------------------------------------------------------------------------|
| Cancel Print | If you select the Cancel Print option, the print jobs are cancelled when the print log cannot be stored to the server.  Even if you select the Cancel Print option, your machine will print a received fax. (For MFC models) |

Ignore Log & Print If you select the **Ignore Log & Print** option, the machine prints the documentation even if the print log cannot be stored to the server.

When the Store Print Log function has recovered, the print log is recorded as follows:

```
Id, Type, Job Name, User Name, Date, Time, Print Pages
```

```
1, Print(xxxxxxx), "Document01.doc", "user01", 03/03/20xx, 14:01:32, 52
```

```
2, Print(xxxxxxx), "Document02.doc", "user01", 03/03/20xx, 14:45:30, ?
```

```
3, <ERROR>, ?, ?, ?, ?
```

```
4, Print(xxxxxxx), "Report01.xls", "user02", 03/03/20xx, 19:30:40, 4
```

- a. If the log cannot be stored at the end of printing, the number of printed pages will not be recorded.
- b. If the print log cannot be stored at the beginning and the end of printing, the print log of the job will not be recorded. When the function has recovered, the error is reflected in the log.

6. Click **Submit** to display the **Test Print Log to Network** page.

To test your settings, click **Yes** and then go to the next step.

To skip the test, click **No**. Your settings will be submitted automatically.

7. The machine will test your settings.

8. If your settings are accepted, **Test OK** appears on the screen.

If **Test Error** appears, check all settings, and then click **Submit** to display the Test page again.



Related Information

- [Store Print Log to Network](#)
-

Use Store Print Log to Network with Secure Function Lock 3.0

Related Models: MFC-L2922DW/MFC-L2960DW/MFC-L2980DW

When Secure Function Lock 3.0 is active, the names of the registered users for copy, Fax RX (for MFC models) and Web Connect Print are recorded in the Store Print Log to Network report. When the Active Directory Authentication is enabled, the user name is recorded in the Store Print Log to Network report:

```
Id, Type, Job Name, User Name, Date, Time, Print Pages
1, Copy, -, -, 04/04/20xx, 09:05:12, 3
2, Fax, -, -, 04/04/20xx, 09:45:30, 5
3, Copy, -, "BOB", 04/04/20xx, 10:20:30, 4
4, Fax, -, "BOB", 04/04/20xx, 10:35:12, 3
```

✓ Related Information

- [Store Print Log to Network](#)

Lock the Machine Settings from the Control Panel

Before turning the machine's Setting Lock on, write down and save your password. If you forget the password, you must reset all passwords stored in the machine by contacting your administrator or Brother customer service.

- [Setting Lock Overview](#)

Setting Lock Overview

Related Models: MFC-L2802DN/MFC-L2800DW/MFC-L2802DW/MFC-L2827DWXL/MFC-L2827DW/
MFC-L2835DW/MFC-L2860DWE/MFC-L2860DW/MFC-L2862DW/MFC-L2922DW/MFC-L2960DW/
MFC-L2980DW

Use the Setting Lock feature to block unauthorised access to machine settings.

When Setting Lock is set to On, you cannot access the machine settings without entering the password.

- [Set the Setting Lock Password](#)
- [Change the Setting Lock Password](#)
- [Turn Setting Lock On](#)

Set the Setting Lock Password



Related Models: MFC-L2802DN/MFC-L2800DW/MFC-L2802DW/MFC-L2827DWXL/MFC-L2827DW/
MFC-L2835DW/MFC-L2860DWE/MFC-L2860DW/MFC-L2862DW/MFC-L2922DW/MFC-L2960DW/
MFC-L2980DW

>> MFC-L2802DN/MFC-L2800DW/MFC-L2802DW/MFC-L2827DWXL/MFC-L2827DW/MFC-L2835DW
>> MFC-L2860DWE/MFC-L2860DW/MFC-L2862DW/MFC-L2922DW/MFC-L2960DW/MFC-L2980DW

MFC-L2802DN/MFC-L2800DW/MFC-L2802DW/MFC-L2827DWXL/MFC-L2827DW/ MFC-L2835DW

1. Press **Menu**.
2. Press **▲** or **▼** to display the [General Setup] option, and then press **OK**.
3. (MFC-L2802DN/MFC-L2800DW/MFC-L2802DW/MFC-L2827DWXL/MFC-L2827DW/MFC-L2835DW) Press **▲** or **▼** to display the [Security] option, and then press **OK**.
4. Press **▲** or **▼** to display the [Setting Lock] option, and then press **OK**.
5. Enter a four-digit number for the password.
To enter each digit, press **▲** or **▼** to select a number, and then press **OK**.
6. When the LCD displays [Verify:], re-enter the password.
7. Press **OK**.
8. Press **Stop/Exit**.

MFC-L2860DWE/MFC-L2860DW/MFC-L2862DW/MFC-L2922DW/MFC-L2960DW/ MFC-L2980DW

1. Press  [Settings] > [All Settings] > [General Setup] > [Setting Lock].
2. Enter a four-digit number for the password.
3. Press [OK].
4. When the LCD displays [Verify:], re-enter the password.
5. Press [OK].
6. Press .

Related Information

- [Setting Lock Overview](#)

Related Topics:

- [How to Enter Text on Your Machine](#)

Change the Setting Lock Password



Related Models: MFC-L2802DN/MFC-L2800DW/MFC-L2802DW/MFC-L2827DWXL/MFC-L2827DW/
MFC-L2835DW/MFC-L2860DWE/MFC-L2860DW/MFC-L2862DW/MFC-L2922DW/MFC-L2960DW/
MFC-L2980DW

>> MFC-L2802DN/MFC-L2800DW/MFC-L2802DW/MFC-L2827DWXL/MFC-L2827DW/MFC-L2835DW
>> MFC-L2860DWE/MFC-L2860DW/MFC-L2862DW/MFC-L2922DW/MFC-L2960DW/MFC-L2980DW

MFC-L2802DN/MFC-L2800DW/MFC-L2802DW/MFC-L2827DWXL/MFC-L2827DW/ MFC-L2835DW

1. Press **Menu**.
2. Press **▲** or **▼** to display the [General Setup] option, and then press **OK**.
3. (MFC-L2802DN/MFC-L2800DW/MFC-L2802DW/MFC-L2827DWXL/MFC-L2827DW/MFC-L2835DW) Press **▲** or **▼** to display the [Security] option, and then press **OK**.
4. Press **▲** or **▼** to display the [Setting Lock] option, and then press **OK**.
5. Press **▲** or **▼** to select the [Set Password] option, and then press **OK**.
6. Enter the current four-digit password.
7. Press **OK**.
8. Enter a new four-digit password.
9. Press **OK**.
10. When the LCD displays [Verify:], re-enter the password.
11. Press **OK**.
12. Press **Stop/Exit**.

MFC-L2860DWE/MFC-L2860DW/MFC-L2862DW/MFC-L2922DW/MFC-L2960DW/ MFC-L2980DW

1. Press  [Settings] > [All Settings] > [General Setup] > [Setting Lock] > [Set Password].
2. Enter the current four-digit password.
3. Press [OK].
4. Enter a new four-digit password.
5. Press [OK].
6. When the LCD displays [Verify:], re-enter the password.
7. Press [OK].
8. Press .

✓ Related Information

- [Setting Lock Overview](#)

Turn Setting Lock On

Related Models: MFC-L2802DN/MFC-L2800DW/MFC-L2802DW/MFC-L2827DWXL/MFC-L2827DW/MFC-L2835DW/MFC-L2860DWE/MFC-L2860DW/MFC-L2862DW/MFC-L2922DW/MFC-L2960DW/MFC-L2980DW

>> [MFC-L2802DN/MFC-L2800DW/MFC-L2802DW/MFC-L2827DWXL/MFC-L2827DW/MFC-L2835DW](#)
>> [MFC-L2860DWE/MFC-L2860DW/MFC-L2862DW/MFC-L2922DW/MFC-L2960DW/MFC-L2980DW](#)

MFC-L2802DN/MFC-L2800DW/MFC-L2802DW/MFC-L2827DWXL/MFC-L2827DW/MFC-L2835DW

1. Press **Menu**.
2. Press **▲** or **▼** to display the [General Setup] option, and then press **OK**.
3. (MFC-L2802DN/MFC-L2800DW/MFC-L2802DW/MFC-L2827DWXL/MFC-L2827DW/MFC-L2835DW) Press **▲** or **▼** to display the [Security] option, and then press **OK**.
4. Press **▲** or **▼** to display the [Setting Lock] option, and then press **OK**.
5. Press **OK** when the LCD displays [On].
6. Enter the current four-digit password.
7. Press **OK**.

MFC-L2860DWE/MFC-L2860DW/MFC-L2862DW/MFC-L2922DW/MFC-L2960DW/MFC-L2980DW

1. Press  [Settings] > [All Settings] > [General Setup] > [Setting Lock] > [Lock Off⇒On].
2. Enter the current four-digit password.
3. Press [OK].



To turn Setting Lock off, press  on the LCD, enter the current four-digit password, and then press [OK].

✓ Related Information

- [Setting Lock Overview](#)

Use Global Network Detection Features

When you use your machine on a private network, use the Global Network Detection feature to avoid a risk from unexpected attacks from the global network.

- [Enable Global IP Address Detection](#)
- [Block Communications from the Global Network](#)

Enable Global IP Address Detection

Related Models: DCP-L2620DW/DCP-L2622DW/DCP-L2627DW/DCP-L2627DWXL/DCP-L2627DWE/
DCP-L2640DN/DCP-L2660DW/DCP-L2665DW/MFC-L2802DN/MFC-L2800DW/MFC-L2802DW/
MFC-L2827DWXL/MFC-L2827DW/MFC-L2835DW/MFC-L2860DWE/MFC-L2860DW/MFC-L2862DW/
MFC-L2922DW/MFC-L2960DW/MFC-L2980DW



Use this feature to check your machine's IP address. When your machine is assigned to a global IP address, an alert is displayed on the machine.

>> DCP-L2620DW/DCP-L2622DW/DCP-L2627DW/DCP-L2627DWXL/DCP-L2627DWE/DCP-L2640DN/
MFC-L2802DN/MFC-L2800DW/MFC-L2802DW/MFC-L2827DWXL/MFC-L2827DW/MFC-L2835DW
>> DCP-L2660DW/DCP-L2665DW/MFC-L2860DWE/MFC-L2860DW/MFC-L2862DW/MFC-L2922DW/
MFC-L2960DW/MFC-L2980DW

**DCP-L2620DW/DCP-L2622DW/DCP-L2627DW/DCP-L2627DWXL/DCP-L2627DWE/
DCP-L2640DN/MFC-L2802DN/MFC-L2800DW/MFC-L2802DW/MFC-L2827DWXL/
MFC-L2827DW/MFC-L2835DW**

1. Press **Menu**.
2. Press **▲** or **▼** to select the [Network] option, and then press **OK**.
3. Press **▲** or **▼** to select the [Global Detect] option, and then press **OK**.
4. Press **▲** or **▼** to select the [Allow Detect] option, and then press **OK**.
5. Press **▲** or **▼** to select [On], and then press **OK**.

**DCP-L2660DW/DCP-L2665DW/MFC-L2860DWE/MFC-L2860DW/MFC-L2862DW/
MFC-L2922DW/MFC-L2960DW/MFC-L2980DW**

1. Press  [Settings] > [All Settings] > [Network] > [Global Detect] > [Allow Detect] > [On].
2. Press .

Related Information

- [Use Global Network Detection Features](#)

Block Communications from the Global Network

Related Models: DCP-L2620DW/DCP-L2622DW/DCP-L2627DW/DCP-L2627DWXL/DCP-L2627DWE/DCP-L2640DN/DCP-L2660DW/DCP-L2665DW/MFC-L2802DN/MFC-L2800DW/MFC-L2802DW/MFC-L2827DWXL/MFC-L2827DW/MFC-L2835DW/MFC-L2860DWE/MFC-L2860DW/MFC-L2862DW/MFC-L2922DW/MFC-L2960DW/MFC-L2980DW





When you enable this feature, it limits receiving jobs from devices with global IP addresses

>> DCP-L2620DW/DCP-L2622DW/DCP-L2627DW/DCP-L2627DWXL/DCP-L2627DWE/DCP-L2640DN/MFC-L2802DN/MFC-L2800DW/MFC-L2802DW/MFC-L2827DWXL/MFC-L2827DW/MFC-L2835DW
>> DCP-L2660DW/DCP-L2665DW/MFC-L2860DWE/MFC-L2860DW/MFC-L2862DW/MFC-L2922DW/MFC-L2960DW/MFC-L2980DW

**DCP-L2620DW/DCP-L2622DW/DCP-L2627DW/DCP-L2627DWXL/DCP-L2627DWE/
DCP-L2640DN/MFC-L2802DN/MFC-L2800DW/MFC-L2802DW/MFC-L2827DWXL/
MFC-L2827DW/MFC-L2835DW**

1. Press **Menu**.
2. Press **▲** or **▼** to select the [Network] option, and then press **OK**.
3. Press **▲** or **▼** to select the [Global Detect] option, and then press **OK**.
4. Press **▲** or **▼** to select the [Reject Access] option, and then press **OK**.
5. Press **▲** or **▼** to select [On], and then press **OK**.

**DCP-L2660DW/DCP-L2665DW/MFC-L2860DWE/MFC-L2860DW/MFC-L2862DW/
MFC-L2922DW/MFC-L2960DW/MFC-L2980DW**

1. Press  [Settings] > [All Settings] > [Network] > [Global Detect] > [Reject Access] > [On].
2. Press .



Related Information

- [Use Global Network Detection Features](#)

Mobile/Web Connect

- [Brother Web Connect](#)
- [AirPrint](#)
- [Mopria™ Print Service and Mopria™ Scan](#)
- [Brother Mobile Connect](#)

Brother Web Connect

Related Models: DCP-L2660DW/DCP-L2665DW/MFC-L2860DWE/MFC-L2860DW/MFC-L2862DW/
MFC-L2922DW/MFC-L2960DW/MFC-L2980DW

- [Brother Web Connect Overview](#)
- [Online Services Used with Brother Web Connect](#)
- [Set Up Brother Web Connect](#)
- [Scan and Upload Documents Using Brother Web Connect](#)
- [Download and Print Documents Using Brother Web Connect](#)
- [FaxForward to Cloud or E-mail](#)

Brother Web Connect Overview

Related Models: DCP-L2660DW/DCP-L2665DW/MFC-L2860DWE/MFC-L2860DW/MFC-L2862DW/MFC-L2922DW/MFC-L2960DW/MFC-L2980DW

Certain websites provide services that allow users to upload and view images and files on the websites. Your Brother machine can scan images and upload them to these services, and also download and print images that are already uploaded to these services.

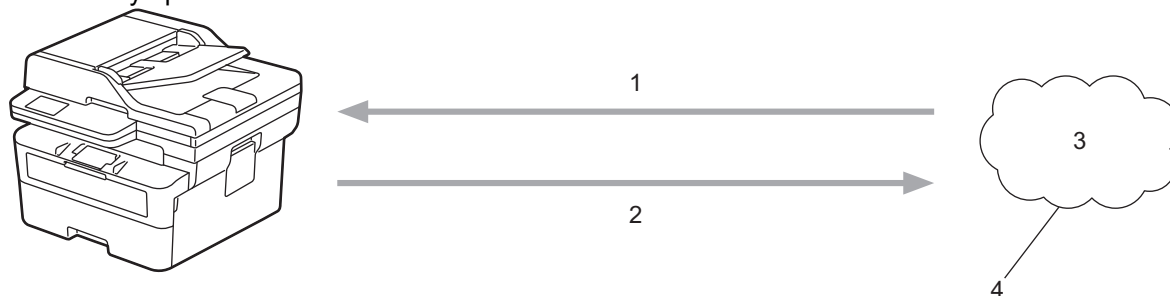

1. Printing
2. Scanning
3. Photos, images, documents, and other files
4. Web Service

To use Brother Web Connect, your Brother machine must be connected to a network that has access to the Internet, through either a wired or wireless connection.

For network setups that use a proxy server, the machine must also be configured to use a proxy server. If you are unsure of your network configuration, check with your network administrator.



A proxy server is a computer that serves as an intermediary between computers without a direct Internet connection, and the Internet.

✓ Related Information



- [Brother Web Connect](#)
 - [Configure the Proxy Server Settings Using the Machine's Control Panel](#)

Configure the Proxy Server Settings Using the Machine's Control Panel

Related Models: DCP-L2660DW/DCP-L2665DW/MFC-L2860DWE/MFC-L2860DW/MFC-L2862DW/MFC-L2922DW/MFC-L2960DW/MFC-L2980DW

If your network uses a proxy server, the following proxy server information must be configured on the machine:

- Proxy server address
- Port number
- User Name
- Password

1. Press  [Settings] > [All Settings] > [Network] > [Web Connect Settings] > [Proxy Settings] > [Proxy Connection] > [On].
2. Press the proxy server information, and then enter the option that you want to set.
3. Press .

Related Information

- [Brother Web Connect Overview](#)

Related Topics:

- [Configure the Proxy Server Settings Using Web Based Management](#)

Online Services Used with Brother Web Connect

Related Models: DCP-L2660DW/DCP-L2665DW/MFC-L2860DWE/MFC-L2860DW/MFC-L2862DW/MFC-L2922DW/MFC-L2960DW/MFC-L2980DW

Use Brother Web Connect to access services from your Brother machine:

To use Brother Web Connect, you must have an account with the online service you want to use. If you do not already have an account, use a computer to access the service's website and create an account.

If you already have an account, there is no need to create an additional account.

Google Drive™

An online document storage, editing, sharing, and file synchronisation service.

URL: drive.google.com

Evernote®

An online file storage and management service.

URL: www.evernote.com

Dropbox

An online file storage, sharing, and synchronisation service.

URL: www.dropbox.com

OneDrive

An online file storage, sharing, and managing service.

URL: onedrive.live.com

Box

An online document editing and sharing service.

URL: www.box.com

OneNote

An online document editing and sharing service.

URL: www.onenote.com

SharePoint Online

An online content storage, sharing, and managing service.

For more information about any of these services, refer to the respective service's website.

The following table describes which file types can be used with each Brother Web Connect feature:

| Accessible Services | Google Drive™ Evernote® Dropbox OneDrive Box OneNote SharePoint Online |
|----------------------------------------|------------------------------------------------------------------------------------------|
| Download and print images ¹ | JPEG PDF DOCX XLSX PPTX |
| Upload scanned images | JPEG |

| | |
|------------------------------------------------------------------|-------------------------------------------------------------------------------------------------------------------------------------------|
| Accessible Services | Google Drive™ Evernote® Dropbox OneDrive Box OneNote SharePoint Online |
| | PDF ² DOCX XLSX PPTX TIFF XPS |
| FaxForward to the online services (available for certain models) | JPEG PDF TIFF |

¹ DOC/XLS/PPT formats are also available for downloading and printing images.

² Includes Searchable PDF, Signed PDF, Secure PDF, PDF/A and High Compression PDF.



(For Hong Kong, Taiwan and Korea)

Brother Web Connect supports only file names written in English. Files named in the local language will not be downloaded.



Related Information

- [Brother Web Connect](#)

Set Up Brother Web Connect

Related Models: DCP-L2660DW/DCP-L2665DW/MFC-L2860DWE/MFC-L2860DW/MFC-L2862DW/
MFC-L2922DW/MFC-L2960DW/MFC-L2980DW

- [Brother Web Connect Setup Overview](#)
- [Create an Account for Each Online Service Before Using Brother Web Connect](#)
- [Apply for Brother Web Connect Access](#)
- [Register an Account on Your Brother Machine for Brother Web Connect](#)

Brother Web Connect Setup Overview

Related Models: DCP-L2660DW/DCP-L2665DW/MFC-L2860DWE/MFC-L2860DW/MFC-L2862DW/MFC-L2922DW/MFC-L2960DW/MFC-L2980DW

Configure the Brother Web Connect settings using the following procedure:

Step 1: Create an account with the service you want to use.

Access the service's website using a computer and create an account. (If you already have an account, there is no need to create an additional account.)

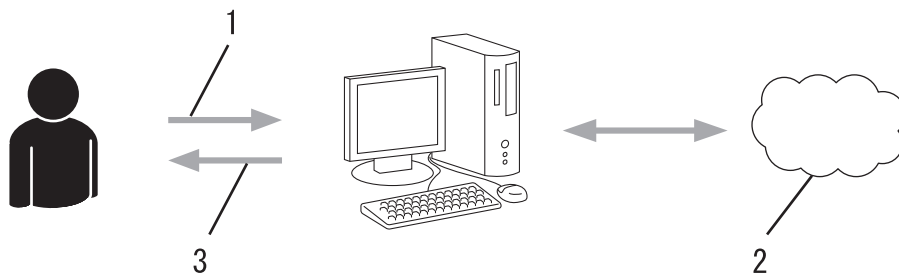

1. User registration
2. Web Service
3. Obtain account

Step 2: Apply for Brother Web Connect access.

Start Brother Web Connect access using a computer and obtain a temporary ID.

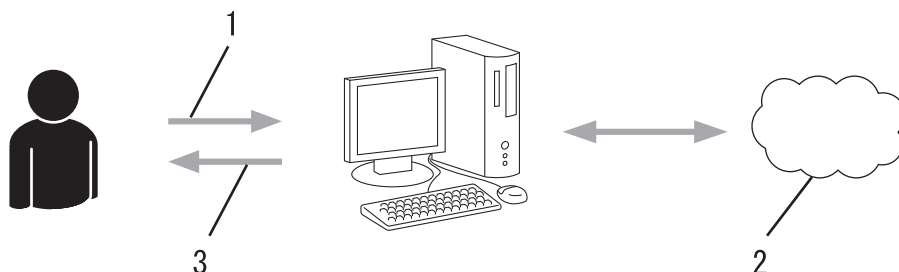

1. Enter account information
2. Brother Web Connect application page
3. Obtain temporary ID

Step 3: Register your account information on your machine so you can access the service you want to use.

Enter the temporary ID to enable the service on your machine. Specify the account name as you would like it to be displayed on the machine, and enter a PIN if you would like to use one.

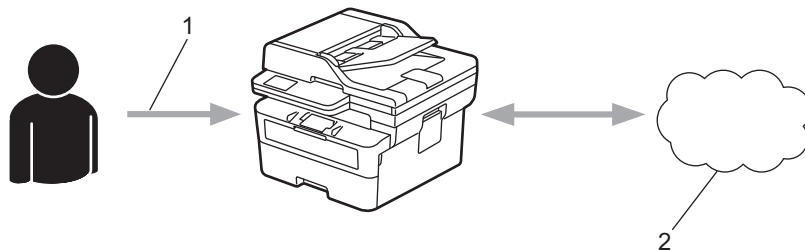

1. Enter temporary ID
2. Web Service

Your Brother machine can now use the service.



Related Information

- [Set Up Brother Web Connect](#)

Create an Account for Each Online Service Before Using Brother Web Connect

Related Models: DCP-L2660DW/DCP-L2665DW/MFC-L2860DWE/MFC-L2860DW/MFC-L2862DW/MFC-L2922DW/MFC-L2960DW/MFC-L2980DW

To use Brother Web Connect to access an online service, you must have an account with that online service. If you do not already have an account, use a computer to access the service's website and create an account. After creating an account, log on and use the account once with a computer before using the Brother Web Connect feature. Otherwise, you may not be able to access the service using Brother Web Connect.

If you already have an account, there is no need to create an additional account.

When you have created an account with the online service you want to use, apply for Brother Web Connect access.



Related Information



- [Set Up Brother Web Connect](#)

Apply for Brother Web Connect Access

Related Models: DCP-L2660DW/DCP-L2665DW/MFC-L2860DWE/MFC-L2860DW/MFC-L2862DW/MFC-L2922DW/MFC-L2960DW/MFC-L2980DW

To use Brother Web Connect to access online services, you must first apply for Brother Web Connect access using a computer that has the Brother Software installed.

1. Access the Brother Web Connect application website:

| Option | Description |
|---------|-----------------------------------------------------------------------------------------------------------------------------------------------------------------------------------------------------------------------------------------------------------------------------------------------------------------------------------------------------------------------------------------------------------------------------------------------------------------------------------------------------------------------------------------------------|
| Windows | Launch  (Brother Utilities), and then click the drop-down list and select your model name (if not already selected). Click Do More in the left navigation bar, and then click Brother Web Connect .  You can also access the website directly: Type bwc.brother.com into your web browser's address bar. |
| Mac | Type bwc.brother.com into your web browser's address bar. |

The Brother Web Connect page launches.

2. Select the service you want to use.
3. Follow the on-screen instructions and apply for access.

 When using SharePoint Online, follow the on-screen instructions to register a document library.

When finished, your temporary ID appears.

Get connected with Brother Web Connect

Finished the registration.

Please enter the following temporary ID on the LCD screen of your machine.

Temporary ID (11 digits)

XXX XXXX XXXX

NOTE : The temporary ID will expire in 24 hours.

4. Make a note of your temporary ID as you will need it to register accounts to the machine. The temporary ID is valid for 24 hours.
5. Close the web browser.

Now that you have a Brother Web Connect access ID, you must register this ID on your machine, and then use your machine to access the web service you want to use.



Related Information

- [Set Up Brother Web Connect](#)

Related Topics:

- [Register an Account on Your Brother Machine for Brother Web Connect](#)

Register an Account on Your Brother Machine for Brother Web Connect

Related Models: DCP-L2660DW/DCP-L2665DW/MFC-L2860DWE/MFC-L2860DW/MFC-L2862DW/MFC-L2922DW/MFC-L2960DW/MFC-L2980DW

You must enter your Brother Web Connect account information and configure your machine so that it can use Brother Web Connect to access the service you want.

- You must apply for Brother Web Connect access to register an account on your machine.
- Before you register an account, confirm that the correct date and time are set on the machine.

1. Press ◀ or ▶ to display the [Web] option.
2. Press [Web].



- If information regarding the Internet connection appears on the machine's LCD, read the information and press [OK]. If you want to display this information again, press [Yes].
- Occasionally, updates or announcements about Brother Web Connect's features will appear on the LCD. Read the information, and then press [OK].

3. If the information regarding licence agreement appears, make your selection and follow the on-screen instructions.
4. Press ▲ or ▼ to display the service with which you want to register.
5. Press the service name.
6. If information regarding Brother Web Connect appears, press [OK].
7. Press [Register/Delete].
8. Press [Register Account].
The machine will prompt you to enter the temporary ID you received when you applied for Brother Web Connect access.
9. Press [OK].
10. Enter the temporary ID using the LCD.
11. Press [OK].



An error message will appear on the LCD if the information you entered does not match the temporary ID you received when you applied for access, or if the temporary ID has expired. Enter the temporary ID correctly, or apply for access again to receive a new temporary ID.

The machine will prompt you to enter the account name that you want to be displayed on the LCD.

12. Press [OK].
13. Enter the name using the LCD.
14. Press [OK].
15. Do one of the following:
 - To set a PIN for the account, press [Yes]. (A PIN prevents unauthorised access to the account.) Enter a four-digit number, and then press [OK].
 - If you do not want to set a PIN, press [No].
16. When the account information you entered appears, confirm that it is correct.
17. Press [Yes] to register your information as entered.
18. Press [OK].
19. Press .

Registration is complete and your machine can now access the service.



Related Information

- [Set Up Brother Web Connect](#)

Related Topics:

- [How to Enter Text on Your Machine](#)
 - [Apply for Brother Web Connect Access](#)
-

Scan and Upload Documents Using Brother Web Connect

Related Models: DCP-L2660DW/DCP-L2665DW/MFC-L2860DWE/MFC-L2860DW/MFC-L2862DW/MFC-L2922DW/MFC-L2960DW/MFC-L2980DW

Upload your scanned photos and documents directly to a web service without using a computer.

Uploaded documents are saved in an album named **From_BrotherDevice**.

For information regarding restrictions, such as the size or number of documents that can be uploaded, refer to the respective service's website.

If you are a restricted Web Connect user, due to the enabled Secure Function Lock feature (available for certain models), you cannot upload the scanned data.

1. [Load your document](#).
2. Press ◀ or ▶ to display the [Web] option.
3. Press [Web].



- If information regarding the Internet connection appears on the machine's LCD, read the information and press [OK]. If you want to display this information again, press [Yes].
- Occasionally, updates or announcements about Brother Web Connect's features will appear on the LCD. Read the information, and then press [OK].

4. Press ▲ or ▼ to display the service that hosts the account to which you want to upload. Press the service name.
5. Press ▲ or ▼ to display your account name, and then press it.
6. Follow the on-screen instructions to complete this operation.



Related Information

- [Brother Web Connect](#)

Download and Print Documents Using Brother Web Connect

Related Models: DCP-L2660DW/DCP-L2665DW/MFC-L2860DWE/MFC-L2860DW/MFC-L2862DW/MFC-L2922DW/MFC-L2960DW/MFC-L2980DW

Documents that have been uploaded to your account can be downloaded directly to your machine and printed. Documents that other users have uploaded to their own accounts for sharing can also be downloaded to your machine and printed, as long as you have viewing privileges for those documents.

If you are a restricted user for Brother Web Connect due to the enabled Secure Function Lock feature (available for certain models), you cannot download the data.

The Secure Function Lock Page Limit feature also applies to print jobs sent using Brother Web Connect.



For Hong Kong, Taiwan and Korea:

Brother Web Connect supports only file names written in English. Files named in the local language will not be downloaded.



Related Information

- [Brother Web Connect](#)
 - [Download and Print Using Web Services](#)

Download and Print Using Web Services

Related Models: DCP-L2660DW/DCP-L2665DW/MFC-L2860DWE/MFC-L2860DW/MFC-L2862DW/MFC-L2922DW/MFC-L2960DW/MFC-L2980DW

1. Press ◀ or ▶ to display the [Web] option.
2. Press [Web].



- If information regarding the Internet connection appears on the machine's LCD, read the information and press [OK]. If you want to display this information again, press [Yes].
- Occasionally, updates or announcements about Brother Web Connect's features will appear on the LCD. Read the information, and then press [OK].

3. Press ▲ or ▼ to display the service that hosts the document you want to download and print. Press the service name.
4. To log on to the service, press ▲ or ▼ to display your account name, and then press it. If the PIN entry screen appears, enter the four-digit PIN and press [OK].



Depending on the service, you may have to select the account name from a list.

5. Press [Download: Print].
6. Press ▲ or ▼ to display the folder you want, and then press it. Some services do not require documents to be saved in folders. For documents not saved in folders, select [See Unsorted Files] to select documents.
7. Press the thumbnail of the document you want to print. Confirm the document on the LCD and then press [OK]. Select additional documents to print (you can select up to 10 documents).
8. When finished, press [OK].
9. Follow the on-screen instructions to complete this operation.



Related Information

- [Download and Print Documents Using Brother Web Connect](#)

Related Topics:

- [How to Enter Text on Your Machine](#)

FaxForward to Cloud or E-mail

Related Models: MFC-L2860DWE/MFC-L2860DW/MFC-L2862DW/MFC-L2922DW/MFC-L2960DW/MFC-L2980DW

- Use the FaxForward to Cloud feature to automatically forward incoming faxes to your accounts with the available online services.

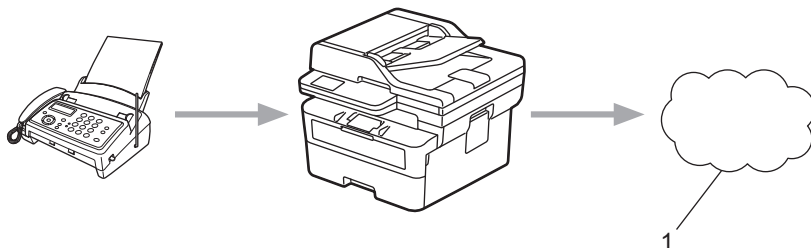

1. Web Service

- Use the FaxForward to E-mail feature to automatically forward incoming faxes to an inbox as email attachments.

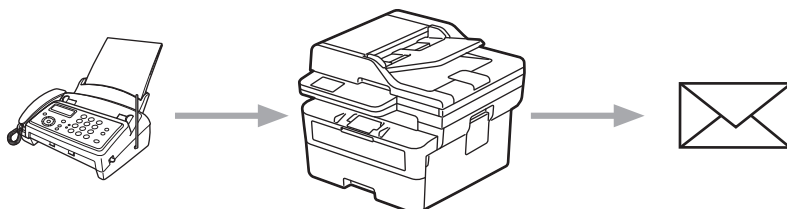

✓ Related Information

- [Brother Web Connect](#)
 - [Use FaxForward to Forward a Fax to the Cloud or an Email](#)
 - [Stop Using FaxForward to Forward a Fax to an Email or a Cloud location](#)

Use FaxForward to Forward a Fax to the Cloud or an Email

Related Models: MFC-L2860DWE/MFC-L2860DW/MFC-L2862DW/MFC-L2922DW/MFC-L2960DW/MFC-L2980DW

Turn the FaxForward feature on to automatically forward incoming faxes to either an online service or an inbox as email attachments.

- If you are a restricted Apps or Fax Receive user, due to the enabled Secure Function Lock feature (available for certain models), you cannot upload the incoming faxes.
- This feature is available only for monochrome faxes.
- If you turn the FaxForward to Cloud feature on, you cannot use the following options:
 - [Fax Forward]
 - [Fax Storage]
 - [PC Fax Receive]
 - [Forward to Network]

1. Press ◀ or ▶ to display the [Apps] option.
2. Press [Apps].



- If information regarding the Internet connection appears on the machine's LCD, read the information and press [OK]. If you want to display this information again, press [Yes].
- Occasionally, updates or announcements about Brother Web Connect's features will appear on the LCD. Read the information, and then press [OK].

3. Select [FaxForward to Cloud/E-mail].



If information regarding [FaxForward to Cloud/E-mail] appears, read it, and then press [OK].

4. Press [On].
5. Press [Forward to Cloud] or [Forward to E-mail].
 - If you selected [Forward to Cloud], select the online service you want to use to receive faxes, and then specify your account name.
 - If you selected [Forward to E-mail], enter the email address you want to use to receive faxes as email attachments.
6. Follow the on-screen instructions to complete this operation.



Related Information

- [FaxForward to Cloud or E-mail](#)

Stop Using FaxForward to Forward a Fax to an Email or a Cloud location

Related Models: MFC-L2860DWE/MFC-L2860DW/MFC-L2862DW/MFC-L2922DW/MFC-L2960DW/MFC-L2980DW

Turn the FaxForward feature off when you want to stop incoming faxes from automatically going to either an online service or an inbox as email attachments.

If there are received faxes still in your machine's memory, you cannot turn the FaxForward feature off.

1. Press ◀ or ▶ to display the [Apps] option.
2. Press [Apps].



- If information regarding the Internet connection appears on the machine's LCD, read the information and press [OK]. If you want to display this information again, press [Yes].
- Occasionally, updates or announcements about Brother Web Connect's features will appear on the LCD. Read the information, and then press [OK].

3. Select [FaxForward to Cloud/E-mail].



If information regarding [FaxForward to Cloud/E-mail] appears, read it, and then press [OK].

4. Press [Off].
5. Press [OK].



Related Information

- [FaxForward to Cloud or E-mail](#)

AirPrint

- [AirPrint Overview](#)
- [Before Using AirPrint \(macOS\)](#)
- [Print Using AirPrint](#)
- [Scan Using AirPrint \(macOS\)](#)
- [Send a Fax Using AirPrint \(macOS\)](#)

AirPrint Overview

Related Models: DCP-L2620DW/DCP-L2622DW/DCP-L2627DW/DCP-L2627DWXL/DCP-L2627DWE/DCP-L2640DN/DCP-L2660DW/DCP-L2665DW/MFC-L2802DN/MFC-L2800DW/MFC-L2802DW/MFC-L2827DWXL/MFC-L2827DW/MFC-L2835DW/MFC-L2860DWE/MFC-L2860DW/MFC-L2862DW/MFC-L2922DW/MFC-L2960DW/MFC-L2980DW

AirPrint is a printing solution for Apple operating systems that allows you to wirelessly print photos, email, web pages, and documents from your iPad, iPhone, iPod touch, and Mac computer without the need to install a driver.

(MFC-L2802DN/MFC-L2800DW/MFC-L2802DW/MFC-L2827DWXL/MFC-L2827DW/MFC-L2835DW/MFC-L2860DWE/MFC-L2860DW/MFC-L2862DW/MFC-L2922DW/MFC-L2960DW/MFC-L2980DW)

AirPrint also allows you to send faxes directly from your Mac computer without having to print them and allows you to scan documents to your Mac computer.

(DCP-L2620DW/DCP-L2622DW/DCP-L2627DW/DCP-L2627DWXL/DCP-L2627DWE/DCP-L2640DN/DCP-L2660DW/DCP-L2665DW)

AirPrint also allows you to scan documents to your Mac computer.

For more information, visit Apple's website.

Use of the Works with Apple badge means that an accessory has been designed to work specifically with the technology identified in the badge and has been certified by the developer to meet Apple performance standards.



✓ Related Information

- [AirPrint](#)

Related Topics:

- [AirPrint Problems](#)

Before Using AirPrint (macOS)

Related Models: DCP-L2620DW/DCP-L2622DW/DCP-L2627DW/DCP-L2627DWXL/DCP-L2627DWE/DCP-L2640DN/DCP-L2660DW/DCP-L2665DW/MFC-L2802DN/MFC-L2800DW/MFC-L2802DW/MFC-L2827DWXL/MFC-L2827DW/MFC-L2835DW/MFC-L2860DWE/MFC-L2860DW/MFC-L2862DW/MFC-L2922DW/MFC-L2960DW/MFC-L2980DW

Before printing using macOS, add your machine to the printer list on your Mac computer.

1. Do one of the following:
 - macOS v13
Select **System Settings** from the Apple menu.
 - macOS v12 and macOS v11
Select **System Preferences** from the Apple menu.
2. Select **Printers & Scanners**.
3. Do one of the following:
 - macOS v13
Click **Add Printer, Scanner, or Fax....**
 - macOS v12 and macOS v11
Click the + icon below the Printers pane on the left.
The **Add Printer** screen appears.
4. Do one of the following:
 - macOS v13 and macOS v12
Select your machine, and then select your model's name from the **Use** pop-up menu.
 - macOS v11
Select your machine, and then select **AirPrint** from the **Use** pop-up menu.
5. Click **Add**.



Related Information

- [AirPrint](#)



Print Using AirPrint

- [Print from iPad, iPhone, or iPod touch](#)
- [Print Using AirPrint \(macOS\)](#)

Print from iPad, iPhone, or iPod touch

Related Models: DCP-L2620DW/DCP-L2622DW/DCP-L2627DW/DCP-L2627DWXL/DCP-L2627DWE/DCP-L2640DN/DCP-L2660DW/DCP-L2665DW/MFC-L2802DN/MFC-L2800DW/MFC-L2802DW/MFC-L2827DWXL/MFC-L2827DW/MFC-L2835DW/MFC-L2860DWE/MFC-L2860DW/MFC-L2862DW/MFC-L2922DW/MFC-L2960DW/MFC-L2980DW

The procedure used to print may vary by application. Safari is used in the example below.

1. Make sure your machine is turned on.
2. Load the paper in the paper tray and change the paper tray settings on your machine.
3. Use Safari to open the page that you want to print.
4. Tap  or .
5. Tap **Print**.
6. Make sure your machine is selected.
7. If a different machine (or no machine) is selected, tap **Printer**.
A list of available machines appears.
8. Tap your machine's name in the list.
9. Select the options you want, such as the number of pages to print and 2-sided printing (if supported by your machine).
10. Tap **Print**.

Related Information

- [Print Using AirPrint](#)

Print Using AirPrint (macOS)

Related Models: DCP-L2620DW/DCP-L2622DW/DCP-L2627DW/DCP-L2627DWXL/DCP-L2627DWE/DCP-L2640DN/DCP-L2660DW/DCP-L2665DW/MFC-L2802DN/MFC-L2800DW/MFC-L2802DW/MFC-L2827DWXL/MFC-L2827DW/MFC-L2835DW/MFC-L2860DWE/MFC-L2860DW/MFC-L2862DW/MFC-L2922DW/MFC-L2960DW/MFC-L2980DW

The procedure used to print may vary by application. Safari is used in the example below. Before printing, make sure your machine is in the printer list on your Mac computer.

1. Make sure your machine is turned on.
2. Load the paper in the paper tray and change the paper tray settings on your machine.
3. On your Mac computer, use Safari to open the page that you want to print.
4. Click the **File** menu, and then select **Print**.
5. Make sure your machine is selected. If a different machine (or no machine) is selected, click the **Printer** pop-up menu, and then select your machine.
6. Select the desired options, such as the number of pages to print and 2-sided printing (if supported by your machine).
7. Click **Print**.

✓ Related Information

- [Print Using AirPrint](#)

Related Topics:

- [Before Using AirPrint \(macOS\)](#)

Scan Using AirPrint (macOS)

Related Models: DCP-L2620DW/DCP-L2622DW/DCP-L2627DW/DCP-L2627DWXL/DCP-L2627DWE/DCP-L2640DN/DCP-L2660DW/DCP-L2665DW/MFC-L2802DN/MFC-L2800DW/MFC-L2802DW/MFC-L2827DWXL/MFC-L2827DW/MFC-L2835DW/MFC-L2860DWE/MFC-L2860DW/MFC-L2862DW/MFC-L2922DW/MFC-L2960DW/MFC-L2980DW

Before scanning, make sure your machine is in the scanner list on your Mac computer.

1. [Load your document.](#)
2. Do one of the following:
 - macOS v13
Select **System Settings** from the Apple menu.
 - macOS v12 and macOS v11
Select **System Preferences** from the Apple menu.
3. Select **Printers & Scanners**.
4. Select your machine from the scanner list.
5. Do one of the following:
 - macOS v13
Click the **Open Scanner...** button.
 - macOS v12 and macOS v11
Click the **Scan** tab, and then click the **Open Scanner...** button.The Scanner screen appears.
6. If you place the document in the ADF, select **Use Document Feeder** checkbox, and then select the size of your document from the scan size setting pop-up menu.
7. Select the destination folder or destination application from the destination setting pop-up menu.
8. Click **Show Details** to change the scanning settings if needed.
You can crop the image manually by dragging the mouse pointer over the portion you want to scan when scanning from the scanner glass.
9. Click **Scan**.

Related Information

- [AirPrint](#)

Related Topics:

- [Before Using AirPrint \(macOS\)](#)

Send a Fax Using AirPrint (macOS)

Related Models: MFC-L2802DN/MFC-L2800DW/MFC-L2802DW/MFC-L2827DWXL/MFC-L2827DW/
MFC-L2835DW/MFC-L2860DWE/MFC-L2860DW/MFC-L2862DW/MFC-L2922DW/MFC-L2960DW/
MFC-L2980DW

Make sure your machine is in the printer list on your Mac computer. Apple TextEdit is used in the example below.



AirPrint supports only monochrome fax documents.

1. Make sure your machine is turned on.
2. On your Mac computer, open the file that you want to send as a fax.
3. Click the **File** menu, and then select **Print**.
4. Click the **Printer** pop-up menu, and then select your model with **- Fax** in the name.
5. Type the fax recipient information.
6. Click **Fax**.



Related Information

- [AirPrint](#)

Related Topics:

- [PC-FAX for Mac](#)
- [Before Using AirPrint \(macOS\)](#)

Mopria™ Print Service and Mopria™ Scan

Related Models: DCP-L2620DW/DCP-L2622DW/DCP-L2627DW/DCP-L2627DWXL/DCP-L2627DWE/
DCP-L2640DN/DCP-L2660DW/DCP-L2665DW/MFC-L2802DN/MFC-L2800DW/MFC-L2802DW/
MFC-L2827DWXL/MFC-L2827DW/MFC-L2835DW/MFC-L2860DWE/MFC-L2860DW/MFC-L2862DW/
MFC-L2922DW/MFC-L2960DW/MFC-L2980DW

Mopria™ Print Service is a print feature and Mopria™ Scan is a scan feature on Android™ mobile devices developed by the Mopria Alliance™. With this service, you can connect to the same network as your machine to print and scan without additional setup.

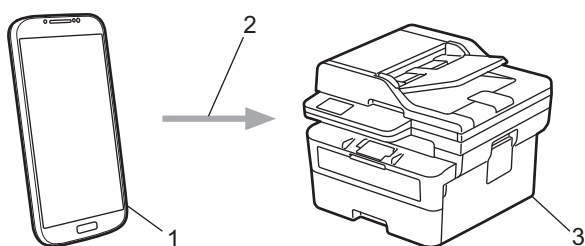

1. Android™ Mobile Device
2. Wi-Fi® Connection
3. Your Machine

You must download the Mopria™ Print Service or Mopria™ Scan from Google Play™ and install it on your Android™ device. Before using these Mopria™ features, make sure you enable them on your mobile device.



Related Information

- [Mobile/Web Connect](#)

Brother Mobile Connect

Related Models: DCP-L2620DW/DCP-L2622DW/DCP-L2627DW/DCP-L2627DWXL/DCP-L2627DWE/DCP-L2640DN/DCP-L2660DW/DCP-L2665DW/MFC-L2802DN/MFC-L2800DW/MFC-L2802DW/MFC-L2827DWXL/MFC-L2827DW/MFC-L2835DW/MFC-L2860DWE/MFC-L2860DW/MFC-L2862DW/MFC-L2922DW/MFC-L2960DW/MFC-L2980DW

Use Brother Mobile Connect to print and scan from your mobile device.

- For Android™ devices:

Brother Mobile Connect allows you to use your Brother machine's features directly from your Android™ device.

Download and install Brother Mobile Connect from Google Play™.

- For all iOS or iPadOS supported devices including iPhone, iPad, and iPod touch:

Brother Mobile Connect allows you to use your Brother machine's features directly from your iOS or iPadOS device.

Download and install Brother Mobile Connect from the App Store.



Related Information

- [Mobile/Web Connect](#)

Related Topics:

- [Access Brother iPrint&Scan \(Windows/Mac\)](#)

Troubleshooting

Use this section to resolve typical problems you may encounter when using your machine. You can correct most problems yourself.

IMPORTANT

For technical help, you must call Brother customer service or your local Brother dealer.

(MFC-L2802DN/MFC-L2800DW/MFC-L2802DW/MFC-L2827DWXL/MFC-L2827DW/MFC-L2835DW)

To prevent you from losing the received fax data in the machine's memory, transfer the data to another Fax machine or to your computer before turning off the machine.



If you need additional help, visit support.brother.com.

First, check the following:

- The machine's power cord is connected correctly and the machine's power is on. See the *Quick Setup Guide*.
- All of the protective materials have been removed. See the *Quick Setup Guide*.
- Paper is loaded correctly in the paper tray.
- The interface cables are securely connected to the machine and the computer, or the wireless connection is set up on both the machine and your computer.
- Error and maintenance messages

If you did not solve the problem with the checks, identify the problem and then see *Related Information*.



Related Information

- [Error and Maintenance Messages](#)
- [Error Messages When Using the Brother Web Connect Feature](#)
- [Document Jams](#)
- [Paper Jams](#)
- [Printing Problems](#)
- [Improve the Print Quality](#)
- [Telephone and Fax Problems](#)
- [Network Problems](#)
- [AirPrint Problems](#)
- [Other Problems](#)
- [Check the Machine Information](#)
- [Update Your Machine's Firmware](#)
- [Reset Your Machine](#)

Error and Maintenance Messages

As with any sophisticated office product, errors may occur and supply items may have to be replaced. If this happens, your machine identifies the error or required routine maintenance and shows the appropriate message. The most common error and maintenance messages are shown in the table.

Follow the instructions in the **Action** column to solve the error and remove the message.



You can correct most errors and perform routine maintenance by yourself. If you need more tips: Visit support.brother.com/faqs.

>> DCP-L2600D/DCP-L2620DW/DCP-L2622DW/DCP-L2627DW/DCP-L2627DWXL/DCP-L2627DWE/
DCP-L2640DN/MFC-L2802DN/MFC-L2800DW/MFC-L2802DW/MFC-L2827DWXL/MFC-L2827DW/
MFC-L2835DW

>> DCP-L2660DW/DCP-L2665DW/MFC-L2860DWE/MFC-L2860DW/MFC-L2862DW/MFC-L2922DW/
MFC-L2960DW/MFC-L2980DW

DCP-L2600D/DCP-L2620DW/DCP-L2622DW/DCP-L2627DW/DCP-L2627DWXL/ DCP-L2627DWE/DCP-L2640DN/MFC-L2802DN/MFC-L2800DW/MFC-L2802DW/ MFC-L2827DWXL/MFC-L2827DW/MFC-L2835DW

| Error Message | Cause | Action |
|-------------------------------|-------------------------------------------------------------------------------------------------|-----------------------------------------------------------------------------------------------------------------------------------------------------------------------------------------------------------------------------------------------------------------------------------------------------------------------------------------------------------------------------------------------------------------------------------------------------------------------------------------------------------------------------------------------------------------------------------------------------|
| 2-sided Disabled | The back cover of the machine is not closed completely. | Close the back cover of the machine until it locks in the closed position. |
| | The 2-sided tray is not installed completely. | Install the 2-sided tray firmly in the machine. |
| BT Call Sign On (For U.K.) | The BT Call Sign setting is on. You cannot change the Receive Mode from Manual to another mode. | Set the BT Call Sign setting to off. |
| Cannot Detect | Your machine cannot detect the drum unit. | Remove the toner cartridge and drum unit assembly. Remove the toner cartridge from the drum unit, and reinstall the toner cartridge back in the drum unit. Reinstall the toner cartridge and drum unit assembly back in the machine. |
| | Your machine cannot detect the toner cartridge. | |
| Cannot Print ## | The machine has a mechanical problem. | <ul style="list-style-type: none"> (MFC-L2802DN/MFC-L2800DW/ MFC-L2802DW/ MFC-L2827DWXL/ MFC-L2827DW/MFC-L2835DW) To prevent you from losing the received fax data in the machine's memory, transfer the data to another Fax machine or to your computer before turning off the machine. Press and hold  to turn the machine off, wait a few minutes, and then turn it on again. If the problem continues, contact Brother customer service or your local Brother dealer. |
| Cannot Scan ## | The machine has a mechanical problem. | <ul style="list-style-type: none"> (MFC-L2802DN/MFC-L2800DW/ MFC-L2802DW/ MFC-L2827DWXL/ MFC-L2827DW/MFC-L2835DW) To prevent you from losing the received fax data in the machine's memory, transfer the data to |

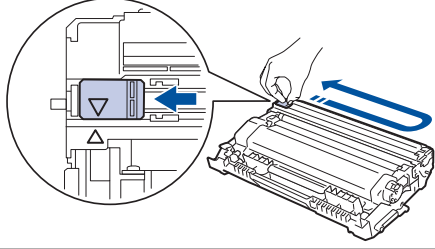

| Error Message | Cause | Action |
|-------------------------------------------------------------|---------------------------------------------------------------------------------------------------------------------------------------------------------------------------------------------------------------------|----------------------------------------------------------------------------------------------------------------------------------------------------------------------------------------------------------------------------------------------------------------------------------------------------------------------------------------------------------------------------------------------------------------------------------------------------------------|
| | | <p>another Fax machine or to your computer before turning off the machine.</p> <ul style="list-style-type: none"> Remove the document. <p>Press and hold  to turn the machine off, and then turn it on again.</p> <ul style="list-style-type: none"> If the problem continues, contact Brother customer service or your local Brother dealer. |
| Cartridge Error Put the Black (BK) Toner Cartridge back in. | The toner cartridge is not installed correctly. | <p>Pull out the drum unit and toner cartridge assembly, take out the toner cartridge, and put it back in the drum unit again. Put the drum unit and toner cartridge assembly back in the machine.</p> <p>If the problem continues, contact Brother customer service or your local Brother dealer.</p> |
| Comm. Error | Poor telephone line quality caused a communication error. | Send the fax again or connect the machine to another telephone line. If the problem continues, contact your telephone company and ask them to check the telephone line. |
| Cooling Down | The temperature of the inside of the machine is too hot. The machine will pause its current print job and enter cooling down mode. While the machine cools, the cooling fan runs and the LCD displays Cooling Down. | <p>Wait until the machine has finished cooling down. Make sure all vents on the machine are clear of obstructions. When the machine has cooled down, it will resume printing.</p> <p>If the fan is not spinning, disconnect the machine from the power for several minutes, then reconnect it.</p> |
| Cover is Open | The front cover is not completely closed. | Open and then firmly close the front cover of the machine. |
| | The fuser cover is not completely closed or paper was jammed in the back of the machine when you turned on the power. | Close the fuser cover located inside the back cover of the machine. |
| | The ADF cover is not completely closed. | <p>Close the ADF cover.</p> <p>Press and hold  to turn the machine off, wait a few minutes, and then turn it on again.</p> <p>If the problem continues, contact Brother customer service or your local Brother dealer.</p> |
| Disconnected | The other person or other person's fax machine stopped the call. | <p>Try to send or receive again.</p> <p>If calls are stopped repeatedly and you are using a VoIP (Voice over IP) system, try changing the Compatibility to Basic (for VoIP).</p> |
| Document Jam | The document was not inserted or fed correctly, or the document scanned from the ADF was too long. | <p>Remove the jammed paper from the ADF unit.</p> <p>Clear any debris or scraps of paper from the ADF unit paper path.</p> <p>Press Stop/Exit.</p> |



| Error Message | Cause | Action |
|------------------------------------------|-----------------------------------------------------------------------------------------------------------------------------------------------|------------------------------------------------------------------------------------------------------------------------------------------------------------------------------------------------------------------------------------------------------------------------------------------------------------------|
| Drum ! Slide the Green tab on Drum Unit. | The corona wire on the drum unit must be cleaned. | Clean the corona wire on the drum unit.  |
| | The drum unit or the toner cartridge and drum unit assembly is not installed correctly. | Put the toner cartridge in the drum unit. Then reinstall the toner cartridge and drum unit assembly in the machine. |
| Drum End Soon | The drum unit is near the end of its life. | Order a new drum unit before you get the Replace Drum message. |
| Jam 2-sided | The paper is jammed in the 2-sided paper tray. | Pull the paper tray and the 2-sided tray out completely, open the back cover and then remove all jammed paper. Close the back cover, and put the paper tray and the 2-sided tray firmly back in the machine. |
| Jam Inside | The paper is jammed inside the machine. | Open the front cover and remove the toner cartridge and drum unit assembly. Pull out all jammed paper. Close the front cover. If the error message remains, press Start . |
| Jam Rear | The paper is jammed in the back of the machine. | Open the fuser cover and remove all jammed paper. Close the fuser cover. If the error message remains, press Start . |
| Jam Tray 1 | The paper is jammed in the indicated paper tray. | Pull the paper tray out completely and gently remove all jammed paper. Put the paper tray firmly back in the machine. |
| Manual Feed | Manual was selected as the paper source in the printer driver, but there is no paper in the manual feed slot. | Place paper in the manual feed slot. |
| Media Mismatch | The media type specified in the printer driver differs from the paper type specified in the machine's menu. | Load the correct type of paper in the tray indicated on the LCD, or select the correct media type in the Paper Type setting on the machine. |
| No Caller ID | There is no incoming call history. You did not receive calls or you have not subscribed to the Caller ID service from your telephone company. | If you want to use the Caller ID feature, call your telephone company. |
| No Paper T1 | The machine is out of paper, or paper is not loaded correctly in the paper trays. | <ul style="list-style-type: none"> • Refill paper in the paper trays. Make sure the paper guides are set to the correct size. • If paper is in the tray, remove it and load it again. Make sure the paper guides are set to the correct size. • Do not overfill the paper tray. |
| No Response/Busy | The number you dialed does not answer or is busy. | Verify the number and try again. |

| Error Message | Cause | Action |
|----------------------------------------------------------------------------------|------------------------------------------------------------------------------------------------------------------------------------------------------|-------------------------------------------------------------------------------------------------------------------------------------------------------------------------------------------------------------------------------------------------------------------------------------------------------------------------------------------------------------------------------------------------------------------------------------------------------------------------------------------------------------------------------------------------------------------------------------------------------------------------------------------------------------------------------|
| No Toner | The toner cartridge or the toner cartridge and drum unit assembly is not installed correctly. | Remove the toner cartridge and drum unit assembly. Remove the toner cartridge from the drum unit, and reinstall the toner cartridge back in the drum unit. Reinstall the toner cartridge and drum unit assembly back in the machine. If the problem continues, replace the toner cartridge with a new one. <i>See Related Information: Replace the Toner Cartridge.</i> |
| Out of Memory | The machine's memory is full. | <p>If a fax-sending or copy operation is in process</p> <p>Do one of the following:</p> <ul style="list-style-type: none"> • Press Start to send or copy the scanned pages. • Press Stop/Exit and wait until the other operations in progress finish, and then try again. • Print the faxes that are in the memory. • Clear the data in the memory. To gain extra memory, you can turn off Memory Receive. <p>If a print operation is in process</p> <p>Do one of the following:</p> <ul style="list-style-type: none"> • Reduce the resolution. • Clear faxes from the memory. |
| Replace Drum | It is time to replace the drum unit. | Replace the drum unit. <i>See Related Information: Replace the Drum Unit.</i> |
| | If this message is displayed even after replacing the drum unit with new one, the drum unit counter was not reset. | Reset the drum unit counter. <i>See Related Information: Reset the Drum Counter.</i> |
| Replace Toner | The toner cartridge is at the end of its life. The machine stops all print operations. While memory is available, faxes are stored in the memory. | Replace the toner cartridge with a new one. <i>See Related Information: Replace the Toner Cartridge.</i> |
| Self-Diagnostic Turn the power off, then on again. Leave the machine for 15 min. | The fuser unit does not work correctly. | <ul style="list-style-type: none"> • (MFC-L2802DN/MFC-L2800DW/ MFC-L2802DW/ MFC-L2827DWXL/ MFC-L2827DW/MFC-L2835DW) To prevent you from losing the received fax data in the machine's memory, transfer the data to another Fax machine or to your computer before turning off the machine. • Press and hold  to turn the machine off, wait a few seconds, and then turn it on again. Leave the machine idle for 15 minutes with the power on. |
| | The fuser unit is too hot. | |





| Error Message | Cause | Action |
|---------------|--------------------------------------------------------------------------------------------------------------------------------------|------------------------------------------------------------------------------------------------------------------------------------------------------------------------------------|
| Size Error DX | The paper size specified in the printer driver and the machine's paper size setting are not suitable for automatic 2-sided printing. | Press Stop/Exit . Choose a paper size suitable for 2-sided printing. The paper size suitable for automatic 2-sided printing is A4. |
| | The paper in the tray is not the correct size and is not suitable for automatic 2-sided printing. | Load the correct size of paper in the tray and set the tray for that paper size. The paper size suitable for automatic 2-sided printing is A4. |
| Size Mismatch | The paper in the tray is not the correct size. | Load the correct size of paper in the tray and set the size of paper to the tray. |
| Toner Ended | The toner cartridge is at the end of its life. The machine stops all print operations. | Replace the toner cartridge with a new one. |
| Toner Low | If the LCD displays this message, you can still print. The toner cartridge is near the end of its life. | Order a new toner cartridge now so a replacement toner cartridge is available when the LCD displays Replace Toner . |
| Wrong Toner | The installed toner cartridge is not correct for your machine. | Remove the toner cartridge from the drum unit, and install a toner cartridge with the correct supply product code. <i>See Related Information: Replace the Toner Cartridge.</i> |

**DCP-L2660DW/DCP-L2665DW/MFC-L2860DWE/MFC-L2860DW/MFC-L2862DW/
MFC-L2922DW/MFC-L2960DW/MFC-L2980DW**

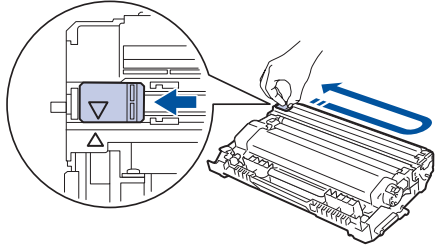
| Error Message | Cause | Action |
|-------------------------------|-------------------------------------------------------------------------------------------------|----------------------------------------------------------------------------------------------------------------------------------------------------------------------------------------------------------------------------------------------------------------------------------------------------------------------------------|
| 2-sided Disabled | The back cover of the machine is not closed completely. | Close the back cover of the machine until it locks in the closed position. |
| | The 2-sided tray is not installed completely. | Install the 2-sided tray firmly in the machine. |
| Access Denied | The function you want to use is restricted by Secure Function Lock 3.0. | Call your administrator to check your Secure Function Lock Settings. |
| BT Call Sign On (For U.K.) | The BT Call Sign setting is on. You cannot change the Receive Mode from Manual to another mode. | Set the BT Call Sign setting to off. |
| Cannot Detect | Your machine cannot detect the drum unit. | Remove the toner cartridge and drum unit assembly. Remove the toner cartridge from the drum unit, and reinstall the toner cartridge back in the drum unit. Reinstall the toner cartridge and drum unit assembly back in the machine. |
| | Your machine cannot detect the toner cartridge. | |
| Cannot Print ## | The machine has a mechanical problem. | <ul style="list-style-type: none"> Press and hold  to turn the machine off, wait a few minutes, and then turn it on again. If the problem continues, contact Brother customer service or your local Brother dealer. |
| Cannot Scan | The document is too long for 2-sided scanning. | Press  . Use an appropriate size paper for 2-sided scanning. |

| Error Message | Cause | Action |
|-----------------------------------------------------|-------------------------------------------------------------------------------------------------------------------------------------------------------------------------------------------------------------------------------------------------------|-----------------------------------------------------------------------------------------------------------------------------------------------------------------------------------------------------------------------------------------------------------------------------------------------------------------|
| Cannot Scan ## | The machine has a mechanical problem. | <ul style="list-style-type: none"> Press and hold  to turn the machine off, and then turn it on again. If the problem continues, contact Brother customer service or your local Brother dealer. |
| Cartridge Error Put the Toner Cartridge back in. | The toner cartridge is not installed correctly. | <p>Pull out the drum unit and toner cartridge assembly, take out the toner cartridge, and put it back in the drum unit again. Put the drum unit and toner cartridge assembly back in the machine.</p> <p>If the problem continues, contact Brother customer service or your local Brother dealer.</p> |
| Comm.Error | Poor telephone line quality caused a communication error. | Send the fax again or connect the machine to another telephone line. If the problem continues, contact your telephone company and ask them to check the telephone line. |
| Cooling Down | The temperature of the inside of the machine is too hot. The machine will pause its current print job and go into cooling down mode. During the cooling down mode, you will hear the cooling fan running while the LCD displays <i>Cooling Down</i> . | <p>Wait until the machine has finished cooling down. Make sure all vents on the machine are clear of obstructions. When the machine has cooled down, it will resume printing.</p> <p>If the fan is not spinning, disconnect the machine from the power for several minutes, then reconnect it.</p> |
| Cover is Open | The front cover is not completely closed. | Open and then firmly close the front cover of the machine. |
| | The fuser cover is not completely closed or paper was jammed in the back of the machine when you turned on the power. | Close the fuser cover located inside the back cover of the machine. |
| | The ADF cover is not completely closed. | <p>Close the ADF cover.</p> <p>Press and hold  to turn the machine off, wait a few minutes, and then turn it on again.</p> <p>If the problem continues, contact Brother customer service or your local Brother dealer.</p> |
| Disconnected | The other person or other person's fax machine stopped the call. | <p>Try to send or receive again.</p> <p>If calls are stopped repeatedly and you are using a VoIP (Voice over IP) system, try changing the Compatibility to Basic (for VoIP).</p> |
| Document Jam | The document was not inserted or fed correctly, or the document scanned from the ADF was too long. | <p>Remove the jammed paper from the ADF unit.</p> <p>Clear any debris or scraps of paper from the ADF unit paper path.</p> <p>Press .</p> |
| Drum ! | The corona wire on the drum unit must be cleaned. | Clean the corona wire on the drum unit. |

| Error Message | Cause | Action |
|---------------------|-----------------------------------------------------------------------------------------------------------------------------------------------|------------------------------------------------------------------------------------------------------------------------------------------------------------------------------------------------------------------------------------------------------------------------------------------------------------------|
| | |  |
| | The drum unit or the toner cartridge and drum unit assembly is not installed correctly. | Put the toner cartridge in the drum unit. Then reinstall the toner cartridge and drum unit assembly in the machine. |
| Drum End Soon | The drum unit is near the end of its life. | Order a new drum unit before you get the Replace Drum message. |
| Jam 2-sided | The paper is jammed in the 2-sided paper tray. | Pull the paper tray and the 2-sided tray out completely, open the back cover and then remove all jammed paper. Close the back cover, and put the paper tray and the 2-sided tray firmly back in the machine. |
| Jam Inside | The paper is jammed inside the machine. | Open the front cover and remove the toner cartridge and drum unit assembly. Pull out the jammed paper. Close the front cover. |
| Jam Rear | The paper is jammed in the back of the machine. | Open the fuser cover and remove all jammed paper. Close the fuser cover. If the error message remains, press Retry . |
| Jam Tray 1 | The paper is jammed in the indicated paper tray. | Pull the paper tray out completely and gently remove all jammed paper. Put the paper tray firmly back in the machine. |
| Limit Exceeded | The print limit set in Secure Function Lock 3.0 was reached. | Contact your administrator to check your Secure Function Lock settings. |
| Manual Feed | Manual was selected as the paper source in the printer driver, but there is no paper in the manual feed slot. | Place paper in the manual feed slot. |
| Media Type Mismatch | The media type specified in the printer driver differs from the paper type specified in the machine's menu. | Load the correct type of paper in the tray indicated on the LCD, or select the correct media type in the Paper Type setting on the machine. |
| No Caller ID | There is no incoming call history. You did not receive calls or you have not subscribed to the Caller ID service from your telephone company. | If you want to use the Caller ID feature, call your telephone company. |
| No Paper Tray1 | The machine is out of paper, or paper is not loaded correctly in the paper trays. | <ul style="list-style-type: none"> • Refill paper in the paper trays. Make sure the paper guides are set to the correct size. • If paper is in the tray, remove it and load it again. Make sure the paper guides are set to the correct size. • Do not overfill the paper tray. |
| No Response/Busy | The number you dialed does not answer or is busy. | Verify the number and try again. |

| Error Message | Cause | Action |
|-------------------|------------------------------------------------------------------------------------------------------------------------------------------------------|-----------------------------------------------------------------------------------------------------------------------------------------------------------------------------------------------------------------------------------------------------------------------------------------------------------------------------------------------------------------------------------------------------------------------------------------------------------------------------------------------------------------------------------------------------------------------------------------------------------------------------------------------------------------------------------------------------------------------------------------|
| No Toner | The toner cartridge or the toner cartridge and drum unit assembly is not installed correctly. | Remove the toner cartridge and drum unit assembly. Remove the toner cartridge from the drum unit, and reinstall the toner cartridge back in the drum unit. Reinstall the toner cartridge and drum unit assembly back in the machine. If the problem continues, replace the toner cartridge with a new one. <i>See Related Information: Replace the Toner Cartridge.</i> |
| Out of Fax Memory | The machine's fax memory is full. | If you are using the Fax Preview function, delete unwanted received fax data. To print fax data, press  Settings > All Settings > Fax > Print Document. |
| Out of Memory | The machine's memory is full. | If a fax-sending or copy operation is in process Do one of the following: <ul style="list-style-type: none"> • Press  or Quit, and wait until the other operations that are in progress finish, and then try again. • Press Send Now to send the pages scanned so far. • Clear the data in the memory. To gain extra memory, you can turn off Memory Receive. • Print the faxes that are in the memory. If a print operation is in process Do one of the following: <ul style="list-style-type: none"> • Reduce the resolution. • Clear faxes from the memory. |
| Print Data Full | The machine's memory is full. | Press  and delete the previously stored secure print data. |
| Replace Drum | It is time to replace the drum unit. | Replace the drum unit. <i>See Related Information: Replace the Drum Unit.</i> |
| | If this message is displayed even after replacing the drum unit with new one, the drum unit counter was not reset. | Reset the drum unit counter. <i>See Related Information: Reset the Drum Counter.</i> |
| Replace Toner | The toner cartridge is at the end of its life. The machine stops all print operations. While memory is available, faxes are stored in the memory. | Replace the toner cartridge with a new one. <i>See Related Information: Replace the Toner Cartridge.</i> |
| Self-Diagnostic | The fuser unit does not work correctly. | Press and hold  to turn the machine off, wait a few seconds, and then turn it on again. Leave the machine idle for 15 minutes with the power on. |
| | The fuser unit is too hot. | |

| Error Message | Cause | Action |
|-----------------------------------|--------------------------------------------------------------------------------------------------------------------------------------|-----------------------------------------------------------------------------------------------------------------------------------------------------------------------------------------------------------------|
| Size Error | The paper tray you selected does not support the paper size specified in the printer driver. | Change the printer driver setting or machine's tray setting so that the paper size selected in the printer driver matches the paper size loaded in the tray you selected. |
| Size Error 2-sided | The paper size specified in the printer driver and the machine's paper size setting are not suitable for automatic 2-sided printing. | Press  . Choose a paper size suitable for 2-sided printing. The paper size suitable for automatic 2-sided printing is A4. |
| | The paper in the tray is not the correct size and is not suitable for automatic 2-sided printing. | Load the correct size of paper in the tray and set the tray for that paper size. The paper size suitable for automatic 2-sided printing is A4. |
| Size Mismatch | The paper in the tray is not the correct size. | Load the correct size of paper in the tray and set the size of paper to the tray. |
| Toner Ended | The toner cartridge is at the end of its life. | Replace the toner cartridge with a new one. |
| Toner Low | If the LCD displays this message, you can still print. The toner cartridge is near the end of its life. | Order a new toner cartridge now so a replacement toner cartridge is available when the LCD shows <i>Replace Toner</i> . |
| Touchscreen Initialisation Failed | The touchscreen was pressed before the power on initialization was completed. | Make sure nothing is touching or resting on the touchscreen. |
| | Debris may be stuck between the lower part of the touchscreen and its frame. | Insert a piece of stiff paper between the lower part of the touchscreen and its frame and slide it back and forth to push out the debris. |
| Wrong Toner Cartridge | The installed toner cartridge is not correct for your machine. | Remove the toner cartridge from the drum unit, and install a toner cartridge with the correct supply product code. <i>See Related Information: Replace the Toner Cartridge.</i> |



Related Information

- [Troubleshooting](#)
 - [Unable to Print or Scan -Transfer Your Faxes](#)

Related Topics:

- [Replace the Toner Cartridge](#)
- [Replace the Drum Unit](#)
- [Clean the Corona Wire](#)
- [Print a Fax Stored in the Machine's Memory](#)
- [Load Paper](#)
- [Reset the Drum Counter](#)

Unable to Print or Scan -Transfer Your Faxes

Related Models: MFC-L2802DN/MFC-L2800DW/MFC-L2802DW/MFC-L2827DWXL/MFC-L2827DW/MFC-L2835DW/MFC-L2860DWE/MFC-L2860DW/MFC-L2862DW/MFC-L2922DW/MFC-L2960DW/MFC-L2980DW

If the LCD displays:

- [Cannot Print] ##
- [Cannot Scan] ##

We recommend transferring your faxes to another fax machine or to your computer.

You can also transfer the Fax Journal report to see if there are any faxes you must transfer.



If there is an error message on the LCD after you transfer the faxes, disconnect your Brother machine from the power source for several minutes, and then reconnect it.



Related Information

- [Error and Maintenance Messages](#)
 - [Transfer Faxes to Another Fax Machine](#)
 - [Transfer Faxes to Your Computer](#)
 - [Transfer the Fax Journal Report to Another Fax Machine](#)

Transfer Faxes to Another Fax Machine

Related Models: MFC-L2802DN/MFC-L2800DW/MFC-L2802DW/MFC-L2827DWXL/MFC-L2827DW/MFC-L2835DW/MFC-L2860DWE/MFC-L2860DW/MFC-L2862DW/MFC-L2922DW/MFC-L2960DW/MFC-L2980DW

You must set up your Station ID before transferring faxes to another fax machine.

>> [MFC-L2802DN/MFC-L2800DW/MFC-L2802DW/MFC-L2827DWXL/MFC-L2827DW/MFC-L2835DW](#)

>> [MFC-L2860DWE/MFC-L2860DW/MFC-L2862DW/MFC-L2922DW/MFC-L2960DW/MFC-L2980DW](#)

MFC-L2802DN/MFC-L2800DW/MFC-L2802DW/MFC-L2827DWXL/MFC-L2827DW/MFC-L2835DW

1. Press **Menu**.
2. Press **▲** or **▼** to display the [Service] option, and then press **OK**.
3. Press **OK** to select [Data Transfer].
4. Press **▲** or **▼** to display the [Fax Transfer] option, and then press **OK**.
5. Do one of the following:
 - If the LCD shows [No Data], there are no faxes left in the machine's memory. Press **Stop/Exit**.
 - Enter the fax number to which faxes will be forwarded. Press **Start**.

MFC-L2860DWE/MFC-L2860DW/MFC-L2862DW/MFC-L2922DW/MFC-L2960DW/MFC-L2980DW

1. Press  [Settings] > [All Settings] > [Service] > [Data Transfer] > [Fax Transfer].
2. Do one of the following:
 - If the LCD shows [No Data], there are no faxes left in the machine's memory. Press [Close].
 - Enter the fax number to which faxes will be forwarded.
3. Press [Fax Start].

✓ Related Information

- [Unable to Print or Scan -Transfer Your Faxes](#)

Related Topics:

- [Set Your Station ID](#)

Transfer Faxes to Your Computer



Related Models: MFC-L2802DN/MFC-L2800DW/MFC-L2802DW/MFC-L2827DWXL/MFC-L2827DW/MFC-L2835DW/MFC-L2860DWE/MFC-L2860DW/MFC-L2862DW/MFC-L2922DW/MFC-L2960DW/MFC-L2980DW

>> [MFC-L2802DN/MFC-L2800DW/MFC-L2802DW/MFC-L2827DWXL/MFC-L2827DW/MFC-L2835DW](#)
>> [MFC-L2860DWE/MFC-L2860DW/MFC-L2862DW/MFC-L2922DW/MFC-L2960DW/MFC-L2980DW](#)

MFC-L2802DN/MFC-L2800DW/MFC-L2802DW/MFC-L2827DWXL/MFC-L2827DW/MFC-L2835DW

1. Make sure you have installed the software and drivers on your computer.
2. Launch  (**Brother Utilities**), and then click the drop-down list and select your model name (if not already selected). Click **PC-FAX** in the left navigation bar, and then click **Receive**.
The **PC-FAX Receive** window appears.
3. Make sure you have set [PC Fax Receive] on the machine.
If faxes are in the machine's memory when you set up PC-Fax Receive, the LCD displays [Send Fax to PC?].
4. Do one of the following:
 - To transfer all faxes to your computer, press ▲ or ▼ to select [Yes], and then press **OK**.
 - To exit and leave the faxes in the memory, press ▲ or ▼ to select [No], and then press **OK**.
5. Press **Stop/Exit**.

MFC-L2860DWE/MFC-L2860DW/MFC-L2862DW/MFC-L2922DW/MFC-L2960DW/MFC-L2980DW

1. Make sure you have installed the software and drivers on your computer.
2. Launch  (**Brother Utilities**), and then click the drop-down list and select your model name (if not already selected). Click **PC-FAX** in the left navigation bar, and then click **Receive**.
The **PC-FAX Receive** window appears.
3. Make sure you have set [PC Fax Receive] on the machine.
If faxes are in the machine's memory when you set up PC-Fax Receive, the LCD displays [Send Fax to PC?].
4. Do one of the following:
 - To transfer all faxes to your computer, press [Yes].
 - To exit and leave the faxes in the memory, press [No].
5. Press .

Related Information

- [Unable to Print or Scan -Transfer Your Faxes](#)

Transfer the Fax Journal Report to Another Fax Machine

Related Models: MFC-L2802DN/MFC-L2800DW/MFC-L2802DW/MFC-L2827DWXL/MFC-L2827DW/MFC-L2835DW/MFC-L2860DWE/MFC-L2860DW/MFC-L2862DW/MFC-L2922DW/MFC-L2960DW/MFC-L2980DW

You must set up your Station ID before transferring the Fax Journal report to another fax machine.

>> [MFC-L2802DN/MFC-L2800DW/MFC-L2802DW/MFC-L2827DWXL/MFC-L2827DW/MFC-L2835DW](#)

>> [MFC-L2860DWE/MFC-L2860DW/MFC-L2862DW/MFC-L2922DW/MFC-L2960DW/MFC-L2980DW](#)

MFC-L2802DN/MFC-L2800DW/MFC-L2802DW/MFC-L2827DWXL/MFC-L2827DW/MFC-L2835DW

1. Press **Menu**.
2. Press **▲** or **▼** to display the [Service] option, and then press **OK**.
3. Press **OK** to select [Data Transfer].
4. Press **▲** or **▼** to display the [Report Trans.] option, and then press **OK**.
5. Enter the destination fax number for the Fax Journal.
6. Press **Start**.

MFC-L2860DWE/MFC-L2860DW/MFC-L2862DW/MFC-L2922DW/MFC-L2960DW/MFC-L2980DW

1. Press  [Settings] > [All Settings] > [Service] > [Data Transfer] > [Report Transfer].
2. Enter the destination fax number for the Fax Journal.
3. Press [Fax Start].

Related Information

- [Unable to Print or Scan -Transfer Your Faxes](#)

Related Topics:

- [Set Your Station ID](#)
- [Configure Date and Time Using Web Based Management](#)

Error Messages When Using the Brother Web Connect Feature

Related Models: DCP-L2660DW/DCP-L2665DW/MFC-L2860DWE/MFC-L2860DW/MFC-L2862DW/MFC-L2922DW/MFC-L2960DW/MFC-L2980DW

Your machine displays an error message if an error occurs. The most common error messages are shown in the table.

You can correct most errors yourself. If, after reading this table, you still need help, see the latest troubleshooting tips at support.brother.com/faqs.

Connection Error

| Error Messages | Cause | Action |
|--------------------------------------------------------------------------------------------------|-----------------------------------------------------------------------------------------------------------------------------------------------------|--------------------------------------------------------------------------------------------------------------------------------------------------------------------------------------------------------------------------------------------------------------------------------------------------------------------------------------------------------------------------------------------------------------------------------------|
| Connection Error 02 Network connection failed. Verify that the network connection is good. | The machine is not connected to a network. | <ul style="list-style-type: none"> Make sure the eligible IP address is assigned to your machine. Check your access point/router is active and the Internet connection is established. Make sure the wireless router/access point is on. If the Web button was pressed soon after the machine was turned on, the network connection may not have been established yet. Wait and try again. |
| Connection Error 03 Connection failed to server. Check network settings. | <ul style="list-style-type: none"> Network or server settings are incorrect. There is a problem with the network or server. | <ul style="list-style-type: none"> Confirm that network settings are correct, or wait and try again later. If the Web button was pressed soon after the machine was turned on, the network connection may not have been established yet. Wait and try again. <p><i>See Related Information: Configure Date and Time Using Web Based Management.</i></p> |
| Connection Error 07 Connection failed to server. Wrong Date & Time. | Date and time settings are incorrect. | Set the date and time correctly. Note that if the machine's power cord is disconnected, the date and time settings may have reset to factory settings. |

Authentication Error

| Error Messages | Cause | Action |
|-------------------------------------------------------------------------------------------------------------------------------------------------------------------------------------------|--------------------------------------------------------------------------------------------------------------------------------------------------------|--------------------------------------------------------------------------------------------------------------------------------------------|
| Authentication Error 01 Incorrect PIN code. Enter PIN correctly. | The PIN you entered to access the account is incorrect. The PIN is the four-digit number that was entered when registering the account to the machine. | Enter the correct PIN. |
| Authentication Error 02 Incorrect or expired ID, or this temporary ID is already used. Enter correctly or reissue temporary ID. Temporary ID is valid for 24 hours after it is issued. | The temporary ID that was entered is incorrect. | Enter the correct temporary ID. |
| | The temporary ID that was entered has expired. A temporary ID is valid for 24 hours. | Apply for Brother Web Connect access again and receive a new temporary ID, and then use the new ID to register the account to the machine. |

| Error Messages | Cause | Action |
|--------------------------------------------------------------------------------------------------|-----------------------------------------------------------------------------------------------|---------------------------------|
| Authentication Error 03 Display name has already been registered. Enter another display name. | The name you entered as the display name has already been registered to another service user. | Enter a different display name. |

Server Error

| Error Messages | Cause | Action |
|-----------------------------------------------------------------------------------------------------------------------------------------------------------------------------------------------------------------------------|--------------------------------------------------------------------------------------------------------------------------------------------------------------------------------------------------------------------------------------------------------------------------------|------------------------------------------------------------------------------------------------------------------------------------------------------------------------------------------------------------------|
| Server Error 01 Authentication failed. Do the following: 1. Go to http://bwc.brother.com to get a new temporary ID. 2. Press OK and enter your new temporary ID in the next screen. | The machine's authentication information (needed to access the service) has expired or is invalid. | Apply for Brother Web Connect access again to receive a new temporary ID, and then use the new ID to register the account to the machine. |
| Server Error 03 Failed to upload. Unsupported file or corrupt data. Confirm data of file. | The file you are trying to upload may have one of the following problems: <ul style="list-style-type: none"> The file exceeds the service's limit on number of pixels, file size, etc. The file type is not supported. The file is corrupted. | <ul style="list-style-type: none"> Check the service's size or format restrictions. Save the file as a different type. If possible, get a new, uncorrupted version of the file. |
| Server Error 13 Service temporarily unavailable. Try again later. | There is a problem with the service and it cannot be used now. | Wait and try again. If you get the message again, access the service from a computer to confirm if it is unavailable. |



Related Information

- [Troubleshooting](#)

Related Topics:

- [Configure Date and Time Using Web Based Management](#)

Document Jams

Related Models: DCP-L2640DN/DCP-L2660DW/DCP-L2665DW/MFC-L2802DN/MFC-L2800DW/MFC-L2802DW/MFC-L2827DWXL/MFC-L2827DW/MFC-L2835DW/MFC-L2860DWE/MFC-L2860DW/MFC-L2862DW/MFC-L2922DW/MFC-L2960DW/MFC-L2980DW

- [Document is Jammed in the Top of the ADF Unit](#)
- [Document is Jammed under the Document Cover](#)
- [Remove Small Scraps of Paper Jammed in the ADF](#)

Document is Jammed in the Top of the ADF Unit

Related Models: DCP-L2640DN/DCP-L2660DW/DCP-L2665DW/MFC-L2802DN/MFC-L2800DW/MFC-L2802DW/MFC-L2827DWXL/MFC-L2827DW/MFC-L2835DW/MFC-L2860DWE/MFC-L2860DW/MFC-L2862DW/MFC-L2922DW/MFC-L2960DW/MFC-L2980DW

1. Remove any paper from the ADF that is not jammed.
2. Open the ADF cover.
3. Pull the jammed document out to the left. If the document rips or tears, be sure you remove any debris or scraps to prevent future jams.

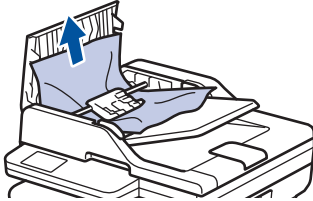

4. Close the ADF cover.
5. Press **Stop/Exit** or .

Related Information

- [Document Jams](#)

Document is Jammed under the Document Cover

Related Models: DCP-L2640DN/DCP-L2660DW/DCP-L2665DW/MFC-L2802DN/MFC-L2800DW/MFC-L2802DW/MFC-L2827DWXL/MFC-L2827DW/MFC-L2835DW/MFC-L2860DWE/MFC-L2860DW/MFC-L2862DW/MFC-L2922DW/MFC-L2960DW/MFC-L2980DW

1. Remove any paper from the ADF that is not jammed.
2. Lift the document cover.
3. Pull the jammed document out to the right. If the document rips or tears, be sure you remove any debris or scraps to prevent future jams.

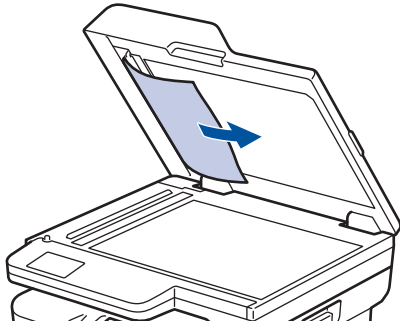

4. Close the document cover.
5. Press **Stop/Exit** or .



Related Information

- [Document Jams](#)

Remove Small Scraps of Paper Jammed in the ADF

Related Models: DCP-L2640DN/DCP-L2660DW/DCP-L2665DW/MFC-L2802DN/MFC-L2800DW/MFC-L2802DW/MFC-L2827DWXL/MFC-L2827DW/MFC-L2835DW/MFC-L2860DWE/MFC-L2860DW/MFC-L2862DW/MFC-L2922DW/MFC-L2960DW/MFC-L2980DW

1. Lift the document cover.
2. Insert a piece of stiff paper, such as cardstock, into the ADF to push any small paper scraps through.
(DCP-L2640DN/DCP-L2660DW/DCP-L2665DW/MFC-L2802DN/MFC-L2800DW/MFC-L2802DW/MFC-L2827DWXL/MFC-L2827DW/MFC-L2835DW/MFC-L2860DWE/MFC-L2860DW/MFC-L2862DW)

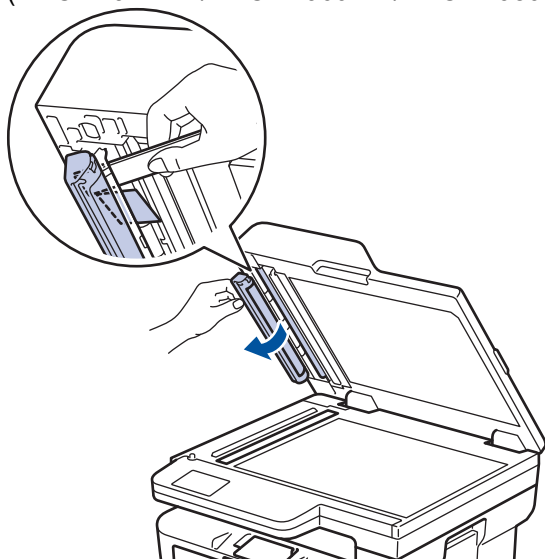
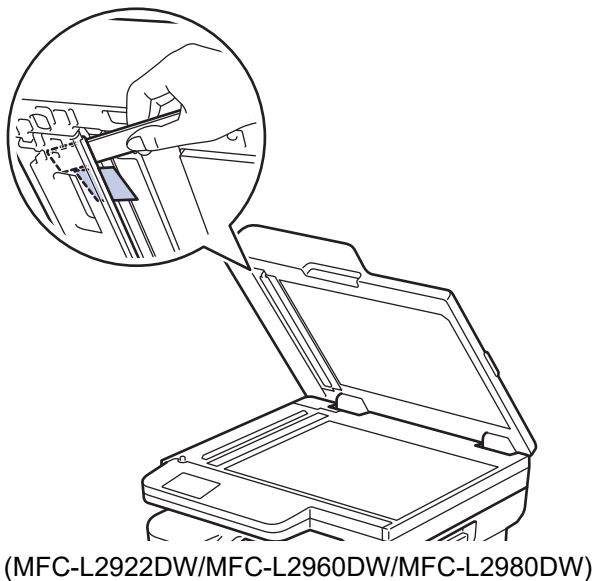

3. Close the document cover.
4. Press **Stop/Exit** or .

✓ Related Information

- [Document Jams](#)

Paper Jams

Always remove the remaining paper from the paper tray, fan and straighten the stack when you are adding new paper. This helps prevent paper jams.

- [Clear Paper Jams](#)
- [Paper is Jammed in the Paper Tray](#)
- [Paper is Jammed in the Output Paper Tray](#)
- [Paper is Jammed in the Back of the Machine](#)
- [Paper is Jammed inside the Machine](#)
- [Paper is Jammed in the 2-sided Tray](#)

Clear Paper Jams

If paper is jammed or multiple sheets of paper are fed together frequently, do the following:

- Clean the paper pick-up rollers and the separator pad of paper trays.
See Related Information: Clean the Paper Pick-up Rollers.
- Load paper correctly in the tray.
See Related Information: Load Paper.
- Set the correct paper size and paper type on your machine.
See Related Information: Paper Settings.
- Set the correct paper size and paper type on your computer.
See Related Information: Print a Document (Windows).
See Related Information: Print Using AirPrint.
- Use the recommended paper.
See Related Information: Using Special Paper.
See Related Information: Recommended Print Media.



Related Information

- [Paper Jams](#)

Related Topics:

- [Clean the Paper Pick-up Rollers](#)
- [Load Paper](#)
- [Paper Settings](#)
- [Print a Document \(Windows\)](#)
- [Print Using AirPrint](#)
- [Using Special Paper](#)
- [Recommended Print Media](#)

Paper is Jammed in the Paper Tray

If the machine's control panel or the Status Monitor indicates that there is a jam in the paper tray, follow these steps:

1. Pull the paper tray completely out of the machine.

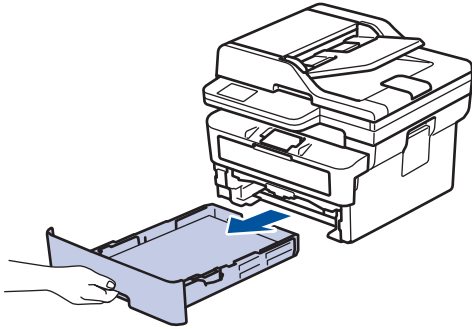

2. Slowly pull out the jammed paper.

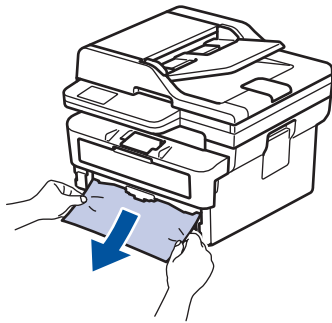

 Pulling the jammed paper downwards using both hands allows you to remove the paper more easily.

3. Fan the stack of paper to prevent further jams, and slide the paper guides to fit the paper size. Load paper in the paper tray.

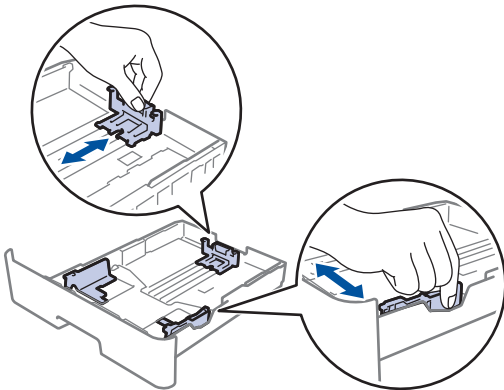

4. Make sure the paper is below the maximum paper mark (▼▼▼).

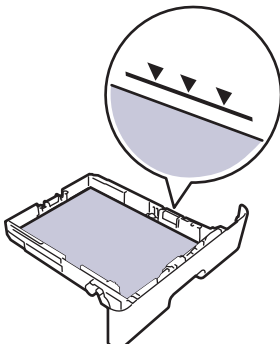

5. Put the paper tray firmly back into the machine.



Related Information

- [Paper Jams](#)
-

Paper is Jammed in the Output Paper Tray

When the paper is jammed in the output paper tray, follow these steps:

1. Use both hands to open the scanner.

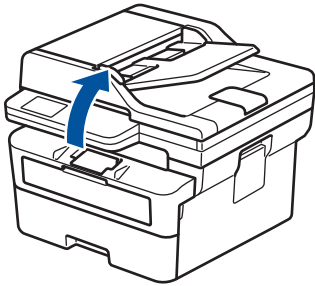

2. Remove the paper.

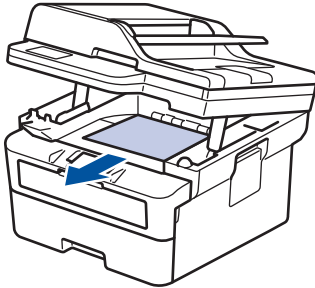

3. Push the scanner down with both hands to close it.

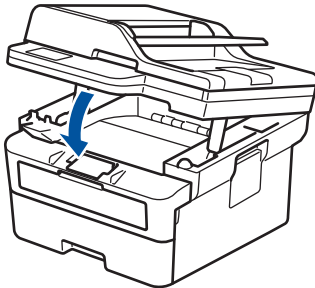

✓ Related Information

- [Paper Jams](#)

Paper is Jammed in the Back of the Machine

If the machine's control panel or the Status Monitor indicates that there is a jam in the back of the machine (Jam Rear), do the following:

1. Leave the machine turned on for 10 minutes for the internal fan to cool the extremely hot parts inside the machine.
2. Open the back cover.

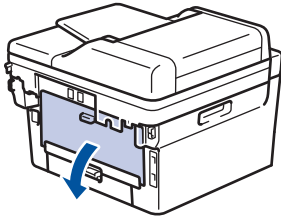

3. Pull the blue tabs at the left and right sides towards you to release the fuser cover.

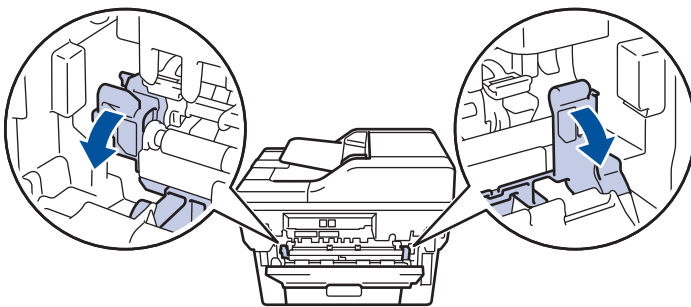

WARNING

HOT SURFACE

The machine's internal parts will be extremely hot. Wait for the machine to cool down before touching them.

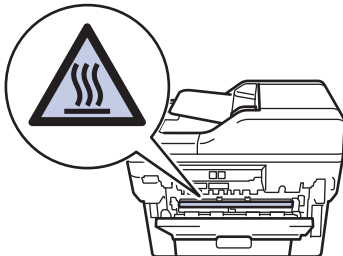

(For models with green levers) If the green envelope levers inside the back cover are pulled down in the envelope position, lift these levers to their original position before pulling the blue tabs down.

4. Use both hands to gently pull the jammed paper out of the machine.

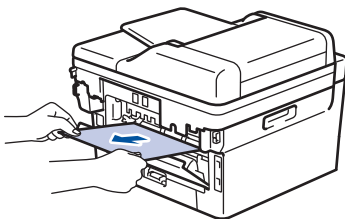

5. Close the fuser cover.

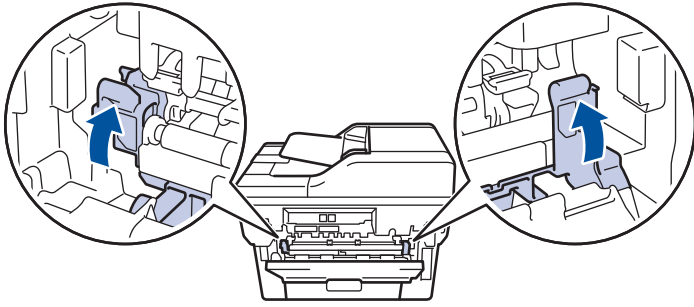

6. Close the back cover until it locks in the closed position.



If you print envelopes on a model equipped with the green envelope levers, pull the levers down to the envelope position again and leave the back cover open.



Related Information

- [Paper Jams](#)
-

Paper is Jammed inside the Machine

If the machine's control panel or the Status Monitor indicates that there is a jam inside the machine, follow these steps:

1. Leave the machine turned on for 10 minutes for the internal fan to cool the extremely hot parts inside the machine.
2. Open the front cover.

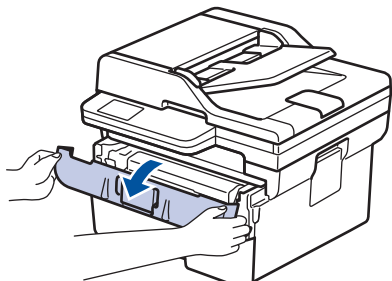

3. Remove the toner cartridge and drum unit assembly.

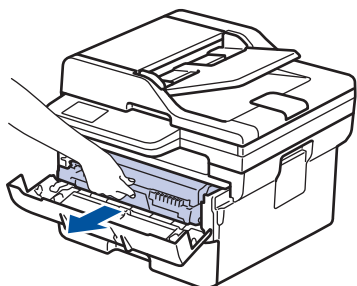

WARNING

HOT SURFACE

The machine's internal parts will be extremely hot. Wait for the machine to cool down before touching them.

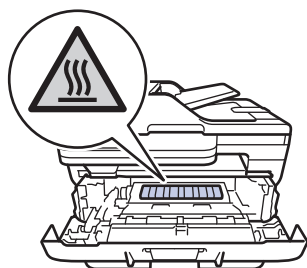

4. Pull out the jammed paper slowly.

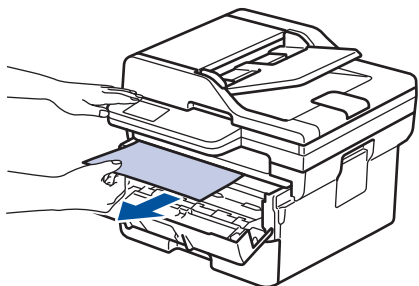

5. Install the toner cartridge and drum unit assembly into the machine.

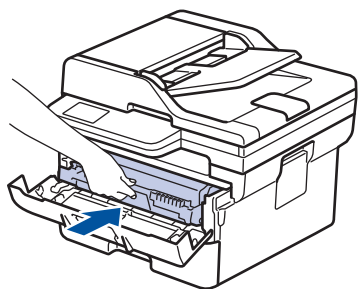

6. Close the front cover.



Related Information

- [Paper Jams](#)

Paper is Jammed in the 2-sided Tray

If the machine's control panel or the Status Monitor indicates that there is a jam in the 2-sided paper tray, follow these steps:

1. Leave the machine turned on for 10 minutes for the internal fan to cool the extremely hot parts inside the machine.
2. Pull the paper tray completely out of the machine.

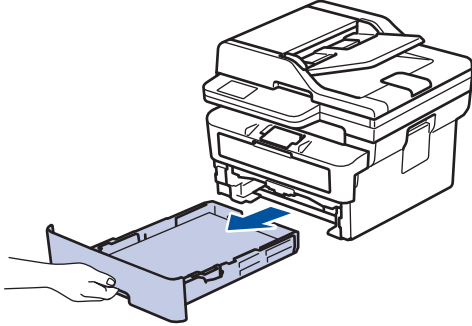

3. At the back of the machine, pull the 2-sided tray completely out of the machine.

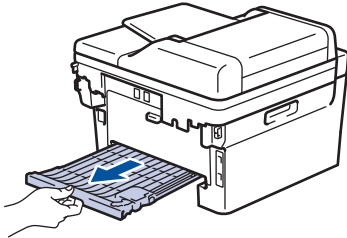

4. Pull the jammed paper out of the machine or out of the 2-sided tray.

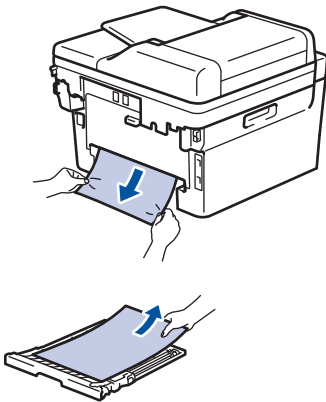

5. Remove paper that may have jammed under the machine due to static electricity.

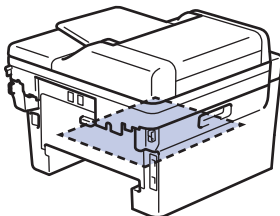

6. If paper is not caught inside the 2-sided tray, open the back cover.

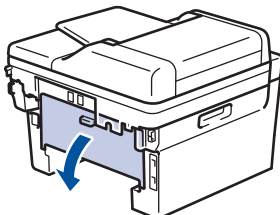

7. Pull the blue tabs at the left and right sides towards you to release the fuser cover.

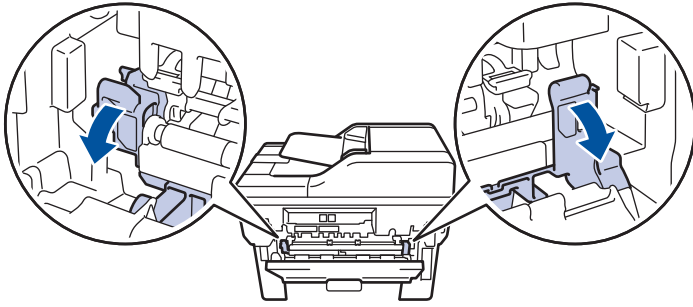

(For models with green levers) If the green envelope levers inside the back cover are pulled down in the envelope position, lift these levers to their original position before pulling the blue tabs down.

WARNING

HOT SURFACE

The machine's internal parts will be extremely hot. Wait for the machine to cool down before touching them.

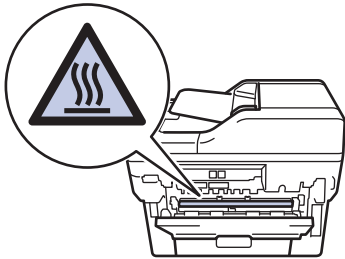

8. Use both hands to gently pull the jammed paper out of the back of the machine.

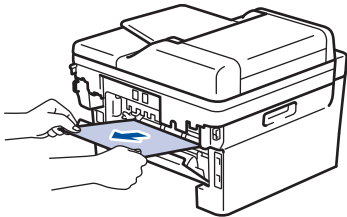

9. Close the fuser cover.

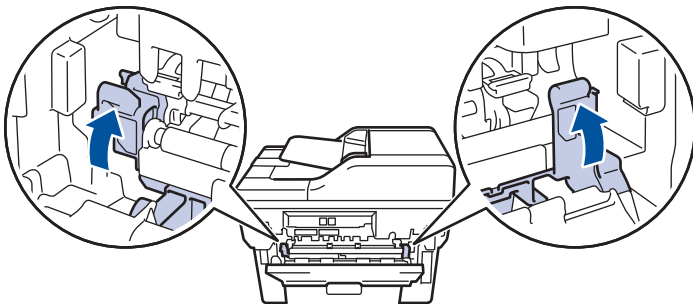

10. Close the back cover until it locks in the closed position.



If you print envelopes on a model equipped with the green envelope levers, pull the levers down to the envelope position again and leave the back cover open.

11. Push the 2-sided tray firmly back into the back of the machine.

12. Push the paper tray firmly back into the front of the machine.





Related Information

- [Paper Jams](#)

Printing Problems

If, after reading the information in this table, you still need help, see the latest troubleshooting tips at support.brother.com/faqs.

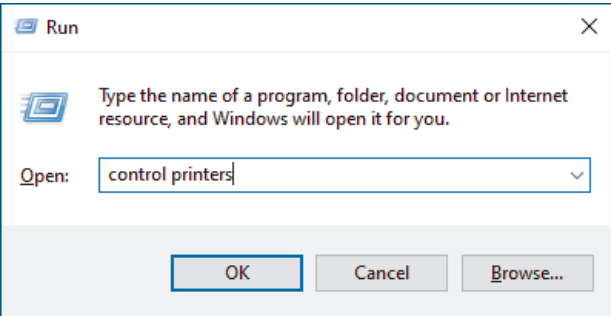
| Difficulties | Suggestions |
|--------------------------------------------------------------------------------------------------------------------|-------------------------------------------------------------------------------------------------------------------------------------------------------------------------------------------------------------------------------------------------------------------------------------------------------------------------------------------------------------------------------------------------------------------------------------------------------------------------------------------------------------------------------------------------------------------------------------------------------------------------------------------------------------------------------------------------------------------------------------------------------------------------------------------------------------------------------------------------------------------------------------------------------------------------------------------------------------------------------------------------------------------------------------------------------------------------------------------------------------------------------------------------------------------------------------------------------------------------------------------------------------------------------------------------------------------------------------------------------------------------------------------------------------------------------------------------------------------------------------------------------|
| No printout | <p>Check the machine is not in Power Off mode.</p> <p>If the machine is in Power Off mode, press , and then send the print data again.</p> <p>Check that the correct printer driver has been installed and selected.</p> <p>Check to see if the Status Monitor or the machine's control panel displays an error.</p> <p>Check that the machine is online:</p> <p>Windows:</p> <ol style="list-style-type: none"> 1. Hold down the  key and press the  key on the computer's keyboard to launch Run. 2. Type "control printers" in the Open: field and click OK.  <ol style="list-style-type: none"> 3. Right-click your model's icon, and then click See what's printing. 4. If printer driver options appear, select your printer driver. 5. Click Printer in the menu bar and make sure Use Printer Offline is not selected. <p>Mac:</p> <p>Click the System Preferences or System Settings menu, and then select the Printers & Scanners option. When the machine is offline, delete it, and then add it again.</p> |
| The machine is not printing or has stopped printing. | <p>Cancel the print job and clear it from the machine's memory. The printout may be incomplete. Send the print data again.</p> <p>See <i>Related Information:Cancel a Print Job</i>.</p> |
| The headers or footers appear when the document displays on the screen but they do not show up when it is printed. | <p>There is an unprintable area on the top and bottom of the page. Adjust the top and bottom margins in your document to allow for this.</p> |
| The machine prints unexpectedly or it prints garbled text. | <p>Cancel the print job and clear it from the machine's memory. The printout may be incomplete. Send the print data again.</p> <p>See <i>Related Information:Cancel a Print Job</i>.</p> <p>Check the settings in your application to make sure they are set up to work with your machine.</p> |

| Difficulties | Suggestions |
|--------------------------------------------------------------------------------------------------------------------------------------------------------------|----------------------------------------------------------------------------------------------------------------------------------------------------------------------------------------------------------------------------------------------------------------------------------------------------------------------------------------------------------------------------------------------------------------------------------------------------------------------------------------------------------------------------------------------|
| | Confirm that the Brother printer driver is selected in your application's Print window. |
| The machine prints the first couple of pages correctly, then some pages have missing text. | <p>Check the settings in your application to make sure they are set up to work with your machine.</p> <p>Your machine is not receiving all of the data sent from the computer. Make sure you connected the interface cable correctly.</p> |
| Cannot print on 1-sided or 2-sided. | <p>(Windows) Change the 2-sided option in the printer driver.</p> <ul style="list-style-type: none"> If you want to make a temporary change, select None or 2-sided in the printer driver from your application: See <i>Related Information: Print a Document (Windows)</i>. If you want to make a permanent change, change the default printer driver settings: See <i>Related Information: Change the Default Print Settings (Windows)</i>. |
| The machine does not print on both sides of the paper even though the printer driver setting is 2-sided and the machine supports automatic 2-sided printing. | Check the paper size setting in the printer driver. You must select A4 paper. Supported paper weight is 60 to 105g/m ² |
| Print speed is too slow. | <p>Reduce the resolution in the printer driver.</p> <p>If you have enabled Quiet Mode, disable it in the printer driver or the machine's menu.</p> <p>When printing continuously, the printing speed may be automatically reduced to lower the temperature inside the machine.</p> |
| The machine does not feed paper. | <p>If there is paper in the paper tray, make sure it is straight. If the paper is curled, straighten it. Sometimes it is helpful to remove the paper, turn the stack over and place it back in the paper tray.</p> <p>Fan the stack of paper well and place it back to the paper tray.</p> <p>Reduce the amount of paper in the paper tray, and then try again.</p> <p>(For models with Manual Feed Slot) Make sure Manual is not selected for Paper Source in the printer driver.</p> <p>Clean the paper pick-up rollers.</p> |
| The machine does not feed paper from the Manual feed slot. (For models with Manual Feed Slot) | <p>Use both hands to push one sheet of paper firmly into the manual feed slot until the top edge of the paper presses against the paper feed rollers. Continue pressing the paper against the rollers until the machine grabs the paper and pulls it in further.</p> <p>Put only one sheet of paper in the manual feed slot.</p> <p>Make sure Manual is selected as Paper Source in the printer driver.</p> |
| The machine does not feed envelopes. | Load one envelope at a time in the manual feed slot. Your application must be set to print the envelope size you are using. This is usually done in the Page Setup or Document Setup menu of your application. |
| Print position is misaligned with the preprinted objects. | Adjust the print position using the Print Position setting for each paper tray. |



Related Information

- [Troubleshooting](#)



Related Topics:



- [Monitor the Status of the Machine from Your Computer \(Windows\)](#)
 - [Cancel a Print Job](#)
 - [Clean the Paper Pick-up Rollers](#)
 - [Print a Document \(Windows\)](#)
 - [Change the Default Print Settings \(Windows\)](#)
 - [Load Paper](#)
-

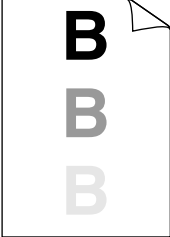
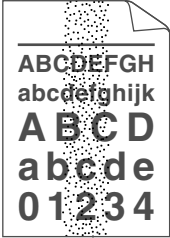

Improve the Print Quality

If you have a print quality problem, print a test page first. If the printout looks good, the problem is probably not the machine. Check the interface cable connections and try printing a different document. If the printout or test page printed from the machine has a quality problem, check the examples of poor print quality and follow the recommendations in the table.

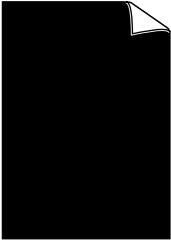
1. To get the best print quality, we suggest using recommended print media. Make sure you use paper that meets our specifications.
2. Check that the toner cartridge and drum unit are installed correctly.

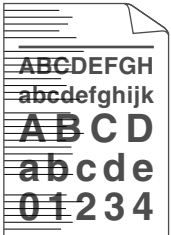
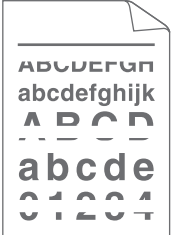
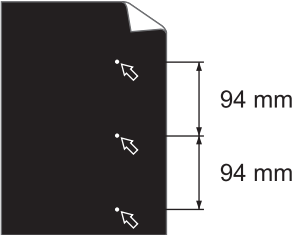
| Examples of poor print quality | Recommendation |
|--------------------------------------------------------------------------------------------------------------------------------------------------------------------------------------|--------------------------------------------------------------------------------------------------------------------------------------------------------------------------------------------------------------------------------------------------------------------------------------------------------------------------------------------------------------------------------------------------------------------------------------------------------------------------------------------------------------------------------------------------------------------------------------------------------------------------------------------------|
|  <p>ABCDEF GH abcde fghijk A B C D a b c d e 0 1 2 3 4</p> <p>Faint</p> | <ul style="list-style-type: none"> • If the machine displays the Replace Toner status, install a new toner cartridge. • Check the machine's environment. Conditions such as humidity, high temperatures, and so on, may cause this print fault. • If the whole page is too light, Toner Save mode may be turned on. Turn Toner Save mode off in the machine's menu settings or the printer driver. • Clean the drum unit. • Clean the corona wire on the drum unit. • Replace the toner cartridge with a new toner cartridge. • Replace the drum unit with a new drum unit. |
|  <p>ABCDEF GH abcde fghijk A B C D a b c d e 0 1 2 3 4</p> <p>Grey background</p> | <ul style="list-style-type: none"> • Check the machine's environment. Conditions such as high temperatures and high humidity can increase the amount of background shading. • Clean the drum unit. • Replace the toner cartridge with a new toner cartridge. • Replace the drum unit with a new drum unit. |
|  <p>B B B</p> <p>Ghosting images</p> | <ul style="list-style-type: none"> • Check the machine's environment. Conditions such as low humidity and low temperatures may cause this print quality problem. • Select the appropriate media type in the printer driver. • Clean the drum unit. • Replace the drum unit with a new drum unit. • Replace the toner cartridge with a new toner cartridge. • The fuser unit may be contaminated. Contact Brother customer service. |
|  <p>ABCDEF GH abcde fghijk A B C D a b c d e 0 1 2 3 4</p> <p>Toner specks</p> | <ul style="list-style-type: none"> • Make sure the media type setting in the driver matches the type of paper you are using. • Clean the drum unit. • The toner cartridge may be damaged. Replace the toner cartridge with a new toner cartridge. • The drum unit may be damaged. Replace the drum unit with a new drum unit. • The fuser unit may be contaminated. Contact Brother customer service. |

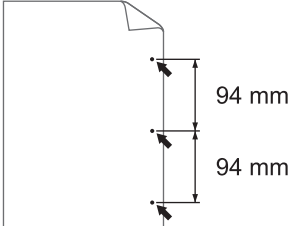
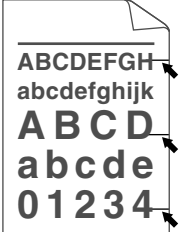
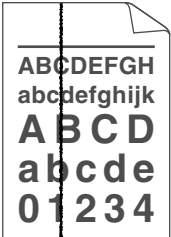
| Examples of poor print quality | Recommendation |
|------------------------------------------------------------------------------------------------------------------------------------------------------------------------------------|-----------------------------------------------------------------------------------------------------------------------------------------------------------------------------------------------------------------------------------------------------------------------------------------------------------------------------------------------------------------------------------------------------------------------------------------------------------------------------------------------------------------------------|
|  <p data-bbox="406 409 545 436">Hollow print</p> | <ul data-bbox="817 168 1474 443" style="list-style-type: none"> • Select Thick Paper mode in the printer driver or use thinner paper than you are currently using. • Select the appropriate media type from the paper type options on your machine. • Check the machine's environment. Conditions such as high humidity can cause hollow print. • The drum unit may be damaged. Replace the drum unit with a new drum unit. |
|  <p data-bbox="427 705 525 732">All black</p> | <ul data-bbox="817 463 1356 571" style="list-style-type: none"> • Clean the corona wire inside the drum unit. • The drum unit may be damaged. Replace the drum unit with a new drum unit. |
|  <p data-bbox="319 983 633 1010">White lines across the page</p> | <ul data-bbox="817 748 1474 1064" style="list-style-type: none"> • Select the appropriate media type in the printer driver. • Select the appropriate media type from the paper type options on your machine. • The problem may disappear by itself. Print several blank pages to clear this problem, especially if the machine has not been used for a long time. • Clean the drum unit. • The drum unit may be damaged. Replace the drum unit with a new drum unit. |
|  <p data-bbox="349 1317 600 1344">Lines across the page</p> | <ul data-bbox="817 1081 1356 1189" style="list-style-type: none"> • Clean the drum unit. • The drum unit may be damaged. Replace the drum unit with a new drum unit. |
|  <p data-bbox="220 1599 730 1626">White lines, bands or ribbing across the page</p> | <ul data-bbox="817 1364 1474 1563" style="list-style-type: none"> • Check the machine's environment. Conditions such as high humidity and high temperatures may cause this print quality problem. • Clean the drum unit. • If the problem is not solved after printing a few pages, replace the drum unit with a new drum unit. |
|  <p data-bbox="146 1881 804 1908">White spots on black text and graphics at 94 mm intervals</p> | <ul data-bbox="817 1646 1474 1908" style="list-style-type: none"> • Make 10-15 copies of a blank, white sheet of paper. If the problem is not solved after printing the blank pages, the drum unit may have foreign material, such as glue from a label, stuck on the drum. Clean the drum unit. <i>See Related Information: Clean the Drum Unit.</i> • The drum unit may be damaged. Replace the drum unit with a new drum unit. |

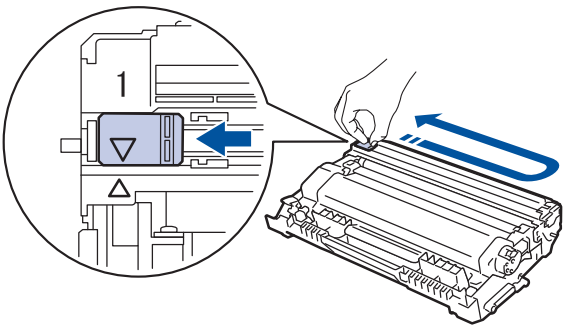
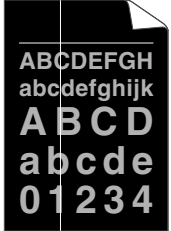
| Examples of poor print quality | Recommendation |
|-----------------------------------------------------------------------------------------------------------------------------------------------------------------------|---------------------------------------------------------------------------------------------------------------------------------------------------------------------------------------------------------------------------------------------------------------------------------------------------------------------------------------------------------------------------------------------------------------------------------------------------------------------------------------------------------------------------------------------------------------------------------------------------------------------------------------------------------------------------------------------------------------------------------------------------------------------------------------------|
|  <p>Black spots at 94 mm intervals</p> | |
|  <p>Black toner marks across the page</p> | <ul style="list-style-type: none"> • If you use label sheets for laser printers, the glue from the sheets may sometimes stick to the drum surface. Clean the drum unit. <i>See Related Information: Clean the Drum Unit.</i> • If you used paper that has clips or staples, the drum unit may be damaged. • If the unpacked drum unit is in direct sunlight (or room light for long periods of time), the unit may be damaged. • Clean the drum unit. • The toner cartridge may be damaged. Replace the toner cartridge with a new toner cartridge. • The drum unit may be damaged. Replace the drum unit with a new drum unit. |
|  <p>Black lines down the page Printed pages have toner stains down the page</p> | <ul style="list-style-type: none"> • Clean the corona wire inside the drum unit by sliding the green tab. <p> Make sure the green tab of the corona wire is in the Home position (1).</p>  <ul style="list-style-type: none"> • Wipe the scanner glass strip with a dry lint free soft cloth. • The toner cartridge may be damaged. Replace the toner cartridge with a new toner cartridge. • The drum unit may be damaged. Replace the drum unit with a new drum unit. • The fuser unit may be contaminated. Contact Brother customer service. |
|  <p>White lines down the page</p> | <ul style="list-style-type: none"> • Make sure there is no foreign material, such as a torn piece of paper, sticky notes or dust, inside the machine and around the toner cartridge and drum unit. • The toner cartridge may be damaged. Replace the toner cartridge with a new toner cartridge. • The drum unit may be damaged. Replace the drum unit with a new drum unit. |

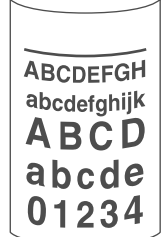
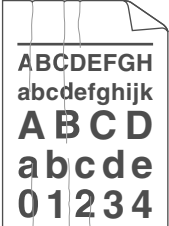
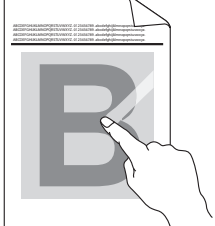
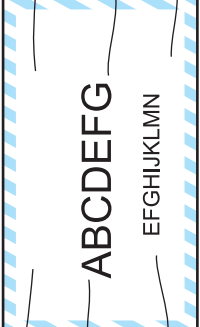
| Examples of poor print quality | Recommendation |
|----------------------------------------------------------------------------------------------------------------------------------------------|-------------------------------------------------------------------------------------------------------------------------------------------------------------------------------------------------------------------------------------------------------------------------------------------------------------------------------------------------------------------------------------------------------------------------------------------------------------------------------------------------------------------------------------------------------------------------------------------------------------------------------------------------------------------------------------------------------------------------------------------------------------------------------------|
|  <p data-bbox="392 405 560 427">Image skewed</p> | <ul data-bbox="818 170 1473 674" style="list-style-type: none"> • Set the document correctly in the ADF or on the scanner glass if the skew only occurs when making copies. • Make sure the paper or other print media is loaded correctly in the paper tray and the guides are not too tight or too loose against the paper stack. • Set the paper guides correctly. • The paper tray may be too full. • Check the paper type and quality. • Check for loose objects such as torn paper inside the machine. • If the problem only occurs during automatic 2-sided printing, check for torn paper in the 2-sided tray. Verify the 2-sided tray is inserted completely and the back cover is closed completely. |
|  <p data-bbox="352 943 600 965">Curled or wavy image</p> | <ul data-bbox="818 696 1473 1050" style="list-style-type: none"> • Check the paper type and quality. High temperatures and high humidity will cause paper to curl. • If you do not use the machine often, the paper may have been in the paper tray too long. Turn over the stack of paper in the paper tray. Also, fan the paper stack, and then rotate the paper 180° in the paper tray. • Open the back cover (face up output tray) to let the printed paper exit onto the face up output tray. • Choose Reduce Paper Curl mode in the printer driver when you do not use our recommended print media. |
|  <p data-bbox="360 1308 592 1330">Wrinkles or creases</p> | <ul data-bbox="818 1072 1441 1207" style="list-style-type: none"> • Make sure paper is loaded correctly. • Check the paper type and quality. • Turn over the stack of paper in the tray or rotate the paper 180° in the paper tray. |
|  <p data-bbox="408 1592 544 1615">Poor fixing</p> | <ul data-bbox="818 1357 1457 1610" style="list-style-type: none"> • Make sure the media type setting in the printer driver matches the type of paper you are using. • Select Improve Toner Fixing mode in the printer driver. <p data-bbox="855 1491 1465 1610">If this selection does not provide enough improvement, change the printer driver setting in Media Type to a thick setting. If you are printing an envelope, select Env. Thick in the media type setting.</p> |
|  <p data-bbox="376 1977 576 2000">Envelope creases</p> | <ul data-bbox="818 1641 1473 1783" style="list-style-type: none"> • Make sure the levers are pulled down to the envelope position when you print envelopes (applicable to models with green levers). After you have finished printing, reset the levers back to their original position. Pull up the levers until they stop. |

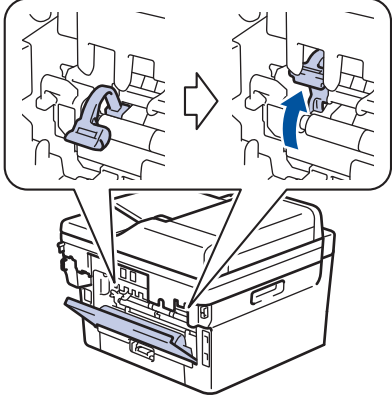
| Examples of poor print quality | Recommendation |
|--------------------------------|-------------------------------------------------------------------------------------------------------------------------------------------------------------------------------------------------------------------------------------------------------------------------------------------------------------------------------------|
| |  <ul style="list-style-type: none">• Make sure envelopes are printed with the back cover (face up output tray) opened.• (For models with Manual Feed Slot) Make sure envelopes are fed only from the manual feed slot. |

Related Information

- [Troubleshooting](#)

Related Topics:

- [Test Print](#)
- [Clean the Drum Unit](#)
- [Reduce Toner Consumption](#)
- [Replace the Toner Cartridge](#)
- [Replace the Drum Unit](#)
- [Clean the Scanner](#)

Telephone and Fax Problems

Related Models: MFC-L2802DN/MFC-L2800DW/MFC-L2802DW/MFC-L2827DWXL/MFC-L2827DW/
MFC-L2835DW/MFC-L2860DWE/MFC-L2860DW/MFC-L2862DW/MFC-L2922DW/MFC-L2960DW/
MFC-L2980DW

Telephone Line or Connections

| Difficulties | Suggestions |
|-------------------------------------------|-------------------------------------------------------------------------------------------------------------------------------------------------------------------------------------------------------------------------------------------------------------------------------------------------------------------------------------------------------------------------------------------------|
| Dialling does not work. (No dial tone) | Check all line cord connections. Make sure the telephone line cord is plugged into the telephone wall socket and the LINE socket of the machine. If you subscribe to DSL or VoIP services, contact your service provider for connection instructions. |
| | (Available only for some countries.) Change the Tone/Pulse setting. |
| | If an external phone is connected to the machine, send a manual fax by lifting the handset of the external telephone and dialling the number using the external telephone. Wait to hear the fax receiving tones before sending a fax. |
| | If there is no dial tone, connect a known working telephone and telephone line cord to the socket. Then lift the external telephone's handset and listen for a dial tone. If there is still no dial tone, ask your telephone company to check the line and/or wall socket. |
| The machine does not answer when called. | Make sure the machine is in the correct receive mode for your setup. Check for a dial tone. If possible, call your machine to hear it answer. If there is still no answer, check that the telephone line cord is plugged into the telephone wall socket and the LINE socket of the machine. If there is no ringing when you call your machine, ask your telephone company to check the line. |

Handling Incoming Calls

| Difficulties | Suggestions |
|------------------------------------|---------------------------------------------------------------------------------------------------------------------------------------------------------------------------------------------------------------------------------------------------------------------------------------------------------------------------------------------------------------------------------------------------------------------------------------------------------------------------------------------------------------------------------------------------------------------------------------------------------------------------------------------------------------------------------------------------------------------------------------------------------------------------------------------------------------------------------------------------------------------------------|
| Sending a Fax Call to the machine. | If you answered on an extension or external telephone, press your Remote Activation Code (the factory setting is *51). If you answered on the external telephone, press the Start button to receive the fax. When your machine answers, hang up. |
| Custom features on a single line. | If you have Call Waiting, Call Waiting/Caller ID, Caller ID, Voice Mail, an answering machine, an alarm system or other custom feature on a single telephone line with your machine, it may create a problem sending or receiving faxes. For Example: If you subscribe to Call Waiting or some other custom service and its signal comes through the line while your machine is sending or receiving a fax, the signal can temporarily interrupt or disrupt the faxes. Brother's ECM (Error Correction Mode) feature should help overcome this problem. This condition is related to the telephone system industry and is common to all devices that send and receive information on a single, shared line with custom features. If avoiding a slight interruption is crucial to your business, we recommend using a separate telephone line with no custom features. |

Receiving Faxes

| Difficulties | Suggestions |
|-----------------------|------------------------------------------------------------------------------------------------------------------------------------------------------------------------------------------------------------------------------------------------------------------------------------------------------------------------------------------------------------------------------------------------------------------------|
| Cannot receive a fax. | Check all line cord connections. Make sure the telephone line cord is plugged into the telephone wall socket and the LINE socket of the machine. If you subscribe to DSL or VoIP services, contact your service provider for connection instructions. If you are using a VoIP system, try changing the VoIP setting to <i>Basic (for VoIP)</i> . This will lower modem speed and turn off Error Correction Mode (ECM). |

| Difficulties | Suggestions |
|-----------------------|-----------------------------------------------------------------------------------------------------------------------------------------------------------------------------------------------------------------------------------------------------------------------------------------------------------------------------------------------------------------------------------------------------------------------------------------------------------------------------------------------------------------------------------------------------------------------------------------------------------------------------------------------------------------------------------------------------------------------------------------------------------------------------------------------------------------------------------------------------------------------------------------------------------------------------------------------------------------------------------------------------------------------------------------------------------------------------------------------------------------------------------------------------------------------------------------------------------------------------------------|
| Cannot receive a fax. | <p>Make sure the machine is in the correct Receive Mode. This is determined by the external devices and telephone subscriber services you have on the same line as the Brother machine.</p> <ul style="list-style-type: none"> If you have a dedicated fax line and want your Brother machine to automatically answer all incoming faxes, you should select Fax Only mode. If your Brother machine shares a line with an external answering machine, you should select the External TAD mode. In External TAD mode, your Brother machine will receive incoming faxes automatically and voice callers will be able to leave a message on your answering machine. If your Brother machine shares a line with other telephones and you want it to automatically answer all incoming faxes, you should select the Fax/Tel mode. In Fax/Tel mode, your Brother machine will receive faxes automatically and produce a pseudo/double-ring to alert you to answer voice calls. If you do not want your Brother machine to answer any incoming faxes automatically, you should select the Manual mode. In Manual mode, you must answer every incoming call and activate the machine to receive faxes. |
| | <p>Another device or service at your location may be answering the call before your Brother machine answers. To test this, lower the Ring Delay setting:</p> <ul style="list-style-type: none"> If the Receive Mode is set to Fax Only or Fax/Tel, reduce the Ring Delay to the minimum value (excluding "0"). <i>See Related Information: Set the Number of Rings Before the Machine Answers (Ring Delay).</i> If the Receive Mode is set to External TAD, reduce the number of rings programmed on your answering machine to two. If the Receive Mode is set to Manual, DO NOT adjust the Ring Delay setting. |
| | <p>Have someone send you a test fax:</p> <ul style="list-style-type: none"> If you received the test fax successfully, your machine is operating correctly. Remember to reset your Ring Delay or answering machine setting back to your original setting. If receiving problems recur after resetting the Ring Delay, then a person, device, or subscriber service is answering the fax call before the machine has a chance to answer. If you were not able to receive the fax, then another device or subscriber service may be interfering with your fax reception or there may be a problem with your fax line. |
| | <p>If you are using a telephone answering machine (External TAD mode) on the same line as the Brother machine, make sure your answering machine is set up correctly.</p> <ol style="list-style-type: none"> Set your answering machine to answer in one or two rings. Record the outgoing message on your answering machine. <ul style="list-style-type: none"> Record five seconds of silence at the beginning of your outgoing message. Limit your speaking to 20 seconds. End your outgoing message with your Remote Activation Code for people sending manual faxes. For example: "After the beep, leave a message or press *51 and Start to send a fax." Set your answering machine to answer calls. Set your Brother machine's Receive Mode to External TAD. <i>See Related Information: Choose the Correct Receive Mode.</i> |
| | <p>Make sure your Brother machine's Fax Detect feature is turned On. Fax Detect is a feature that allows you to receive a fax even if you answered the call on an external or extension telephone.</p> |
| | <p>If you often get transmission errors due to possible interference on the telephone line or if you are using a VoIP system, try changing the Compatibility setting to <i>Basic (for VoIP)</i>.</p> |
| | <p>Contact your administrator to check your Secure Function Lock settings.</p> |
| | |

Sending Faxes

| Difficulties | Suggestions |
|--------------------|--------------------------------------------------------------------------------------------------------------------------------------------------------------------------------------------------------------------------------------------------------------|
| Cannot send a fax. | <p>Check all line cord connections. Make sure the telephone line cord is plugged into the telephone wall socket and the LINE socket of the machine. If you subscribe to DSL or VoIP services, contact your service provider for connection instructions.</p> |
| | <p>Make sure you pressed Fax and the machine is in Fax mode.</p> |
| | <p>Print the Transmission Verification Report and check for an error.</p> |

| Difficulties | Suggestions |
|-----------------------------------------------------|-------------------------------------------------------------------------------------------------------------------------------------------------------------------------------------------------------------------------------------------------------------------------------------------------------------------------------------------------------------------------------------------------------------------------|
| Cannot send a fax. | Contact your administrator to check your Secure Function Lock settings. |
| | Ask the other party to check that the receiving machine has paper. |
| Poor quality of sent faxes. | Try changing your resolution to Fine or S.Fine. Make a copy to check your machine's scanner operation. If the copy quality is poor, clean the scanner. |
| Transmission Verification Report says RESULT:ERROR. | There is probably temporary noise or static on the line. Try sending the fax again. If you are sending a PC-Fax message and get RESULT:ERROR on the Transmission Verification Report, your machine may be out of memory. To free up extra memory, you can turn Fax Storage off, print fax messages in memory or cancel a delayed fax. If the problem continues, ask the telephone company to check your telephone line. |
| | If you often get transmission errors due to possible interference on the telephone line or if you are using a VoIP system, try changing the Compatibility setting to Basic (for VoIP). |
| Sent faxes are blank. | Make sure you are loading the document correctly. When using the ADF, the document should be face up. When using the scanner glass, the document should be face down. |
| Vertical black lines when sending a fax. | Black vertical lines on faxes you send are typically caused by dirt or correction fluid on the glass strip. Clean the glass strip. |

Printing received faxes

| Difficulties | Suggestions |
|--------------------------------------------------------------------------------------------------------------------------------------------------------------------------------------------------------------------------------------------------------|----------------------------------------------------------------------------------------------------------------------------------------------------------------------------------------------------------------------------------------------------|
| <ul style="list-style-type: none"> Condensed print Horizontal streaks Top and bottom sentences are cut off Missing lines  | This is usually caused by a poor telephone connection. Do a test copy; if your copy looks good, you probably had a bad connection, with static or interference on the telephone line. Ask the other party to send the fax again. |
| Vertical black lines when receiving | The corona wire may be dirty. Clean the corona wire in the drum unit. |
| | The sender's scanner may be dirty. Ask the sender to make a copy to see if the problem is with the sending machine. Try receiving from another fax machine. |
| Received faxes appear as split or blank pages. | Left and right margins are cut off or a single page is printed on two pages. If the received faxes are divided and printed on two pages or if you get an extra blank page, your paper size setting may not be correct for the paper you are using. |
| | Turn Auto Reduction on. |



Related Information

- [Troubleshooting](#)
 - [Set Dial Tone Detection](#)
 - [Set Telephone Line Compatibility for Interference and VoIP Systems](#)

Related Topics:

- [Set the Number of Rings Before the Machine Answers \(Ring Delay\)](#)
- [Choose the Correct Receive Mode](#)

Set Dial Tone Detection

Related Models: MFC-L2802DN/MFC-L2800DW/MFC-L2802DW/MFC-L2827DWXL/MFC-L2827DW/
MFC-L2835DW/MFC-L2860DWE/MFC-L2860DW/MFC-L2862DW/MFC-L2922DW/MFC-L2960DW/
MFC-L2980DW

Setting the Dial Tone to [Detection] shortens the Dial Tone detect pause.



>> [MFC-L2802DN/MFC-L2800DW/MFC-L2802DW/MFC-L2827DWXL/MFC-L2827DW/MFC-L2835DW](#)

>> [MFC-L2860DWE/MFC-L2860DW/MFC-L2862DW/MFC-L2922DW/MFC-L2960DW/MFC-L2980DW](#)

MFC-L2802DN/MFC-L2800DW/MFC-L2802DW/MFC-L2827DWXL/MFC-L2827DW/ MFC-L2835DW

1. Press **Menu**.
2. Press **▲** or **▼** to display the [Initial Setup] option, and then press **OK**.
3. Press **▲** or **▼** to display the [Dial Tone] option, and then press **OK**.
4. Press **▲** or **▼** to choose the [Detection] or [No Detection], and then press **OK**.
5. Press **Stop/Exit**.

MFC-L2860DWE/MFC-L2860DW/MFC-L2862DW/MFC-L2922DW/MFC-L2960DW/ MFC-L2980DW

1. Press  [Settings] > [All Settings] > [Initial Setup] > [Dial Tone].
2. Press [Detection] or [No Detection].
3. Press .

Related Information

- [Telephone and Fax Problems](#)

Set Telephone Line Compatibility for Interference and VoIP Systems

Related Models: MFC-L2802DN/MFC-L2800DW/MFC-L2802DW/MFC-L2827DWXL/MFC-L2827DW/MFC-L2835DW/MFC-L2860DWE/MFC-L2860DW/MFC-L2862DW/MFC-L2922DW/MFC-L2960DW/MFC-L2980DW

Problems sending and receiving faxes due to possible interference on the telephone line may be solved by reducing the modem speed to minimise errors in fax transmission. If you are using a Voice over IP (VoIP) service, we recommend changing the compatibility to Basic (for VoIP).



- VoIP is a type of phone system that uses an Internet connection, rather than a traditional phone line.
- Telephone providers frequently bundle VoIP together with Internet and cable services.

>> [MFC-L2802DN/MFC-L2800DW/MFC-L2802DW/MFC-L2827DWXL/MFC-L2827DW/MFC-L2835DW](#)
>> [MFC-L2860DWE/MFC-L2860DW/MFC-L2862DW/MFC-L2922DW/MFC-L2960DW/MFC-L2980DW](#)

MFC-L2802DN/MFC-L2800DW/MFC-L2802DW/MFC-L2827DWXL/MFC-L2827DW/MFC-L2835DW

1. Press **Menu**.
2. Press **▲** or **▼** to display the [Initial Setup] option, and then press **OK**.
3. Press **▲** or **▼** to display the [Compatibility] option, and then press **OK**.
4. Press **▲** or **▼** to display the [High], [Normal], or [Basic (for VoIP)] option, and then press **OK**.

| Option | Description |
|------------------|-----------------------------------------------------------------------------------------------------------------------------------------------------------------------------------------------------------------------------------------------------------------------------------------------------------------------------------------------------|
| High | Select High to set the modem speed at 33600 bps. |
| Normal | Select Normal to set the modem speed at 14400 bps. |
| Basic (for VoIP) | Select Basic (for VoIP) to reduce the modem speed to 9600 bps and turn off Error Correction Mode (ECM). Unless interference is a recurring problem on your telephone line, you may prefer to use it only when needed. To improve compatibility with most VoIP services, we recommend changing the compatibility setting to Basic (for VoIP). |

5. Press **Stop/Exit**.

MFC-L2860DWE/MFC-L2860DW/MFC-L2862DW/MFC-L2922DW/MFC-L2960DW/MFC-L2980DW

1. Press  [Settings] > [All Settings] > [Initial Setup] > [Compatibility].
2. Press [High], [Normal] or [Basic (for VoIP)].

| Option | Description |
|------------------|-----------------------------------------------------------------------------------------------------------------------------------------------------------------------------------------------------------------------|
| High | Select High to set the modem speed at 33600 bps. |
| Normal | Select Normal to set the modem speed at 14400 bps. |
| Basic (for VoIP) | Select Basic (for VoIP) to reduce the modem speed to 9600 bps and turn off Error Correction Mode (ECM). Unless interference is a recurring problem on your telephone line, you may prefer to use it only when needed. |

| Option | Description |
|--------|--------------------------------------------------------------------------------------------------------------------------------------|
| | To improve compatibility with most VoIP services, we recommend changing the compatibility setting to <code>Basic (for VoIP)</code> . |

3. Press .

Related Information

- [Telephone and Fax Problems](#)
-

Network Problems

Related Models: DCP-L2620DW/DCP-L2622DW/DCP-L2627DW/DCP-L2627DWXL/DCP-L2627DWE/DCP-L2640DN/DCP-L2660DW/DCP-L2665DW/MFC-L2802DN/MFC-L2800DW/MFC-L2802DW/MFC-L2827DWXL/MFC-L2827DW/MFC-L2835DW/MFC-L2860DWE/MFC-L2860DW/MFC-L2862DW/MFC-L2922DW/MFC-L2960DW/MFC-L2980DW

- [Error Messages](#)
- [Use the Network Connection Repair Tool \(Windows\)](#)
- [Check Your Machine's Network Settings](#)
- [If You Are Having Difficulty with Your Machine's Network](#)

Error Messages

Related Models: DCP-L2620DW/DCP-L2622DW/DCP-L2627DW/DCP-L2627DWXL/DCP-L2627DWE/
DCP-L2640DN/DCP-L2660DW/DCP-L2665DW/MFC-L2802DN/MFC-L2800DW/MFC-L2802DW/
MFC-L2827DWXL/MFC-L2827DW/MFC-L2835DW/MFC-L2860DWE/MFC-L2860DW/MFC-L2862DW/
MFC-L2922DW/MFC-L2960DW/MFC-L2980DW

The most common error messages are shown in the table.

>> DCP-L2620DW/DCP-L2622DW/DCP-L2627DW/DCP-L2627DWXL/DCP-L2627DWE/DCP-L2640DN/
MFC-L2802DN/MFC-L2800DW/MFC-L2802DW/MFC-L2827DWXL/MFC-L2827DW/MFC-L2835DW
>> DCP-L2660DW/DCP-L2665DW/MFC-L2860DWE/MFC-L2860DW/MFC-L2862DW/MFC-L2922DW/
MFC-L2960DW/MFC-L2980DW

**DCP-L2620DW/DCP-L2622DW/DCP-L2627DW/DCP-L2627DWXL/DCP-L2627DWE/
DCP-L2640DN/MFC-L2802DN/MFC-L2800DW/MFC-L2802DW/MFC-L2827DWXL/
MFC-L2827DW/MFC-L2835DW**

| Error Messages | Cause | Action |
|------------------------------------------------------|----------------------------------------------------------------------------------------------------------------------------------|---------------------------------------------------------------------------------------------------------------------------------------------------------------------------------------------------------------------------------------------------------------------------------------------------------------------------------------------------------------------------------------------------------------------------------------------------------------------------------------------------------------------------------------------------------------------------|
| Maximum limit of connected devices has been reached. | Four mobile devices are already connected to the Wi-Fi Direct network when the Brother machine is the Group Owner. | After the current connection between your Brother machine and another mobile device has shut down, try to configure the Wi-Fi Direct settings again. You can confirm the connection status by printing the Network Configuration Report. |
| Connection Error | Other devices are trying to connect to the Wi-Fi Direct network at the same time. | Make sure there are no other devices trying to connect to the Wi-Fi Direct network, and then try to configure the Wi-Fi Direct settings again. |
| Connection Fail | The Brother machine and your mobile device cannot communicate during the Wi-Fi Direct network configuration. | <ul style="list-style-type: none"> • Move the mobile device closer to your Brother machine. • Move your Brother machine and the mobile device to an obstruction-free area. • If you are using the PIN Method of WPS, make sure you have entered the correct PIN. |
| No Device | When configuring the Wi-Fi Direct network, the Brother machine cannot find your mobile device. | <ul style="list-style-type: none"> • Make sure your machine and mobile device are in the Wi-Fi Direct mode. • Move the mobile device closer to your Brother machine. • Move your Brother machine and the mobile device to an obstruction-free area. • If you are manually configuring the Wi-Fi Direct network, make sure you have entered the correct password. • If your mobile device has a configuration page for obtaining an IP address, make sure your mobile device's IP address has been configured via DHCP. |
| Wrong Date&Time, contact your administrator. | The Brother machine does not obtain the time from the SNTP time server or you have not configured the Date&Time for the machine. | <ul style="list-style-type: none"> • Make sure the settings to access the SNTP time server are configured correctly in Web Based Management. • Confirm the Date&Time settings of your machine are correct in Web Based Management. |

**DCP-L2660DW/DCP-L2665DW/MFC-L2860DWE/MFC-L2860DW/MFC-L2862DW/
MFC-L2922DW/MFC-L2960DW/MFC-L2980DW**

| Error Messages | Cause | Action |
|-------------------------------------------|--------------------------------------------------------------------------------|----------------------------------------------------------------------------------------------------------------------------------------------------------------------|
| The maximum number of devices are already | Four mobile devices are already connected to the Wi-Fi Direct network when the | After the current connection between your Brother machine and another mobile device has shut down, try to configure the Wi-Fi Direct settings again. You can confirm |

| Error Messages | Cause | Action |
|---------------------------------------------------|---------------------------------------------------------------------------------------------------------------------------------------------------------------------------|-------------------------------------------------------------------------------------------------------------------------------------------------------------------------------------------------------------------------------------------------------------------------------------------------------------------------------------------------------------------------------------------------------------------------------------------------------------------------------------------------------------------------------------------------------------------------------------------------------------------------------------------------------------------------------------------------------------------------------------------------------------------------------------------------------------------|
| connected using Wi-Fi Direct. | Brother machine is the Group Owner. | the connection status by printing the Network Configuration Report. |
| Authentication Error, contact your administrator. | Your authentication setting for the Store Print Log to Network feature is not correct. | <ul style="list-style-type: none"> Make sure the Username and Password in Authentication Setting are correct. If the username is part of a domain, enter the username in one of the following styles: user@domain or domain\user. Make sure the time of the log file server matches the time from the SNTP server, or the Date&Time settings. Make sure the SNTP time server settings are configured correctly so the time matches the time used for authentication by Kerberos or NTLMv2. If there is no SNTP server, make sure the Date&Time and Time Zone settings are set correctly using Web Based Management or the control panel so the machine matches the time being used by the server providing the authentication. |
| Check User ID and Password. | The Kerberos Authentication error. | Make sure you have entered a correct user name and a password for the Kerberos server. For more information on the Kerberos server settings, contact your network administrator. |
| | The date, time and time zone settings of the Brother machine are not correct. | Confirm your machine's date, time, and time zone settings. |
| | The DNS server configuration is not correct. | Contact your network administrator for the information on the DNS server settings. |
| | The Kerberos Authentication configuration is correct. However, the user is not allowed to connect to the LDAP server. | Contact your network administrator for the information on your access rights. |
| Connection Error | Other devices are trying to connect to the Wi-Fi Direct network at the same time. | Make sure there are no other devices trying to connect to the Wi-Fi Direct network, and then try to configure the Wi-Fi Direct settings again. |
| Connection Failed | The Brother machine and your mobile device cannot communicate during the Wi-Fi Direct network configuration. | <ul style="list-style-type: none"> Move the mobile device closer to your Brother machine. Move your Brother machine and the mobile device to an obstruction-free area. If you are using the PIN Method of WPS, make sure you have entered the correct PIN. |
| File Access Error, contact your administrator. | The Brother machine cannot access the destination folder for the Store Print Log to Network feature. | <ul style="list-style-type: none"> Make sure the destination folder name is correct. Make sure the destination folder is write-enabled. Make sure the print log file is not locked. If it is, contact your network administrator. |
| Log Access Error | In Web Based Management, you have selected the Cancel Print option in the Error Detection Setting section of the Store Print Log to Network feature. | Wait for about 60 seconds until this message disappears from the LCD. |
| No Device | When configuring the Wi-Fi Direct network, the Brother machine cannot find your mobile device. | <ul style="list-style-type: none"> Make sure your machine and mobile device are in the Wi-Fi Direct mode. Move the mobile device closer to your Brother machine. Move your Brother machine and the mobile device to an obstruction-free area. |

| Error Messages | Cause | Action |
|------------------------------------------------|----------------------------------------------------------------------------------------------------------------------------------|---------------------------------------------------------------------------------------------------------------------------------------------------------------------------------------------------------------------------------------------------------------------------------------------------------------------------|
| | | <ul style="list-style-type: none"> If you are manually configuring the Wi-Fi Direct network, make sure you have entered the correct password. If your mobile device has a configuration page for obtaining an IP address, make sure your mobile device's IP address has been configured via DHCP. |
| Server Timeout | The Brother machine cannot connect to the LDAP server. | <ul style="list-style-type: none"> Make sure your server address is correct. Make sure your server is connected to the network. Make sure the machine is connected to the network. |
| | The Brother machine cannot connect to the Active Directory server. | <ul style="list-style-type: none"> Make sure your server address is correct. Make sure your server is connected to the network. Make sure the machine is connected to the network. |
| Server Timeout, contact your administrator. | The Brother machine cannot connect to the server for the Store Print Log to Network feature. | <ul style="list-style-type: none"> Make sure your server address is correct. Make sure your server is connected to the network. Make sure the machine is connected to the network. |
| Wrong Date & Time, contact your administrator. | The Brother machine does not obtain the time from the SNTP time server or you have not configured the Date&Time for the machine. | <ul style="list-style-type: none"> Make sure the settings to access the SNTP time server are configured correctly in Web Based Management. Confirm the Date&Time settings of your machine are correct in Web Based Management. |
| Internal Error | The Brother machine's LDAP protocol is disabled. | Confirm your authentication method, and then enable the necessary protocol setting in Web Based Management. |
| | The Brother machine's CIFS protocol is disabled. | |



Related Information

- [Network Problems](#)

Related Topics:

- [Print the Network Configuration Report](#)

Use the Network Connection Repair Tool (Windows)

Related Models: DCP-L2620DW/DCP-L2622DW/DCP-L2627DW/DCP-L2627DWXL/DCP-L2627DWE/DCP-L2640DN/DCP-L2660DW/DCP-L2665DW/MFC-L2802DN/MFC-L2800DW/MFC-L2802DW/MFC-L2827DWXL/MFC-L2827DW/MFC-L2835DW/MFC-L2860DWE/MFC-L2860DW/MFC-L2862DW/MFC-L2922DW/MFC-L2960DW/MFC-L2980DW

Use the Network Connection Repair Tool to fix the Brother machine's network settings. It will assign the correct IP address and Subnet Mask.

Make sure your machine is turned on and is connected to the same network as your computer.

1. Launch  (**Brother Utilities**), and then click the drop-down list and select your model name (if not already selected).
2. Click **Tools** in the left navigation bar, and then click **Network Connection Repair Tool**.
3. Follow the on-screen instructions.
4. Check the diagnosis by printing the Network Configuration Report or the Printer Settings page.



The Network Connection Repair Tool will start automatically if you select the **Enable Connection Repair Tool** option in the Status Monitor. Right-click the Status Monitor screen, and then click **Other Settings > Enable Connection Repair Tool**. This is not recommended when your network administrator has set the IP address to Static, since it will automatically change the IP address.

If the correct IP address and the Subnet Mask are still not assigned even after using the Network Connection Repair Tool, ask your network administrator for this information.



Related Information

- [Network Problems](#)

Related Topics:

- [Print the Network Configuration Report](#)
- [My Machine Cannot Print, Scan, or Use the PC-FAX Receive Function over the Network](#)
- [I Want to Check that My Network Devices are Working Correctly](#)

Check Your Machine's Network Settings

Related Models: DCP-L2620DW/DCP-L2622DW/DCP-L2627DW/DCP-L2627DWXL/DCP-L2627DWE/
DCP-L2640DN/DCP-L2660DW/DCP-L2665DW/MFC-L2802DN/MFC-L2800DW/MFC-L2802DW/
MFC-L2827DWXL/MFC-L2827DW/MFC-L2835DW/MFC-L2860DWE/MFC-L2860DW/MFC-L2862DW/
MFC-L2922DW/MFC-L2960DW/MFC-L2980DW

- [Print the Network Configuration Report](#)

If You Are Having Difficulty with Your Machine's Network

If you think there is a problem with your machine's network environment, check the following topics. You can correct most problems yourself.

If you need additional help, visit support.brother.com/faqs.

- [I Cannot Complete the Wireless Network Setup Configuration](#)
- [My Machine Cannot Print, Scan, or Use the PC-FAX Receive Function over the Network](#)
- [I Want to Check that My Network Devices are Working Correctly](#)

I Cannot Complete the Wireless Network Setup Configuration

Related Models: DCP-L2620DW/DCP-L2622DW/DCP-L2627DW/DCP-L2627DWXL/DCP-L2627DWE/DCP-L2660DW/DCP-L2665DW/MFC-L2800DW/MFC-L2802DW/MFC-L2827DWXL/MFC-L2827DW/MFC-L2835DW/MFC-L2860DWE/MFC-L2860DW/MFC-L2862DW/MFC-L2922DW/MFC-L2960DW/MFC-L2980DW

Turn your wireless router off and back on. Then, try to configure the wireless settings again. If you are unable to resolve the problem, follow the instructions below:

Investigate the problem using the WLAN Report.

| Cause | Action | Interface |
|------------------------------------------------------------------------------------------------------------------------------------------------|--------------------------------------------------------------------------------------------------------------------------------------------------------------------------------------------------------------------------------------------------------------------------------------------------------------------------------------------------------------------------------------------------------------------------------------------------------------------------------------------------------------------------------------------------------------------------------------------------------------------------------------------------------------------------------------------------------------------------------------------------------------------------------------------|--------------|
| Your security settings (SSID/ Network Key) are not correct. | <p>Confirm the security settings using Wireless Setup Helper (Windows). For more information and to download the utility, go to your model's Downloads page at support.brother.com/downloads.</p> <p>Select and confirm that you are using the correct security settings.</p> <ul style="list-style-type: none"> - See the instructions supplied with your wireless LAN access point/router for information on how to find the security settings. - The manufacturer's name or model number of the wireless LAN access point/router may be used as the default security settings. - Consult with the access point/router manufacturer, your Internet provider, or network administrator. | Wireless |
| Your Brother machine's MAC address is not allowed. | <p>Confirm that the Brother machine's MAC Address is allowed in the filter.</p> <p>You can find the MAC Address on your Brother machine's control panel.</p> | Wireless |
| Your wireless LAN access point/router is in Stealth mode (not broadcasting the SSID). | <ul style="list-style-type: none"> • Enter the correct SSID or Network Key manually. • Check the SSID or the Network Key in the instructions supplied with your wireless LAN access point/router and reconfigure the wireless network setup. | Wireless |
| Your machine is trying to connect to a 5 GHz Wi-Fi network. The current channel set on your wireless LAN access point/router is not supported. | <p>Change the channel on your wireless LAN access point/router to a channel supported by your machine.</p> <ol style="list-style-type: none"> 1. Confirm the channels supported by your machine. Go to support.brother.com/g/d/a5m6/, select your model for more information. 2. Check your wireless LAN access point/router's channel setting. Make sure it is set to one of the channels supported by your machine, and not set to "Auto" or "Automatic". For more information about changing the channel setting, see the instructions supplied with your wireless LAN access point/router. 3. Try to connect your machine to your Wi-Fi network again. | Wireless |
| Your security settings (SSID/ password) are not correct. | <p>Confirm the SSID and password.</p> <p>When you are configuring the network manually, the SSID and password are displayed on your Brother machine. If your mobile device supports the manual configuration, the SSID and password will be displayed on your mobile device's screen.</p> | Wi-Fi Direct |
| You are using Android™ 4.0. | <p>If your mobile device disconnects (approximately six minutes after using Wi-Fi Direct), try the one-push configuration using WPS (recommended) and set the Brother machine as a Group Owner.</p> | Wi-Fi Direct |
| Your Brother machine is placed too far from your mobile device. | <p>Move your Brother machine within about 3.3 feet (1 metre) of the mobile device when you configure the Wi-Fi Direct network settings.</p> | Wi-Fi Direct |
| There are some obstructions (walls or furniture, for | <p>Move your Brother machine to an obstruction-free area.</p> | Wi-Fi Direct |

| Cause | Action | Interface |
|------------------------------------------------------------------------------------------------------------------------------------------------------|-----------------------------------------------------------------------------------------------------------------------------------------------------------------------------------------------------------------------------------------------------------------------------------------------------------------------------------------------|--------------|
| example) between your machine and the mobile device. | | |
| There is a wireless computer, Bluetooth®-supported device, microwave oven, or digital cordless phone near the Brother machine or your mobile device. | Move other devices away from the Brother machine or your mobile device. | Wi-Fi Direct |
| You have checked and tried all of the above, but your Brother machine still cannot complete the Wi-Fi Direct configuration. | <ul style="list-style-type: none"> • Turn your Brother machine off and back on. Then, try to configure the Wi-Fi Direct settings again. • If you are using your Brother machine as a client, confirm how many devices are allowed on the current Wi-Fi Direct network, and then check how many devices are connected. | Wi-Fi Direct |

For Windows

If your wireless connection has been interrupted, and you have checked and tried all of the above, we recommend using the Network Connection Repair Tool.



Related Information

- [If You Are Having Difficulty with Your Machine's Network](#)



Related Topics:

- [Configure Your Machine for a Wireless Network When the SSID Is Not Broadcast](#)
- [Use Wi-Fi Direct®](#)

My Machine Cannot Print, Scan, or Use the PC-FAX Receive Function over the Network

Related Models: DCP-L2620DW/DCP-L2622DW/DCP-L2627DW/DCP-L2627DWXL/DCP-L2627DWE/DCP-L2640DN/DCP-L2660DW/DCP-L2665DW/MFC-L2802DN/MFC-L2800DW/MFC-L2802DW/MFC-L2827DWXL/MFC-L2827DW/MFC-L2835DW/MFC-L2860DWE/MFC-L2860DW/MFC-L2862DW/MFC-L2922DW/MFC-L2960DW/MFC-L2980DW

| Cause | Action |
|-----------------------------------------------------------------------------------------------------------------------------------|------------------------------------------------------------------------------------------------------------------------------------------------------------------------------------------------------------------------------------------------------------------------------------------------------------------------------------------------------------------------------------------------------------------------------------------------------------------------------------------------------------------------------------------------------------------------------------------------------------------------------------------------------------------------------------------------------------------------------------------------------------------------------------------------------------------------------------------------------------------------------------------------------------------------------------------------------------------------------|
| Your machine disconnects from the wireless network. | <ul style="list-style-type: none"> • DCP-L2620DW/DCP-L2622DW/DCP-L2627DW/DCP-L2627DWXL/DCP-L2627DWE/MFC-L2800DW/MFC-L2802DW/MFC-L2827DWXL/MFC-L2827DW/MFC-L2835DW <ol style="list-style-type: none"> 1. Press Wi-Fi. 2. Press ▲ or ▼ to select the <i>Recover WLAN</i> option, and then press OK. 3. When your wireless device connects successfully, the machine displays <i>Connected</i>. • DCP-L2660DW/DCP-L2665DW/MFC-L2860DWE/MFC-L2860DW/MFC-L2862DW/MFC-L2922DW/MFC-L2960DW/MFC-L2980DW <ol style="list-style-type: none"> 1. Press  > <i>Recover WLAN</i>. 2. When your wireless device connects successfully, the machine displays <i>Connected</i>. |
| Your security software blocks your machine's access to the network. (The network scanning feature does not work.) | <ul style="list-style-type: none"> • Windows <p>Configure the third-party Security/Firewall Software to allow network scanning. To add port 54925 for network scanning, type the information below:</p> <ul style="list-style-type: none"> - In Name: Type any description, for example Brother NetScan. - In Port number: Type 54925. - In Protocol: UDP is selected. <p>See the instruction manual that came with your third-party Security/Firewall Software or contact the software manufacturer.</p> • Mac (Brother iPrint&Scan) <p>In the Finder menu bar, click Go > Applications, and then double-click the Brother iPrint&Scan icon. The Brother iPrint&Scan window appears. Click the Select your Machine button, and then follow the on-screen instructions to reselect your network machine.</p> |
| Your security software blocks your machine's access to the network. (The network PC-Fax Receive feature does not work.) (Windows) | <p>Set the third-party Security/Firewall Software to allow PC-FAX Rx. To add port 54926 for Network PC-FAX Rx, type the information below:</p> <ul style="list-style-type: none"> • In Name: Type any description, for example Brother PC-FAX Rx. • In Port number: Type 54926. • In Protocol: UDP is selected. <p>See the instruction manual that came with your third-party Security/Firewall Software or contact the software manufacturer.</p> |

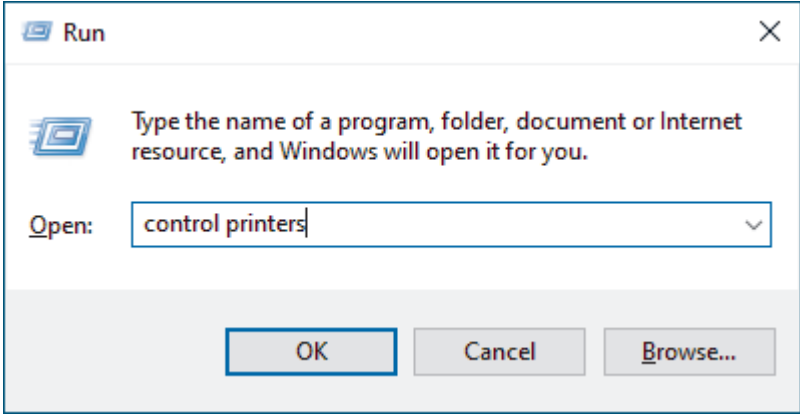
| Cause | Action |
|---------------------------------------------------------------------|----------------------------------------------------------------------------------------------------------------------------------------------------------------------------------------------------------------------------------------------------------------------------------------------------------------------------------------------------------------------------------------------------------------------------------------------------------------------------------------------------------------------------------------------------------------------------------------------------------------------------------------------------------------------------------------------------------------------------------------------------------------------------------------------------------------------------------------------------------------------------------------|
| Your security software blocks your machine's access to the network. | <p>Some security software might block access without showing a security alert dialog box even after successful installation.</p> <p>To allow access, see the instructions for your security software or ask the software manufacturer.</p> |
| Your Brother machine was not assigned an available IP address. | <ul style="list-style-type: none"> • Confirm the IP address and the Subnet Mask. Verify that both the IP addresses and Subnet Masks of your computer and the Brother machine are correct and located on the same network. For more information about how to verify the IP address and the Subnet Mask, ask your network administrator. • Windows Confirm the IP address and the Subnet Mask using the Network Connection Repair Tool. |
| A failed print job is still in your computer's print queue. | <ul style="list-style-type: none"> • If a failed print job is still in your computer's print queue, delete it. • Otherwise, double-click the printer icon in the following folder and cancel all documents: (Windows) <ol style="list-style-type: none"> 1. Hold down the  key and press the  key on the computer's keyboard to launch Run. 2. Type "control printers" in the Open: field and click OK.  <p>(Mac) Click System Settings > Printers & Scanners or System Preferences > Printers & Scanners.</p> |
| Your machine is not connected to the wireless network. | <p>Print the WLAN Report to check the error code on the printed report. See <i>Related Information: Print the WLAN Report</i>.</p> |

If you have checked and tried all of the above, but you are still having problems, uninstall the drivers (Windows) and the software and reinstall the latest ones.



Related Information

- [If You Are Having Difficulty with Your Machine's Network](#)

Related Topics:

- [Print the WLAN Report](#)
- [Wireless LAN Report Error Codes](#)
- [Use the Network Connection Repair Tool \(Windows\)](#)
- [I Want to Check that My Network Devices are Working Correctly](#)

I Want to Check that My Network Devices are Working Correctly

Related Models: DCP-L2620DW/DCP-L2622DW/DCP-L2627DW/DCP-L2627DWXL/DCP-L2627DWE/DCP-L2640DN/DCP-L2660DW/DCP-L2665DW/MFC-L2802DN/MFC-L2800DW/MFC-L2802DW/MFC-L2827DWXL/MFC-L2827DW/MFC-L2835DW/MFC-L2860DWE/MFC-L2860DW/MFC-L2862DW/MFC-L2922DW/MFC-L2960DW/MFC-L2980DW

| Check | Action |
|------------------------------------------------------------------------------------------------|------------------------------------------------------------------------------------------------------------------------------------------------------------------------------------------------------------------------------------------------------------------------------------------------------------------------------------------------------------------------------------------------------------------------------------------------------------------------------------------------------------------------------------------------------------------------------------------------------------------------------------------------------------------------------------------------|
| Check that your Brother machine, access point/router, or network hub is turned on. | <p>Check the following:</p> <ul style="list-style-type: none"> The power cord is connected correctly and the Brother machine is turned on. The access point/router or hub is turned on and its link LED is blinking. All protective packaging has been removed from the machine. The toner cartridge and drum unit assembly is installed correctly. The machine's cover is fully closed. Paper is loaded correctly in the paper tray. (For wired networks) A network cable is securely connected to the Brother machine and to the router or hub. |
| Check the Link Status on the Network Configuration Report or the Printer Settings page. | Print the Network Configuration Report and check that Ethernet Link Status or Wireless Link Status is Link OK . |
| Check that you can "ping" the Brother machine from your computer. | <p>Ping the Brother machine from your computer using the IP address or the node name in the Windows command prompt or Mac Terminal application:</p> <p>ping <ipaddress> or <nodename>.</p> <ul style="list-style-type: none"> Successful: Your Brother machine is working correctly and connected to the same network as your computer. Unsuccessful: Your Brother machine is not connected to the same network as your computer. <p>Windows: Ask your administrator about the IP address and the subnet mask, and then use the Network Connection Repair Tool.</p> <p>Mac: Confirm that the IP address and the Subnet Mask are set correctly.</p> |
| Check that your Brother machine is connected to the wireless network. | Print the WLAN Report to check the error code on the printed report. See <i>Related Information: Print the WLAN Report</i> . |

If you have checked and tried all of the above but you are still having problems, see the instructions supplied with your wireless access point/router to find the SSID (Network Name) and the Network Key (Password) information and set them correctly.



Related Information

- [If You Are Having Difficulty with Your Machine's Network](#)

Related Topics:

- [Print the Network Configuration Report](#)
- [Print the WLAN Report](#)
- [Wireless LAN Report Error Codes](#)
- [Use the Network Connection Repair Tool \(Windows\)](#)
- [My Machine Cannot Print, Scan, or Use the PC-FAX Receive Function over the Network](#)

AirPrint Problems

Related Models: DCP-L2620DW/DCP-L2622DW/DCP-L2627DW/DCP-L2627DWXL/DCP-L2627DWE/DCP-L2640DN/DCP-L2660DW/DCP-L2665DW/MFC-L2802DN/MFC-L2800DW/MFC-L2802DW/MFC-L2827DWXL/MFC-L2827DW/MFC-L2835DW/MFC-L2860DWE/MFC-L2860DW/MFC-L2862DW/MFC-L2922DW/MFC-L2960DW/MFC-L2980DW

| Difficulties | Suggestions |
|-----------------------------------------------------------------------------------------------------|-----------------------------------------------------------------------------------------|
| My machine is not displayed in the printer list. | Make sure your machine is turned on. |
| | Make sure your machine and your mobile device or Mac are connected to the same network. |
| | Move your mobile device closer to the wireless access point/router, or to your machine. |
| I cannot print. | Make sure your machine is turned on. |
| | Make sure your machine and your mobile device or Mac are connected to the same network. |
| I am trying to print a multi-page document from an iOS device, but ONLY the first page is printing. | Make sure you are running the latest OS version. |







Related Information

- [Troubleshooting](#)

Related Topics:

- [AirPrint Overview](#)

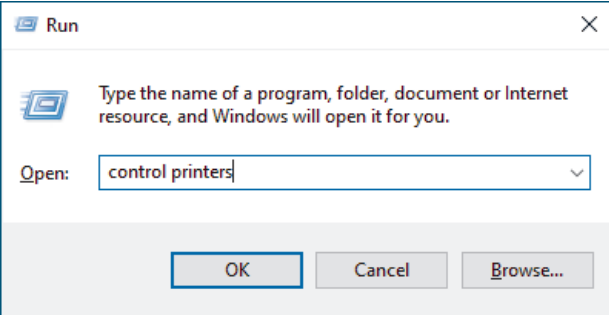
Other Problems

| Difficulties | Suggestions |
|---------------------------------------------------------------------------------------------------|------------------------------------------------------------------------------------------------------------------------------------------------------------------------------------------------------------------------------------------------------------------------------------------------------------------------------------------------------------------------------------------------------------------------------------------------------------------------------------------------------------------------------------------------------------------------------------------------------------------------------------------------------------------------------------------------------------------------------------------------------------------------------------------------------------------------------------------------------------------------------------------------------------------------------------------------------------------------------------------------------------------------------------------------------------------------------------------------------------------------------------------------------------------------------------------------------------------------------------------------------------------------------------------------------------|
| <p>The machine will not turn on.</p> | <p>Adverse conditions on the power connection (such as lightning or a power surge) may have triggered the machine's internal safety mechanisms. Unplug the power cord. Wait for ten minutes, then plug in the power cord and press  to turn the machine on.</p> <p>If the problem is not solved and you are using a power breaker, disconnect it to make sure it is not the problem. Plug the machine's power cord directly into a different known working wall electrical socket. If there is still no power, try a different power cable.</p> |
| <p>The machine cannot print EPS data that includes binary with the BR-Script3 printer driver.</p> | <p>(Windows)</p> <p>To print EPS data, do the following:</p> <ol style="list-style-type: none"> 1. Hold down the  key and press the  key on the computer's keyboard to launch Run. 2. Type "control printers" in the Open: field and click OK. <div data-bbox="858 887 1473 1200" style="border: 1px solid #ccc; padding: 5px; margin: 10px 0;">  </div> <ol style="list-style-type: none"> 3. Right-click your model's icon with BR-Script3 in the name, select Printer properties. <p> If your model with BR-Script3 in the name does not appear, right-click your model's icon, select Printer properties, and then select your model with BR-Script3 in the name.</p> <ol style="list-style-type: none"> 4. From the Device Settings tab, choose TBCP (Tagged Binary Communication Protocol) in Output Protocol. |
| <p>The Brother software cannot be installed.</p> | <p>(Windows)</p> <p>If the Security Software warning appears on the computer screen during the installation, change the Security Software settings to permit the Brother product setup program or other program to run.</p> <p>(Mac)</p> <p>If you are using a firewall function of anti-spyware or antivirus security software, temporarily disable it and then install the Brother software.</p> |

Copying difficulties

| Difficulties | Suggestions |
|----------------------------|---------------------------------------------------------------------------------------------------------------------------------------------------|
| <p>Cannot make a copy.</p> | <p>Make sure you pressed Copy and the machine is in Copy mode.</p> <p>Contact your administrator to check your Secure Function Lock settings.</p> |

| Difficulties | Suggestions |
|----------------------------------------|--------------------------------------------------------------------------------------------------------------------------------------------------------------------------------------------------------------------------|
| Vertical black line appears in copies. | Black vertical lines on copies are typically caused by dirt or correction fluid on the glass strip, or the corona wire is dirty. Clean the glass strip and scanner glass and the white bar and white plastic above them. |
| Copies are blank. | Make sure you are loading the document correctly. |

Scanning difficulties

| Difficulties | Suggestions |
|----------------------------------------------------------------|------------------------------------------------------------------------------------------------------------------------------------------------------------------------------------------------------------------------------------------------|
| TWAIN or WIA errors appear when starting to scan. (Windows) | Make sure the Brother TWAIN or WIA driver is selected as the primary source in your scanning application. For example, in Nuance™ PaperPort™ 14SE, click Desktop > Scan Settings > Select to select the Brother TWAIN/WIA driver. |
| OCR does not work. | Try increasing the scanning resolution. |
| Cannot scan. | Contact your administrator to check your Secure Function Lock settings. |

Software difficulties

| Difficulties | Suggestions |
|-----------------------------------|--------------------------------------------------------------------------------------------------|
| Cannot install software or print. | (Windows) Run the install program again. This program will repair and reinstall the software. |



Related Information

- [Troubleshooting](#)

Check the Machine Information

Follow these instructions to check your machine's serial number and firmware version.

>> DCP-L2600D/DCP-L2620DW/DCP-L2622DW/DCP-L2627DW/DCP-L2627DWXL/DCP-L2627DWE/
DCP-L2640DN/MFC-L2802DN/MFC-L2800DW/MFC-L2802DW/MFC-L2827DWXL/MFC-L2827DW/
MFC-L2835DW
>> DCP-L2660DW/DCP-L2665DW/MFC-L2860DWE/MFC-L2860DW/MFC-L2862DW/MFC-L2922DW/
MFC-L2960DW/MFC-L2980DW

**DCP-L2600D/DCP-L2620DW/DCP-L2622DW/DCP-L2627DW/DCP-L2627DWXL/
DCP-L2627DWE/DCP-L2640DN/MFC-L2802DN/MFC-L2800DW/MFC-L2802DW/
MFC-L2827DWXL/MFC-L2827DW/MFC-L2835DW**

1. Press **Menu**.
2. Press **▲** or **▼** to display the [Machine Info.] option, and then press **OK**.
3. Press **▲** or **▼** to select one of the following options:

| Option | Description |
|--------------|----------------------------------------------------------|
| Serial No. | Check your machine's serial number. |
| Version | Check your machine's firmware version. |
| Page Counter | Check the total number of pages the machine has printed. |
| Parts Life | Check the supplies' life that remains available. |

4. Press **OK**.
5. Press **Stop/Exit**.

**DCP-L2660DW/DCP-L2665DW/MFC-L2860DWE/MFC-L2860DW/MFC-L2862DW/
MFC-L2922DW/MFC-L2960DW/MFC-L2980DW**

1. Press  [Settings] > [All Settings] > [Machine Info.].
2. Press one of the following options:

| Option | Description |
|---------------------|----------------------------------------------------------|
| Serial No. | Check your machine's serial number. |
| Firmware Version | Check your machine's firmware version. |
| Firmware Update | Update your machine to the latest firmware. |
| Firmware Auto Check | View firmware information on the Home screen. |
| Page Counter | Check the total number of pages the machine has printed. |
| Parts Life | Check the supplies' life that remains available. |

3. Press .



Related Information

- [Troubleshooting](#)

Update Your Machine's Firmware

To keep your machine up to date, check support.brother.com/downloads periodically for the latest firmware. Without the most current firmware, some of your machine's functions may become unavailable.

You can also update the firmware directly from your machine by following these steps: (DCP-L2660DW/ DCP-L2665DW/MFC-L2860DWE/MFC-L2860DW/MFC-L2862DW/MFC-L2922DW/MFC-L2960DW/ MFC-L2980DW)

1. Press  [Settings] > [All Settings] > [Machine Info.].
2. Press [Firmware Update].
3. Press .



Related Information

- [Troubleshooting](#)

Related Topics:

- [Check Your Machine's Password](#)

Reset Your Machine

>> DCP-L2600D/DCP-L2620DW/DCP-L2622DW/DCP-L2627DW/DCP-L2627DWXL/DCP-L2627DWE/
DCP-L2640DN/MFC-L2802DN/MFC-L2800DW/MFC-L2802DW/MFC-L2827DWXL/MFC-L2827DW/
MFC-L2835DW
>> DCP-L2660DW/DCP-L2665DW/MFC-L2860DWE/MFC-L2860DW/MFC-L2862DW/MFC-L2922DW/
MFC-L2960DW/MFC-L2980DW

**DCP-L2600D/DCP-L2620DW/DCP-L2622DW/DCP-L2627DW/DCP-L2627DWXL/
DCP-L2627DWE/DCP-L2640DN/MFC-L2802DN/MFC-L2800DW/MFC-L2802DW/
MFC-L2827DWXL/MFC-L2827DW/MFC-L2835DW**

1. Press **Menu**.
2. Press **▲** or **▼** to display the [Initial Setup] option, and then press **OK**.
3. Press **▲** or **▼** to display the [Reset] option, and then press **OK**.
4. Press **▲** or **▼** to choose the type of reset you want to perform, and then press **OK**.



Subdivided reset functions are not available for some models.

5. Press the option in the table to reset the machine or to exit the process.

| Option | Description |
|--------|--------------------------------------------------|
| ▲ | Reset the machine. |
| ▼ | The machine will exit and cancel the reset menu. |

The LCD displays [Reboot OK?].

6. Press the option in the table to reboot the machine or to exit the process.

| Option | Description |
|--------|-------------------------------------------------------|
| ▲ | Reboot the machine. The machine will begin the reset. |
| ▼ | The machine will exit without rebooting. |



If you exit without rebooting, your machine will not reset and your settings will remain unchanged.

**DCP-L2660DW/DCP-L2665DW/MFC-L2860DWE/MFC-L2860DW/MFC-L2862DW/
MFC-L2922DW/MFC-L2960DW/MFC-L2980DW**

1. Press  [Settings] > [All Settings] > [Initial Setup] > [Reset].
2. Press **▲** or **▼** to display the type of reset functions, and then press the reset function you want to use.
The LCD displays [Machine will reboot after resetting. Press [OK] for 2 seconds to confirm.].
3. Press the option in the table to reboot the machine or to exit the process.

| Option | Description |
|---------------------------------|-------------------------------------------------------|
| Press OK for two seconds | Reboot the machine. The machine will begin the reset. |
| Cancel | The machine will exit without rebooting. |



If you exit without rebooting, your machine will not reset and your settings will remain unchanged.

4. Press .



You can also reset the Network settings by pressing  [Settings] > [All Settings] > [Network] > [Network Reset].



Related Information

- [Troubleshooting](#)
 - [Reset Functions Overview](#)

Related Topics:

- [Check Your Machine's Password](#)
 - [Reset the Network Settings to the Factory Settings](#)
-

Reset Functions Overview

The following reset functions are available:



Unplug the interface cable before you choose Network Settings Reset function, All Settings Reset function or Factory Reset function.

>> DCP-L2600D/DCP-L2620DW/DCP-L2622DW/DCP-L2627DW/DCP-L2627DWXL/DCP-L2627DWE/
DCP-L2640DN/MFC-L2802DN/MFC-L2800DW/MFC-L2802DW/MFC-L2827DWXL/MFC-L2827DW/
MFC-L2835DW
>> DCP-L2660DW/DCP-L2665DW/MFC-L2860DWE/MFC-L2860DW/MFC-L2862DW/MFC-L2922DW/
MFC-L2960DW/MFC-L2980DW

**DCP-L2600D/DCP-L2620DW/DCP-L2622DW/DCP-L2627DW/DCP-L2627DWXL/
DCP-L2627DWE/DCP-L2640DN/MFC-L2802DN/MFC-L2800DW/MFC-L2802DW/
MFC-L2827DWXL/MFC-L2827DW/MFC-L2835DW**



Subdivided reset functions are not available for some models.

1. Machine Reset

This function resets the following settings:

- Programmed fax jobs in the memory (For MFC Models)
(Delayed Fax)
- Coverpage Message (For MFC Models)
- Remote Fax Options (For MFC Models)
(Remote Access Code, Fax Storage, Fax Forwarding, and PC-Fax Receive (Windows only))
- Language Setting

2. Network Settings Reset (For Network Models)

Reset the print server to its default factory settings (including all IP Address information except the administrator password).

3. Address Book and Fax Settings Reset (For MFC Models)

This function resets the following settings:

- Address Book
(Shortcut / Speed Dial / Setup Groups)
- Programmed fax jobs in the memory
- Station ID
(name and number)
- Coverpage Message
- Remote Fax Options
(Remote Access Code, Fax Storage, Fax Forwarding, and PC-Fax Receive (Windows only))
- Report
(Transmission Verification Report/ Tel Index List/Fax Journal)
- Setting Lock password

4. All Settings Reset

You can reset all the machine's settings back to the settings that were set at the factory.

All Settings Reset takes less time than Factory Reset.

5. Factory Reset

Use the Settings Reset function to reset all of the machine's settings to the settings originally set at the factory.

Factory Reset takes more time than All Settings Reset.

We strongly recommend you perform this operation when you dispose of the machine.

DCP-L2660DW/DCP-L2665DW/MFC-L2860DWE/MFC-L2860DW/MFC-L2862DW/ MFC-L2922DW/MFC-L2960DW/MFC-L2980DW

1. Machine Reset

You can reset all the machine's settings that you have changed, such as Date and Time and Ring Delay.

The Address Book, fax reports, and Call history will remain. (For MFC Models)

2. Network Settings Reset (For Network Models)

Reset the print server to its default factory settings (including all IP Address information except the administrator password).

3. Address Book and Fax Settings Reset (For MFC Models)

This function resets the following settings:

- Address Book
(Addresses and Groups)
- Programmed fax jobs in the memory
- Station ID
(name and number)
- Coverpage Message
- Remote Fax Options
(Remote Access Code, Fax Storage, Fax Forwarding, and PC-Fax Receive (Windows only))
- Report
(Transmission Verification Report/ Tel Index List/Fax Journal)
- Setting Lock password

4. All Settings Reset

You can reset all the machine's settings back to the settings that were set at the factory.

All Settings Reset takes less time than Factory Reset.

5. Factory Reset

Use the Settings Reset function to reset all of the machine's settings to the settings originally set at the factory.

Factory Reset takes more time than All Settings Reset.

We strongly recommend you perform this operation when you dispose of the machine.

Related Information

- [Reset Your Machine](#)

Routine Maintenance

- [Replace Supplies](#)
- [Clean the Machine](#)
- [Check the Remaining Part Life](#)
- [Pack and Ship Your Machine](#)

Replace Supplies

You must replace supplies when the machine indicates that the life of the supply is over.

The toner cartridge and drum unit are two separate supplies. Make sure both are installed as an assembly. The product code of supplies may vary depending on the country.

NOTE

- Be sure to seal the used supplies tightly in a bag so that toner powder does not spill out of the cartridge.
- Visit go.brother/original for instructions on how to return your used supplies to the Brother collection and recycling program. If your local Brother office does not have the collection program yet, or you choose not to return your used supply, discard the used supply according to local regulations, keeping it separate from domestic waste. If you have questions, contact your local waste disposal office.
- We recommend placing both the new and the used supplies on a piece of paper to prevent accidentally spilling or scattering the contents.
- Using paper that is not a direct equivalent for a recommended print media may reduce the life of supplies and machine parts.
- The projected life for each of the toner cartridges is based on ISO/IEC 19752. Frequency of replacement will vary depending on the print volume, percentage of coverage, types of media used, and powering on/off the machine.
- Frequency of replacing supplies except toner cartridges will vary depending on the print volume, types of media used, and powering on/off the machine.
- Handle the toner cartridge carefully. If toner scatters on your hands or clothes, immediately wipe or wash it off with cold water.

IMPORTANT

To avoid print quality problems, DO NOT touch the shaded parts shown in the illustrations.

Toner Cartridge

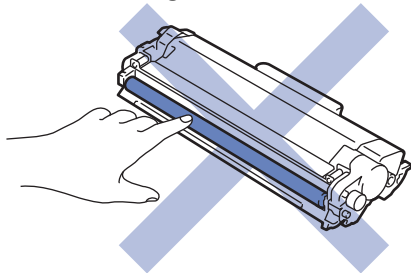

Drum Unit

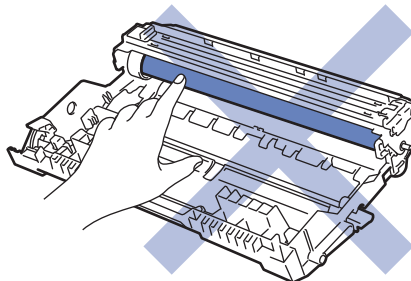

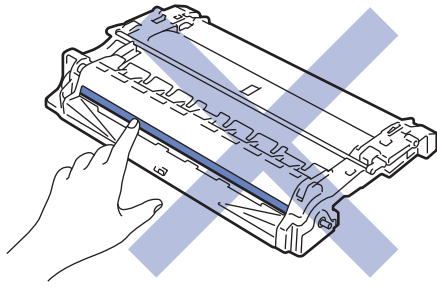

Related Information

- Routine Maintenance
 - Replace the Toner Cartridge
 - Replace the Drum Unit
 - Reset the Drum Counter
-

Replace the Toner Cartridge

1. Make sure the machine is turned on.
2. Open the front cover.

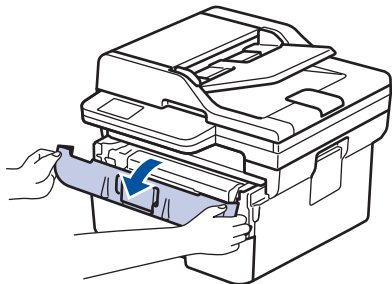

3. Remove the toner cartridge and drum unit assembly from the machine.

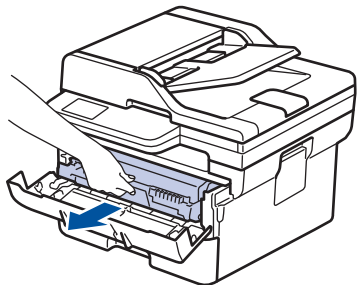

4. Push down the green lock lever and take the toner cartridge out of the drum unit.

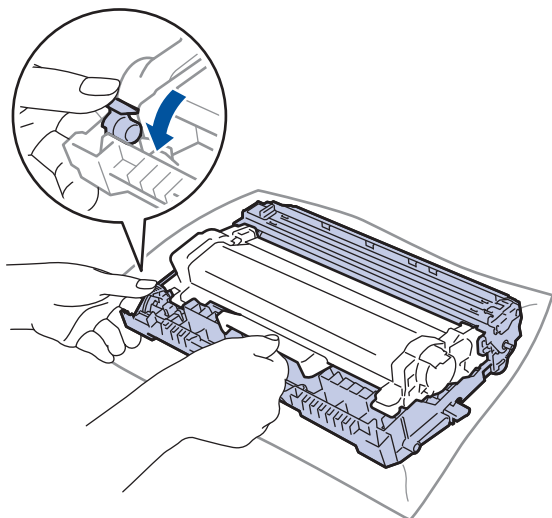

5. Unpack the new toner cartridge.
6. Remove the protective cover.

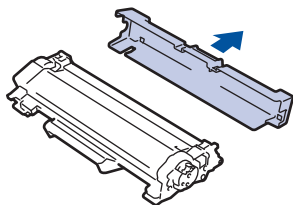

-
7. Hold the toner cartridge by the handle and shake it from left to right several times, as shown. Then push it firmly into the drum unit until it locks into place.

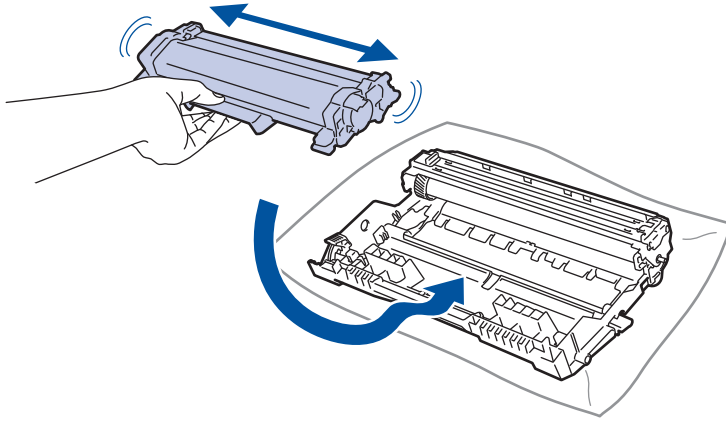

Make sure you put the toner cartridge in correctly or it may separate from the drum unit.

8. Clean the corona wire inside the drum unit by gently sliding the green tab from left to right and right to left several times.

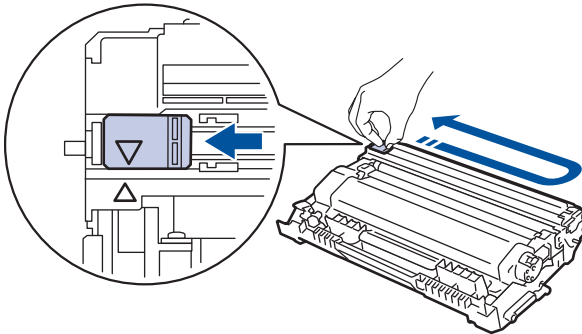

Be sure to return the tab to the Home position (▲). The arrow on the tab must be aligned with the arrow on the drum unit. If it is not, printed pages may have a vertical stripe.

9. Reinsert the toner cartridge and drum unit assembly back into the machine.

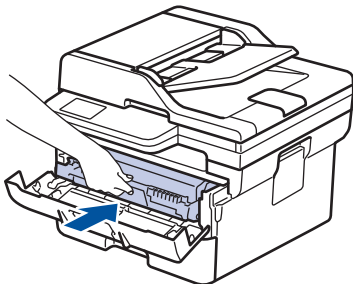

10. Close the front cover of the machine.



-
- After replacing a toner cartridge, DO NOT turn the machine off or open the front cover until the machine's display returns to Ready Mode.
 - The toner cartridge that comes with your Brother machine is an Inbox toner cartridge.
 - It is a good idea to keep a new toner cartridge ready for use when you see the Toner Low warning.
 - DO NOT unpack the new toner cartridge until you are ready to install it.
 - If a toner cartridge is left unpacked for a long time, the toner life will be shortened.
 - We recommend using genuine Brother supplies to ensure stable print quality and performance. Although not all non-genuine supplies may cause quality issues, it is possible that some may adversely affect print quality or cause machine malfunction. Brother may charge for repairing your machine if it is proven that non-genuine supplies caused the damage, even if the machine is still covered by the warranty.
-



Related Information

- [Replace Supplies](#)

Related Topics:

- [Error and Maintenance Messages](#)
 - [Improve the Print Quality](#)
-

Replace the Drum Unit

1. Make sure the machine is turned on.
2. Open the front cover.

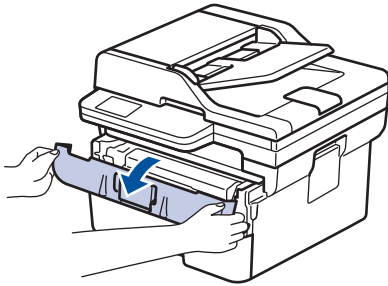

3. Remove the toner cartridge and drum unit assembly from the machine.

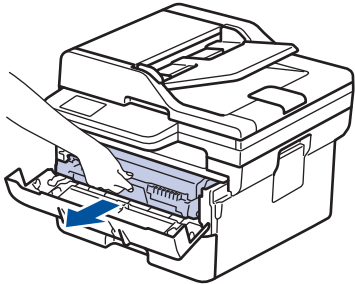

4. Push down the green lock lever and take the toner cartridge out of the drum unit.

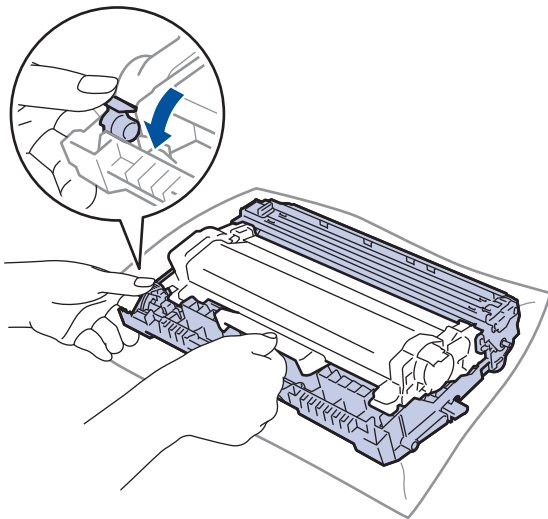

5. Unpack the new drum unit.
6. Push the toner cartridge firmly into the new drum unit until it locks into place.

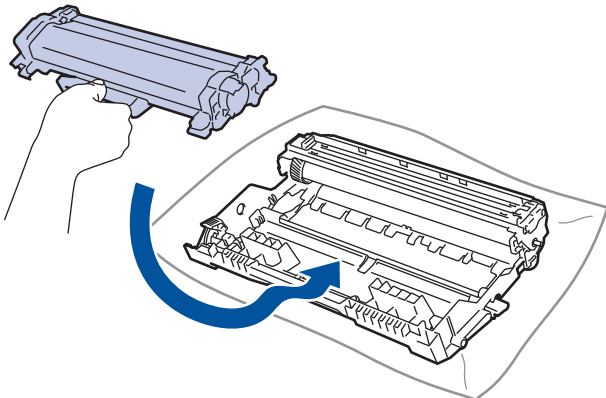

Make sure you put the toner cartridge in correctly or it may separate from the drum unit.

-
7. Reinsert the toner cartridge and drum unit assembly back into the machine.

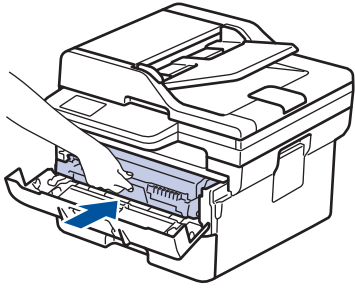

8. Close the front cover of the machine.



After installing the new drum unit, you must reset the drum counter. See *Related Information: Reset the Drum Counter*.

NOTE

- Drum wear and tear occurs due to use and rotation of the drum and interaction with paper, toner, and other materials in the paper path. In designing this product, Brother decided to use the number of rotations of the drum as a reasonable determinant of the drum life. When a drum reaches the factory-established rotation limit corresponding to the rated page yield, the product's LCD will advise you to replace the drum. The product will continue to function; however, print quality may not be optimal.
- If an unpacked drum unit is placed in direct sunlight (or room light for long periods of time), the unit may be damaged.
- There are many factors that determine the actual drum life, such as the temperature, humidity, type of paper, type of toner used and so on. Under ideal conditions, the average drum life is estimated at approximately 15,000 pages based on one page per job (A4/Letter single-sided pages). The number of pages may be affected by a variety of factors including, but not limited to, media type and media size.
Because we have no control over the many factors that determine the actual drum life, we cannot guarantee a minimum number of pages that will be printed by your drum.
- The machine should be used only in a clean, dust-free environment with adequate ventilation.
We recommend using genuine Brother supplies to ensure stable print quality and performance. Although not all non-genuine supplies may cause quality issues, it is possible that some may adversely affect print quality or cause machine malfunction. Brother may charge for repairing your machine if it is proven that non-genuine supplies caused the damage, even if the machine is still covered by the warranty.



Related Information

- [Replace Supplies](#)

Related Topics:

- [Error and Maintenance Messages](#)
 - [Improve the Print Quality](#)
 - [Reset the Drum Counter](#)
-

Reset the Drum Counter

When you replace the drum unit with a new one, you must reset the drum counter by completing the following steps:

IMPORTANT

DO NOT reset the drum counter unless you are replacing the drum unit.



>> DCP-L2600D/DCP-L2620DW/DCP-L2622DW/DCP-L2627DW/DCP-L2627DWXL/DCP-L2627DWE/
DCP-L2640DN/MFC-L2802DN/MFC-L2800DW/MFC-L2802DW/MFC-L2827DWXL/MFC-L2827DW/
MFC-L2835DW

>> DCP-L2660DW/DCP-L2665DW/MFC-L2860DWE/MFC-L2860DW/MFC-L2862DW/MFC-L2922DW/
MFC-L2960DW/MFC-L2980DW

**DCP-L2600D/DCP-L2620DW/DCP-L2622DW/DCP-L2627DW/DCP-L2627DWXL/
DCP-L2627DWE/DCP-L2640DN/MFC-L2802DN/MFC-L2800DW/MFC-L2802DW/
MFC-L2827DWXL/MFC-L2827DW/MFC-L2835DW**

1. Make sure the machine is turned on.
2. Make sure the machine's cover is closed.
3. Press **OK** and **▲** at the same time.
4. Press **OK** to select [Drum].
5. Press **▲** to reset the drum counter.

**DCP-L2660DW/DCP-L2665DW/MFC-L2860DWE/MFC-L2860DW/MFC-L2862DW/
MFC-L2922DW/MFC-L2960DW/MFC-L2980DW**

1. Make sure the machine is turned on.
2. Close the front cover of the machine.
3. Press  to clear the error.
4. Press  (Toner) until the touchscreen message changes.
5. Press [Drum].
6. Press [Yes].

Related Information

- [Replace Supplies](#)

Related Topics:

- [Replace the Drum Unit](#)

Clean the Machine

Clean the outside and inside of the machine regularly with a dry, lint-free cloth.

When you replace the toner cartridge or the drum unit, make sure you clean the inside of the machine. If printed pages are stained with toner, clean the inside of the machine with a dry, lint-free cloth.

! WARNING

DO NOT use flammable substances, any type of spray, or an organic solvent/liquid containing alcohol or ammonia to clean the inside or outside of the product. Doing so could cause a fire. Instead, use only a dry, lint-free cloth.



IMPORTANT

- DO NOT use isopropyl alcohol to remove dirt from the control panel. It may crack the panel.
- To avoid print quality problems, DO NOT touch the shaded parts shown in the illustrations.

Toner cartridge

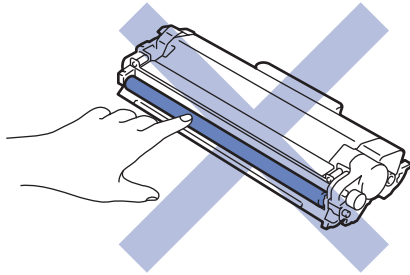

Drum unit

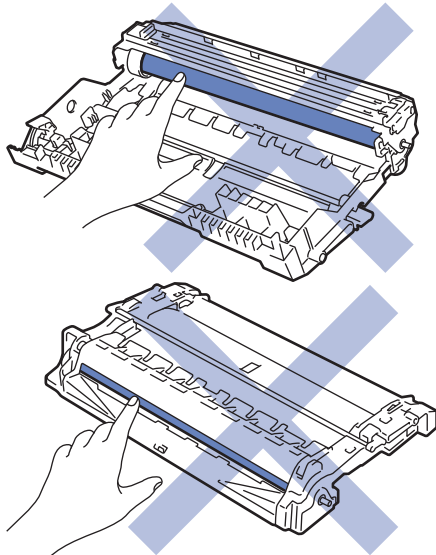



(For certain models) The toner cartridge features an IC chip. DO NOT touch this surface. Touching the IC chip may cause contamination or damage, and may interfere with the machine's ability to detect this component.

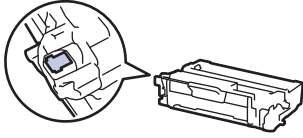

Related Information

- [Routine Maintenance](#)
 - [Clean the Scanner](#)
 - [Clean the Touchscreen LCD](#)
 - [Clean the Corona Wire](#)
 - [Clean the Drum Unit](#)
 - [Clean the Paper Pick-up Rollers](#)
-

Clean the Scanner

Before starting the cleaning procedure, see *Related Information: Clean the Machine*.

1. Press and hold  to turn the machine off.
2. Lift the document cover (1). Clean the white plastic surface (2) and scanner glass (3) underneath it with a soft lint-free cloth moistened with water.

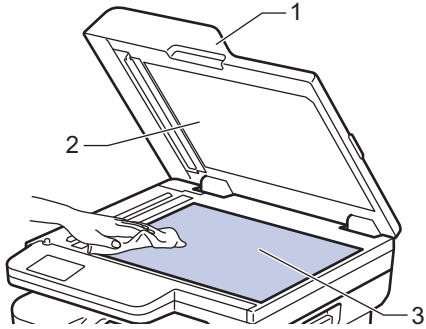

3. In the ADF unit, clean the white bar (1) and the scanner glass strip (2) underneath it with a soft lint-free cloth moistened with water.

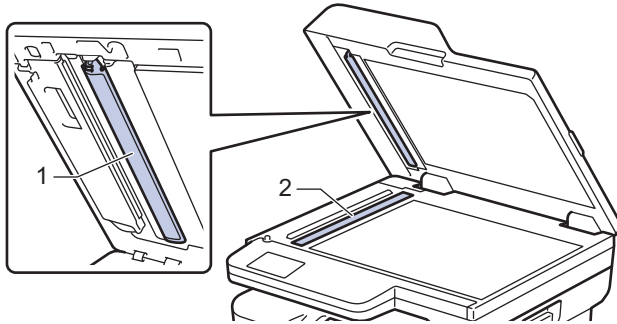

4. (For automatic 2-sided scanning models) Open the scanner glass cover (1), and then clean the other white bar (2) and scanner glass strip (3).

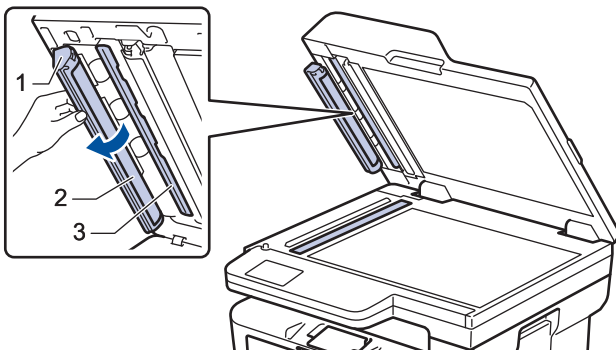

5. Close the document cover.
6. Press  to turn the machine on.



Related Information

- [Clean the Machine](#)

Related Topics:

- [Improve the Print Quality](#)

Clean the Touchscreen LCD

Related Models: DCP-L2660DW/DCP-L2665DW/MFC-L2860DWE/MFC-L2860DW/MFC-L2862DW/MFC-L2922DW/MFC-L2960DW/MFC-L2980DW

Before starting the cleaning procedure, see *Related Information: Clean the Machine*.

IMPORTANT

DO NOT use any type of liquid cleaners (including ethanol).

1. Press and hold  to turn the machine off.
2. Clean the touchscreen with a dry, soft lint-free cloth.

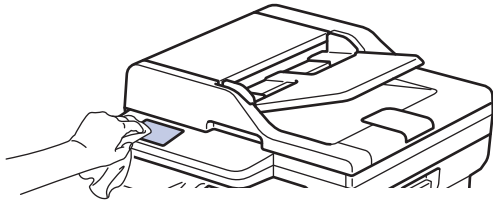

3. Press  to turn the machine on.

✓ Related Information

- [Clean the Machine](#)

Clean the Corona Wire

If you have print quality problems or the control panel displays [Drum !] status, clean the corona wire.

1. Open the front cover.

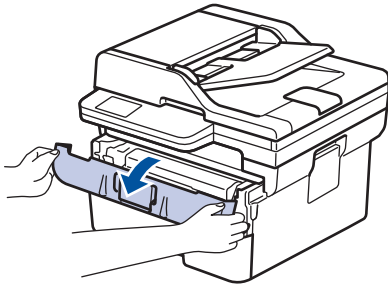

2. Remove the toner cartridge and drum unit assembly from the machine.

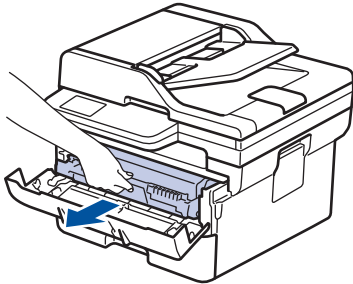

3. Clean the corona wire inside the drum unit by gently sliding the green tab from left to right and right to left several times.

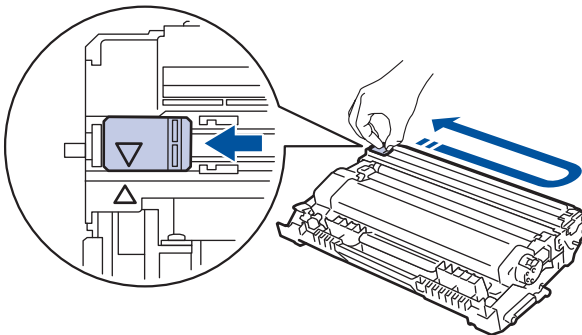

Be sure to return the tab to the Home position (▲). The arrow on the tab must be aligned with the arrow on the drum unit. If it is not, printed pages may have a vertical stripe.

4. Reinsert the toner cartridge and drum unit assembly back into the machine.

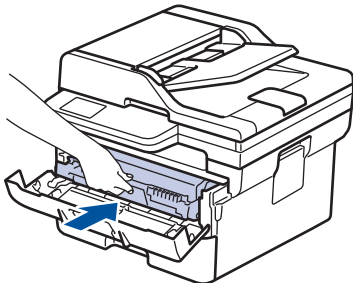

5. Close the front cover of the machine.



Related Information

- [Clean the Machine](#)

Related Topics:

- [Error and Maintenance Messages](#)

Clean the Drum Unit

If your printout has dots or other repeating marks at 94 mm intervals, the drum may have foreign material, such as glue from a label, stuck on the drum surface.

>> DCP-L2600D/DCP-L2620DW/DCP-L2622DW/DCP-L2627DW/DCP-L2627DWXL/DCP-L2627DWE/
DCP-L2640DN/MFC-L2802DN/MFC-L2800DW/MFC-L2802DW/MFC-L2827DWXL/MFC-L2827DW/
MFC-L2835DW
>> DCP-L2660DW/DCP-L2665DW/MFC-L2860DWE/MFC-L2860DW/MFC-L2862DW/MFC-L2922DW/
MFC-L2960DW/MFC-L2980DW

**DCP-L2600D/DCP-L2620DW/DCP-L2622DW/DCP-L2627DW/DCP-L2627DWXL/
DCP-L2627DWE/DCP-L2640DN/MFC-L2802DN/MFC-L2800DW/MFC-L2802DW/
MFC-L2827DWXL/MFC-L2827DW/MFC-L2835DW**

1. Make sure the machine is in Ready mode.
2. Press **Menu**.
3. Press ▲ or ▼ to display the [Print Reports] option, and then press **OK**.
4. Press ▲ or ▼ to select the [Drum Dot Print] option, and then press **OK**.
5. Press **Start**.
The machine prints the Drum Dot Check Sheet.
6. Press **Stop/Exit**.
7. Press and hold  to turn the machine off.
8. Open the front cover.

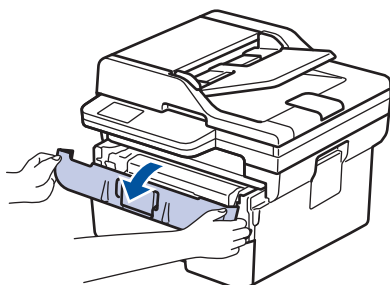

9. Remove the toner cartridge and drum unit assembly from the machine.

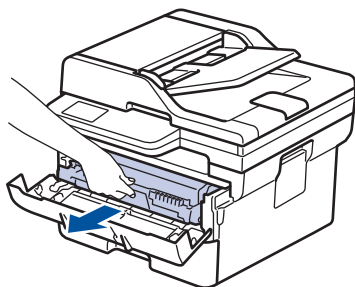

10. Push down the green lock lever and take the toner cartridge out of the drum unit.

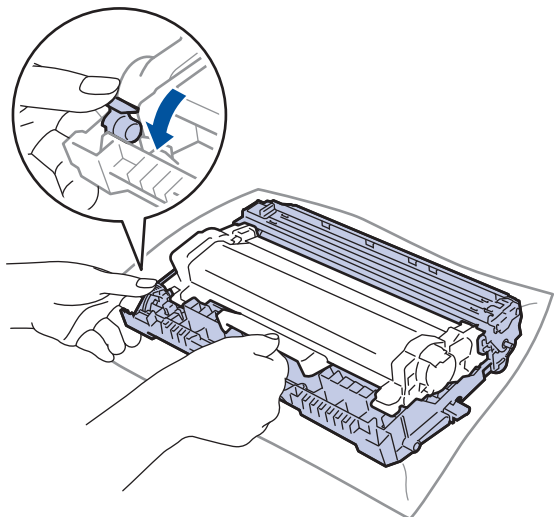

11. Turn the drum unit as shown in the illustration. Make sure that the drum unit gear (1) is on the left side.

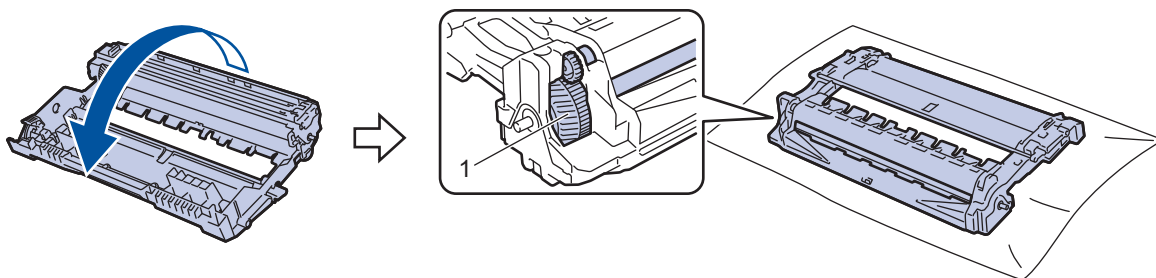

12. Use the numbered markers next to the drum roller to find the mark on the drum. For example, a dot in column 2 on the check sheet means that there is a mark in drum region "2".

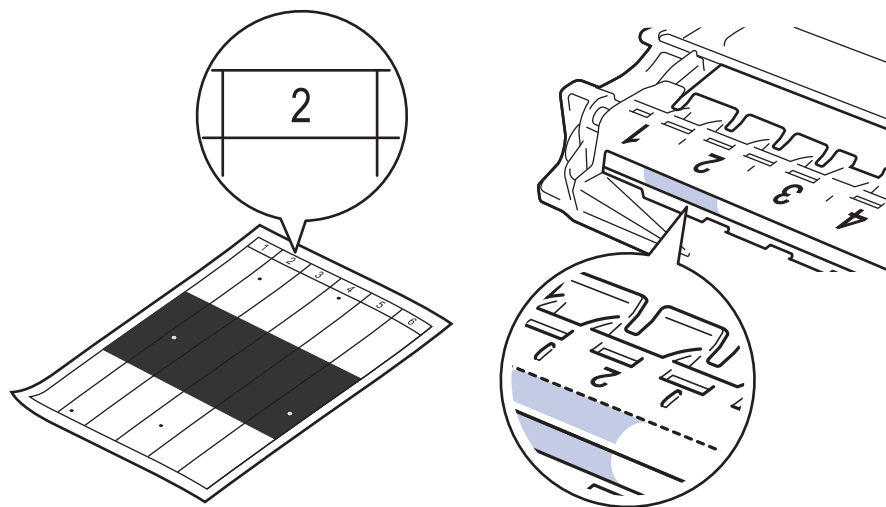

13. Turn the drum unit edge towards you while looking at the drum surface to find the mark.

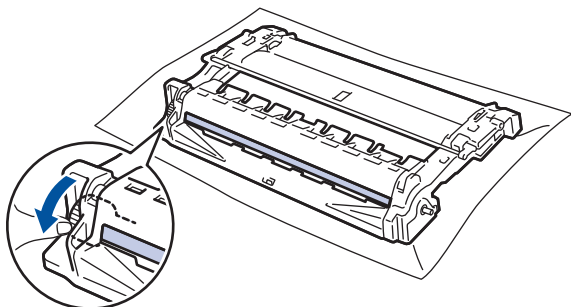

IMPORTANT

To avoid print quality problems, DO NOT touch the surface of the drum unit, only the wheel on the end.

14. Wipe the drum unit surface gently with a dry cotton swab until the mark or foreign material on the surface comes off.

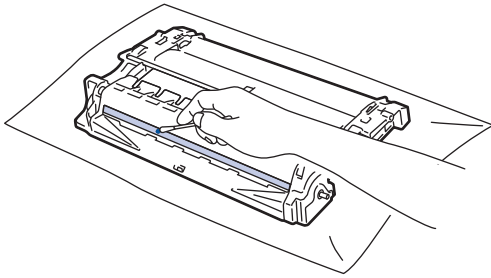

NOTE

DO NOT clean the surface of the photosensitive drum with a sharp object or any liquids.

15. Push the toner cartridge firmly into the drum unit it locks into place.

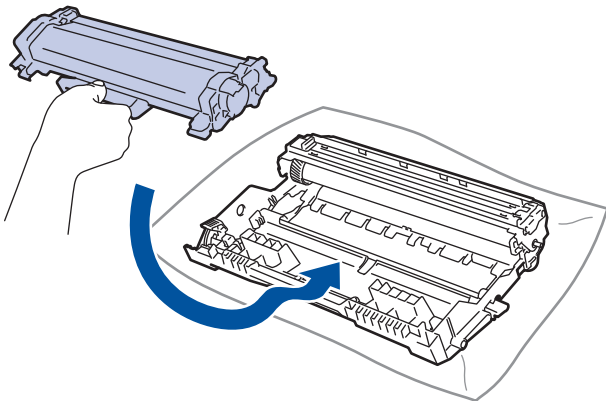

Make sure you put the toner cartridge in correctly or it may separate from the drum unit.

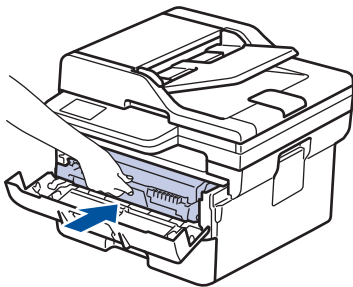

16. Reinsert the toner cartridge and drum unit assembly back into the machine.



17. Close the front cover of the machine.

18. Press  to turn the machine on.

**DCP-L2660DW/DCP-L2665DW/MFC-L2860DWE/MFC-L2860DW/MFC-L2862DW/
MFC-L2922DW/MFC-L2960DW/MFC-L2980DW**

1. Make sure the machine is in Ready mode.
2. Press  [Settings] > [All Settings] > [Print Reports] > [Drum Dot Print].
3. Press [Yes].
The machine prints the Drum Dot Check Sheet.
4. Press .
5. Press and hold  to turn the machine off.

6. Open the front cover.

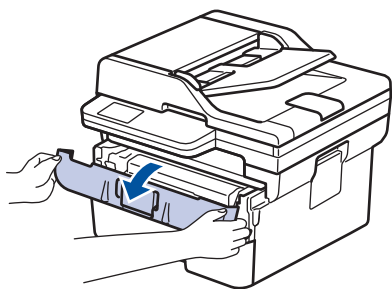

7. Remove the toner cartridge and drum unit assembly from the machine.

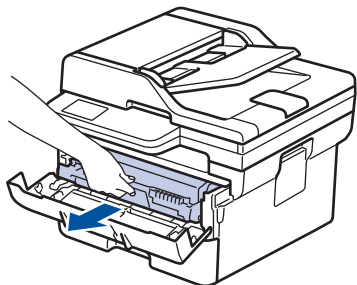

8. Push down the green lock lever and take the toner cartridge out of the drum unit.

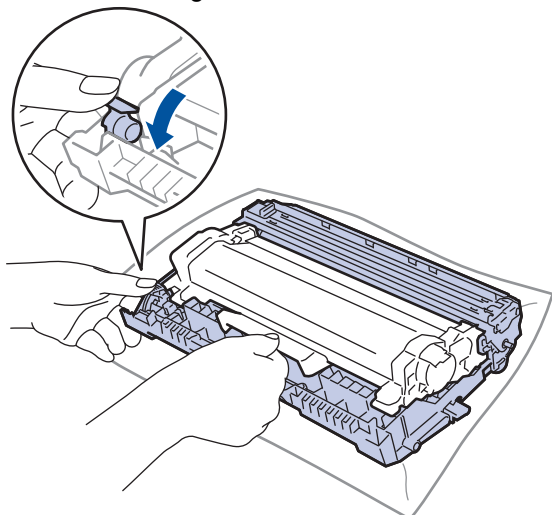

9. Turn the drum unit as shown in the illustration. Make sure that the drum unit gear (1) is on the left side.

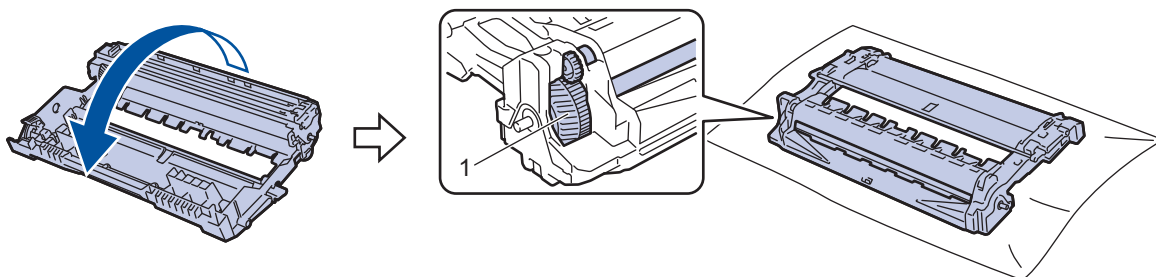

10. Use the numbered markers next to the drum roller to find the mark on the drum. For example, a dot in column 2 on the check sheet means that there is a mark in drum region “2”.

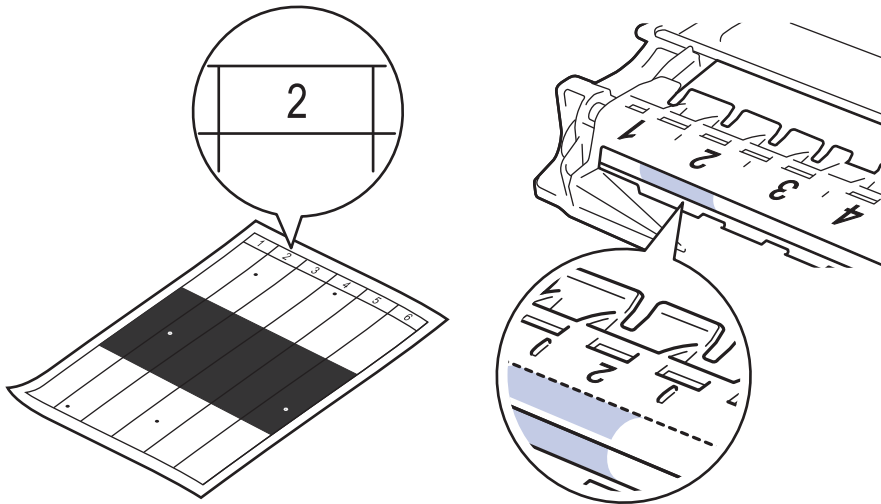

11. Turn the drum unit edge towards you while looking at the drum surface to find the mark.

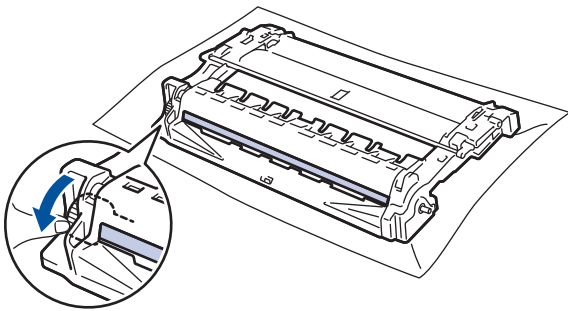

IMPORTANT

To avoid print quality problems, DO NOT touch the surface of the drum unit, only the wheel on the end.

12. Wipe the drum unit surface gently with a dry cotton swab until the mark or foreign material on the surface comes off.

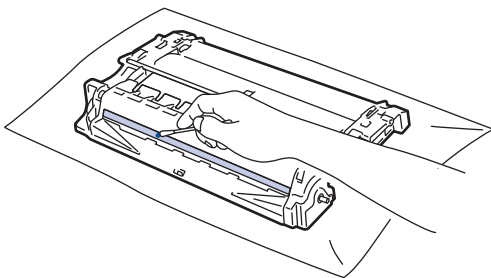

NOTE

DO NOT clean the surface of the photosensitive drum with a sharp object or any liquids.

13. Push the toner cartridge firmly into the drum unit it locks into place.

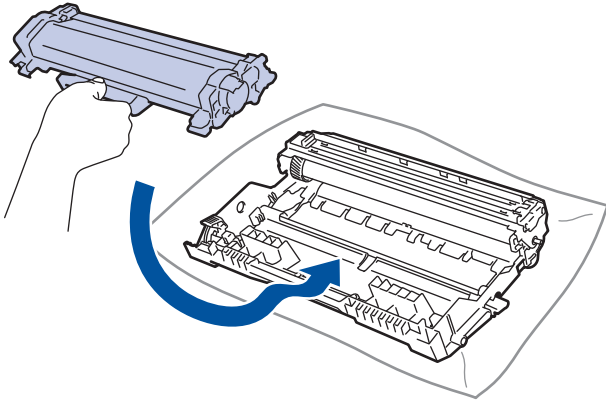

Make sure you put the toner cartridge in correctly or it may separate from the drum unit.

14. Reinsert the toner cartridge and drum unit assembly back into the machine.

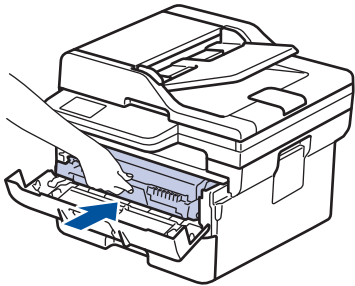

15. Close the front cover of the machine.

16. Press  to turn the machine on.



Related Information

- [Clean the Machine](#)

Related Topics:

- [Improve the Print Quality](#)
-

Clean the Paper Pick-up Rollers

Cleaning the paper pick-up rollers periodically may prevent paper jams by ensuring that paper feeds correctly.

Before starting the cleaning procedure, see *Related Information: Clean the Machine*.

If you have paper feed problems, clean the pick-up rollers as follows:

1. Press and hold  to turn the machine off.
2. Pull the paper tray completely out of the machine.

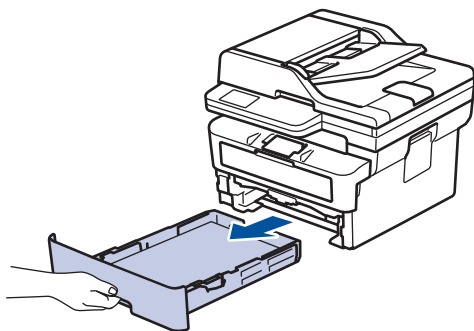

3. If paper is loaded or something is stuck inside in the paper tray, remove it.
4. Tightly wring out a lint-free cloth soaked in lukewarm water, and then wipe the separator pad on the paper tray to remove dust.

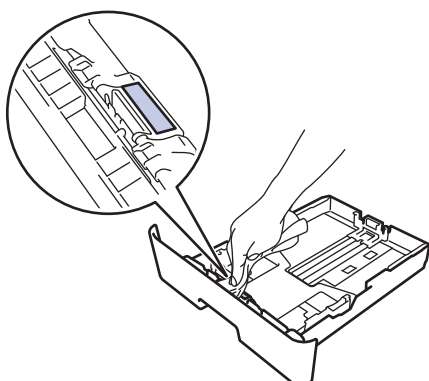

5. Wipe the two pick-up rollers inside the machine to remove dust.

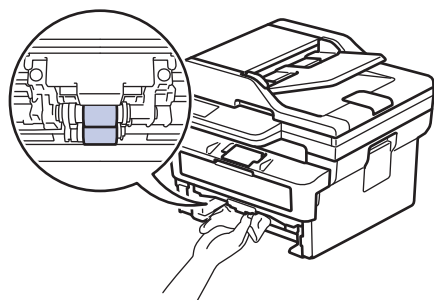

6. Reload the paper and put the paper tray firmly back in the machine.
7. Press  to turn the machine on.

✓ Related Information

- [Clean the Machine](#)

Related Topics:

- [Printing Problems](#)



Check the Remaining Part Life

>> DCP-L2600D/DCP-L2620DW/DCP-L2622DW/DCP-L2627DW/DCP-L2627DWXL/DCP-L2627DWE/
DCP-L2640DN/MFC-L2802DN/MFC-L2800DW/MFC-L2802DW/MFC-L2827DWXL/MFC-L2827DW/
MFC-L2835DW
>> DCP-L2660DW/DCP-L2665DW/MFC-L2860DWE/MFC-L2860DW/MFC-L2862DW/MFC-L2922DW/
MFC-L2960DW/MFC-L2980DW

**DCP-L2600D/DCP-L2620DW/DCP-L2622DW/DCP-L2627DW/DCP-L2627DWXL/
DCP-L2627DWE/DCP-L2640DN/MFC-L2802DN/MFC-L2800DW/MFC-L2802DW/
MFC-L2827DWXL/MFC-L2827DW/MFC-L2835DW**

1. Press **Menu**.
2. Press **▲** or **▼** to display the [Machine Info.] option, and then press **OK**.
3. Press **▲** or **▼** to display the [Parts Life] option, and then press **OK**.
4. Press **▲** or **▼** to select the [Toner] or [Drum] option, and then press **OK**.
The LCD displays the approximate remaining toner or drum life.
5. Press **Stop/Exit**.

**DCP-L2660DW/DCP-L2665DW/MFC-L2860DWE/MFC-L2860DW/MFC-L2862DW/
MFC-L2922DW/MFC-L2960DW/MFC-L2980DW**

1. Press  [Settings] > [All Settings] > [Machine Info.] > [Parts Life].
2. The LCD displays the approximate remaining drum life.
3. Press .



To display the approximate remaining life of toner cartridge, press  on the LCD, and then press [Toner Life].

Related Information

- [Routine Maintenance](#)

Pack and Ship Your Machine

WARNING

When you move the machine, carry the machine as shown in the illustration.

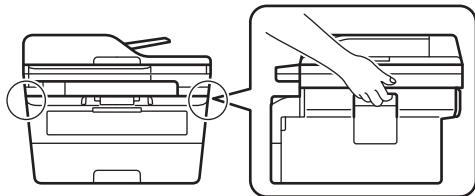

If for any reason you must ship your machine, carefully repack the machine in the original packaging to avoid any damage during transit. The machine should be adequately insured with the carrier.

1. Press and hold  to turn the machine off. Leave the machine off for at least 10 minutes to cool down.
2. Disconnect all the cables, and then unplug the power cord from the electrical socket.



Some models are equipped with a non-detachable AC power cord. If your cord is not detachable, fold it loosely and rest it on top of the machine so it packs easily.

3. Put the machine into the bag it originally came in.

4. Pack the machine, the printed materials, and the AC power cord (if applicable) in the original carton with the original packing material as shown. (The original packing material may differ depending on your country.) The illustrations may differ from the actual packing materials. The materials vary depending on your model.

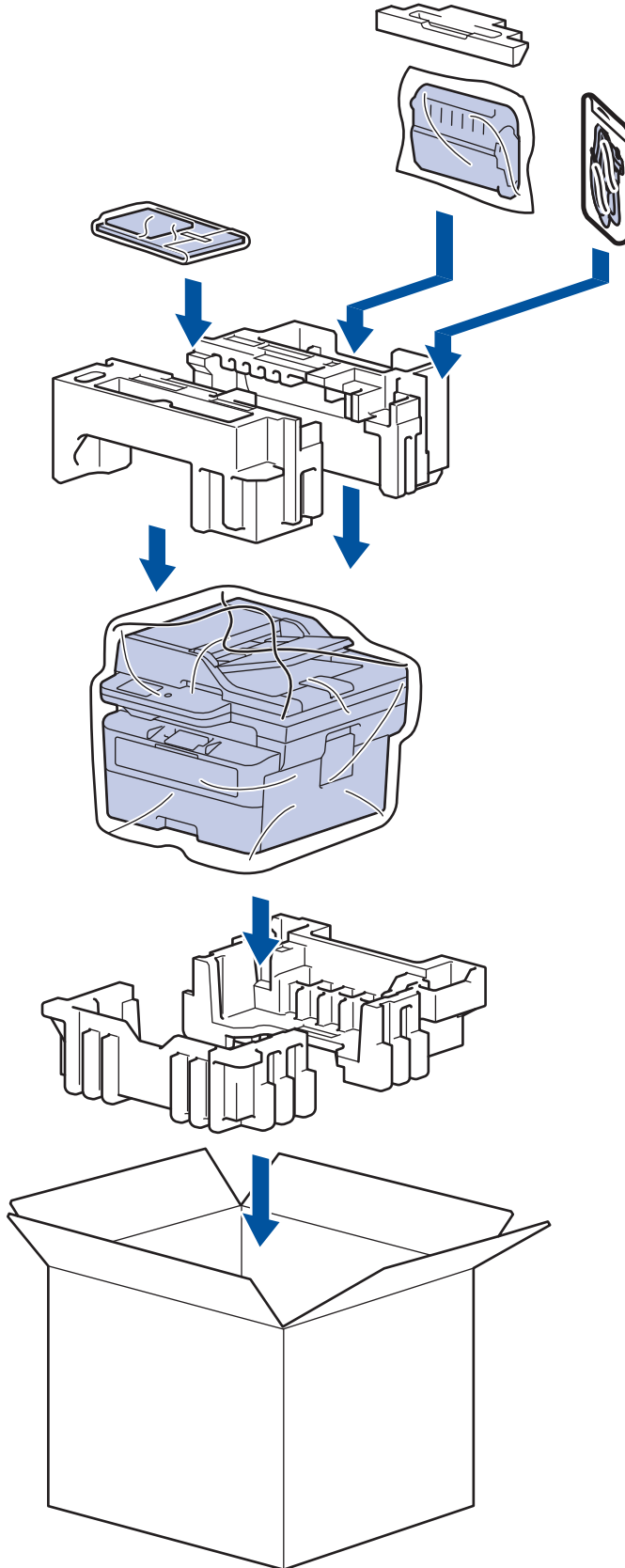

5. Close the carton and tape it shut.

✓ Related Information

- [Routine Maintenance](#)

Machine Settings

Customise settings and features to make your machine a more efficient work tool.

- [Check Your Machine's Password](#)
- [Change Machine Settings from the Control Panel](#)
- [Change Machine Settings Using Web Based Management](#)

Check Your Machine's Password

If prompted to enter a password, check the following information:

>> [Find the Default Password](#)

>> [Change the Password](#)

>> [Reset the Password](#)

Find the Default Password

The default password to manage this machine's settings is located on the back of the machine and marked "Pwd".

Change the Password

We recommend immediately changing the default password to protect your machine from unauthorised access.

Use Web Based Management to change the password.

For more information, see *Related Information*.

Reset the Password

If you forget your password, reset your machine to its factory default settings. The password will also be reset to the default password.

For more information, see *Related Information*.



Related Information

- [Machine Settings](#)

Related Topics:

- [Update Your Machine's Firmware](#)
- [Reset Your Machine](#)
- [Change the Login Password Using Web Based Management](#)

Change Machine Settings from the Control Panel

- [In the Event of Power Failure \(Memory Storage\)](#)
- [General Settings](#)
- [Save Your Favourite Settings as a Shortcut](#)
- [Print Reports](#)
- [Settings and Features Tables](#)

In the Event of Power Failure (Memory Storage)

Your menu settings are stored permanently, and in the event of a power failure will not be lost. Temporary settings (for example, Contrast, Overseas Mode) are lost.

- (MFC-L2860DWE/MFC-L2860DW/MFC-L2862DW/MFC-L2922DW/MFC-L2960DW/MFC-L2980DW)
During a power failure, the machine will retain the date and time and programmed fax timer jobs (for example, Delayed Fax) for approximately 60 hours. Other fax jobs in the machine's memory will not be lost.
- (MFC-L2802DN/MFC-L2800DW/MFC-L2802DW/MFC-L2827DWXL/MFC-L2827DW/MFC-L2835DW)
During a power failure, the machine will retain the date and time for approximately two hours. The fax jobs in the machine's memory will be lost.



Related Information

- [Change Machine Settings from the Control Panel](#)
-

General Settings

- [Change the Default Mode](#)
- [Set the Mode Timer](#)
- [Adjust the Machine's Volume](#)
- [Change for Daylight Saving Time Automatically](#)
- [Set Sleep Mode Countdown](#)
- [About Deep Sleep Mode](#)
- [Set Auto Power Off Mode](#)
- [Set the Date and Time](#)
- [Set the Time Zone](#)
- [Adjust the LCD Backlight Brightness](#)
- [Change How Long the LCD Backlight Stays On](#)
- [Set Your Station ID](#)
- [Set Tone or Pulse Dialling Mode](#)
- [Reduce Toner Consumption](#)
- [Set the Continue Mode](#)
- [Learn About Receiving Faxes in Continue Mode](#)
- [Prevent Dialling a Wrong Number \(Dial Restriction\)](#)
- [Reduce Printing Noise](#)
- [Change the Language on the LCD](#)

Change the Default Mode

Related Models: MFC-L2802DN/MFC-L2800DW/MFC-L2802DW/MFC-L2827DWXL/MFC-L2827DW/MFC-L2835DW

When the machine is idle or you press **Stop/Exit**, the machine will return to the mode you set.

- For MFC models, the machine has Fax, Scan and Copy modes. The default mode is Fax.
- For DCP models, the machine has Scan and Copy modes. The default mode is Copy.

1. Press **Menu**.
2. Press **▲** or **▼** to display the [General Setup] option, and then press **OK**.
3. Press **▲** or **▼** to display the [Default Mode] option, and then press **OK**.
4. Press **▲** or **▼** to display the [Fax], [Copy], or [Scan] option, and then press **OK**.
5. Press **Stop/Exit**.



Related Information

- [General Settings](#)

Set the Mode Timer

Related Models: MFC-L2802DN/MFC-L2800DW/MFC-L2802DW/MFC-L2827DWXL/MFC-L2827DW/MFC-L2835DW

The machine returns to the default mode after use of the machine in a mode other than the default mode. The Mode Timer setting defines how much time the machine takes after the last operation to return to the default mode. If you choose [Off], the machine will stay in the mode you used last.

- For MFC models, the machine has three mode buttons on the control panel: FAX, SCAN and COPY.
- For DCP models, the machine has Scan and Copy. Default is Copy mode and mode timer setting is one minute.

1. Press **Menu**.
2. Press ▲ or ▼ to display the [General Setup] option, and then press **OK**.
3. Press ▲ or ▼ to display the [Mode Timer] option, and then press **OK**.
4. Press ▲ or ▼ to display the [5 Mins], [2 Mins], [1 Min], [30 Secs], [0 Sec], or [Off] option, and then press **OK**.
5. Press **Stop/Exit**.



Related Information

- [General Settings](#)

Adjust the Machine's Volume

Related Models: DCP-L2660DW/DCP-L2665DW/MFC-L2802DN/MFC-L2800DW/MFC-L2802DW/MFC-L2827DWXL/MFC-L2827DW/MFC-L2835DW/MFC-L2860DWE/MFC-L2860DW/MFC-L2862DW/MFC-L2922DW/MFC-L2960DW/MFC-L2980DW

>> MFC-L2802DN/MFC-L2800DW/MFC-L2802DW/MFC-L2827DWXL/MFC-L2827DW/MFC-L2835DW
>> DCP-L2660DW/DCP-L2665DW/MFC-L2860DWE/MFC-L2860DW/MFC-L2862DW/MFC-L2922DW/MFC-L2960DW/MFC-L2980DW



MFC-L2802DN/MFC-L2800DW/MFC-L2802DW/MFC-L2827DWXL/MFC-L2827DW/MFC-L2835DW

1. Press **Menu**.
2. Press **▲** or **▼** to display the [General Setup] option, and then press **OK**.
3. Press **▲** or **▼** to display the [Volume] option, and then press **OK**.
4. Press **▲** or **▼** to select one of the following options:

| Option | Description |
|---------|------------------------------------------------------------------------------------------------|
| Ring | Adjust the ring volume. |
| Beep | Adjust the volume when you press a button, make a mistake, or after you send or receive a fax. |
| Speaker | Adjust the speaker volume. |

5. Press **OK**.
6. Press **▲** or **▼** to display the [High], [Med], [Low], or [Off] option, and then press **OK**.
7. Press **Stop/Exit**.

DCP-L2660DW/DCP-L2665DW/MFC-L2860DWE/MFC-L2860DW/MFC-L2862DW/MFC-L2922DW/MFC-L2960DW/MFC-L2980DW

1. Do one of the following:
 - For MFC models:
Press  [Settings] > [All Settings] > [General Setup] > [Volume].
 - For DCP models:
Press  [Settings] > [All Settings] > [General Setup] > [Beep].
2. Press one of the following options (MFC models):

| Option | Description |
|---------|------------------------------------------------------------------------------------------------|
| Ring | Adjust the ring volume. |
| Beep | Adjust the volume when you press a button, make a mistake, or after you send or receive a fax. |
| Speaker | Adjust the speaker volume. |

3. Press **▲** or **▼** to display the [Off], [Low], [Med], or [High] option, and then press the option you want.
4. Press .



Related Information

- [General Settings](#)

Change for Daylight Saving Time Automatically

You can program the machine to change automatically to Daylight Saving Time.

It will reset itself forward one hour in the spring, and back one hour in the autumn. Make sure you have set the correct date and time in the Date & Time setting.



This feature is available only in some countries.

>> [MFC-L2802DN/MFC-L2800DW/MFC-L2802DW/MFC-L2827DWXL/MFC-L2827DW/MFC-L2835DW](#)
>> [MFC-L2860DWE/MFC-L2860DW/MFC-L2862DW/MFC-L2922DW/MFC-L2960DW/MFC-L2980DW](#)

MFC-L2802DN/MFC-L2800DW/MFC-L2802DW/MFC-L2827DWXL/MFC-L2827DW/MFC-L2835DW

1. Press **Menu**.
2. Press **▲** or **▼** to display the [Initial Setup] option, and then press **OK**.
3. Press **▲** or **▼** to display the [Date & Time] option, and then press **OK**.
4. Press **▲** or **▼** to display the [Auto Daylight] option, and then press **OK**.
5. Press **▲** or **▼** to display the [On] or [Off] option, and then press **OK**.
6. Press **Stop/Exit**.

MFC-L2860DWE/MFC-L2860DW/MFC-L2862DW/MFC-L2922DW/MFC-L2960DW/MFC-L2980DW

1. Press  [Settings] > [All Settings] > [Initial Setup] > [Date & Time] > [Auto Daylight].
2. Press [On] or [Off].
3. Press .

Related Information

- [General Settings](#)

Set Sleep Mode Countdown

Related Models: DCP-L2600D/DCP-L2620DW/DCP-L2622DW/DCP-L2627DW/DCP-L2627DWXL/
DCP-L2627DWE/DCP-L2640DN/DCP-L2660DW/DCP-L2665DW/MFC-L2802DN/MFC-L2800DW/
MFC-L2802DW/MFC-L2827DWXL/MFC-L2827DW/MFC-L2835DW/MFC-L2860DWE/MFC-L2860DW/
MFC-L2862DW/MFC-L2922DW

The Sleep Mode (or Power Save Mode) setting can reduce power consumption. When the machine is in Sleep Mode, it acts as though it is turned off. The machine will wake up and start printing when it receives a print job or a fax. Use these instructions to set a time delay (countdown) before the machine enters Sleep Mode.

- You can choose how long the machine must be idle before it goes into Sleep Mode.
- The timer will restart if any operation is carried out on the machine, such as receiving a print job.



>> DCP-L2600D/DCP-L2620DW/DCP-L2622DW/DCP-L2627DW/DCP-L2627DWXL/DCP-L2627DWE/
DCP-L2640DN/MFC-L2802DN/MFC-L2800DW/MFC-L2802DW/MFC-L2827DWXL/MFC-L2827DW/
MFC-L2835DW

>> DCP-L2660DW/DCP-L2665DW/MFC-L2860DWE/MFC-L2860DW/MFC-L2862DW/MFC-L2922DW

**DCP-L2600D/DCP-L2620DW/DCP-L2622DW/DCP-L2627DW/DCP-L2627DWXL/
DCP-L2627DWE/DCP-L2640DN/MFC-L2802DN/MFC-L2800DW/MFC-L2802DW/
MFC-L2827DWXL/MFC-L2827DW/MFC-L2835DW**

1. Press **Menu**.
2. Press **▲** or **▼** to display the [General Setup] option, and then press **OK**.
3. Press **▲** or **▼** to display the [Ecology] option, and then press **OK**.
4. Press **▲** or **▼** to display the [Sleep Time] option, and then press **OK**.
5. Enter the length of time (maximum 50 minutes) the machine is idle before entering Sleep Mode, and then press **OK**.
6. Press **Stop/Exit**.

**DCP-L2660DW/DCP-L2665DW/MFC-L2860DWE/MFC-L2860DW/MFC-L2862DW/
MFC-L2922DW**

1. Press  [Settings] > [All Settings] > [General Setup] > [Ecology] > [Sleep Time].
2. Enter the length of time (maximum 50 minutes) the machine will remain idle before entering Sleep Mode, and then press [OK].
3. Press .

Related Information

- [General Settings](#)

About Deep Sleep Mode

If the machine is in Sleep Mode and does not receive any jobs for a certain length of time, the machine will automatically enter Deep Sleep Mode. The length of time is based on your specific model and settings.

Deep Sleep Mode uses less power than Sleep Mode.

| Applicable Models | Machine's LCD in Deep Sleep Mode | Conditions That Will Wake the Machine |
|-------------------------------------------------------------------------------------------------------------------------------------------------------------------------------------------------|-------------------------------------------------------|-------------------------------------------------------------------------------|
| DCP-L2600D/DCP-L2620DW/ DCP-L2622DW/DCP-L2627DW/ DCP-L2627DWXL/ DCP-L2627DWE/ DCP-L2640DN/MFC-L2802DN/ MFC-L2800DW/ MFC-L2802DW/ MFC-L2827DWXL/ MFC-L2827DW/MFC-L2835DW | The LCD displays <i>Deep Sleep</i> . | The machine receives a job. Someone presses a button on the control panel. |
| DCP-L2660DW/DCP-L2665DW/ MFC-L2860DWE/ MFC-L2860DW/ MFC-L2862DW/ MFC-L2922DW/ MFC-L2960DW/MFC-L2980DW | The LCD backlight turns off and the Power LED blinks. | The machine receives a job. Someone presses the touchscreen LCD. |



Related Information

- [General Settings](#)

Set Auto Power Off Mode

If the machine does not receive any jobs for a certain length of time, based on your model and settings, the machine will automatically enter Power Off mode. The machine will not go into Power Off mode if it is connected to a network, a USB cable, NFC, Wi-Fi Direct, or a telephone line, or if there is any secure print data stored in its memory. The available features and interfaces vary depending on the model.



To start printing, press  on the control panel and then send a print job.

>> DCP-L2600D/DCP-L2620DW/DCP-L2622DW/DCP-L2627DW/DCP-L2627DWXL/DCP-L2627DWE/
DCP-L2640DN/MFC-L2802DN/MFC-L2800DW/MFC-L2802DW/MFC-L2827DWXL/MFC-L2827DW/
MFC-L2835DW
>> DCP-L2660DW/DCP-L2665DW/MFC-L2860DWE/MFC-L2860DW/MFC-L2862DW/MFC-L2922DW/
MFC-L2960DW/MFC-L2980DW

**DCP-L2600D/DCP-L2620DW/DCP-L2622DW/DCP-L2627DW/DCP-L2627DWXL/
DCP-L2627DWE/DCP-L2640DN/MFC-L2802DN/MFC-L2800DW/MFC-L2802DW/
MFC-L2827DWXL/MFC-L2827DW/MFC-L2835DW**

1. Press **Menu**.
2. Press **▲** or **▼** to display the [General Setup] option, and then press **OK**.
3. Press **▲** or **▼** to display the [Ecology] option, and then press **OK**.
4. Press **▲** or **▼** to display the [Auto Power Off] option, and then press **OK**.
5. Press **▲** or **▼** to display the [8 hours], [4 hours], [2 hours], [1 hour], [20 Mins], or [Off] option, and then press **OK**.
6. Press **Stop/Exit**.

**DCP-L2660DW/DCP-L2665DW/MFC-L2860DWE/MFC-L2860DW/MFC-L2862DW/
MFC-L2922DW/MFC-L2960DW/MFC-L2980DW**

1. Press  [Settings] > [All Settings] > [General Setup] > [Ecology] > [Auto Power Off].
2. Press **▲** or **▼** to display the [Off], [20 Mins], [1 hour], [2 hours], [4 hours] or [8 hours] option, and then press the option you want.
3. Press .

Related Information

- [General Settings](#)

Set the Date and Time

Related Models: MFC-L2802DN/MFC-L2800DW/MFC-L2802DW/MFC-L2827DWXL/MFC-L2827DW/
MFC-L2835DW/MFC-L2860DWE/MFC-L2860DW/MFC-L2862DW/MFC-L2922DW/MFC-L2960DW/
MFC-L2980DW

>> MFC-L2802DN/MFC-L2800DW/MFC-L2802DW/MFC-L2827DWXL/MFC-L2827DW/MFC-L2835DW
>> MFC-L2860DWE/MFC-L2860DW/MFC-L2862DW/MFC-L2922DW/MFC-L2960DW/MFC-L2980DW

MFC-L2802DN/MFC-L2800DW/MFC-L2802DW/MFC-L2827DWXL/MFC-L2827DW/ MFC-L2835DW



1. Press **Menu**.
2. Press **▲** or **▼** to display the [Initial Setup] option, and then press **OK**.
3. Press **▲** or **▼** to display the [Date & Time] option, and then press **OK**.
4. Press **▲** or **▼** to display the [Date & Time] option, and then press **OK**.
5. Enter the last two digits of the year using the dial pad, and then press **OK**.
6. Enter the two digits for the month using the dial pad, and then press **OK**.
7. Enter the two digits for the day using the dial pad, and then press **OK**.
8. Press **▲** or **▼** to display the [12h Clock] or [24h Clock] option, and then press **OK**.
9. Do one of the following:
 - If you selected [12h Clock] as the format in the [Date & Time] setting, enter the time (in 12-hour format) using the dial pad.
Press **OK**.
Press **▲** or **▼** to display the [AM] or [PM] option, and then press **OK**.
 - If you selected [24h Clock] as the format in the [Date & Time] setting, enter the time (in 24-hour format) using the dial pad.
Press **OK**.
(For example: enter 19:45 for 7:45 PM.)
10. Press **Stop/Exit**.

MFC-L2860DWE/MFC-L2860DW/MFC-L2862DW/MFC-L2922DW/MFC-L2960DW/ MFC-L2980DW

1. Press  [Settings] > [All Settings] > [Initial Setup] > [Date & Time] > [Date].
2. Enter the last two digits of the year using the LCD, and then press [OK].
3. Enter the two digits for the month using the LCD, and then press [OK].
4. Enter the two digits for the day using the LCD, and then press [OK].
5. Press [Clock Type].
6. Press [12h Clock] or [24h Clock].
7. Press [Time].

8. To enter the time, do one of the following:

- If you selected [12h Clock] as the format in the [Clock Type] setting, enter the time (in 12-hour format) using the LCD.

Press   to select the [AM] or [PM].

Press [OK].

- If you selected [24h Clock] as the format in the [Clock Type] setting, enter the time (in 24-hour format) using the LCD.

Press [OK].

(For example: enter 19:45 for 7:45 PM.)

9. Press .



Related Information

- [General Settings](#)
-

Set the Time Zone



Set the time zone for your location on the machine.

>> MFC-L2802DN/MFC-L2800DW/MFC-L2802DW/MFC-L2827DWXL/MFC-L2827DW/MFC-L2835DW
>> MFC-L2860DWE/MFC-L2860DW/MFC-L2862DW/MFC-L2922DW/MFC-L2960DW/MFC-L2980DW

**MFC-L2802DN/MFC-L2800DW/MFC-L2802DW/MFC-L2827DWXL/MFC-L2827DW/
MFC-L2835DW**

1. Press **Menu**.
2. Press **▲** or **▼** to display the [Initial Setup] option, and then press **OK**.
3. Press **▲** or **▼** to display the [Date & Time] option, and then press **OK**.
4. Press **▲** or **▼** to display the [Time Zone] option, and then press **OK**.
5. Press **▲** or **▼** to choose the time zone. Press **OK**.
6. Press **Stop/Exit**.

**MFC-L2860DWE/MFC-L2860DW/MFC-L2862DW/MFC-L2922DW/MFC-L2960DW/
MFC-L2980DW**

1. Press  [Settings] > [All Settings] > [Initial Setup] > [Date & Time] > [Time Zone].
2. Enter your time zone.
3. Press [OK].
4. Press .



Related Information

- [General Settings](#)

Adjust the LCD Backlight Brightness

Related Models: DCP-L2660DW/DCP-L2665DW/MFC-L2860DWE/MFC-L2860DW/MFC-L2862DW/MFC-L2922DW/MFC-L2960DW/MFC-L2980DW

If you are having difficulty reading the LCD, changing the brightness setting may help.

1. Press  [Settings] > [All Settings] > [General Setup] > [LCD Settings] > [Backlight].
2. Press the [Light], [Med] or [Dark] option.
3. Press .



Related Information

- [General Settings](#)

Change How Long the LCD Backlight Stays On

Related Models: DCP-L2660DW/DCP-L2665DW/MFC-L2860DWE/MFC-L2860DW/MFC-L2862DW/MFC-L2922DW/MFC-L2960DW/MFC-L2980DW

Set how long the LCD backlight stays on.

1. Press  [Settings] > [All Settings] > [General Setup] > [LCD Settings] > [Dim Timer].
2. Press the [10 Secs], [20 Secs] or [30 Secs] option.
3. Press .

Related Information

- [General Settings](#)

Set Your Station ID

Related Models: MFC-L2802DN/MFC-L2800DW/MFC-L2802DW/MFC-L2827DWXL/MFC-L2827DW/MFC-L2835DW/MFC-L2860DWE/MFC-L2860DW/MFC-L2862DW/MFC-L2922DW/MFC-L2960DW/MFC-L2980DW

Set the machine to print your Station ID and the fax's date and time at the top of each fax you send.

>> [MFC-L2802DN/MFC-L2800DW/MFC-L2802DW/MFC-L2827DWXL/MFC-L2827DW/MFC-L2835DW](#)

>> [MFC-L2860DWE/MFC-L2860DW/MFC-L2862DW/MFC-L2922DW/MFC-L2960DW/MFC-L2980DW](#)

MFC-L2802DN/MFC-L2800DW/MFC-L2802DW/MFC-L2827DWXL/MFC-L2827DW/MFC-L2835DW

1. Press  (Fax).
2. Press **Menu**.
3. Press **▲** or **▼** to display the [Initial Setup] option, and then press **OK**.
4. Press **▲** or **▼** to display the [Station ID] option, and then press **OK**.
5. Enter your fax number (up to 20 digits) using the dial pad, and then press **OK**.
6. Enter your telephone number (up to 20 digits) using the dial pad, and then press **OK**.
If your telephone number and fax number are the same, enter the same number again.
7. Use the dial pad to enter your name (up to 20 characters), and then press **OK**.





To enter text on your machine, see *Related Information: How to Enter Text on Your Machine*.

8. Press **Stop/Exit**.

MFC-L2860DWE/MFC-L2860DW/MFC-L2862DW/MFC-L2922DW/MFC-L2960DW/MFC-L2980DW

1. Press  [Settings] > [All Settings] > [Initial Setup] > [Station ID] > [Fax].
2. Enter your fax number (up to 20 digits) using the LCD, and then press [OK].
3. Press [Tel].
4. Enter your telephone number (up to 20 digits) using the LCD, and then press [OK].
5. Press [Name].
6. Enter your name (up to 20 characters) using the LCD, and then press [OK].



- Press  to cycle between letters, numbers and special characters. (The characters available may differ depending on your country.)
- If you enter an incorrect character, press **◀** or **▶** to move the cursor to it and press . Press the correct character.
- To enter a space, press [Space].
- For more detailed information, see *Related Information*.

7. Press .

✓ Related Information

- [General Settings](#)

Related Topics:

- [How to Enter Text on Your Machine](#)
 - [Transfer Faxes to Another Fax Machine](#)
 - [Transfer the Fax Journal Report to Another Fax Machine](#)
-

Set Tone or Pulse Dialling Mode

Related Models: MFC-L2802DN/MFC-L2800DW/MFC-L2802DW/MFC-L2827DWXL/MFC-L2827DW/MFC-L2835DW/MFC-L2860DWE/MFC-L2860DW/MFC-L2862DW/MFC-L2922DW/MFC-L2960DW/MFC-L2980DW

Your machine is set for a Tone dialling service. If you have a Pulse dialling (rotary) service, you must change the dialling mode.



This feature is not available in some countries.

>> [MFC-L2802DN/MFC-L2800DW/MFC-L2802DW/MFC-L2827DWXL/MFC-L2827DW/MFC-L2835DW](#)
>> [MFC-L2860DWE/MFC-L2860DW/MFC-L2862DW/MFC-L2922DW/MFC-L2960DW/MFC-L2980DW](#)

MFC-L2802DN/MFC-L2800DW/MFC-L2802DW/MFC-L2827DWXL/MFC-L2827DW/MFC-L2835DW

1. Press **Menu**.
2. Press **▲** or **▼** to display the [Initial Setup] option, and then press **OK**.
3. Press **▲** or **▼** to display the [Tone/Pulse] option, and then press **OK**.
4. Press **▲** or **▼** to display the [Tone] or [Pulse] option, and then press **OK**.
5. Press **Stop/Exit**.

MFC-L2860DWE/MFC-L2860DW/MFC-L2862DW/MFC-L2922DW/MFC-L2960DW/MFC-L2980DW

1. Press  [Settings] > [All Settings] > [Initial Setup] > [Tone/Pulse].
2. Press [Tone] or [Pulse].
3. Press .

Related Information

- [General Settings](#)

Reduce Toner Consumption

Using the Toner Save feature may reduce toner consumption. When Toner Save is set to on, the print on your documents appears lighter.



We DO NOT recommend using the Toner Save feature for printing photo or greyscale images.

>> DCP-L2600D/DCP-L2620DW/DCP-L2622DW/DCP-L2627DW/DCP-L2627DWXL/DCP-L2627DWE/
DCP-L2640DN/MFC-L2802DN/MFC-L2800DW/MFC-L2802DW/MFC-L2827DWXL/MFC-L2827DW/
MFC-L2835DW
>> DCP-L2660DW/DCP-L2665DW/MFC-L2860DWE/MFC-L2860DW/MFC-L2862DW/MFC-L2922DW/
MFC-L2960DW/MFC-L2980DW

**DCP-L2600D/DCP-L2620DW/DCP-L2622DW/DCP-L2627DW/DCP-L2627DWXL/
DCP-L2627DWE/DCP-L2640DN/MFC-L2802DN/MFC-L2800DW/MFC-L2802DW/
MFC-L2827DWXL/MFC-L2827DW/MFC-L2835DW**

1. Press **Menu**.
2. Press **▲** or **▼** to display the [General Setup] option, and then press **OK**.
3. Press **▲** or **▼** to display the [Ecology] option, and then press **OK**.
4. Press **▲** or **▼** to display the [Toner Save] option, and then press **OK**.
5. Press **▲** or **▼** to display the [On] or [Off] option, and then press **OK**.
6. Press **Stop/Exit**.

**DCP-L2660DW/DCP-L2665DW/MFC-L2860DWE/MFC-L2860DW/MFC-L2862DW/
MFC-L2922DW/MFC-L2960DW/MFC-L2980DW**

1. Press  [Settings] > [All Settings] > [General Setup] > [Ecology] > [Toner Save].
2. Press [On] or [Off].
3. Press .

Related Information

- [General Settings](#)

Related Topics:

- [Improve the Print Quality](#)

Set the Continue Mode

The Continue Mode forces the machine to continue printing after the control panel displays "Replace Toner".

The machine will continue printing until the LCD displays "Toner Ended".

The factory setting is "Stop".



- When the control panel indicates an error, you cannot change the mode.
- If you continue printing in the Continue Mode, we cannot guarantee the print quality.
- While using Continue Mode the print may appear faint.
- After replacing the toner cartridge with a new one, the Continue Mode will go back to the factory setting ("Stop").



>> DCP-L2600D/DCP-L2620DW/DCP-L2622DW/DCP-L2627DW/DCP-L2627DWXL/DCP-L2627DWE/
DCP-L2640DN/MFC-L2802DN/MFC-L2800DW/MFC-L2802DW/MFC-L2827DWXL/MFC-L2827DW/
MFC-L2835DW

>> DCP-L2660DW/DCP-L2665DW/MFC-L2860DWE/MFC-L2860DW/MFC-L2862DW/MFC-L2922DW/
MFC-L2960DW/MFC-L2980DW

**DCP-L2600D/DCP-L2620DW/DCP-L2622DW/DCP-L2627DW/DCP-L2627DWXL/
DCP-L2627DWE/DCP-L2640DN/MFC-L2802DN/MFC-L2800DW/MFC-L2802DW/
MFC-L2827DWXL/MFC-L2827DW/MFC-L2835DW**

1. Press **Menu**.
2. Press **▲** or **▼** to display the [General Setup] option, and then press **OK**.
3. Press **▲** or **▼** to display the [Replace Toner] option, and then press **OK**.
4. Press **▲** or **▼** to display the [Continue] or [Stop] option, and then press **OK**.
5. Press **Stop/Exit**.

**DCP-L2660DW/DCP-L2665DW/MFC-L2860DWE/MFC-L2860DW/MFC-L2862DW/
MFC-L2922DW/MFC-L2960DW/MFC-L2980DW**

1. Press  [Settings] > [All Settings] > [General Setup] > [Replace Toner].
2. Press [Continue] or [Stop].
3. Press .

Related Information

- [General Settings](#)

Learn About Receiving Faxes in Continue Mode

Related Models: MFC-L2802DN/MFC-L2800DW/MFC-L2802DW/MFC-L2827DWXL/MFC-L2827DW/MFC-L2835DW/MFC-L2860DWE/MFC-L2860DW/MFC-L2862DW/MFC-L2922DW/MFC-L2960DW/MFC-L2980DW

The machine can store received faxes in the memory if you choose the Continue Mode when the LCD displays Replace Toner.

When received faxes are printed in Continue Mode the LCD will ask if the print quality of the fax is OK.

If the quality is not good, choose No. The machine will keep the faxes stored in the memory so you can reprint them after you replace the toner cartridge with a new one. If the print quality is good, choose Yes. The LCD will ask if you want to delete the printed faxes from the memory.

If you choose not to delete them, you will be asked again after you replace the toner cartridge with a new one.



- (MFC-L2802DN/MFC-L2800DW/MFC-L2802DW/MFC-L2827DWXL/MFC-L2827DW/MFC-L2835DW)
The machine can store up to 400 faxes in memory.
- (MFC-L2860DWE/MFC-L2860DW/MFC-L2862DW/MFC-L2922DW/MFC-L2960DW/MFC-L2980DW)
The machine can store up to 500 faxes in memory.
- (MFC-L2802DN/MFC-L2800DW/MFC-L2802DW/MFC-L2827DWXL/MFC-L2827DW/MFC-L2835DW)
If you turn off the power switch faxes in memory will be lost.
- The machine will keep faxes stored in Continue Mode even if you change the Continue setting to Stop.
- If you install a new toner cartridge when the LCD displays Toner Ended, the machine will ask if you want to print the stored faxes. Choose Print to print stored faxes.

Toner End in Continue Mode

When the LCD displays Toner Ended, the machine will stop printing. If the memory is full and you want to continue receiving faxes, you must install a new toner cartridge.



Related Information

- [General Settings](#)

Prevent Dialling a Wrong Number (Dial Restriction)

Related Models: MFC-L2802DN/MFC-L2800DW/MFC-L2802DW/MFC-L2827DWXL/MFC-L2827DW/MFC-L2835DW/MFC-L2860DWE/MFC-L2860DW/MFC-L2862DW/MFC-L2922DW/MFC-L2960DW/MFC-L2980DW

This feature prevents users from sending a fax or call to the wrong number by mistake. You can set the machine to restrict dialling when you use the dial pad, Address Book and Shortcuts.

>> [MFC-L2802DN/MFC-L2800DW/MFC-L2802DW/MFC-L2827DWXL/MFC-L2827DW/MFC-L2835DW](#)
>> [MFC-L2860DWE/MFC-L2860DW/MFC-L2862DW/MFC-L2922DW/MFC-L2960DW/MFC-L2980DW](#)

MFC-L2802DN/MFC-L2800DW/MFC-L2802DW/MFC-L2827DWXL/MFC-L2827DW/MFC-L2835DW

1. Press **Menu**.
2. Press **▲** or **▼** to display the [Fax] option, and then press **OK**.
3. Press **▲** or **▼** to display the [Dial Restrict.] option, and then press **OK**.
4. Press **▲** or **▼** to display your preferred option, and then press **OK**.
 - [Dial Pad]
 - [Shortcut]
 - [Speed Dial]
5. Press **▲** or **▼** to select one of the following options, and then press **OK**.

| Option | Description |
|---------------|-------------------------------------------------------------------------------------------------------------------------------------------------------------------------------------------------------------------|
| Enter # Twice | The machine will prompt you to re-enter the number, and then if you re-enter the same number correctly, the machine will start dialling. If you re-enter the wrong number, the LCD will display an error message. |
| On | The machine will restrict all fax sending and outbound calls for that dialling method. |
| Off | The machine does not restrict the dialling method. |

- The [Enter # Twice] setting will not work if you use an external phone before entering the number. You will not be asked to re-enter the number.
- If you choose [On] or [Enter # Twice], you cannot use the Broadcasting feature.

6. Press **Stop/Exit**.

MFC-L2860DWE/MFC-L2860DW/MFC-L2862DW/MFC-L2922DW/MFC-L2960DW/MFC-L2980DW

1. Press  [Settings] > [All Settings] > [Fax] > [Dial Restriction].
2. Press one of the following options:
 - [Dial Pad]
 - [Address Book]



If you combine Address Book numbers when dialling, the address will be recognised as dial pad input and will not be restricted.

- [Shortcuts]
3. Press one of the following options:

| Option | Description |
|------------------|-------------------------------------------------------------------------------------------------------------------------------------------------------------------------------------------------------------------|
| Enter # Twice | The machine will prompt you to re-enter the number, and then if you re-enter the same number correctly, the machine will start dialling. If you re-enter the wrong number, the LCD will display an error message. |
| On | The machine will restrict all fax sending and outbound calls for that dialling method. |
| Off | The machine does not restrict the dialling method. |



- The [Enter # Twice] setting will not work if you use an external phone before entering the number. You will not be asked to re-enter the number.
- If you choose [On] or [Enter # Twice], you cannot use the Broadcasting feature.

4. Press .



Related Information

- [General Settings](#)
-

Reduce Printing Noise



The Quiet Mode setting can reduce printing noise. When Quiet Mode is turned on, the print speed becomes slower. The factory setting is off.

>> DCP-L2600D/DCP-L2620DW/DCP-L2622DW/DCP-L2627DW/DCP-L2627DWXL/DCP-L2627DWE/
DCP-L2640DN/MFC-L2802DN/MFC-L2800DW/MFC-L2802DW/MFC-L2827DWXL/MFC-L2827DW/
MFC-L2835DW
>> DCP-L2660DW/DCP-L2665DW/MFC-L2860DWE/MFC-L2860DW/MFC-L2862DW/MFC-L2922DW/
MFC-L2960DW/MFC-L2980DW

**DCP-L2600D/DCP-L2620DW/DCP-L2622DW/DCP-L2627DW/DCP-L2627DWXL/
DCP-L2627DWE/DCP-L2640DN/MFC-L2802DN/MFC-L2800DW/MFC-L2802DW/
MFC-L2827DWXL/MFC-L2827DW/MFC-L2835DW**

1. Press **Menu**.
2. Press **▲** or **▼** to display the [General Setup] option, and then press **OK**.
3. Press **▲** or **▼** to display the [Ecology] option, and then press **OK**.
4. Press **▲** or **▼** to display the [Quiet Mode] option, and then press **OK**.
5. Press **▲** or **▼** to display the [On] or [Off] option, and then press **OK**.
6. Press **Stop/Exit**.

**DCP-L2660DW/DCP-L2665DW/MFC-L2860DWE/MFC-L2860DW/MFC-L2862DW/
MFC-L2922DW/MFC-L2960DW/MFC-L2980DW**

1. Press  [Settings] > [All Settings] > [General Setup] > [Ecology] > [Quiet Mode].
2. Press [On] or [Off].
3. Press .

Related Information

- [General Settings](#)

Change the Language on the LCD

Change the LCD language if needed.

This feature is not available in some countries.



>> DCP-L2600D/DCP-L2620DW/DCP-L2622DW/DCP-L2627DW/DCP-L2627DWXL/DCP-L2627DWE/
DCP-L2640DN/MFC-L2802DN/MFC-L2800DW/MFC-L2802DW/MFC-L2827DWXL/MFC-L2827DW/
MFC-L2835DW

>> DCP-L2660DW/DCP-L2665DW/MFC-L2860DWE/MFC-L2860DW/MFC-L2862DW/MFC-L2922DW/
MFC-L2960DW/MFC-L2980DW

**DCP-L2600D/DCP-L2620DW/DCP-L2622DW/DCP-L2627DW/DCP-L2627DWXL/
DCP-L2627DWE/DCP-L2640DN/MFC-L2802DN/MFC-L2800DW/MFC-L2802DW/
MFC-L2827DWXL/MFC-L2827DW/MFC-L2835DW**

1. Press **Menu**.
2. Press **▲** or **▼** to display the [Initial Setup] option, and then press **OK**.
3. Press **▲** or **▼** to display the [Local Language] option, and then press **OK**.
4. Press **▲** or **▼** to display your language, and then press **OK**.
5. Press **Stop/Exit**.

**DCP-L2660DW/DCP-L2665DW/MFC-L2860DWE/MFC-L2860DW/MFC-L2862DW/
MFC-L2922DW/MFC-L2960DW/MFC-L2980DW**

1. Press  [Settings] > [All Settings] > [Initial Setup] > [Local Language].
2. Press your language.
3. Press .

Related Information

- [General Settings](#)

Save Your Favourite Settings as a Shortcut

Related Models: DCP-L2660DW/DCP-L2665DW/MFC-L2860DWE/MFC-L2860DW/MFC-L2862DW/MFC-L2922DW/MFC-L2960DW/MFC-L2980DW

- [Add Shortcuts](#)
- [Change or Delete Shortcuts](#)

Add Shortcuts



Related Models: DCP-L2660DW/DCP-L2665DW/MFC-L2860DWE/MFC-L2860DW/MFC-L2862DW/MFC-L2922DW/MFC-L2960DW/MFC-L2980DW

You can add the Fax, Copy, Scan, Web Connect and Apps settings you use most frequently by saving them as your Shortcuts. Later you can press the Shortcut to apply these settings instead of manually re-entering them.



Some Shortcut menus are not available depending on your model.

These instructions describe how to add a Copy Shortcut. The steps for adding a Fax, Scan, Web Connect, or Apps Shortcut are very similar.

1. Press  Shortcuts ([Shortcuts]).
2. Press the button where you have not added a Shortcut.
3. Press ▲ or ▼ to display [Copy], and then press [Copy].
4. Press the copy preset you want.
5. Press  ([Options]).
6. Press ▲ or ▼ to display the available settings, and then press the setting you want to change.
7. Press ▲ or ▼ to display the available options for the setting, and then press the option you want.
Repeat these two steps until you have selected all the settings and options you want, and then press [OK].
8. When you have finished changing settings, press [OK].
9. Read and confirm the displayed list of settings you have selected, and then press [OK].
10. Enter a name for the Shortcut using the LCD, and then press [OK].



Related Information

- [Save Your Favourite Settings as a Shortcut](#)

Change or Delete Shortcuts

Related Models: DCP-L2660DW/DCP-L2665DW/MFC-L2860DWE/MFC-L2860DW/MFC-L2862DW/MFC-L2922DW/MFC-L2960DW/MFC-L2980DW



You cannot change a Web Connect Shortcut or Apps Shortcut. If you need to change them, delete them, and then add a new Shortcut.

1. Press  Shortcuts ([Shortcuts]).
2. Press a tab from [1] to [3] to display the Shortcut you want to change.
3. Press the Shortcut you want to change.

The settings for the Shortcut you selected appear.



To delete the Shortcut or edit the name, press and hold the Shortcut until the options appear, and then follow the on-screen menus.

4. Press  ([Options]).
5. Change the settings for the Shortcut if needed.
6. Press [OK].
7. When finished, press [Save as Shortcut].
8. Read and confirm the displayed list of settings you have selected, and then press [OK].
9. Do one of the following:
 - To overwrite the Shortcut, press [Yes].
 - If you do not want to overwrite the Shortcut, press [No] to enter a new Shortcut name.

Press any  to add a new Shortcut.

Enter a new name using the LCD, and then press [OK].



To edit the name, hold down  to delete the current name.



Related Information

- [Save Your Favourite Settings as a Shortcut](#)

Print Reports

- [Reports](#)
- [Print a Report](#)

Reports

The following reports are available:

XMIT Verify (For models with facsimile function)

The XMIT Verify report prints a Transmission Verification Report of your last transmission.

Address Book (For models with facsimile function)

The Address Book report prints a list of names and numbers stored in the Address Book memory.

Fax Journal (For models with facsimile function)

The Fax Journal prints a list of information about your last 200 incoming and outgoing faxes. (TX means Transmit, RX means Receive.)

User Settings

The User Settings report prints a list of your current settings.

Printer Settings

The Printer Settings report prints a list of your current printer settings.

Network Configuration (Models with network functionality)

The Network Configuration report prints a list of your current network settings.

Print File List

The Print File List prints a list of the fonts and print macro/stream setting stored in the machine.

Drum Dot Print

The Drum Dot Print prints the drum dot sheet, which helps when it is time to clean the drum unit.

WLAN Report (Models with wireless network functionality)

The WLAN Report prints the wireless LAN connectivity diagnosis.

Caller ID History (For models with facsimile function)

The Caller ID History report prints a list of the available Caller ID information for the last 30 received faxes and telephone calls.



Related Information

- [Print Reports](#)



Print a Report

>> DCP-L2600D/DCP-L2620DW/DCP-L2622DW/DCP-L2627DW/DCP-L2627DWXL/DCP-L2627DWE/
DCP-L2640DN/MFC-L2802DN/MFC-L2800DW/MFC-L2802DW/MFC-L2827DWXL/MFC-L2827DW/
MFC-L2835DW
>> DCP-L2660DW/DCP-L2665DW/MFC-L2860DWE/MFC-L2860DW/MFC-L2862DW/MFC-L2922DW/
MFC-L2960DW/MFC-L2980DW

**DCP-L2600D/DCP-L2620DW/DCP-L2622DW/DCP-L2627DW/DCP-L2627DWXL/
DCP-L2627DWE/DCP-L2640DN/MFC-L2802DN/MFC-L2800DW/MFC-L2802DW/
MFC-L2827DWXL/MFC-L2827DW/MFC-L2835DW**

1. Press **Menu**.
2. Press **▲** or **▼** to display the [Print Reports] option, and then press **OK**.
3. Press **▲** or **▼** to display the report you want to print, and then press **OK**.
4. Do one of the following:
 - If you choose [XMIT Verify], do one of the following:
 - To view the Transmission Verification Report, press **▲** or **▼** to display the [View on LCD], and then press **OK**.
 - To print the Transmission Verification Report, press **▲** or **▼** to display the [Print Report], and then press **OK**.
Press **Start**.
 - If you choose other reports, press **Start**.
5. Press **Stop/Exit**.

**DCP-L2660DW/DCP-L2665DW/MFC-L2860DWE/MFC-L2860DW/MFC-L2862DW/
MFC-L2922DW/MFC-L2960DW/MFC-L2980DW**

1. Press  [Settings] > [All Settings] > [Print Reports].
2. Press **▲** or **▼** to display the report you want to print, and then press it.
3. Do one of the following:
 - If you choose [XMIT Verify], do one of the following:
 - To view the Transmission Verification Report, press [View on LCD].
 - To print the Transmission Verification Report, press [Print Report].
 - If you choose other reports, go to next step.
4. Press [Yes].
5. Press .

Related Information

- [Print Reports](#)

Settings and Features Tables

The Settings tables will help you understand the menu selections and options that are found in the machine's programs.

- [Settings Tables \(2 Line LCD MFC models\)](#)
- [Settings Tables \(2 Line LCD DCP models\)](#)
- [Settings Tables \(2.7" Touch Panel MFC models and 3.5" Touch Panel MFC models\)](#)
- [Settings Tables \(2.7" Touch Panel DCP models\)](#)
- [Features Tables \(2.7" Touch Panel MFC models and 3.5" Touch Panel MFC models\)](#)
- [Features Tables \(2.7" Touch Panel DCP models\)](#)

Settings Tables (2 Line LCD MFC models)

Related Models: MFC-L2802DN/MFC-L2800DW/MFC-L2802DW/MFC-L2827DWXL/MFC-L2827DW/MFC-L2835DW

>> [General Setup]
 >> [Fax]
 >> [Copy]
 >> [Printer]
 >> [Network] (For Models with Network Functionality)
 >> [Print Reports]
 >> [Machine Info.]
 >> [Initial Setup]

[General Setup]

[General Setup]

| Level 3 | Level 4 | Level 5 | Descriptions |
|--------------|----------------|----------|--------------------------------------------------------------------------------------------------------------------------------------------------------------------------------------------------------------------------------------------------------------------------------------------|
| Default Mode | - | - | Select the default mode. |
| Mode Timer | - | - | Set the idle time before the machine returns to the default mode. |
| Tray Setting | Paper Type | - | Set the type of paper in the paper tray. |
| | Paper Size | - | Set the paper size in the paper tray. |
| | Print Position | X Offset | Move the print start position (at the upper left corner of pages) horizontally from -500 (left) to +500 (right) dots in 300 dpi. |
| | | Y Offset | Move the print start position (at the upper left corner of pages) vertically from -500 (up) to +500 (down) dots in 300 dpi. |
| | Check Paper | - | Select whether to display a message telling you to check that the size and type of the paper in the machine and the machine's Paper Size and Paper Type settings match. |
| Volume | Ring | - | Adjust the ring volume. |
| | Beep | - | Adjust the beeper volume. |
| | Speaker | - | Adjust the speaker volume. |
| Ecology | Eco Mode | - | Turn the following machine settings on at the same time: <ul style="list-style-type: none"> • 2-sided Print: Long Edge ¹(available for certain models) • Sleep Time: 0Min • Quiet Mode: On ¹ • Toner Save: On ¹ |
| | Toner Save | - | Increase the page yield of the toner cartridge. |
| | Sleep Time | - | Set the number of minutes before the machine enters Sleep mode. |
| | Quiet Mode | - | Decrease printing noise. |
| | Auto Power Off | - | Set the number of hours that the machine will remain in Deep Sleep mode before going into Power Off mode. |
| LCD Contrast | - | - | Adjust the LCD contrast. |
| Security | TX Lock | - | Prohibit most operations except receiving faxes. |
| | Setting Lock | - | Restrict unauthorised users from changing the machine's settings. |

| Level 3 | Level 4 | Level 5 | Descriptions |
|---------------|---------|---------|----------------------------------------------------------------------------|
| Replace Toner | - | - | Set the machine to continue printing after the LCD displays Replace Toner. |

¹ Changing this setting is possible only after you change certain machine settings in Web Based Management.

[Fax]

[Fax]

| Level 3 | Level 4 | Level 5 | Descriptions |
|----------------------------------------------------|----------------|----------------------------------------------------------------------------------------|--------------------------------------------------------------------------------------------------------------------------------------------------------------------------------------------------------------------------------|
| Setup Receive | Receive Mode | - | Select the receive mode that best suits your needs. |
| | Ring Delay | - | Set the number of rings before the machine answers in Fax or Fax/Tel mode. |
| | F/T Ring Time | - | Set the length of the pseudo/double-ring time in Fax/Tel mode. |
| | Fax Detect | - | Receive fax messages automatically when you answer a call and hear fax tones. |
| | Remote Codes | - | Answer calls at an extension or external telephone and use codes to turn the Remote Codes on or off. You can personalise the codes. |
| | Auto Reduction | - | Reduce the size of incoming faxes. |
| | Fax Rx Stamp | - | Print the received time and date on the top of incoming faxes. |
| | 2-sided | - | Print incoming faxes on both sides of the paper. |
| Setup Send | Fax Resolution | - | Set the default resolution for outgoing faxes. |
| | Contrast | - | Change the lightness or darkness of faxes you send. |
| | Glass ScanSize | - | Adjust the scan area of the scanner glass to the size of the document. |
| | Real Time TX | - | Send a fax without using the memory. |
| | Overseas Mode | - | If you are having difficulty sending faxes overseas, set this to On. |
| | Coverpage Note | 5. | Set up your own comments for the fax cover page. |
| | | 6. | |
| | Auto Redial | - | Set the machine to redial the last fax number after five minutes, if the fax did not go through because the line was busy. |
| Destination | - | Set the machine to display the destination information on the LCD during fax dialling. | |
| Block List (Available only for some countries.) | Register | - | Register specific fax numbers to the blocked list to avoid receiving faxes from the numbers. |
| | Delete | - | Delete the number from the blocked list. |
| | Print Report | - | Print a list of registered fax numbers in the blocked list. |
| Report Setting | XMIT Report | - | Select the initial setup for the Transmission Verification Report. |
| | Journal Period | - | Set the interval for automatic printing of the Fax Journal. If you select an option other than Off and Every 50 Faxes, you can set the time for the option. If you select Every 7 Days, you can set the day of the week. |

| Level 3 | Level 4 | Level 5 | Descriptions |
|----------------|---------------------------------------------------|---------|---------------------------------------------------------------------------------------------------------------------------------------------------------------|
| Memory Receive | Forward/Store | - | Set the machine to forward fax messages or to store incoming faxes in the memory (so you can retrieve them while you are away from your machine). |
| | PC Fax Receive | - | Set the machine to send faxes to your PC. |
| | Remote Access | - | Set your own code for Remote Retrieval. |
| | Print Document | - | Print incoming faxes stored in the machine's memory. |
| Dial Restrict. | Dial Pad | - | Restrict the dialling when using the dial pad. |
| | Shortcut | - | Set the machine to restrict the dialling of Shortcut numbers. |
| | Speed Dial | - | Set the machine to restrict the dialling of Speed Dial numbers. |
| Remaining Jobs | - | - | Check which scheduled jobs are in the machine's memory and cancel selected jobs. |
| Miscellaneous | BT Call Sign | - | Use with BT Call Sign. |
| | Caller ID (Available only for some countries.) | - | Enable or disable displaying the number (or name) of the party calling you. Before you use this function, confirm that the Caller ID setting is set to On. |

[Copy]

[Copy]

| Level 3 | Level 4 | Descriptions |
|----------|-----------|-------------------------------------------------------|
| Density | - | Adjust the density. |
| Quality | - | Choose the Copy resolution for your type of document. |
| Contrast | - | Adjust the contrast for copies. |
| ID Copy | Density | Adjust the density. |
| | Quality | Choose the Copy resolution for your type of document. |
| | Contrast | Adjust the contrast for copies. |
| | 2in1/1in1 | Make 2 in 1 ID copies. |

[Printer]

[Printer]

| Level 3 | Level 4 | Descriptions |
|----------------------------------------------------|---------------|-----------------------------------------------------------------------------------------------------------------|
| Resolution | - | Select a print resolution. |
| Density | - | Increase or decrease the print density. |
| Test Print | - | Print a test page. |
| 2-sided (For automatic 2-sided printing models) | 2-sided Print | Turn 2-sided printing off or on and select flip on long edge or short edge. |
| | Single Image | For a print job where the last page is a 1-sided image, select the 1-sided Feed option to reduce printing time. |
| Auto Continue | - | Select this setting if you want the machine to clear paper size errors, and to use the paper in the tray. |
| PrintPosition | - | Access the Print Position setting menus. |
| Reset Printer | - | Restore the machine settings to the factory settings. |

[Network] (For Models with Network Functionality)

[Network]

| Level 3 | Level 4 | Level 5 | Level 6 | Descriptions |
|-----------------------------------------|--------------|-------------|---------------------------------------------------------------------------------------------|------------------------------------------------------|
| Wired LAN (For Wired Network models) | TCP/IP | Boot Method | - | Select the Boot method that best suits your needs. |
| | | IP Address | - | Enter the IP address. |
| | | Subnet Mask | - | Enter the Subnet mask. |
| | | Gateway | - | Enter the Gateway address. |
| | | Node Name | - | Enter the Node name. (Up to 32 characters) |
| | | WINS Config | - | Select the WINS configuration mode. |
| | | WINS Server | Primary | Specify the IP address of the primary WINS server. |
| | | | Secondary | Specify the IP address of the secondary WINS server. |
| | | DNS Server | Primary | Specify the IP address of the primary DNS server. |
| | | | Secondary | Specify the IP address of the secondary DNS server. |
| | APIPA | - | Set the machine to allocate the IP address from the link-local address range automatically. | |
| | IPv6 | - | Turn the IPv6 protocol on or off. | |
| | Ethernet | - | - | Select the Ethernet link mode. |
| | Wired Status | - | - | View the current wired status. |
| MAC Address | - | - | View the machine's MAC address. | |
| Set to Default (For wireless models) | - | - | Restore the wired network settings to the factory settings. | |
| Wired Enable | - | - | Turn the Wired LAN interface on or off manually. | |
| WLAN (Wi-Fi) (For wireless models) | Find Network | - | - | Configure your wireless network settings manually. |
| | TCP/IP | Boot Method | - | Select the Boot method that best suits your needs. |
| | | IP Address | - | Enter the IP address. |
| | | Subnet Mask | - | Enter the Subnet mask. |
| | | Gateway | - | Enter the Gateway address. |
| | | Node Name | - | Enter the Node name. (Up to 32 characters) |
| | | WINS Config | - | Select the WINS configuration mode. |
| | | WINS Server | Primary | Specify the IP address of the primary WINS server. |
| | Secondary | | Specify the IP address of the secondary WINS server. | |

| Level 3 | Level 4 | Level 5 | Level 6 | Descriptions |
|----------------------------------------------|-----------------------------------------------------|--------------------|-----------------------------------|-------------------------------------------------------------------------------------------------|
| WLAN (Wi-Fi) (For wireless models) | TCP/IP | DNS Server | Primary | Specify the IP address of the primary DNS server. |
| | | | Secondary | Specify the IP address of the secondary DNS server. |
| | | APIPA | - | Set the machine to allocate the IP address from the link-local address range automatically. |
| | | IPv6 | - | Turn the IPv6 protocol on or off. |
| | WPS/ PushButton | - | - | Configure your wireless network settings using the one-button push method. |
| | WPS/PIN Code | - | - | Configure your wireless network settings using WPS with a PIN. |
| | Recover WLAN | - | - | Reset and restart your wireless network. |
| | WLAN Status | Status | - | View the current wireless network status. |
| | | Signal | - | View the current wireless network signal strength. |
| | | Channel | - | View the current wireless network channel. |
| | | Speed | - | View the current wireless network speed. |
| | | SSID | - | View the current SSID. |
| | | Comm. Mode | - | View the current Communication mode. |
| | MAC Address | - | - | View the machine's MAC address. |
| | Set to Default (For Wired Network models) | - | - | Restore the wireless network settings to the factory settings. |
| WLAN Enable | - | - | Turn the WLAN on or off manually. | |
| Wi-Fi Direct (For wireless models) | Manual | - | - | Configure your Wi-Fi Direct network settings manually. |
| | Group Owner | - | - | Set your machine as the Group Owner. |
| | Push Button | - | - | Configure your Wi-Fi Direct network settings using the one-button push method. |
| | PIN Code | - | - | Configure your Wi-Fi Direct network settings using WPS with a PIN code. |
| | Device Info. | Device Name | - | View your machine's device name. |
| | | SSID | - | View the Group Owner's SSID. When the machine is not connected, the LCD displays Not Connected. |
| | | IP Address | - | View your machine's current IP Address. |
| | Status Info. | Status | - | View the current Wi-Fi Direct network status. |

| Level 3 | Level 4 | Level 5 | Level 6 | Descriptions | |
|----------------------------------------------|---------------------|-----------------------|-----------------------|--------------------------------------------------------------------------------------------------------------------------------------------|------------------------------------------------------------------------------------------------------------------------------|
| Wi-Fi Direct (For wireless models) | Status Info. | Signal | - | View the current Wi-Fi Direct network signal strength. When your machine acts as Group Owner, the LCD always indicates a strong signal. | |
| | | Channel | - | View the current Wi-Fi Direct network channel. | |
| | | Speed | - | View the current Wi-Fi Direct network speed. | |
| | I/F Enable | - | - | Turn the Wi-Fi Direct connection on or off. | |
| E-mail/IFAX | Mail Address | - | - | Enter the email address. (Up to 255 characters) | |
| | Setup Server | SMTP | Server | Enter the SMTP server name and address. | |
| | | | Port | Enter the SMTP port number. | |
| | | | Auth. for SMTP | Select the Security method for email notification. | |
| | | | SSL/TLS | Send or receive an email via an email server that requires secure SSL/TLS communication. | |
| | | | Verify Cert. | Verify the SMTP Server Certificate automatically. | |
| | | POP3/IMAP4 | Protocol | Select the protocol for receiving an email from the server. | |
| | | | Server | Enter the server name and address. | |
| | | | Port | Enter the port number. | |
| | | | Mailbox Name | Enter the mailbox name. (Up to 255 characters) | |
| | | | Mailbox Pwd | Enter the password to log into the server. (Up to 128 characters) | |
| | | | Select Folder | Select the specified folder in the mailbox using the IMAP4 protocol. | |
| | | | SSL/TLS | Send or receive an email via an email server that requires secure SSL/TLS communication. | |
| | | | Verify Cert. | Verify the SMTP Server Certificate automatically. | |
| | | | Auth. Select | Select the Security method for email notification. | |
| | | | Setup Mail RX | Auto Polling | Auto Polling |
| | | Poll Frequency | | | Set the interval for checking new messages on the server. |
| | | Header | | - | Select the contents of the email header to be printed. |
| | | Del Error Mail | | - | The POP3 server deletes error emails automatically. The IMAP4 server deletes error emails automatically after you read them. |

| Level 3 | Level 4 | Level 5 | Level 6 | Descriptions | |
|----------------|----------------|----------------|-----------------------------------------------------------|--------------------------------------------------------------------------------------------------------------------------------------------------|------------------------------------|
| E-mail/IFAX | Setup Mail RX | Notification | - | Receive notification messages. | |
| | Setup Mail TX | Sender Subject | - | View the subject. | |
| | | Size Limit | Size Limit | Size Limit | Limit the size of email documents. |
| | | | Maximum Size (MB) | | |
| | | Notification | - | Send notification messages. | |
| | Setup Relay | Rly Broadcast | - | Relay a document to another fax machine. | |
| | | Relay Domain | Relay Domain XX | Register the Domain name. | |
| | | Relay Report | - | Print the relay Broadcast Report. | |
| | Report Setting | E-mail | XMIT Report | Select the initial setup for the Transmission Verification Report. | |
| | | IFAX | XMIT Report | | |
| Manual Receive | - | - | Check the POP3 or IMAP4 server for new messages manually. | | |
| Web Based Mgmt | - | - | - | Enable or disable Web Based Management. If you enable this function, make sure you specify the connection method to use Web Based Management. | |
| Fax to Server | Fax to Server | - | - | Store a prefix/suffix address in the machine and can send a document from a fax server system. | |
| | Prefix | - | - | | |
| | Suffix | - | - | | |
| Global Detect | Allow Detect | - | - | Enable or disable Global Detect, a function that detects and notifies the user when the user unintentionally connects to a global network. | |
| | Reject Access | - | - | Disable connections to the global network. | |
| Network Reset | - | - | - | Restore all network settings back to the factory settings. | |

[Print Reports]

[Print Reports]

| Level 3 | Level 4 | Descriptions |
|--------------|--------------|------------------------------------------------------------------------------------------------------------------------|
| XMIT Verify | View on LCD | Display a Transmission Verification Report of your last transmission. |
| | Print Report | Print a Transmission Verification Report of your last transmission. |
| Address Book | Numeric | Print a list of names and numbers stored in the Address Book, in numerical order. |
| | Alphabetic | Print a list of names and numbers stored in the Address Book, in alphabetical order. |
| Fax Journal | - | Print a list of information about your last 200 incoming and outgoing faxes. (TX means Transmit. RX means Receive.) |

| Level 3 | Level 4 | Descriptions |
|---------------------------------------------------|---------|-----------------------------------------------------|
| User Settings | - | Print a list of your User settings. |
| Print Settings | - | Print a list of your Printer settings. |
| Network Config | - | Print a list of your Network settings. |
| PrintFileList (available for certain models) | - | Print a list of data saved in the machine's memory. |
| Drum Dot Print | - | Print the Drum Dot Check Sheet. |
| WLAN Report (For wireless models) | - | Print the wireless LAN connection results. |
| Caller ID (Available only for some countries.) | - | Print a list of the Caller ID History. |

[Machine Info.]

[Machine Info.]

| Level 3 | Level 4 | Descriptions |
|--------------|---------------|--------------------------------------------------------------------------|
| Serial No. | - | Check your machine's serial number. |
| Version | Main Version | Check your machine's firmware version. |
| | Security Ver. | |
| Page Counter | Total | Check the total number of pages the machine has printed during its life. |
| | Fax | |
| | Copy | |
| | Print | |
| | Other | |
| Parts Life | Toner | View the approximate remaining toner life. |
| | Drum | You can check the percentage of Drum life that remains available. |

[Initial Setup]

[Initial Setup]

| Level 3 | Level 4 | Descriptions |
|----------------|---------------|-----------------------------------------------------------------------------------------------------------------------------------------------------------------------------------------------------------|
| Date & Time | Date & Time | Add the date and time on the screen and in the headings of the faxes you send. |
| | Auto Daylight | Set the machine to change automatically for Daylight Saving Time. |
| | Time Zone | Set your time zone. |
| Station ID | - | Enter your name and fax number so it appears on each page you fax. |
| Tone/Pulse | - | Select the dialling mode. |
| Dial Tone | - | Shorten the dial tone detection pause. |
| Phone Line Set | - | Select the telephone line type. |
| Compatibility | - | Adjust the equalisation for transmission difficulties. VoIP service providers offer fax support using various standards. If you regularly experience fax transmission errors, select Basic (for VoIP). |

| Level 3 | Level 4 | Descriptions |
|---------------------------------------------------------|-----------------------------------------------------------------|----------------------------------------------------------------------------------------------------------------------|
| Reset | Machine Reset | Restore all the machine settings that you have changed. |
| | Network Reset (For models with network functionality) | Restore all network settings back to the factory settings. |
| | Address & Fax | Erase all stored phone numbers and fax settings. |
| | All Settings | Restore all the machine's settings back to the factory settings. |
| | Factory Reset | Restore all the machine's settings to the factory defaults. Perform this operation when you dispose of your machine. |
| Local Language (available for certain models) | - | Change your LCD language. |



Related Information

- [Settings and Features Tables](#)

Settings Tables (2 Line LCD DCP models)

Related Models: DCP-L2600D/DCP-L2620DW/DCP-L2622DW/DCP-L2627DW/DCP-L2627DWXL/DCP-L2627DWE/DCP-L2640DN

>> [General Setup]
 >> [Copy]
 >> [Printer]
 >> [Network] (For Models with Network Functionality)
 >> [Print Reports]
 >> [Machine Info.]
 >> [Initial Setup]

[General Setup]

[General Setup]

| Level 3 | Level 4 | Level 5 | Descriptions |
|---------------|----------------|----------|----------------------------------------------------------------------------------------------------------------------------------------------------------------------------------------------------------------------------------------------------------------------------------------|
| Tray Setting | Paper Type | - | Set the type of paper in the paper tray. |
| | Paper Size | - | Set the paper size in the paper tray. |
| | Print Position | X Offset | Move the print start position (at the upper left corner of pages) horizontally from -500 (left) to +500 (right) dots in 300 dpi. |
| | | Y Offset | Move the print start position (at the upper left corner of pages) vertically from -500 (up) to +500 (down) dots in 300 dpi. |
| | Check Paper | - | Select whether to display a message telling you to check that the size and type of the paper in the machine and the machine's Paper Size and Paper Type settings match. |
| Ecology | Eco Mode | - | Turn the following machine settings on at the same time: <ul style="list-style-type: none"> • 2-sided Print:Long Edge ¹(available for certain models) • Sleep Time:0Min • Quiet Mode:On ¹ • Toner Save:On ¹ |
| | Toner Save | - | Increase the page yield of the toner cartridge. |
| | Sleep Time | - | Set the number of minutes before the machine enters Sleep mode. |
| | Quiet Mode | - | Decrease printing noise. |
| | Auto Power Off | - | Set the number of hours that the machine will remain in Deep Sleep mode before going into Power Off mode. |
| LCD Contrast | - | - | Adjust the LCD contrast. |
| Replace Toner | - | - | Set the machine to continue printing after the LCD displays Replace Toner. |

¹ Changing this setting is possible only after you change certain machine settings in Web Based Management.

[Copy]

[Copy]

| Level 3 | Level 4 | Descriptions |
|---------|---------|---------------------|
| Density | - | Adjust the density. |

| Level 3 | Level 4 | Descriptions |
|----------|-----------|-------------------------------------------------------|
| Quality | - | Choose the Copy resolution for your type of document. |
| Contrast | - | Adjust the contrast for copies. |
| ID Copy | Density | Adjust the density. |
| | Quality | Choose the Copy resolution for your type of document. |
| | Contrast | Adjust the contrast for copies. |
| | 2in1/1in1 | Make 2 in 1 ID copies. |

[Printer]

[Printer]

For Printer Emulation Supported models

| Level 3 | Level 4 | Level 5 | Descriptions |
|----------------|---------------|-------------|-----------------------------------------------------------------------------------------------------------------|
| Emulation | - | - | Set the printer emulation mode. |
| Resolution | - | - | Select a print resolution. |
| Density | - | - | Increase or decrease the print density. |
| Print Settings | - | - | Set your print settings to Text or Graphics. |
| Print Options | Font List | HP LaserJet | Print a list of the machine's internal fonts. |
| | | BR-Script 3 | |
| | Test Print | - | Print a test page. |
| 2-sided | 2-sided Print | - | Turn 2-sided printing off or on and select flip on long edge or short edge. |
| | Single Image | - | For a print job where the last page is a 1-sided image, select the 1-sided Feed option to reduce printing time. |
| Auto Continue | - | - | Select this setting if you want the machine to clear paper size errors, and to use the paper in the tray. |
| Paper Type | - | - | Set the paper type. |
| Paper Size | - | - | Set the paper size. |
| Copies | - | - | Set the number of printed pages. |
| Orientation | - | - | Set pages to print in either portrait or landscape orientation. |
| PrintPosition | - | - | Access the Print Position setting menus. |
| Auto FF | - | - | Allow the machine to print any remaining data automatically. |
| HP LaserJet | Font No. | - | Set the font number. |
| | Font Pitch | - | Set the font pitch. (Available only for certain fonts.) |
| | Font Point | - | Set the font size. (Available only for certain fonts.) |
| | Symbol Set | - | Select the symbol or character set. |
| | Table Print | - | Print the code table. |
| | Auto LF | - | ON: CR -> CR+LF, OFF: CR -> CR |
| | Auto CR | - | ON: LF -> LF+CR, FF -> FF+CR, or VT -> VT+CR OFF: LF -> LF, FF -> FF, or VT -> VT |
| | Auto WRAP | - | Select whether you want a line feed and carriage return when the carriage position reaches the right margin. |

| Level 3 | Level 4 | Level 5 | Descriptions |
|---------------|---------------|---------|---------------------------------------------------------------------------------------------------------------|
| HP LaserJet | Auto SKIP | - | Select whether you want a line feed and carriage return when the carriage position reaches the bottom margin. |
| | Left Margin | - | Set the left margin at column 0 to 70 columns at 1 cpi. |
| | Right Margin | - | Set the right margin at column 10 to 80 columns at 1 cpi. |
| | Top Margin | - | Set the top margin distance from the top edge of the paper. |
| | Bottom Margin | - | Set the bottom margin distance from the bottom edge of the paper. |
| | Lines | - | Set the number of lines on each page. |
| | Tray Command | - | Select this setting if a tray mismatch appears when you use the HP drivers. |
| BR-Script 3 | Error Print | - | Choose whether the machine prints the error information when errors occur. |
| PDF | Multiple Page | - | Set the page layout when printing multiple pages. |
| | PDF Print Opt | - | Set the PDF Print setting to print either comments (Markup) or stamps in the PDF file, along with the text. |
| | Fit to Page | - | Select if the machine scales or resizes the pages in the PDF file to fit the selected paper size. |
| Reset Printer | - | - | Restore the machine settings to the factory settings. |

For the Other models

| Level 3 | Level 4 | Descriptions |
|----------------------------------------------------|---------------|-----------------------------------------------------------------------------------------------------------------|
| Resolution | - | Select a print resolution. |
| Density | - | Increase or decrease the print density. |
| Test Print | - | Print a test page. |
| 2-sided (For automatic 2-sided printing models) | 2-sided Print | Turn 2-sided printing off or on and select flip on long edge or short edge. |
| | Single Image | For a print job where the last page is a 1-sided image, select the 1-sided Feed option to reduce printing time. |
| Auto Continue | - | Select this setting if you want the machine to clear paper size errors, and to use the paper in the tray. |
| PrintPosition | - | Access the Print Position setting menus. |
| Reset Printer | - | Restore the machine settings to the factory settings. |

[Network] (For Models with Network Functionality)

[Network]

| Level 3 | Level 4 | Level 5 | Level 6 | Descriptions |
|-----------------------------------------|---------|-------------|---------|----------------------------------------------------|
| Wired LAN (For Wired Network models) | TCP/IP | Boot Method | - | Select the Boot method that best suits your needs. |
| | | IP Address | - | Enter the IP address. |
| | | Subnet Mask | - | Enter the Subnet mask. |
| | | Gateway | - | Enter the Gateway address. |
| | | Node Name | - | Enter the Node name. (Up to 32 characters) |

| Level 3 | Level 4 | Level 5 | Level 6 | Descriptions |
|------------------------------------------------|------------------------------------------------|--------------------|---------------------------------------------------------------------------------------------|---------------------------------------------------------------------------------------------|
| Wired LAN (For Wired Network models) | TCP/IP | WINS Config | - | Select the WINS configuration mode. |
| | | WINS Server | Primary | Specify the IP address of the primary WINS server. |
| | | | Secondary | Specify the IP address of the secondary WINS server. |
| | | DNS Server | Primary | Specify the IP address of the primary DNS server. |
| | | | Secondary | Specify the IP address of the secondary DNS server. |
| | | APIPA | - | Set the machine to allocate the IP address from the link-local address range automatically. |
| | | IPv6 | - | Turn the IPv6 protocol on or off. |
| | Ethernet | - | - | Select the Ethernet link mode. |
| | Wired Status | - | - | View the current wired status. |
| | MAC Address | - | - | View the machine's MAC address. |
| | Set to Default (For wireless models) | - | - | Restore the wired network settings to the factory settings. |
| Wired Enable | - | - | Turn the Wired LAN interface on or off manually. | |
| WLAN (Wi-Fi) (For wireless models) | Find Network | - | - | Configure your wireless network settings manually. |
| | TCP/IP | Boot Method | - | Select the Boot method that best suits your needs. |
| | | IP Address | - | Enter the IP address. |
| | | Subnet Mask | - | Enter the Subnet mask. |
| | | Gateway | - | Enter the Gateway address. |
| | | Node Name | - | Enter the Node name. (Up to 32 characters) |
| | | WINS Config | - | Select the WINS configuration mode. |
| | | WINS Server | Primary | Specify the IP address of the primary WINS server. |
| | | | Secondary | Specify the IP address of the secondary WINS server. |
| | | DNS Server | Primary | Specify the IP address of the primary DNS server. |
| | | | Secondary | Specify the IP address of the secondary DNS server. |
| | APIPA | - | Set the machine to allocate the IP address from the link-local address range automatically. | |
| | IPv6 | - | Turn the IPv6 protocol on or off. | |
| | WPS/PushButton | - | - | Configure your wireless network settings using the one-button push method. |

| Level 3 | Level 4 | Level 5 | Level 6 | Descriptions | |
|----------------------------------------------|-----------------------------------------------------|--------------------|-----------------------------------|--------------------------------------------------------------------------------|--------------------------------------------------------------------------------------------------------------------------------------------|
| WLAN (Wi-Fi) (For wireless models) | WPS/PIN Code | - | - | Configure your wireless network settings using WPS with a PIN. | |
| | Recover WLAN | - | - | Reset and restart your wireless network. | |
| | WLAN Status | Status | - | - | View the current wireless network status. |
| | | Signal | - | - | View the current wireless network signal strength. |
| | | Channel | - | - | View the current wireless network channel. |
| | | Speed | - | - | View the current wireless network speed. |
| | | SSID | - | - | View the current SSID. |
| | | Comm. Mode | - | - | View the current Communication mode. |
| | MAC Address | - | - | View the machine's MAC address. | |
| | Set to Default (For Wired Network models) | - | - | Restore the wireless network settings to the factory settings. | |
| WLAN Enable | - | - | Turn the WLAN on or off manually. | | |
| Wi-Fi Direct (For wireless models) | Manual | - | - | Configure your Wi-Fi Direct network settings manually. | |
| | Group Owner | - | - | Set your machine as the Group Owner. | |
| | Push Button | - | - | Configure your Wi-Fi Direct network settings using the one-button push method. | |
| | PIN Code | - | - | Configure your Wi-Fi Direct network settings using WPS with a PIN code. | |
| | Device Info. | Device Name | - | - | View your machine's device name. |
| | | SSID | - | - | View the Group Owner's SSID. When the machine is not connected, the LCD displays Not Connected. |
| | | IP Address | - | - | View your machine's current IP Address. |
| | Status Info. | Status | - | - | View the current Wi-Fi Direct network status. |
| | | Signal | - | - | View the current Wi-Fi Direct network signal strength. When your machine acts as Group Owner, the LCD always indicates a strong signal. |
| | | Channel | - | - | View the current Wi-Fi Direct network channel. |
| | | Speed | - | - | View the current Wi-Fi Direct network speed. |
| | I/F Enable | - | - | Turn the Wi-Fi Direct connection on or off. | |
| | Web Based Mgmt | - | - | - | Enable or disable Web Based Management. |

| Level 3 | Level 4 | Level 5 | Level 6 | Descriptions |
|---------------|---------------|---------|---------|--------------------------------------------------------------------------------------------------------------------------------------------|
| | | | | If you enable this function, make sure you specify the connection method to use Web Based Management. |
| Global Detect | Allow Detect | - | - | Enable or disable Global Detect, a function that detects and notifies the user when the user unintentionally connects to a global network. |
| | Reject Access | - | - | Disable connections to the global network. |
| Network Reset | - | - | - | Restore all network settings back to the factory settings. |

[Print Reports]

[Print Reports]

| Level 3 | Level 4 | Descriptions |
|------------------------------------------------------------|---------|-----------------------------------------------------|
| User Settings | - | Print a list of your User settings. |
| Print Settings | - | Print a list of your Printer settings. |
| Network Config (For models with network function) | - | Print a list of your Network settings. |
| PrintFileList (available for certain models) | - | Print a list of data saved in the machine's memory. |
| Drum Dot Print | - | Print the Drum Dot Check Sheet. |
| WLAN Report (For models with wireless network function) | - | Print the wireless LAN connection results. |

[Machine Info.]

[Machine Info.]

| Level 3 | Level 4 | Descriptions |
|--------------|------------------------------------------------|--------------------------------------------------------------------------|
| Serial No. | - | Check your machine's serial number. |
| Version | Main Version | Check your machine's firmware version. |
| | Sub1 Version (available for certain models) | |
| | Security Ver. | |
| Page Counter | Total | Check the total number of pages the machine has printed during its life. |
| | Copy | |
| | Print | |
| | Other | |
| Parts Life | Toner | View the approximate remaining toner life. |
| | Drum | You can check the percentage of Drum life that remains available. |

[Initial Setup]

[Initial Setup]

| Level 3 | Level 4 | Descriptions |
|---------------------------------------------------------|-----------------------------------------------------------------|----------------------------------------------------------------------------------------------------------------------|
| Reset | Machine Reset | Restore all the machine settings that you have changed. |
| | Network Reset (For models with network functionality) | Restore all network settings back to the factory settings. |
| | All Settings | Restore all the machine's settings back to the factory settings. |
| | Factory Reset | Restore all the machine's settings to the factory defaults. Perform this operation when you dispose of your machine. |
| Local Language (available for certain models) | - | Change your LCD language. |



Related Information

- [Settings and Features Tables](#)

Settings Tables (2.7" Touch Panel MFC models and 3.5" Touch Panel MFC models)

Related Models: MFC-L2860DWE/MFC-L2860DW/MFC-L2862DW/MFC-L2922DW/MFC-L2960DW/MFC-L2980DW

- >> [Settings]
- >> [General Setup]
- >> [Shortcut Settings]
- >> [Fax]
- >> [Printer]
- >> [Network]
- >> [Print Reports]
- >> [Machine Info.]
- >> [Initial Setup]

[Settings]



[Settings]

| Level 1 | Level 2 | Descriptions |
|---------------|---------------------------------------|------------------------------------------------------------------------------------------------------------|
| (Date & Time) | - | Access the Date and Time setting menus. |
| Toner | Toner Life | View the approximate remaining toner life. |
| | Test Print | Print a test page. |
| | Toner Cartridge Check | View the installed toner cartridge information on the LCD, for example, if the toner cartridge is genuine. |
| Network | Wired LAN | Access the Wired LAN setting menus. |
| | WLAN (Wi-Fi) (For wireless models) | Access the WLAN setting menus. |
| Fax Preview | - | View received faxes on the LCD. |
| Tray Setting | - | Access the tray setting menus. |
| Eco Mode | - | Access the Eco Mode setting menu. |
| All Settings | - | Configure the detailed settings. |

[General Setup]

[All Settings] > [General Setup]

| Level 3 | Level 4 | Level 5 | Descriptions |
|--------------|----------------|----------|----------------------------------------------------------------------------------------------------------------------------------|
| Tray Setting | Paper Type | - | Set the type of paper in the paper tray. |
| | Paper Size | - | Set the paper size in the paper tray. |
| | Print Position | X Offset | Move the print start position (at the upper left corner of pages) horizontally from -500 (left) to +500 (right) dots in 300 dpi. |
| | | Y Offset | Move the print start position (at the upper left corner of pages) vertically from -500 (up) to +500 (down) dots in 300 dpi. |

| Level 3 | Level 4 | Level 5 | Descriptions |
|-----------------|----------------------------------------------|------------|------------------------------------------------------------------------------------------------------------------------------------------------------------------------------------------------------------------------------------------------------------------------------------------------------------------------------------------------------|
| Tray Setting | Check Paper | - | Select whether to display a message telling you to check that the size and type of the paper in the machine and the machine's Paper Size and Paper Type settings match. |
| Volume | Ring | - | Adjust the ring volume. |
| | Beep | - | Adjust the beeper volume. |
| | Speaker | - | Adjust the speaker volume. |
| LCD Settings | Backlight | - | Adjust the brightness of the LCD backlight. |
| | Dim Timer | - | Set how long the LCD backlight stays on after returning to the Home screen. |
| Screen Settings | Home Screen | - | Set the Main Home screen. |
| | Scan Screen | - | Set the default Scan screen settings. |
| | Display Information | IP Address | Select whether or not to display your machine's IP Address on the Home screens. |
| Ecology | Eco Mode | - | Turn the following machine settings on at the same time: <ul style="list-style-type: none"> • 2-sided Print:Long Edge ¹ (available for certain models) • Sleep Time:0 Min (available for certain models) • Dim Timer:10 Secs • Quiet Mode:On ¹ • Toner Save:On ¹ |
| | Toner Save | - | Increase the page yield of the toner cartridge. |
| | Sleep Time (available for certain models) | - | Set the number of minutes before the machine enters Sleep mode. |
| | Quiet Mode | - | Decrease printing noise. |
| | Auto Power Off | - | Set the number of minutes or hours before the machine enters Power Off mode. Choose <i>Off</i> if you do not want the machine to go into Power Off mode. |
| Setting Lock | - | - | Restrict unauthorised users from changing the machine's settings. |
| Replace Toner | - | - | Set the machine to continue printing after the LCD displays <i>Replace Toner</i> . |

¹ Changing this setting is possible only after you change certain machine settings in Web Based Management.

[Shortcut Settings]

[All Settings] > [Shortcut Settings]

| Level 3 | Level 4 | Descriptions |
|---------------------------|-----------------------------------------------------|------------------------------------|
| (Select shortcut button.) | Rename | Change the shortcut name. |
| | Edit | Change the shortcut settings. |
| | Delete | Delete the shortcut. |
| | Register Card/NFC (available for certain models) | Assign a shortcut to an ID card. |
| | Delete Card/NFC (available for certain models) | Remove a shortcut from an ID card. |

[Fax]

[All Settings] > [Fax]

| Level 3 | Level 4 | Level 5 | Descriptions | |
|--------------------------------------------------------|----------------|----------------------------------------------------------------------------------------|----------------------------------------------------------------------------------------------------------------------------|-----------------------------------------------------------------------------------------------------------------------------------------------------------------------------------------------------------------------------------------------------|
| Setup Receive | Ring Delay | - | Set the number of rings before the machine answers in Fax or Fax/Tel mode. | |
| | Receive Mode | - | Select the Receive Mode that best suits your needs. | |
| | F/T Ring Time | - | Set the length of the pseudo/double-ring time in Fax/Tel mode. | |
| | Fax Preview | - | View received faxes on the LCD. | |
| | Fax Detect | - | Receive fax messages automatically when you answer a call and hear fax tones. | |
| | Remote Codes | Remote Codes | - | Answer calls at an extension or external telephone and use codes to turn the Remote Codes on or off. You can personalise the codes. |
| | | Act.Code | | |
| | | Deact.Code | | |
| | Auto Reduction | - | Reduce the size of incoming faxes. | |
| | PC Fax Receive | - | Set the machine to send faxes to your computer. You can turn on the Backup Print safety feature. | |
| | Memory Receive | Off | - | - |
| | | Fax Forward | - | Set the machine to forward fax messages or to store incoming faxes in the memory (so you can retrieve them while you are away from your machine). If you select Fax Forward or Fax Storage, you can turn on the Backup Print safety feature. |
| | | Fax Storage | | |
| | | Forward to Cloud | - | Forward incoming faxes to the online service. |
| Forward to Network (available for certain models) | | - | Forward incoming faxes to a network destination. | |
| Fax Rx Stamp | - | Print the received time and date on the top of incoming faxes. | | |
| 2-sided | - | Print incoming faxes on both sides of the paper. | | |
| Setup Send | Coverpage Note | 5. | Set up your own comments for the fax cover page. | |
| | | 6. | | |
| | Auto Redial | - | Set the machine to redial the last fax number after five minutes, if the fax did not go through because the line was busy. | |
| Destination | - | Set the machine to display the destination information on the LCD during fax dialling. | | |
| Incoming limit (Available only for some countries.) | Limit method | - | Select a method for incoming fax restriction. | |
| Report Setting | XMIT Report | - | Select the initial setup for the Transmission Verification Report. | |
| | Journal Period | Journal Period | Set the interval for automatic printing of the Fax Journal. | |

| Level 3 | Level 4 | Level 5 | Descriptions |
|------------------|---------------------------------------------------|---------|---------------------------------------------------------------------------------------------------------------------------------------------------------------|
| Report Setting | Journal Period | Time | If you select an option other than Off and Every 50 Faxes, you can set the time for the option. |
| | | Day | If you select Every 7 Days, you can set the day of the week. |
| Print Document | - | - | Print incoming faxes stored in the machine's memory. |
| Remote Access | - | - | Set your own code for Remote Retrieval. |
| Dial Restriction | Dial Pad | - | Restrict the dialling when using the dial pad. |
| | Address Book | - | Restrict the dialling when using the Address Book. |
| | Shortcuts | - | Restrict the dialling when using a Shortcut. |
| Remaining Jobs | - | - | Check which scheduled jobs are in the machine's memory and cancel selected jobs. |
| Miscellaneous | BT Call Sign (U.K. only) | - | Use with BT Call Sign. |
| | Caller ID (Available only for some countries.) | - | Enable or disable displaying the number (or name) of the party calling you. Before you use this function, confirm that the Caller ID setting is set to On. |

[Printer]

[All Settings] > [Printer]

| Level 3 | Level 4 | Level 5 | Descriptions |
|----------------|---------------|-------------|-----------------------------------------------------------------------------------------------------------------|
| Emulation | - | - | Select the emulation mode. |
| Resolution | - | - | Select a print resolution. |
| Density | - | - | Increase or decrease the print density. |
| Print Settings | - | - | Set your print settings to Text or Graphics. |
| Print Options | Font List | HP LaserJet | Print a list of the machine's internal fonts. |
| | | BR-Script 3 | |
| | Test Print | - | Print a test page. |
| 2-sided | 2-sided Print | - | Enable or disable 2-sided printing and choose long edge or short edge. |
| | Single Image | - | For a print job where the last page is a 1-sided image, select the 1-sided Feed option to reduce printing time. |
| Auto Continue | - | - | Select this setting if you want the machine to clear paper size errors, and to use the paper in the tray. |
| Paper Type | - | - | Set the paper type. |
| Paper Size | - | - | Set the paper size. |
| Copies | - | - | Set the number of printed pages. |
| Orientation | - | - | Set pages to print in either portrait or landscape orientation. |
| Print Position | X Offset | - | Access the Print Position setting menus. |
| | Y Offset | - | |
| Auto FF | - | - | Allow the machine to print any remaining data automatically. |
| HP LaserJet | Font No. | Font No. | Set the font number. |

| Level 3 | Level 4 | Level 5 | Descriptions |
|---------------|-------------------|-----------------------------------------------------------------------------|---------------------------------------------------------------------------------------------------------------|
| HP LaserJet | Font No. | Soft Font No. | Set the soft font number. This menu appears if a soft font is installed on your Brother machine. |
| | Font Pitch | - | Set the font pitch. (Available only for certain fonts.) |
| | Font Point | - | Set the font size. (Available only for certain fonts.) |
| | Symbol Set | - | Select the symbol or character set. |
| | Table Print | - | Print the code table. |
| | Auto LF | - | ON: CR -> CR+LF, OFF: CR -> CR |
| | Auto CR | - | ON: LF -> LF+CR, FF -> FF+CR, or VT -> VT+CR OFF: LF -> LF, FF -> FF, or VT -> VT |
| | Auto WRAP | - | Select whether you want a line feed and carriage return when the carriage position reaches the right margin. |
| | Auto SKIP | - | Select whether you want a line feed and carriage return when the carriage position reaches the bottom margin. |
| | Left Margin | - | Set the left margin at column 0 to 70 columns at 1 cpi. |
| | Right Margin | - | Set the right margin at column 10 to 80 columns at 1 cpi. |
| | Top Margin | - | Set the top margin distance from the top edge of the paper. |
| | Bottom Margin | - | Set the bottom margin distance from the bottom edge of the paper. |
| | Lines | - | Set the number of lines on each page. |
| Tray Command | - | Select this setting if a tray mismatch appears when you use the HP drivers. | |
| BR-Script 3 | Error Print | - | Choose whether the machine prints the error information when errors occur. |
| PDF | Multiple Page | - | Set the page layout when printing multiple pages. |
| | PDF Print Options | - | Set the PDF Print setting to print either comments (Markup) or stamps in the PDF file, along with the text. |
| | PDF Fit to Page | - | Select if the machine scales or resizes the pages in the PDF file to fit the selected paper size. |
| Reset Printer | - | - | Restore the machine settings to the factory settings. |

[Network]

[All Settings] > [Network]

| Level 3 | Level 4 | Level 5 | Level 6 | Descriptions |
|-----------|---------|--------------------|---------|----------------------------------------------------|
| Wired LAN | TCP/IP | Boot Method | - | Select the Boot method that best suits your needs. |
| | | IP Address | - | Enter the IP address. |
| | | Subnet Mask | - | Enter the Subnet mask. |
| | | Gateway | - | Enter the Gateway address. |
| | | Node Name | - | Enter the Node name. (up to 32 characters) |
| | | WINS Configuration | - | Select the WINS configuration mode. |

| Level 3 | Level 4 | Level 5 | Level 6 | Descriptions |
|--------------|--------------------|--------------------|---------------------------------------------------------------------------------------------|---------------------------------------------------------------------------------------------|
| Wired LAN | TCP/IP | WINS Server | Primary | Specify the IP address of the primary WINS server. |
| | | | Secondary | Specify the IP address of the secondary WINS server. |
| | | DNS Server | Primary | Specify the IP address of the primary DNS server. |
| | | | Secondary | Specify the IP address of the secondary DNS server. |
| | | APIPA | - | Set the machine to allocate the IP address from the link-local address range automatically. |
| | | IPv6 | - | Turn the IPv6 protocol on or off. |
| | Ethernet | - | - | Select the Ethernet link mode. |
| | Wired Status | - | - | View the current wired status. |
| | MAC Address | - | - | View the machine's MAC address. |
| | Set to Default | - | - | Restore the wired network settings to the factory settings. |
| | Wired Enable | - | - | Turn the Wired LAN interface on or off manually. |
| WLAN (Wi-Fi) | Find Wi-Fi Network | - | - | Configure your wireless network settings manually. |
| | TCP/IP | Boot Method | - | Select the Boot method that best suits your needs. |
| | | IP Address | - | Enter the IP address. |
| | | Subnet Mask | - | Enter the Subnet mask. |
| | | Gateway | - | Enter the Gateway address. |
| | | Node Name | - | Enter the Node name. (up to 32 characters) |
| | | WINS Configuration | - | Select the WINS configuration mode. |
| | | WINS Server | Primary | Specify the IP address of the primary WINS server. |
| | | | Secondary | Specify the IP address of the secondary WINS server. |
| | | DNS Server | Primary | Specify the IP address of the primary DNS server. |
| | | | Secondary | Specify the IP address of the secondary DNS server. |
| | APIPA | - | Set the machine to allocate the IP address from the link-local address range automatically. | |
| | IPv6 | - | Turn the IPv6 protocol on or off. | |
| | WPS/Push Button | - | - | Configure your wireless network settings using the one-button push method. |
| | WPS/PIN Code | - | - | Configure your wireless network settings using WPS with a PIN. |
| | Recover WLAN | - | - | Reset and restart your wireless network. |

| Level 3 | Level 4 | Level 5 | Level 6 | Descriptions | |
|-----------------------------------------------|--------------------|-------------|----------------|------------------------------------------------------------------------------------------|--------------------------------------------------------------------------------------------------------------------------------------------|
| WLAN (Wi-Fi) | WLAN Status | Status | - | View the current wireless network status. | |
| | | Signal | - | View the current wireless network signal strength. | |
| | | SSID | - | View the current SSID. | |
| | | Comm. Mode | - | View the current Communication mode. | |
| | MAC Address | - | - | View the machine's MAC address. | |
| | Set to Default | - | - | Restore the wireless network settings to the factory settings. | |
| | WLAN Enable | - | - | Turn the wireless network connection On. | |
| Wi-Fi Direct | Manual | - | - | Configure your Wi-Fi Direct network settings manually. | |
| | Group Owner | - | - | Set your machine as the Group Owner. | |
| | Push Button | - | - | Configure your Wi-Fi Direct network settings using the one-button push method. | |
| | PIN Code | - | - | Configure your Wi-Fi Direct network settings using WPS with a PIN code. | |
| | Device Information | Device Name | - | - | View your machine's device name. |
| | | SSID | - | - | View the Group Owner's SSID. When the machine is not connected, the LCD displays Not Connected. |
| | | IP Address | - | - | View your machine's current IP Address. |
| | Status Information | Status | - | - | View the current Wi-Fi Direct network status. |
| | | Signal | - | - | View the current Wi-Fi Direct network signal strength. When your machine acts as Group Owner, the LCD always indicates a strong signal. |
| | I/F Enable | - | - | - | Turn the Wi-Fi Direct connection on or off. |
| NFC (available for certain models) | - | - | - | Turn the NFC function on or off. | |
| E-mail/IFAX (available for certain models) | Mail Address | - | - | Enter the email address. (Up to 255 characters) | |
| | Setup Server | SMTP | Server | Enter the SMTP server name and address. | |
| | | | Port | Enter the SMTP port number. | |
| | | | Auth. for SMTP | Select the Security method for email notification. | |
| | | | SSL/TLS | Send or receive an email via an email server that requires secure SSL/TLS communication. | |

| Level 3 | Level 4 | Level 5 | Level 6 | Descriptions | |
|-----------------------------------------------|----------------------|----------------------------------------------------|-------------------|------------------------------------------------------------------------------------------------------------------------------|-------------------------------------|
| E-mail/IFAX (available for certain models) | Setup Server | SMTP | Verify Cert. | Verify the SMTP Server Certificate automatically. | |
| | | POP3/IMAP4 | Protocol | Select the protocol for receiving an email from the server. | |
| | | | Server | Enter the server name and address. | |
| | | | Port | Enter the port number. | |
| | | | Mailbox Name | Enter the mailbox name. (Up to 255 characters) | |
| | | | Mailbox Password | Enter the password to log into the server. (Up to 128 characters) | |
| | | | Select Folder | Select the specified folder in the mailbox using the IMAP4 protocol. | |
| | | | SSL/TLS | Send or receive an email via an email server that requires secure SSL/TLS communication. | |
| | | | Verify Cert. | Verify the Server Certificate automatically. | |
| | Auth. for POP3/IMAP4 | Select the Security method for email notification. | | | |
| | Setup Mail RX | Auto Polling | Auto Polling | Automatically check the server for new messages. | |
| | | | Poll Frequency | Set the interval for checking for new messages on the server. | |
| | | Header | - | Select the contents of the email header to be printed. | |
| | | Del/Read Error Mail | - | The POP3 server deletes error emails automatically. The IMAP4 server deletes error emails automatically after you read them. | |
| | | Notification | - | Receive notification messages. | |
| | Setup Mail TX | Sender Subject | - | View the subject. | |
| | | Size Limit | Size Limit | Limit the size of email documents. | |
| | | | Maximum Size (MB) | | |
| | | Notification | - | Send notification messages. | |
| | Setup Relay | Relay Broadcast | - | Relay a document to another fax machine. | |
| | | Relay Domain | Relay ## | Register the Domain name. | |
| | | Relay Report | - | Print the relay Broadcast Report. | |
| | Report Setting | E-mail | XMIT Report | Select the initial setup for the Transmission Verification Report. | |
| | | IFAX | XMIT Report | | |
| | Manual Receive | - | - | Manually check the POP3 or IMAP4 server for new messages. | |
| | Web Connect Settings | Proxy Settings | Proxy Connection | - | Change the Web connection settings. |
| | | | Address | - | |
| Port | | | - | | |

| Level 3 | Level 4 | Level 5 | Level 6 | Descriptions |
|-------------------------------------------------|----------------|-----------|---------|-------------------------------------------------------------------------------------------------------------------------------------------------------------------------------------------------|
| Web Connect Settings | Proxy Settings | User Name | - | Change the Web connection settings. |
| | | Password | - | |
| Web Based Mgmt | - | - | - | Enable or disable Web Based Management. If you enable this function, make sure you specify the connection method to use Web Based Management. |
| Fax to Server (available for certain models) | Fax to Server | - | - | Select the network connection type. |
| | Prefix | - | - | |
| | Suffix | - | - | |
| IPsec (available for certain models) | - | - | - | IPsec is an optional security feature of the IP protocol that provides authentication and encryption services. We recommend contacting your network administrator before changing this setting. |
| Global Detect | Allow Detect | - | - | Enable or disable Global Detect, a function that detects and notifies the user when the user unintentionally connects to a global network. |
| | Reject Access | - | - | Disable connections to the global network. |
| Network Reset | - | - | - | Restore all network settings back to the factory settings. |

[Print Reports]

[All Settings] > [Print Reports]

| Level 3 | Level 4 | Descriptions |
|-----------------------------------------------------------------|--------------|------------------------------------------------------------------------------------------------------------------------|
| XMIT Verify | View on LCD | Display Transmission Verification Reports about sent faxes. |
| | Print Report | Print a Transmission Verification Report of your last transmission. |
| Address Book | - | Print a list of names and numbers stored in the Address Book. |
| Fax Journal | - | Print a list of information about your last 200 incoming and outgoing faxes. (TX means Transmit. RX means Receive.) |
| User Settings | - | Print a list of your User settings. |
| Printer Settings | - | Print a list of your Printer settings. |
| Network Configuration | - | Print a list of your Network settings. |
| Print File List (available for certain models) | - | Print a list of data saved in the machine's memory. |
| Drum Dot Print | - | Print the Drum Dot Check Sheet. |
| WLAN Report (For models with wireless network functionality) | - | Print the wireless LAN connection results. |
| Caller ID History | - | Print a list of the Caller ID History. |

| Level 3 | Level 4 | Descriptions |
|--------------------------------------|---------|--------------|
| (Available only for some countries.) | | |

[Machine Info.]

[All Settings] > [Machine Info.]

| Level 3 | Level 4 | Descriptions |
|---------------------|------------------|--------------------------------------------------------------------|
| Serial No. | - | Check your machine's serial number. |
| Firmware Version | Main Version | Check your machine's firmware version. |
| | Sub1 Version | |
| | Security Version | |
| Firmware Update | - | Update your machine to the latest firmware. |
| Firmware Auto Check | - | View firmware information on the Home screen. |
| Page Counter | Total | Check the total number of pages the machine has printed. |
| | Fax | |
| | Copy | |
| | Print | |
| | Other | |
| Parts Life | Drum | Check the percentage of the supplies' life that remains available. |

[Initial Setup]

[All Settings] > [Initial Setup]

| Level 3 | Level 4 | Descriptions |
|----------------|--------------------|-----------------------------------------------------------------------------------------------------------------------------------------------------------------------------------------------------------|
| Date & Time | Date | Add the date and time on the screen and in the headings of the faxes you send. |
| | Time | |
| | Clock Type | Select the time format (12-hour or 24-hour). |
| | Auto Daylight | Set the machine to change automatically for Daylight Saving Time. |
| | Time Zone | Set your time zone. |
| Station ID | Fax | Enter your name and fax number so it appears on each page you fax. |
| | Tel | |
| | Name | |
| Tone/Pulse | - | Select the dialling mode. |
| Dial Tone | - | Shorten the dial tone detection pause. |
| Phone Line Set | - | Select the telephone line type. |
| Compatibility | - | Adjust the equalisation for transmission difficulties. VoIP service providers offer fax support using various standards. If you regularly experience fax transmission errors, select Basic (for VoIP). |
| Reset | Machine Reset | Restore all the machine settings that you have changed. |
| | Network Reset | Restore all network settings back to the factory settings. |
| | Address Book & Fax | Erase all stored phone numbers and fax settings. |
| | All Settings | Restore all the machine's settings back to the factory settings. |

| Level 3 | Level 4 | Descriptions |
|--------------------------------------------------------|---------------|----------------------------------------------------|
| Reset | Factory Reset | Restore all settings back to the factory settings. |
| Local Language (Available only for some countries.) | - | Change your LCD language. |



Related Information

- [Settings and Features Tables](#)
-

Settings Tables (2.7" Touch Panel DCP models)

Related Models: DCP-L2660DW/DCP-L2665DW

```
>> [Settings]
>> [General Setup]
>> [Shortcut Settings]
>> [Printer]
>> [Network]
>> [Print Reports]
>> [Machine Info.]
>> [Initial Setup]
```

[Settings]



[Settings]

| Level 1 | Level 2 | Descriptions |
|--------------|-----------------------|------------------------------------------------------------------------------------------------------------|
| Toner | Toner Life | View the approximate remaining toner life. |
| | Test Print | Print a test page. |
| | Toner Cartridge Check | View the installed toner cartridge information on the LCD, for example, if the toner cartridge is genuine. |
| Network | Wired LAN | Access the Wired LAN setting menus. |
| | WLAN (Wi-Fi) | Access the WLAN setting menus. |
| Tray Setting | - | Access the tray setting menus. |
| Wi-Fi Direct | - | Access the Wi-Fi Direct setting menus. |
| Eco Mode | - | Access the Eco Mode setting menu. |
| All Settings | - | Configure the detailed settings. |

[General Setup]

[All Settings] > [General Setup]

| Level 3 | Level 4 | Level 5 | Descriptions |
|--------------|----------------|----------|-------------------------------------------------------------------------------------------------------------------------------------------------------------------------|
| Tray Setting | Paper Type | - | Set the type of paper in the paper tray. |
| | Paper Size | - | Set the paper size in the paper tray. |
| | Print Position | X Offset | Move the print start position (at the upper left corner of pages) horizontally from -500 (left) to +500 (right) dots in 300 dpi. |
| | | Y Offset | Move the print start position (at the upper left corner of pages) vertically from -500 (up) to +500 (down) dots in 300 dpi. |
| | Check Paper | - | Select whether to display a message telling you to check that the size and type of the paper in the machine and the machine's Paper Size and Paper Type settings match. |
| Beep | - | - | Adjust the beeper volume. |
| LCD Settings | Backlight | - | Adjust the brightness of the LCD backlight. |
| | Dim Timer | - | Set how long the LCD backlight stays on after returning to the Home screen. |

| Level 3 | Level 4 | Level 5 | Descriptions |
|-----------------|---------------------|------------|-------------------------------------------------------------------------------------------------------------------------------------------------------------------------------------------------------------------------------------------------------------------------------------------------------------------|
| Screen Settings | Home Screen | - | Set the Main Home screen. |
| | Scan Screen | - | Set the default Scan screen settings. |
| | Display Information | IP Address | Select whether or not to display your machine's IP Address on the Home screens. |
| Ecology | Eco Mode | - | Turn the following machine settings on at the same time: <ul style="list-style-type: none"> • 2-sided Print:Long Edge¹(available for certain models) • Sleep Time:0 Min • Dim Timer:10 Secs • Quiet Mode:On¹ • Toner Save:On¹ |
| | Toner Save | - | Increase the page yield of the toner cartridge. |
| | Sleep Time | - | Set the number of minutes before the machine enters Sleep mode. |
| | Quiet Mode | - | Decrease printing noise. |
| | Auto Power Off | - | Set the number of hours that the machine will remain in Deep Sleep mode before going into Power Off mode. Choose Off if you do not want the machine to go into Power Off mode. |
| Replace Toner | - | - | Set the machine to continue printing after the LCD displays Replace Toner. |

¹ Changing this setting is possible only after you change certain machine settings in Web Based Management.

[Shortcut Settings]

[All Settings] > [Shortcut Settings]

| Level 3 | Level 4 | Descriptions |
|---------------------------|---------|-------------------------------|
| (Select shortcut button.) | Rename | Change the shortcut name. |
| | Edit | Change the shortcut settings. |
| | Delete | Delete the shortcut. |

[Printer]

[All Settings] > [Printer]

| Level 3 | Level 4 | Level 5 | Descriptions |
|----------------|---------------|-------------|-----------------------------------------------------------------------------------------------------------------|
| Emulation | - | - | Select the emulation mode. |
| Resolution | - | - | Select a print resolution. |
| Density | - | - | Increase or decrease the print density. |
| Print Settings | - | - | Set your print settings to Text or Graphics. |
| Print Options | Font List | HP LaserJet | Print a list of the machine's internal fonts. |
| | | BR-Script 3 | |
| | Test Print | - | Print a test page. |
| 2-sided | 2-sided Print | - | Enable or disable 2-sided printing and choose long edge or short edge. |
| | Single Image | - | For a print job where the last page is a 1-sided image, select the 1-sided Feed option to reduce printing time. |

| Level 3 | Level 4 | Level 5 | Descriptions |
|----------------|-------------------|-----------------------------------------------------------------------------|---------------------------------------------------------------------------------------------------------------|
| Auto Continue | - | - | Select this setting if you want the machine to clear paper size errors, and to use the paper in the tray. |
| Paper Type | - | - | Set the paper type. |
| Paper Size | - | - | Set the paper size. |
| Copies | - | - | Set the number of printed pages. |
| Orientation | - | - | Set pages to print in either portrait or landscape orientation. |
| Print Position | - | - | Access the Print Position setting menus. |
| Auto FF | - | - | Allow the machine to print any remaining data automatically. |
| HP LaserJet | Font No. | Font No. | Set the font number. |
| | | Soft Font No. | Set the soft font number. This menu appears if a soft font is installed on your Brother machine. |
| | Font Pitch | - | Set the font pitch. (Available only for certain fonts.) |
| | Font Point | - | Set the font size. (Available only for certain fonts.) |
| | Symbol Set | - | Select the symbol or character set. |
| | Table Print | - | Print the code table. |
| | Auto LF | - | ON: CR -> CR+LF, OFF: CR -> CR |
| | Auto CR | - | ON: LF -> LF+CR, FF -> FF+CR, or VT -> VT+CR OFF: LF -> LF, FF -> FF, or VT -> VT |
| | Auto WRAP | - | Select whether you want a line feed and carriage return when the carriage position reaches the right margin. |
| | Auto SKIP | - | Select whether you want a line feed and carriage return when the carriage position reaches the bottom margin. |
| | Left Margin | - | Set the left margin at column 0 to 70 columns at 1 cpi. |
| | Right Margin | - | Set the right margin at column 10 to 80 columns at 1 cpi. |
| | Top Margin | - | Set the top margin distance from the top edge of the paper. |
| | Bottom Margin | - | Set the bottom margin distance from the bottom edge of the paper. |
| | Lines | - | Set the number of lines on each page. |
| Tray Command | - | Select this setting if a tray mismatch appears when you use the HP drivers. | |
| BR-Script 3 | Error Print | - | Choose whether the machine prints the error information when errors occur. |
| PDF | Multiple Page | - | Set the page layout when printing multiple pages. |
| | PDF Print Options | - | Set the PDF Print setting to print either comments (Markup) or stamps in the PDF file, along with the text. |
| | PDF Fit to Page | - | Select if the machine scales or resizes the pages in the PDF file to fit the selected paper size. |
| Reset Printer | - | - | Restore the machine settings to the factory settings. |

[Network]

[All Settings] > [Network]

| Level 3 | Level 4 | Level 5 | Level 6 | Descriptions |
|----------------|--------------------|--------------------|---------------------------------------------------------------------------------------------|------------------------------------------------------|
| Wired LAN | TCP/IP | Boot Method | - | Select the Boot method that best suits your needs. |
| | | IP Address | - | Enter the IP address. |
| | | Subnet Mask | - | Enter the Subnet mask. |
| | | Gateway | - | Enter the Gateway address. |
| | | Node Name | - | Enter the Node name. (up to 32 characters) |
| | | WINS Configuration | - | Select the WINS configuration mode. |
| | | WINS Server | Primary | Specify the IP address of the primary WINS server. |
| | | | Secondary | Specify the IP address of the secondary WINS server. |
| | | DNS Server | Primary | Specify the IP address of the primary DNS server. |
| | | | Secondary | Specify the IP address of the secondary DNS server. |
| | APIPA | - | Set the machine to allocate the IP address from the link-local address range automatically. | |
| | IPv6 | - | Turn the IPv6 protocol on or off. | |
| | Ethernet | - | - | Select the Ethernet link mode. |
| | Wired Status | - | - | View the current wired status. |
| | MAC Address | - | - | View the machine's MAC address. |
| Set to Default | - | - | Restore the wired network settings to the factory settings. | |
| Wired Enable | - | - | Turn the Wired LAN interface on or off manually. | |
| WLAN (Wi-Fi) | Find Wi-Fi Network | - | - | Configure your wireless network settings manually. |
| | TCP/IP | Boot Method | - | Select the Boot method that best suits your needs. |
| | | IP Address | - | Enter the IP address. |
| | | Subnet Mask | - | Enter the Subnet mask. |
| | | Gateway | - | Enter the Gateway address. |
| | | Node Name | - | Enter the Node name. (up to 32 characters) |
| | | WINS Configuration | - | Select the WINS configuration mode. |
| | | WINS Server | Primary | Specify the IP address of the primary WINS server. |
| | | | Secondary | Specify the IP address of the secondary WINS server. |
| | | DNS Server | Primary | Specify the IP address of the primary DNS server. |

| Level 3 | Level 4 | Level 5 | Level 6 | Descriptions |
|----------------------|-----------------|------------------|-----------|-----------------------------------------------------------------------------------------------------------------------------------------|
| WLAN (Wi-Fi) | TCP/IP | DNS Server | Secondary | Specify the IP address of the secondary DNS server. |
| | | APIPA | - | Set the machine to allocate the IP address from the link-local address range automatically. |
| | | IPv6 | - | Turn the IPv6 protocol on or off. |
| | WPS/Push Button | - | - | Configure your wireless network settings using the one-button push method. |
| | WPS/PIN Code | - | - | Configure your wireless network settings using WPS with a PIN. |
| | Recover WLAN | - | - | Reset and restart your wireless network. |
| | WLAN Status | Status | - | View the current wireless network status. |
| | | Signal | - | View the current wireless network signal strength. |
| | | SSID | - | View the current SSID. |
| | | Comm. Mode | - | View the current Communication mode. |
| | MAC Address | - | - | View the machine's MAC address. |
| | Set to Default | - | - | Restore the wireless network settings to the factory settings. |
| | WLAN Enable | - | - | Turn the WLAN on or off manually. |
| | Wi-Fi Direct | Manual | - | - |
| Group Owner | | - | - | Set your machine as the Group Owner. |
| Push Button | | - | - | Configure your Wi-Fi Direct network settings using the one-button push method. |
| PIN Code | | - | - | Configure your Wi-Fi Direct network settings using WPS with a PIN code. |
| Device Information | | Device Name | - | View your machine's device name. |
| | | SSID | - | View the Group Owner's SSID. When the machine is not connected, the LCD displays Not Connected. |
| | | IP Address | - | View your machine's current IP Address. |
| Status Information | | Status | - | View the current Wi-Fi Direct network status. |
| | | Signal | - | View the current Wi-Fi Direct network signal strength. When your machine acts as Group Owner, the LCD always indicates a strong signal. |
| I/F Enable | | - | - | Turn the Wi-Fi Direct connection on or off. |
| Web Connect Settings | Proxy Settings | Proxy Connection | - | Change the Web connection settings. |
| | | Address | - | |
| | | Port | - | |

| Level 3 | Level 4 | Level 5 | Level 6 | Descriptions |
|----------------------|----------------|-----------|---------|--------------------------------------------------------------------------------------------------------------------------------------------------|
| Web Connect Settings | Proxy Settings | User Name | - | Change the Web connection settings. |
| | | Password | - | |
| Web Based Mgmt | - | - | - | Enable or disable Web Based Management. If you enable this function, make sure you specify the connection method to use Web Based Management. |
| Global Detect | Allow Detect | - | - | Enable or disable Global Detect, a function that detects and notifies the user when the user unintentionally connects to a global network. |
| | Reject Access | - | - | Disable connections to the global network. |
| Network Reset | - | - | - | Restore all network settings back to the factory settings. |

[Print Reports]

[All Settings] > [Print Reports]

| Level 3 | Descriptions |
|-----------------------|-----------------------------------------------------|
| User Settings | Print a list of your User settings. |
| Printer Settings | Print a list of your Printer settings. |
| Network Configuration | Print a list of your Network settings. |
| Print File List | Print a list of data saved in the machine's memory. |
| Drum Dot Print | Print the Drum Dot Check Sheet. |
| WLAN Report | Print the wireless LAN connection results. |

[Machine Info.]

[All Settings] > [Machine Info.]

| Level 3 | Level 4 | Descriptions |
|---------------------|------------------|--------------------------------------------------------------------|
| Serial No. | - | Check your machine's serial number. |
| Firmware Version | Main Version | Check your machine's firmware version. |
| | Sub1 Version | |
| | Security Version | |
| Firmware Update | - | Update your machine to the latest firmware. |
| Firmware Auto Check | - | View firmware information on the Home screen. |
| Page Counter | Total | Check the total number of pages the machine has printed. |
| | Copy | |
| | Print | |
| | Other | |
| Parts Life | Drum | Check the percentage of the supplies' life that remains available. |

[Initial Setup]

[All Settings] > [Initial Setup]

| Level 3 | Level 4 | Descriptions |
|---------------------------------------------------------------|----------------------|------------------------------------------------------------------|
| Reset | Machine Reset | Restore all the machine settings that you have changed. |
| | Network Reset | Restore all network settings back to the factory settings. |
| | All Settings | Restore all the machine's settings back to the factory settings. |
| | Factory Reset | Restore all settings back to the factory settings. |
| Local Language (Available only for some countries.) | - | Change your LCD language. |

Related Information

- [Settings and Features Tables](#)
-

Features Tables (2.7" Touch Panel MFC models and 3.5" Touch Panel MFC models)

Related Models: MFC-L2860DWE/MFC-L2860DW/MFC-L2862DW/MFC-L2922DW/MFC-L2960DW/MFC-L2980DW

- >> [Fax] (When Fax Preview is Off)
- >> [Fax] (When Fax Preview is On)
- >> [Copy]
- >> [Scan]
- >> [Secure Print]
- >> [Web]
- >> [Apps]
- >> [2 in 1 ID Copy]
- >> [Shortcuts]
- >> [Toner]
- >> Wi-Fi Setup (For wireless models)

[Fax] (When Fax Preview is Off)



[Fax]

| Level 3 | Level 4 | Level 5 | Level 6 | Descriptions |
|---------------|-----------------------------------------------------------|----------------------------|---------------|------------------------------------------------------------------------------------------------------------------------------------------------------------------------------------------------------------------------------------------------------------------------------------------------------|
| Redial(Pause) | - | - | - | Redial the last number called. When you are entering a fax or telephone number on the touchscreen, Redial changes to Pause on the LCD. Press Pause when you need a delay while dialling numbers, such as access codes and credit card numbers. You can also store a pause when you set up addresses. |
| Tel(R) | - | - | - | Tel changes to R when PBX is selected as the telephone line type. You can use R to gain access to an outside line or to transfer a call to another extension when connected to a PBX. |
| Address Book | (Search:) | - | - | Search within the Address Book. |
| | Edit | - | - | Store Address Book numbers, set up Group numbers for Broadcasting, change and delete Address Book numbers. |
| | (Select Address Book) | Apply | - | Start sending a fax using the Address Book. |
| Call History | Redial | - | - | Redial the last number you dialled. |
| | Outgoing Call | (Select Outgoing Call) | Edit Apply | Select a number from the Outgoing Call history, and then send a fax to it, add it to the Address Book, or delete it. |
| | Caller ID History (Available only for some countries.) | (Select Caller ID History) | Edit Apply | Select a number from the Caller ID History and then send a fax to it, add it to the Address Book, or delete it. |

| Level 3 | Level 4 | Level 5 | Level 6 | Descriptions |
|-------------------------------------------------------------------------------------------|--------------------------------------------------------|-----------------|------------------------------------------------------------------------------------------------------------|------------------------------------------------------------------------|
| Fax Start | - | - | - | Send a fax. |
|  Options | Fax Resolution | - | - | Set the resolution for outgoing faxes. |
| | Contrast | - | - | Adjust the contrast. |
| | 2-sided Fax (For automatic 2-sided scanning models) | - | - | Set the 2-sided scanning format. |
| | Glass Scan Size | - | - | Adjust the scan area of the scanner glass to the size of the document. |
| | Broadcasting | Add Number | Add Number | Send the same fax message to more than one fax number. |
| | | | Add from Address book | |
| | | | Search in Address book | |
| | Delayed Fax | Delayed Fax | - | Set the time of day the delayed faxes will be sent. |
| | | Set Time | - | |
| | Real Time TX | - | - | Send a fax without using the memory. |
| | Coverpage Setup | Coverpage Setup | - | Set the machine to automatically send a pre-programmed cover page. |
| | | Coverpage Note | - | |
| | | Total Pages | - | |
| | Overseas Mode | - | - | Set to On if you have difficulty sending faxes overseas. |
| Call History | - | - | Select a number from the Call History and then send a fax to it, add it to the Address Book, or delete it. | |
| Address Book | - | - | Select the address of the recipient from the address book. | |
| Set New Default | - | - | Save your settings as the default. | |
| Factory Reset | - | - | Restore all settings back to the factory settings. | |
| Save as Shortcut | - | - | - | Save the current settings as a shortcut. |

[Fax] (When Fax Preview is On)

[Fax]

| Level 3 | Level 4 | Level 5 | Descriptions |
|------------|---------------|---------|------------------------------------------------------------------------------------------------------------------------------------------------------------------------------------------------------------------------------------------------------------------------------------------------------|
| Send a fax | Redial(Pause) | - | Redial the last number called. When you are entering a fax or telephone number on the touchscreen, Redial changes to Pause on the LCD. Press Pause when you need a delay while dialling numbers, such as access codes and credit card numbers. You can also store a pause when you set up addresses. |

| Level 3 | Level 4 | Level 5 | Descriptions |
|----------------|-------------------------------------------------------------------------------------------|------------------------|---------------------------------------------------------------------------------------------------------------------------------------------------------------------------------------|
| Send a fax | Tel(R) | - | Tel changes to R when PBX is selected as the telephone line type. You can use R to gain access to an outside line or to transfer a call to another extension when connected to a PBX. |
| | Address Book | - | Select the address of the recipient from the address book. |
| | Call History | - | Select a number from the Call History and then send a fax to it, add it to the Address Book, or delete it. |
| | Fax Start | - | Send a fax. |
| |  Options | - | Select your settings. |
| | Save as Shortcut | - | Save the current settings as a shortcut. |
| Received Faxes | Print/Delete | Print All (New Faxes) | Print the new received faxes. |
| | | Print All (Old Faxes) | Print the old received faxes. |
| | | Delete All (New Faxes) | Delete the new received faxes. |
| | | Delete All (Old Faxes) | Delete the old received faxes. |
| Address Book | - | - | Select the address of the recipient from the address book. |
| Call History | - | - | Select a number from the Call History and then send a fax to it, add it to the Address Book, or delete it. |

[Copy]



[Copy]





| Level 3 | Level 4 | Level 5 | Descriptions | |
|---------------------------------------------------------------------------------------------|------------------|---------|------------------------------------------------------------------------------------------|-------------------------------------------------------------|
| Start | - | - | Make a monochrome or greyscale copy. | |
| ID | - | - | Make a copy of the ID card. | |
|  Options | Quality | - | Select the Copy resolution for your document type. | |
| | Enlarge/Reduce | 100% | - | |
| | | Enlarge | | Select an enlargement ratio for the next copy. |
| | | Reduce | | Select a reduction ratio for the next copy. |
| | | Auto | | Adjust the copy size to fit on the paper size you have set. |
| | Custom (25-400%) | | Enter an enlargement or reduction ratio. | |
| | Density | - | | Adjust the density. |
| 2-sided Copy (For automatic 2-sided printing models) | Layout | | Turn off or turn on 2-sided copying and select flip on long edge or flip on short edge. | |
| 2-sided Copy Page Layout | - | | Select a page layout option when you make 2-sided N in 1 copies from a 2-sided document. | |





| Level 3 | Level 4 | Level 5 | Descriptions |
|--------------------------------------------------------------------------------------------------|-----------------------------------------|---------|------------------------------------------|
|  Options | (For automatic 2-sided printing models) | | |
| | Contrast | - | Adjust the contrast. |
| | Stack/Sort | - | Select to stack or sort multiple copies. |
| | Page Layout | - | Make N in 1 copies. |
| Save as Shortcut | - | - | Save the current settings as a shortcut. |

[Scan]



[Scan]

| Level 3 | Level 4 | Level 5 | Level 6 | Descriptions |
|-------------------------------------------------------|-----------------------|----------------------------------------------------------------------------------------------------|----------------------------------------------------------------------------------------------------|-----------------------------------------------------------------------------------------------|
| to My E-mail (available for certain models) | - | - | - | Scan a monochrome or a colour document to your email address. |
| to My Folder (available for certain models) | - | - | - | Send scanned data to your folder in the CIFS server on your local network or on the Internet. |
| to PC | to File | Other Scan to Actions (Select USB or PC) |  Options | Scan documents and save them to a folder on your computer. |
| | | | Save as Shortcut | |
| | | | Start | |
| | to OCR | Other Scan to Actions (Select USB or PC) |  Options | Convert your scanned document to an editable text file. |
| | | | Save as Shortcut | |
| | | | Start | |
| | to Image | Other Scan to Actions (Select USB or PC) |  Options | Scan photos or graphics into your graphics applications. |
| | | | Save as Shortcut | |
| | | | Start | |
| | to E-mail | Other Scan to Actions (Select USB or PC) |  Options | Send a scanned document as an email attachment. |
| | | | Save as Shortcut | |
| | | | Start | |
| to Mobile App | (Select Profile name) | Other Scan to Actions | - | Scan documents to a mobile application. |
| | |  Options | - | |

| Level 3 | Level 4 | Level 5 | Level 6 | Descriptions | |
|-----------------------------------------------------------------------------------------------------------------------|-----------------------|---------------------------------------------------------------------------------------------|---------------------------------------------------------------------------------------------|------------------------------------------------------------------------------------------------------------------|-------------------------------------------------------------------------------------------|
| to Mobile App | (Select Profile name) | Save as Shortcut | - | Scan documents to a mobile application. | |
| | | Start | - | | |
| to E-mail Server | Other Scan to Actions | - | - | Send scanned data to an email server by allowing your machine to communicate with your network and email server. | |
| | Manual | Next | Destinations | |  Options |
| | | | | | Save as Shortcut |
| | | | | | Start |
| | | Cancel | | | - |
| | | Add Address | - | | |
| | | (Select destinations) | - | | |
| | | Address Book |  (Search:) | | - |
| | Edit | | - | | |
| | (Select Address Book) | | - | | |
| to FTP (available for certain models) | Other Scan to Actions | - | - | Scan documents directly to an FTP server. | |
| | (Select Profile name) |  Options | - | | |
| | | Save as Shortcut | - | | |
| | | Start | - | | |
| to Network (available for certain models) | Other Scan to Actions | - | - | Send scanned data to a CIFS server on your local network or on the Internet. | |
| | (Select Profile name) |  Options | - | | |
| | | Save as Shortcut | - | | |
| | | Start | - | | |
| to Web (available for certain models) | - | - | - | Upload the scanned data to an Internet service. | |
| WS Scan (Appears when you install a Web Services Scanner, which is displayed in your computer's Network explorer.) | Other Scan to Actions | - | - | Scan data using the Web Service protocol. | |
| | Scan | - | - | | |
| | Scan for E-mail | - | - | | |
| | Scan for Fax | - | - | | |
| | Scan for Print | - | - | | |

[Secure Print]



[Secure Print]

| Level 2 | Level 3 | Level 4 | Descriptions |
|--------------|---------------|---------------------------|--------------------------------------------------------------------------------------------------------------------------------------------------|
| Secure Print | (Select User) | (Select Secure Print Job) | You can print data saved in the machine's memory when you enter your four-digit password. Active only when the machine has secure print data. |

[Web]



[Web]

| Level 2 | Descriptions |
|---------|------------------------------------------------------------------------------------------------------------------------------------------------------------------------------------|
| Web | Connect the Brother machine to an Internet service. Web services may have been added and service names may have been changed by the provider since this document was published. |

[Apps]



[Apps]

| Level 2 | Descriptions |
|---------|----------------------------------------------------------|
| Apps | Connect the Brother machine to the Brother Apps service. |

[2 in 1 ID Copy]



[2 in 1 ID Copy]

| Level 2 | Descriptions |
|----------------|----------------------------------------------------------|
| 2 in 1 ID Copy | Copy both sides of an identification card onto one page. |

[Shortcuts]



[Shortcuts]

| Level 3 | Level 4 | Level 5 | Descriptions | |
|---------|---------------|-----------|-----------------------------------------|------------------------------------------------------------|
| + | Copy | - | Select the settings you want. | |
| | Fax | - | Select the settings you want. | |
| | Scan | to File | | Scan documents and save them to a folder on your computer. |
| | | to OCR | | Convert your scanned document to an editable text file. |
| | | to Image | | Scan photos or graphics into your graphics applications. |
| | | to E-mail | | Send a scanned document as an email attachment. |
| | to Mobile App | | Scan documents to a mobile application. | |

| Level 3 | Level 4 | Level 5 | Descriptions |
|---------------------------------------------------------------------|--------------------------------------------------|-------------------------------------------|------------------------------------------------------------------------------------------------------------------------------------------------------------------------------------|
| + | Scan | to E-mail Server | Send scanned data to an email server by allowing your machine to communicate with your network and email server. |
| | | to Network (available for certain models) | Send scanned data to a CIFS server on your local network or on the Internet. |
| | | to FTP (available for certain models) | Send scanned data via FTP. |
| | Web | - | Connect the Brother machine to an Internet service. Web services may have been added and service names may have been changed by the provider since this document was published. |
| This list appears when each Shortcut name is pressed for 2 seconds. | Apps | - | Connect the Brother machine to the Brother Apps service. |
| | Rename | - | Change the shortcut name. |
| | Edit | - | Change the shortcut settings. |
| | Delete | - | Delete the shortcut. |
| | Register Card/NFC (available for certain models) | - | Assign a shortcut to an ID card. |
| Delete Card/NFC (available for certain models) | - | Remove a shortcut from an ID card. | |

[Toner]

[Toner]

| Level 2 | Level 3 | Descriptions |
|---------------------------------------------------------------------------------------------|-----------------------|------------------------------------------------------------------------------------------------------------|
|  (Toner) | Toner Life | View the approximate remaining toner life. |
| | Test Print | Print a test page. |
| | Toner Cartridge Check | View the installed toner cartridge information on the LCD, for example, if the toner cartridge is genuine. |

Wi-Fi Setup (For wireless models)

(Wi-Fi Setup) (For wireless models)

| Level 2 | Level 3 | Descriptions |
|---------------------------------------------------------------------------------------------------|---------------------------|----------------------------------------------------------------------------|
|  (Wi-Fi Setup) | Find Wi-Fi Network | Configure your wireless network settings manually. |
| | TCP/IP ¹ | Change the TCP/IP settings. |
| | WPS/Push Button | Configure your wireless network settings using the one-button push method. |
| | WPS/PIN Code ¹ | Configure your wireless network settings using WPS with a PIN. |

¹ Available after a Wi-Fi® connection has been configured.

| Level 2 | Level 3 | Descriptions |
|----------------------------------------------------------------------------------------------------|------------------------------------|----------------------------------------------------------------|
|  (Wi-Fi Setup) | Recover WLAN | Reset and restart your wireless network. |
| | WLAN Status ¹ | View the current wireless network status. |
| | MAC Address ¹ | View the machine's MAC address. |
| | Set to Default ¹ | Restore the wireless network settings to the factory settings. |
| | WLAN Enable ¹ | Turn the wireless interface on or off. |



Related Information

- [Settings and Features Tables](#)

Features Tables (2.7" Touch Panel DCP models)

Related Models: DCP-L2660DW/DCP-L2665DW

- >> [Copy]
- >> [Scan]
- >> [Web]
- >> [Apps]
- >> [2 in 1 ID Copy]
- >> [Shortcuts]
- >> [Toner]
- >> Wi-Fi Setup

[Copy]





 [Copy]

| Level 3 | Level 4 | Level 5 | Descriptions |
|--------------------------------------------------------------------------------------------|----------------|------------------------------------------|-----------------------------------------------------------------------------------------|
| Start | - | - | Make a monochrome or greyscale copy. |
| ID | - | - | Make a copy of the ID card. |
|  Options | Quality | - | Select the Copy resolution for your document type. |
| | Enlarge/Reduce | 100% | - |
| | | Enlarge | Select an enlargement ratio for the next copy. |
| | | Reduce | Select a reduction ratio for the next copy. |
| | | Auto | Adjust the copy size to fit on the paper size you have set. |
| | | Custom (25-400%) | Enter an enlargement or reduction ratio. |
| | Density | - | Adjust the density. |
| | 2-sided Copy | Layout | Turn off or turn on 2-sided copying and select flip on long edge or flip on short edge. |
| | Contrast | - | Adjust the contrast. |
| Stack/Sort | - | Select to stack or sort multiple copies. | |
| Page Layout | - | Make N in 1 copies. | |
| Save as Shortcut | - | - | Save the current settings as a shortcut. |

[Scan]

 [Scan]

| Level 3 | Level 4 | Level 5 | Level 4 | Descriptions |
|---------|---------|-----------------------|---------------------------------------------------------------------------------------------|------------------------------------------------------------|
| to PC | to File | Other Scan to Actions | - | Scan documents and save them to a folder on your computer. |
| | | (Select USB or PC) |  Options | |
| | | | Save as Shortcut | |
| | | | Start | |

| Level 3 | Level 4 | Level 5 | Level 4 | Descriptions | |
|------------------------------------------|-----------------------|---------------------------------------------------------------------------------------------|-------------------------------------------------------------------------------------------|---------------------------------------------------------|----------------------------------------------------------|
| to PC | to OCR | Other Scan to Actions | - | Convert your scanned document to an editable text file. | |
| | | (Select USB or PC) |  Options | | |
| | | | Save as Shortcut | | |
| | | Start | | | |
| | to Image | Other Scan to Actions | - | | Scan photos or graphics into your graphics applications. |
| | | (Select USB or PC) |  Options | | |
| | | | Save as Shortcut | | |
| | | Start | | | |
| | to E-mail | Other Scan to Actions | - | | |
| (Select USB or PC) | |  Options | | | |
| | | Save as Shortcut | | | |
| | Start | | | | |
| to Mobile App | (Select Profile name) | Other Scan to Actions | - | Scan documents to a mobile application. | |
| | |  Options | - | | |
| | | Save as Shortcut | - | | |
| | | Start | - | | |
| to FTP (available for certain models) | Other Scan to Actions | - | - | Scan documents directly to an FTP server. | |
| | (Select Profile name) |  Options | - | | |
| | Save as Shortcut | - | - | | |
| | Start | - | - | | |
| to Web | - | - | - | Upload the scanned data to an Internet service. | |
| WS Scan | Other Scan to Actions | - | - | Scan data using the Web Service protocol. | |
| | Scan | - | - | | |
| | Scan for E-mail | - | - | | |
| | Scan for Fax | - | - | | |
| | Scan for Print | - | - | | |

[Web]



[Web]

| Level 2 | Descriptions |
|---------|------------------------------------------------------------------------------------------------------------------------------------------------------------------------------------|
| Web | Connect the Brother machine to an Internet service. Web services may have been added and service names may have been changed by the provider since this document was published. |

[Apps]



[Apps]

| Level 2 | Descriptions |
|---------|----------------------------------------------------------|
| Apps | Connect the Brother machine to the Brother Apps service. |

[2 in 1 ID Copy]



[2 in 1 ID Copy]

| Level 2 | Descriptions |
|----------------|----------------------------------------------------------|
| 2 in 1 ID Copy | Copy both sides of an identification card onto one page. |

[Shortcuts]



Shortcuts

[Shortcuts]

| Level 3 | Level 4 | Level 5 | Descriptions |
|---------------------------------------------------------------------|---------|------------------------------------------------------------------------------------------------------------------------------------------------------------------------------------|------------------------------------------------------------|
| + | Copy | - | Select the settings you want. |
| | Scan | to File | Scan documents and save them to a folder on your computer. |
| | | to OCR | Convert your scanned document to an editable text file. |
| | | to Image | Scan photos or graphics into your graphics applications. |
| | | to E-mail | Send a scanned document as an email attachment. |
| | | to Mobile App | Scan documents to a mobile application. |
| | | to FTP (available for certain models) | Send scanned data via FTP. |
| Web | - | Connect the Brother machine to an Internet service. Web services may have been added and service names may have been changed by the provider since this document was published. | |
| Apps | - | Connect the Brother machine to the Brother Apps service. | |
| This list appears when each Shortcut name is pressed for 2 seconds. | Rename | - | Change the shortcut name. |
| | Edit | - | Change the shortcut settings. |
| | Delete | - | Delete the shortcut. |

[Toner]



[Toner]

| Level 2 | Level 3 | Descriptions |
|---------|------------------------------|------------------------------------------------------------------------------------------------------------|
| (Toner) | Toner Life | View the approximate remaining toner life. |
| | Test Print | Print a test page. |
| | Toner Cartridge Check | View the installed toner cartridge information on the LCD, for example, if the toner cartridge is genuine. |

Wi-Fi Setup



(Wi-Fi Setup)

| Level 2 | Level 3 | Descriptions |
|---------------------------------|----------------------------------------|----------------------------------------------------------------------------|
| (Wi-Fi Setup) | Find Wi-Fi Network | Configure your wireless network settings manually. |
| | TCP/IP ¹ | Change the TCP/IP settings. |
| | WPS/Push Button | Configure your wireless network settings using the one-button push method. |
| | WPS/PIN Code ¹ | Configure your wireless network settings using WPS with a PIN. |
| | Recover WLAN | Reset and restart your wireless network. |
| | WLAN Status ¹ | View the current wireless network status. |
| | MAC Address ¹ | View the machine's MAC address. |
| | Set to Default ¹ | Restore the wireless network settings to the factory settings. |
| WLAN Enable ¹ | Turn the wireless interface on or off. | |



Related Information

- [Settings and Features Tables](#)

¹ Available after a Wi-Fi® connection has been configured.

Change Machine Settings Using Web Based Management

Web Based Management is a utility that uses a standard web browser to manage your machine using the Hyper Text Transfer Protocol (HTTP) or Hyper Text Transfer Protocol over Secure Socket Layer (HTTPS).

- [What is Web Based Management?](#)
- [Access Web Based Management](#)
- [Change the Login Password Using Web Based Management](#)
- [Set Up Your Machine's Address Book Using Web Based Management](#)

What is Web Based Management?

Web Based Management is a utility that uses a standard web browser to manage your machine using the Hyper Text Transfer Protocol (HTTP) or Hyper Text Transfer Protocol over Secure Socket Layer (HTTPS).



- We recommend using the latest version of the following web browsers:
 - Microsoft Edge, Firefox, and Google Chrome™ for Windows
 - Safari, Firefox, and Google Chrome™ for Mac
 - Google Chrome™ for Android™
 - Safari and Google Chrome™ for iOS
- Ensure that JavaScript and Cookies are always enabled, regardless of which browser you use.
- DCP-L2620DW/DCP-L2622DW/DCP-L2627DW/DCP-L2627DWXL/DCP-L2627DWE/DCP-L2640DN/DCP-L2660DW/DCP-L2665DW/MFC-L2802DN/MFC-L2800DW/MFC-L2802DW/MFC-L2827DWXL/MFC-L2827DW/MFC-L2835DW/MFC-L2860DWE/MFC-L2860DW/MFC-L2862DW/MFC-L2922DW/MFC-L2960DW/MFC-L2980DW:

Make sure your machine is On and connected to the same network as your computer, and that your network supports the TCP/IP protocol.

<

Logout

Home

Status

Auto Refresh Interval

General

Address Book

Fax

Copy

Print

Scan

Administrator

Online Functions

Network

Status

Device Status

Ready

Automatic Refresh

Off

On

Toner Level

BK

Web Language

Auto ▼

Device Location

Contact :

Location :

The actual screen may differ from the screen shown above.

✔ Related Information

- [Change Machine Settings Using Web Based Management](#)

Access Web Based Management

- We recommend using the latest version of the following web browsers:
 - Microsoft Edge, Firefox, and Google Chrome™ for Windows
 - Safari, Firefox, and Google Chrome™ for Mac
 - Google Chrome™ for Android™
 - Safari and Google Chrome™ for iOS
- Ensure that JavaScript and Cookies are always enabled, regardless of which browser you use.
- DCP-L2620DW/DCP-L2622DW/DCP-L2627DW/DCP-L2627DWXL/DCP-L2627DWE/DCP-L2640DN/DCP-L2660DW/DCP-L2665DW/MFC-L2802DN/MFC-L2800DW/MFC-L2802DW/MFC-L2827DWXL/MFC-L2827DW/MFC-L2835DW/MFC-L2860DWE/MFC-L2860DW/MFC-L2862DW/MFC-L2922DW/MFC-L2960DW/MFC-L2980DW:

We recommend using the HTTPS security protocol when configuring settings using Web Based Management. If you use HTTP when configuring settings using Web Based Management, follow the screen prompts to switch to a secure HTTPS connection.

- DCP-L2620DW/DCP-L2622DW/DCP-L2627DW/DCP-L2627DWXL/DCP-L2627DWE/DCP-L2640DN/DCP-L2660DW/DCP-L2665DW/MFC-L2802DN/MFC-L2800DW/MFC-L2802DW/MFC-L2827DWXL/MFC-L2827DW/MFC-L2835DW/MFC-L2860DWE/MFC-L2860DW/MFC-L2862DW/MFC-L2922DW/MFC-L2960DW/MFC-L2980DW:

When you use HTTPS for Web Based Management configuration, your browser will display a warning dialog box. To avoid displaying the warning dialog box, you can install a self-signed certificate to use SSL/TLS communication. For more information, see *Related Information*.

- The default password to manage this machine's settings is located on the back of the machine and marked "Pwd". Change the default password by following the on-screen instructions when you first log in. We recommend immediately changing the default password to protect your machine from unauthorised access.

DCP-L2620DW/DCP-L2622DW/DCP-L2627DW/DCP-L2627DWXL/DCP-L2627DWE/DCP-L2640DN/DCP-L2660DW/DCP-L2665DW/MFC-L2802DN/MFC-L2800DW/MFC-L2802DW/MFC-L2827DWXL/MFC-L2827DW/MFC-L2835DW/MFC-L2860DWE/MFC-L2860DW/MFC-L2862DW/MFC-L2922DW/MFC-L2960DW/MFC-L2980DW:

You can also find the default password in the Network Configuration Report.

- >> [Access Web Based Management from your Web Browser](#)
- >> [Access Web Based Management from Brother iPrint&Scan \(Windows/Mac\)](#)
- >> [Access Web Based Management from Brother Utilities \(Windows\)](#)

Access Web Based Management from your Web Browser

1. Start your web browser.
2. Type "https://machine's IP address" in your browser's address bar (where "machine's IP address" is your machine's IP address).

For example:

https://192.168.1.2



- If you are using a Domain Name System or enable a NetBIOS name, you can type another name, such as "SharedPrinter" instead of the IP address.

For example: https://SharedPrinter

- If you enable a NetBIOS name, you can also use the node name.



For example: https://brn123456abcdef

- The NetBIOS name can be found in the Network Configuration Report.

3. If required, type the password in the **Login** field, and then click **Login**.



The default password to manage this machine's settings is located on the back of the machine and marked "Pwd". Change the default password by following the on-screen instructions when you first log in.



4. If you want to pin the navigation bar to the left side of the screen, click  and then click .

You can now change the machine's settings.



If the machine is idle for a specified amount of time, the user is automatically logged out. Change the logout settings in the **Logout Time** menu.

Access Web Based Management from Brother iPrint&Scan (Windows/Mac)

1. Start Brother iPrint&Scan.
 - Windows
Launch  (**Brother iPrint&Scan**).
 - Mac
In the **Finder** menu bar, click **Go > Applications**, and then double-click the iPrint&Scan icon.
The Brother iPrint&Scan screen appears.
2. If your Brother machine is not selected, click the **Select your Machine** button, and then select your model name from the list. Click **OK**.
3. Click  (**Supplies/Machine Settings**).
4. Click **All Settings**.
The Web Based Management page appears.
5. If required, type the password in the **Login** field, and then click **Login**.



The default password to manage this machine's settings is located on the back of the machine and marked "Pwd". Change the default password by following the on-screen instructions when you first log in.

6. If you want to pin the navigation bar to the left side of the screen, click  and then click .

You can now change the machine's settings.



You can also access Web Based Management from Brother Mobile Connect for mobile devices.

Access Web Based Management from Brother Utilities (Windows)

1. Launch  (**Brother Utilities**), and then click the drop-down list and select your model name (if not already selected).
2. Click **Tools** in the left navigation bar, and then click **Machine Settings**.
The Web Based Management page appears.
3. If required, type the password in the **Login** field, and then click **Login**.



The default password to manage this machine's settings is located on the back of the machine and marked "Pwd". Change the default password by following the on-screen instructions when you first log in.

4. If you want to pin the navigation bar to the left side of the screen, click  and then click .

You can now change the machine's settings.

DCP-L2620DW/DCP-L2622DW/DCP-L2627DW/DCP-L2627DWXL/DCP-L2627DWE/DCP-L2640DN/
DCP-L2660DW/DCP-L2665DW/MFC-L2802DN/MFC-L2800DW/MFC-L2802DW/MFC-L2827DWXL/
MFC-L2827DW/MFC-L2835DW/MFC-L2860DWE/MFC-L2860DW/MFC-L2862DW/MFC-L2922DW/
MFC-L2960DW/MFC-L2980DW:

If you change the protocol settings, you must restart the machine after clicking **Submit** to activate the configuration.

After configuring the settings, click **Logout**.



Related Information

- [Change Machine Settings Using Web Based Management](#)

Related Topics:

- [Print the Network Configuration Report](#)
 - [Create a Self-signed Certificate](#)
 - [Install the Self-signed Certificate for Windows Users as Administrators](#)
 - [Use SSL/TLS](#)
-

Change the Login Password Using Web Based Management

The default password to manage this machine's settings is located on the back of the machine and marked "Pwd". Change the default password by following the on-screen instructions when you first log in. We recommend immediately changing the default password to protect your machine from unauthorised access.

1. Start your web browser.
2. Type "https://machine's IP address" in your browser's address bar (where "machine's IP address" is your machine's IP address).

For example:

https://192.168.1.2



- If you are using a Domain Name System or enable a NetBIOS name, you can type another name, such as "SharedPrinter" instead of the IP address.

For example: https://SharedPrinter

- If you enable a NetBIOS name, you can also use the node name.

For example: https://brn123456abcdef

- The NetBIOS name can be found in the Network Configuration Report.

3. Do one of the following:
 - If you have previously set your own password, type it, and then click **Login**.
 - If you have not previously set your own password, type the default login password, and then click **Login**.
4. In the left navigation bar, click **Administrator > Login Password**.



- The default password to manage this machine's settings is located on the back of the machine and marked "Pwd".

- If the left navigation bar is not visible, start navigating from ☰.

5. To change the password, type your current password in the **Enter Old Password** field.
6. Following the on-screen **Login Password** guidelines, type your new password in the **Enter New Password** field.
7. Retype the new password in the **Confirm New Password** field.
8. Click **Submit**.



You can also change the lockout settings in the **Login Password** menu.



Related Information

- [Change Machine Settings Using Web Based Management](#)

Related Topics:

- [Check Your Machine's Password](#)

Set Up Your Machine's Address Book Using Web Based Management

Related Models: MFC-L2802DN/MFC-L2800DW/MFC-L2802DW/MFC-L2827DWXL/MFC-L2827DW/MFC-L2835DW/MFC-L2860DWE/MFC-L2860DW/MFC-L2862DW/MFC-L2922DW/MFC-L2960DW/MFC-L2980DW

- We recommend using the HTTPS security protocol when configuring settings using Web Based Management.
- When you use HTTPS for Web Based Management configuration, your browser will display a warning dialog box.

1. Start your web browser.
2. Type "https://machine's IP address" in your browser's address bar (where "machine's IP address" is your machine's IP address).

For example:

https://192.168.1.2



- If you are using a Domain Name System or enable a NetBIOS name, you can type another name, such as "SharedPrinter" instead of the IP address.

For example: https://SharedPrinter

- If you enable a NetBIOS name, you can also use the node name.

For example: https://brn123456abcdef

- The NetBIOS name can be found in the Network Configuration Report.

3. If required, type the password in the **Login** field, and then click **Login**.



The default password to manage this machine's settings is located on the back of the machine and marked "**Pwd**". Change the default password by following the on-screen instructions when you first log in.

4. In the left navigation bar, click **Address Book**.



If the left navigation bar is not visible, start navigating from ☰.

5. Click the target address numbers, and then add or update the Address Book information as needed.
6. Click **Submit**.



Related Information

- [Change Machine Settings Using Web Based Management](#)

Appendix

- [Specifications](#)
- [Supplies](#)
- [Environmental and Compliance Information](#)
- [Brother Help and Customer Support](#)

Specifications

- >> General Specifications
- >> Document Size Specification
- >> Print Media Specifications
- >> Fax Specifications
- >> Copy Specification
- >> Scanner Specifications
- >> Printer Specifications
- >> Interface Specifications
- >> Supported Protocols and Security Features
- >> Computer Requirements Specifications

General Specifications

| | | |
|---------------------------------------|------------------------------|----------------------------------------------------------------------------------------------------------------------------------------------------------------------------------------------------------------------------------------------------------------------------------------------------------------------------------------------------------------------------------------------------------------------------------------------------------------------------------------------------------|
| Printer Type | | Laser |
| Print Method | | Electrophotographic Laser Printer |
| Memory Capacity | Standard | <ul style="list-style-type: none"> • (DCP-L2600D/DCP-L2620DW/DCP-L2627DW/DCP-L2627DWXL/DCP-L2627DWE/MFC-L2802DN/MFC-L2800DW/MFC-L2802DW/MFC-L2827DWXL/MFC-L2827DW/MFC-L2835DW) 128 MB • (DCP-L2622DW/DCP-L2640DN/DCP-L2660DW/DCP-L2665DW/MFC-L2860DWE/MFC-L2860DW/MFC-L2862DW/MFC-L2922DW/MFC-L2960DW/MFC-L2980DW) 256 MB |
| Liquid Crystal Display (LCD) | | <ul style="list-style-type: none"> • (DCP-L2600D/DCP-L2620DW/DCP-L2622DW/DCP-L2627DW/DCP-L2627DWXL/DCP-L2627DWE/DCP-L2640DN/MFC-L2802DN/MFC-L2800DW/MFC-L2802DW/MFC-L2827DWXL/MFC-L2827DW/MFC-L2835DW) 16 characters x 2 lines • (DCP-L2660DW/DCP-L2665DW/MFC-L2860DWE/MFC-L2860DW/MFC-L2862DW) 2.7 in. (67.5 mm) TFT Colour touchscreen LCD ¹ • (MFC-L2922DW/MFC-L2960DW/MFC-L2980DW) 3.5 in. (87.6 mm) TFT Colour touchscreen LCD ¹ |
| Power Source | | 220 V to 240 V AC 50/60 Hz |
| Power Consumption (Average) | Peak | <ul style="list-style-type: none"> • (DCP-L2600D/DCP-L2620DW/DCP-L2622DW/DCP-L2627DW/DCP-L2627DWXL/DCP-L2627DWE/DCP-L2640DN/DCP-L2660DW/DCP-L2665DW/MFC-L2802DN/MFC-L2800DW/MFC-L2802DW/MFC-L2827DWXL/MFC-L2827DW/MFC-L2835DW/MFC-L2860DWE/MFC-L2860DW/MFC-L2862DW/MFC-L2922DW) Approximately 920 W • (MFC-L2960DW/MFC-L2980DW) Approximately 870 W |
| | Printing ² | <ul style="list-style-type: none"> • (DCP-L2600D/DCP-L2620DW/DCP-L2622DW/DCP-L2627DW/DCP-L2627DWXL/DCP-L2627DWE/DCP-L2640DN/DCP-L2660DW/DCP-L2665DW/MFC-L2802DN/MFC-L2800DW/MFC-L2802DW/MFC-L2827DWXL/MFC-L2827DW/MFC-L2835DW/MFC-L2860DWE/MFC-L2860DW/MFC-L2862DW/MFC-L2922DW) |

| | | |
|---------------------------------------|-------------------------------------------|---------------------------------------------------------------------------------------------------------------------------------------------------------------------------------------------------------------------------------------------------------------------------------------------------------------------------------------------------------------------------------------------------------------------------------------------------------------------------------------------------------------------------------------|
| Power Consumption (Average) | | <p>Approximately 470 W at 25°C</p> <ul style="list-style-type: none"> (MFC-L2960DW/MFC-L2980DW) <p>Approximately 485 W at 25°C</p> |
| | Printing (Quiet Mode) ² | <ul style="list-style-type: none"> (DCP-L2600D/DCP-L2620DW/DCP-L2622DW/DCP-L2627DW/DCP-L2627DWXL/DCP-L2627DWE/DCP-L2640DN/DCP-L2660DW/DCP-L2665DW/MFC-L2802DN/MFC-L2800DW/MFC-L2802DW/MFC-L2827DWXL/MFC-L2827DW/MFC-L2835DW/MFC-L2860DWE/MFC-L2860DW/MFC-L2862DW/MFC-L2922DW) <p>Approximately 270 W at 25°C</p> <ul style="list-style-type: none"> (MFC-L2960DW/MFC-L2980DW) <p>Approximately 220 W at 25°C</p> |
| | Copying ² | <ul style="list-style-type: none"> (DCP-L2620DW/DCP-L2627DW/DCP-L2627DWXL/DCP-L2627DWE/MFC-L2802DN/MFC-L2800DW/MFC-L2802DW/MFC-L2827DWXL/MFC-L2827DW/MFC-L2835DW) <p>Approximately 480 W at 25°C</p> <ul style="list-style-type: none"> (DCP-L2600D/DCP-L2622DW/DCP-L2640DN/DCP-L2660DW/DCP-L2665DW/MFC-L2860DWE/MFC-L2860DW/MFC-L2862DW/MFC-L2922DW) <p>Approximately 490 W at 25°C</p> <ul style="list-style-type: none"> (MFC-L2960DW/MFC-L2980DW) <p>Approximately 495 W at 25°C</p> |
| | Copying (Quiet Mode) ² | <ul style="list-style-type: none"> (DCP-L2600D/DCP-L2620DW/DCP-L2622DW/DCP-L2627DW/DCP-L2627DWXL/DCP-L2627DWE/DCP-L2640DN/DCP-L2660DW/DCP-L2665DW/MFC-L2802DN/MFC-L2800DW/MFC-L2802DW/MFC-L2827DWXL/MFC-L2827DW/MFC-L2835DW/MFC-L2860DWE/MFC-L2860DW/MFC-L2862DW/MFC-L2922DW) <p>Approximately 280 W at 25°C</p> <ul style="list-style-type: none"> (MFC-L2960DW/MFC-L2980DW) <p>Approximately 220 W at 25°C</p> |
| | Ready ² | <ul style="list-style-type: none"> (DCP-L2600D/DCP-L2620DW/DCP-L2622DW/DCP-L2627DW/DCP-L2627DWXL/DCP-L2627DWE/DCP-L2640DN/DCP-L2660DW/DCP-L2665DW/MFC-L2802DN/MFC-L2800DW/MFC-L2802DW/MFC-L2827DWXL/MFC-L2827DW/MFC-L2835DW/MFC-L2860DWE/MFC-L2860DW/MFC-L2862DW/MFC-L2922DW) <p>Approximately 43 W at 25°C</p> <ul style="list-style-type: none"> (MFC-L2960DW/MFC-L2980DW) <p>Same as Sleep mode.</p> |
| | Sleep ² | <ul style="list-style-type: none"> (DCP-L2600D/DCP-L2620DW/DCP-L2622DW/DCP-L2627DW/DCP-L2627DWXL/DCP-L2627DWE/DCP-L2640DN/DCP-L2660DW/DCP-L2665DW/MFC-L2802DN/MFC-L2800DW/MFC-L2802DW/MFC-L2827DWXL/MFC-L2827DW/MFC-L2835DW/MFC-L2860DWE/MFC-L2860DW/MFC-L2862DW/MFC-L2922DW) <p>Approximately 4.1 W</p> <ul style="list-style-type: none"> (MFC-L2960DW/MFC-L2980DW) <p>Approximately 3.3 W</p> |
| | Deep Sleep ² | <ul style="list-style-type: none"> (DCP-L2600D) <p>Approximately 0.5 W</p> |

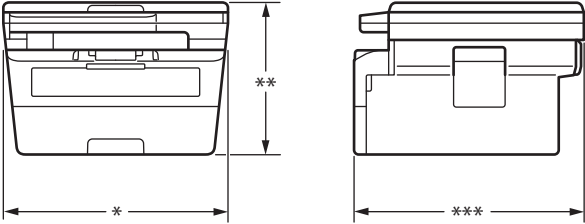
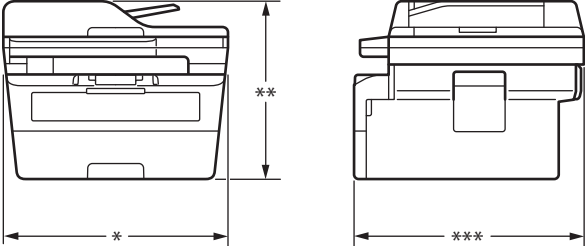
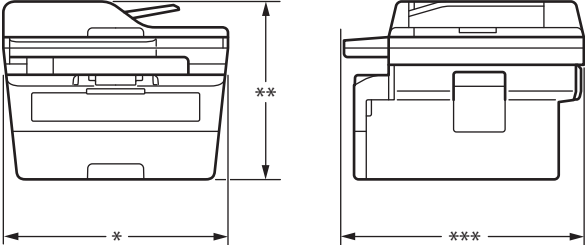
| | | |
|--------------------------------------------------------------------------------------------------------------------------------------------------------------------------------------------------------------------------------------------------------------------------------------------------------------------------------------------------------------------------------------------------------------------------------------------------------------------------------------------------------------------------------------------------------------------------------------------------------|-----------------------------------------|---------------------------------------------------------------------------------------------------------------------------------------------------------------------------------------------------------------------------------------------------------------------------------------------------------------------------------------------------------------------------------------------------------------------------------------------------------------------------------|
| <p>Power Consumption (Average)</p> | | <ul style="list-style-type: none"> (DCP-L2620DW/DCP-L2622DW/DCP-L2627DW/DCP-L2627DWXL/DCP-L2627DWE/DCP-L2640DN/MFC-L2802DN/MFC-L2800DW/MFC-L2802DW/MFC-L2827DWXL/MFC-L2827DW/MFC-L2835DW) Approximately 0.6 W (DCP-L2660DW/DCP-L2665DW/MFC-L2860DWE/MFC-L2860DW/MFC-L2862DW/MFC-L2922DW/MFC-L2960DW/MFC-L2980DW) Approximately 0.7 W |
| | <p>Power Off^{2 3 4}</p> | <p>Approximately 0.08 W</p> |
| <p>Dimensions (Typical outline view) (DCP-L2600D/DCP-L2620DW/DCP-L2622DW/DCP-L2627DW/DCP-L2627DWXL/DCP-L2627DWE)</p>  <p>(DCP-L2640DN/DCP-L2660DW/DCP-L2665DW/MFC-L2802DN/MFC-L2800DW/MFC-L2802DW/MFC-L2827DWXL/MFC-L2827DW/MFC-L2835DW/MFC-L2860DWE/MFC-L2860DW/MFC-L2862DW)</p>  <p>(MFC-L2922DW/MFC-L2960DW/MFC-L2980DW)</p>  | | <p>Unit: mm</p> <ul style="list-style-type: none"> (DCP-L2600D/DCP-L2620DW/DCP-L2622DW/DCP-L2627DW/DCP-L2627DWXL/DCP-L2627DWE) * : 410 ** : 272 *** : 399 (DCP-L2640DN/DCP-L2660DW/DCP-L2665DW/MFC-L2802DN/MFC-L2800DW/MFC-L2802DW/MFC-L2827DWXL/MFC-L2827DW/MFC-L2835DW/MFC-L2860DWE/MFC-L2860DW/MFC-L2862DW) * : 410 ** : 319 *** : 399 (MFC-L2922DW/MFC-L2960DW/MFC-L2980DW) * : 410 ** : 319 *** : 421 |
| <p>Weight (with supplies)</p> | | <ul style="list-style-type: none"> (DCP-L2600D/DCP-L2620DW/DCP-L2622DW/DCP-L2627DW/DCP-L2627DWE) 10.1 kg (DCP-L2627DWXL) 11.2 kg (DCP-L2640DN/DCP-L2660DW/DCP-L2665DW) 11.4 kg (MFC-L2802DN/MFC-L2800DW/MFC-L2802DW/MFC-L2827DW/MFC-L2835DW/MFC-L2860DWE/MFC-L2860DW/MFC-L2862DW) 11.6 kg (MFC-L2922DW) 11.8 kg (MFC-L2960DW/MFC-L2980DW) |

| | | | |
|------------------------------------------------------------------------------------------------------------------------------------------------------------------------------------------------------------------------------------|----------------------------|-----------------------------------|---------------------------------------------------------------------------------------------------------------------------------------------------------------------------------------------------------------------------------------------------------------------------------------------------------------------------------------------------------------------------------------|
| | | | 12.4 kg • (MFC-L2827DWXL) 12.7 kg |
| Noise Level | Sound Pressure 5 | Printing | LpAm = 49 dB (A) |
| | | Printing (Quiet Mode) | LpAm = 44 dB (A) |
| | | Ready | LpAm = 30 dB(A) |
| | Sound Power | Printing 5 | <ul style="list-style-type: none"> (DCP-L2600D/DCP-L2620DW/DCP-L2622DW/DCP-L2627DW/DCP-L2627DWXL/DCP-L2627DWE/DCP-L2640DN/DCP-L2660DW/DCP-L2665DW/MFC-L2802DN/MFC-L2800DW/MFC-L2802DW/MFC-L2827DWXL/MFC-L2827DW/MFC-L2835DW/MFC-L2860DWE/MFC-L2860DW/MFC-L2862DW/MFC-L2922DW) LWAc = 6.63 B (A) (MFC-L2960DW/MFC-L2980DW) LWAc = 6.78 B (A) |
| | | Printing (Quiet Mode) | LWAc = 6.12 B (A) |
| | | Ready | LWAc = Inaudible |
| Temperature | Operating | From 10°C to 32.5°C | |
| | Storage | From 0°C to 40°C | |
| Humidity | Operating | 20% to 80% (without condensation) | |
| | Storage | 35% to 85% (without condensation) | |
| Automatic Document Feeder (ADF) (DCP-L2640DN/DCP-L2660DW/DCP-L2665DW/MFC-L2802DN/MFC-L2800DW/MFC-L2802DW/MFC-L2827DWXL/MFC-L2827DW/MFC-L2835DW/MFC-L2860DWE/MFC-L2860DW/MFC-L2862DW/MFC-L2922DW/MFC-L2960DW/MFC-L2980DW) | | | Up to 50 sheets For best results we recommend: <ul style="list-style-type: none"> Temperature: 20°C to 30°C Humidity: 50% to 70% Paper: 80 g/m² |

1 Measured diagonally.

2 Measured when the machine is connected with the same network connection as the ENERGY STAR Ver. 3.1 test method.

3 Measured according to IEC 62301 Edition 2.0.

4 Power consumption varies slightly depending on the usage environment.

5 Measured in accordance with the method described in ISO 7779.

Document Size Specification

| | | |
|----------------------|-----------------------------|----------------------|
| Document Size | ADF Width 1 | 105 mm to 215.9 mm |
| | ADF Length 1 | 147.3 mm to 355.6 mm |
| | Scanner Glass Width | Maximum 215.9 mm |
| | Scanner Glass Length | Maximum 300 mm |

1 ADF models only

Print Media Specifications

| | | | |
|--------------------|------------------------------|-------------------|-----------------------------------------------------------------------------------------------------------------------|
| Paper Input | Paper Tray (Standard) | Paper Type | Plain Paper, Thin Paper, Recycled Paper, Thick Paper |
| | | Paper Size | A4, Letter, B5 (JIS), B5 (ISO), A5, A5 (Long Edge), B6 (JIS), A6, Executive, 16K (195x270 mm), A4 Short (270mm Paper) |

| | | | |
|----------------------------------|-----------------------------------|-------------------------------|-------------------------------------------------------------------------------------------------------------------------------------------------------------|
| Paper Input | Paper Tray (Standard) | Paper Weight | 60 to 163 g/m ² ¹ |
| | | Maximum Paper Capacity | Up to 250 sheets of 80 g/m ² Plain Paper |
| | Manual Feed Slot | Paper Type | Plain Paper, Thin Paper, Thick Paper, Thicker Paper, Recycled Paper, Bond, Label, Envelope, Env.Thin, Env.Thick |
| | | Paper Size | <ul style="list-style-type: none"> • Width: 76.2 to 215.9 mm • Length: 127 to 355.6 mm • Envelope: COM-10, DL, C5, Monarch |
| | | Paper Weight | 60 to 230 g/m ² |
| | Maximum Paper Capacity | One sheet at a time | |
| Paper Output ² | Face Down Output Tray | | Up to 120 Sheets (face down delivery to the face down output paper tray) ³ |
| | Face Up Output Tray | | One sheet (face up delivery to the face up output tray) |
| 2-sided | Automatic 2-sided Printing | Paper Type | Plain Paper, Thin Paper, Recycled Paper |
| | | Paper Size | A4 |
| | | Paper Weight | 60 to 105 g/m ² |

¹ For paper of 105 g/m² and above, open the back cover to use the face up output tray.

² For labels, we recommend removing the printed sheets from the output paper tray immediately after they exit the machine to avoid the possibility of smudging.

³ Calculated with 80 g/m² in a temperate, non humid environment. Actual output tray capacity may vary depending on environmental conditions.

Fax Specifications

NOTE

This feature is available for MFC models.

| | | |
|----------------------------------|-------------------------------------------------------------------------------------------------------------------------------------------------------------|-----------------------------------|
| Compatibility | ITU-T Super Group 3 | |
| Coding System | MH / MR / MMR / JBIG | |
| Modem Speed | 33,600 bps (with Automatic Fallback) | |
| 2-sided Print Receiving | (MFC-L2802DN/MFC-L2800DW/MFC-L2802DW/MFC-L2827DWXL/MFC-L2827DW/MFC-L2835DW/MFC-L2860DWE/MFC-L2860DW/MFC-L2862DW/MFC-L2922DW/MFC-L2960DW/MFC-L2980DW) Yes | |
| Automatic 2-sided Sending | (MFC-L2922DW/MFC-L2960DW/MFC-L2980DW) Yes (from the ADF) | |
| Scanning Width | Maximum 208 mm | |
| Printing Width | Maximum 207.4 mm | |
| Greyscale | 8 bit / 256 levels | |
| Resolution | Horizontal | 203 dpi |
| | Vertical | Standard: 98 dpi Fine: 196 dpi |

| | |
|-------------------------------|-----------------------------------------------------------------------------------------------------------------------------------------------------------------------------------------------------------------------------------------------------------------------------------------------|
| Resolution | Super fine: 392 dpi Photo: 196 dpi |
| Address Book | (MFC-L2802DN/MFC-L2800DW/MFC-L2802DW/MFC-L2827DWXL/MFC-L2827DW/ MFC-L2835DW/MFC-L2860DWE/MFC-L2860DW/MFC-L2862DW/MFC-L2922DW/ MFC-L2960DW/MFC-L2980DW) 200 Locations |
| Shortcut | (MFC-L2802DN/MFC-L2800DW/MFC-L2802DW/MFC-L2827DWXL/MFC-L2827DW/ MFC-L2835DW) 10 locations |
| Groups | Up to 20 |
| Broadcasting | <ul style="list-style-type: none"> (MFC-L2802DN/MFC-L2800DW/MFC-L2802DW/MFC-L2827DWXL/ MFC-L2827DW/MFC-L2835DW) 260 Locations (MFC-L2860DWE/MFC-L2860DW/MFC-L2862DW/MFC-L2922DW/ MFC-L2960DW/MFC-L2980DW) 250 Locations |
| Automatic Redial | 3 times at 5-minute intervals |
| Memory Transmission | <ul style="list-style-type: none"> (MFC-L2802DN/MFC-L2800DW/MFC-L2802DW/MFC-L2827DWXL/ MFC-L2827DW/MFC-L2835DW) Up to 400 pages ¹ (MFC-L2860DWE/MFC-L2860DW/MFC-L2862DW/MFC-L2922DW/ MFC-L2960DW/MFC-L2980DW) Up to 500 pages ¹ |
| Out of Paper Reception | <ul style="list-style-type: none"> (MFC-L2802DN/MFC-L2800DW/MFC-L2802DW/MFC-L2827DWXL/ MFC-L2827DW/MFC-L2835DW) Up to 400 pages ¹ (MFC-L2860DWE/MFC-L2860DW/MFC-L2862DW/MFC-L2922DW/ MFC-L2960DW/MFC-L2980DW) Up to 500 pages ¹ |

¹ 'Pages' refers to the 'ITU-T TestChart Document No.1' (a typical business letter, Standard resolution, JBIG code).

Copy Specification

| | |
|-----------------------------------------|-------------------------------------------------------------------------------------------------------------------------------------------------------------------------------------------------------------------------------------------------------------------------------------------------------------------------------------------------------------------------------------------------------------------|
| Copy Width | Maximum 210 mm |
| Automatic 2-sided Copy | (MFC-L2922DW/MFC-L2960DW/MFC-L2980DW) Yes (from the ADF) |
| Sort Copy | Yes |
| Stack Copy | Up to 99 pages |
| Resolution | Maximum 600 x 600 dpi |
| First Copy Out Time ¹ | <ul style="list-style-type: none"> (MFC-L2960DW/MFC-L2980DW) Less than 8.4 seconds at 23°C (DCP-L2600D/DCP-L2620DW/DCP-L2622DW/DCP-L2627DW/DCP-L2627DWXL/ DCP-L2627DWE/DCP-L2640DN/DCP-L2660DW/DCP-L2665DW/MFC-L2802DN/ MFC-L2800DW/MFC-L2802DW/MFC-L2827DWXL/MFC-L2827DW/MFC-L2835DW/ MFC-L2860DWE/MFC-L2860DW/MFC-L2862DW/MFC-L2922DW) Less than 10 seconds at 23°C |

¹ From Ready Mode and standard tray.

Scanner Specifications

| | |
|-----------------------------------|-----------------------------------------------------------------------------------------------------------------------------------------------------------------------------------------------------------------------------------------------------------------------------------------------------|
| Colour / Black | Yes / Yes |
| TWAIN Compliant | Yes (Windows 10 / Windows 11) |
| WIA Compliant | Yes (Windows 10 / Windows 11) |
| AirPrint Compliant | (DCP-L2620DW/DCP-L2622DW/DCP-L2627DW/DCP-L2627DWXL/DCP-L2627DWE/ DCP-L2640DN/DCP-L2660DW/DCP-L2665DW/MFC-L2802DN/MFC-L2800DW/ MFC-L2802DW/MFC-L2827DWXL/MFC-L2827DW/MFC-L2835DW/MFC-L2860DWE/ MFC-L2860DW/MFC-L2862DW/MFC-L2922DW/MFC-L2960DW/MFC-L2980DW) Yes (macOS v11, v12, v13) |
| Colour Depth | <ul style="list-style-type: none"> 30 bit colour Processing (Input) 24 bit colour Processing (Output) |
| Grey Scale | <ul style="list-style-type: none"> 10 bit colour Processing (Input) 8 bit colour Processing (Output) |
| Resolution ² | <ul style="list-style-type: none"> Up to 19200 x 19200 dpi (interpolated) Up to 1200 x 1200 dpi (from Scanner Glass) Up to 600 x 600 dpi (from the ADF)¹ |
| Scanning Width | Maximum 210 mm |
| Automatic 2-sided Scanning | (MFC-L2922DW/MFC-L2960DW/MFC-L2980DW) Yes (from the ADF) |

¹ ADF models only

² Maximum 1200 × 1200 dpi scanning with the WIA driver in Windows 10 and Windows 11 (resolution up to 19200 × 19200 dpi can be selected by using the scanner utility)

Printer Specifications

| | |
|--------------------------------------|-----------------------------------------------------------------------------------------------------------------------------------------------------------------------------------------------------------------------------------------------------------------------------------------------------------------------------------------------------------------------------------------------------------------------------------------------------------------------------------------------------------------------------------------------|
| Automatic 2-sided Print | Yes |
| Emulation | (DCP-L2622DW/DCP-L2640DN/DCP-L2660DW/DCP-L2665DW/MFC-L2860DWE/ MFC-L2860DW/MFC-L2862DW/MFC-L2922DW/MFC-L2960DW/MFC-L2980DW) PCL6, BR-Script3, PDF Version 1.7 |
| Resolution | Up to 1200 x 1200 dpi |
| Print Speed ^{1 2} | 1-sided Print ³ <ul style="list-style-type: none"> (DCP-L2620DW/DCP-L2627DW/DCP-L2627DWXL/DCP-L2627DWE/ MFC-L2802DN/MFC-L2800DW/MFC-L2802DW/MFC-L2827DWXL/ MFC-L2827DW/MFC-L2835DW) Up to 32 pages/minute (A4 size) Up to 34 pages/minute (Letter size) (DCP-L2600D/DCP-L2622DW/DCP-L2640DN/DCP-L2660DW/DCP-L2665DW/ MFC-L2860DWE/MFC-L2860DW/MFC-L2862DW/MFC-L2922DW/ MFC-L2960DW/MFC-L2980DW) Up to 34 pages/minute (A4 size) Up to 36 pages/minute (Letter size) |
| | 2-sided Print |
| First Print Time ⁴ | <ul style="list-style-type: none"> (MFC-L2960DW/MFC-L2980DW) Less than 6.9 seconds at 23°C (DCP-L2600D/DCP-L2620DW/DCP-L2622DW/DCP-L2627DW/ DCP-L2627DWXL/DCP-L2627DWE/DCP-L2640DN/DCP-L2660DW/ |

| | |
|--|----------------------------------------------------------------------------------------------------------------------------------------------------------------------------------|
| | DCP-L2665DW/MFC-L2802DN/MFC-L2800DW/MFC-L2802DW/ MFC-L2827DWXL/MFC-L2827DW/MFC-L2835DW/MFC-L2860DWE/ MFC-L2860DW/MFC-L2862DW/MFC-L2922DW) Less than 8.5 seconds at 23°C |
|--|----------------------------------------------------------------------------------------------------------------------------------------------------------------------------------|

- 1 The print speed may change depending on the type of document you print.
- 2 The print speed may be slower when the machine is connected by wireless LAN.
- 3 These print speeds are for 1-sided printing and measured in accordance with the ISO/IEC 24734 standard.
- 4 From Ready mode and standard tray.

Interface Specifications

| | |
|---------------------------|-----------------------------------------------------------------------------------------------------------------------------------------------------------------------------------------------------------------------------------------------------------------------------------------------------------------------------|
| USB ^{1 2} | Hi-Speed USB 2.0 Use a USB 2.0 interface cable that is no more than 2 metres long. |
| LAN | (DCP-L2640DN/DCP-L2660DW/DCP-L2665DW/MFC-L2802DN/MFC-L2800DW/MFC-L2802DW/ MFC-L2827DWXL/MFC-L2827DW/MFC-L2835DW/MFC-L2860DWE/MFC-L2860DW/ MFC-L2862DW/MFC-L2922DW/MFC-L2960DW/MFC-L2980DW) 10Base-T/100Base-TX ³ |
| Wireless LAN | (DCP-L2620DW/DCP-L2622DW/DCP-L2627DW/DCP-L2627DWXL/DCP-L2627DWE/ DCP-L2660DW/DCP-L2665DW/MFC-L2800DW/MFC-L2802DW/MFC-L2827DWXL/MFC-L2827DW/ MFC-L2835DW/MFC-L2860DWE/MFC-L2860DW/MFC-L2862DW/MFC-L2922DW/MFC-L2960DW/ MFC-L2980DW) IEEE 802.11a/b/g/n (Infrastructure Mode) IEEE 802.11a/g/n (Wi-Fi Direct®) |
| NFC | (MFC-L2922DW/MFC-L2980DW) Yes |

- 1 Your machine has a USB 2.0 Hi-Speed interface. The machine can also be connected to a computer that has a USB 1.1 interface.
- 2 Third party USB hub devices are not supported.
- 3 Use a straight-through Category 5 (or greater) twisted-pair cable.

Supported Protocols and Security Features

Supported protocols and security features may differ depending the models.

Ethernet

10Base-T/100Base-TX

Wireless LAN (2.4GHz)

IEEE 802.11b/g/n (Infrastructure Mode), IEEE 802.11g/n (Wi-Fi Direct)

Wireless LAN (5GHz)

IEEE 802.11a/n (Infrastructure Mode), IEEE 802.11a/n (Wi-Fi Direct)

Protocols (IPv4)

ARP, RARP, BOOTP, DHCP, APIPA(Auto IP), WINS/NetBIOS name resolution, DNS Resolver, mDNS, LLMNR responder, LPR/LPD, Custom Raw Port/Port9100, POP3, SMTP Client, IPP/IPPS, FTP Client and Server, CIFS Client, SNMPv1/v2c/v3, HTTP/HTTPS server, TFTP client and server, ICMP, Web Services (Print/Scan), Syslog, SNTN Client, IMAP4, LDAP/LDAPS

Protocols (IPv6)

NDP, RA, DNS resolver, mDNS, LLMNR responder, LPR/LPD, Custom Raw Port/Port9100, IPP/IPPS, POP3, SMTP Client, FTP Client and Server, CIFS Client, SNMPv1/v2c/v3, HTTP/HTTPS server, TFTP client and server, ICMPv6, Web Services (Print/Scan), Syslog, SNTN Client, IMAP4, LDAP/LDAPS

Network Security (Wired)

APOP*, SMTP-AUTH, SSL/TLS (SMTP, HTTP, IPP, POP3*, IMAP4*, FTP), SNMP v3, 802.1x (EAP-MD5, EAP-FAST, PEAP, EAP-TLS, EAP-TTLS), OAuth(SMTP, POP3, IMAP4), Kerberos, IPsec

*When Internet FAX is downloaded.

Network Security (Wireless)

APOP*, SMTP-AUTH, SSL/TLS (SMTP, HTTP, IPP, POP3*, IMAP4*, FTP), SNMP v3, 802.1x (EAP-FAST, PEAP, EAP-TLS, EAP-TTLS), OAuth(SMTP, POP3, IMAP4), Kerberos, IPsec

*When Internet FAX is downloaded.

Wireless Network Security

WEP 64/128 bit, WPA-PSK (TKIP/AES), WPA2-PSK (TKIP/AES), WPA3-SAE (AES) (Wi-Fi Direct supports WPA2-PSK (AES) only)

Wireless Certification

Wi-Fi Certification Mark License (WPA3™ - Enterprise, Personal), Wi-Fi Protected Setup™ (WPS) Identifier Mark License, Wi-Fi CERTIFIED™ Wi-Fi Direct

Computer Requirements Specifications

Supported Operating Systems And Software Functions

For the latest supported OS, go to your model's **Supported OS** page at support.brother.com/os.

| Computer Platform & Operating System Version | PC Interface | | | Processor | Hard Disk Space to Install ¹ | |
|------------------------------------------------------------------------|---------------------------------|-----------|--------------|----------------------------------------------|-----------------------------------------|--------------------------------------|
| | USB ² | Wired LAN | Wireless LAN | | For Drivers | For Applications (including Drivers) |
| Windows 10 Home / 10 Pro / 10 Education / 10 Enterprise ^{4 5} | Printing PC Fax ³ | | | 32 bit (x86) or 64 bit (x64) processor | 80 MB | 1.8 GB |
| Windows 11 Home / 11 Pro / 11 Education / 11 Enterprise ^{4 5} | Scanning | | | 64 bit (x64) processor | | |
| Windows Server 2012 | Printing | Printing | | 64 bit (x64) processor | 80 MB | 80 MB |
| Windows Server 2012 R2 | Scanning | | | | | |
| Windows Server 2016 | | | | | | |
| Windows Server 2019 | | | | | | |
| Windows Server 2022 | | | | | | |
| macOS v11 ⁶ | Printing | | | 64 bit processor | N/A | 500 MB |
| macOS v12 ⁶ | PC-Fax (Send) ³ | | | | | |
| macOS v13 ⁶ | Scanning | | | | | |
| Chrome OS | Printing Scanning | | | N/A | N/A | N/A |

¹ An Internet connection is required to install the software if the installation disc is not supplied.

² Third party USB ports are not supported.

³ PC-Fax supports black and white only.

⁴ For WIA, 1200x1200 resolution. Brother Scanner Utility enables to enhance up to 19200 x 19200 dpi.

⁵ PaperPort™ 14SE supports Windows 10 and Windows 11.

⁶ macOS Disclaimer AirPrint capable: Printing, scanning, or PC faxing(Send) via macOS requires the use of AirPrint. Mac drivers are not provided for this machine.

For the latest driver updates, go to your model's **Downloads** page at support.brother.com/downloads.

All trademarks, brand and product names are the property of their respective companies.

Related Information

- [Appendix](#)

Supplies

When the time comes to replace supplies, such as the toner cartridge or drum unit, an error message will appear on your machine's control panel or in the Status Monitor. For more information about the supplies for your machine, visit go.brother/original or contact your local Brother dealer.



Supply product codes vary by country and region.

Toner Cartridge

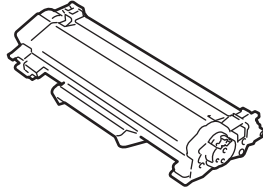

| Supply Order No. | Approximate Life (Page Yield) | Applicable Models |
|------------------------------------------------------------------------------------------------------------------------------------------------------|------------------------------------------|----------------------------------------------------------------------------------------------------------------------------------------------------------------------------------------------------------------------------------------------------------------------------------------------------------|
| Standard Toner: (For Western, Northern and Southern European countries)TN2510 (For Central and Eastern European countries)TN2590 | Approximately 1,200 pages ^{1 2} | DCP-L2600D/DCP-L2620DW/ DCP-L2622DW/DCP-L2627DW/ DCP-L2627DWXL/DCP-L2627DWE/ DCP-L2640DN/DCP-L2660DW/ DCP-L2665DW/MFC-L2802DN/ MFC-L2800DW/MFC-L2802DW/ MFC-L2827DWXL/MFC-L2827DW/ MFC-L2835DW/MFC-L2860DWE/ MFC-L2860DW/MFC-L2862DW/ MFC-L2922DW/MFC-L2960DW/ MFC-L2980DW |
| High Yield Toner: (For Western, Northern and Southern European countries)TN2510XL (For Central and Eastern European countries)TN2590XL | Approximately 3,000 pages ^{1 2} | DCP-L2600D/DCP-L2620DW/ DCP-L2622DW/DCP-L2627DW/ DCP-L2627DWXL/DCP-L2627DWE/ DCP-L2640DN/DCP-L2660DW/ DCP-L2665DW/MFC-L2802DN/ MFC-L2800DW/MFC-L2802DW/ MFC-L2827DWXL/MFC-L2827DW/ MFC-L2835DW/MFC-L2860DWE/ MFC-L2860DW/MFC-L2862DW/ MFC-L2922DW/MFC-L2960DW/ MFC-L2980DW |
| Super High Yield Toner: (For Western, Northern and Southern European countries)TN2510XXL (For Central and Eastern European countries)TN2590XXL | Approximately 5,000 pages ^{1 2} | MFC-L2922DW/MFC-L2960DW/ MFC-L2980DW |
| Inbox Toner: (Supplied with your machine) | Approximately 700 pages ^{1 2} | DCP-L2600D/DCP-L2620DW/ DCP-L2622DW/DCP-L2627DWE/ MFC-L2802DN/MFC-L2800DW/ MFC-L2802DW/MFC-L2827DW/ MFC-L2860DWE |
| | Approximately 1,200 pages ^{1 2} | DCP-L2627DW/DCP-L2640DN/ DCP-L2660DW/DCP-L2665DW/ MFC-L2835DW/MFC-L2860DW/ MFC-L2862DW/MFC-L2922DW |
| | Approximately 1,500 pages ^{1 2} | MFC-L2960DW |
| | Approximately 3,000 pages ^{1 2} | MFC-L2980DW |
| | Approximately 6,000 pages ^{1 2} | DCP-L2627DWXL/MFC-L2827DWXL |

| Supply Order No. | Approximate Life (Page Yield) | Applicable Models |
|------------------|--------------------------------------------------------------------------|-------------------|
| | (High Yield Toner + High Yield Toner replacement included in the carton) | |

¹ The approximate cartridge yield is declared in accordance with ISO/IEC 19752.

² A4/Letter single-sided pages

Drum Unit

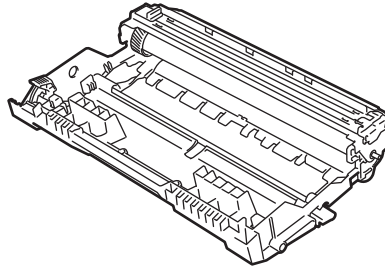

| Drum Unit: | | |
|---------------------------------------------------------------------------------------------------------------------|-----------------------------------------|----------------------------------------------------------------------------------------------------------------------------------------------------------------------------------------------------------------------------------------------------------------------------------------------------------|
| Supply Product Codes | Approximate Life (Page Yield) | Applicable Models |
| (For Western, Northern and Southern European countries)DR2510 (For Central and Eastern European countries)DR2590 | Approximately 15,000 pages ¹ | DCP-L2600D/DCP-L2620DW/ DCP-L2622DW/DCP-L2627DW/ DCP-L2627DWXL/DCP-L2627DWE/ DCP-L2640DN/DCP-L2660DW/ DCP-L2665DW/MFC-L2802DN/ MFC-L2800DW/MFC-L2802DW/ MFC-L2827DWXL/MFC-L2827DW/ MFC-L2835DW/MFC-L2860DWE/ MFC-L2860DW/MFC-L2862DW/ MFC-L2922DW/MFC-L2960DW/ MFC-L2980DW |

¹ Approximately 15,000 pages based on one page per job (A4/Letter single-sided pages). The number of pages may be affected due to a variety of factors including but not limited to media type and media size.



Related Information

- [Appendix](#)

Environmental and Compliance Information

- [Information Regarding Recycled Paper](#)
- [Availability of Service Parts](#)
- [Chemical Substances \(EU REACH\)](#)

Information Regarding Recycled Paper

- Recycled paper is of the same quality as paper made from original forest sources. Standards governing modern recycled paper ensure that it meets the highest quality requirements for different printing processes. The imaging equipment supplied by Brother is suitable for using with recycled paper meeting the EN 12281:2002 standard.
- Purchasing recycled paper saves natural resources and promotes the circular economy. Paper is made using cellulose fibres from wood. Collecting and recycling paper extends the life of fibres over multiple life cycles, making the best use of the resources.
- The recycled paper production process is shorter. The fibres have already been processed, so less water and energy, and fewer chemicals are used.
- Paper recycling has the benefit of saving carbon by diverting paper products from alternative disposal routes such as landfill and incineration. Landfill waste emits methane gas, which has a powerful greenhouse effect.



Related Information

- [Environmental and Compliance Information](#)
-

Availability of Service Parts

Brother warrants that service parts will be available for at least seven years after the last date we place models on the market.

To obtain service parts, contact your Brother supplier or dealer.



Related Information

- [Environmental and Compliance Information](#)
-

Chemical Substances (EU REACH)

Information concerning chemical substances within our products required for the REACH Regulation can be found at <https://www.brother.eu/reach>.



Related Information

- [Environmental and Compliance Information](#)
-

Brother Help and Customer Support

If you need help with using your Brother product, visit support.brother.com for FAQs and troubleshooting tips. You can also download the latest software, drivers and firmware, to improve the performance of your machine, and user documentation, to learn how to get the most from your Brother product.

Further product and support information is available from your local Brother office website. Visit global.brother/en/gateway to find the contact details for your local Brother office and to register your new product.



Related Information

- [Appendix](#)
-

brother



UK
Version B