

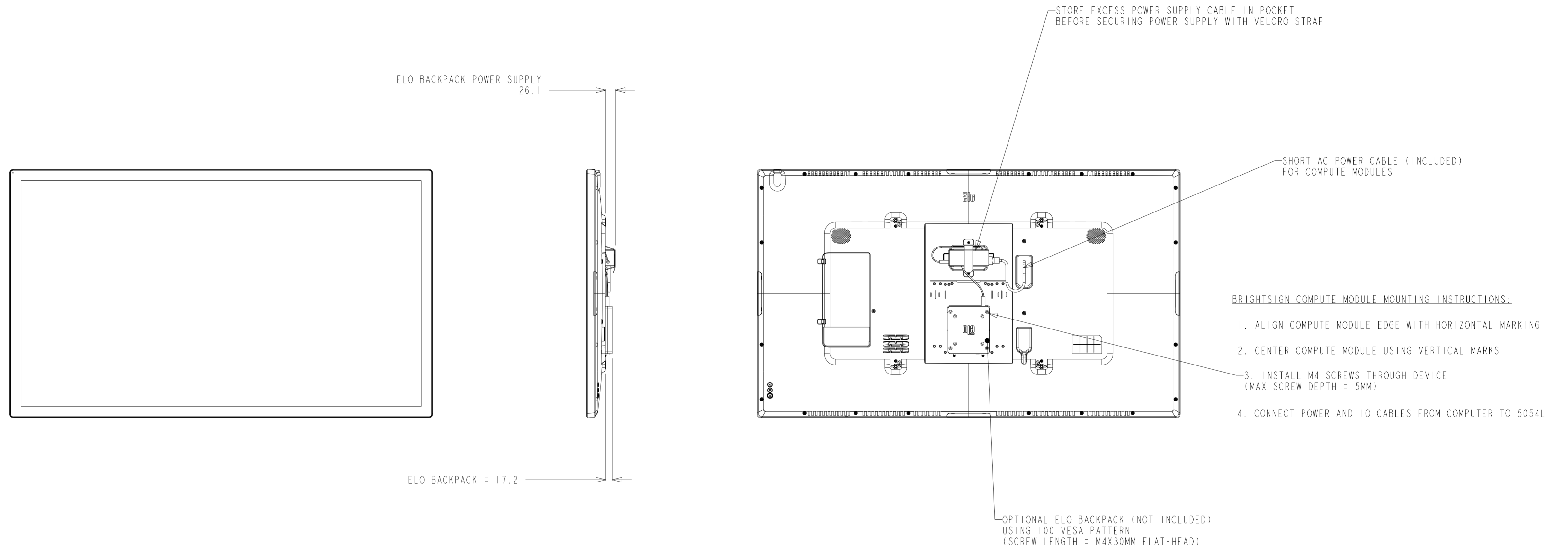

# COMPUTE MODULE MOUNTING



# LOW-PROFILE WALL MOUNT KIT P/N E721949

LANDSCAPE ORIENTATION (SEE PAGE 4 FOR PORTRAIT ORIENTATION)

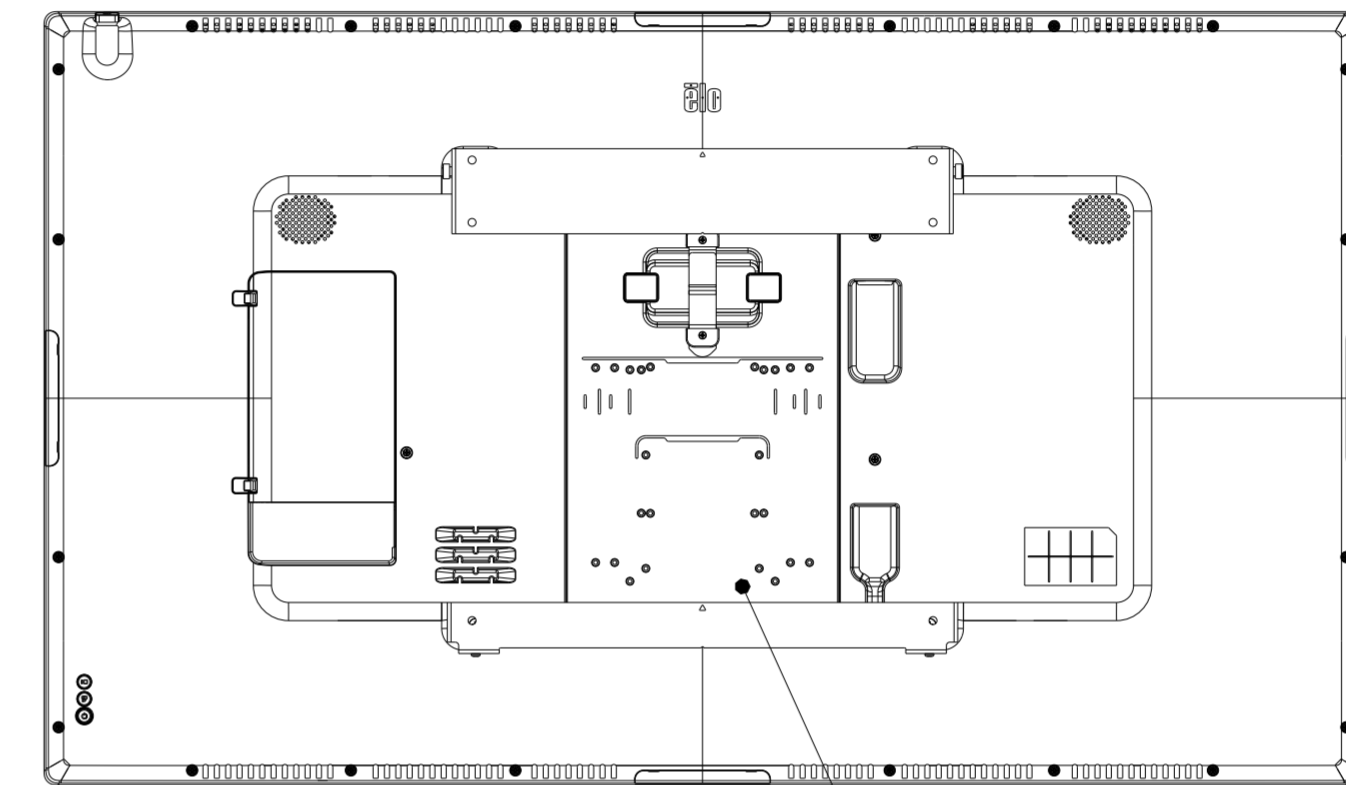
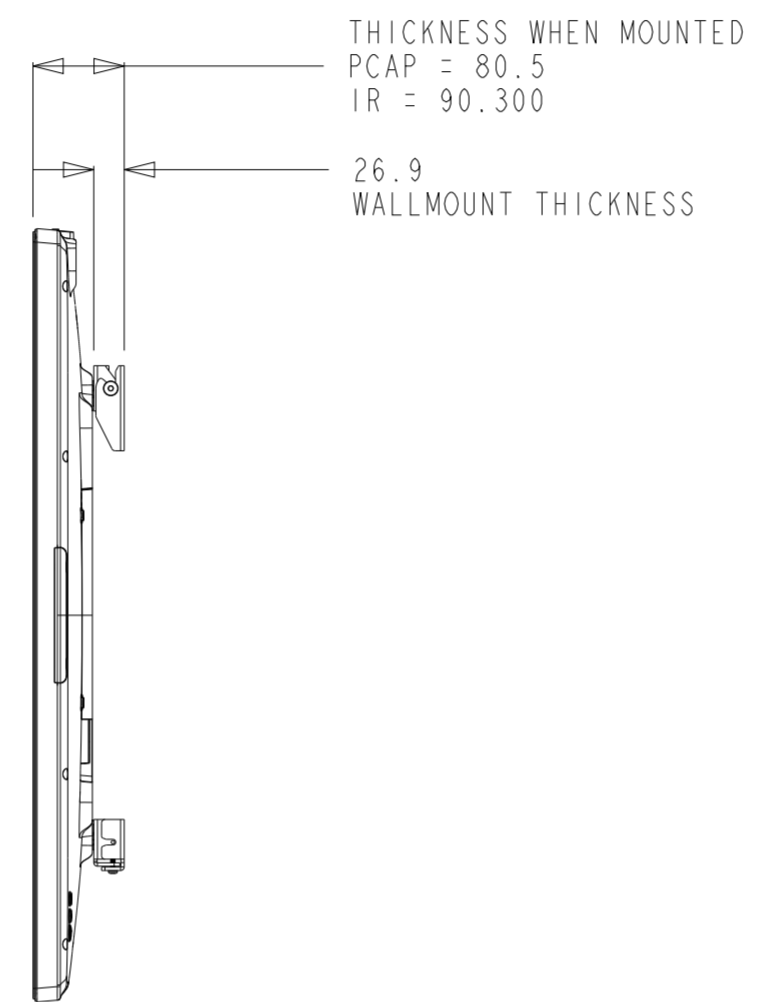
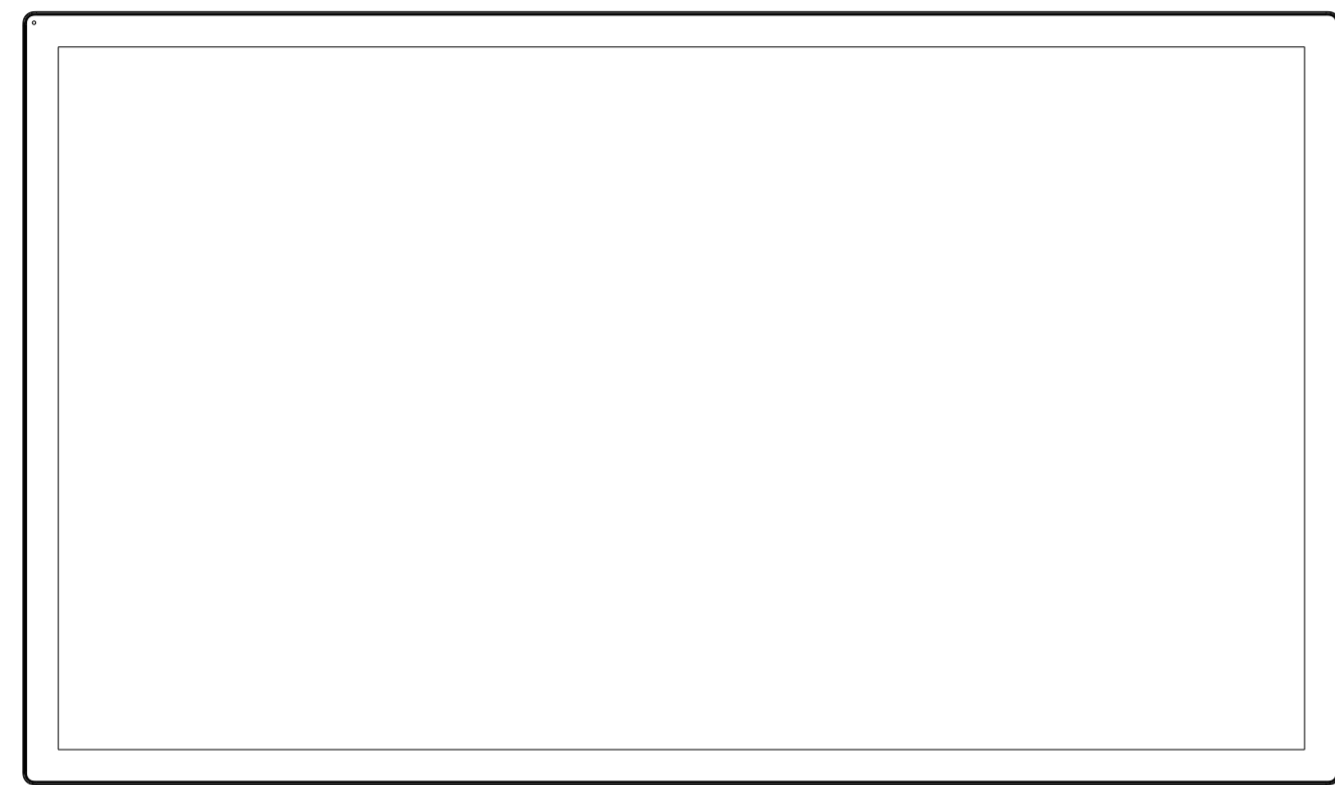
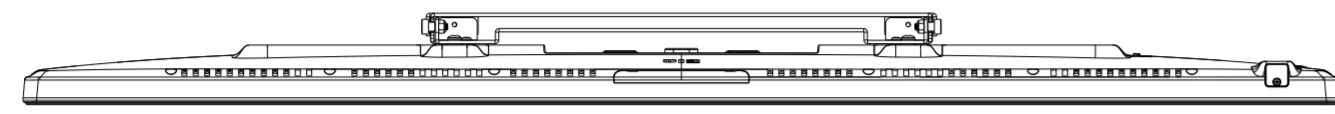

MAXIMUM COMPUTE MODULE THICKNESS ON RECESSED FACE WITHOUT WALL CLEARANCE = 35.1MM

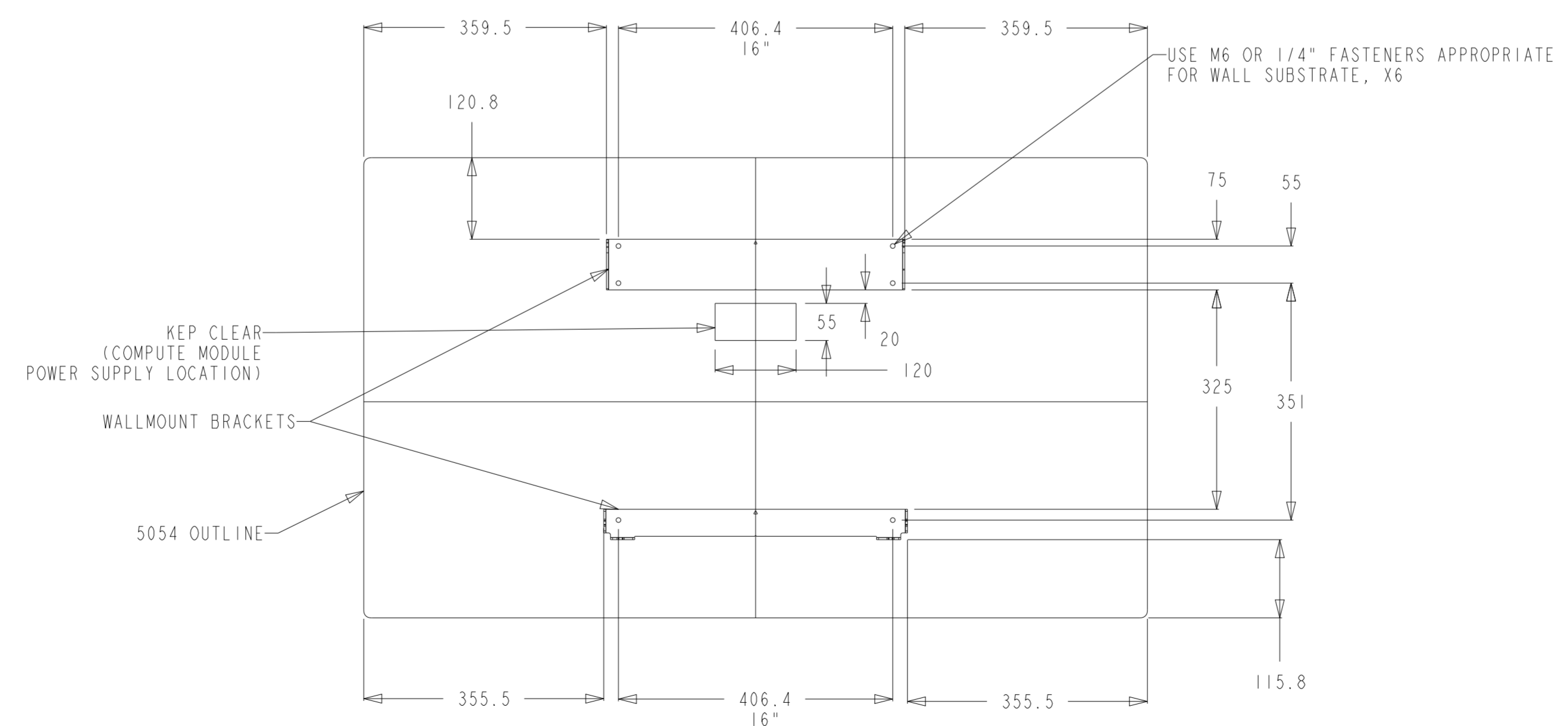

# LOW-PROFILE WALL MOUNT KIT P/N E721949

PORTRAIT ORIENTATION (SEE PAGE 3 FOR LANDSCAPE ORIENTATION)

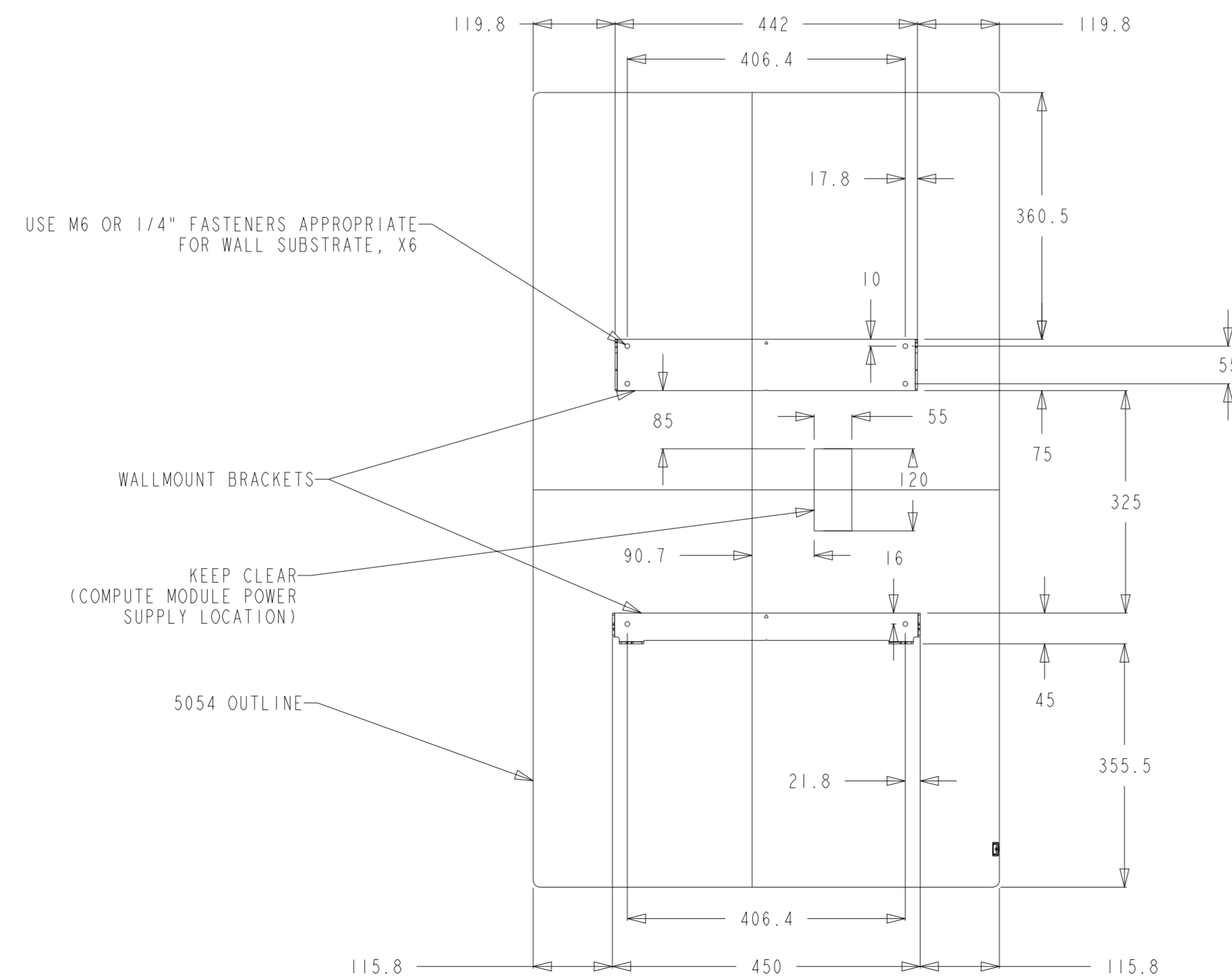
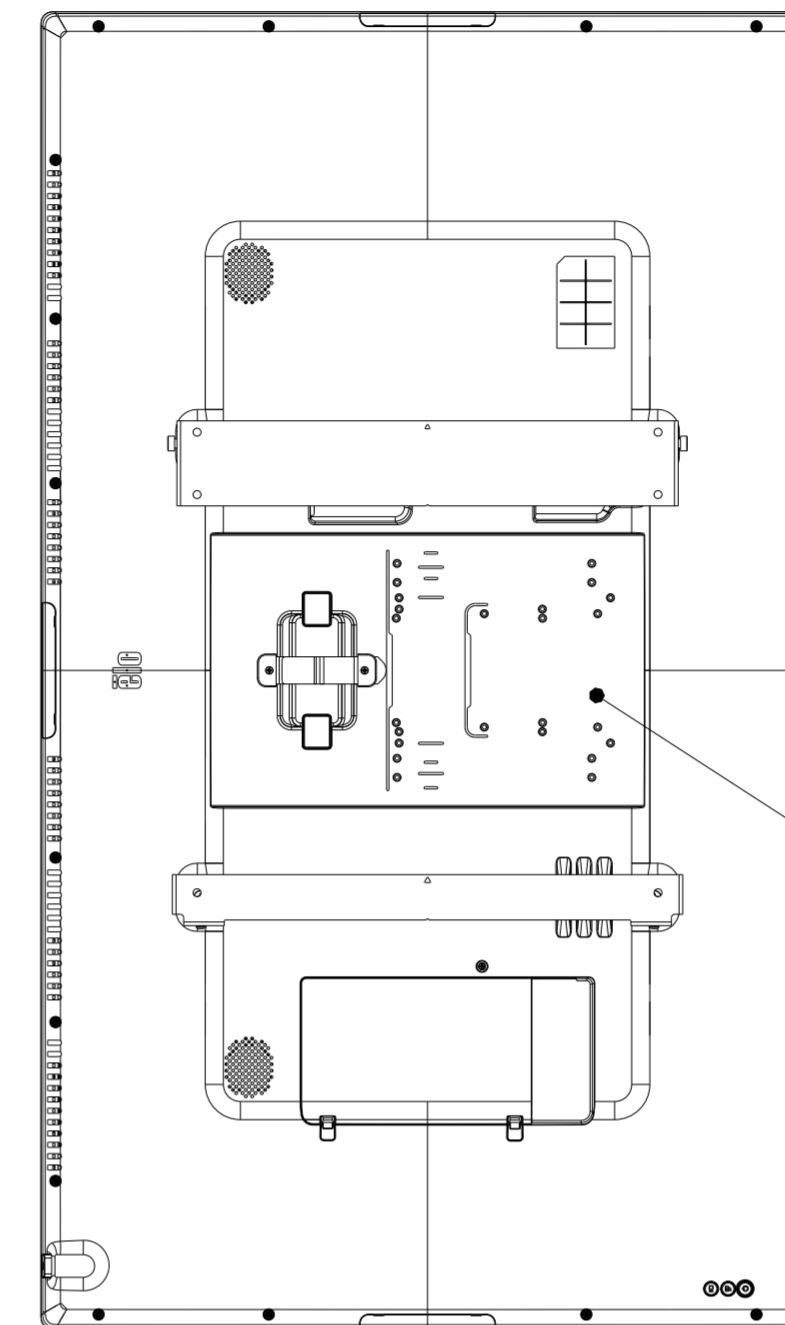
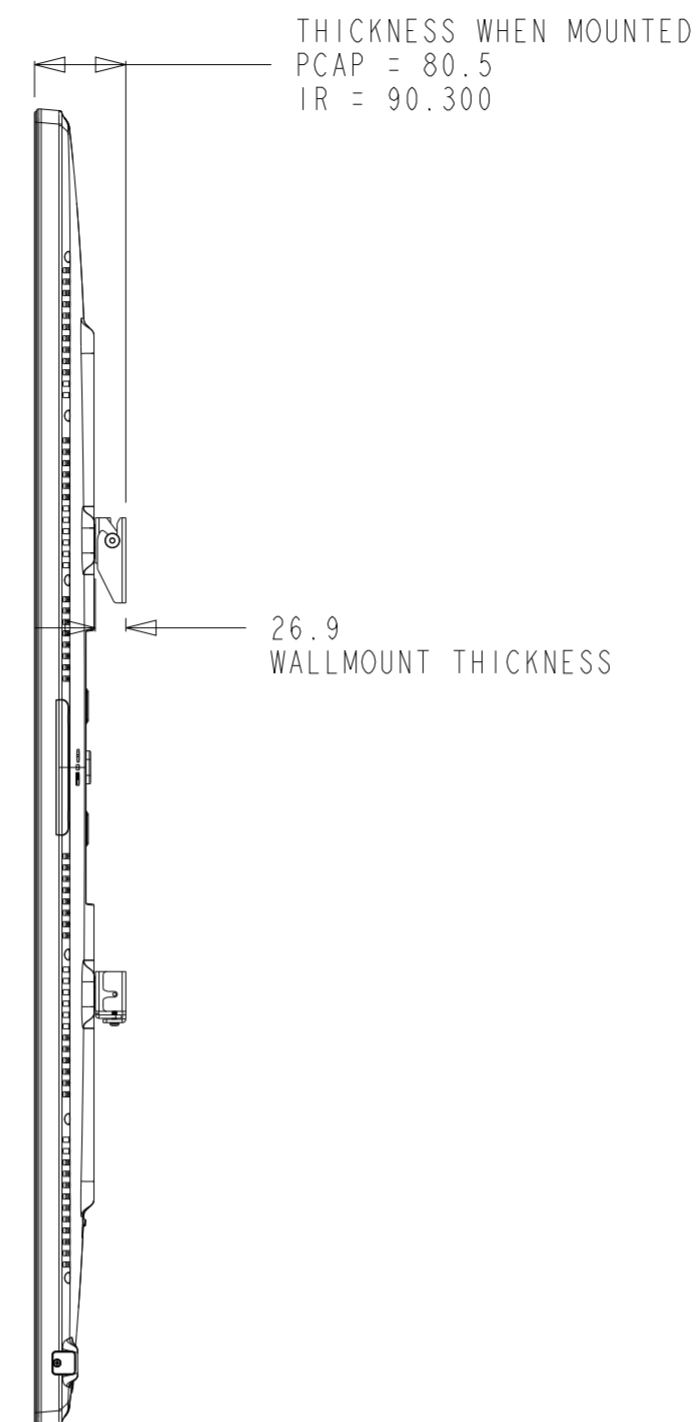
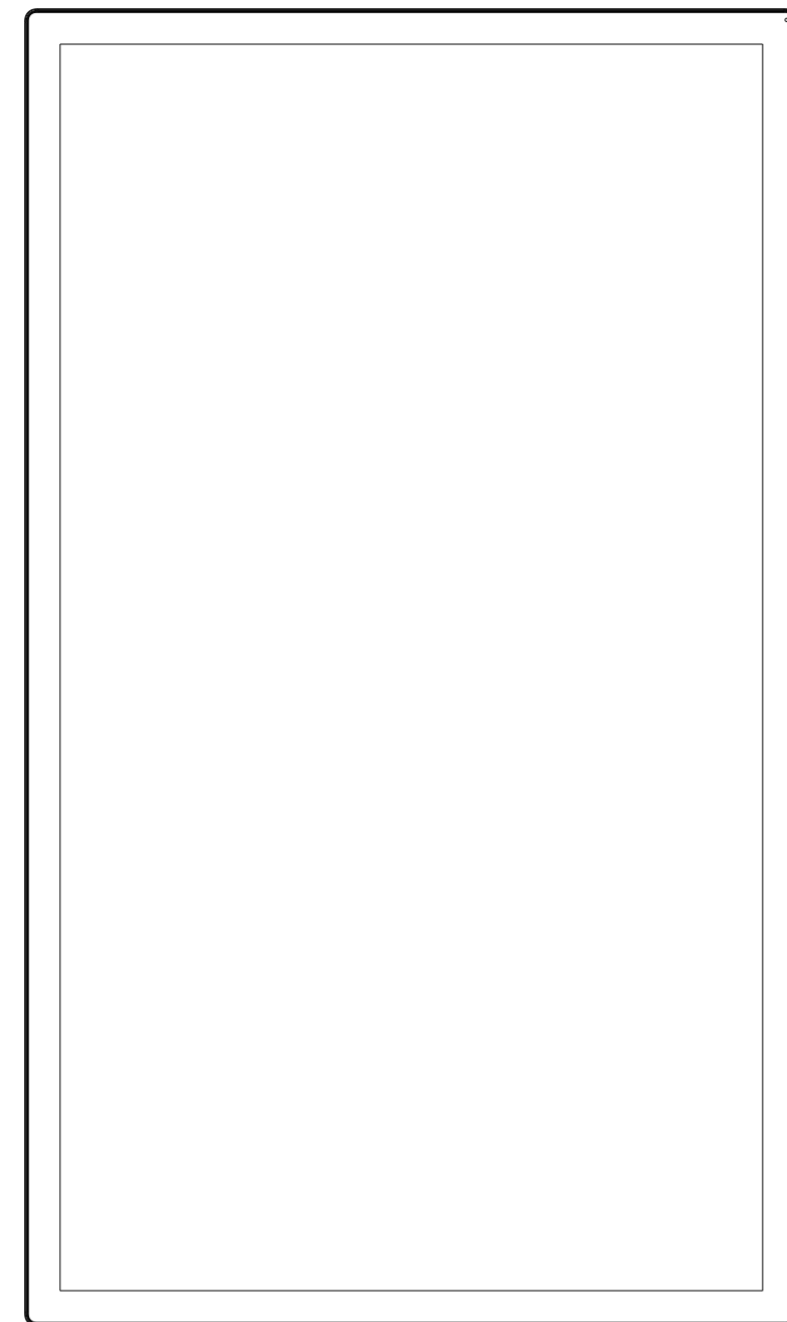

IDS STAND KIT P/N E722153  
LANDSCAPE ORIENTATION ONLY

