

HANNspree

Hanns *Note* 2

SN10HR1B

User Manual

Contents

Precautions	3
Special Notes	4
Declaration	5
What's in the Box	6
1. Product Overview	7
1.1 Front View	7
1.2 Rear View.....	8
2. Initial Operation	9
2.1 Maintaining the Battery	9
2.2 Connecting to Wi-Fi Networks	10
2.3 Connecting PC to Transmit Data	11
3. Android Interface	13
3.1 Home Screen	13
3.2 Customizing the Home Screen Panels.....	14
3.3 Managing Applications	14
3.4 Creating Application Folders	15
4. Built-in Note-taking App	15
4.1 Main Screen	15
4.2 Take Notes	16
4.3 Organize Notes	17
4.4 Edit PDF Files	19
4.5 Add Schedules to Calendar	20
4.6 Settings	21
5. System Firmware Updates	21
6. Product Specifications	22
7. Appendix	23

Control Information

This device is in accordance with the requirements in Radio Equipment Directive 2014/53/EU

This device complies with the requirements in EMC Electromagnetic Compatibility Directive 2014/30/EU and Low Voltage Directive 2014/35/EU.

The highest CE SAR value for the device is 0.5 W/Kg and the SAR limit is 2.0 W/Kg

Recycling Information

Hannspree attaches great importance to environmental policy. We encourage you to properly dispose of this product at the end of its service life.

This product may contain recyclable materials, and it may also contain materials that are classified as dangerous or toxic. We sincerely hope that you will use the information provided to dispose of this product responsibly.

For more information, please visit:



<http://www.hannspree.eu/>

Trademark Notice

Android, Google, Google Play, and other marks are trademarks of Google Inc.

Precautions

For the correct use and good performance of your HannsNote2 device, make sure to read this manual and follow the instructions provided.

- Please avoid exposing the device to temperatures above 35°C and below 0°C.
- Never drop, knock, or hit the device forcefully.
- Never let the device come in contact with chemicals such as benzene, thinner, etc.
- Do not let the device get close to strong magnetic fields, electric fields, etc.
- Keep the device away from heating appliances.
- Never privately disassemble, repair or modify the device.
- Be aware that using the device when cycling, driving a car, or riding a motorcycle is likely to cause danger.
- Be careful when listening to media at high volumes, as it could damage your hearing.
- Please charge your HannsNote2 device under the following circumstances:
 - A. When you pull down the status bar, the battery icon shows no power () on the upper-left corner of the screen.
 - B. The system automatically shuts down, and immediately shuts down after a re-start.
 - C. The operating button does not respond.
 - D. The red icon appears () on the upper-right corner of the screen.



DO NOT discard the battery in municipal waste.

The crossed out wheelie bin symbol indicate that the battery should **NOT** be disposed of in municipal waste.

HANNspree Europe Holdings BV:
Newtonweg 25, 5928 PN Venlo The Netherlands

HANNspree UK Ltd: Breakspear Park, Breakspear Way, Hemel Hempstead, Hertfordshire, HP2 4TZ

Do not attempt to replace the HannsNote2 battery yourself. Doing so may damage the battery, causing the device to overheat, which could result in injury. The lithium-ion battery in you HannsNote2 should be replaced only by HANNspree or a HANNspree Authorized Service Provider, and must be recycled or disposed of separately from household waste. Do not incinerate the battery. For more information about battery recycling and replacement, please visit <http://www.hannspree.eu/en/support/battery-replacement>.

Special Notes

Please read the following notes carefully before using HannsNote2.

- The product has no built-in light source and requires ambient light reflection. HannsNote2 should be used in an environment with an illuminance of 500 lux (lumens) or higher.

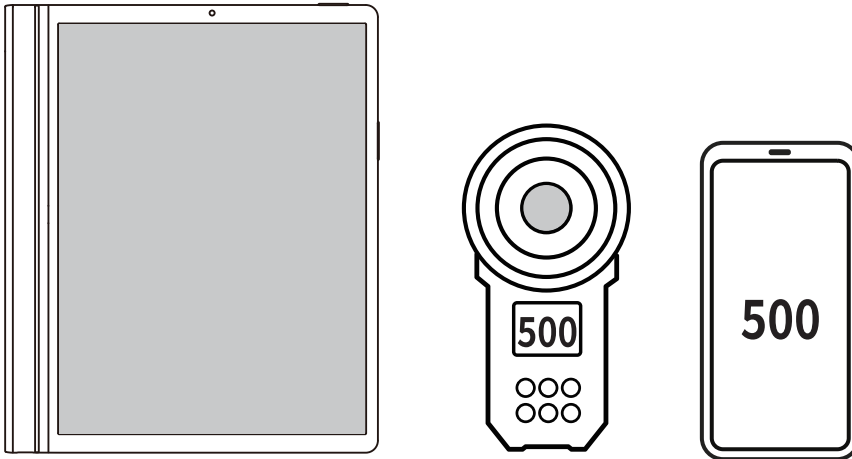

NOTE:

- The tablet and measuring instrument or mobile app must be set up on the same surface for testing.
- HannsNote2 is compatible with any stylus that conforms to the communication protocol USI 2.0.

Declaration

1. The information in this manual may not, except under written license by The Company, be copied, transmitted, distributed, or stored.
2. Although efforts have been made for the correctness and completeness during the preparation of the manual, there is no guarantee that this manual is free from any error or omission. The Company assumes no reliability regarding the errors or omissions that might exist in the manual.
3. For sustainable development, The Company reserves the right to modify and improve any product described in this manual without prior notice.
4. Under no circumstance shall the Company assume any liability, direct or indirect, related to data or income loss, or any special, accidental, incidental or indirect losses.

What's in the Box

Check Supplied Items

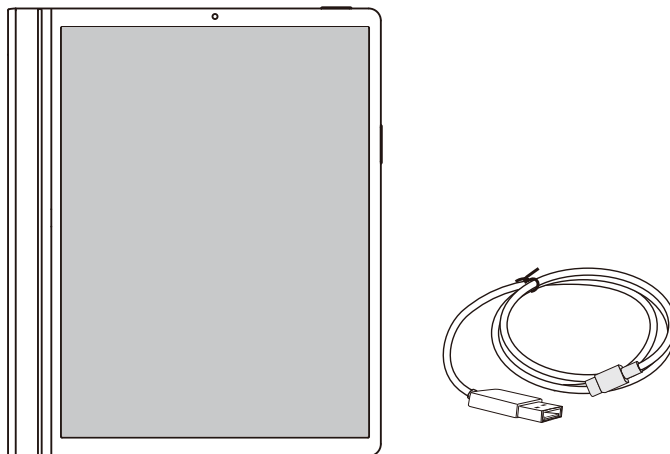

Reader SN10HR1B

NOTE:

- The illustrations in this document may appear differently from your model.

The Quick Start Guide is also included.

- If any item is damaged or missing, contact your point of purchase for assistance.
- Use only approved accessories.

1. Product Overview

1.1 Front View

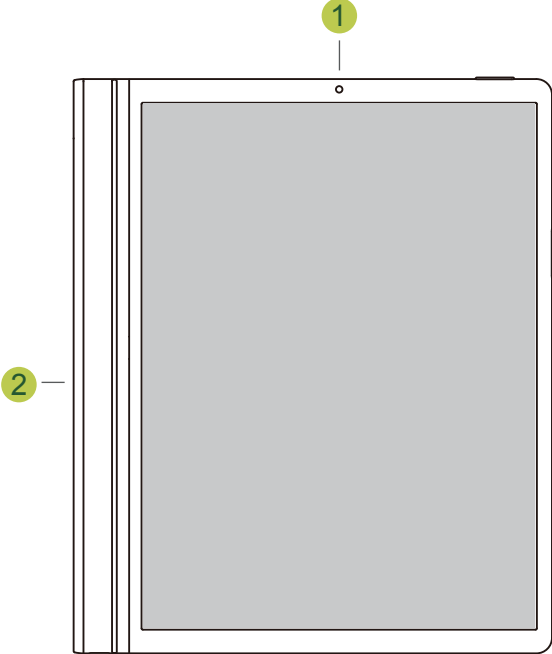

No.	Item	Description
1	Front Camera	For video calls and taking selfies.
2	Speaker	Emits sound output.

1.2 Rear View

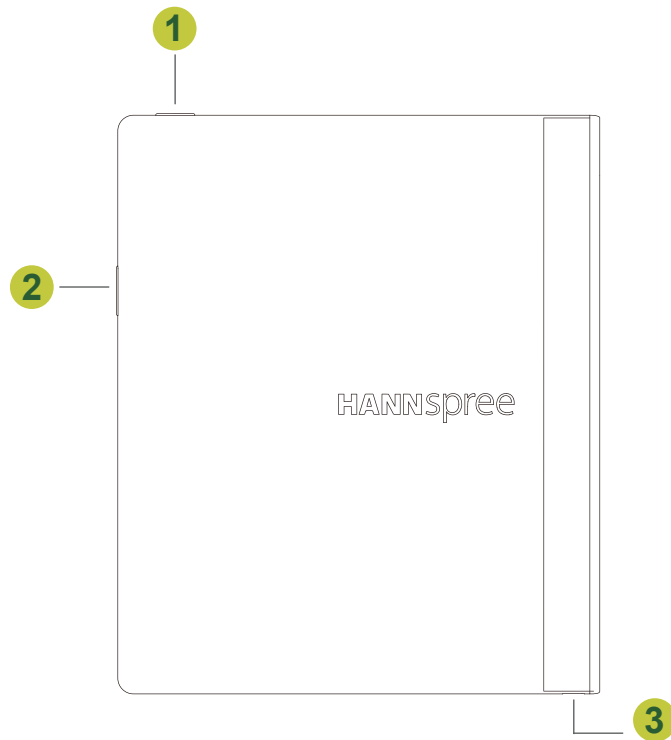

No.	Item	Description
1	Power button	Press to power on the device.
2	Volume button	Toggle to adjust the volume.
3	Power Input	Connect with power outlet to recharge the battery.

About the Power button:

- **Power on:** Press and hold the power button for 3 seconds until the device is turned on.
- **Power off:** Press the power button and the volume button at the same time. Tap **Power off** to turn the device off.

2. Initial Operation

2.1 Maintaining the Battery

Make sure to fully charge the battery before using your HannsNote2 device for the first time. This HannsNote2 has a built-in polymer battery; only use compatible power adapters to charge the device. For the first two times when you charge your HannsNote2 device, make sure its battery has been fully depleted before charging it again. This will prolong its service life.

To charge the battery, connect the compatible power adapter to the device.

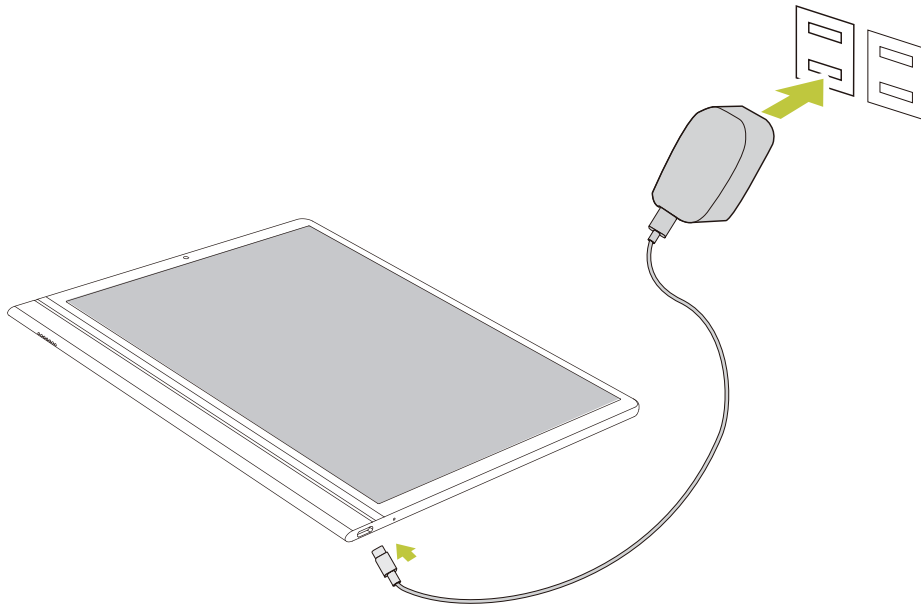

NOTE:

- For the first two times when you charge the battery, it may take up to 2 hours before the battery is fully charged.
- During charging, the battery icon on the screen will scroll.
- When charging is complete, the battery icon will turn black and stop scrolling.
- If your HannsNote2 device shuts down due to low power, it may take some time after connecting the device with a power outlet before the system enters the Home screen.

Be sure to turn off your HannsNote2 device when it's not in use.

Be sure to cycle the battery (discharge and recharge) at least once every month when your HannsNote2 device is not in-use.

The built-in polymer battery must be recharged regularly. Battery damage caused by depletion or by the use of an unauthorized power adapter is not covered by the warranty.

Please avoid constantly plugging in and charging the device. Constantly charging your HannsNote2 device while it's in-use, over an extended period of time, can lead to a decrease in the battery's service life, and cause damage to the battery such as swelling.

2.2 Connecting to Wi-Fi Networks

Once you have successfully connected to a Wi-Fi network, the device will automatically connect to the network when you are within range.

To configure the Wi-Fi connection, do the following:

1. Pull down the status bar to open the notification panel.
2. On the *Quick Settings* screen, tap **Internet**.

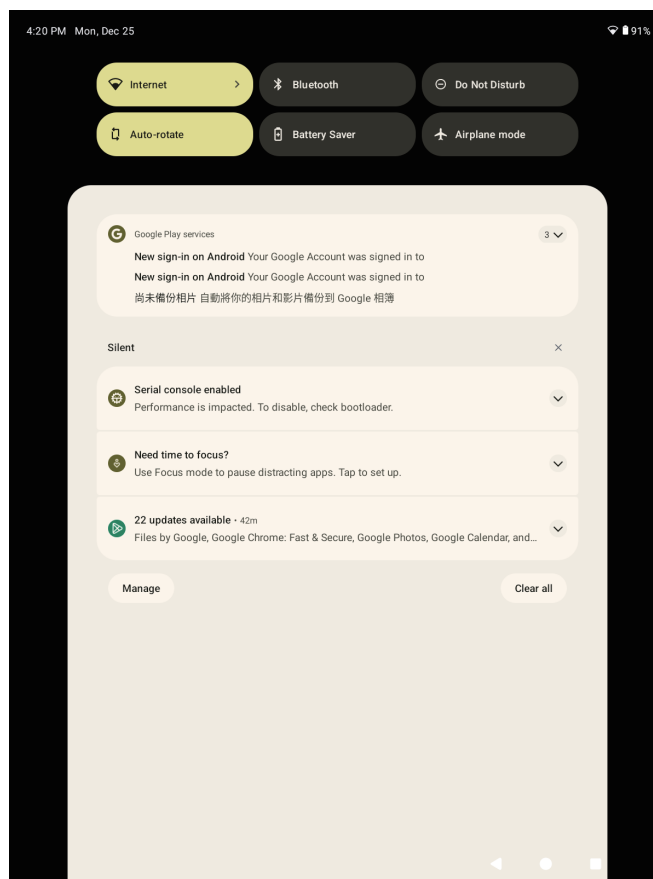

3. Turn on Wi-Fi. The device searches for available networks within range and displays the searched Access Point (AP) names on the right panel.

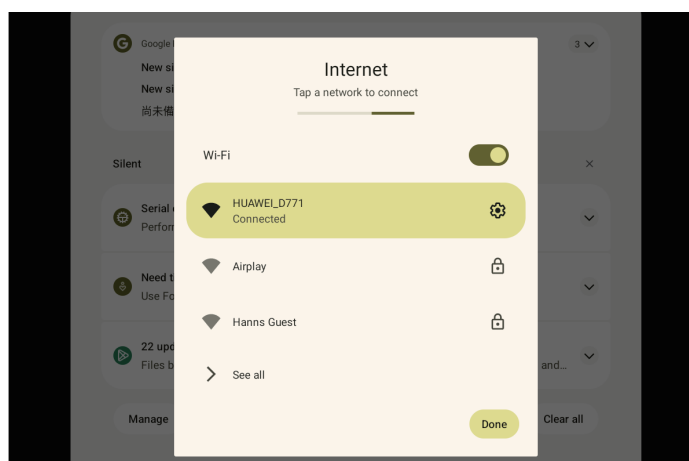

NOTE:

Tap the Wi-Fi switch button to turn Wi-Fi on or off.

- The Wi-Fi icon showing  indicates Wi-Fi is turned off.
- The Wi-Fi icon showing  indicates Wi-Fi is turned on.

4. Tap an access point name that you want to connect with. If the selected access point is protected by a password, you will be prompted to input the password.

5. If prompted, enter the password to connect to the AP.

NOTE:

- Password entry is required only when connecting to the AP for the first time.
- To make the Wi-Fi password visible while typing it, select the “Show password” checkbox.

6. Tap **Connect**.

NOTE:

- Some public places offer open wireless internet access. This means no password is required to establish the connection.
- For secured networks, you may need to enter several parameters to complete the settings. If you are not sure about the parameters, please contact your local Internet Service Provider (ISP).
- Your HannsNote2 device recognizes Wi-Fi networks that you have connected with before. Once Wi-Fi is turned on and a known connection is detected, the device automatically connects to that network.

2.3 Connecting PC to Transmit Data

Follow the steps below to transmit data from a PC to your HannsNote2 device:

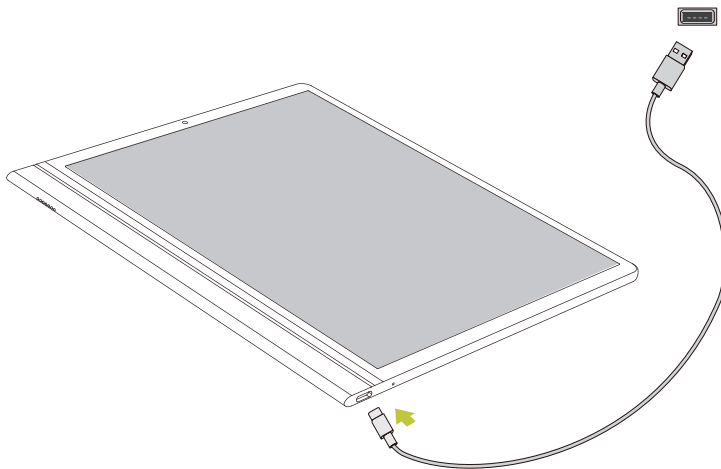

1. Connect your HannsNote2 device with the PC using a USB Type-A to Type-C connector.

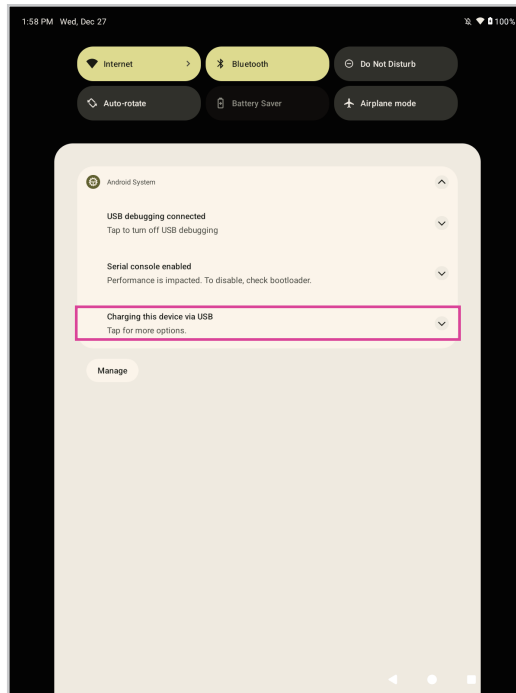

2. Select "File Transfer" on the list of options.

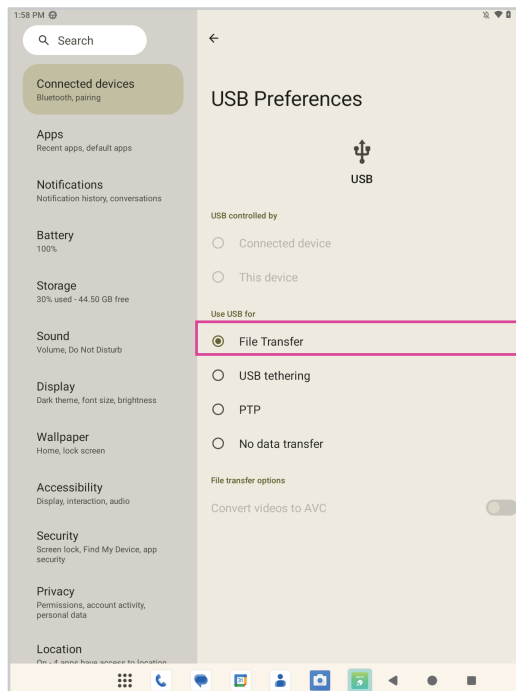

3. Android Interface

3.1 Home Screen

After powering on your HannsNote2 device, the locked Home screen will appear. Unlock it to open the Home screen.

This following section describes the main touch screen area and some tips on how to use it.

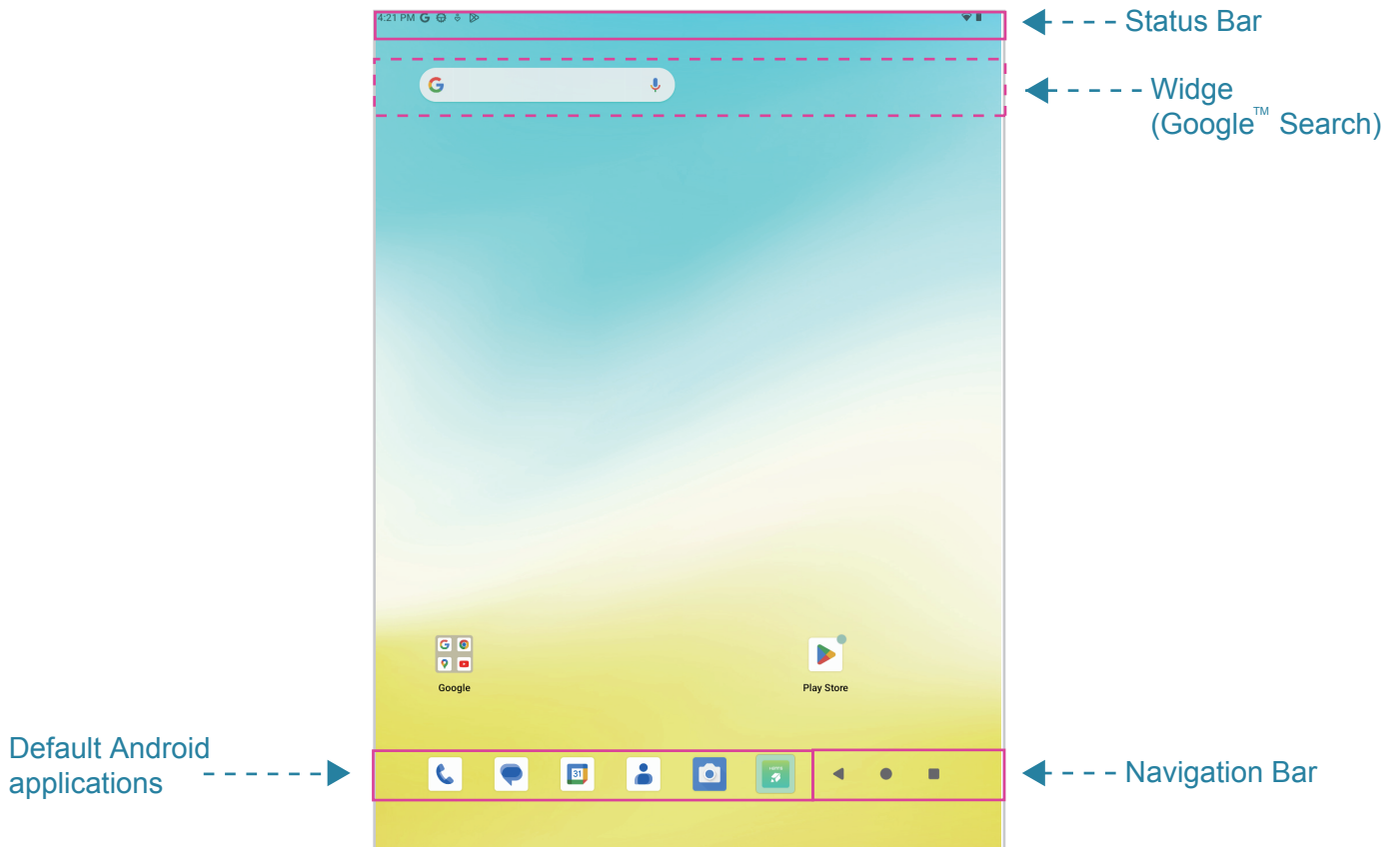

Item	Description
Status Bar	Display notifications and system icons such as Wi-Fi connection status, battery power / battery charging status, current time, and USB connection status.
Widget (Google Search)	Enter the text you want to search in the search box.
Default Android applications	Tap an icon to open the corresponding application.

	Item	Description
Navigation Bar	Back key (◀)	Tap to return to the previous screen.
	Home key (●)	Tap to return to the Home screen.
	Switch app (■)	Swipe to view the most-recently accessed applications. • To access a specific application, tap directly on the application's icon.

3.2 Customizing the Home Screen Panels

You can customize the wallpaper of your Home screen with any default wallpaper or with the photos stored in the device. Long press the Home screen and the wallpaper menu will appear. Then choose your desired option from the list.

3.3 Managing Applications

- **Add application shortcuts:** In the application menu, long press an application icon that you want to add as a shortcut, then drag the icon onto the Home screen.
- **Moving application shortcuts:** Long press an application icon that you want to move on the Home screen until the positioning grid lines appear, then drag the icon to the location you desire it to be in.
- **Remove application shortcuts:** Long press the application icon that you want to delete from the Home screen and an ✕ will appear. Drag the application icon towards the ✕ and hover until it turns red, then release.

3.4 Creating Application Folders

You can organize your applications into folders. Simply drag one application icon over another application icon and release it. A folder be created automatically.

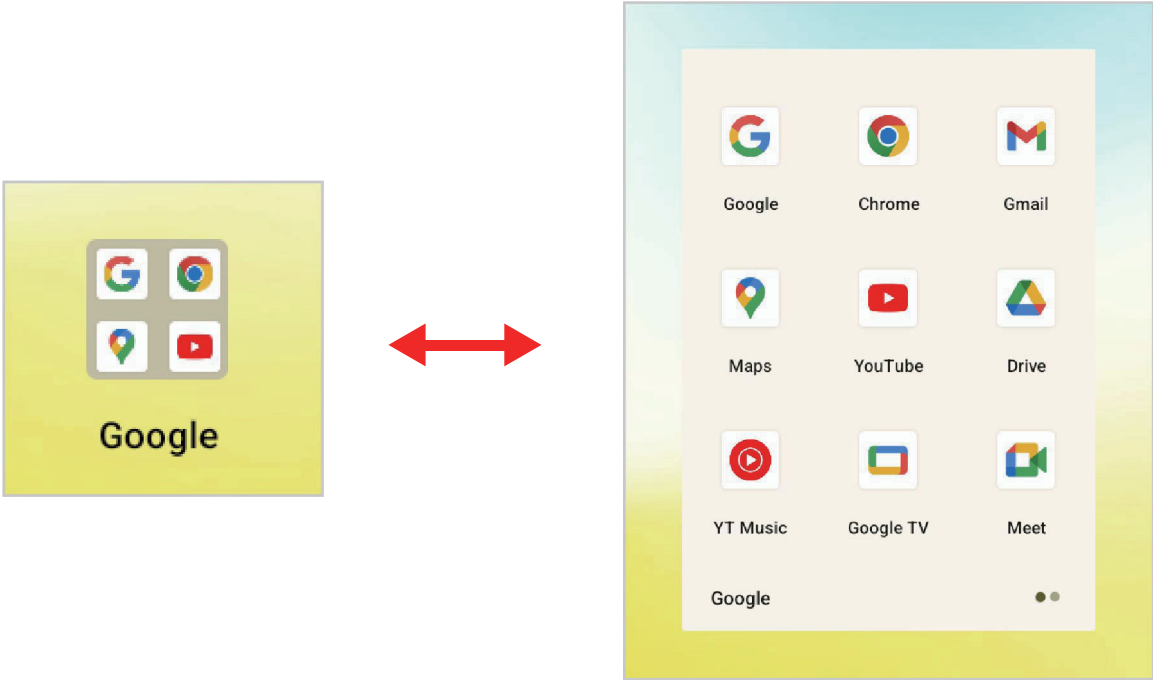

4. Built-in Note-taking App

4.1 Take Notes

Tap the HannsNote2 application icon to open.

The following describes the function of the search bar and each item on the navigation menu.

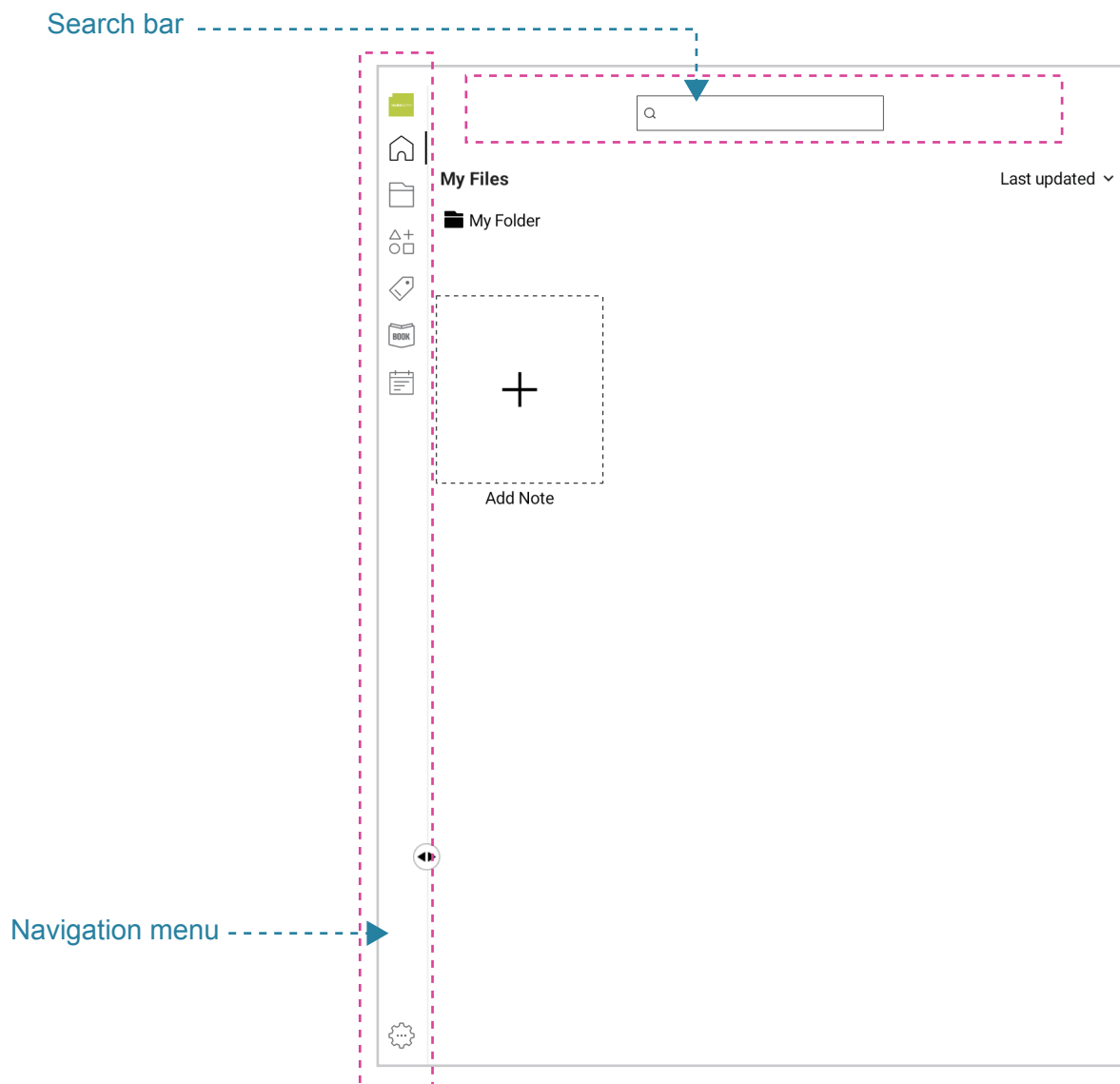

Icon	Item	Description
	Search bar	Type in keywords to search notes, files, and tags.
	Home page	Tap to start adding new notes or view stored notes.
	File	Tap to create a new file where you can organize your notes.
	Resource	Tap to select all stored materials.
	Tag	Tap to add a new tag, which can help you find your notes and files.
	Book	Tap to import a new e-book, or view and edit the e-books that are stored on your HannsNote2 device.
	Calendar	Tap to schedule an event on your calendar.
	Setting	Tap to manage your HannsNote2 app settings.

4.2 Take Notes

This note-taking app provides powerful functions for jotting down your ideas efficiently. The following introduces the tools and tips on how to use them.

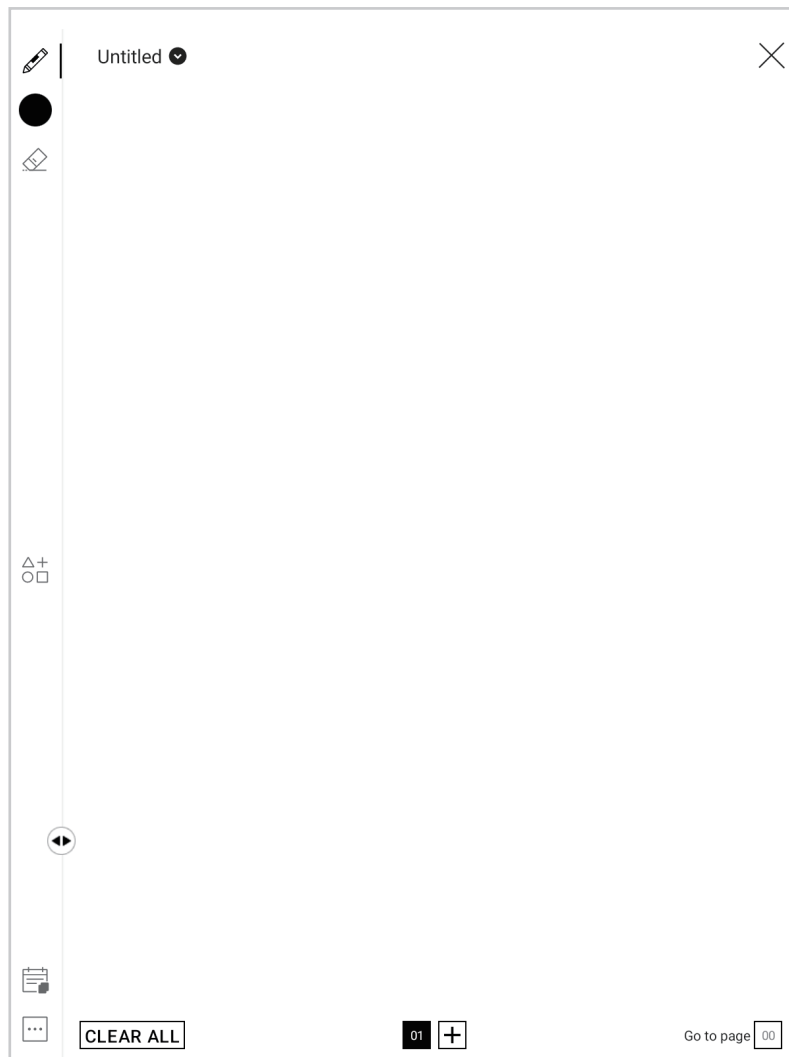

Icon	Item	Description
	Pen	Tap to adjust weight of stroke.
	Color	Tap to select a color.
	Text	Tap to add text.
	Eraser	Tap to use the erase tool.
	Crop	Tap to use the crop tool.

4.3 Organize Notes

The HannsNote2 app helps you to keep your notes organized. You can manage notes by **File** or **Tag**. Additionally, you can effortlessly find the notes you need through the search bar.

4.3.1 Organize Notes by File

Tap the File icon in the navigation menu to create a new file. You will be prompted to select a color and type in the file name. You can then search for the file by typing keywords into the search bar.

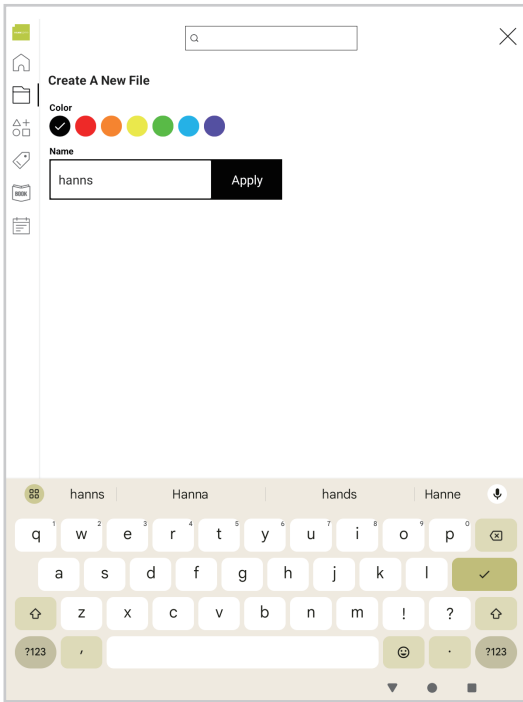

Create a new file

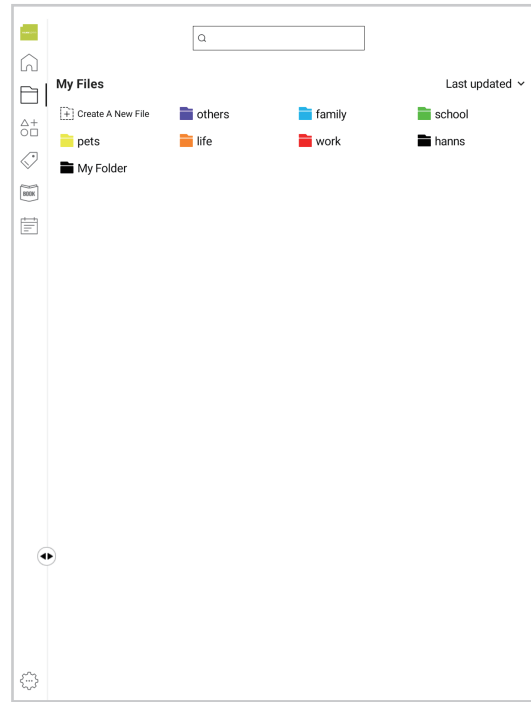

Search files

4.3.2 Organize Notes by Tag

Tap the Tag icon in the navigation menu to create a new tag. You will be prompted to select a color and type in the tag name. You can then search for the tag by typing keywords into the search bar.

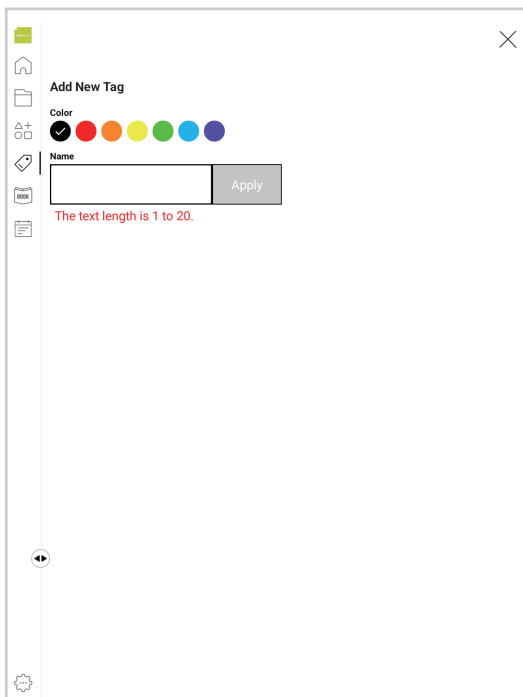

Create a new tag

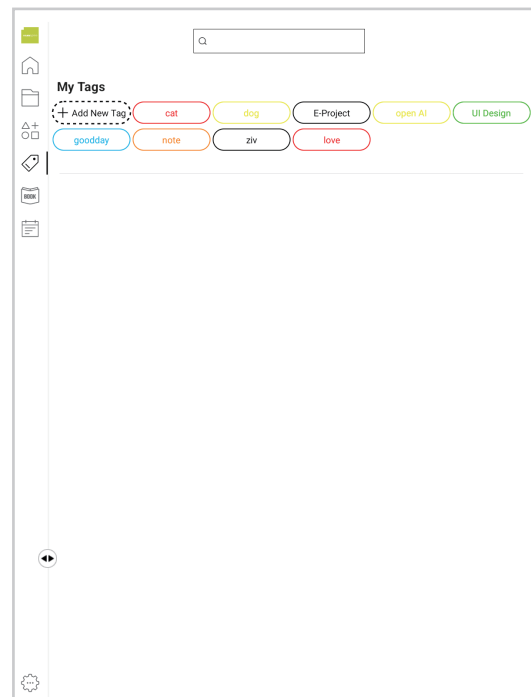

Search tags

4.4 Edit PDF Files

The HannsNote2 app enables you to write comments, highlight text, and sign on PDF documents.

4.4.1 Import PDF Files

Tap the import icon  to import PDF files, that have been saved on your HannsNote2 device, into the HannsNote2 app. Select the files that you want to import and tap the Add to Books button.

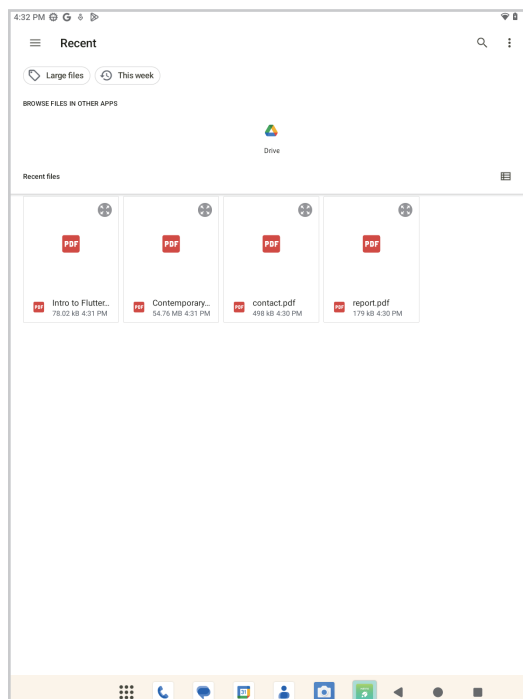
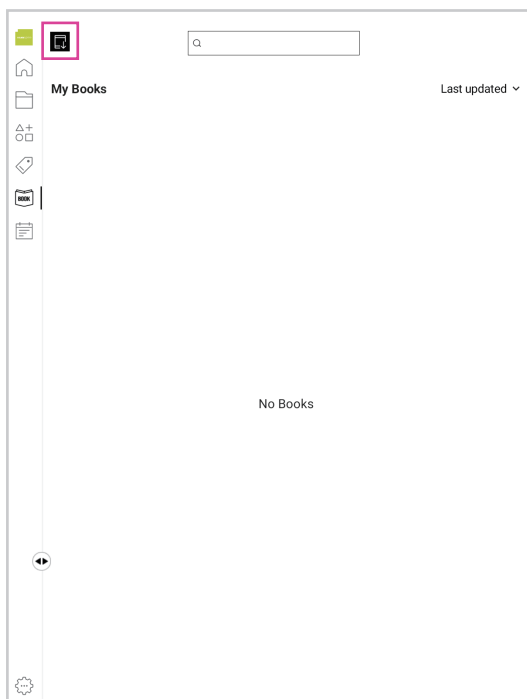

4.4.2 Share PDF Files

You can share your PDF files after you've finished editing them. Simply tap the share icon in the top right corner and select the tool you want to use for sharing.

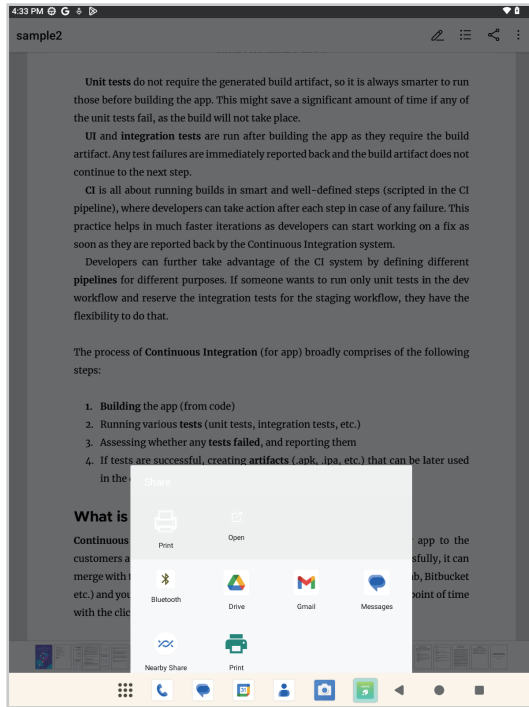

4.5 Schedule Events on Calendar

Tap the Calendar icon in the navigation menu to schedule a new event. You will be prompted to enter the title, then select the date and the time.

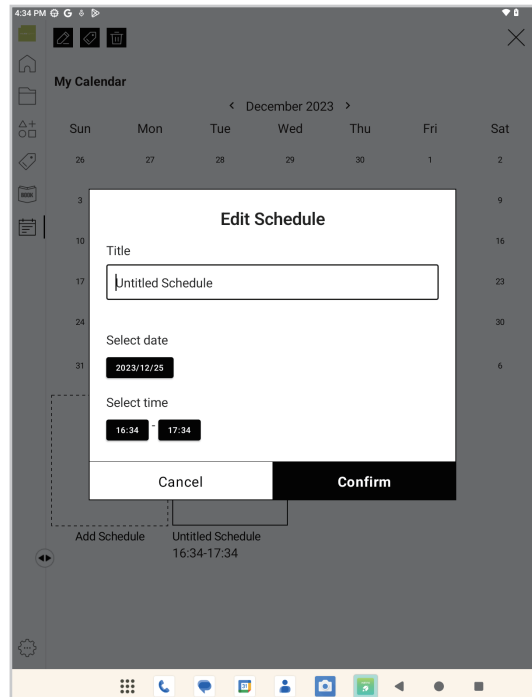
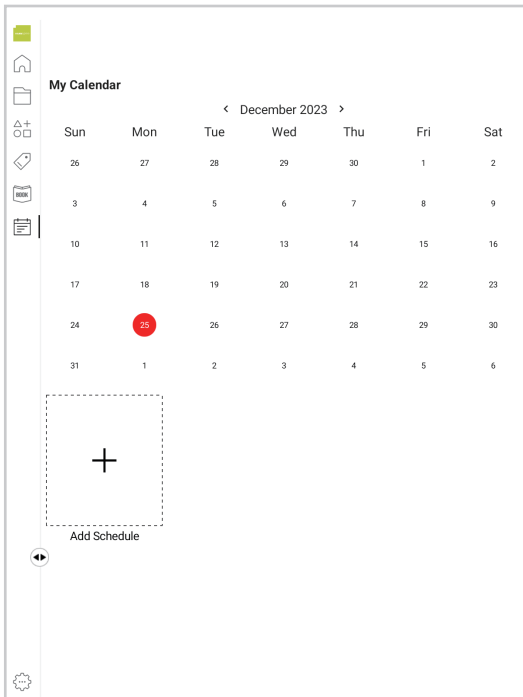

4.6 Settings

Tap the Settings icon in the navigation menu to manage your device name, change the language, check the software version and pair devices, reset the app, or log out.

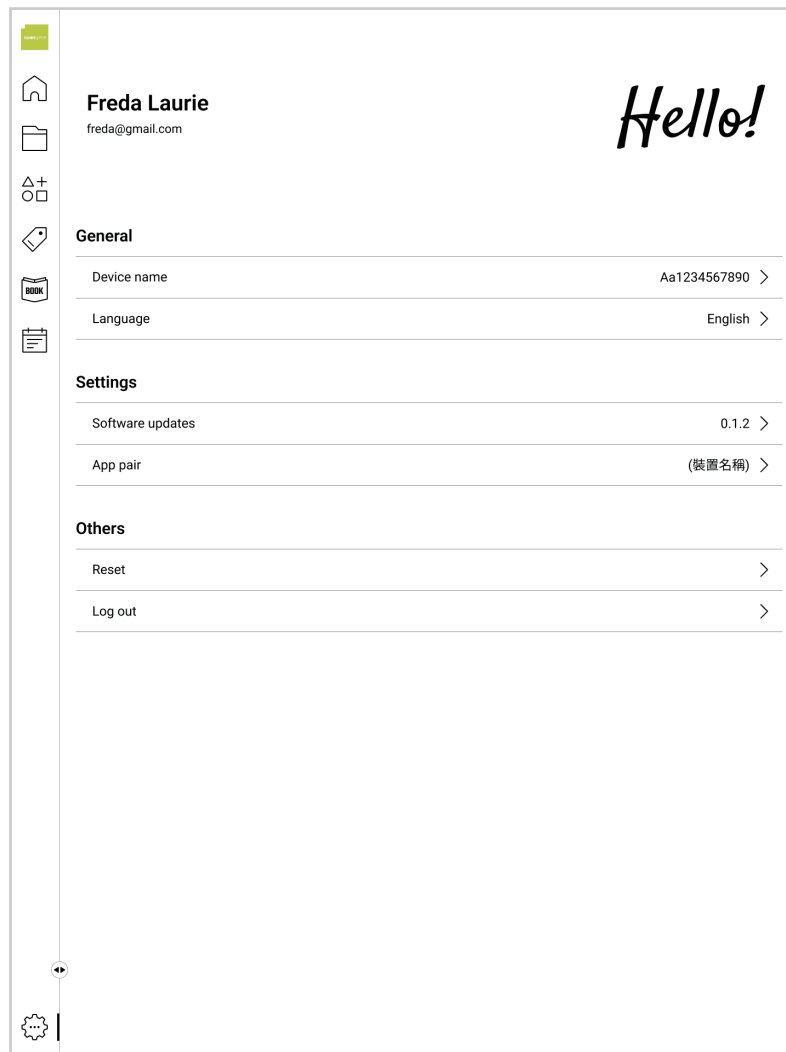

5. System Firmware Update

Android devices automatically receive over-the-air (OTA) updates. To manually check for a firmware update, select Settings > System > System update > Check for updates.

6. Product Specifications

Platform	Operating System	Android 13
	Processor	Rockchip RK3566: 4*A55@1.8G
	Memory	4GB (LPDDR4)
Storage	Storage	64GB eMMC
Display	Brightness	N/A (depends on ambient light)
	Resolution	10 inch, 1600 x 1200
	Type	8-bit 16.7M ecoVISION Paper Display
	Sensor (points)	10-point multi-touch (Protocol: USI2.0)
Communications	Wi-Fi	2.4GHz and 5GHz
	Bluetooth	BT5.0
	Cable	Type-C
Sensor	G Sensor	Yes (4-direction)
I/O Port	Microphone	Built-in
	USB 2.0	USB-A to Type-C cable
	Speakers output spec.	0.8W
HW button	Power	Yes
	Volume	Yes
Power	Battery	Rechargeable (Li-ion) battery, USB-C charging, 2200 mAh
	Operational Battery Life	Watching videos for 2.5-3 hours
	Stand-by* Battery Life	72 hours *Stand-By Mode: Turn off Wi-Fi, Bluetooth, and background programs
Dimension	Dimensions (W*D*H)	184.4 x 221.5 x 4.9 mm
Build-in App	HannsNote2 (Note-taking & drawing)	
E-book Format	PDF, EPUB, TXT, CHM, RTF, PRC, HTML, PDB, JPG, PNG, BMP, TIFF...(depends on E-book app)	
OTG	Supports	

7. Appendix

Usage Notice & Safety Information

1. Do not turn on your device when its use is prohibited due to interference or danger.
2. The electromagnetic waves emitted by the device may cause radio interference with medical equipment. Please adhere to the instructions provided for the medical equipment when in proximity. If you have any concerns, please contact your physician or the manufacturer of the medical device.
3. Activate airplane mode during flight: Comply with any relevant restrictions to prevent interference with aircraft communications.
4. Power off your device during refueling: Avoid using your device at gas stations and refrain from using it near fuel or chemical products.
5. Power off your device near blasting sites: Adhere to any relevant restrictions and avoid using your device in areas where blasting operations are being conducted.
6. Utilize qualified repair services: Only officially designated maintenance personnel are authorized to install or repair your device. Self-disassembly will void the warranty.
7. Battery: The device is equipped with a built-in battery. If replacement is necessary, please contact the original purchaser. Do not attempt to disassemble it yourself. Please use the recommended input voltage: 5V  2A for charging. Avoid using non-compliant or fast charging devices or accessories to prevent damage to the battery or device.
8. Keep your device dry and avoid exposure to water flows, saltwater, deionized water, soapy water, solvents, detergents, perfumes, skincare products, toners, high temperatures, or high humidity.
9. Do not place objects on the device and avoid scratching the screen with pens or sharp objects.
10. Do not drop the device or cause impacts to it. Bending the device or applying excessive force to the screen and buttons may result in damage or malfunction.

Warranty and Service

For warranty and service related information, please refer to the warranty card or Hannspree website. For further help and support with your device, including how to install software updates when available and much more, please visit:

<http://www.hannspree.eu/>

FAQ

You can find answers to frequently asked questions about HannsNote2 at the Hannspree website:

<https://www.hannspree.com/hannsnote2>

Resetting Your Device to Factory Default

If you need to reset your device to the factory default settings for any reason, please follow the process below:

WARNING!!!

Please be aware that the following procedure will permanently erase any information stored on the device.

1. From the Home screen, tap **Settings**.
2. Tap **System & Reset options**.
3. Tap Erase **all data(factory reset)**

The unit will now reset itself back to factory default and any previous information/data will have been permanently erased.

NOTE: Some applications downloaded from Google Play, or produced by third parties, may not be fully supported by this device.