

Acer LCD Monitor

User Guide

Copyright © 2024. Acer Incorporated.
All Rights Reserved.

Acer LCD Monitor User's Guide
Original Issue:

Changes may be made periodically to the information in this publication without obligation to notify any person of such revisions or changes. Such changes will be incorporated in new editions of this manual or supplementary documents and publications. This company makes no representations or warranties, either expressed or implied, with respect to the contents hereof and specifically disclaims the implied warranties of merchantability or fitness for a particular purpose.

Record the model number, serial number, purchase date and place of purchase information in the space provided below. The serial number and model number are recorded on the label affixed to your computer. All correspondence concerning your unit should include the serial number, model number and purchase information.

No part of this publication may be reproduced, stored in a retrieval system, or transmitted, in any form or by any means, electronically, mechanically, by photocopy, recording or otherwise, without the prior written permission of Acer Incorporated.

Acer LCD Monitor User's Guide

Model number: _____

Serial number: _____

Date of purchase: _____

Place of purchase: _____

Acer and the Acer logo are registered trademarks of Acer Incorporated. Other companies' product names or trademarks are used herein for identification purposes only and belong to their respective companies.

Special Notes on LCD Monitors

The following are normal with the LCD monitor and do not indicate a problem.

- Due to the nature of the fluorescent light, the screen may flicker during initial use. Turn off the power switch and then turn it on again to make sure the flicker disappears.
- You may find slightly uneven brightness on the screen depending on the desktop pattern you use.
- The LCD screen has 99.99% or more effective pixels. It may include blemishes of 0.01% or less such as a missing pixel or a pixel lit all the time.
- Due to the nature of the LCD screen, an afterimage of the previous screen may remain after switching the image, when the same image is displayed for hours. In this case, the screen is recovered slowly by changing the image or turning off the power switch for a few hours.

Information for your Safety and Comfort

Safety Instructions

Read these instructions carefully. Keep this document for future reference. Follow all warnings and instructions marked on the product.

Cleaning your Monitor

Please carefully follow these guidelines when cleaning the monitor:

- Always unplug the monitor before cleaning.
- Spray a non-solvent cleaning solution onto a cloth or rag and clean the screen gently. If you spill liquid on the screen, gently wipe the screen with a soft, dry microfiber cloth and then clean the screen with a lint roller.
- Cleaning the screen with a microfiber cloth and lint roller is recommended.
- Do not adhere anything onto the screen as this may damage the screen and/or affect its functioning.



.....
Note: When using a lint roller:

1. Peel off the protective film from the surface of the roller.
2. Roll the roller over the dirty areas in one direction until the dirt is removed.
*Once the sheet is dirty or no longer sticky, peel it off and use a new one.
3. When finished, place the roller back into the original packaging to ensure it does not get dust on it.



.....
Note: When using a microfiber cloth:

1. Make sure the microfiber cloth is clean.
2. Wipe the dirty areas in one direction until the dirt is removed.
*If there is still residual dirt, use other clean section of the microfiber cloth to wipe the dirt.
3. When finished, rinse the microfiber cloth with detergent and dry the microfiber cloth completely.
4. Place the microfiber cloth back into the original packaging to ensure it does not get dust on it.

Connecting/Disconnecting the Device

Observe the following guidelines when connecting and disconnecting power from the LCD monitor:

- Make sure the monitor is attached to its base before connecting the power cord to the AC power outlet.
- Make sure both the LCD monitor and the computer are turned off before connecting any cable or unplugging the power cord.
- If the system has multiple sources of power, disconnect power from the system by unplugging all power cords from the power supplies.

General Instructions

- Do not place the LCD display near a window. Exposing the display to rain, moisture or sunlight can cause severe damage.
- Do not apply pressure to the LCD screen. Excessive pressure may cause permanent damage to the display.
- Do not attempt to service this unit yourself. All services should be performed by authorized technicians.
- Immediately unplug your display and call an authorized technician if any of the following circumstances occur:
 - a. The Display-to-PC signal cable is frayed or damaged.
 - b. The LCD display is spilled with liquid or exposed to rain.
 - c. The LCD display or case is damaged.

Accessibility

Be sure that the power outlet you plug the power cord into is easily accessible and located as close to the equipment operator as possible. When you need to disconnect power from the equipment, be sure to unplug the power cord from the electrical outlet.

Safe Listening

To protect your hearing, follow these instructions.

- Gradually increase the volume until you can hear it clearly and comfortably and without distortion.
- After setting the volume level, do not increase it after your ears have adjusted.
- Limit the amount of time listening to music at high volume.
- Avoid turning up the volume to block out noisy surroundings.
- Turn the volume down if you can't hear people speaking near you.

Warnings

- Do not use this product near water.
- Do not place this product on an unstable cart, stand or table. If the product falls, it could be seriously damaged.
- Slots and openings are provided for ventilation to ensure reliable operation of the product and to protect it from overheating. These openings must not be blocked or covered. The openings should never be blocked by placing the product on a bed, sofa, rug or other similar surface. This product should never be placed near or over a radiator or heat register, or in a built-in installation unless proper ventilation is provided.
- Never push objects of any kind into this product through cabinet slots as they may touch dangerous voltage points or short-out parts that could result in a fire or electric shock. Never spill liquid of any kind onto or into the product.
- To avoid damage of internal components and to prevent battery leakage, do not place the product on a vibrating surface.
- Never use it under sporting, exercising, or any vibrating environment which will probably cause unexpected short current or damage internal devices.

Using Electrical Power

This product should be operated from the type of power indicated on the marking label. If you are not sure of the type of power available, consult your dealer or local power company.

- Do not allow anything to rest on the power cord. Do not locate this product where people will walk on the cord.
- If an extension cord is used with this product, make sure that the total ampere rating of the equipment plugged into the extension cord does not exceed the extension cord ampere rating. Also, make sure that the total rating of all products plugged into the wall outlet does not exceed the fuse rating.
- Do not overload a power outlet, strip or receptacle by plugging in too many devices. The overall system load must not exceed 80% of the branch circuit rating. If power strips are used, the load should not exceed 80% of the power strip's input rating.
- This product's power cord is equipped with a three-wire grounded plug. The plug only fits in a grounded power outlet. Make sure the power outlet is properly grounded before inserting the power cord plug. Do not insert the plug into a non-grounded power outlet. Contact your electrician for details.



.....

Warning! The grounding pin is a safety feature. Using a power outlet that is not properly grounded may result in electric shock and/or injury.



.....

Warning! The USB Type-C port is above PD 100W. The connected equipment is required to use fire enclosure.



.....

Note: The grounding pin also provides good protection from unexpected noise produced by other nearby electrical devices that may interfere with the performance of this product.

- Use the product only with the supplied power supply cord set. If you need to replace the power cord set, make sure that the new power cord meets the following requirements: detachable type, UL listed/CSA certified, rated 4.74 A 100 V minimum, 2.7 meters (9 feet) maximum length.

Storing the Monitor

Store the LCD display in a room with a temperature range of -20°C to 60°C (-4 °F to 140°F) to prevent permanent damage, avoiding storing the LCD display outside of this temperature range.

Product Servicing

Do not attempt to service this product yourself, as opening or removing covers may expose you to dangerous voltage points or other risks. Refer all servicing to qualified service personnel.

Unplug this product from the wall outlet and refer servicing to qualified service personnel when:

- the power cord or plug is damaged, cut or frayed
- liquid was spilled into the product
- the product was exposed to rain or water
- the product has been dropped or the case has been damaged
- the product exhibits a distinct change in performance, indicating a need for service
- the product does not operate normally after following the operating instructions



.....

Note: Adjust only those controls that are covered by the operating instructions, since improper adjustment of other controls may result in damage and will often require extensive work by a qualified technician to restore the product to normal condition.

Potentially Explosive Environments

Switch off your device in any area with a potentially explosive atmosphere and obey all signs and instructions. Potentially explosive atmospheres include areas where you would normally be advised to turn off your vehicle engine. Sparks in such areas could cause an explosion or fire resulting in bodily injury or even death. Switch off the device near gas pumps at service stations. Observe restrictions on the use of radio equipment in fuel depots, storage and distribution areas; chemical plants; or where blasting operations are in progress. Areas with a potentially explosive atmosphere are often, but not always, marked. They include below deck on boats, chemical transfer or storage facilities, vehicles using liquefied petroleum gas (such as propane or butane), and areas where the air contains chemicals or particles such as grain, dust or metal powders.

Additional Safety Information

Your device and its enhancements may contain small parts. Keep them out of the reach of small children.

IT Equipment Recycling Information

Acer is strongly committed to environmental protection and views recycling, in the form of salvaging and disposal of used equipment, as one of the company's top priorities in minimizing the burden placed on the environment.

We at Acer are very conscious of the environmental effects of our business and strive to identify and provide the best working procedures to reduce the environmental impact of our products.

For more information and help when recycling, please go to this website:

<http://www.acer-group.com/public/Sustainability>

Visit www.acer-group.com for further information on the features and benefits of our other products.

Recycling Information for the United States of America

Acer encourages information technology (IT) equipment owners to responsibly recycle their equipment when it is no longer needed. Acer offers programs and services to assist equipment owners with this process.

For more information on recycling IT equipment, please go to:

<https://www.acer.com/ac/en/US/content/recycling>

Disposal of Waste Equipment

This symbol on the product or on its packaging indicates that this product must not be disposed of with your other household waste. Instead, it is your responsibility to dispose of your waste equipment by handing it over to a designated collection point for the recycling of waste electrical and electronic equipment. The separate collection and recycling of your waste equipment at the time of disposal will help to conserve natural resources and ensure that it is recycled in a manner that protects human health and the environment.



LCD Pixel Statement

The LCD unit is produced with high-precision manufacturing techniques. Nevertheless, some pixels may occasionally misfire or appear as black or red dots. This has no effect on the recorded image and does not constitute a malfunction.

Power Mode:

- On
 - In Off mode, press the power button to enter On mode.
 - In Sleep mode, press the power/menu/function-ok button to enter On mode.
- Sleep
 - No signal from PC, enters sleep mode in 3 seconds
 - No cable connection, enters sleep mode in 1 minute
- Off
 - In On mode, press the power button to enter Off mode

Waking up the Monitor

Follow the instructions below to wake the monitor up from **Sleep** mode:

- When an input signal cable is connected and the monitor has entered sleep mode, resend a signal to the monitor.
- When no input signal cable is connected and the monitor has entered sleep mode, connect an input signal cable to the monitor.
- When the monitor has entered sleep mode, pressing any button (except the power button) will open the OSD menu to allow you to select an input signal.

Tips and Information for Comfortable use

Computer users may complain of eyestrain and headaches after prolonged use. Users are also at risk of physical injury after long hours of working in front of a computer. Long work periods, bad posture, poor work habits, stress, inadequate working conditions, personal health and other factors greatly increase the risk of physical injury.

Incorrect computer usage may lead to carpal tunnel syndrome, tendonitis, tenosynovitis or other musculoskeletal disorders. The following symptoms may appear in the hands, wrists, arms, shoulders, neck or back:

- numbness, or a burning or tingling sensation
- aching, soreness or tenderness
- pain, swelling or throbbing
- stiffness or tightness
- coldness or weakness

If you have these symptoms, or any other recurring or persistent discomfort and/or pain related to computer use, consult a physician immediately and inform your company's health and safety department.

The following section provides tips for more comfortable computer use.

Finding your comfort zone

Find your comfort zone by adjusting the viewing angle of the monitor, using a footrest, or raising your sitting height to achieve maximum comfort. Observe the following tips:

- refrain from staying too long in one fixed posture
- avoid slouching forward and/or leaning backward
- stand up and walk around regularly to remove the strain on your leg muscles

Taking care of your vision

Long viewing hours, wearing incorrect glasses or contact lenses, glare, excessive room lighting, poorly focused screens, very small typefaces and low-contrast displays could stress your eyes. The following sections provide suggestions on how to reduce eyestrain.

Eyes

- Every hour of use, rest your eyes for more than 5 minutes.
- Give your eyes regular breaks by looking away from the monitor and focusing on a distant point.

- Blink frequently to keep your eyes from drying out.

Display

- Keep your display clean.
- Keep your head at a higher level than the top edge of the display so your eyes point downward when looking at the middle of the display.
- Adjust the display brightness and/or contrast to a comfortable level for enhanced text readability and graphics clarity.
- Eliminate glare and reflections by:
 - placing your display in such a way that the side faces the window or any light source
 - minimizing room light by using drapes, shades or blinds
 - using a task light
 - changing the monitor's viewing angle
 - using a glare-reduction filter
 - using a display visor, such as a piece of cardboard extended from the display's top front edge

Avoid adjusting your display to an awkward viewing angle.

Avoid looking at bright light sources, such as open windows, for extended periods of time.

Developing good work habits

Develop the following work habits to make your computer use more relaxing and productive:

- Take short breaks regularly and often.
- Perform some stretching exercises.
- Breathe fresh air as often as possible.
- Exercise regularly and maintain a healthy body.

Acer monitor is purposed for video and visual display of information obtained from electronic devices.



.....

NOTE:

1. Rest for 10 minutes after every 30 minutes.
2. Children under 2 years old should stay away from this product.

Children 2 years old or more should not see the screen for more than 1 hour a day.

Special Notes on LCD Monitors.....	iii
Information for your Safety and Comfort	iii
Safety Instructions	iii
Cleaning your Monitor	iii
Connecting/Disconnecting the Device	iv
General Instructions	iv
Accessibility	v
Safe Listening	v
Warnings.....	v
Using Electrical Power	vi
Storing the Monitor	vii
Product Servicing	vii
Potentially Explosive Environments	vii
Disposal of Waste Equipment.....	viii
LCD Pixel Statement.....	ix
Power Mode:	ix
Waking up the Monitor.....	ix
Tips and Information for Comfortable use	x
Finding your comfort zone.....	x
Taking care of your vision	x
Developing good work habits	xi
Unpacking.....	1
Attaching/Removing the base	2
Attaching/Removing the base (for VESA wall mount).....	4
Adjusting the viewing angle.....	5
Connecting the power cord	6
Power saving.....	6
Display Data Channel (DDC).....	6
FreeSync Premium (HDMI / DP / Type C)	6
Low Blue Light Mode	7
Standard Timing Table	8
Setting Up the Monitor	9
Connections for 2D Video	9
Connections for 3D Video	10
Connecting your Monitor to a Power Source	11
Powering On/Off the Monitor	12
Control Panel.....	13
Download software	14
Changing the Refresh Rate	15
User Tutorial for best 3D Performance	17
On Screen Display (OSD) Menu	22
Troubleshooting.....	33

Unpacking

Please check that the following items are present when you unpack the box, and save the packing materials in case you need to ship or transport the monitor in the future.

LCD monitor

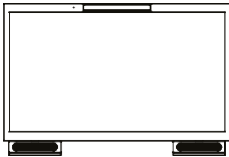

Quick Start Guide



Support Stand



Support Base



Power Adapter

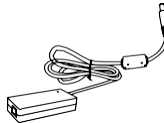

Power Cord



HDMI Cable



USB-A-to-USB-C Cable

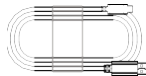

Attaching/Removing the base

1. Remove the support base, support stand, and accessories from the package.
2. Attach the support stand onto the support base and turn the thumb screw at the bottom of the base in a clockwise direction to secure the support stand onto the support base.

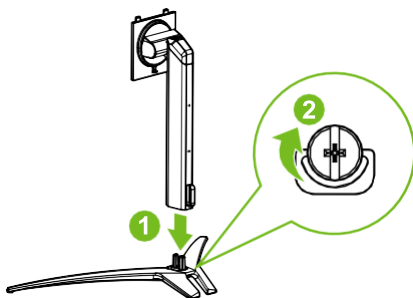

3. Remove the monitor from the package.
4. Place the monitor face down on the edge of a flat and stable surface covered by a protective sheet so that the display is laying flat on the surface and the speakers are over the edge.

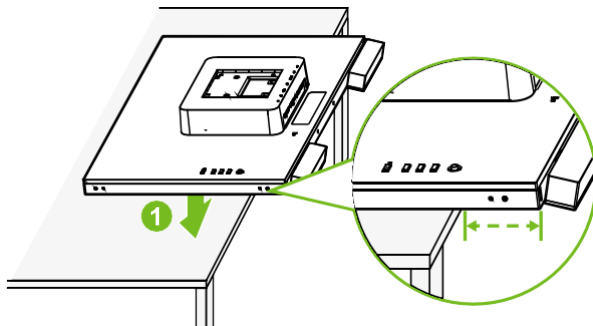

- At an angle of about 45 degrees insert the support stand tabs into the holes on the rear side of the display.

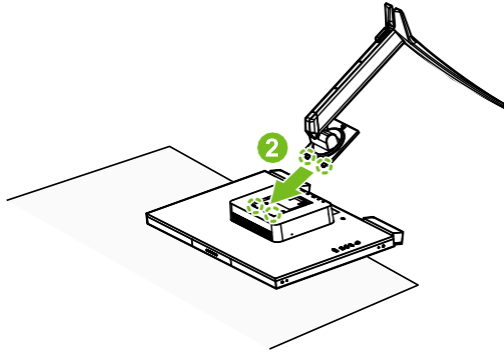

- Push the support stand downwards until the release latch clicks in place, indicating that the support stand has been locked securely in place.

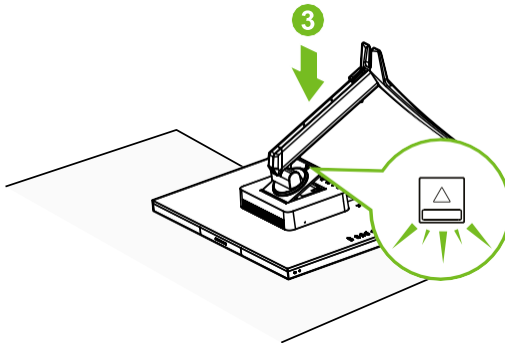

Attaching/Removing the base (for VESA wall mount)

To mount the monitor using a VESA wall mount:

1. Do not install the monitor support stand and base.
2. If the monitor support stand and base have been already installed, remove them by reversing the previous attaching/removing the base instructions.

The VESA mounting screw holes can be found on the rear side of the monitor display as shown in the image with the monitor's VESA dimensions below:

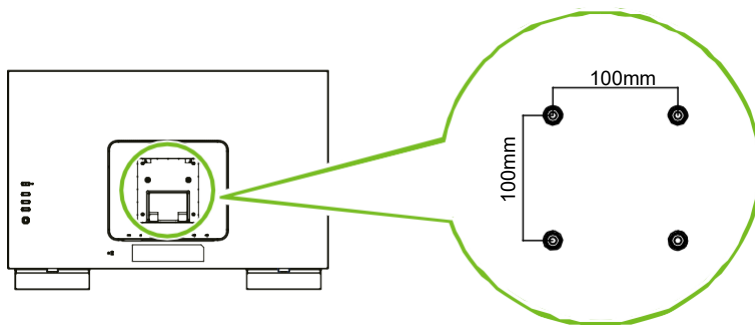

VESA: 100 x 100 mm

Screws: M4 x 10 mm

Adjusting the viewing angle

To optimize the viewing experience, you can adjust the tilt or height of the monitor by holding the left and right sides of the monitor. The tilt can be adjusted to a 18-degree angle upwards or a 5-degree angle downwards.

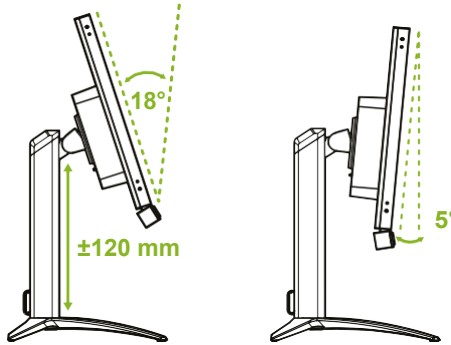

The monitor can be rotated 15 degrees in each direction.

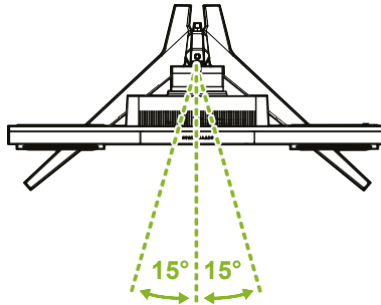

Pull down or lift up to adjust the height by holding the left and right sides of the monitor.

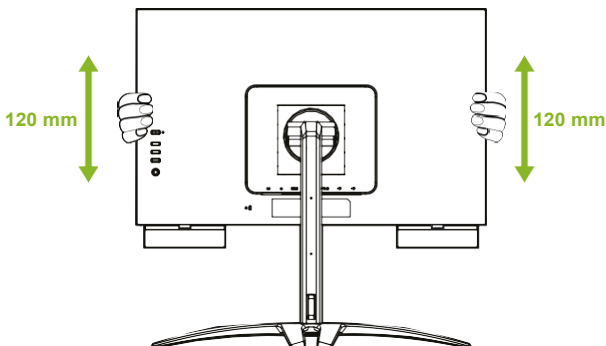

Connecting the power cord

- Check first to make sure that the power cord you use is the correct type required for your area.
- The monitor has a universal power supply that allows operation in either 100/120 V AC or 220/240 V AC voltage area. No user-adjustment is required.
- Plug one end of the power cord to the AC inlet, and plug the other end into an AC outlet.
- For units using 120 V AC:
Use a plug rated 4.74 A/125 V.
- For units using 220/240 V AC:
Use a plug rated 4.74 A/220 V. The cord set should have the appropriate safety approvals for the country in which the equipment will be installed.

Power saving

The monitor will be put into “power saving” mode if the monitor does not detect any input signals for about one minute, as indicated by the amber power LED.

Mode	LED light
On	Blue
Power saving	Amber
Off	Off

The power saving mode will be kept until an input signal has been detected or the keyboard or mouse is activated. The recovery time from “power saving” mode back to “on” is around 3 seconds (Auto Source off).

Display Data Channel (DDC)

To make installation easier, the monitor supports plug-and-play functionality as long as your system is compatible with the DDC protocol. The DDC is a communication protocol through which the monitor automatically informs the host system about its capabilities, such as supported resolutions and corresponding timing. The monitor supports the DDC2B standard.

FreeSync Premium (HDMI / DP / Type C)

The monitor allows a FreeSync Premium supported graphics source to dynamically adjust display refresh rate based on typical content frame rates for power efficient, virtually stutter free and low-latency display update.

Low Blue Light Mode

This display features **Low Blue Light** capabilities which help reduce the blue light emissions. When the **Low Blue Light** feature is set at level 4, it will also be compliant with TÜV Rheinland's low blue light certification requirements.

When **Low Blue Light** is set to level 1/2/3/4, the wavelength of the blue light that is between 400 nm and 500 nm will be reduced, which can provide optimal image quality while helping relax eye strain.

You can adjust the low blue light settings in the **Picture** sub-menu of the OSD menu.

Configuring the Low Blue Light Mode

1. Press the joystick to open the OSD menu.
2. Toggle the joystick to navigate the OSD menu.
3. Select the **Picture** sub-menu.
4. Select **Low Blue Light** in the **Picture** sub-menu.
5. Toggle the joystick left/right to configure the display's low blue light settings.

Standard Timing Table

No.	Mode	Resolution	Refresh Rate	
1	VGA	640x480	60	Hz
2		640x480	72	Hz
3		640x480	75	Hz
4	MAC	640x480	66.66	Hz
5	VESA	720x400	70	Hz
6	SVGA	800x600	56	Hz
7		800x600	60	Hz
8		800x600	72	Hz
9		800x600	75	Hz
10	MAC	832x624	74.55	Hz
11	XGA	1024x768	60	Hz
12		1024x768	70	Hz
13		1024x768	75	Hz
14	MAC	1152x870	75	Hz
15	VESA	1152x864	75	Hz
16		1280x960	60	Hz
17	SXGA	1280x1024	60	Hz
18		1280x1024	75	Hz
19	VESA	1280x720	60	Hz
20	WXGA+	1440x900	60	Hz
21	WSXGA+	1680x1050	60	Hz
22	FHD	1920x1080	60	Hz
23	QHD	2560x1440	60	Hz
24		2560x1440	120	Hz
25		2560x1440	144	Hz
26		2560x1440	160	Hz
27	UHD	3840x2160	60	Hz
28		3840x2160	120	Hz
29		3840x2160	144	Hz
30		3840x2160	160	Hz

Setting Up the Monitor

Connections for 2D Video

To connect the monitor to a computer for 2D video, follow either of the three configurations below:

1. HDMI Cable

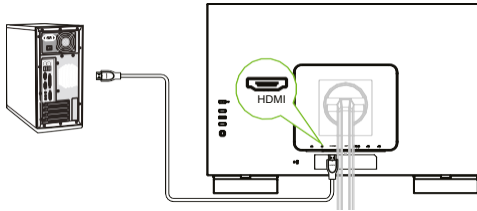

2. DP Cable

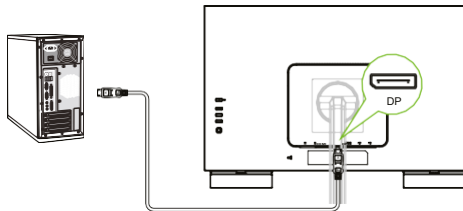

3. USB Type-C Cable

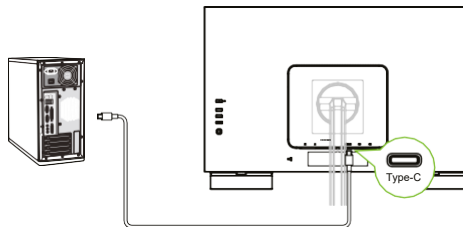

.....
Note: Before making connections, make sure that the power for all the connected equipment is off.



.....
Note: Please do not use a USB extension cord for the USB-A ports.



.....
Note: The DP and USB Type-C cables are not included in the package contents.

Connections for 3D Video

To connect the monitor to a computer for 3D video, follow either of the three configurations below:

1. HDMI and USB-A-to-Type-C Cable

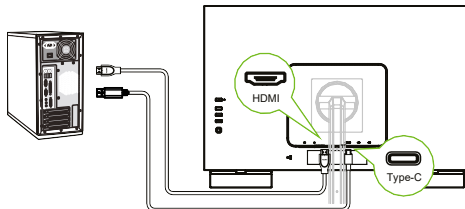

2. DP and USB-A-to-Type-C Cable

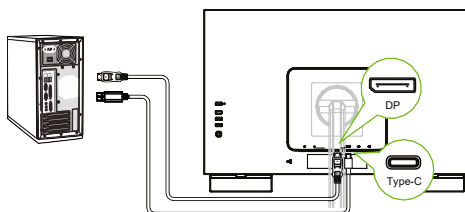

3. USB Type-C Cable

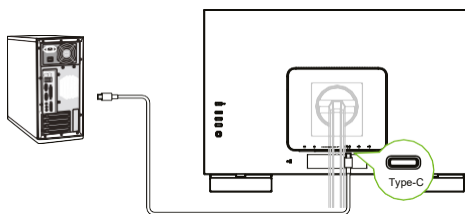

.....

Note: Before making connections, make sure that the power for all the connected equipment is off.



.....

Note: Please do not use a USB extension cord for the USB-A ports.



.....

Note: The DP and USB Type-C cables are not included in the package contents.

Connecting your Monitor to a Power Source



Note: If you want to move the monitor, hold the bottom side of the monitor. Lifting up the monitor by holding its base may damage the monitor.

Follow the steps below to connect the monitor to your computer:

1. Connect the power adapter to the DC-in port on the monitor.
2. Connect the power cord to the power adapter.
3. Fully insert the power cord plug into the power outlet socket.

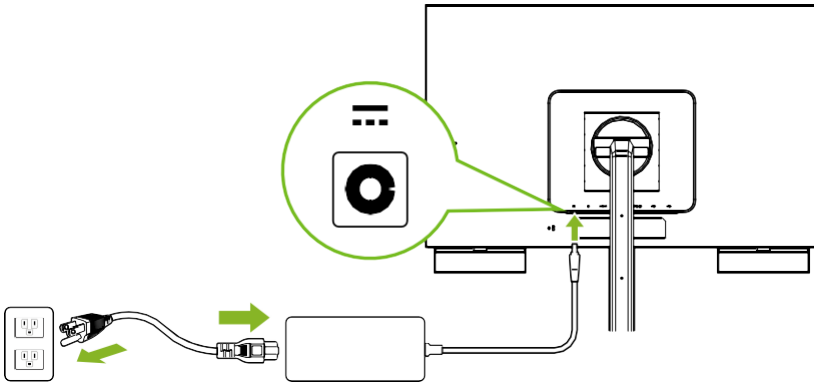

Connect the HDMI/DP/DP ALT cables to your computer according to the instructions in either the 2D or 3D video connections sections. See the following page(s) for more information.

Powering On/Off the Monitor

To power on the monitor, press the power button located on the left side of the rear panel.

When the monitor is turned on, power off the monitor by pressing the power button.





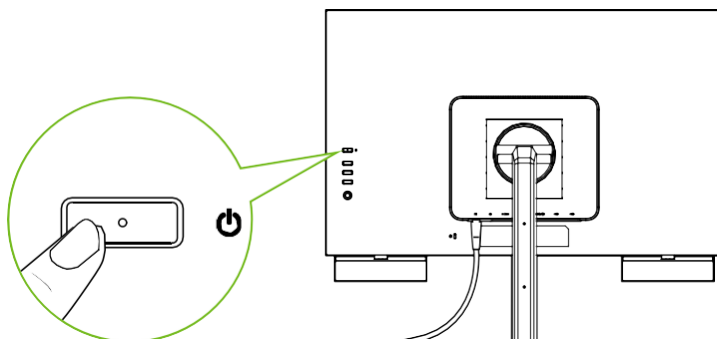

Note: The display will power on automatically anytime the power cord is plugged into the power outlet socket. It is not recommended to remove the power cord from the power outlet socket in order to shut the monitor down after finishing the installation. Use the power button to power off the monitor.

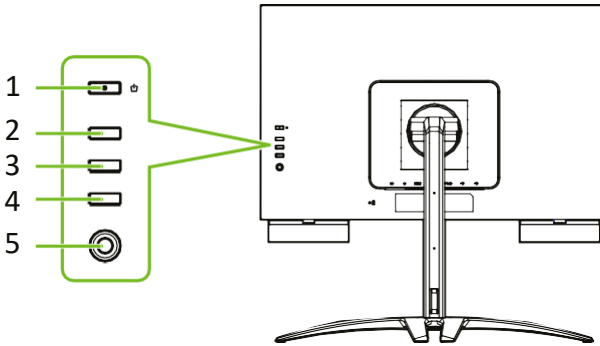

Control Panel

The four buttons and a small joystick located on the left side of the rear panel can be used to control and configure the monitor.



1	Power Button	<ul style="list-style-type: none"> • Turns the monitor on/off.
2	Hot Key 1 	<ul style="list-style-type: none"> • Opens the OSD portal. • When the OSD portal is opened, press to enter the assigned hot key function. • Opens Information after entering the main OSD menu.
3	Hot Key 2 	<ul style="list-style-type: none"> • Opens the OSD portal. • When the OSD portal is opened, press to enter the assigned hot key function. • Opens Modes after entering the main OSD menu.
4	Hot Key 3 	<ul style="list-style-type: none"> • Opens the OSD portal. • When the OSD portal is opened, press to enter the input source menu. • Exits the main OSD menu.
5	Joystick 	<ul style="list-style-type: none"> • Opens the OSD portal. • When the OSD portal is opened, press to enter the main OSD menu. • Toggle the joystick up/down/left/right to navigate the OSD menu. • Press the joystick to confirm selections.

Download software

1. Please visit <https://www.acer.com> to download the “SpatialLabs Experience Center” application.
2. Go to **SUPPORT** -> **GET SUPPORT**.
3. Type your device model name “PSV27-2” or type the serial number or SNID to find the product.
4. In **Drivers and Manuals** -> **Application** to download the “SpatialLabs Experience Center”.

Changing the Refresh Rate

The monitor is set to a default refresh rate of 60Hz, while supporting a refresh rate of up to 160Hz.

If your PC supports a refresh rate higher than the default rate, follow the steps below to toggle the refresh rate to a higher setting.



CAUTION: If your PC does not support a 160Hz refresh rate, do not change the refresh rate to a higher rate, doing so may cause the monitor to freeze.

1. On your PC's desktop, right click and select **Display settings**.

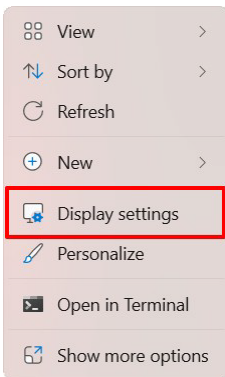

2. In the Display settings menu, select **Advanced display**.

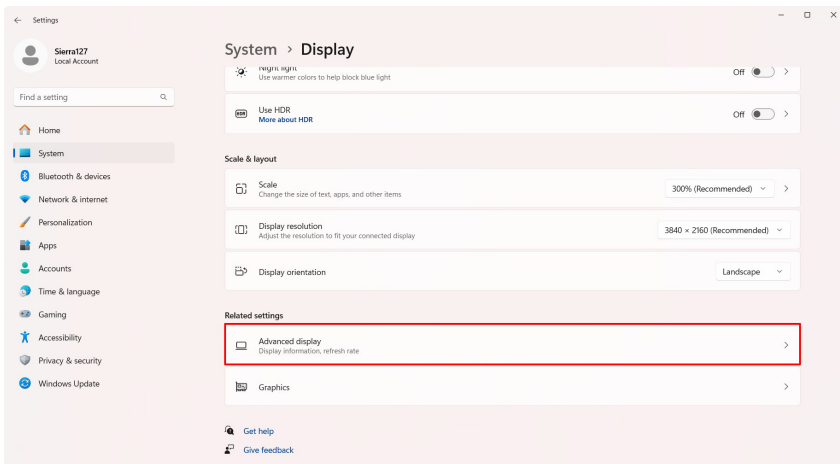

3. In the **Advanced display** menu, select Choose a refresh rate and then select the refresh rate you want for the display.

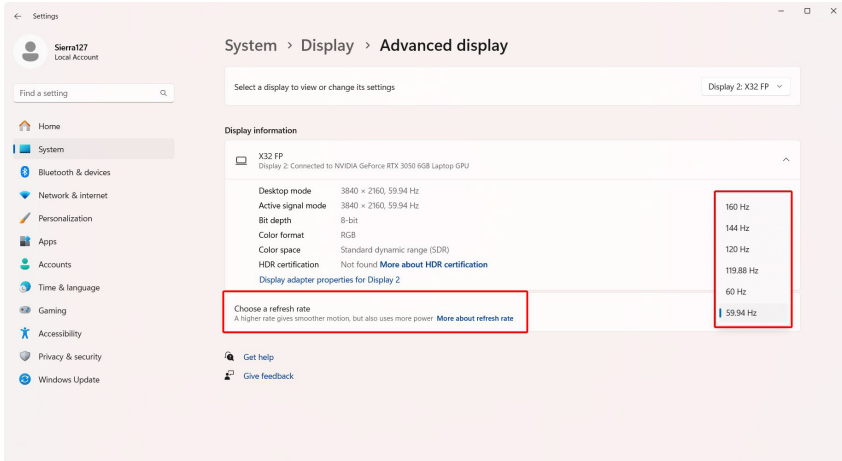

User Tutorial for best 3D Performance

1. Make sure the environment is well lit.



2. Avoid placing the tracking cameras under direct light.



3. Make sure your face is completely visible.

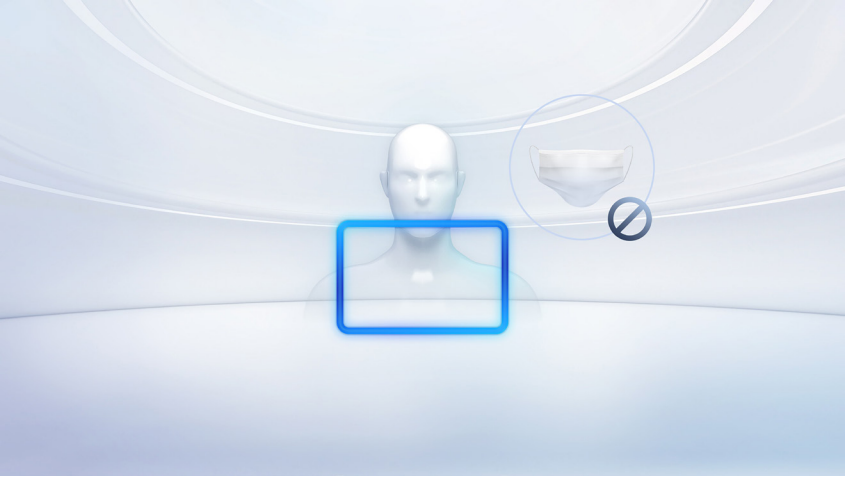

4. Align your body with the center of your display and make sure the camera is directed at your face.

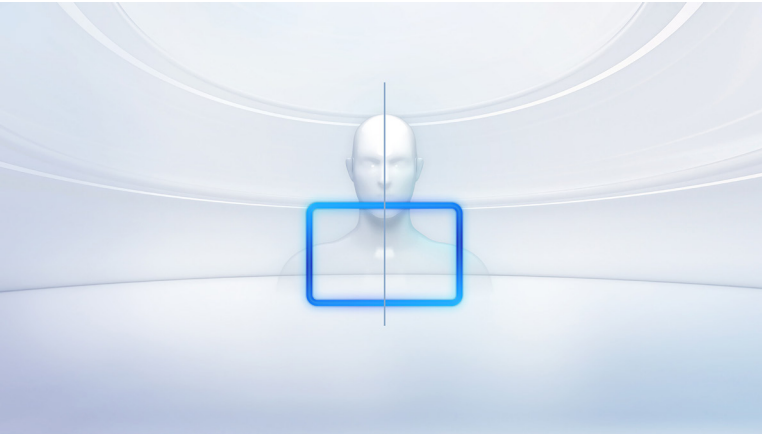

5. Make sure your computer is always plugged into a power source.



6. Make sure the screen resolution of your SpatialLabs device is set to 3840x2160, and is in extended mode while using multiple monitors.

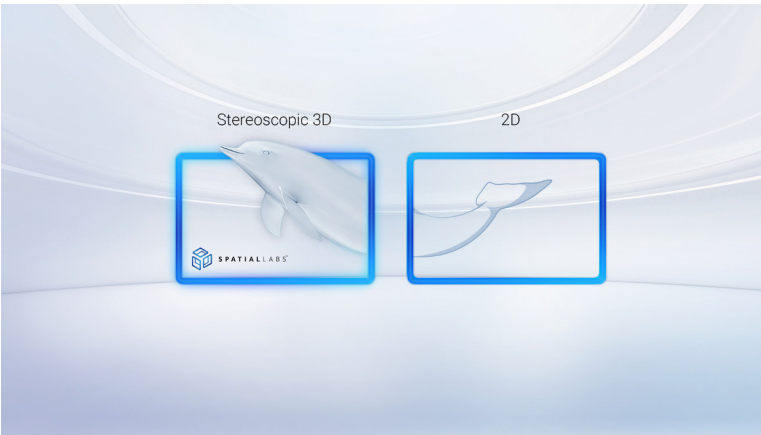

7. Feel free to move your head to observe different angles, but avoid any sudden or large movements.



8. The SpatialLabs experience is best suited for one person at a time.



9. Please take a rest if you experience any eye fatigue or discomfort.



On Screen Display (OSD) Menu



Note: The following content is for general reference only. Actual product specifications may vary.

The OSD (On Screen Display) menu can be used to adjust the monitor's settings. You can use the joystick or hot keys on the rear panel of the monitor to access and navigate the OSD menu.

1. Press the joystick or one of the three hot keys on the rear panel of the monitor to open the OSD portal.
2. Press the joystick to open the OSD menu.
3. Toggle the joystick up/down/left/right to navigate the OSD menu.
4. Press the joystick to confirm selections.
5. Toggle the joystick left/right to adjust settings.
6. Press the joystick to confirm changes.

OSD portal

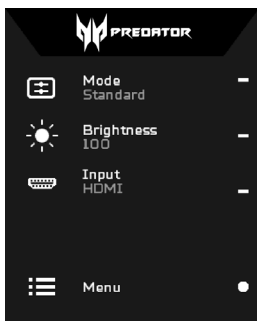

- Hot key 1 (Modes / Volume / Gamma / Contrast / Low Blue Light / Over Drive / VRB)
- Hot key 2 (Brightness / Volume / Gamma / Contrast / Low Blue Light / Over Drive / VRB)
- Hot key 3 (Input source, not configurable)
- Joystick (Main OSD menu)

Hot key 1 (default: Standard mode)

Select **Mode** to view more setting options. The options include: **sRGB**, **Reading**, **Darkroom**, **User**, **Standard**, **ECO**, **Graphics**, and **Movie**.

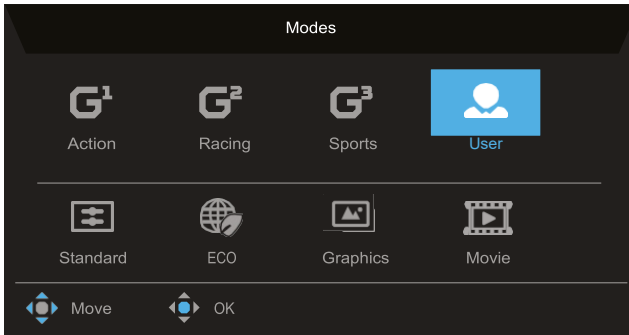

Hot key 2 (default: Brightness)

Select **Brightness** and then adjust the brightness of the monitor.

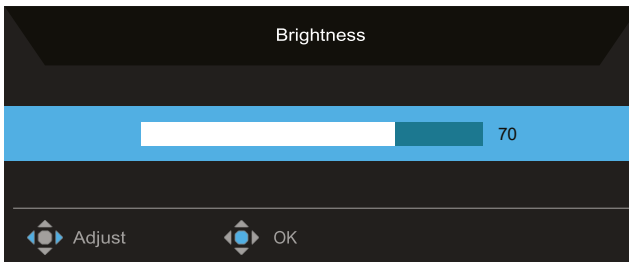

Hot key 3 (default: HDMI)

Select **Input** to view more setting options. The options include: **HDMI**, **DP**, **DP ALT**, and **Auto Source**.

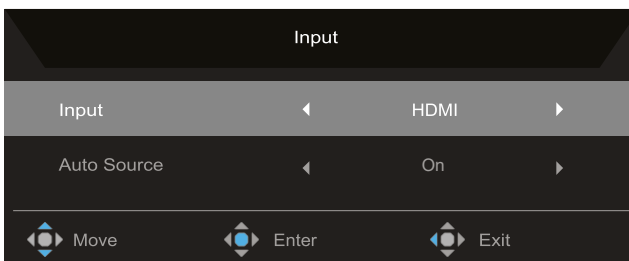

Main OSD menu

The main OSD menu lists all setting options that allow users to make adjustments to the monitor. To open the main OSD menu, select **Menu** in the OSD portal.



Note: A **Save Settings to...** menu option appears when any change has been made in the main OSD menu. This menu option allows you to save the changes made in the OSD main menu under three different gaming modes on the monitor.

Shortcut keys

The OSD menu features three shortcut keys at right side of each sub-menu page.



- : Opens the **Information** section.
- : Opens the **Modes** menu.
- : Exits the OSD menu.

Adjusting the Picture settings

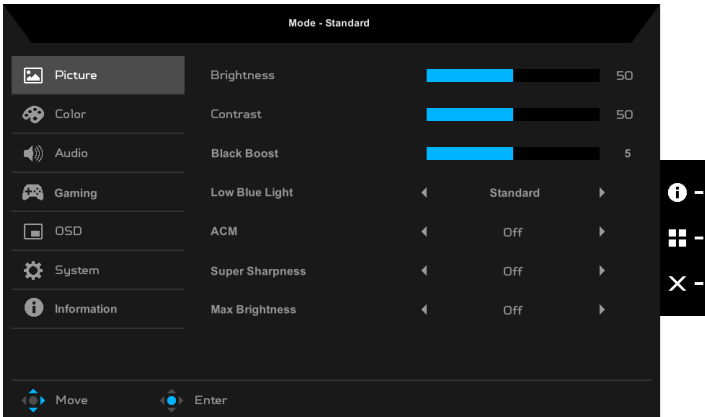

The setting options include:

- **Brightness:** Adjusts the brightness of the monitor (0 to 100). Default: **70**.
- **Contrast:** Adjusts the contrast of the monitor (0 to 100). Default: **50**.



Note: **Contrast** sets the degree of difference between light and dark areas.

- **Black Boost:** Adjusts the black level of the monitor to make details in shaded areas more visible (0 to 10). Default: **5**.
- **Low Blue Light:** Filters out blue light to protect your eyes (**Standard / Level 1 / Level 2 / Level 3 / Level 4**). Default: **Standard**.



.....

Note: The lower the level is, the more blue light passes through.

- **ACM:** Enables/Disables the Adaptive Contrast Management function (**Off / On**). Default: **Off**.
- **Super Sharpness:** Enables/Disables the Super Sharpness function (**Off / On**). This technology can simulate high-resolution images by enhancing the pixel density in videos and images. Default: **Off**.
- **Max Brightness:** Default is **Off**.



.....

Note: Due to environmental considerations, the default brightness of the monitor will be low. It can be adjusted to your preference with the following steps:

Step 1: Go to OSD menu > **Picture** > **Max Brightness**, and turn **Off** to **On** to increase the brightness.

Step 2: When **Max Brightness** is turned on, adjust **Brightness** value between 0 and 100 to your preference.

Adjusting the Color settings

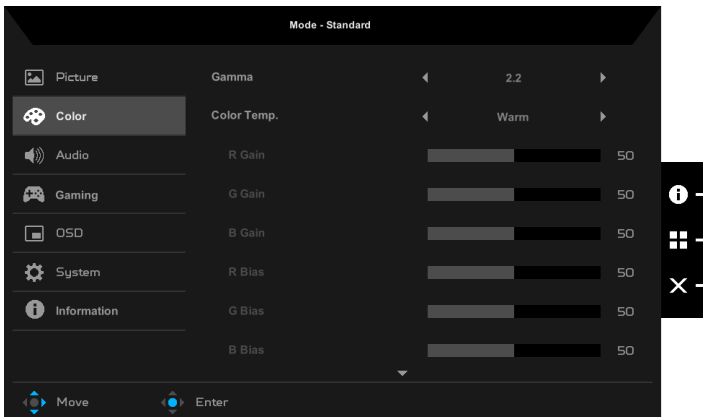

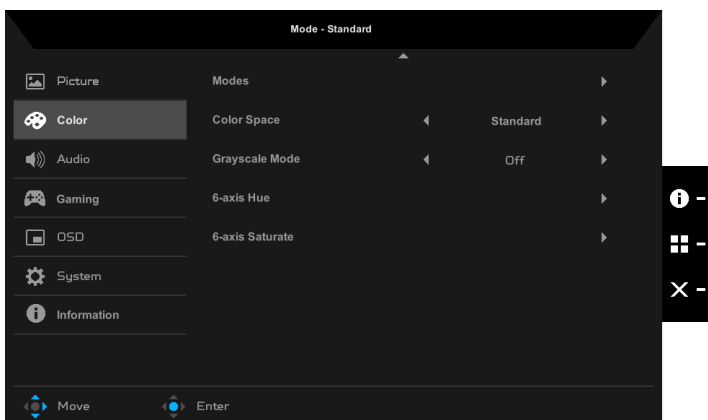

The setting options include:

- **Gamma:** Adjusts the mid-tone contrast of the monitor (**1.8 / 2.0 / 2.2 / 2.4 / 2.6**). Default: **2.2**.
- **Color Temp.:** Adjusts the color temperature of the monitor (**Warm / Normal / Cool / Low Blue Light / User**). Default: **Warm**.
 - **R/G/B Gain:** Adjusts R/G/B gain of the monitor (0 to 100). Default: **50**.
 - **R/G/B Bias:** Adjusts R/G/B bias of the monitor (0 to 100). Default: **50**.
- **Modes:** Opens the **Modes** menu (**Action / Racing / Sports / User / Standard / ECO / Graphics / Movie**). Default: **Standard**.
- **Color Space:** Sets the color space of the monitor (**sRGB / Rec. 709 / EBU / DCI / SMPTE-C / Standard**). Default: **Standard**.
- **Grayscale Mode:** Enables/Disables the grayscale mode (**Off / On**). Default: **Off**.
- **6-axis Hue:** Adjusts/Resets the hue of red, green, blue, yellow, magenta or cyan (0 to 100). Default: **50**.
- **6-axis Saturate:** Adjusts/Resets the saturation of red, green, blue, yellow, magenta or cyan (0 to 100). Default: **50**.

Adjusting the Audio settings

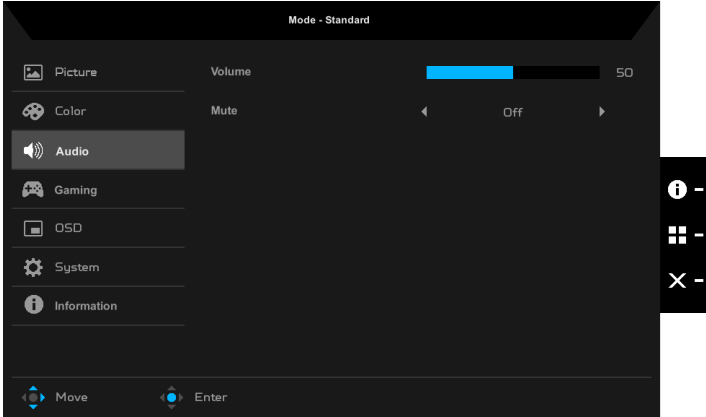

The setting options include:

- **Volume:** Adjusts the volume of the speakers (0 to 100). Default: **70**.
- **Mute:** Turns the sound off or on (**Off / On**). Default: **Off**.

Adjusting the Gaming settings

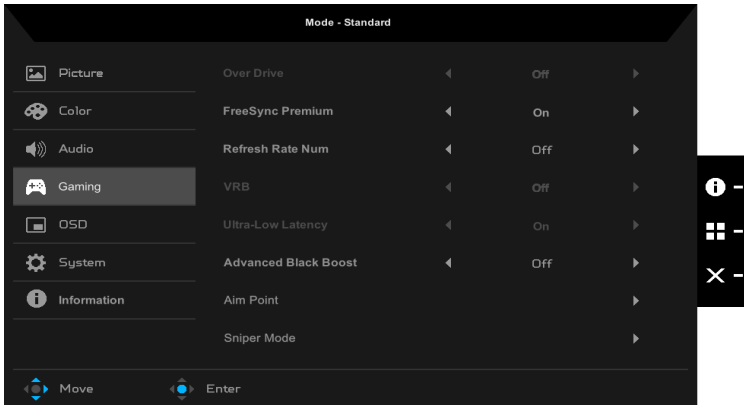

The setting options include:

- **Over Drive:** Configures the monitor to make the pixels transition colors faster (**Off / Normal / Extreme**). Default: **Normal**.

- **FreeSync Premium:** Enables/Disables the FreeSync Premium technology which is supported by AMD's graphic cards (**Off / On**). Default: **On**.



Note:

1. The **FreeSync Premium** function is only enabled when the input signal meets FreeSync requirements.
2. Please update FreeSync to the latest AMD driver.

- **Refresh Rate Num:** Displays the monitor's refresh rate (**Off / On**). Default: **Off**.



Note: When **Refresh Rate Num** is set to **On**, the monitor's refresh rate will be displayed on the screen.

- **VRB:** Visual Response Boost (VRB) decreases blur in fast moving images (**Off / Normal / Extreme**). Default: **Off**.



Note: The VRB function is only available at frame rates of 75Hz to 180Hz.

- **Ultra-Low Latency:** Enables/Disables the monitor's latency function which helps to speed up the image processing and optimize your gaming experience (**Off / On**). Default: **On**.



Note:

1. If **FreeSync Premium** is set to **On**, **Ultra-Low Latency** will be set to **On** automatically and cannot be configured.
2. If **FreeSync Premium** is set to **Off**, users can set **Ultra-Low Latency** to **Off** or **On**.
3. **Ultra-Low Latency** does not support the resolutions lower than 800x600 and the V-Frequency lower than 48Hz.

- **Advanced Black Boost:** Enables/Disables the monitor's advanced black boost function which enhances shadows by increasing the brightness without changing lighter shades (**Off / On**). Default: **Off**.
- **Aim Point:** Configures the monitor's aim point function which shows aim point crosshairs on the display for first-person shooter (FPS) games.
 - **Cross Hair:** Enables/Disables the aim point crosshairs function of the monitor (**Off / On**). Default: **Off**.
 - **H. Position:** Adjusts the horizontal position of the aim point crosshairs on the monitor's display (-5 to 5). Default: **0**.

- **V. Position:** Adjusts the vertical position of the aim point crosshairs on the monitor's display (-5 to 5). Default: **0**.
- **Color:** Changes the color of the aim point crosshairs on the monitor's display (**White / Red / Green / Auto**). Default: **White**
- **Icon:** Selects the monitor's aim point crosshairs icon type (**Icon 1 / Icon 2 / Icon 3**). Default: **Icon 1**.
- **Sniper Mode:** Configures the monitor's sniper mode function which magnifies the center portion of the display for first-person shooter (FPS) games.
 - **Scope:** Enables/Disables the sniper mode scope function of the monitor (**Off / On**). Default: **Off**.
 - **Scope Ratio:** Adjusts the magnification of the scope on the monitor's display (**1.5x / 2x / 4x**). Default: **2x**.
 - **Scope Size:** Adjusts the size of the scope on the monitor's display (**Small / Middle / Large**). Default: **Middle**.
 - **Scope with Night Vision:** Enables/Disables the scope's night vision function. (**Off / On**). Default: **Off**.

Adjusting the OSD settings

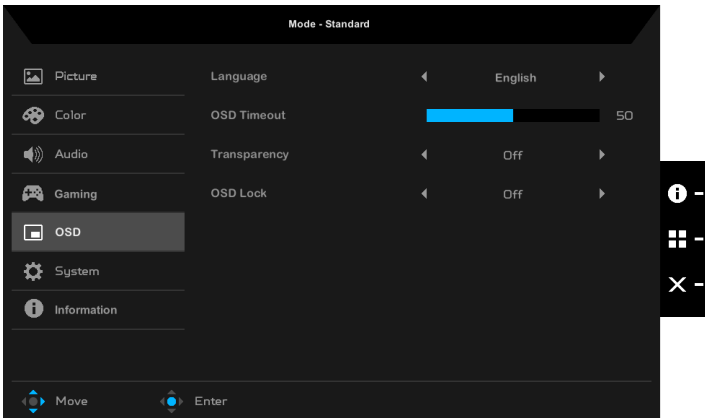

The setting options include:

- **Language:** Changes the OSD menu language. Default: **English**.
- **OSD Timeout:** Sets the number of seconds the OSD menu is displayed before it automatically closes (10 to 120 seconds). Default: **10**.
- **Transparency:** Sets the transparency of the OSD menu (**Off / 20% / 40% / 60% / 80%**). Default: **Off**.

- **OSD Lock:** Sets the OSD lock (**Off / On**). Default: **Off**.



Note: Under normal display conditions, push and hold the joystick to the right for more than 3 seconds to trigger the OSD unlock function.

Adjusting the System settings

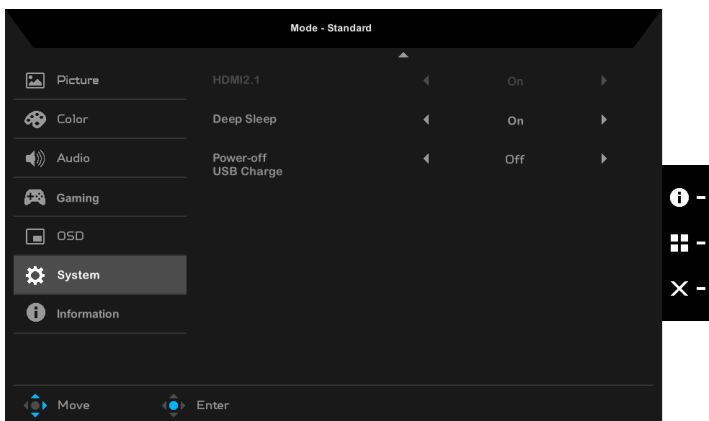
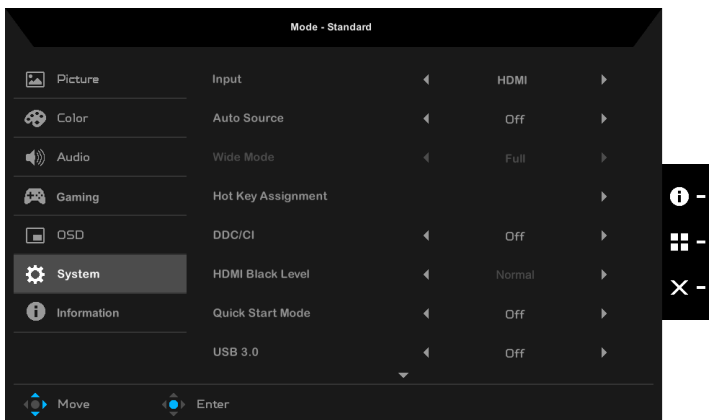

The setting options include:

- **Input:** Selects the input source (**HDMI / DP / DP ALT**). Default: **HDMI**.
- **Auto Source:** Enables/Disables the monitor to automatically search for available input sources (**Off / On**). Default: **On**.
- **Wide Mode:** Adjusts the aspect ratio of the monitor (**Full / Aspect / 1:1**). Default: **Full**.

- **Hot Key Assignment:** Assigns the function that the hot keys on the OSD portal will access.
 - Hot Key 1 (**Modes / Volume / Gamma / Contrast / Low Blue Light / Over Drive / VRB**). Default: **Modes**.
 - Hot Key 2 (**Brightness / Volume / Gamma / Contrast / Low Blue Light / Over Drive / VRB**). Default: **Brightness**.
- **DDC/CI:** Enables/Disables you to configure the monitor using software installed on your computer (**Off / On**). Default: **On**.



.....

Note: DDC/CI stands for Display Data Channel/Command Interface. It enables users to send commands to adjust the monitor's configurations.

- **HDMI Black Level:** Adjusts the black level range of an HDMI input source (**Normal / Low**). Default: **Normal**.
- **Quick Start Mode:** Speeds up the monitor's boot-up process (**Off / On**). Default: **Off**.
- **USB 3.0:** Configures the data transmission speed of the USB Type-C port at the bottom side of the rear panel (**Off / On**). Default: **Off**.



.....

Note:

1. If **USB 3.0** is set to **Off**, the transmission speed of the USB Type-C port will be downgraded to the USB 2.0 specification, which allows the DP Alt (DisplayPort Alternate) mode to support resolution 3840x2160 @160Hz.
2. If **USB 3.0** is set to **On**, the transmission speed of the USB Type-C port will comply with the USB 3.0 specification and the DP Alt mode can support resolution 3840x2160 @60Hz.

- **HDMI 2.1:** Enables/Disables the HDMI 2.1 specification (**Off / On**). Default: **On**.
- **Deep Sleep:** Enables/Disables the deep sleep function (**Off / On**). Default: **On**.
- **Power-off USB Charge:** Enables/Disables the power charging function of the USB port (**Off / On**). Default: **Off**.



Note: If **Power-off USB Charge** is set to **Off**, when the monitor is powered off, you cannot charge your devices using the USB port.

Information

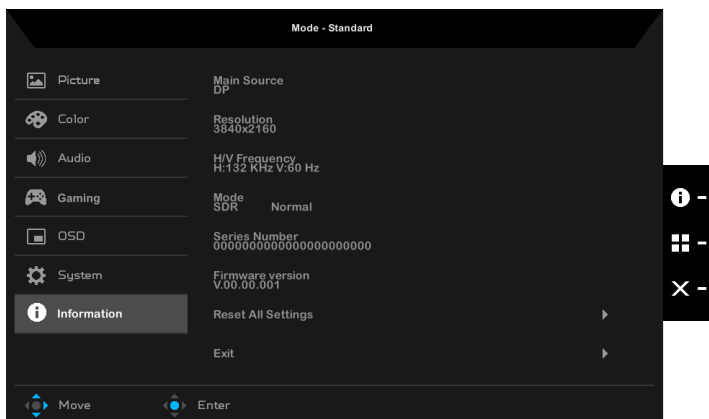

The setting options include:

- **Reset All Settings:** Resets the OSD menu to its default settings.
- **Exit:** Exits the OSD menu.

Troubleshooting

Before sending your LCD monitor for servicing, please check the troubleshooting list below to see if you can self-diagnose the problem.

1. What if there is no stereoscopic 3D effect performed?

- Check the LED next to the SpatialLabs Eye Tracking Camera Module to see if it is turned on or not. The LED should be in amber when the Eye Tracking Camera is working properly.
- Check the Device Manager to see if the SpatialLabs Eye Tracking Camera Module and COM port for 3D display is existing or not.
- Monitor setting
 - i. If there are 2 or more monitors connected, make sure to set each monitor to extend mode.
 - ii. In monitor extend mode, set Acer SpatialLabs PSV27-2 as the main display.

2. Why can't I see the contents in stereoscopic 3D mode?

If you are unable to see the contents in Stereoscopic 3D, you can refer to the following troubleshooting guidelines from the SpatialLabs Experience Center tutorial:

- Ensure that you have sufficient ambient lighting (minimum 100 lumens).
- Avoid having strong light coming from behind the viewer.
- Ensure that your entire face is visible, without wearing a mask.
- Align your body and face with the center of the screen.
- The optimal viewing distance from the viewer to the screen may vary among individuals. It is recommended to adjust your distance to find the most comfortable viewing distance for you, the best viewing distance is 50 cm - 110 cm based on content.

3. Do I have to plug in the AC Power for the host PC when using the device?

It is recommended to keep the AC Power of the host PC plugged in at all times when using the device to prevent Windows from entering Power Saving Mode and ensure optimal performance.

4. Does it support multiple people when viewing Stereoscopic 3D?

The SpatialLabs display experience is suitable for one person at a time only due to its eye-tracking solutions. Therefore, if there are people behind you during the experience, it may affect the viewing result.

5. Why do I see the image blurring when moving my head from side to side, as if there's a layer of shadow on the image?

The phenomenon is known as ghost image. Ghost image occurs when part of the image intended for the left eye overlaps with the right eye, and vice versa. While eye-tracking solution helps reduce this effect by accurately delivering the appropriate images to each eye. However, there are still limitations. Therefore, we recommend avoiding sudden movement to ensure the best viewing experience.

6. Why does the image appear blurry when I drag the model to the front, creating a popping-out effect?

The popping-out effect and focal distance have limitations due to the nature of how our eyes work. For example, if you bring a finger very close to your eyes, you may not be able to focus on it. The same idea applies when you drag the image way out, causing the eyes and brain to experience difficulties in functioning properly. Adjusting the image slightly backward would resolve the issue.



Declaration of Conformity

We,
Acer Incorporated

SF, 88, Sec. 1, Xintai 5th Rd., Xizhi, New Taipei City 221

And,
Acer Italy s.r.l.
Viale delle Industrie 1/A, 20044 Arese (MI), Italy
Tel: +39-02-939-921 ,Fax: +39-02 9399-2913
www.acer.it

Product: LCD Monitor
Trade Name: Acer
Model Number: **PSV27-2**

We, Acer Incorporated, hereby declare under our sole responsibility that the product described above is in conformity with the relevant Union harmonization legislations as below Directive and following harmonized standards and/or other relevant standards have been applied:

-
- EMC Directive: 2014/30/EU
 - EN 55032:2015+AI 1:2020 Class B
 - EN 61000-3-3:2013+AI:2019
 - EN 55035:2017 +AI I :2020
 - EN 61000-3-2:2014 Class D
-
- LVD Directive: 2014/35/EU
 - EN 62368-1: 2014+AI 1:2017
-
- RoHS Directive: 2011/65/EU
 - EN IEC 63000: 2018
-
- ErP Directive: 2009/125/EC
 - Regulation (EU) 2019/2021; EN50564:2011; EN62087
-

Year to begin affixing CE marking: 2023

RU Jan/ Sr.Manager
Acer Incorporated (New Taipei City)

Apr. 1, 2024
Date

acer**Acer America Corporation**

1730 N First St Suite 400,

San Jose, CA 95112

Tel : (408) 533-7700

Fax : (408) 533-4555

www.acer.com

Federal Communications Commission Supplier's Declaration of Conformity

This device complies with Part 15 of the FCC Rules. Operation is subject to the following two conditions: (1) this device may not cause harmful interference, and (2) this device must accept any interference received, including interference that may cause undesired operation.

The following local Manufacturer /Importer is responsible for this declaration:

Product:	LCD Monitor
Model Number:	PSV27-2
Name of Responsible Party:	Acer America Corporation
Address of Responsible Party:	1730 N First St Suite 400, San Jose, CA 95112 U. S. A.
Contact Person:	Acer Representative
Phone No.:	(408) 533-7700
Fax No.:	(408) 533-4555



Product Information for EU Energy



The terms HDMI and HDMI High-Definition Multimedia Interface, and the HDMI Logo are trademarks or registered trademarks of HDMI Licensing LLC in the United States and other countries.

Regulatory Compliance

