



# 4G+ Cat 6 AC1200 Wireless Dual Band Gigabit Router

Enjoy 4G+ Speed  
Sharing Everywhere



Archer MR515

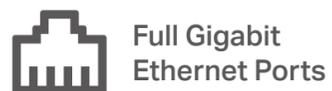

Full Gigabit  
Ethernet Ports



MU-MIMO  
Technology<sup>†</sup>



EasyMesh-Compatible  
Create Seamless Wi-Fi<sup>®</sup>



Advanced Security  
with WPA3<sup>△</sup>

# Highlights

## Fast 4G+ Mobile Broadband Speed

Supports the 4G+ Cat6, which uses Carrier Aggregation technology to boost LTE speeds, MR515 provides fast broadband speeds up to 300 Mbps as your reliable internet access. Plug your SIM card and enjoy HD movies without interruption, downloading files in seconds, and smooth online gaming.

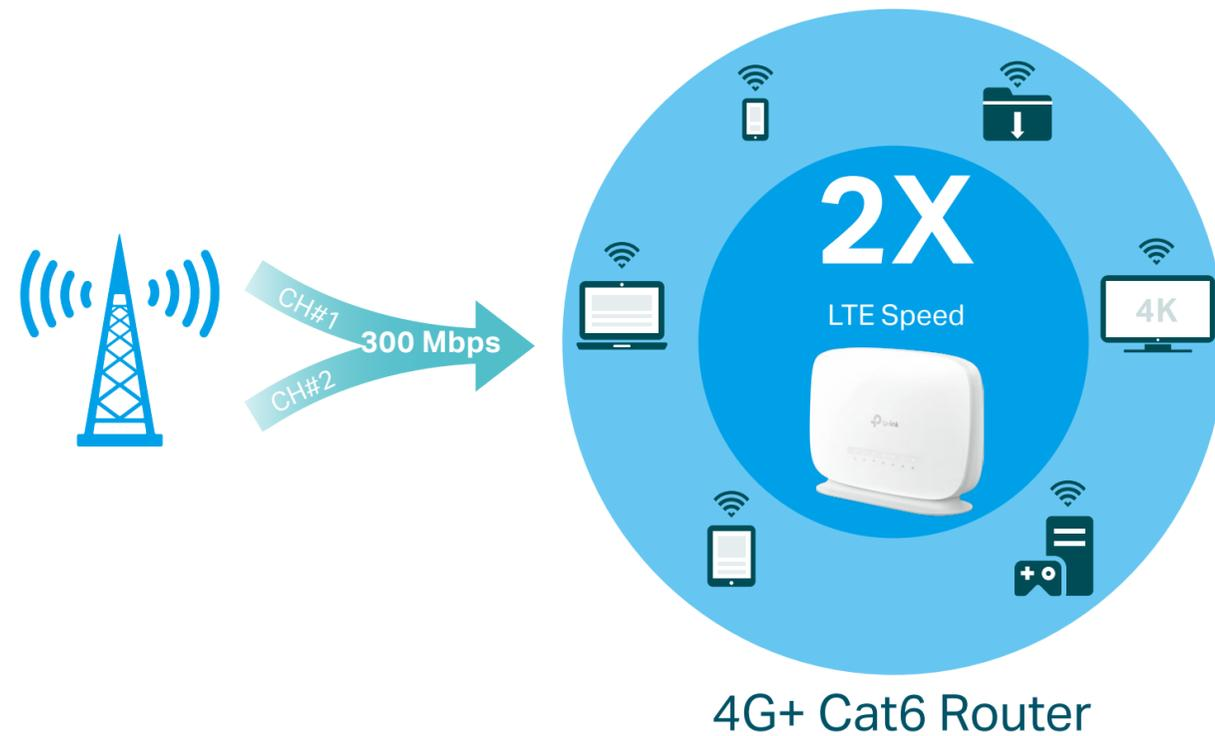

## Vast Wi-Fi Coverage Throughout Your Home

Beamforming concentrates signal towards your connected devices, Power Amplifier and Low Noise Amplifier boost sending and receiving capabilities, both of which boost the signal coverage. Hence MR505 creates a wide and strong AC1200 dual band Wi-Fi network throughout your home.

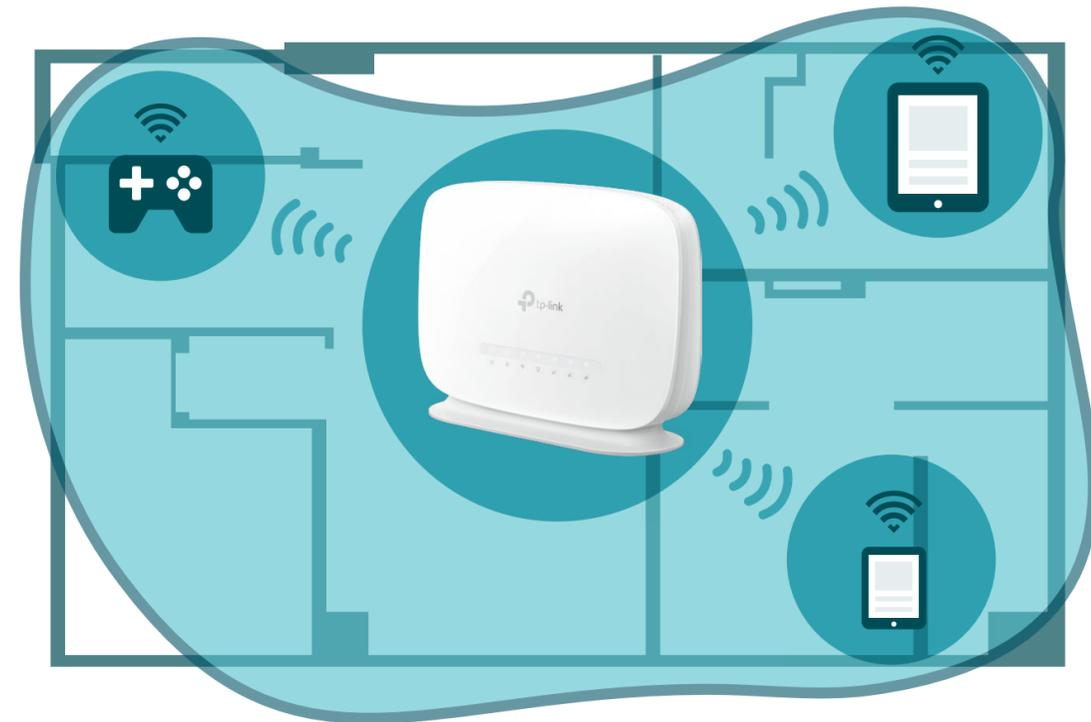

# Highlights

## MU-MIMO for Higher Efficiency

MU-MIMO technology serves multiple devices at once, reducing wait time, increasing Wi-Fi throughput for every device, and making each stream more efficient.†

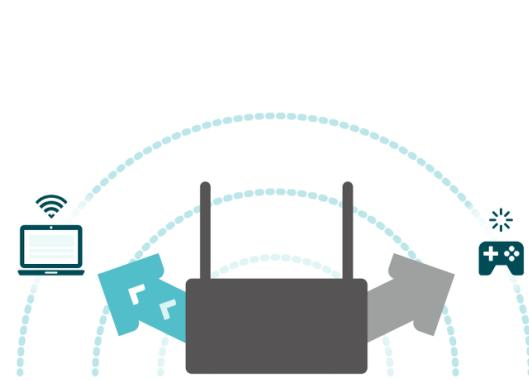

Traditional Router



MU-MIMO Router

## More Devices, More Stability

Connect up to 64 wireless devices with ease, thanks to a powerful processor that boosts data transfer speeds while ensuring dependable network stability.†

Up to  
**64**  
devices

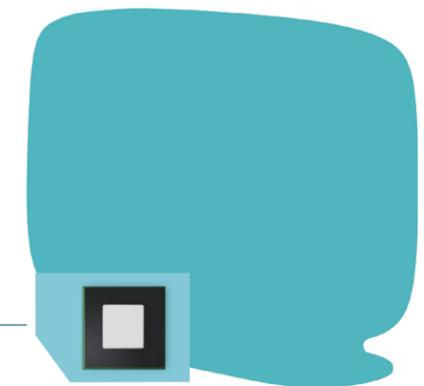

Powerful CPU

# Highlights

## Available WAN Connection

The gigabit WAN/LAN port enables MR515 to work as a traditional wireless router which is compatible with cable, fiber, and DSL modems. And when it's set as a wireless router, its 3G/4G connection works as a backup to provide a sustained and reliable internet connection for you.

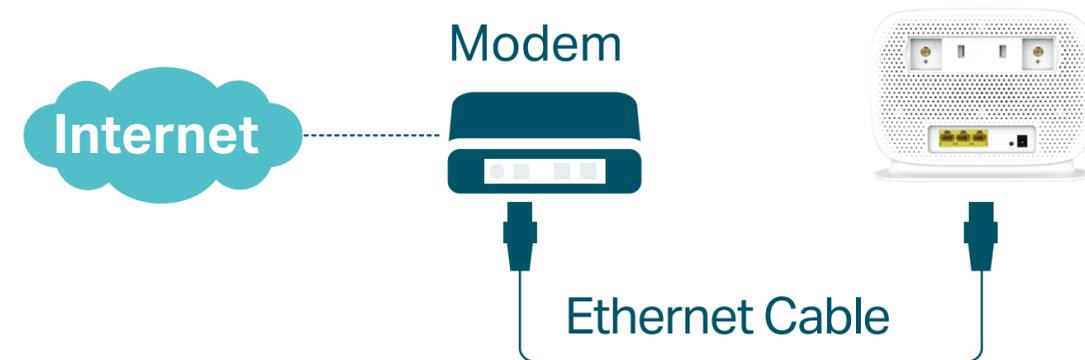

## EasyMesh-Compatible

Mesh networking creates smooth, fast, stable roaming. MR515 can build an EasyMesh network with devices that use EasyMesh technology. Eliminate Wi-Fi dead zones, expand your network and fill your entire home with high-speed Wi-Fi.<sup>§</sup>

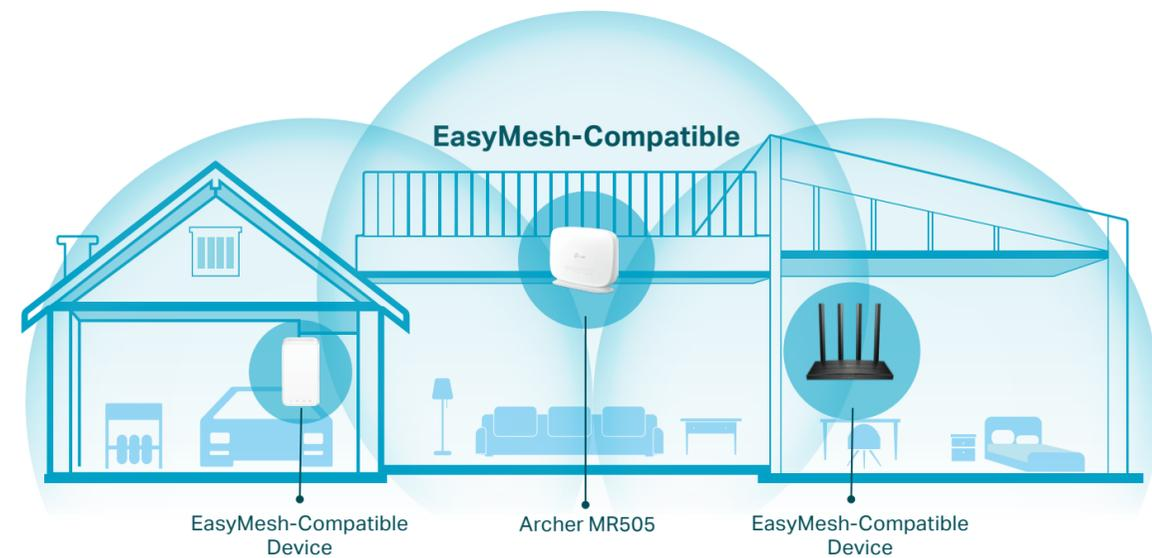

Check full list of EasyMesh-Compatible routers and range extenders at:  
<https://www.tp-link.com/easymesh/product-list/>  
\*More compatible devices are coming soon.

# Features

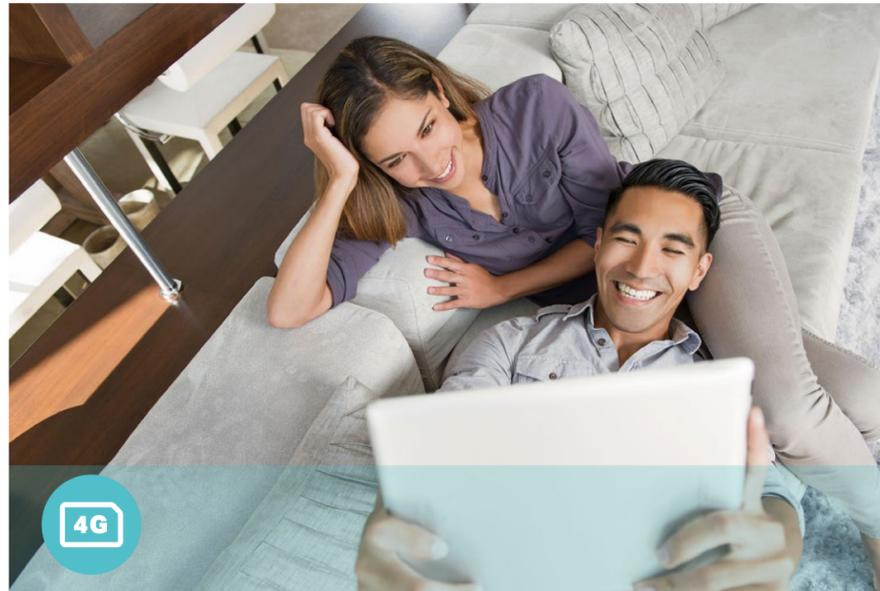

## 4G+ LTE

- 4G+ LTE – Ideal for cutting-edge 4G LTE Advanced network
- Backward Compatible – Compatible with 3G/4G network



## Wi-Fi Speed

- Superior Wireless Speed – Combined wireless speeds up to 867 Mbps over 5 GHz, and 300 Mbps over 2.4 GHz
- 802.11 ac Standard – Provides a data transfer rate 3 times faster than 802.11n for each stream



## Reliability

- Simultaneous Dual Band – Separate Wi-Fi bands enable more devices to connect to your network without a drop in performance
- Easy Bandwidth Management – Advanced QoS makes it easier for you to manage the bandwidth of connected devices
- Superior Stability – Powerful processor enables you to connect up to 64 wireless devices with ease

# Features

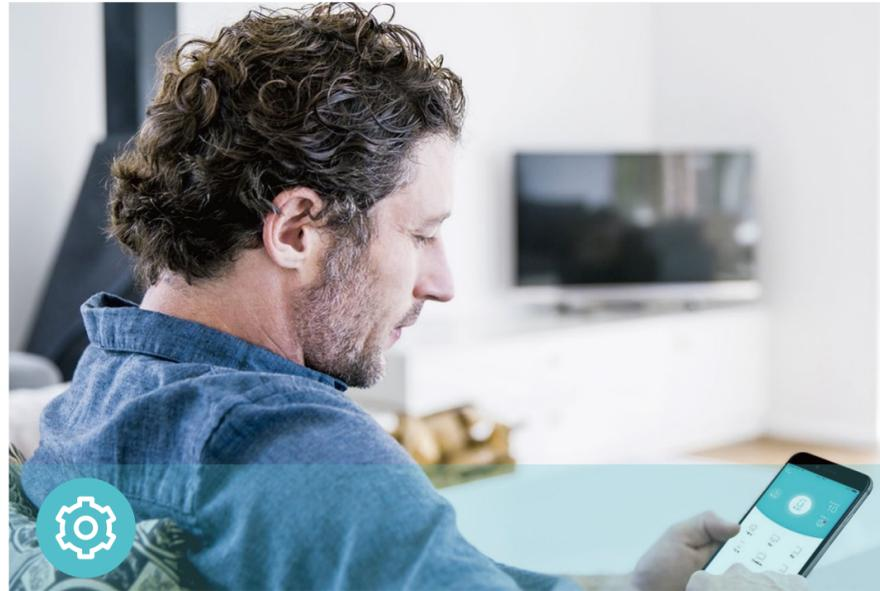

## Ease of Use

- Intuitive Web UI – Ensures quick and simple installation without hassle
- Fast Encryption – One-touch WPA wireless security encryption with the WPS button
- Hassle-free Management with Tether App – Network management is made easy with the TP-Link Tether App, available on any Android and iOS device
- Online Upgrade – Keeps you informed of the latest firmware and allows online upgrade on the web UI



## Security

- Guest Network – Keeps your main network secure by creating a separate network for friends and visitors
- Access Control – Establishes a whitelist or blacklist to allow or restrict certain devices to access the internet
- Parental Controls – Restrict internet access time and contents for children devices
- Encryptions for Secure Network – WPA-PSK, WPA2-PSK and WPA3-PSK encryptions provide active protection against security threats

# Specifications

## Wireless

- Network Type  
Compatible with majority of mobile operators and supports 4G/3G:  
4G: FDD-LTE: B1/B3/B5/B7/B8/B20/B28 (2100/1800/850/2600/900/800/700 MHz)  
TDD-LTE: B38/B40/B41(2600/2300/2500 MHz)  
3G: DC-HSPA+/HSPA/UMTS: B1/B5/B8(2100/850/900 MHz)
- Wireless Standards: IEEE 802.11a/n/ac 5 GHz, IEEE 802.11b/g/n 2.4 GHz
- Frequency: 2.4 GHz and 5 GHz
- Signal Rate: 300 Mbps at 2.4 GHz, 867 Mbps at 5 GHz
- EIRP (CE): < 20 dBm (2.4 GHz), < 23 dBm (5 GHz)
- Reception Sensitivity:  
5 GHz: 11a 54M: -77 dBm  
11ac VHT20: -71 dBm  
11ac VHT40: -67 dBm  
11ac VHT80 : -63 dBm  
11n HT20: -76 dBm  
11n HT40: -73 dBm  
2.4 GHz: 11g 54M: -75 dBm  
11n HT20: -74 dBm  
11n HT40: -71 dBm
- Wireless Function: Enable/Disable Wireless Radio, Wireless Schedule, WMM
- Wireless Security: 64/128-bit WEP, WPA/WPA2 Personal, WPA/WPA2 Enterprise, WPA/WPA3 Personal

## Hardware

- 4G+ Cat6: Download Speed 300 Mbps + Upload Speed 50 Mbps
- Wireless: 300 Mbps on 2.4 GHz + 867 Mbps on 5 GHz
- Antennas: 2× Internal 4G/3G Antennas + 2× Internal Wi-Fi Antennas + 2× External Antenna Ports
- Ports: 1× Gigabit LAN/WAN Port + 2× Gigabit LAN Ports
- Dimensions: 8.35×6.20×2.24 in (212×157.5×57 mm)

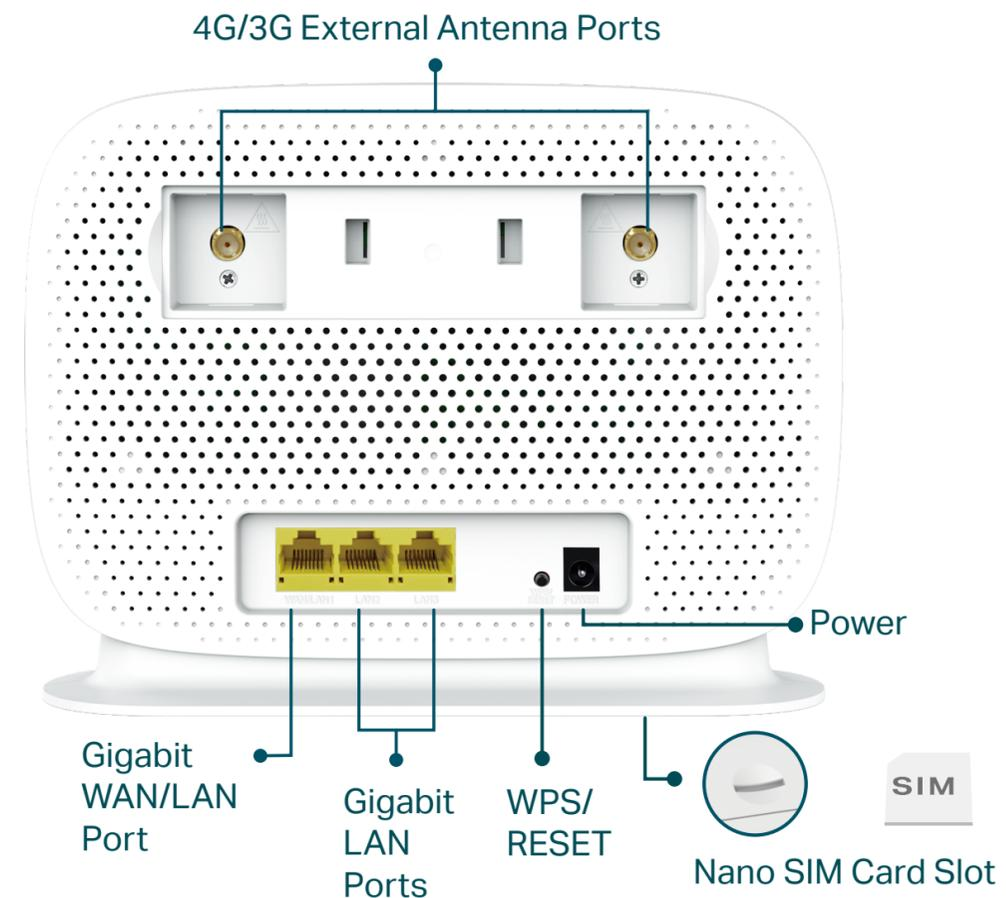

# Specifications

## Software

- Operating Modes: 3G/4G Router, Wireless Router
- WAN Type: Dynamic IP/Static IP/PPPoE/PPTP(Dual Access)/L2TP(Dual Access)
- DHCP: Server, DHCP Client List, Address Reservation
- Quality of Service: Bandwidth Control
- Port Forwarding: Virtual Server, Port Triggering, UPnP, DMZ
- Dynamic DNS: TP-Link, DynDns, NO-IP
- Security: IPv4 SPI Firewall, ALG, IP and MAC Address Binding, Access Control
- Protocols: IPv4, IPv6
- Management: TP-Link Cloud, Local Management, Remote Management
- Administration: Upgrade Firmware, Factory Default, System Log, Diagnostic Tools
- Guest Network: 2.4 GHz Guest Network x 1, 5 GHz Guest Network x 1

## Others

- Certification:  
CE, RoHS
- Requirements:  
Microsoft Windows 98SE/NT/2000/XP/Vista™/7/8/8.1/10, MAC OS, NetWare, UNIX or Linux  
Edge, Firefox, Chrome, Safari, or other JavaScript-enabled browser  
\*You are recommended to use the latest version  
Nano SIM Card
- Environment:  
Operating Temperature: 0°C~40°C (32°F ~104°F)  
Operating Humidity: 10%~90% non-condensing  
Storage Humidity: 5%~90% non-condensing
- Package Contents  
4G+ Cat6 300 Mbps LTE AC1200 Wireless Dual Band Gigabit Router Archer MR515  
Power Adapter  
RJ45 Ethernet Cable  
Quick Installation Guide

<sup>†</sup>Maximum wireless signal rates are the physical rates derived from IEEE Standard 802.11 specifications. Actual wireless data throughput and wireless coverage, and number of connected devices are not guaranteed and will vary as a result of network conditions, client limitations, and environmental factors, including building materials, obstacles, volume and density of traffic, and client location.

<sup>‡</sup>Use of MU-MIMO requires clients to also support MU-MIMO.

<sup>§</sup>TP-Link EasyMesh-compatible products can network with other devices that use EasyMesh. Failed connections may be due to firmware conflicts of different vendors. The EasyMesh-Compatible function is still being developed on some models and will be supported in subsequent software updates. This product is compatible with standardized EasyMesh technology but has not obtained the Wi-Fi EasyMesh™ certification.

<sup>\*\*</sup>Actual network speed may be limited by the rate of the product's Ethernet WAN or LAN port, the rate supported by the network cable, Internet service provider factors and other environmental conditions.

<sup>^</sup>Use of WPA3 requires clients to also support the corresponding feature.

©2024 TP-Link

[www.tp-link.com](http://www.tp-link.com)