

Yealink

Certified for

Microsoft Teams

WH64 Mono & WH64 Dual DECT Wireless Headset



Quick Start Guide V1.1



Please update the headset to the latest version via Yealink USB Connect (PC) before using.

1 Package List



WHD642 Headset

or



WHM641 Headset



WHB640 Base

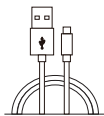

USB 2.0 Cable
(USB-A to USB-C)

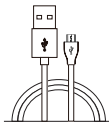

USB 2.0 Cable
(Micro USB to USB-A)

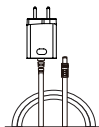

Power Adapter

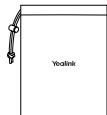

Drawstring Bag



Quick Start Guide

Note: We recommend that you use the included accessories, as other accessories may have compatibility issues that prevent them from working properly.

2 Overview

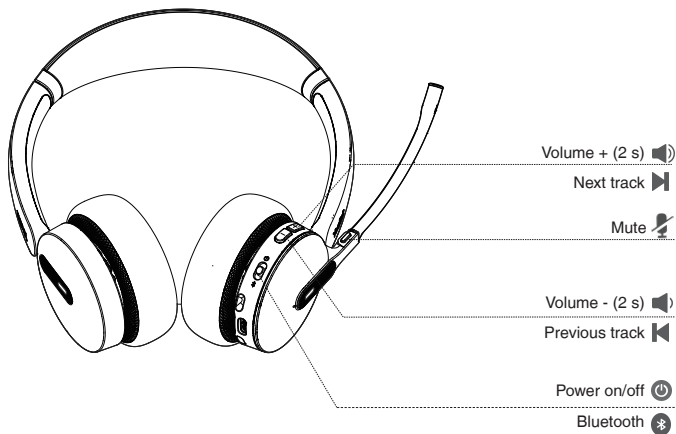
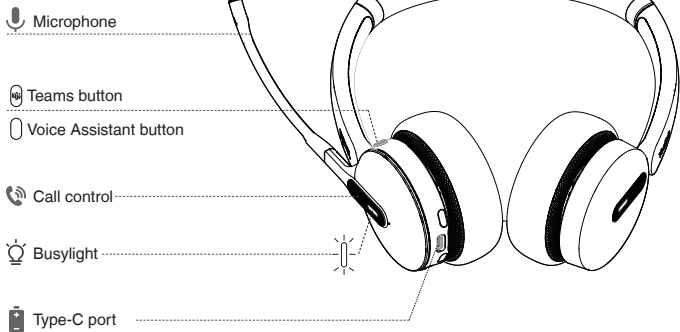

3 Pairing and Connecting Device

• Headset Bluetooth Mode

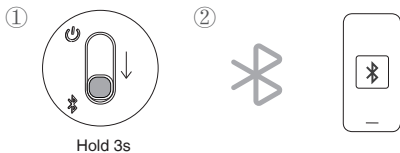

• Dect Mode

Using the diagram, connect the base to your PC, power outlet and desk phone's headset port, if available.

For the initial use, the headset is successfully paired with the base when you dock it in the base.

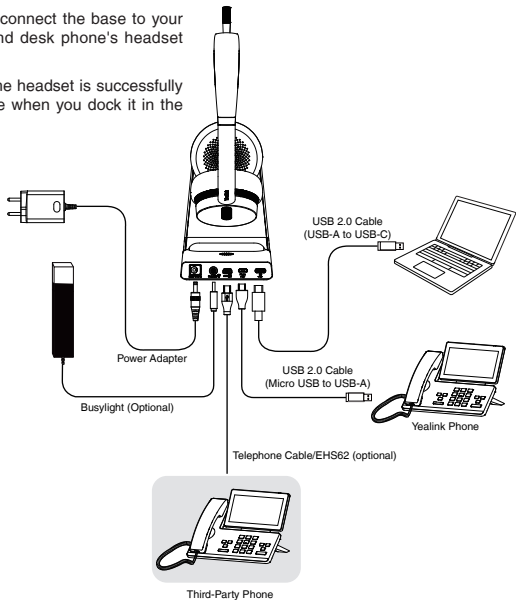

Note:

For more information about the Telephone Cable & EHS62, please refer to the user guide.

4 Charging

USB Charging



Charging Stand

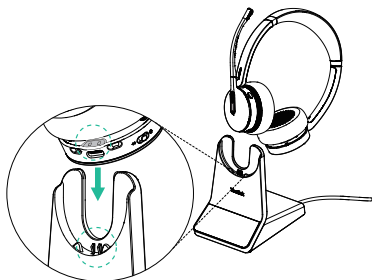

Note: We recommend to fully charge the headset when using it for the first time.

LED Indicator Status

Charging

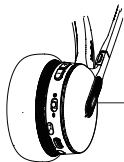

Breathing green LED indicator

Fully Charged

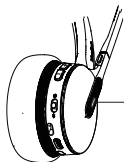



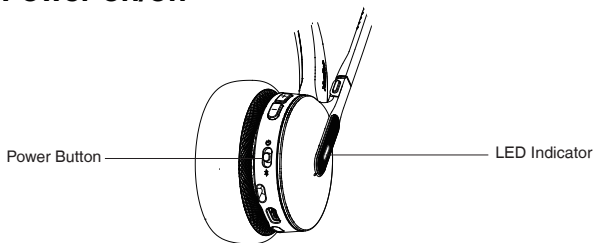

Solid green LED indicator

Note: It takes 1.5 hours to fully charge the headset.

5 Power on/off



Power Button	LED Indicator	Prompt Sound
 Power on	Solid green for 2 seconds	 "power on, battery low/medium/high"
 Power off	Solid red for 2 seconds	 "power off"

6 Call Control

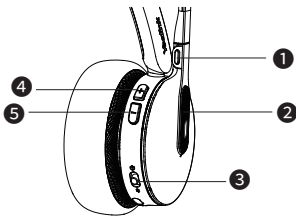

Item	Headset Action
Mute/unmute call	Press 1 .
Volume up/down	Press 4 / 5 .
Answer call	Press 2 .
End call	Press 2 .
Reject call	Double-press 2 .
Hold/unhold call	- Press 2 for 2 sec to hold call. - Press 2 for 2 sec or press once to unhold call.
Redial	Double-press 2 .

7 Fit Headset

Support dual-sided wearing.

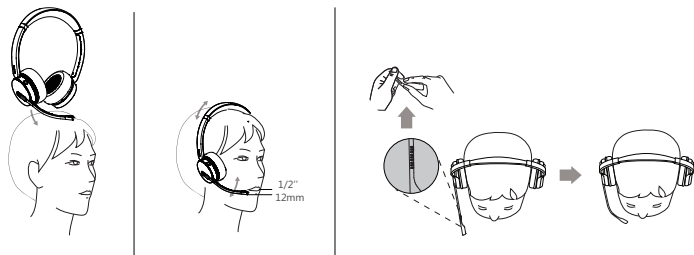

8 Replace Ear Cushions

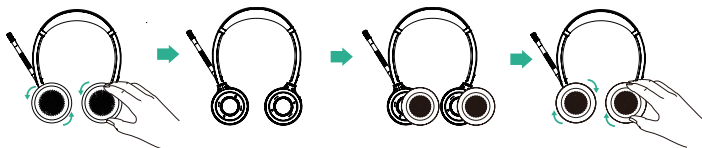

9 Software Management

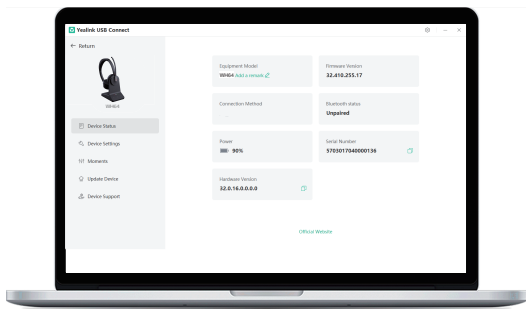

Download Yealink USB Connect from the Yealink website <https://www.yealink.com/product/yuc>.



Declaration of Conformity

We,

YEALINK(XIAMEN) NETWORK TECHNOLOGY CO.,LTD

Address: No.666 Hu'an Rd. Huli District Xiamen City, Fujian, P.R. China

Manufacturer: YEALINK(XIAMEN) NETWORK TECHNOLOGY CO.,LTD

Address: No.666 Hu'an Rd. Huli District Xiamen City, Fujian, P.R. China

CE DATE: 15 /April/2024

declare that the product

Type: DECT Wireless Headset

Model: WH64 Mono(Contains WHB640, WHM641)

meets the essential requirements and other relevant provisions according to the following EC directive

Directive: 2014/30/EU, 2014/35/EU, **RED 2014/53/EU**;

The presumption of conformity with the essential requirement is ensure according to :

Article 3.1 a : (protection of the health & the safety of the user)

Safety: **EN 62368-1:2020+A11:2020**

SAR: EN 50663:2017, EN 62479:2010, EN IEC 62311:2020,

Article 3.1 b : (protection requirement with respect to electromagnetic compatibility)

EMC: EN55032:2015+A1:2020, EN55035:2017+A11:2020,

EN IEC 61000-3-2:2019+A1:2021, EN 61000-3-3:2013+A2:2021,

EN301489-6 V2.2.1, EN301489-1 V2.2.3

ETSI EN 301 489-17 V3.2.4 For WHM641

Article 3.2 (effective use of the radio spectrum)

Radio: ETSI EN 301406 V2.2.2

ETSI EN300 328 V2.2.2 For WHM641

Harmonized: UN-EN62321

Directive 2011/65/EU and (EU)2015/863 of the European Parliament and of the Council of 8 June 2011 and 4 June 2015 on the restriction of the use of certain hazardous substances in electrical and electronic equipment (RoHS 2.0)

Directive 2012/19/EU of the European Parliament and of the Council of 4 July 2012 on Waste electrical and electronic equipment (WEEE)

Regulation (EC) No.1907/2006 of the European Parliament and of the Council of 18 December 2006 on Registration, Evaluation, Authorization, and Restriction of Chemicals (REACH)

The declaration of conformity is issued under the sole responsibility of the manufacturer

NAME: Huahu Wang

DATE:

TITLE: Manager

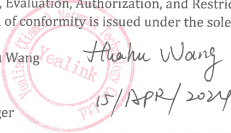

Huahu Wang
15 / APR / 2024



Declaration of Conformity

We,

YEALINK(XIAMEN) NETWORK TECHNOLOGY CO.,LTD

Address: No.666 Hu'an Rd. Huli District Xiamen City, Fujian, P.R. China

Manufacturer: YEALINK(XIAMEN) NETWORK TECHNOLOGY CO.,LTD

Address: No.666 Hu'an Rd. Huli District Xiamen City, Fujian, P.R. China

CE DATE: 15 /April/2024

declare that the product

Type: DECT Wireless Headset

Model: WH64 Dual(Contains WHB640, WHD642)

meets the essential requirements and other relevant provisions according to the following EC directive

Directive: 2014/30/EU, 2014/35/EU, **RED 2014/53/EU**;

The presumption of conformity with the essential requirement is ensure according to :

Article 3.1 a : (protection of the health & the safety of the user)

Safety: **EN 62368-1:2020+A11:2020**

SAR: EN 50663:2017, EN 62479:2010, EN IEC 62311:2020,

Article 3.1 b : (protection requirement with respect to electromagnetic compatibility)

EMC: EN55032:2015+A1:2020, EN55035:2017+A11:2020,

EN IEC 61000-3-2:2019+A1:2021, EN 61000-3-3:2013+A2:2021,

EN301489-6 V2.2.1, EN301489-1 V2.2.3

ETSI EN 301 489-17 V3.2.4 For WHD642

Article 3.2 (effective use of the radio spectrum)

Radio: ETSI EN 301406 V2.2.2

ETSI EN300 328 V2.2.2 For WHD642

Harmonized: UN-EN62321

Directive 2011/65/EU and (EU)2015/863 of the European Parliament and of the Council of 8 June 2011 and 4 June 2015 on the restriction of the use of certain hazardous substances in electrical and electronic equipment (RoHS 2.0)

Directive 2012/19/EU of the European Parliament and of the Council of 4 July 2012 on Waste electrical and electronic equipment (WEEE)

Regulation (EC) No.1907/2006 of the European Parliament and of the Council of 18 December 2006 on Registration, Evaluation, Authorization, and Restriction of Chemicals (REACH)

The declaration of conformity is issued under the sole responsibility of the manufacturer

NAME: Huah u Wang

DATE:

TITLE: Manager

Yealink (Xiamen) Network Technology Co., Ltd.
Huah u Wang
15 / APR / 2024

About Yealink

Yealink (Stock Code: 300628) is a global-leading provider of Unified Communication & Collaboration Solutions specialized in video conferencing, voice communications, and collaboration, dedicated to helping every person and organization embrace the power of "Easy Collaboration, High Productivity".

With best-in-class quality, innovative technology, and user-friendly experiences, Yealink is one of the best providers in more than 140 countries and regions, ranks No.1 in the global market share of IP Phone, and is the Top 5 leader in the video conferencing market (Frost & Sullivan, 2021).

Copyright

Copyright © 2024 YEALINK(XIAMEN) NETWORK TECHNOLOGY CO., LTD.

All rights reserved. No parts of this publication may be reproduced or transmitted in any form or by any means, electronic or mechanical, photocopying, recording, or otherwise, for any purpose, without the express written permission of Yealink(Xiamen) Network Technology CO., LTD.



Please scan the QR code to see the User Guide



430104002670

YEALINK(XIAMEN) NETWORK TECHNOLOGY CO.,LTD.
Web: www.yealink.com
Copyright©2024YEALINK(XIAMEN) NETWORK
TECHNOLOGY CO.,LTD. All rights reserved.