

OptiPlex Micro Plus 7020

Owner's Manual

Notes, cautions, and warnings

 **NOTE:** A NOTE indicates important information that helps you make better use of your product.

 **CAUTION:** A CAUTION indicates either potential damage to hardware or loss of data and tells you how to avoid the problem.

 **WARNING:** A WARNING indicates a potential for property damage, personal injury, or death.

Contents

Chapter 1: Views of OptiPlex Micro Plus 7020	6
Front.....	6
Back.....	7
Chapter 2: Set up your computer	9
Chapter 3: Specifications of OptiPlex Micro Plus 7020	13
Dimensions and weight.....	13
Processor.....	13
Chipset.....	16
Operating system.....	17
Memory.....	17
Memory matrix.....	18
External ports and slots.....	18
Internal slots.....	19
Ethernet.....	19
Wireless module.....	19
Audio.....	20
Storage.....	20
RAID (Redundant Array of Independent Disks).....	20
Power adapter.....	21
GPU—Integrated.....	22
External display support (GPU—Integrated).....	22
Hardware security.....	22
Environmental.....	23
Regulatory compliance.....	23
Operating and storage environment.....	23
Chapter 4: Working inside your computer	24
Safety instructions.....	24
Before working inside your computer.....	24
Safety precautions.....	25
Electrostatic discharge—ESD protection.....	25
ESD Field Service kit	26
Transporting sensitive components.....	27
After working inside your computer.....	27
BitLocker.....	27
Recommended tools.....	27
Screw list.....	28
Major components of OptiPlex Micro Plus 7020.....	28
Chapter 5: Removing and installing side cover	31
Removing the side cover.....	31
Installing the side cover.....	32

Chapter 6: Removing and installing coin-cell battery.....	35
Removing the coin-cell battery.....	35
Installing the coin-cell battery.....	35
Chapter 7: Removing and installing Customer Replaceable Units (CRUs).....	37
Front bezel.....	37
Removing the front bezel.....	37
Installing the front bezel.....	38
Speaker.....	39
Removing the speaker.....	39
Installing the speaker.....	40
Solid state drive.....	41
Removing the M.2 2230 solid-state drive from slot 0.....	41
Installing the M.2 2230 solid-state drive in slot 0.....	42
Removing the M.2 2230 solid-state drive from slot 1.....	43
Installing the M.2 2230 solid-state drive in slot 1.....	44
Removing the M.2 2280 solid-state drive from slot 0.....	45
Installing the M.2 2280 solid-state drive in slot 0.....	46
Removing the M.2 2280 solid-state drive from slot 1.....	47
Installing the M.2 2280 solid-state drive in slot 1.....	48
Location of the screw mount of the M.2 slot.....	49
Wireless card.....	50
Removing the wireless card.....	50
Installing the wireless card.....	51
Fan.....	53
Removing the fan.....	53
Installing the fan.....	54
Memory.....	55
Removing the memory module.....	55
Installing the memory module.....	56
Chapter 8: Removing and installing Field Replaceable Units (FRUs).....	58
Optional I/O module (HDMI/VGA/DP/Serial/PS2).....	58
Removing the optional I/O module (HDMI/VGA/DP/Serial/PS2).....	58
Installing the optional I/O module (HDMI/VGA/DP/Serial/PS2).....	60
Optional Type-C module.....	61
Removing the optional Type-C module.....	61
Installing the optional Type-C module.....	62
Heat sink.....	63
Removing the heat sink.....	63
Installing the heat sink.....	64
Processor.....	65
Removing the processor.....	65
Installing the processor.....	66
System board.....	67
Removing the system board.....	67
Installing the system board.....	69
Internal antenna.....	73

Removing the antenna module (white cable).....	73
Installing the antenna module (white cable).....	74
Removing the antenna module (black cable).....	75
Installing the antenna module (black cable).....	76
Removing SMA antenna assembly.....	77
Installing SMA antenna assembly.....	78
Chapter 9: Software.....	80
Operating system.....	80
Drivers and downloads.....	80
Chapter 10: BIOS Setup.....	81
Entering BIOS Setup program.....	81
Navigation keys.....	81
One time boot menu.....	81
F12 One Time Boot menu.....	82
System setup options.....	82
Updating the BIOS.....	93
Updating the BIOS in Windows.....	93
Updating the BIOS in Linux and Ubuntu.....	94
Updating the BIOS using the USB drive in Windows.....	94
Updating the BIOS from the One-Time boot menu.....	94
System and setup password.....	95
Assigning a System Setup password.....	95
Deleting or changing an existing system password or setup password.....	96
Clearing BIOS (System Setup) and System passwords.....	96
Chapter 11: Troubleshooting.....	97
Dell SupportAssist Pre-boot System Performance Check diagnostics.....	97
Running the SupportAssist Pre-Boot System Performance Check.....	97
Power-Supply Unit Built-in Self-Test	97
System-diagnostic lights.....	98
Recovering the operating system.....	98
Real Time Clock—RTC reset.....	98
Backup media and recovery options.....	99
Wi-Fi power cycle.....	99
Chapter 12: Getting help and contacting Dell.....	100

Views of OptiPlex Micro Plus 7020

Front

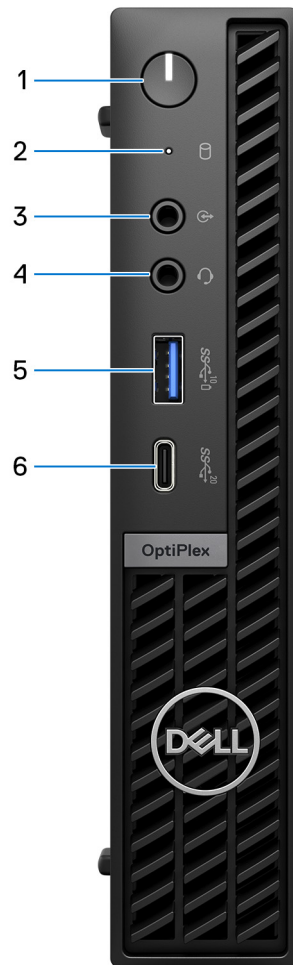

Figure 1. Front view

1. Power button

Press to turn on the computer if it is turned off, in sleep state, or in hibernate state.

When the computer is turned on, press the power button to put the computer into sleep state; press and hold the power button for 10 seconds to force shut-down the computer.

NOTE: You can customize the power-button behavior in Windows.

2. Storage drive activity light

The activity light turns on when the computer reads from or writes to storage drives.

3. Re-tasking line-out/line-in audio port

Connect a supported audio device.

4. Universal audio jack

Connect headphones or a headset (headphone and microphone combo).

5. USB 3.2 Gen 2 (10 Gbps) port with PowerShare

Connect devices such as external storage devices and printers.

Provides data transfer speeds up to 10 Gbps. Supports Power Delivery that enables two-way power supply between devices. Provides up to 15 W power output.

NOTE: PowerShare enables you to charge your USB devices even when your computer is turned off.

NOTE: If a USB device is connected to the PowerShare port before the computer is turned off or put in hibernate state, you must disconnect and connect it again to enable charging.

6. USB 3.2 Gen 2x2 Type-C (20 Gbps) port

Connect devices such as external storage devices, printers, and external displays. Provides data transfer rate of up to 20 Gbps.

Back

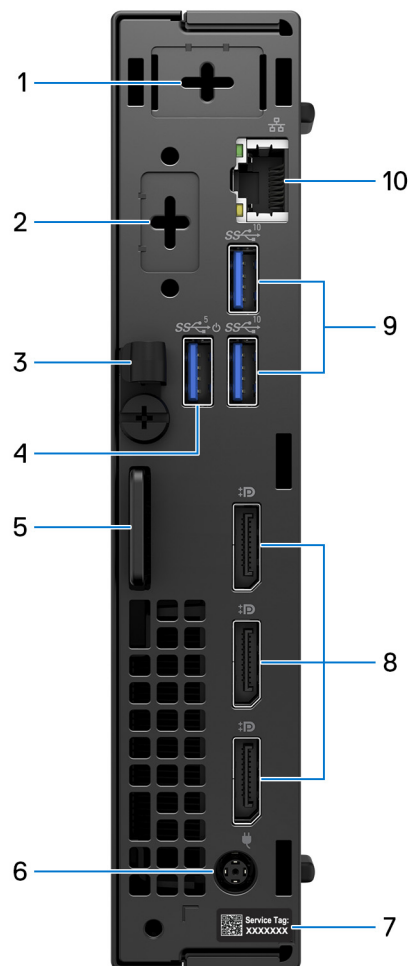

Figure 2. Back view

1. One optional external antenna port

Supports an optional external antenna module.

2. **One optional I/O module port**

Supports an optional I/O module with one of the following ports:

- HDMI 2.1
- DisplayPort 1.4a (HBR3)
- PS2
- USB Type-C with DisplayPort Alt mode and Power Delivery
- VGA
- Serial

i **NOTE:** You may connect a 90 W Dell USB-C hub monitor to the optional Type-C port as a consolidated power, display, and USB I/O solution for your computer.

3. **DC-in cable clip**

Use for routing the power-adaptor cable.

4. **USB 3.2 Gen 1 (5 Gbps) port with Smart Power On**

Connect devices such as external storage devices and printers. Supports data transfer speeds up to 5 Gbps.

i **NOTE:** When USB wake is enabled in the BIOS, the computer will power on or wake from hibernation when a USB mouse or keyboard that is connected to this port is used.

5. **Kensington security-cable slot and padlock ring**

Connect a security cable to prevent unauthorized movement of your computer and install a standard padlock to prevent unauthorized access to the interior of your computer.

6. **Power-adaptor port**

Connect a power adapter to provide power to your computer.

7. **Service Tag label**

The Service Tag is a unique alphanumeric identifier that enables Dell service technicians to identify the hardware components in your computer and access warranty information.

8. **Three DisplayPort 1.4a ports**

Connect an external display or a projector. Can support video outputs of up to 4096 x 2304 at 60 Hz.

9. **Two USB 3.2 Gen 2 (10 Gbps) ports**

Connect devices such as external storage devices and printers. Provides data transfer speeds up to 10 Gbps.

10. **Network port**

Connect an Ethernet (RJ45) cable from a router or a broadband modem for network or Internet access, with a transfer rate of 10/100/1000 Mbps.

Set up your computer

Steps

1. Connect the keyboard and mouse.

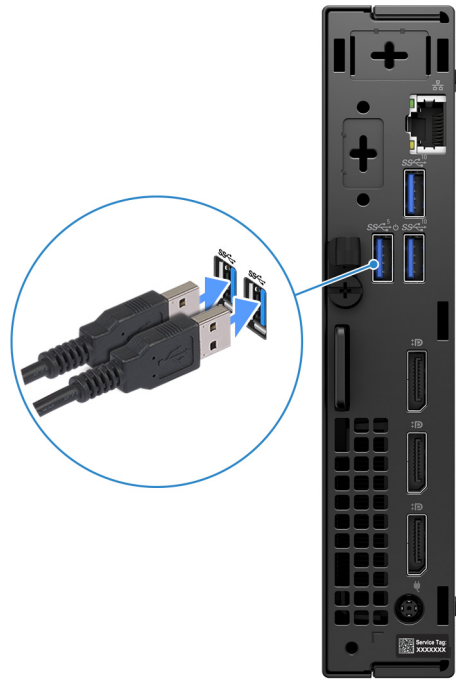

Figure 3. Connect the keyboard and mouse to your OptiPlex Micro Plus 7020

2. Connect to your network using a cable.

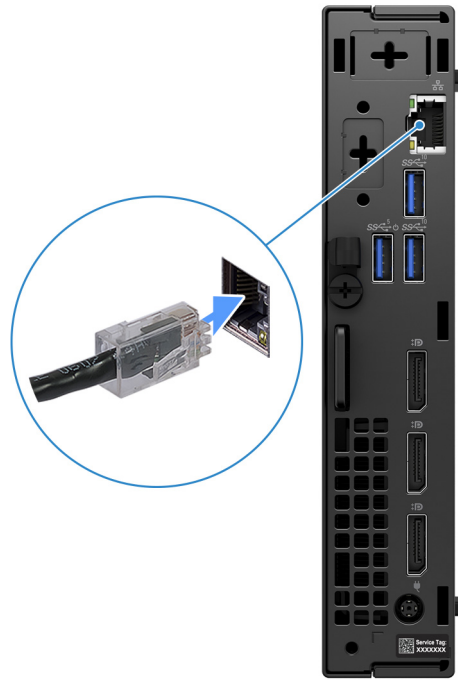

Figure 4. Connect to your network using a cable

NOTE: Alternatively, you can connect to a wireless network.

3. Connect the display.



Figure 5. Connect the display

4. Connect the power cable.

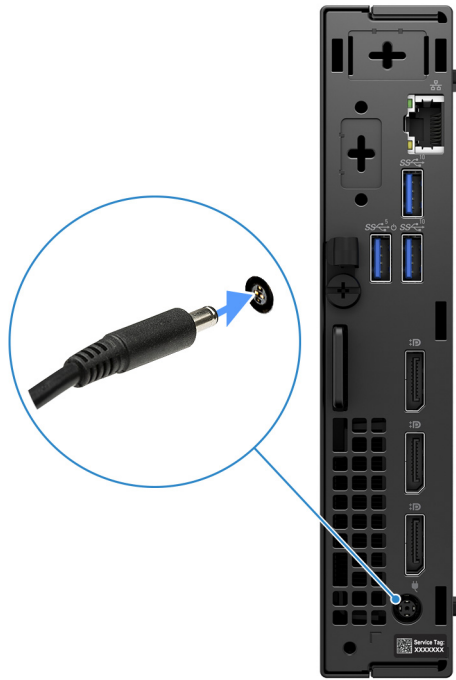

Figure 6. Connect the power cable.

5. Press the power button.



Figure 7. Press the power button

6. Finish the operating system setup.

For Ubuntu:

Follow the on-screen instructions to complete the setup. For more information about installing and configuring Ubuntu, search in the Knowledge Base Resource at [Dell Support Site](#).



For Windows:

Follow the on-screen instructions to complete the setup. When setting up, Dell Technologies recommends that you:

- Connect to a network for Windows updates.
 - ① **NOTE:** If connecting to a secured wireless network, enter the password for the wireless network access when prompted.
- If connected to the internet, sign-in with an existing Microsoft account or create a new account. If not connected to the internet, create an offline account.
- On the **Support and Protection** screen, enter your contact details.

7. Locate and use Dell apps from the Windows Start menu—Recommended

Table 1. Locate Dell apps

Resources	Description
	<p>SupportAssist</p> <p>SupportAssist proactively and predictively identifies hardware and software issues on your computer and automates the engagement process with Dell Technical support. It addresses performance and stabilization issues, prevents security threats, monitors, and detects hardware failures. For more information, see <i>SupportAssist for Home PCs User's Guide</i> at SupportAssist for Home PCs.</p> <p>① NOTE: In SupportAssist, click the warranty expiry date to renew or upgrade your warranty.</p>
	<p>Dell Update</p> <p>Updates your computer with critical fixes and latest device drivers as they become available. For more information about using Dell Update, see the product guides and third-party license documents at Dell Support Site.</p>
	<p>Dell Digital Delivery</p> <p>Download software applications, which are purchased but not preinstalled on your computer. For more information about using Dell Digital Delivery, search in the Knowledge Base Resource at Dell Support Site.</p>

Specifications of OptiPlex Micro Plus 7020

Dimensions and weight

The following table lists the height, width, depth, and weight of your OptiPlex Micro Plus 7020.

Table 2. Dimensions and weight

Description	Values
Height	182 mm (7.17 in.)
Width	36 mm (1.42 in.)
Depth	178 mm (7.01 in.)
Weight  NOTE: The weight of your computer depends on the configuration ordered and manufacturing variability.	<ul style="list-style-type: none"> • Minimum: 1.25 kg (2.75 lb) • Maximum: 1.36 kg (3.00 lb)

Processor

The following table lists the details of the processors that are supported for your OptiPlex Micro Plus 7020.

Table 3. Processor

Description	Option one	Option two	Option three	Option four
Processor type	Intel Core i9 14900T vPro	Intel Core i9 14900 vPro	Intel Core i7 14700T vPro	Intel Core i7 14700 vPro
Processor wattage	35 W	65 W	35 W	65 W
Processor total core count	24	24	20	20
Performance-cores	8	8	8	8
Efficient-cores	16	16	12	12
Processor total thread count	32	32	28	28
 NOTE: Intel Hyper-Threading Technology is available only on Performance-cores.				
Processor speed	Up to 5.50 GHz Turbo	Up to 5.60 GHz Turbo	Up to 5.20 GHz Turbo	Up to 5.40 GHz Turbo
Performance-cores frequency				
Processor base frequency	1.10 GHz	2 GHz	1.30 GHz	2.10 GHz
Maximum turbo frequency	5.10 GHz	5.40 GHz	5 GHz	5.30 GHz
Efficient-cores frequency				
Processor base frequency	0.80 GHz	1.50 GHz	0.90 GHz	1.50 GHz
Maximum turbo frequency	4 GHz	4.30 GHz	3.70 GHz	4.20 GHz
Processor cache	36 MB	36 MB	33 MB	33 MB
Integrated graphics	Intel UHD Graphics 770	Intel UHD Graphics 770	Intel UHD Graphics 770	Intel UHD Graphics 770

Table 4. Processor



Description	Option five	Option six	Option seven	Option eight
Processor type	Intel Core i5 14600T vPro	Intel Core i5 14600 vPro	Intel Core i5 14500T	Intel Core i5 14500 vPro
Processor wattage	35 W	65 W	35 W	65 W
Processor total core count	14	14	14	14
Performance-cores	6	6	6	6
Efficient-cores	8	8	8	8
Processor total thread count	20	20	20	20
 NOTE: Intel Hyper-Threading Technology is only available on Performance-cores.				
Processor speed	Up to 5.10 GHz Turbo	Up to 5.20 GHz Turbo	Up to 4.80 GHz Turbo	Up to 5 GHz Turbo
Performance-cores frequency				
Processor base frequency	1.80 GHz	2.70 GHz	1.70 GHz	2.60 GHz
Maximum turbo frequency	5.10 GHz	5.20 GHz	4.80 GHz	5 GHz
Efficient-cores frequency				
Processor base frequency	1.30 GHz	2 GHz	1.20 GHz	1.90 GHz
Maximum turbo frequency	3.60 GHz	3.90 GHz	3.40 GHz	3.70 GHz
Processor cache	24 MB	24 MB	24 MB	24 MB
Integrated graphics	Intel UHD Graphics 770	Intel UHD Graphics 770	Intel UHD Graphics 770	Intel UHD Graphics 770

Table 5. Processor

Description	Option nine	Option ten
Processor type	Intel Core i3 14100T	Intel Core i3 14100
Processor wattage	35 W	60 W
Processor total core count	4	4
Performance-cores	4	4
Efficient-cores	0	0
Processor total thread count	8	8
 NOTE: Intel Hyper-Threading Technology is only available on Performance-cores.		
Processor speed	Up to 4.40 GHz Turbo	Up to 4.70 GHz Turbo
Performance-cores frequency		
Processor base frequency	2.70 GHz	3.50 GHz
Maximum turbo frequency	4.40 GHz	4.70 GHz
Efficient-cores frequency		
Processor base frequency	Not applicable	Not applicable
Maximum turbo frequency	Not applicable	Not applicable
Processor cache	12 MB	12 MB
Integrated graphics	Intel UHD Graphics 730	Intel UHD Graphics 730

Chipset

The following table lists the details of the chipset supported by your OptiPlex Micro Plus 7020.

Table 6. Chipset

Description	Values
Chipset	Intel Q670
Processor	Intel Core i3/i5/i5 vPro/i7 vPro/i9 vPro
DRAM bus width	64-bit
Flash EPROM	32 MB + 16 MB
PCIe bus	Up to Gen4
Non-volatile memory	Yes
BIOS configuration Serial Peripheral Interface (SPI)	256 Mbit (32 MB) located at SPI_FLASH
Trusted Platform Module (TPM) 2.0 (Discrete TPM Enabled)	24 KB located at TPM 2.0 on chipset

Table 6. Chipset (continued)

Description	Values
Firmware-TPM (Discrete TPM disabled)	By default the Platform Trust Technology feature is visible to the operating system.
NIC EEPROM	LOM configuration contained within SPI flash ROM instead of LOM e-fuse

Operating system

Your OptiPlex Micro Plus 7020 supports the following operating systems:

- Windows 11 Home
- Windows 11 Pro
- Windows 11 Pro National Education
- Ubuntu Linux 22.04 LTS, 64-bit
- Windows 10 IoT Enterprise LTSC 2021

Memory

The following table lists the memory specifications that are supported by your OptiPlex Micro Plus 7020.

Table 7. Memory specifications

Description	Values
Memory slots	Two SODIMM slots
Memory type	DDR5
Memory speed	<ul style="list-style-type: none"> • 4800 MT/s • 5600 MT/s
Maximum memory configuration	64 GB
Minimum memory configuration	8 GB
Memory size per slot	8 GB, 16 GB, or 32 GB
Memory configurations supported	<p>For computers with an Intel Core i3 14100/i3 14100T/i5 14500 vPro/i5 14500T processor:</p> <ul style="list-style-type: none"> • 8 GB: 1 x 8 GB, DDR5, 4800 MT/s, single-channel • 16 GB: 1 x 16 GB, DDR5, 4800 MT/s, single-channel • 32 GB: 1 x 32 GB, DDR5, 4800 MT/s, single-channel • 16 GB: 2 x 8 GB, DDR5, 4800 MT/s, dual-channel • 32 GB: 2 x 16 GB, DDR5, 4800 MT/s, dual-channel • 64 GB: 2 x 32 GB, DDR5, 4800 MT/s, dual-channel <p>For computers shipped with an Intel Core i5 14600 vPro/i5 14600T vPro/i7 14700 vPro/i7 14700T vPro/i9 14900 vPro/i9 14900T vPro processor:</p> <ul style="list-style-type: none"> • 8 GB: 1 x 8 GB, DDR5, 5600 MT/s, single-channel • 16 GB: 1 x 16 GB, DDR5, 5600 MT/s, single-channel • 16 GB: 2 x 8 GB, DDR5, 5600 MT/s, dual-channel • 32 GB: 1 x 32 GB, DDR5, 5600 MT/s, dual-channel • 32 GB: 2 x 16 GB, DDR5, 5600 MT/s, dual-channel • 64 GB: 2 x 32 GB, DDR5, 5600 MT/s, dual-channel

Memory matrix

The following table lists the memory configurations supported on your OptiPlex Micro Plus 7020.

Table 8. Memory matrix

Configuration	Slot	
	DIMM1	DIMM2
8 GB DDR5	8 GB	Not used
16 GB DDR5	16 GB	Not used
16 GB DDR5	8 GB	8 GB
32 GB DDR5	32 GB	Not used
32 GB DDR5	16 GB	16 GB
64 GB DDR5	32 GB	32 GB

External ports and slots

The following table lists the external ports of your OptiPlex Micro Plus 7020.

Table 9. External ports and slots

Description	Values
Network port	One RJ45 Ethernet port 10/100/1000 Mbps
USB ports	Front: <ul style="list-style-type: none"> • One USB 3.2 Gen 2 (10 Gbps) port with PowerShare • One USB 3.2 Gen 2x2 (20 Gbps) Type-C port Rear: <ul style="list-style-type: none"> • One USB 3.2 Gen 1 (5 Gbps) port with Smart Power On • Two USB 3.2 Gen 2 (10 Gbps) ports
Audio port	<ul style="list-style-type: none"> • One universal audio jack (front) • One re-tasking line-out/line-in audio port (front)
Video port(s)	Rear: <ul style="list-style-type: none"> • Three DisplayPort 1.4a ports • One video port for an optional video module that supports HDMI 2.1/DisplayPort 1.4a (HBR3)/VGA/USB Type-C with DisplayPort Alt Mode
Media-card reader	Not supported
Power-adaptor port	One power-adaptor port (rear)
Security-cable slot	<ul style="list-style-type: none"> • One Kensington lock slot • One padlock ring

Internal slots

The following table lists the internal slots of your OptiPlex Micro Plus 7020.

Table 10. Internal slots

Description	Values
M.2	<ul style="list-style-type: none"> One M.2 2230 slot for Wi-Fi and Bluetooth card Two M.2 2230/2280 slots for solid state drives <p>NOTE: To learn more about the features of different types of M.2 cards, search in the Knowledge Base Resource at Dell Support Site.</p>

Ethernet

The following table lists the wired Ethernet Local Area Network (LAN) specifications of your OptiPlex Micro Plus 7020.

Table 11. Ethernet specifications

Description	Values
Model number	Intel WGI219LM
Transfer rate	10/100/1000 Mbps

Wireless module

The following table lists the Wireless Local Area Network (WLAN) modules that are supported on your OptiPlex Micro Plus 7020.

Table 12. Wireless module specifications

Description	Option one	Option two
Model number	Intel AX211	Realtek RTL8852BE
Transfer rate	Up to 2400 Mbps	Up to 1201 Mbps
Frequency bands supported	2.4 GHz/5 GHz/6 GHz	2.4 GHz/5 GHz
Wireless standards	<ul style="list-style-type: none"> WiFi 802.11a/b/g Wi-Fi 4 (WiFi 802.11n) Wi-Fi 5 (WiFi 802.11ac) Wi-Fi 6E (WiFi 802.11ax) 	<ul style="list-style-type: none"> WiFi 802.11a/b/g Wi-Fi 4 (WiFi 802.11n) Wi-Fi 5 (WiFi 802.11ac) Wi-Fi 6 (WiFi 802.11ax)
Encryption	<ul style="list-style-type: none"> 64-bit/128-bit WEP AES-CCMP TKIP 	<ul style="list-style-type: none"> 64-bit/128-bit WEP AES-CCMP TKIP
Bluetooth wireless card	Bluetooth 5.3 wireless card	Bluetooth 5.3 wireless card
	<p>NOTE: The version of the Bluetooth wireless card may vary depending on the operating system that is installed on your computer.</p>	

Audio

The following table lists the audio specifications of your OptiPlex Micro Plus 7020.

Table 13. Audio specifications

Description	Values
Audio type	4 Channel High Definition Audio
Audio controller	Realtek ALC3246 Codec
Internal audio interface	Intel HDA (High-Definition Audio)
External audio interface	<ul style="list-style-type: none"> • One universal audio jack (front) • One re-tasking line out/line in audio port (front)

Storage

This section lists the storage options on your OptiPlex Micro Plus 7020.

Table 14. Storage matrix

Storage	1st M.2 socket (2230/2280)	2nd M.2 socket (2230/2280)
M.2 solid-state drive (2230)	Yes (SSD0, primary M.2 PCIe for boot function)	Yes (SSD1)
M.2 solid-state drive (2230) + M.2 solid-state drive (2280)	Yes (SSD0, primary M.2 PCIe for boot function)	Yes (SSD1)
M.2 solid-state drive (2280)	Yes (SSD0, primary M.2 PCIe for boot function)	Yes (SSD1)

Table 15. Storage specifications

Storage type	Interface type	Capacity
M.2 2230, Class 25 solid-state drive	Gen 4 PCIe NVMe	Up to 2 TB
M.2 2230, Class 35 solid-state drive	Gen 4 PCIe NVMe	Up to 1 TB
M.2 2230, Class 35, Self-Encrypting Opal 2.0 solid-state drive	Gen 4 PCIe NVMe	256 GB
M.2 2280, Class 40 solid-state drive	Gen 4 PCIe NVMe	Up to 2 TB
M.2 2280, Class 40, Self-Encrypting Opal 2.0 solid-state drive	Gen 4 PCIe NVMe	Up to 1 TB

RAID (Redundant Array of Independent Disks)

For optimal performance when configuring drives as a RAID volume, Dell Technologies recommends drive models that are identical.

RAID 0 (Striped, Performance) volumes benefit from higher performance when drives are matched because the data is split across multiple drives; any I/O operations with block sizes larger than the stripe size splits the I/O and become constrained by the slowest of the drives. For RAID 0 I/O operations where block sizes are smaller than the stripe size, whichever drive the I/O operation targets determine the performance, which increases variability and results in inconsistent latencies. This variability is pronounced for write operations, and it can be problematic for applications that are latency sensitive. One such example is any application that performs thousands of random writes per second in small block sizes.

RAID 1 (Mirrored, Data Protection) volumes benefit from higher performance when drives are matched because the data is mirrored across multiple drives: all I/O operations must be performed identically to both drives, thus variations in drive performance when the models are different, result in the I/O operations completing only as fast as the slowest drive. While this does not suffer the variable latency issue in small random I/O operations as with RAID 0 across heterogeneous drives, the impact is nonetheless large because the higher performing drive becomes limited in all I/O types. One of the worst examples of constrained performance here is when using unbuffered I/O. To ensure that the writes are fully committed to nonvolatile regions of the RAID volume, unbuffered I/O bypasses cache (for example by using the Force Unit Access bit in the NVMe protocol) and the I/O operation will not be completed until all the drives in the RAID volume have completed the request to commit the data. This kind of I/O operation completely negates any advantage of a higher-performing drive in the volume.

Care must be taken to match not only the drive vendor, capacity, and class, but also the specific model. Drives from the same vendor, with the same capacity, and even within the same class, can have different performance characteristics for certain types of I/O operations. Thus, matching by model ensures that the RAID volume consists of a homogeneous array of drives that deliver all the benefits of a RAID volume without incurring the additional penalties when one or more drives in the volume are lower performing.

OptiPlex Micro Plus 7020 supports RAID with more than one solid-state drive configuration.

Power adapter

The following table lists the power adapter specifications of your OptiPlex Micro Plus 7020.

Table 16. Power adapter specifications

Description		Option one	Option two
Type		130 W AC adapter	180 W AC adapter
Connector dimensions:			
	External diameter	7.40 mm	7.40 mm
	Internal diameter	5.10 mm	5.10 mm
Power-adapter dimensions:			
	Height	25 mm (0.98 in.)	30 mm (1.18 in.)
	Width	76 mm (2.99 in.)	76 mm (2.99 in.)
	Depth	155 mm (6.10 in.)	155 mm (6.10 in.)
Input voltage		100 VAC–240 VAC	100 VAC–240 VAC
Input frequency		50 Hz–60 Hz	50 Hz–60 Hz
Input current (maximum)		2.50 A	2.34 A
Output current (continuous)		6.70 A	9.23 A
Rated output voltage		19.50 VDC	19.50 VDC
Temperature range:			
	Operating	0°C to 40°C (32°F to 104°F)	0°C to 40°C (32°F to 104°F)
	Storage	-40°C to 70°C (-40°F to 158°F)	-40°C to 70°C (-40°F to 158°F)

CAUTION: Operating and storage temperature ranges may differ among components, so operating or storing the device outside these ranges may impact the performance of specific components.

GPU—Integrated

The following table lists the specifications of the integrated Graphics Processing Unit (GPU) supported by your OptiPlex Micro Plus 7020.

Table 17. GPU—Integrated

Controller	Memory size	Processor
Intel UHD Graphics 730	Shared system memory	Intel Core i3
Intel UHD Graphics 770	Shared system memory	Intel Core i5/i5 vPro/i7 vPro/i9 vPro

External display support (GPU—Integrated)

Table 18. External display support (GPU—Integrated)

Integrated graphics card	Number of supported external displays
Three DisplayPort 1.4a ports	<ul style="list-style-type: none"> • Without MST - 3 • With MST - 4
Three DisplayPort 1.4a ports + Optional video port module	4
<p>NOTE: The resolution and refresh rate of each connected external display may affect the total number of supported external displays.</p>	

Hardware security

The following table lists the hardware security of your OptiPlex Micro Plus 7020.

Table 19. Hardware security

Hardware security
Kensington security-cable slot
Padlock ring
Chassis lock slot support
Chassis intrusion switch
Lockable cable covers
Supply chain tamper alerts
SafelD including Trusted Platform Module (TPM) 2.0
Smart card keyboard (FIPS)
Windows 11 Enterprise Security: Credential Guard and Device Guard
Microsoft Windows BitLocker
Local hard drive data wipe through BIOS (Secure Erase)
Self-encrypting storage drives (Opal, FIPS)
China TPM
Intel Secure Boot
Intel Authenticate

Environmental

The following table lists the environmental specifications of your OptiPlex Micro Plus 7020.

Table 20. Environmental

Feature	Values
Recyclable packaging	Yes
BFR/PVC—free chassis	Yes
Vertical orientation packaging support	No
Multi-Pack packaging	Yes
Energy-Efficient Power Supply	Standard
ENV0424 compliant	Yes

 **NOTE:** Wood-based fiber packaging contains a minimum of 35% recycled content by total weight of wood-based fiber.

Regulatory compliance

The following table lists the regulatory compliance of your OptiPlex Micro Plus 7020.

Table 21. Regulatory compliance

Regulatory compliance
Product Safety, EMC and Environmental Datasheets
Dell Regulatory Compliance Home Page
Responsible Business Alliance policy

Operating and storage environment

This table lists the operating and storage specifications of your OptiPlex Micro Plus 7020.

Airborne contaminant level: G1 as defined by ISA-S71.04-1985

Table 22. Computer environment

Description	Operating	Storage
Temperature range	10°C to 35°C (50°F to 95°F)	-40°C to 65°C (-40°F to 149°F)
Relative humidity (maximum)	20% to 80% (non-condensing)	5% to 95% (non-condensing)
Vibration (maximum)*	0.26 GRMS	1.37 GRMS
Shock (maximum)	40 G†	105 G†
Altitude range	-15.2 m to 3048 m (-49.87 ft to 10000 ft)	-15.2 m to 10668 m (-49.87 ft to 35000 ft)

 **CAUTION:** Operating and storage temperature ranges may differ among components, so operating or storing the device outside these ranges may impact the performance of specific components.











* Measured using a random vibration spectrum that simulates the user environment.

† Measured using a 2 ms half-sine pulse.

Working inside your computer

Safety instructions

Use the following safety guidelines to protect your computer from potential damage and to ensure your personal safety. Unless otherwise noted, each procedure in this document assumes that you have read the safety information that shipped with your computer.



-  **WARNING:** Before working inside your computer, read the safety information that is shipped with your computer. For more safety best practices, see [Dell Regulatory Compliance Home Page](#).
-  **WARNING:** Disconnect your computer from all power sources before opening the computer cover or panels. After you finish working inside the computer, replace all covers, panels, and screws before connecting your computer to an electrical outlet.
-  **CAUTION:** To avoid damaging the computer, ensure that the work surface is flat, dry, and clean.
-  **CAUTION:** To avoid damaging the components and cards, handle them by their edges, and avoid touching the pins and the contacts.
-  **CAUTION:** You should only perform troubleshooting and repairs as authorized or directed by the Dell technical support team. Damage due to servicing that is not authorized by Dell is not covered by your warranty. See the safety instructions that is shipped with the product or at [Dell Regulatory Compliance Home Page](#).
-  **CAUTION:** Before touching anything inside your computer, ground yourself by touching an unpainted metal surface, such as the metal at the back of the computer. While you work, periodically touch an unpainted metal surface to dissipate static electricity which could harm internal components.
-  **CAUTION:** When you disconnect a cable, pull it by its connector or its pull tab, not the cable itself. Some cables have connectors with locking tabs or thumbscrews that you must disengage before disconnecting the cable. When disconnecting cables, keep them evenly aligned to avoid bending the connector pins. When connecting cables, ensure that the connector on the cable is correctly oriented and aligned with the port.
-  **CAUTION:** Press and eject any installed card from the media-card reader.
-  **CAUTION:** Exercise caution when handling rechargeable Li-ion batteries in laptops. Swollen batteries should not be used and should be replaced and disposed properly.
-  **NOTE:** The color of your computer and certain components may differ from what is shown in this document.

Before working inside your computer

About this task

-  **NOTE:** The images in this document may differ from your computer depending on the configuration you ordered.

Steps

1. Save and close all open files and exit all open applications.
2. Shut down your computer. For Windows operating system, click **Start** >  **Power** > **Shut down**.
 -  **NOTE:** If you are using a different operating system, see the documentation of your operating system for shut-down instructions.

3. Disconnect your computer and all attached devices from their electrical outlets.
4. Disconnect all attached network devices and peripherals, such as keyboard, mouse, and monitor from your computer.

 **CAUTION: To disconnect a network cable, first unplug the cable from your computer and then unplug the cable from the network device.**

5. Remove any media card and optical disc from your computer, if applicable.

Safety precautions

The safety precautions section details the primary steps to be taken before performing any disassembly instructions.

Observe the following safety precautions before you perform any installation or break-fix procedures involving disassembly or reassembly:

- Turn off the computer and all attached peripherals.
- Disconnect the computer from AC power.
- Disconnect all network cables and peripherals from the computer.
- Use an ESD field service kit when working inside any desktop to avoid electrostatic discharge (ESD) damage.
- After removing a computer component, carefully place the removed component on an anti-static mat.
- Wear shoes with non-conductive rubber soles to reduce the chance of getting electrocuted.
- Unplugging, pressing, and holding the power button for 15 seconds should discharge residual power in the system board.

Standby power

Dell products with standby power must be unplugged before you open the case. Systems equipped with standby power are powered while turned off. The internal power enables the computer to be remotely turned on (Wake-on-LAN) and suspended into a sleep mode and has other advanced power management features.

Bonding

Bonding is a method for connecting two or more grounding conductors to the same electrical potential. This is done by using a field service electrostatic discharge (ESD) kit. When connecting a bonding wire, ensure that it is connected to bare metal and never to a painted or nonmetal surface. Ensure that the wrist strap is secure and in full contact with your skin. Remove all jewelry such as watches, bracelets, or rings before to grounding yourself and the equipment.

Electrostatic discharge—ESD protection

ESD is a major concern when you handle electronic components, especially sensitive components such as expansion cards, processors, memory modules, and system boards. A slight charge can damage circuits in ways that may not be obvious, such as intermittent problems or a shortened product life span. As the industry pushes for lower power requirements and increased density, ESD protection is an increasing concern.

Due to the increased density of semiconductors used in recent Dell products, the sensitivity to static damage is now higher than in previous Dell products. For this reason, some previously approved methods of handling parts are no longer applicable.

Two recognized types of ESD damage are catastrophic and intermittent failures.

- **Catastrophic** – Catastrophic failures represent approximately 20 percent of ESD-related failures. The damage causes an immediate and complete loss of device functionality. An example of catastrophic failure is a memory module that has received a static shock and immediately generates a "No POST/No Video" symptom with a beep code that is emitted for missing or non-functional memory.
- **Intermittent** – Intermittent failures represent approximately 80 percent of ESD-related failures. The high rate of intermittent failures means that most of the time when damage occurs, it is not immediately recognizable. The memory module receives a static shock, but the tracing is merely weakened and does not immediately produce outward symptoms that are related to the damage. The weakened trace may take weeks or months to melt, and in the meantime may cause degradation of memory integrity, intermittent memory errors, and so on.

Intermittent failures also called latent or "walking wounded" are difficult to detect and troubleshoot.

Perform the following steps to prevent ESD damage:

- Use a wired ESD wrist strap that is properly grounded. Wireless anti-static straps do not provide adequate protection. Touching the chassis before handling parts does not ensure adequate ESD protection on parts with increased sensitivity to ESD damage.
- Handle all static-sensitive components in a static-safe area. If possible, use anti-static floor pads and workbench pads.
- When unpacking a static-sensitive component from its shipping carton, do not remove the component from the anti-static packing material until you are ready to install the component. Before unwrapping the anti-static packaging, use the anti-static wrist strap to discharge the static electricity from your body.
- Before transporting a static-sensitive component, place it in an anti-static container or packaging.

ESD Field Service kit

The unmonitored Field Service kit is the most commonly used service kit. Each Field Service kit includes three main components: anti-static mat, wrist strap, and bonding wire.

 **CAUTION: It is critical to keep ESD-sensitive devices away from internal parts that are insulators and often highly charged, such as plastic heat sink casings.**

Working Environment

Before deploying the ESD Field Service kit, assess the situation at the customer location. For example, deploying the kit for a server environment is different than for a desktop or laptop environment. Servers are typically installed in a rack within a data center; desktops or laptops are typically placed on office desks or cubicles. Always look for a large open flat work area that is free of clutter and large enough to deploy the ESD kit with additional space to accommodate the type of computer that is being repaired. The workspace should also be free of insulators that can cause an ESD event. On the work area, insulators such as Styrofoam and other plastics should always be moved at least 12 inches or 30 centimeters away from sensitive parts before physically handling any hardware components.

ESD Packaging

All ESD-sensitive devices must be shipped and received in static-safe packaging. Metal, static-shielded bags are preferred. However, you should always return the damaged part using the same ESD bag and packaging that the new part arrived in. The ESD bag should be folded over and taped shut and all the same foam packing material should be used in the original box that the new part arrived in. ESD-sensitive devices should be removed from packaging only at an ESD-protected work surface, and parts should never be placed on top of the ESD bag because only the inside of the bag is shielded. Always place parts in your hand, on the ESD mat, in the computer, or inside an anti-static bag.

Components of an ESD Field Service kit

The components of an ESD Field Service kit are:

- **Anti-Static Mat** – The anti-static mat is dissipative and parts can be placed on it during service procedures. When using an anti-static mat, your wrist strap should be snug and the bonding wire should be connected to the anti-static mat and to any bare metal on the computer being worked on. Once deployed properly, service parts can be removed from the ESD bag and placed directly on the anti-static mat. ESD-sensitive items are safe in your hand, on the anti-static mat, in the computer, or inside an ESD bag.
- **Wrist Strap and Bonding Wire** – The wrist strap and bonding wire can be either directly connected between your wrist and bare metal on the hardware if the ESD mat is not required, or connected to the anti-static mat to protect hardware that is temporarily placed on the mat. The physical connection of the wrist strap and bonding wire between your skin, the ESD mat, and the hardware is known as bonding. Use only Field Service kits with a wrist strap, anti-static mat, and bonding wire. Never use wireless wrist straps. Always be aware that the internal wires of a wrist strap are prone to damage from normal wear and tear, and must be checked regularly with a wrist strap tester in order to avoid accidental ESD hardware damage. It is recommended to test the wrist strap and bonding wire at least once per week.
- **ESD Wrist Strap Tester** – The wires inside an ESD strap are prone to damage over time. When using an unmonitored kit, it is a best practice to regularly test the strap prior to each service call, and at a minimum, test once per week. A wrist strap tester is the best method for doing this test. If you do not have your own wrist strap tester, check with your regional office to find out if they have one. To perform the test, plug the bonding-wire of the wrist-strap into the tester while it is strapped to your wrist and push the button to test. A green LED is lit if the test is successful; a red LED is lit and an alarm sounds if the test fails.

 **NOTE:** It is recommended to always use the traditional wired ESD grounding wrist strap and protective anti-static mat when servicing Dell products. In addition, it is critical to keep sensitive parts separate from all insulator parts while servicing the computer, and use anti-static bags for transporting sensitive components.

Transporting sensitive components

When transporting ESD sensitive components such as replacement parts or parts to be returned to Dell, it is critical to place these parts in anti-static bags for safe transport.

Lifting equipment

Adhere to the following guidelines when lifting heavy equipment:

 **CAUTION: Do not lift greater than 50 pounds. Always obtain additional resources or use a mechanical lifting device.**

1. Get a firm balanced footing. Keep your feet apart for a stable base, and point your toes out.
2. Tighten stomach muscles. Abdominal muscles support your spine when you lift, offsetting the force of the load.
3. Lift with your legs, not your back.
4. Keep the load close. The closer it is to your spine, the less force it exerts on your back.
5. Keep your back upright, whether lifting or setting down the load. Do not add the weight of your body to the load. Avoid twisting your body and back.
6. Follow the same technique in reverse to set the load down.

After working inside your computer

About this task

 **CAUTION: Leaving stray or loose screws inside your computer may severely damage your computer.**

Steps

1. Replace all screws and ensure that no stray screws remain inside your computer.
2. Connect any external devices, peripherals, or cables you removed before working on your computer.
3. Replace any media cards, discs, or any other parts that you removed before working on your computer.
4. Connect your computer and all attached devices to their electrical outlets.
5. Turn on your computer.

BitLocker

 **CAUTION: If BitLocker is not suspended before updating the BIOS, the BitLocker key is not recognized the next time you reboot the computer. You will then be prompted to enter the recovery key to progress, and the system displays a prompt for the recovery key on each reboot. If the recovery key is not known, this can result in data loss or an operating system reinstall. For more information, see Knowledge Article: [updating the BIOS on Dell systems with BitLocker enabled](#).**

The installation of the following components triggers BitLocker:

- Hard disk drive or solid-state drive
- System board

Recommended tools

The procedures in this document may require the following tools:









- Phillips screwdriver #0

- Phillips screwdriver #1
- Plastic scribe

Screw list

- NOTE:** When removing screws from a component, it is recommended to note the screw type and the quantity of screws, and then place them in a screw storage box. This is to ensure that the correct number of screws and correct screws are restored when the component is replaced.
- NOTE:** Some computers have magnetic surfaces. Ensure that the screws are not left attached to such surfaces when replacing a component.
- NOTE:** Screw color may vary depending on the configuration ordered.

Table 23. Screw list

Component	Screw type	Quantity	Image
Side cover	#6-32 (Captive screw)	1	
System board	M3x5	5	
System board	M3x4	3	
Wireless card	M2x3.5	1	
M.2 2230 or M.2 2280 solid-state drive	M2x3.5	1	
SMA antenna assembly	M3x3	1	
Optional I/O module (HDMI 2.1/ DisplayPort 1.4a (HBR3)/VGA)	M3x3	2	
Optional Type-C module (USB Type-C with DisplayPort Alt Mode)	M3x3	2	

Major components of OptiPlex Micro Plus 7020

The following image shows the major components of OptiPlex Micro Plus 7020.

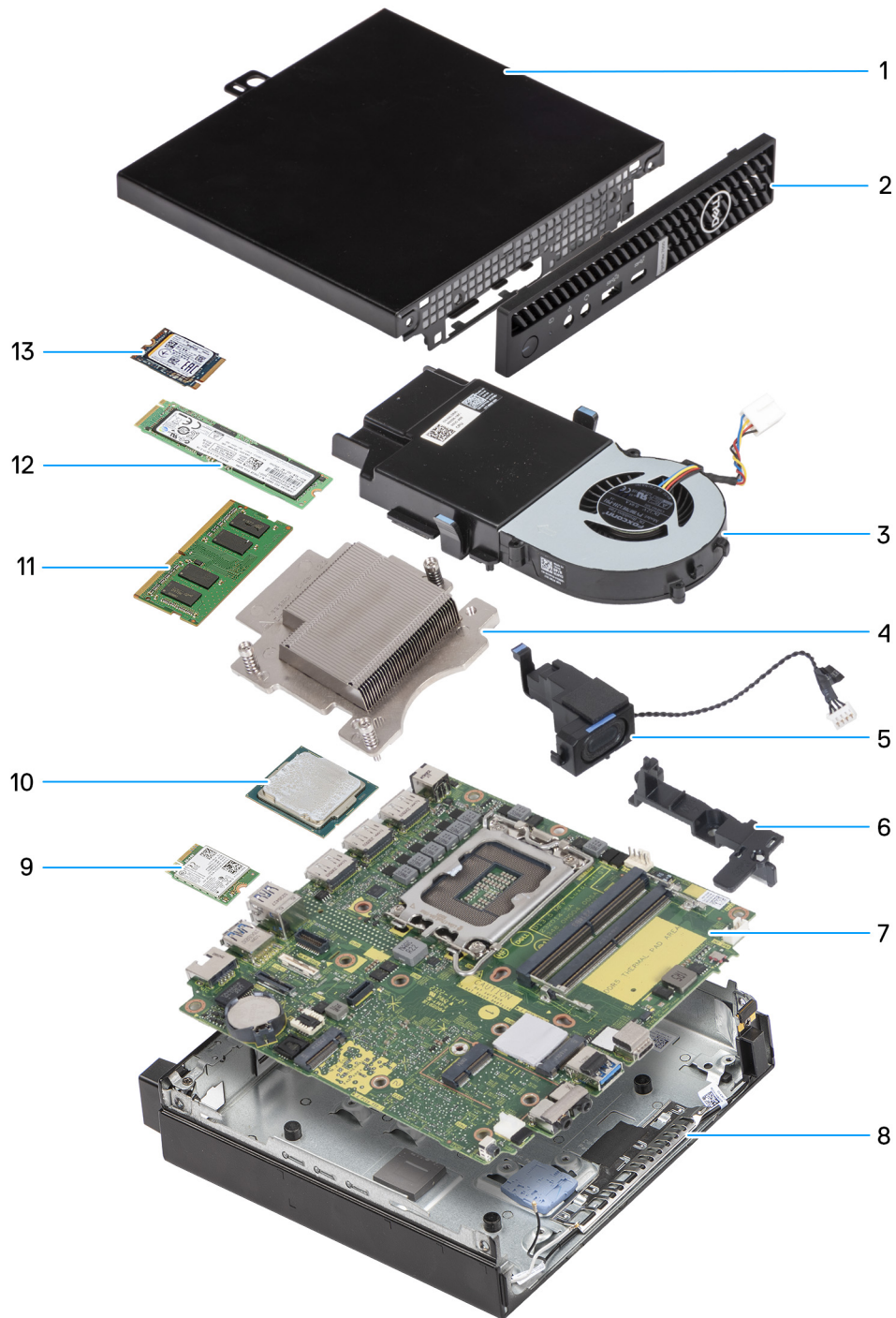



Figure 8. Major components of OptiPlex Micro Plus 7020

1. Side cover
2. Front bezel
3. Fan assembly
4. Heat sink
5. Speaker
6. Speaker-support bracket
7. System board
8. Chassis
9. Wireless card

10. Processor
11. Memory module
12. M.2 2280 solid-state drive
13. M.2 2230 solid-state drive

 **NOTE:** Dell Technologies provides a list of components and their part numbers for the original system configuration purchased. These parts are available according to warranty coverages purchased by the customer. Contact your Dell sales representative for purchase options.

Removing and installing side cover

Removing the side cover

Prerequisites

1. Follow the procedure in [Before working inside your computer](#).

About this task

The following image(s) indicate the location of the side cover and provides a visual representation of the removal procedure.

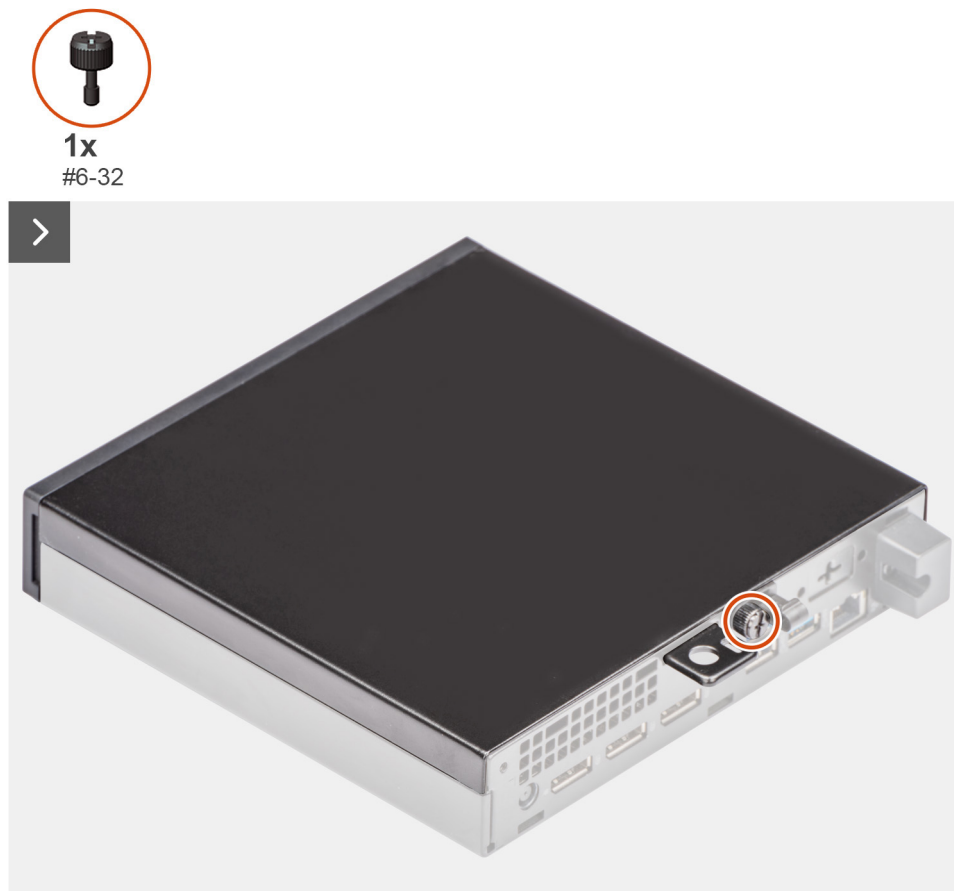

Figure 9. Removing the side cover

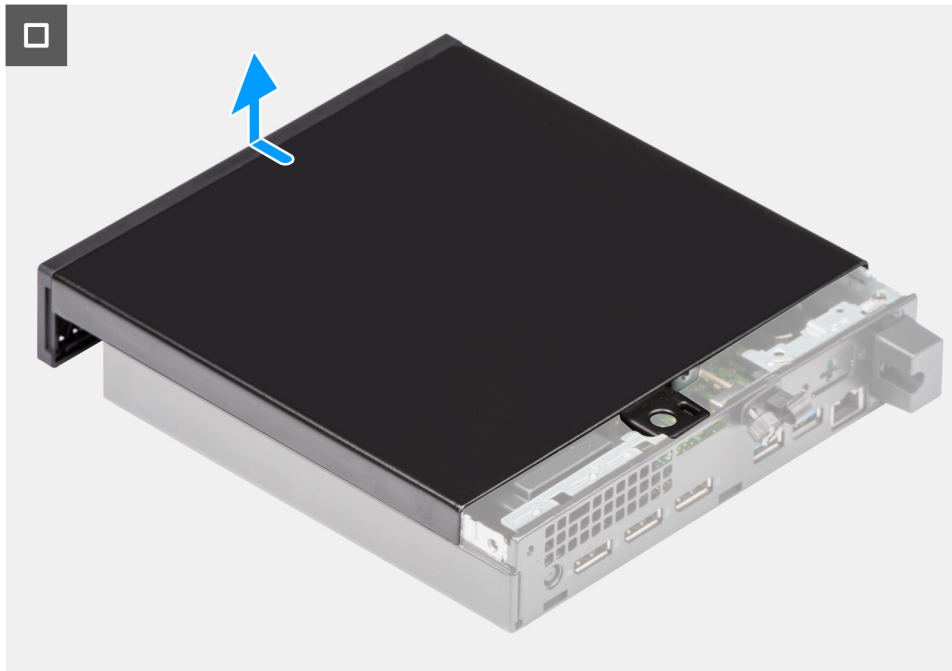

Figure 10. Removing the side cover

Steps

1. Place your computer on its side with the side cover facing up.
2. Loosen the thumb-screw (6x32) that secures the side cover to the chassis.
3. Slide and lift the side cover off the chassis.

Installing the side cover

Prerequisites

If you are replacing a component, remove the existing component before performing the installation process.

About this task

The following image(s) indicate the location of the side cover and provides a visual representation of the installation procedure.



1x
#6-32

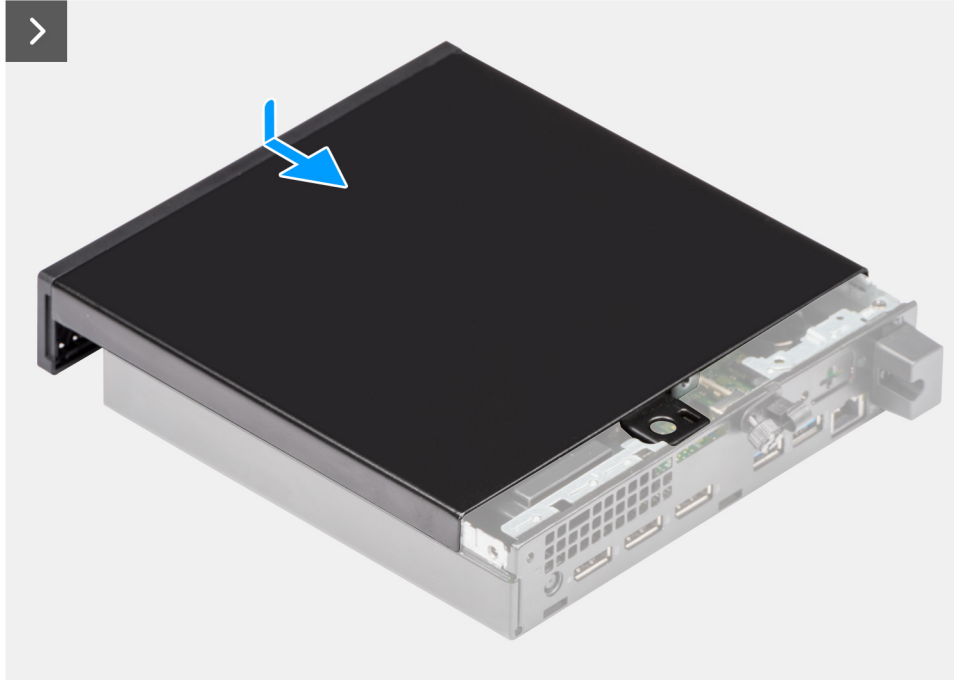

Figure 11. Installing the side cover



Figure 12. Installing the side cover

Steps

1. Place the side cover on the chassis.

2. Align the tabs on the side cover with the slots on the chassis.
3. Slide the side cover into place towards the rear of the computer.
4. Tighten the thumb-screw (6x32) that secures the side cover to the chassis.

Next steps

1. Follow the procedure in [After working inside your computer](#).

Removing and installing coin-cell battery

Removing the coin-cell battery

⚠ WARNING: This computer contains a coin-cell battery and requires trained technicians for handling guidance.

⚠ CAUTION: Removing the coin-cell battery will clear the CMOS and will reset BIOS settings.

Prerequisites

1. Follow the procedure in [Before working inside your computer](#).
2. Remove the [side cover](#).

About this task

The following image(s) indicate the location of the coin-cell battery and provides a visual representation of the removal procedure.

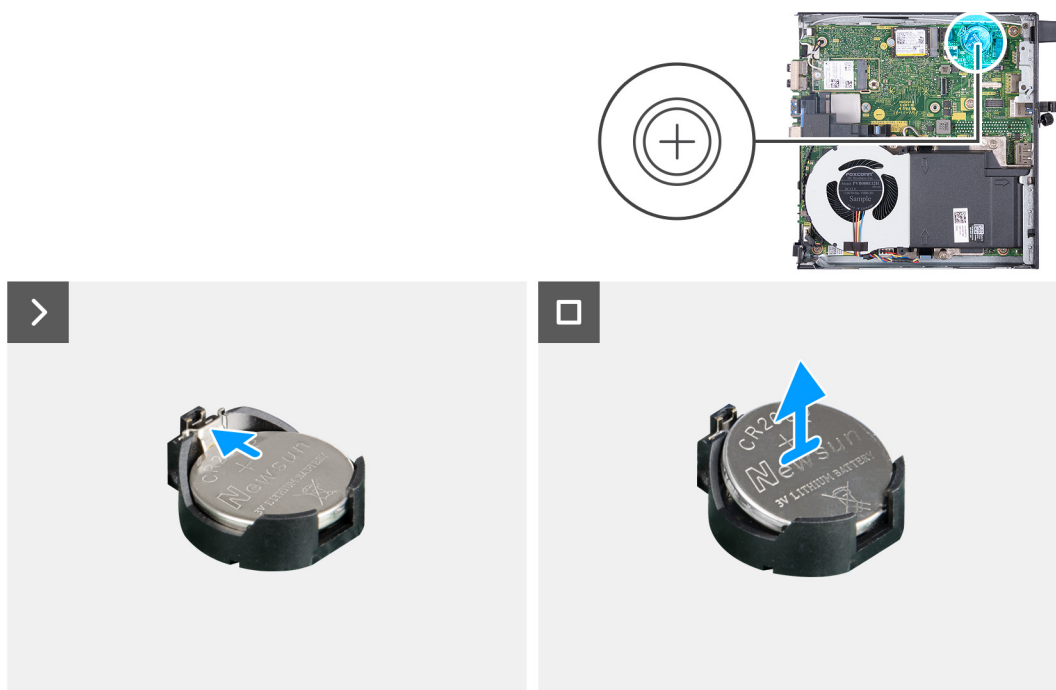

Figure 13. Removing the coin-cell battery

Steps

1. Push the coin-cell battery-release lever on the coin-cell battery socket to release the coin-cell battery.
2. Lift the coin-cell battery from the coin-cell battery socket.

Installing the coin-cell battery

⚠ WARNING: This computer contains a coin-cell battery and requires trained technicians for handling guidance.

Prerequisites

If you are replacing a component, remove the existing component before performing the installation process.

About this task

The following image(s) indicate the location of the coin-cell battery and provides a visual representation of the installation procedure.

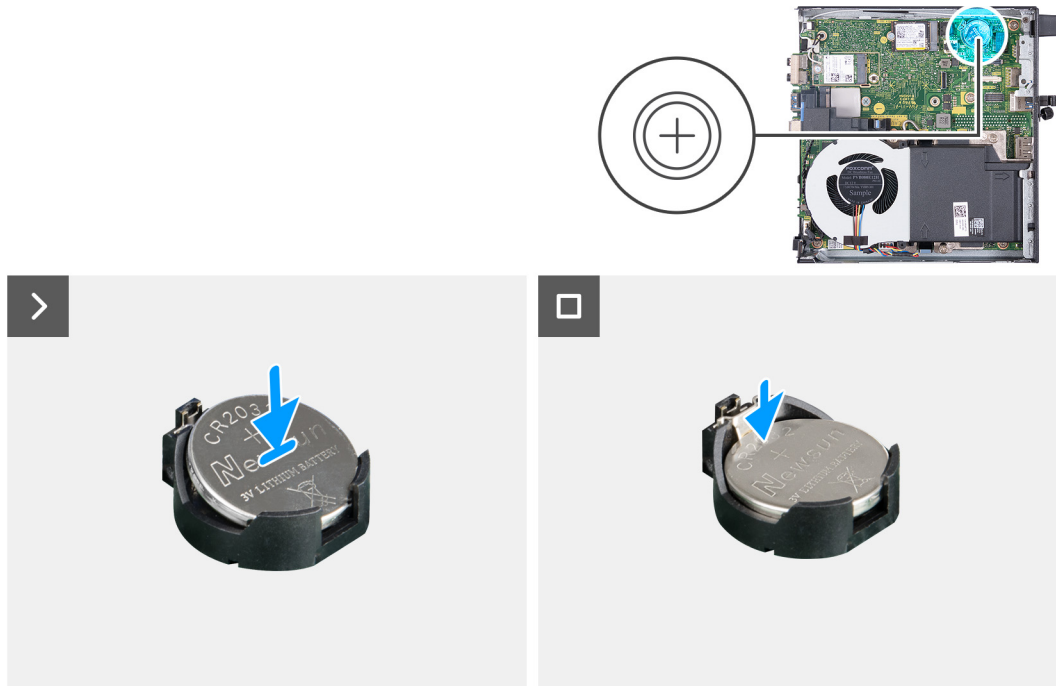

Figure 14. Installing the coin-cell battery

Steps

With the positive side (+) facing up, insert the coin-cell battery into the battery socket on the system board and snap the battery into place.

Next steps

1. Install the [side cover](#).
2. Follow the procedure in [After working inside your computer](#).

Removing and installing Customer Replaceable Units (CRUs)

The replaceable components in this chapter are Customer Replaceable Units (CRUs).

 **CAUTION:** Customers can replace only the Customer Replaceable Units (CRUs) following the safety precautions and replacement procedures.

 **NOTE:** The images in this document may differ from your computer depending on the configuration you ordered.

Front bezel

Removing the front bezel

Prerequisites

1. Follow the procedure in [Before working inside your computer](#).
2. Remove the [side cover](#).

About this task

The following image(s) indicate the location of the front bezel and provides a visual representation of the removal procedure.

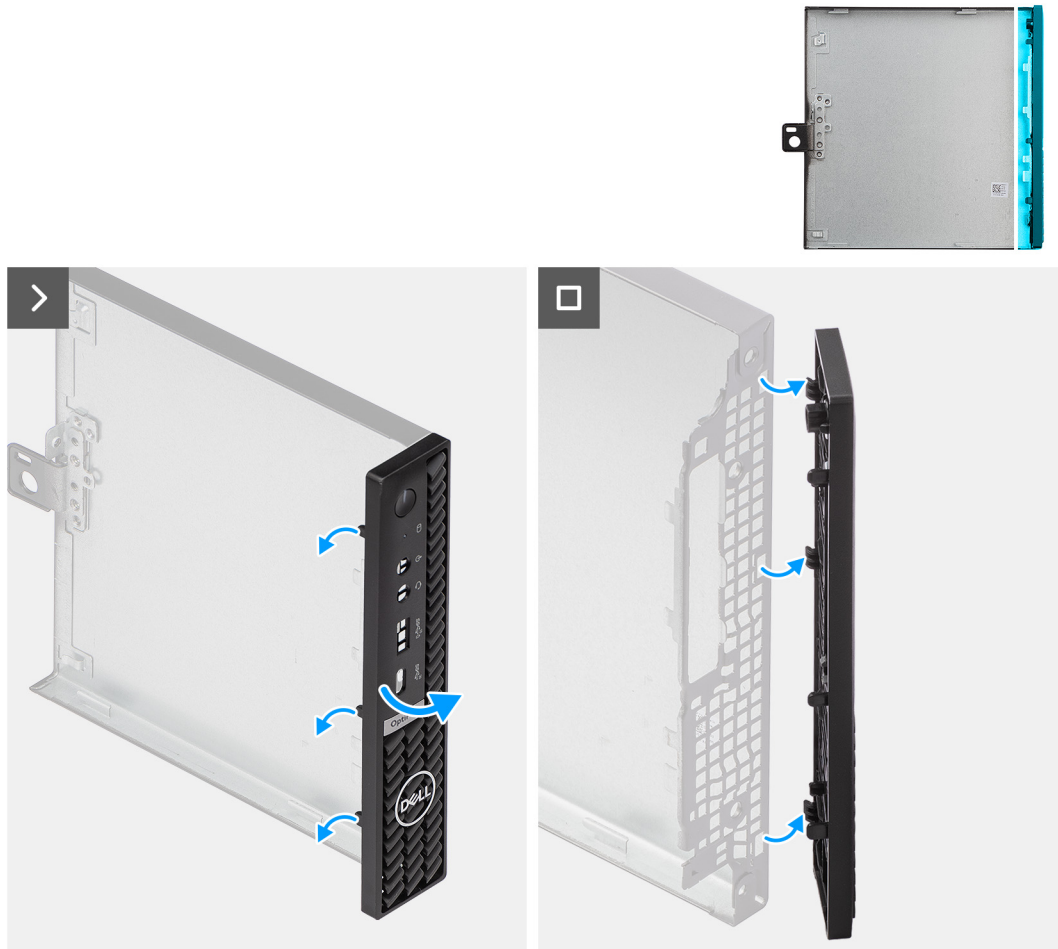

Figure 15. Removing the front bezel

Steps

1. Gently pry and release the front-cover tabs starting from the top, working down to the bottom tab.
2. Swing the front bezel outwards, away from the side cover.

Installing the front bezel

Prerequisites

If you are replacing a component, remove the existing component before performing the installation process.

About this task

The following image(s) indicate the location of the front bezel and provides a visual representation of the installation procedure.

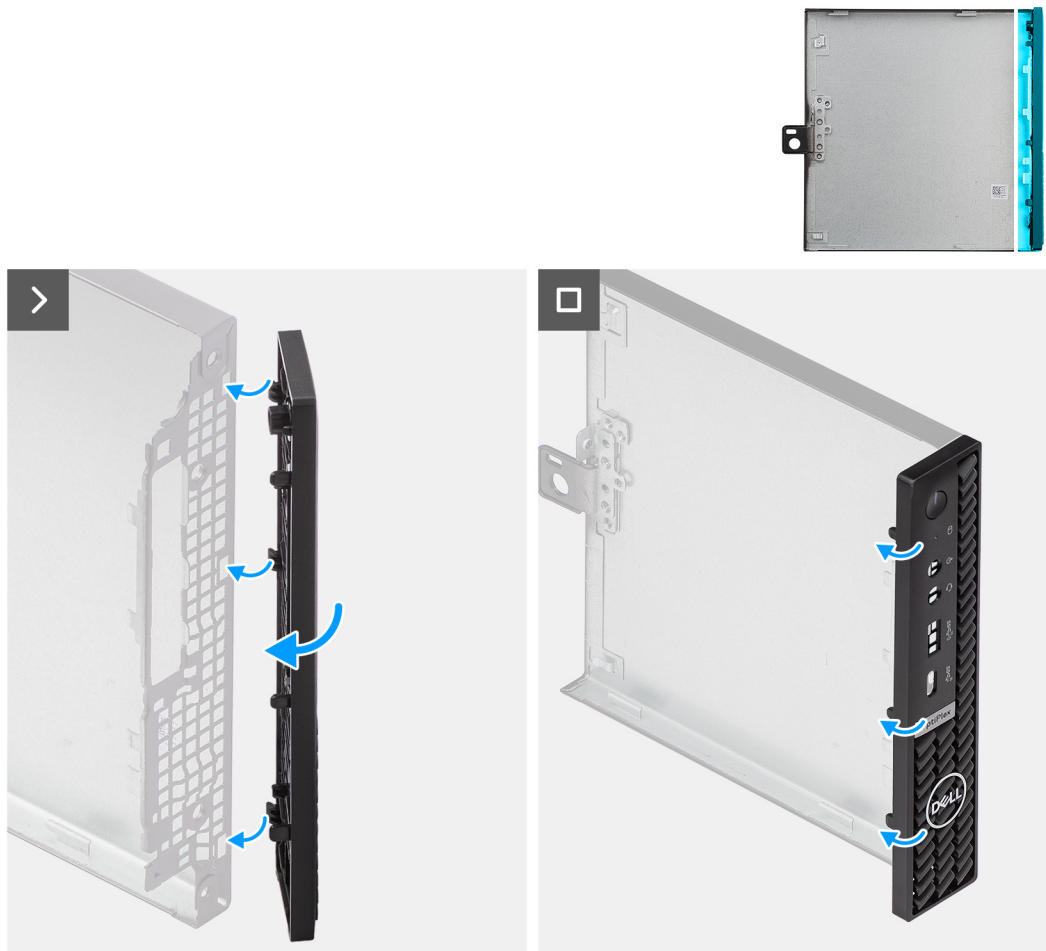

Figure 16. Installing the front bezel

Steps

1. Insert the tabs on the right side of the bezel into the corresponding slots on the side cover.
2. Push the left side of the front bezel towards the side cover, snapping the tabs into position.

Next steps

1. Install the [side cover](#).
2. Follow the procedure in [After working inside your computer](#).

Speaker

Removing the speaker

Prerequisites

1. Follow the procedure in [Before working inside your computer](#).
2. Remove the [side cover](#).

About this task

The following image(s) indicate the location of the speaker and provides a visual representation of the removal procedure.

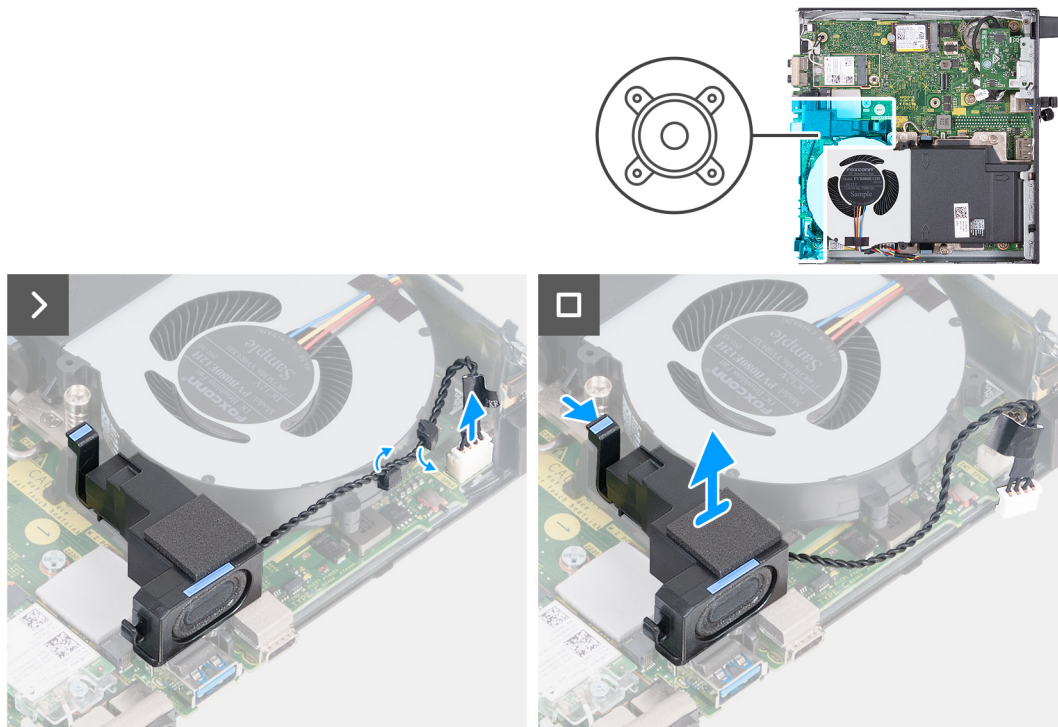

Figure 17. Removing the speaker

Steps

1. Disconnect the speaker cable from its connector (INT SPKR) on the system board.
2. Remove the speaker cable from the routing guides on the fan assembly.
3. Press the tab that secures the speaker to the speaker-support bracket.
4. Lift the speaker off the bracket.

Installing the speaker

Prerequisites

If you are replacing a component, remove the existing component before performing the installation process.

About this task

The following image(s) indicate the location of the speaker and provides a visual representation of the installation procedure.

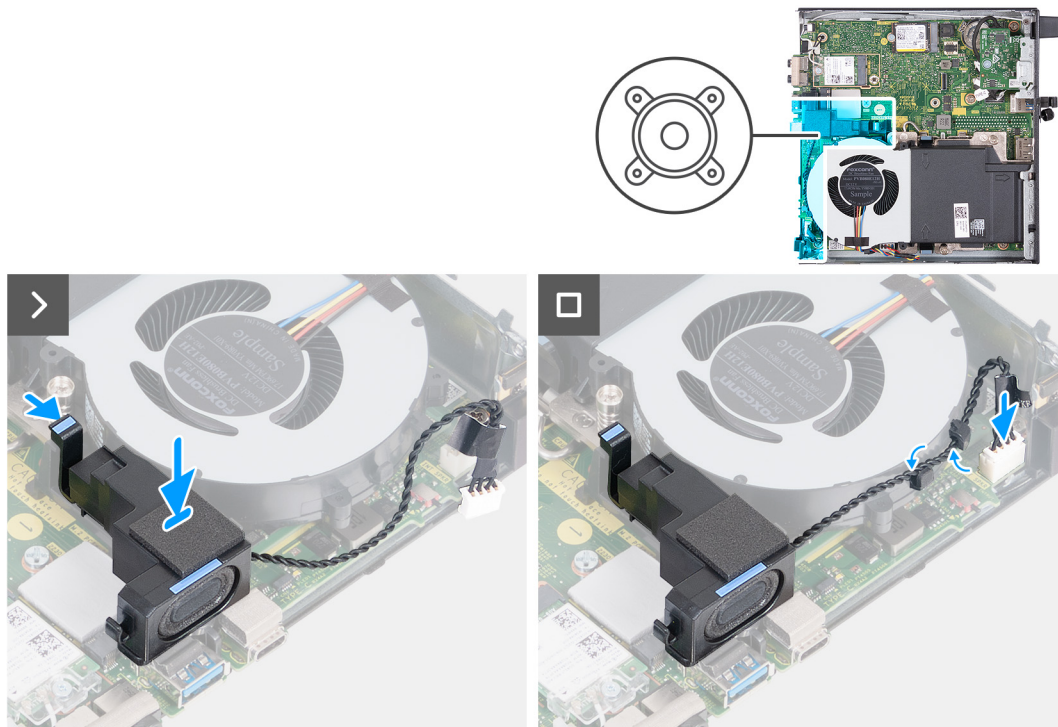

Figure 18. Installing the speaker

Steps

1. Press and hold on the tab that secures the speaker to the speaker-support bracket.
2. Place the speaker on the bracket.
3. Release the tab that secures the speaker to the speaker-support bracket.
4. Route the speaker cable through the routing guides on the fan assembly.
5. Connect the speaker cable to its connector (INT SPKR) on the system board.

Next steps

1. Install the [side cover](#).
2. Follow the procedure in [After working inside your computer](#).

Solid state drive

Removing the M.2 2230 solid-state drive from slot 0

Prerequisites

1. Follow the procedure in [Before working inside your computer](#).
2. Remove the [side cover](#).
3. Remove the [speaker](#).

About this task

- NOTE:** Depending on the configuration ordered, your computer may have an M.2 2230 or an M.2 2280 solid-state drive that is installed in solid-state drive slot 0 (M.2 PCIe SSD 0).
- NOTE:** This procedure is applicable for computers where an M.2 2230 solid-state drive is installed in solid-state drive slot 0 (M.2 PCIe SSD 0).

The following image(s) indicate the location of the M.2 2230 solid-state drive in slot 0 and provides a visual representation of the removal procedure.

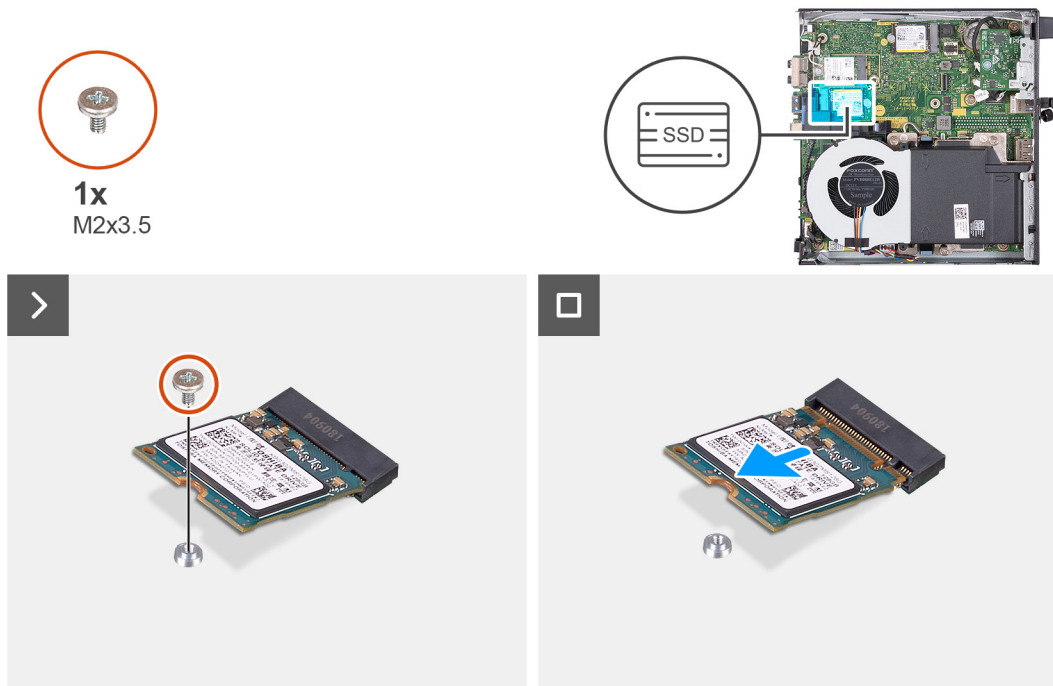

Figure 19. Removing the 2230 solid-state drive from slot 0

Steps

1. Remove the screw (M2x3.5) that secures the M.2 2230 solid-state drive to the system board.
2. Slide and lift the M.2 2230 solid-state drive off the solid-state drive slot 0 (M.2 PCIe SSD 0) on the system board.

Installing the M.2 2230 solid-state drive in slot 0

Prerequisites

If you are replacing a component, remove the existing component before performing the installation process.

About this task

NOTE: This procedure is only applicable if you are installing an M.2 2230 solid-state drive in the solid-state drive slot 0 (M.2 PCIe SSD 0).

The following image(s) indicate the location of the M.2 2230 solid-state drive in slot 0 and provides a visual representation of the installation procedure.

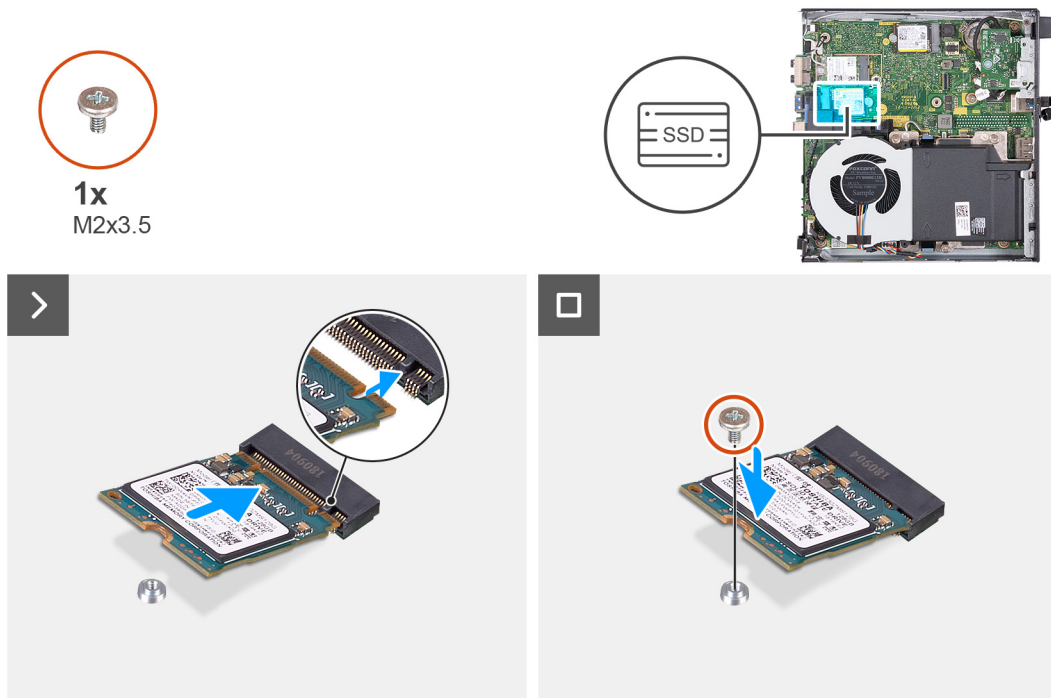

Figure 20. Installing the 2230 solid-state drive in slot 0

Steps

1. Align the notch on the M.2 2230 solid-state drive with the tab on the solid-state drive slot 0 (M.2 PCIe SSD 0).
2. Slide the M.2 2230 solid-state drive into the solid-state drive slot 0 (M.2 PCIe SSD 0) on the system board.
3. Replace the screw (M2x3.5) that secures the M.2 2230 solid-state drive to the system board.

Next steps

1. Install the [speaker](#).
2. Install the [side cover](#).
3. Follow the procedure in [After working inside your computer](#).

Removing the M.2 2230 solid-state drive from slot 1

Prerequisites

1. Follow the procedure in [Before working inside your computer](#).
2. Remove the [side cover](#).

About this task

NOTE: Depending on the configuration ordered, your computer may have an M.2 2230 or an M.2 2280 solid-state drive installed in the solid-state drive slot 1 (M.2 PCIe SSD 1).

NOTE: This procedure is applicable for computers where an M.2 2230 solid-state drive is installed in the solid-state drive slot 1 (M.2 PCIe SSD 1).

The following image(s) indicate the location of the M.2 2230 solid-state drive in slot 1 and provides a visual representation of the removal procedure.

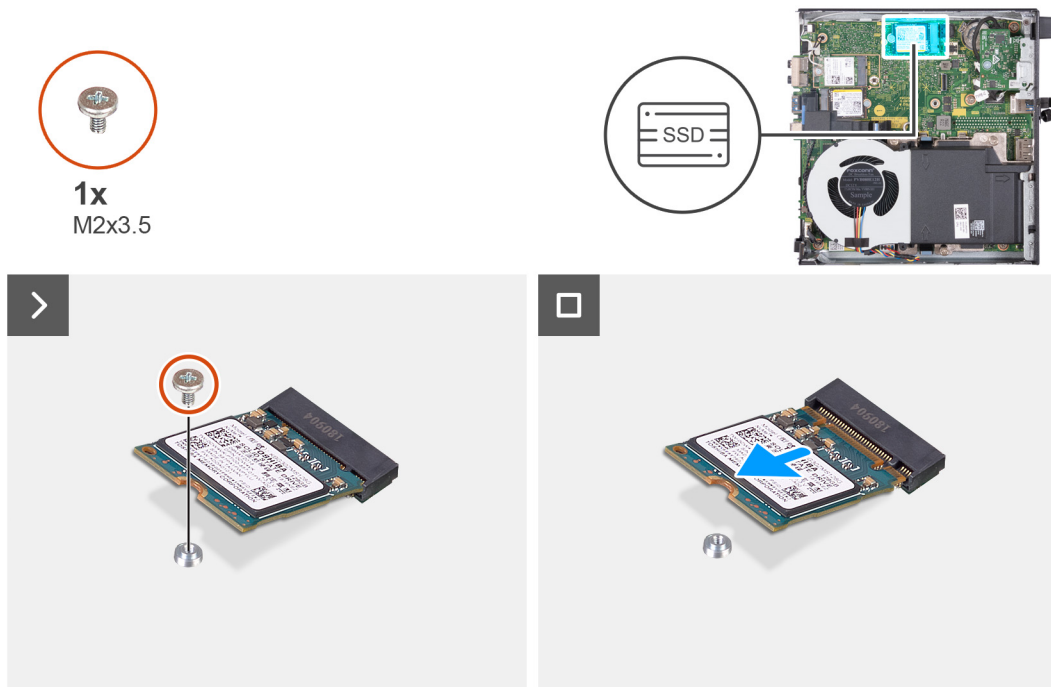

Figure 21. Removing the M.2 2230 solid-state drive from slot 1

Steps

1. Remove the screw (M2x3.5) that secures the M.2 2230 solid-state drive to the system board.
2. Slide and lift the M.2 2230 solid-state drive off the solid-state drive slot 1 (M.2 PCIe SSD 1) on the system board.

Installing the M.2 2230 solid-state drive in slot 1

Prerequisites

If you are replacing a component, remove the existing component before performing the installation process.

About this task

NOTE: This procedure is only applicable if you are installing an M.2 2230 solid-state drive in the solid-state drive slot 1 (M.2 PCIe SSD 1).

The following image(s) indicate the location of the M.2 2230 solid-state drive in slot 1 and provides a visual representation of the installation procedure.

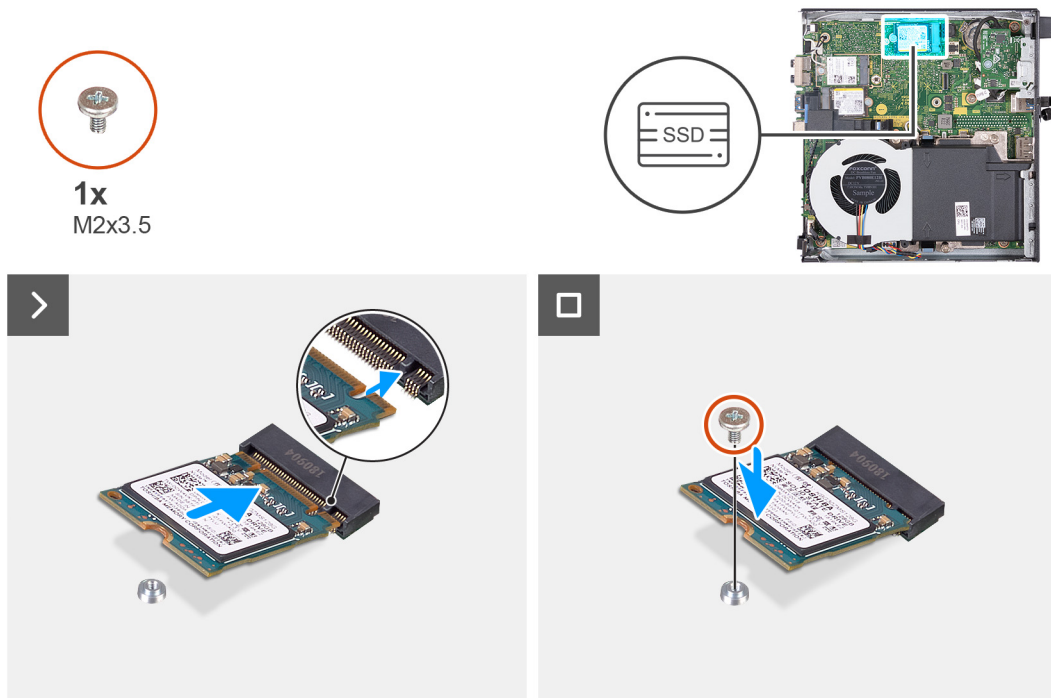

Figure 22. Installing the M.2 2230 solid-state drive in slot 1

Steps

1. Align the notch on the M.2 2230 solid-state drive with the tab on the solid-state drive slot 1 (M.2 PCIe SSD 1).
2. Slide the M.2 2230 solid-state drive into the solid-state drive slot 1 (M.2 PCIe SSD 1) on the system board.
3. Replace the screw (M2x3.5) that secures the M.2 2230 solid-state drive to the system board.

Next steps

1. Install the [side cover](#).
2. Follow the procedure in [After working inside your computer](#).

Removing the M.2 2280 solid-state drive from slot 0

Prerequisites

1. Follow the procedure in [Before working inside your computer](#).
2. Remove the [side cover](#).
3. Remove the [speaker](#).

About this task

- NOTE:** Depending on the configuration ordered, your computer may have an M.2 2230 or an M.2 2280 solid-state drive that is installed in solid-state drive slot 0 (M.2 PCIe SSD 0).
- NOTE:** This procedure is applicable for computers where an M.2 2280 solid-state drive is installed in solid-state drive slot 0 (M.2 PCIe SSD 0).

The following image(s) indicate the location of the M.2 2280 solid-state drive in slot 0 and provides a visual representation of the removal procedure.

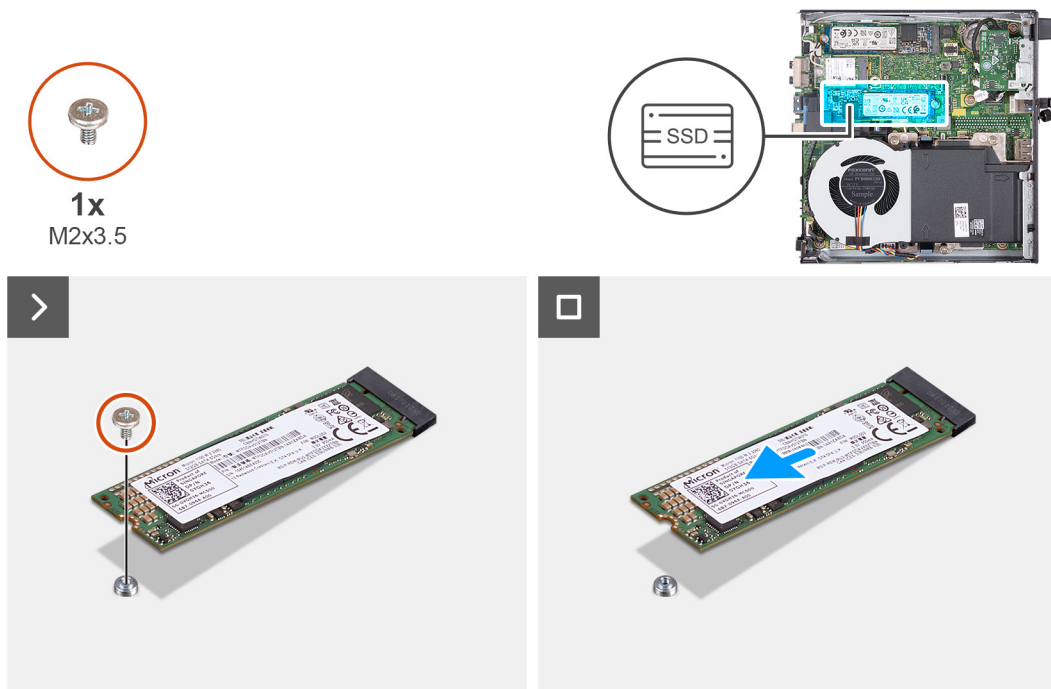

Figure 23. Removing the M.2 2280 solid-state drive from slot 0

Steps

1. Remove the screw (M2x3.5) that secures the M.2 2280 solid-state drive to the system board.
2. Slide and lift the M.2 2280 solid-state drive off the solid-state drive slot 0 (M.2 PCIe SSD 0) on the system board.

Installing the M.2 2280 solid-state drive in slot 0

Prerequisites

If you are replacing a component, remove the existing component before performing the installation process.

About this task

NOTE: This procedure is only applicable if you are installing an M.2 2280 solid-state drive in the solid-state drive slot 0 (M.2 PCIe SSD 0).

The following image(s) indicate the location of the M.2 2280 solid-state drive in slot 0 and provides a visual representation of the installation procedure.

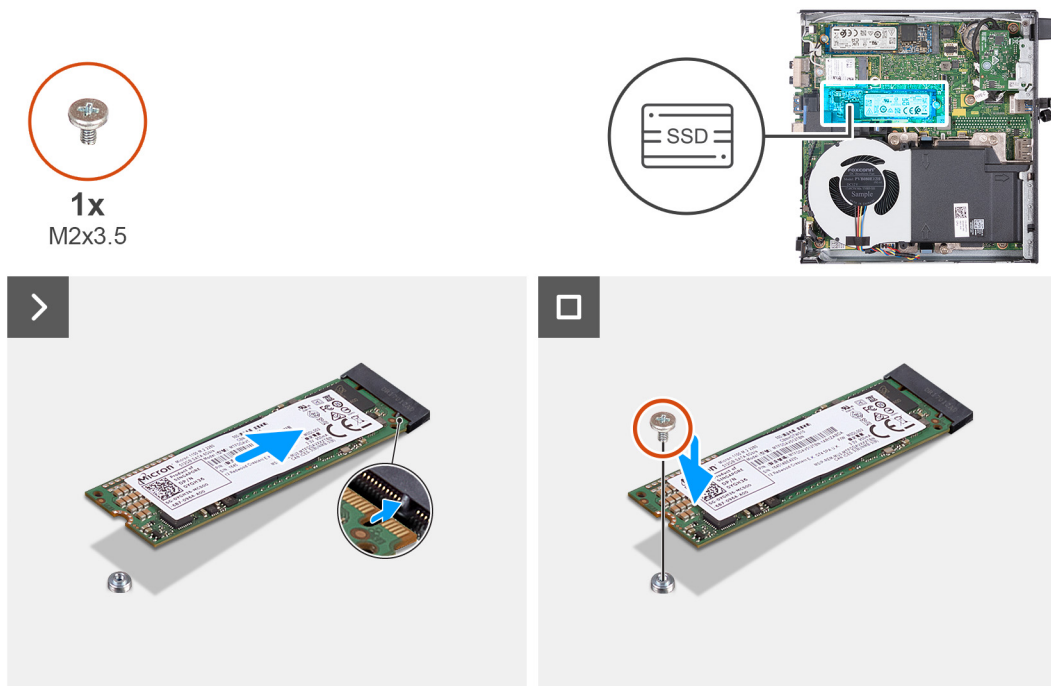

Figure 24. Installing the M.2 2280 solid-state drive in slot 0

Steps

1. Align the notch on the M.2 2280 solid-state drive with the tab on the solid-state drive slot 0 (M.2 PCIe SSD 0).
2. Slide the M.2 2280 solid-state drive into the solid-state drive slot (M.2 PCIe SSD 0) on the system board.
3. Replace the screw (M2x3.5) that secures the M.2 2280 solid-state drive to the system board.

Next steps

1. Install the [speaker](#).
2. Install the [side cover](#).
3. Follow the procedure in [After working inside your computer](#).

Removing the M.2 2280 solid-state drive from slot 1

Prerequisites

1. Follow the procedure in [Before working inside your computer](#).
2. Remove the [side cover](#).

About this task

NOTE: Depending on the configuration ordered, your computer may have an M.2 2230 or an M.2 2280 solid-state drive installed in solid-state drive slot 1 (M.2 PCIe SSD 1).

NOTE: This procedure is applicable for computers where an M.2 2280 solid-state drive is installed in solid-state drive slot 1 (M.2 PCIe SSD 1).

The following image(s) indicate the location of the M.2 2280 solid-state drive in slot 1 and provides a visual representation of the removal procedure.

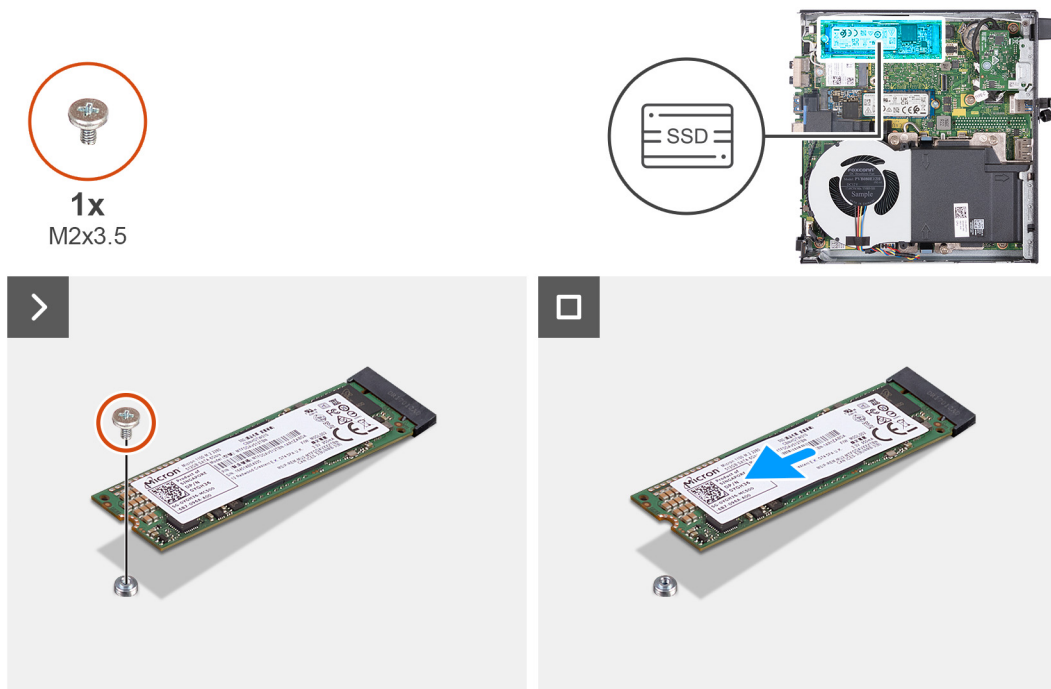

Figure 25. Removing the M.2 2280 solid-state drive from slot 1

Steps

1. Remove the screw (M2x3.5) that secures the M.2 2280 solid-state drive to the system board.
2. Slide and lift the M.2 2280 solid-state drive off the solid-state drive slot 1 (M.2 PCIe SSD 1) on the system board.

Installing the M.2 2280 solid-state drive in slot 1

Prerequisites

If you are replacing a component, remove the existing component before performing the installation process.

About this task

NOTE: This procedure is only applicable if you are installing an M.2 2280 solid-state drive in the solid-state drive slot 1 (M.2 PCIe SSD 1).

The following image(s) indicate the location of the M.2 2280 solid-state drive in slot 1 and provides a visual representation of the installation procedure.

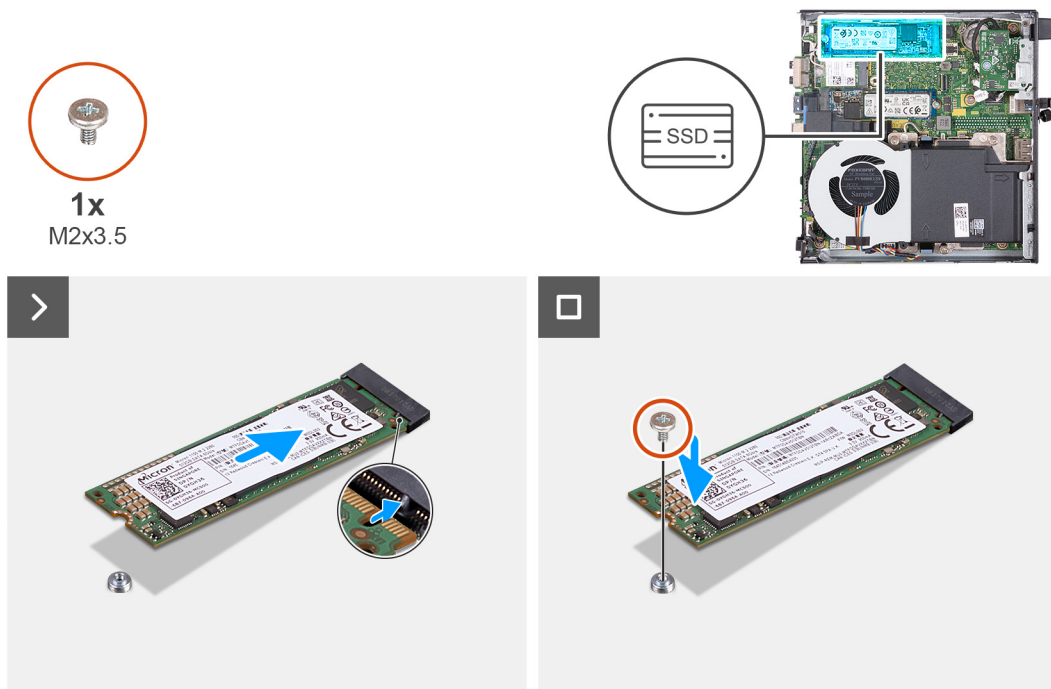

Figure 26. Installing the M.2 2280 solid-state drive in slot 1

Steps

1. Align the notch on the M.2 2280 solid-state drive with the tab on the solid-state drive slot 1 (M.2 PCIe SSD 1).
2. Slide the M.2 2280 solid-state drive into solid-state drive slot 1 (M.2 PCIe SSD 1) on the system board.
3. Replace the screw (M2x3.5) that secures the M.2 2280 solid-state drive to the system board.

Next steps

1. Install the [side cover](#).
2. Follow the procedure in [After working inside your computer](#).

Location of the screw mount of the M.2 slot

Prerequisites

To install an M.2 solid-state drive of a different form factor on the M.2 slot, the location of the screw mount on the M.2 slot must be changed.

About this task

NOTE: This procedure only applies to the screw mount of the M.2 slot for the solid-state drive.

The following image(s) indicate the location of the screw mount on the M.2 slot and provides a visual representation of the procedure to change the position of the screw mount.

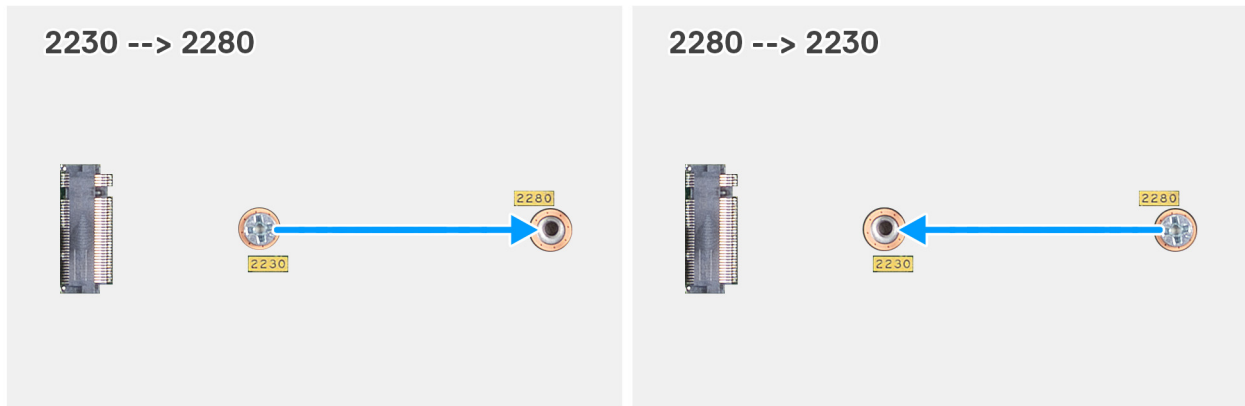

Figure 27. Moving the screw mount to support a different form factor (OptiPlex Micro Plus 7020)

Steps

1. **i** **NOTE: Steps 1 and 2** are applicable if an M.2 2280 solid-state drive is being installed to replace the existing M.2 2230 solid-state drive.
Remove the screw mount from its current screw hole (2230) of the M.2 SSD PCIe connector (M.2 PCIe SSD-0 or M.2 PCIe SSD-1).
2. Install the screw mount on the other screw hole (2280) of the M.2 SSD PCIe connector (M.2 PCIe SSD-0 or M.2 PCIe SSD-1).
3. **i** **NOTE: Steps 3 and 4** are applicable if an M.2 2230 solid-state drive is being installed to replace the existing M.2 2280 solid-state drive.
Remove the screw mount from its current screw hole (2280) of the M.2 SSD PCIe connector (M.2 PCIe SSD-0 or M.2 PCIe SSD-1).
4. Install the screw mount on the other screw hole (2230) of the M.2 SSD PCIe connector (M.2 PCIe SSD-0 or M.2 PCIe SSD-1).

Wireless card

Removing the wireless card

Prerequisites

1. Follow the procedure in [Before working inside your computer](#).
2. Remove the [side cover](#).

About this task

The following image(s) indicate the location of the wireless card and provides a visual representation of the removal procedure.

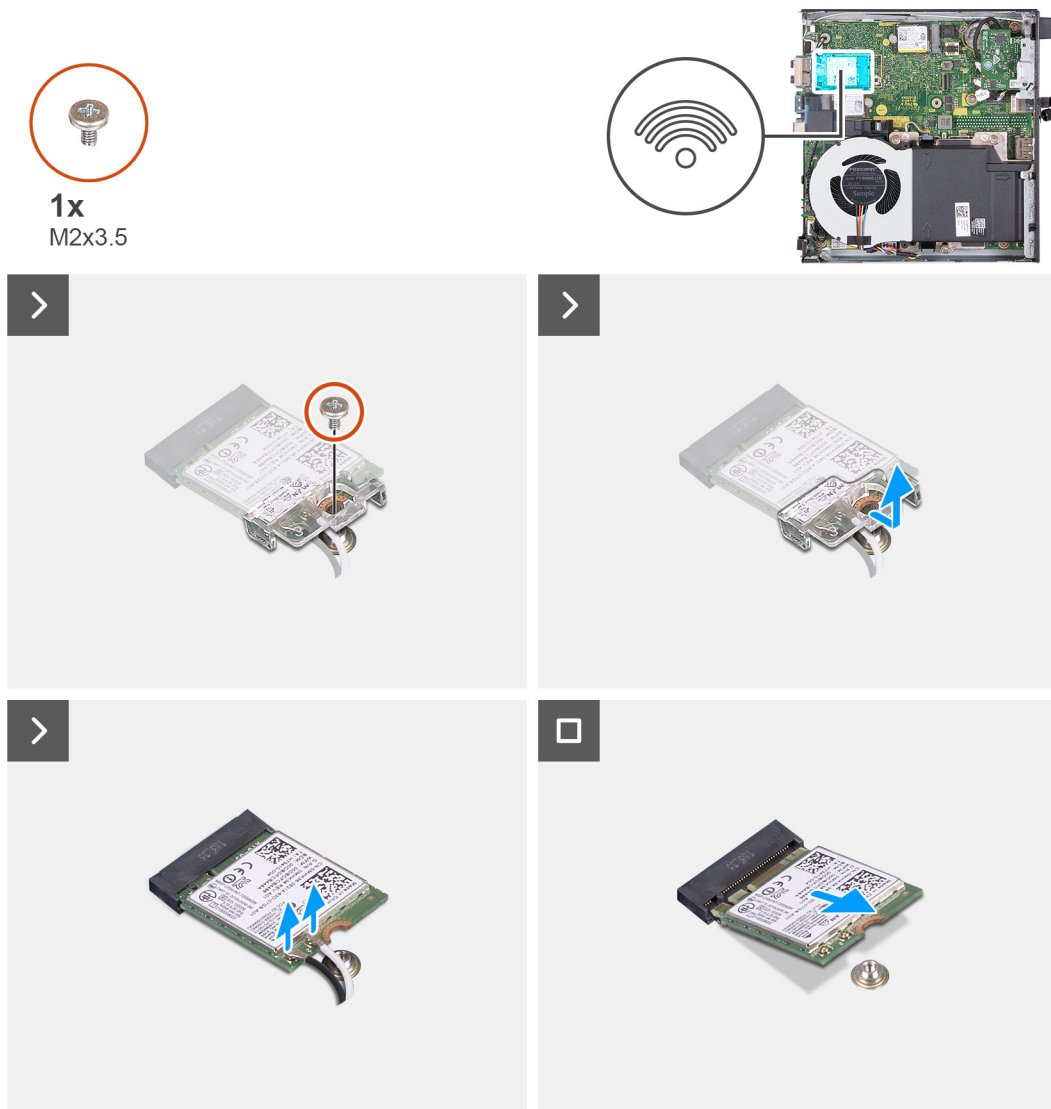

Figure 28. Removing the wireless card

Steps

1. Remove the screw (M2x3.5) that secures the wireless-card bracket to the wireless card.
2. Lift the wireless-card bracket off the wireless card.
3. Disconnect the antenna cables from the wireless card.
4. Slide and remove the wireless card from the wireless-card slot (M.2 WLAN).

Installing the wireless card

Prerequisites

If you are replacing a component, remove the existing component before performing the installation process.

About this task

The following image(s) indicate the location of the wireless card and provides a visual representation of the installation procedure.

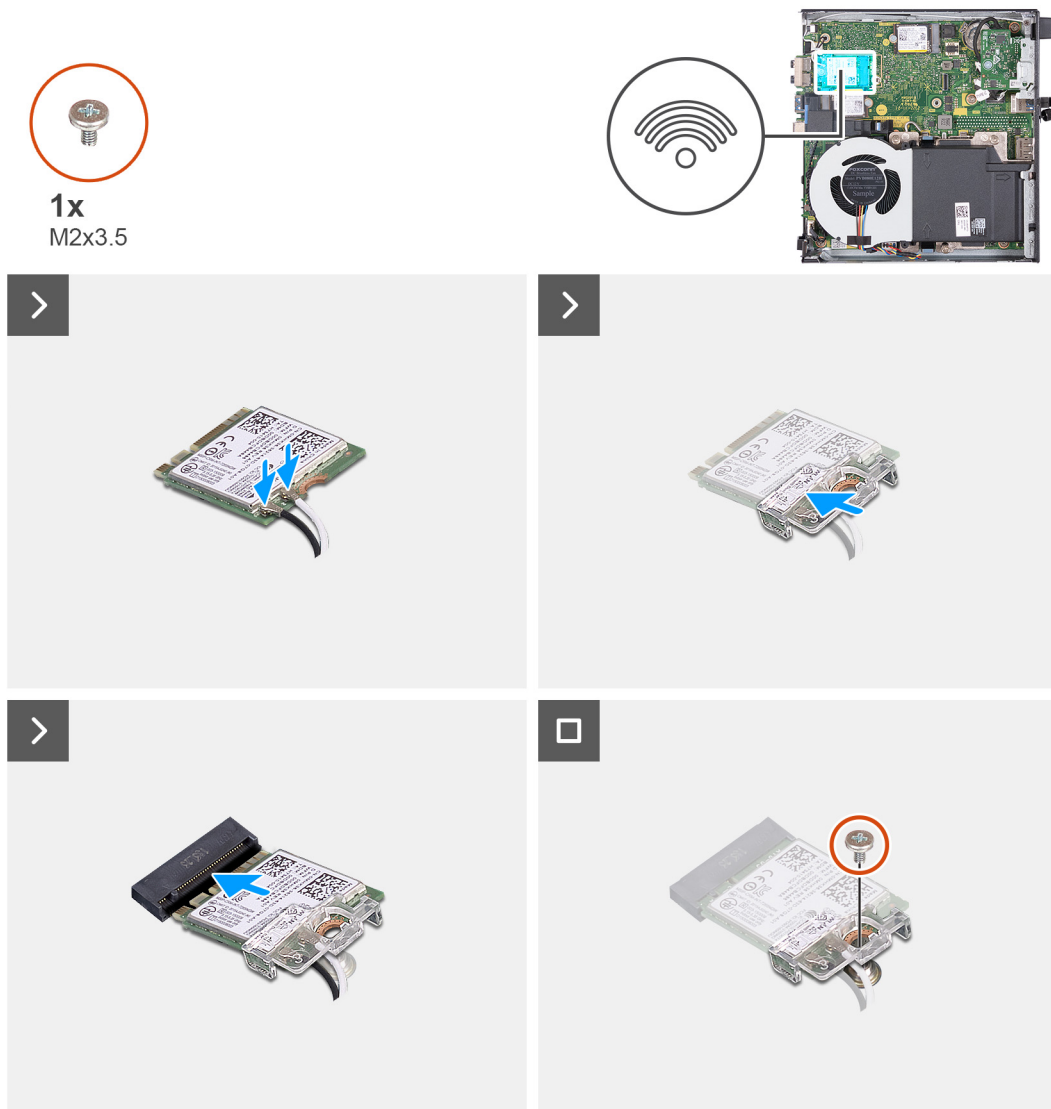

Figure 29. Installing the wireless card

Steps

1. Connect the antenna cables to the wireless card.

Table 24. Antenna-cable color scheme

Connector on the wireless card	Antenna-cable color	Silkscreen marking	
Main	White	MAIN	△ (white triangle)
Auxiliary	Black	AUX	▲ (black triangle)

2. Place the wireless-card bracket on the wireless card.
3. Align the notch on the wireless card with the tab on the wireless-card slot (M.2 WLAN).
4. Slide the wireless card at an angle into the wireless-card slot (M.2 WLAN).
5. Replace the screw (M2x3.5) that secures the wireless-card bracket to the wireless card.

Next steps

1. Install the [side cover](#).
2. Follow the procedure in [After working inside your computer](#).

Fan

Removing the fan

Prerequisites

1. Follow the procedure in [Before working inside your computer](#).
2. Remove the [side cover](#).
3. Remove the [speaker](#).

About this task

The following image(s) indicate the location of the fan and provides a visual representation of the removal procedure.

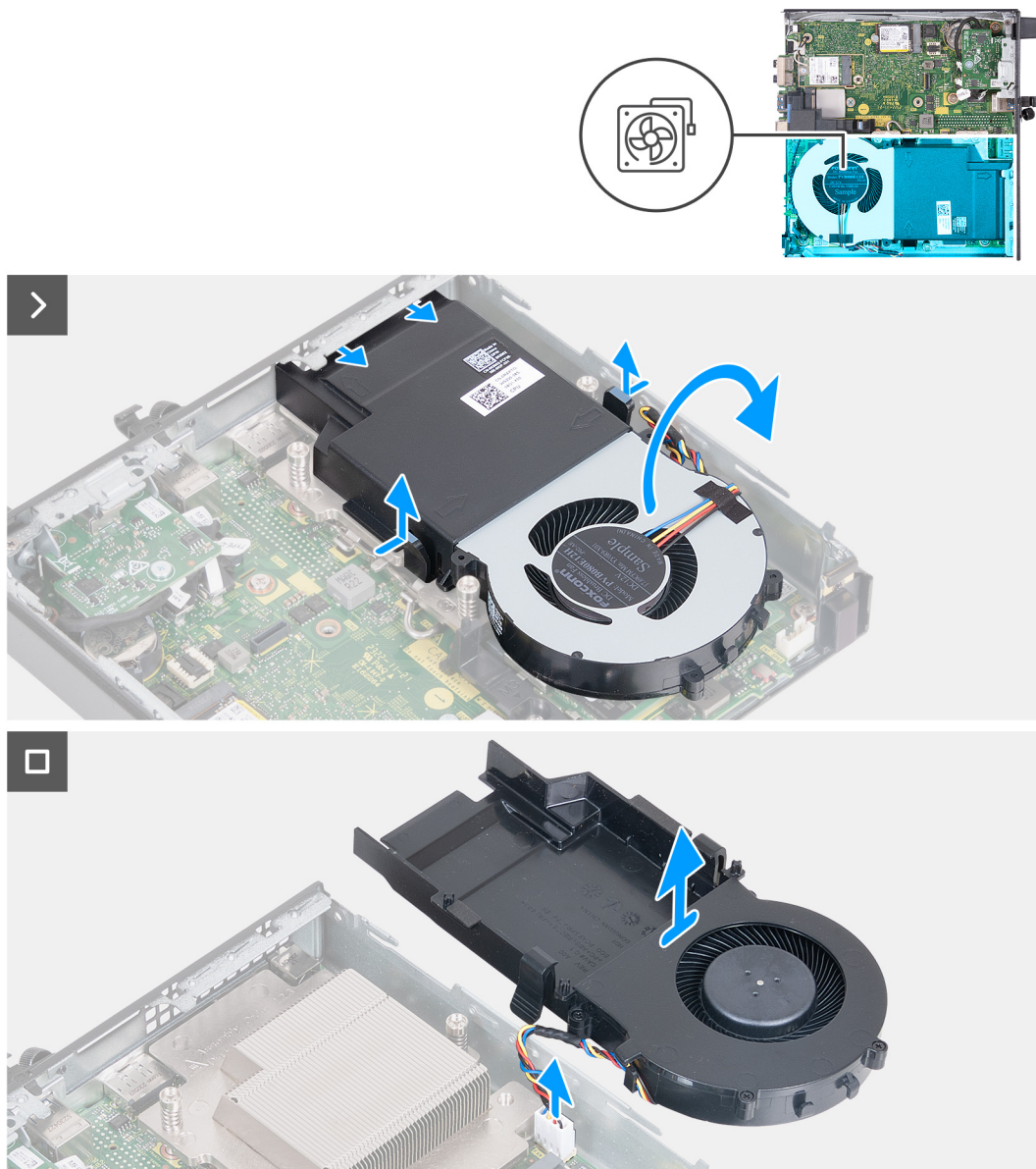

Figure 30. Removing the fan

Steps

1. Press and hold the tabs that secure the fan assembly to the heat sink.
2. Slide the fan assembly out from its slot on the computer chassis.

3. Flip over the fan assembly while holding it in place over the heat sink.
4. Disconnect the fan cable from its connector (FAN CPU) on the system board.
5. Lift the fan assembly away from the heat sink.

Installing the fan

Prerequisites

If you are replacing a component, remove the existing component before performing the installation process.

About this task

The following image(s) indicate the location of the fan and provides a visual representation of the installation procedure.

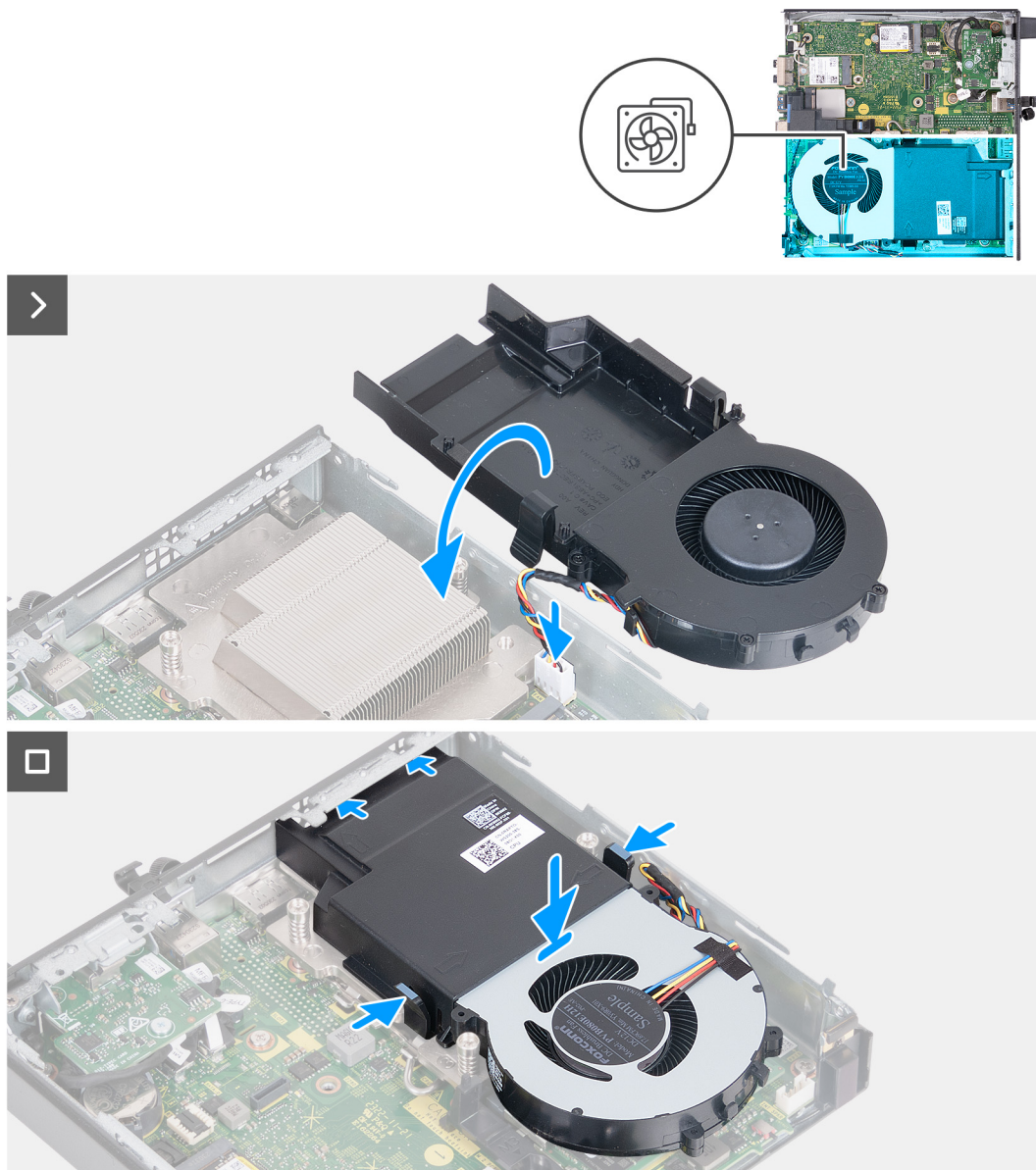

Figure 31. Installing the fan

Steps

1. Connect the fan cable to its connector (FAN CPU) on the system board.
2. Flip over the fan assembly and align it over the heat sink.
3. Press and hold the tabs on the fan assembly while placing the fan assembly on the heat sink.

- Slide the fan assembly into its slot on the computer chassis and release the tabs.

NOTE: Ensure that the tabs are snapped into position on the heat sink.

Next steps

- Install the [speaker](#).
- Install the [side cover](#).
- Follow the procedure in [After working inside your computer](#).

Memory

Removing the memory module

Prerequisites

- Follow the procedure in [Before working inside your computer](#).
- Remove the [side cover](#).
- Remove the [speaker](#).
- Remove the [fan](#).

About this task

The DDR5 thermal pad is required for the following memory configurations:

- 32 GB: 2 x 16 GB, DDR5, 5600 MT/s, SoDIMM, dual-channel
- 64 GB: 2 x 32 GB, DDR5, 5600 MT/s, SoDIMM, dual-channel

The following image(s) indicate the location of the memory and provides a visual representation of the removal procedure.

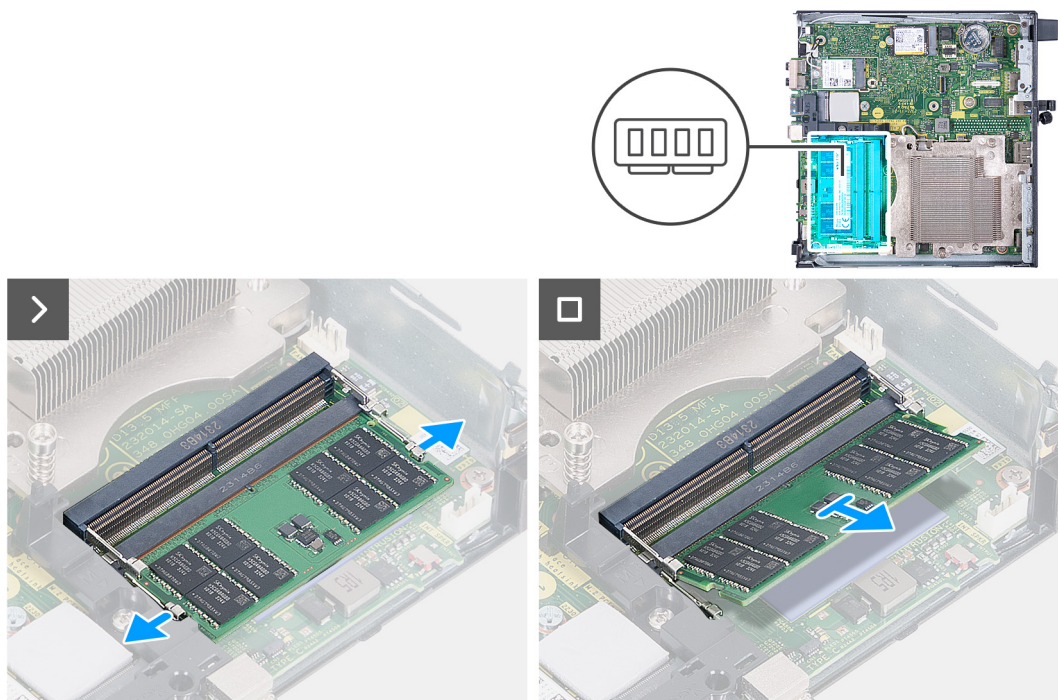

Figure 32. Removing the memory module

Steps

- Carefully spread apart the securing-clips on each end of the memory-module slot (DIMM1 or DIMM2).
- Grasp the memory module near the securing clip, and then gently ease the memory module out of the memory-module slot.

CAUTION: To prevent damage to the memory module, hold the memory module by the edges. Do not touch the components on the memory module.

NOTE: Repeat **step 1** to **step 2** to remove any other memory modules installed in your computer.

NOTE: Note the slot and the orientation of the memory module in order to replace it in the correct slot.

Installing the memory module

Prerequisites

If you are replacing a component, remove the existing component before performing the installation process.

About this task

The DDR5 thermal pad is required for the following memory configurations:

1. 32 GB: 2 x 16 GB, DDR5, 5600 MT/s, SoDIMM, dual-channel
2. 64 GB: 2 x 32 GB, DDR5, 5600 MT/s, SoDIMM, dual-channel

The following image(s) indicate the location of the memory and provides a visual representation of the installation procedure.

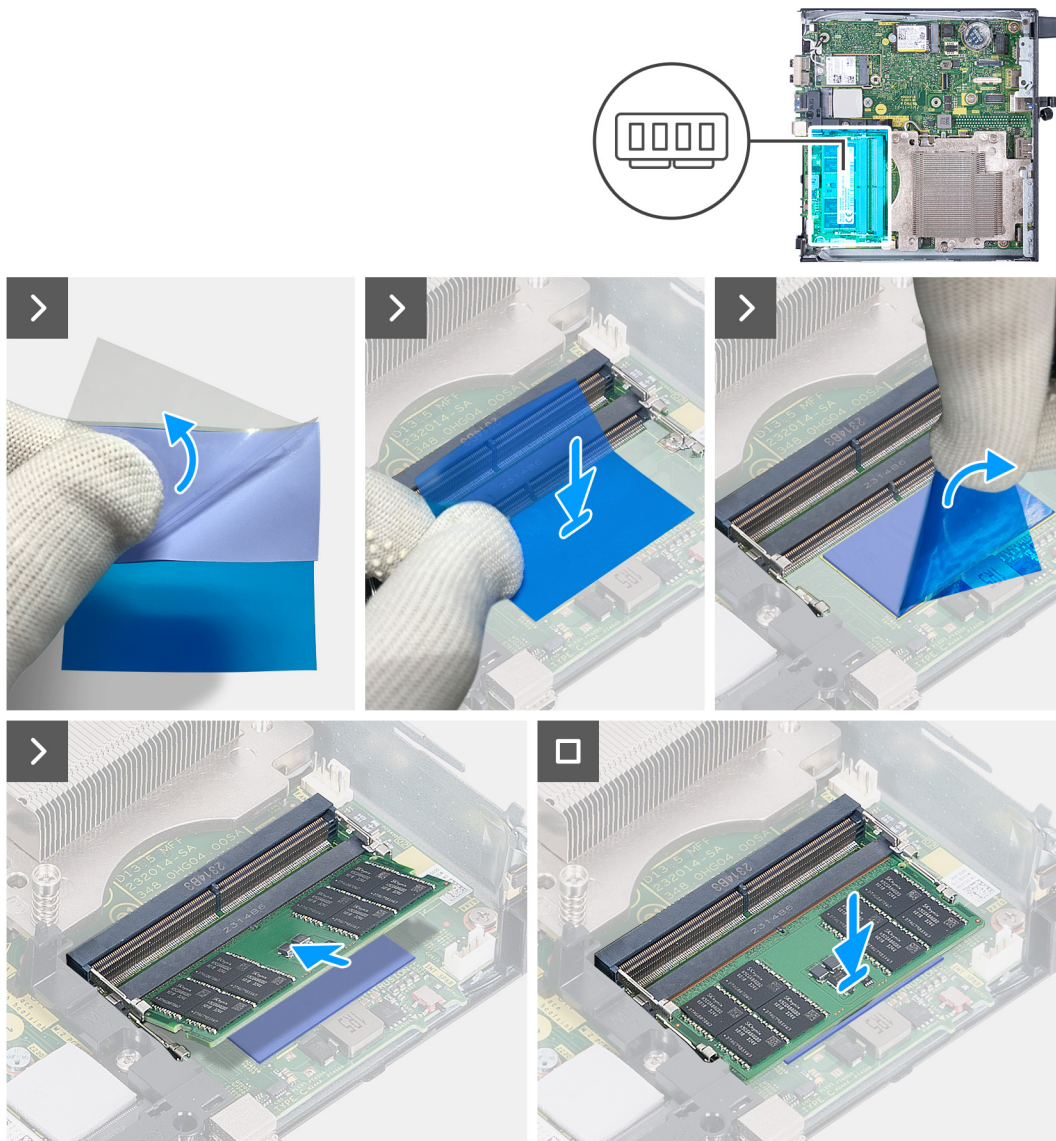





Figure 33. Installing the memory module

Steps

 **NOTE:** **Step 1** to **step 6** are applicable when installing the DDR5 thermal pad for the following memory configurations:

- 32 GB: 16 GB x 2
- 64 GB: 32 GB x 2

1. Peel back the backing of the DDR5 thermal pad halfway.
2. Position the DDR5 thermal pad over the DDR5 thermal pad area.
3. Align the DDR5 thermal pad over the DDR5 thermal pad area.
 **NOTE:** Ensure the corners of the DDR5 thermal pad are aligned to the corners of the DDR5 thermal pad area.
4. Peel the rest of the backing off the DDR5 thermal pad and paste the DDR5 thermal pad onto the DDR5 thermal pad area.
5. Flatten the DDR5 thermal pad with a plastic scrapper to ensure proper adhesion.
6. Peel off the protective layer from the DDR5 thermal pad.
7. Align the notch on the memory module with the tab on the memory-module slot (DIMM1 or DIMM2).
8. Press down on the memory module until the memory module snaps into position and the securing clips lock in place.

 **CAUTION:** To prevent damage to the memory module, hold the memory module by the edges. Do not touch the components on the memory module.

 **NOTE:** Repeat **step 7** to **step 8** when installing more than one memory module in your computer.

Next steps

1. Install the [fan](#).
2. Install the [speaker](#).
3. Install the [side cover](#).
4. Follow the procedure in [After working inside your computer](#).

Removing and installing Field Replaceable Units (FRUs)

The replaceable components in this chapter are Field Replaceable Units (FRUs).

CAUTION: The information in this removing and installing FRU's section is intended for authorized service technicians only.

CAUTION: To avoid any potential damage to the component or loss of data, ensure that an authorized service technician replaces the Field Replaceable Units (FRUs).

CAUTION: Dell Technologies recommends that this set of repairs, if needed, to be conducted by trained technical repair specialists.

CAUTION: As a reminder, your warranty does not cover damages that may occur during FRU repairs that are not authorized by Dell Technologies.

NOTE: The images in this document may differ from your computer depending on the configuration you ordered.

Optional I/O module (HDMI/VGA/DP/Serial/PS2)

Removing the optional I/O module (HDMI/VGA/DP/Serial/PS2)

CAUTION: The information in this section is intended for authorized service technicians only.

Prerequisites

1. Follow the procedure in [Before working inside your computer](#).
2. Remove the [side cover](#).

About this task

NOTE: The optional PS2 module comes with a custom Dell adapter cable that is required to access the PS2 I/O port. Plug in the adapter cable to access the PS2 I/O or COM port of your computer.

The following images indicate the location of the optional I/O module and provide a visual representation of the removal procedure.

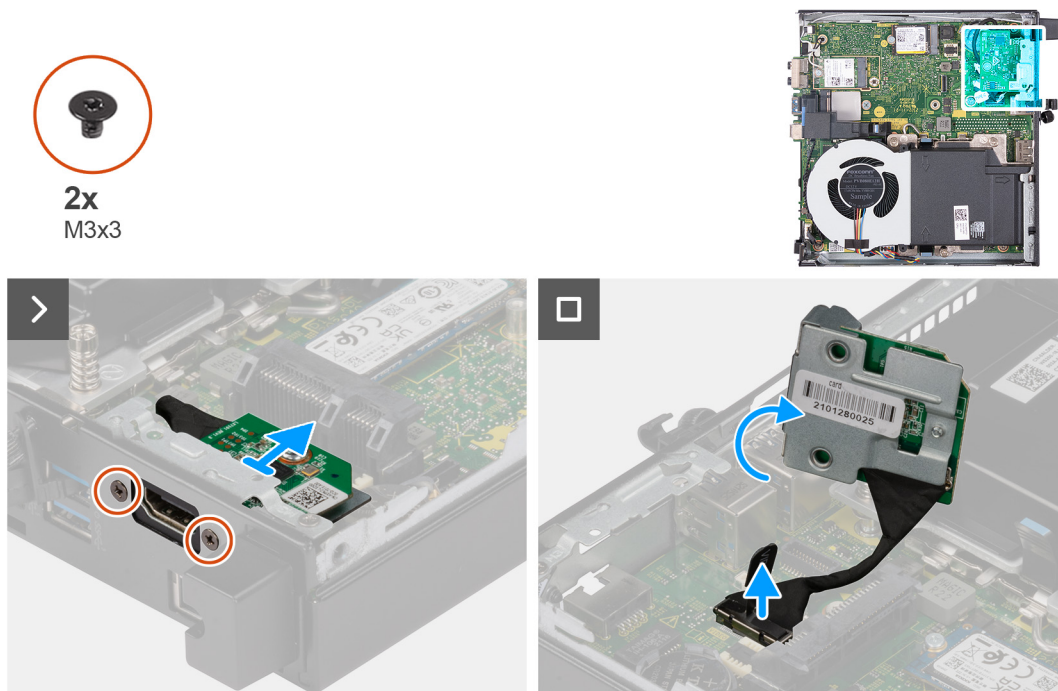

Figure 34. Removing the optional I/O module (HDMI, DP, or PS2)

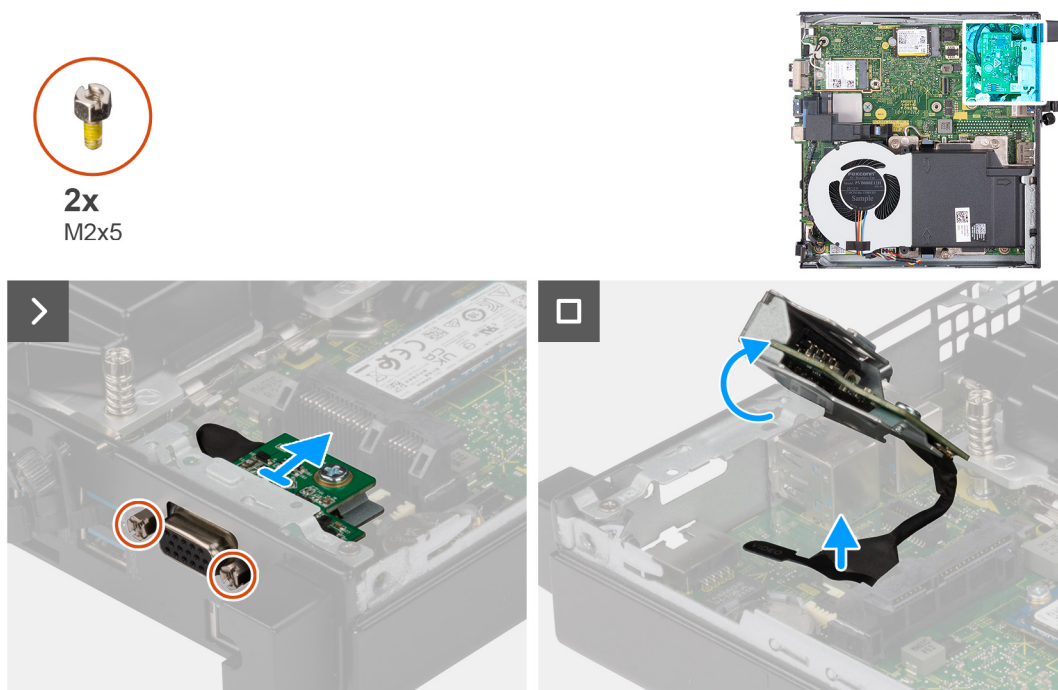

Figure 35. Removing the optional I/O module (VGA or Serial)

Steps

1. Remove the two (M3x3) screws that secure the optional I/O module (HDMI/DP/PS2) or two (M2x5) cross-type screws that secure the optional I/O module (VGA/Serial) to the computer chassis.
2. Disconnect the I/O-module cable from the connector (VIDEO) or (KB MS SERIAL) on the system board, whichever is applicable.
3. Remove the optional I/O module from the computer.

Installing the optional I/O module (HDMI/VGA/DP/Serial/PS2)

CAUTION: The information in this section is intended for authorized service technicians only.

Prerequisites

If you are replacing a component, remove the existing component before performing the installation procedure.

About this task

NOTE: The optional PS2 module comes with a custom Dell adapter cable that is required to access the PS2 I/O port. Plug in the adapter cable to access the PS2 I/O or COM port of your computer.

The following images indicate the location of the optional I/O module and provide a visual representation of the installation procedure.

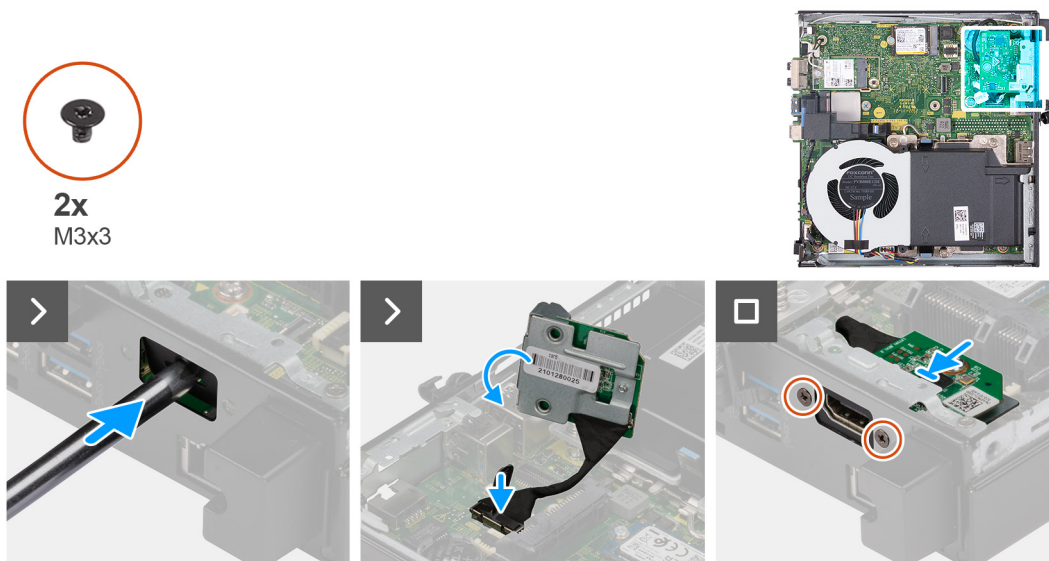

Figure 36. Installing optional I/O module (HDMI, DP, or PS2)

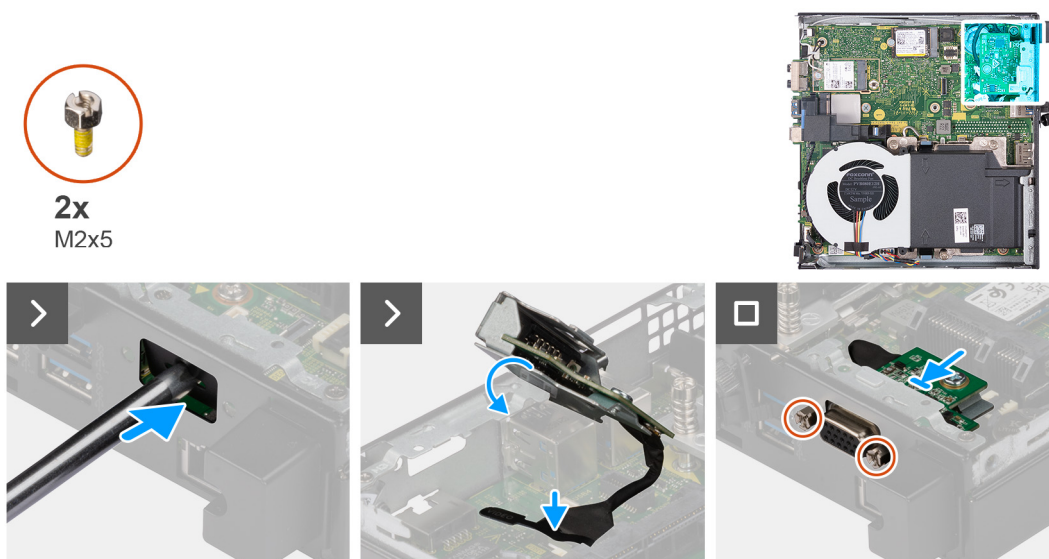

Figure 37. Installing optional I/O module (VGA or Serial)

Steps

1. To remove the knock-out port cover, insert a flat-head screwdriver in the hole of the port cover from the outside of the computer. Push the knock-out port cover to release it, and then remove it out from the computer.

i **NOTE:** This step applies if you are upgrading a computer with no existing I/O module.

2. Insert the optional I/O module into its slot at the back panel of the computer.
3. Connect the I/O cable to the connector (VIDEO) or (KB MS SERIAL) on the system board, whichever is applicable.
4. Replace the two (M3x3) screws that secure the optional I/O module (HDMI/DP/PS2) or two (M2x5) cross-type screws that secure the optional I/O module (VGA/Serial) to the computer chassis.

Next steps

1. Install the [side cover](#).
2. Follow the procedure in [After working inside your computer](#).

Optional Type-C module

Removing the optional Type-C module

⚠ CAUTION: The information in this section is intended for authorized service technicians only.

Prerequisites

1. Follow the procedure in [Before working inside your computer](#).
2. Remove the [side cover](#).

About this task

The following images indicate the location of the optional Type-C module and provide a visual representation of the removal procedure.

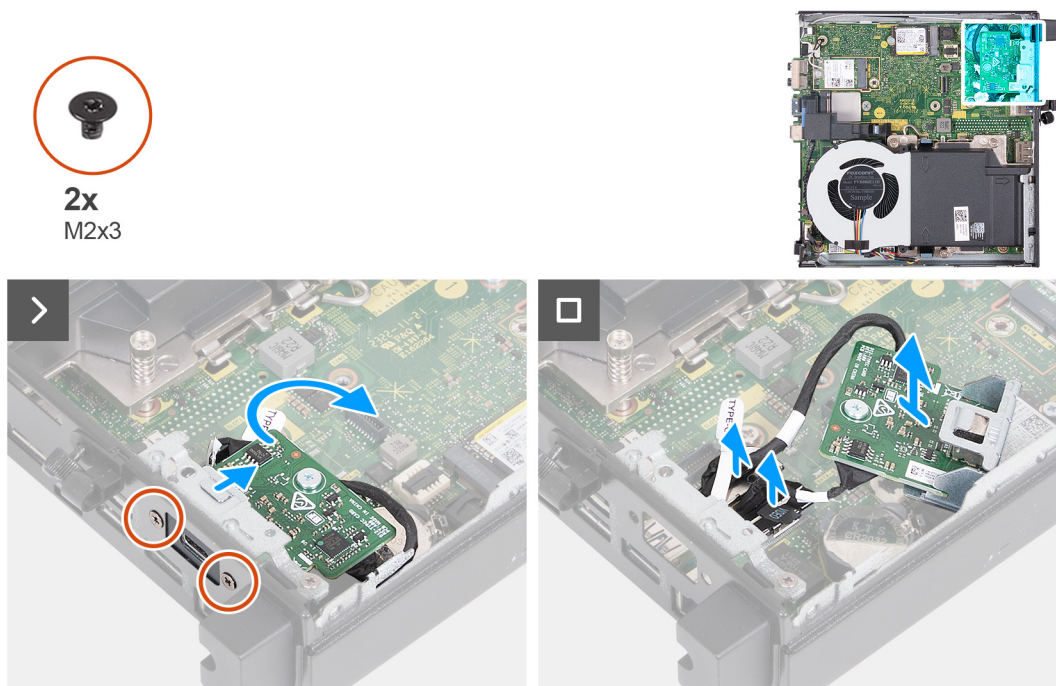

Figure 38. Removing the optional Type-C module

Steps

1. Remove the two (M2x3) screws that secure the optional Type-C module.
2. Slide the optional Type-C module away from its slot on the chassis.
3. Flip over the optional Type-C module and hold it in place over the system board.
4. Disconnect the Type-C DisplayPort cable from its connector (VIDEO) on the system board.
5. Disconnect the Type-C USB cable from its connector (TYPE-C) on the system board.
6. Remove the optional Type-C module from the computer.

Installing the optional Type-C module

CAUTION: The information in this section is intended for authorized service technicians only.

Prerequisites

If you are replacing a component, remove the existing component before performing the installation procedure.

About this task

The following images indicate the location of the optional Type-C module and provide a visual representation of the installation procedure.

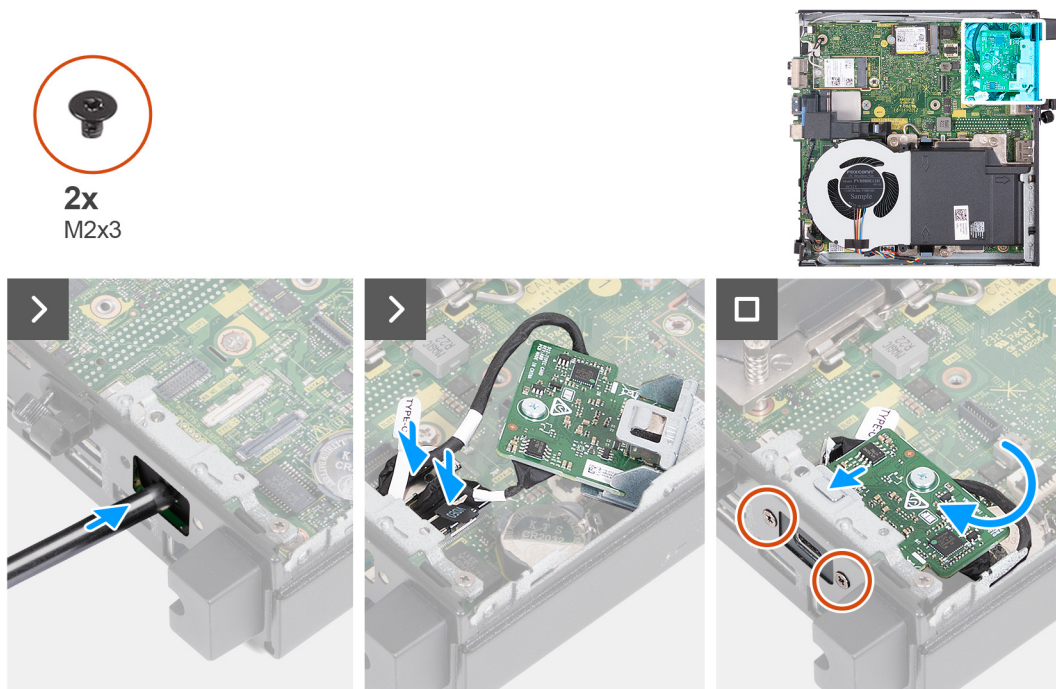

Figure 39. Installing the optional Type-C module

Steps

1. To remove the knock-out port cover, insert a flat-head screwdriver in the hole of the bracket from the outside of the computer. Push the bracket to release it, and then remove it out from the computer.

NOTE: This step applies if you are upgrading the computer with no existing I/O module.

2. Connect the Type-C DisplayPort cable to its connector (VIDEO) on the system board.
3. Connect the Type-C USB cable to its connector (TYPE-C) on the system board.
4. Insert the optional Type-C module into its slot on the back panel of the computer.
5. Replace the two (M3x3) screws that secure the optional Type-C module.

Next steps

1. Install the [side cover](#).
2. Follow the procedure in [After working inside your computer](#).

Heat sink

Removing the heat sink

CAUTION: The information in this section is intended for authorized service technicians only.

Prerequisites

1. Follow the procedure in [Before working inside your computer](#).
2. Remove the [side cover](#).
3. Remove the [speaker](#).
4. Remove the [fan](#).

About this task

- NOTE:** The heat sink may become hot during normal operation. Allow sufficient time for the heat sink to cool before you touch it.
- NOTE:** For maximum cooling of the processor, do not touch the heat transfer areas on the heat sink. The oils in your skin can reduce the heat transfer capability of the thermal paste.

The following image(s) indicate the location of the heat sink and provides a visual representation of the removal procedure.

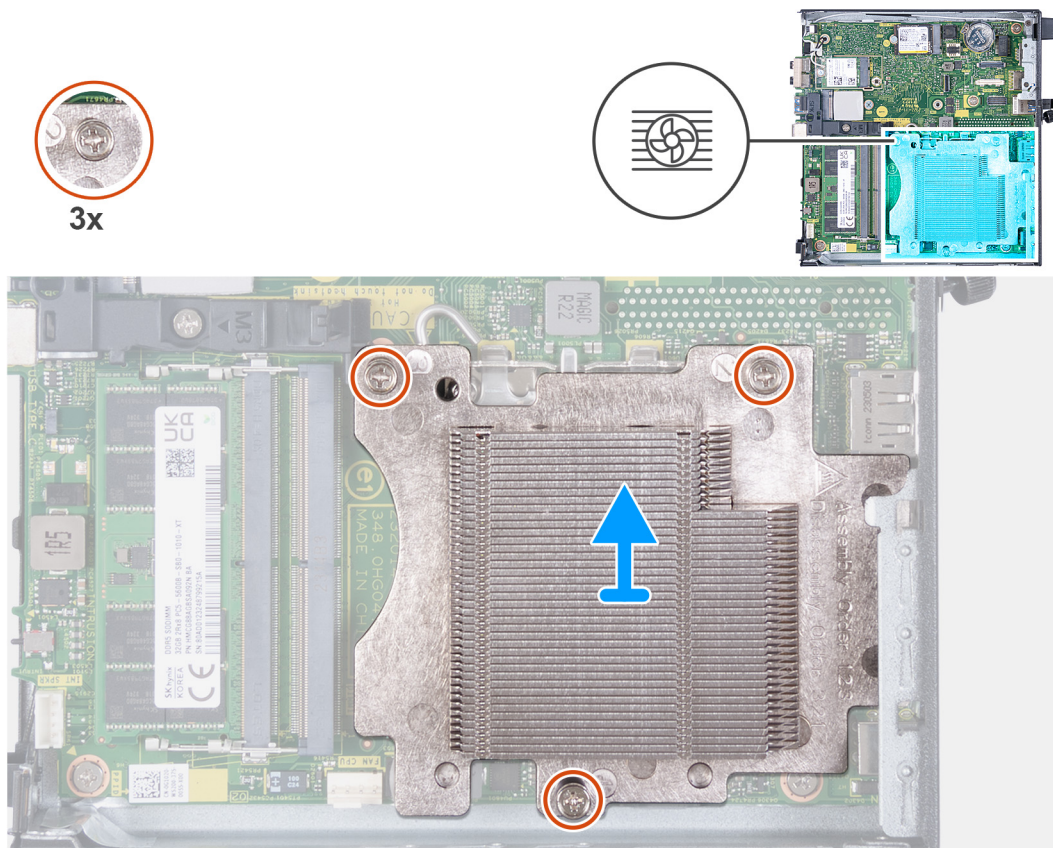

Figure 40. Removing the heat sink

Steps

1. In reverse sequential order (3->2->1), loosen the three captive screws that secure the heat sink to the system board.
2. Lift the heat sink off the system board.

Installing the heat sink

 **CAUTION:** The information in this section is intended for authorized service technicians only.

Prerequisites

If you are replacing a component, remove the existing component before performing the installation process.

About this task

 **NOTE:** If either the processor or the heat sink is replaced, use the thermal paste that is provided in the kit to ensure that thermal conductivity is achieved.

The following image(s) indicate the location of the heat sink and provides a visual representation of the installation procedure.

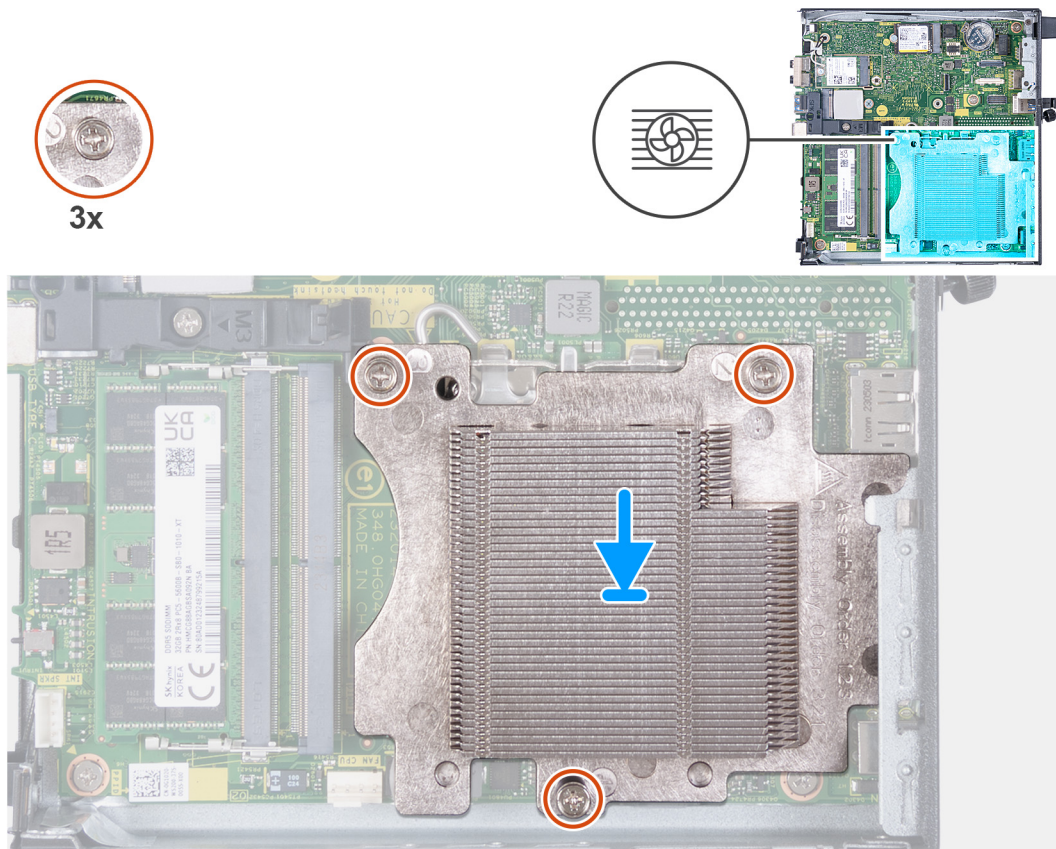

Figure 41. Installing the heat sink

Steps

1. Place the heat sink on the system board.
2. Align the screw holes on the heat sink with the screw holes on the system board.
3. In sequential order (1->2->3), tighten the three captive screws that secure the heat sink to the system board.

Next steps

1. Install the [fan](#).
2. Install the [speaker](#).
3. Install the [side cover](#).

4. Follow the procedure in [After working inside your computer](#).

Processor

Removing the processor

CAUTION: The information in this section is intended for authorized service technicians only.

Prerequisites

1. Follow the procedure in [Before working inside your computer](#).
2. Remove the [side cover](#).
3. Remove the [speaker](#).
4. Remove the [fan](#).
5. Remove the [heat sink](#).

About this task

- NOTE:** The heat sink may become hot during normal operation. Allow sufficient time for the heat sink to cool before you touch it.
- NOTE:** For maximum cooling of the processor, do not touch the heat transfer areas on the heat sink. The oils in your skin can reduce the heat transfer capability of the thermal grease.

The following image(s) indicate the location of the processor and provides a visual representation of the removal procedure.

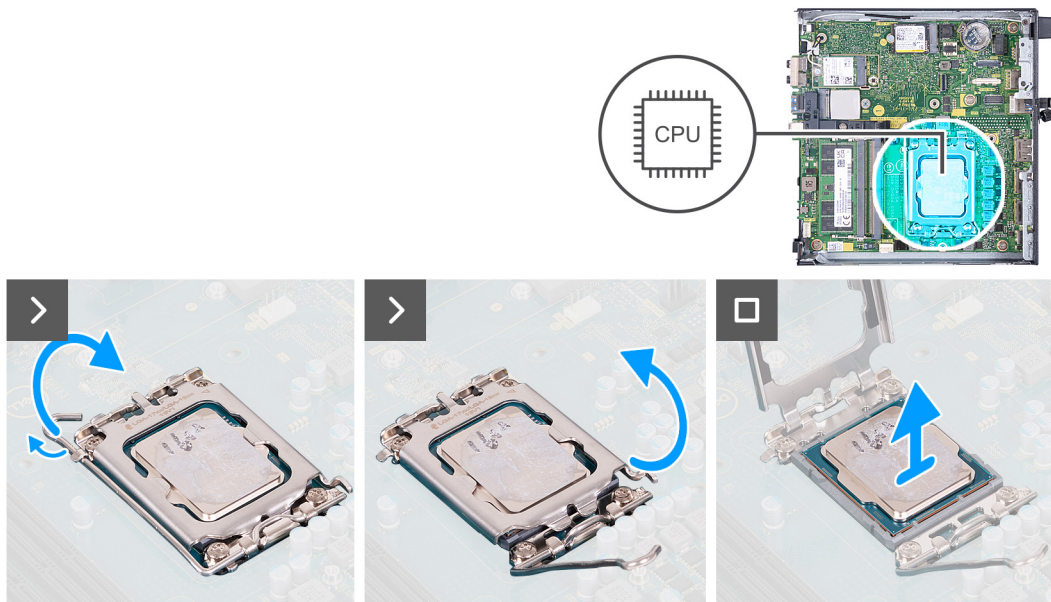

Figure 42. Removing the processor

Steps

1. Press the release lever down and then push it away from the processor to release it from the securing tab.
2. Extend the release lever all the way to ensure the processor cover is open completely.

CAUTION: When removing the processor, do not touch any of the pins inside the socket or allow any objects to fall on the pins in the socket.

3. Gently lift the processor from the processor socket.

Installing the processor

CAUTION: The information in this section is intended for authorized service technicians only.

Prerequisites

If you are replacing a component, remove the existing component before performing the installation process.

About this task

NOTE: If either the processor or the heat sink is replaced, use the thermal grease that is provided in the kit to ensure that thermal conductivity is achieved.

The following image(s) indicate the location of the processor and provides a visual representation of the installation procedure.

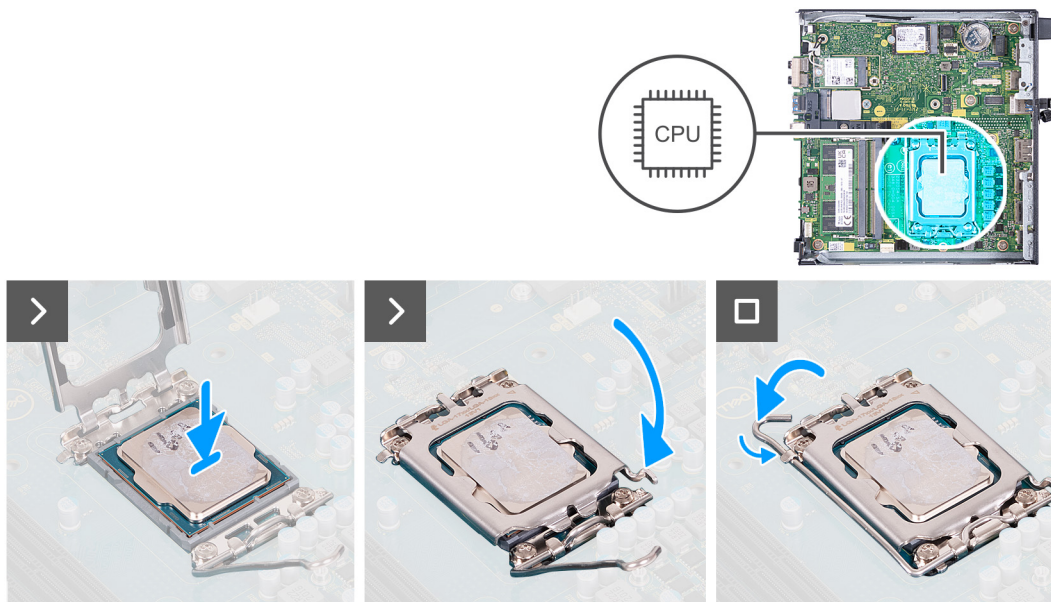

Figure 43. Installing the processor

Steps

1. Ensure that the release lever on the processor socket is fully extended in the open position.

NOTE: The pin-1 corner of the processor has a triangle that aligns with the triangle on the pin-1 corner on the processor socket. When the processor is properly seated, all four corners are aligned at the same height. If one or more corners of the processor are higher than the others, the processor is not seated properly.

2. Align the notches on the processor with the tabs on the processor socket and place the processor in the processor socket.

CAUTION: Ensure that the processor-cover notch is positioned underneath the alignment post.

3. When the processor is fully seated in the socket, push the release-lever down and place it under the tab on the processor cover.

Next steps

1. Install the [heat sink](#).
2. Install the [fan](#).
3. Install the [speaker](#).
4. Install the [side cover](#).
5. Follow the procedure in [After working inside your computer](#).

System board

Removing the system board

CAUTION: The information in this section is intended for authorized service technicians only.

Prerequisites

1. Follow the procedure in [Before working inside your computer](#).
2. Remove the [side cover](#).
3. Remove the [coin-cell battery](#).
4. Remove the [speaker](#).
5. Remove the [M.2 2230 solid-state drive](#) or [M.2 2280 solid-state drive](#), whichever is applicable.
6. Remove the [wireless card](#).
7. Remove the [fan](#).
8. Remove the [memory](#).
9. Remove the [heat sink](#).
10. Remove the [processor](#).
11. Remove the [optional I/O module \(HDMI/VGA/DP/Serial/PS2\)](#) or the [optional Type-C module](#), whichever is applicable.

About this task

The following images indicate the system board connectors.

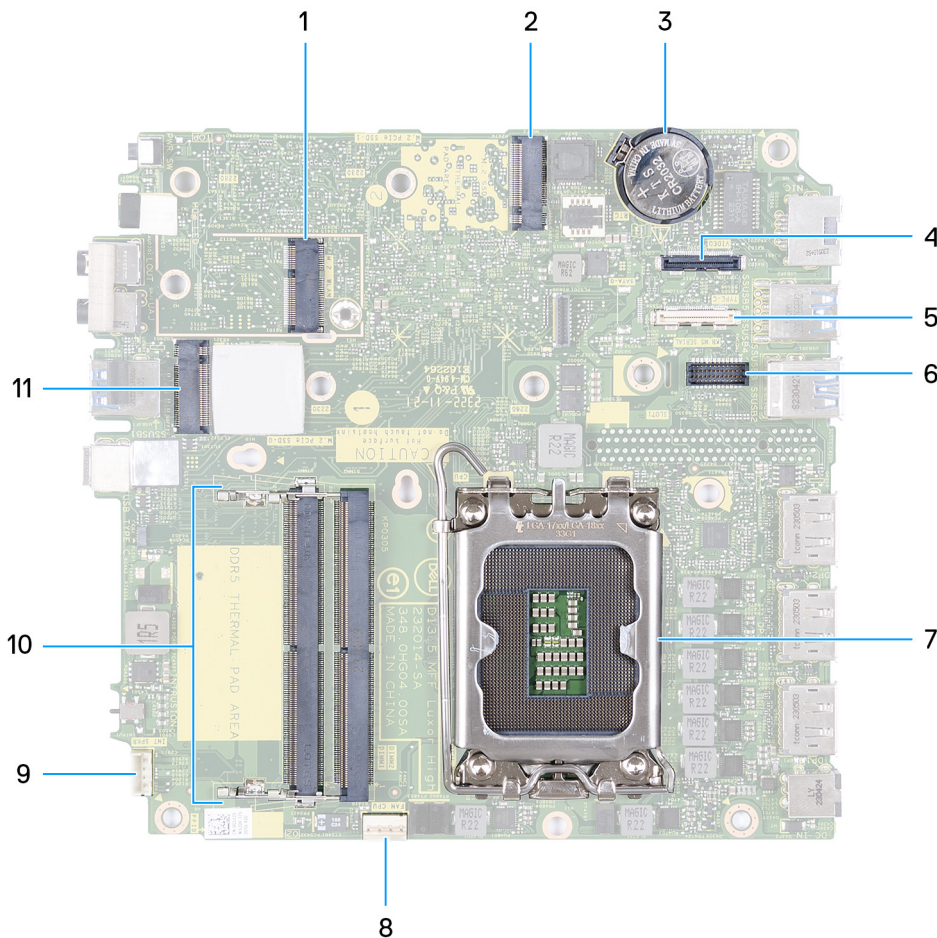

Figure 44. System board connectors

1. M.2 WLAN connector (M.2 WLAN)
2. M.2 SSD PCIe connector (M.2 2230 or M.2 2280) (M.2 PCIe SSD-1)
3. Coin-cell battery
4. Optional video connector (VGA Port/DisplayPort 1.4a (HBR3)/HDMI 2.1 Port) (VIDEO)
5. Optional connector (USB 3.2 Gen 2 Type-C Port) (TYPE-C)
6. Optional PS/2, serial port connector (KB MS SERIAL)
7. Processor socket (CPU)
8. Fan connector (FAN CPU)
9. Internal speaker connector (INT SPKR)
10. Memory-module slots (DIMM1 and DIMM2)
11. M.2 SSD PCIe connector (M.2 2230 or M.2 2280) (M.2 PCIe SSD-0)

The following image(s) indicate the location of the system board and provides a visual representation of the removal procedure.

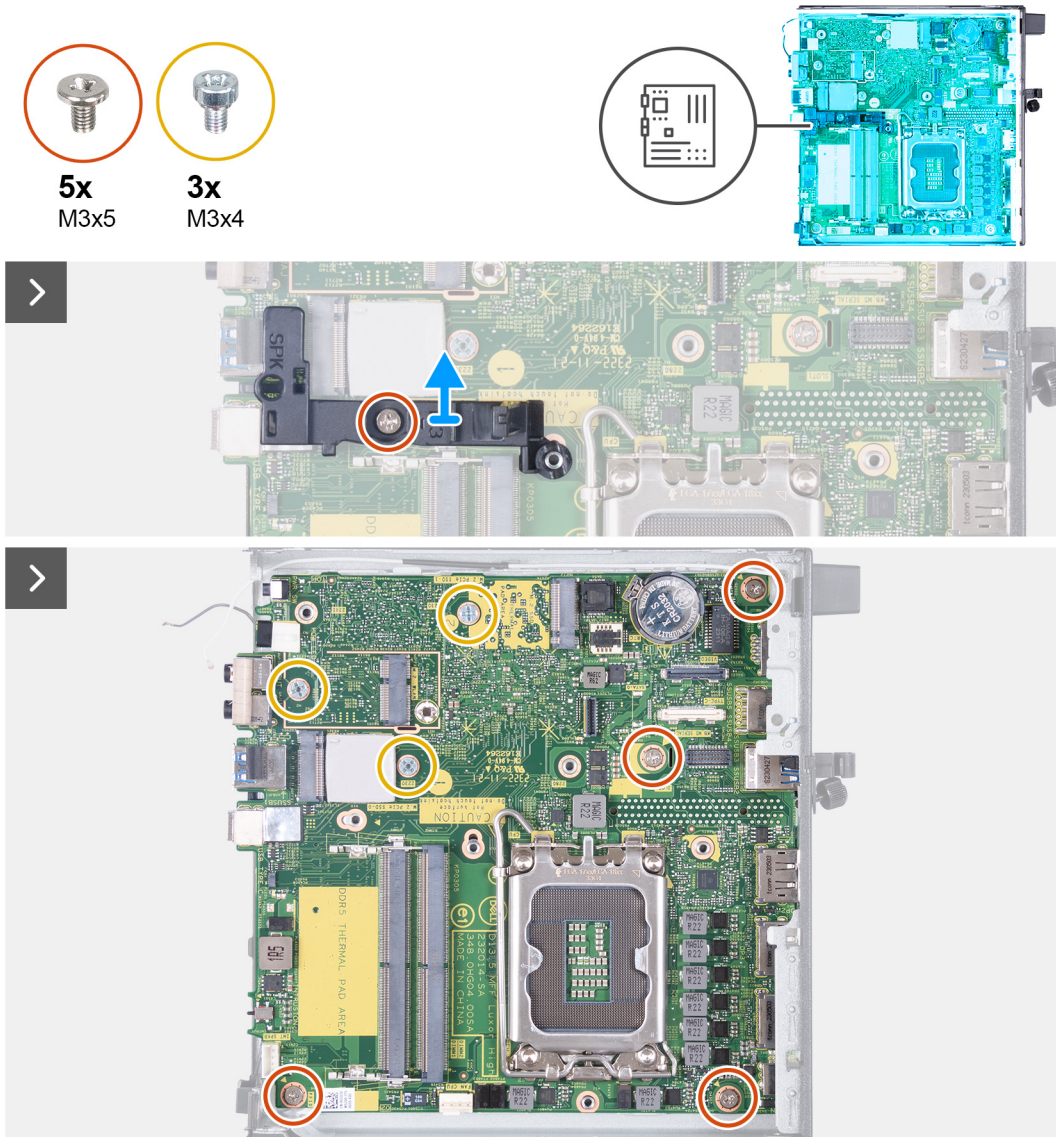

Figure 45. Removing the system board

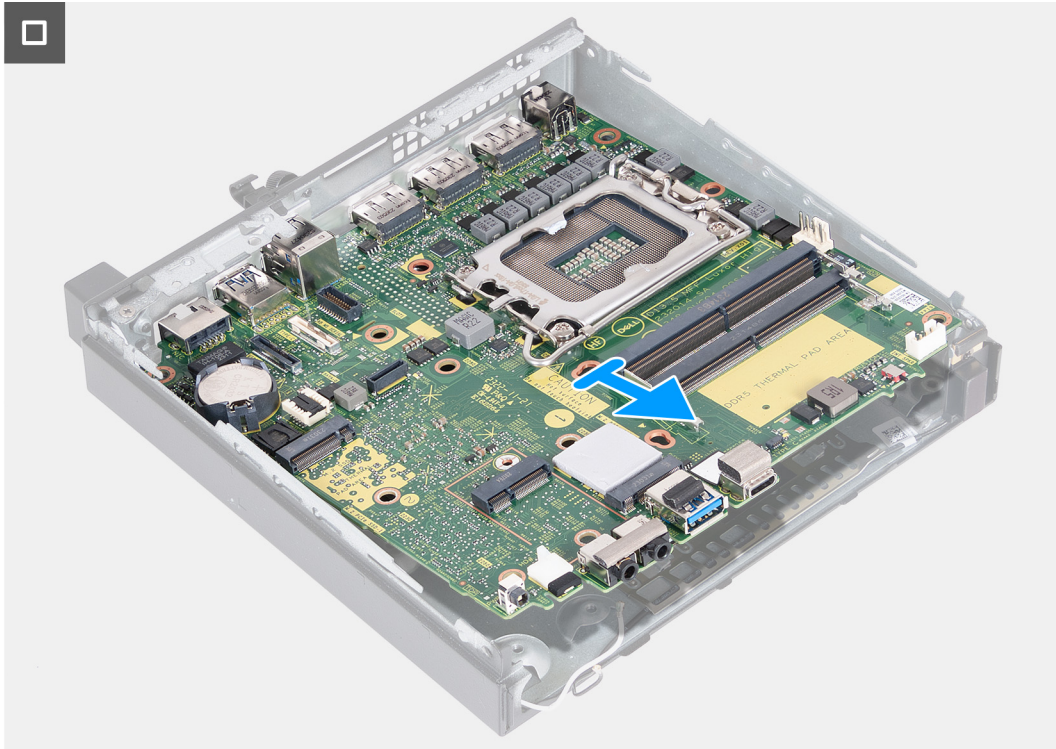

Figure 46. Removing the system board

Steps

1. Remove the screw (M3x5) that secures the speaker-support bracket to the system board.
2. Lift the speaker-support bracket off the system board.
3. Remove the four screws (M3x5) that secure the system board to the chassis.
4. Remove the three screws (M3x4) that secure the system board to the chassis.
5. Lift the system board at an angle and remove it from the chassis.

Installing the system board

CAUTION: The information in this section is intended for authorized service technicians only.

Prerequisites

If you are replacing a component, remove the existing component before performing the installation process.

About this task

The following images indicate the system board connectors.

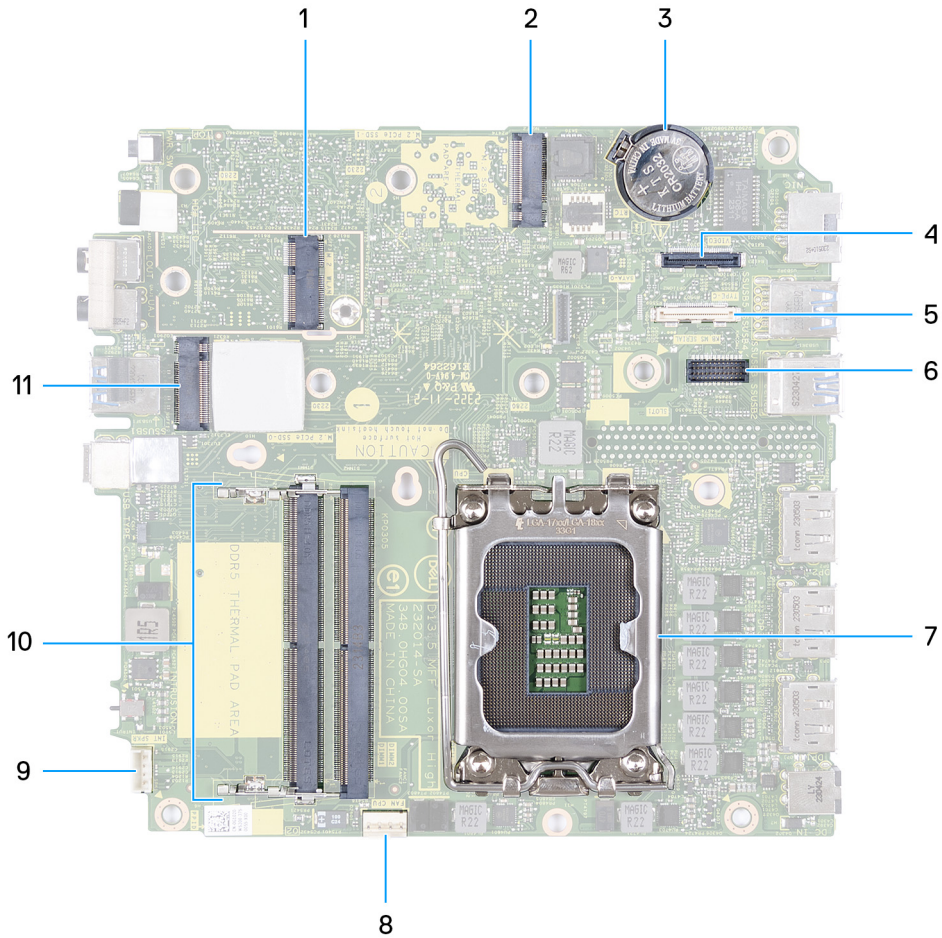

Figure 47. System board connectors

1. M.2 WLAN connector (M.2 WLAN)
2. M.2 SSD PCIe connector (M.2 2230 or M.2 2280) (M.2 PCIe SSD-1)
3. Coin-cell battery
4. Optional video connector (VGA Port/DisplayPort 1.4a (HBR3)/HDMI 2.1 Port) (VIDEO)
5. Optional connector (USB 3.2 Gen 2 Type-C Port) (TYPE-C)
6. Optional PS/2, serial port connector (KB MS SERIAL)
7. Processor socket (CPU)
8. Fan connector (FAN CPU)
9. Internal speaker connector (INT SPKR)
10. Memory-module slots (DIMM1 and DIMM2)
11. M.2 SSD PCIe connector (M.2 2230 or M.2 2280) (M.2 PCIe SSD-0)

The following image(s) indicate the location of the system board and provides a visual representation of the installation procedure.

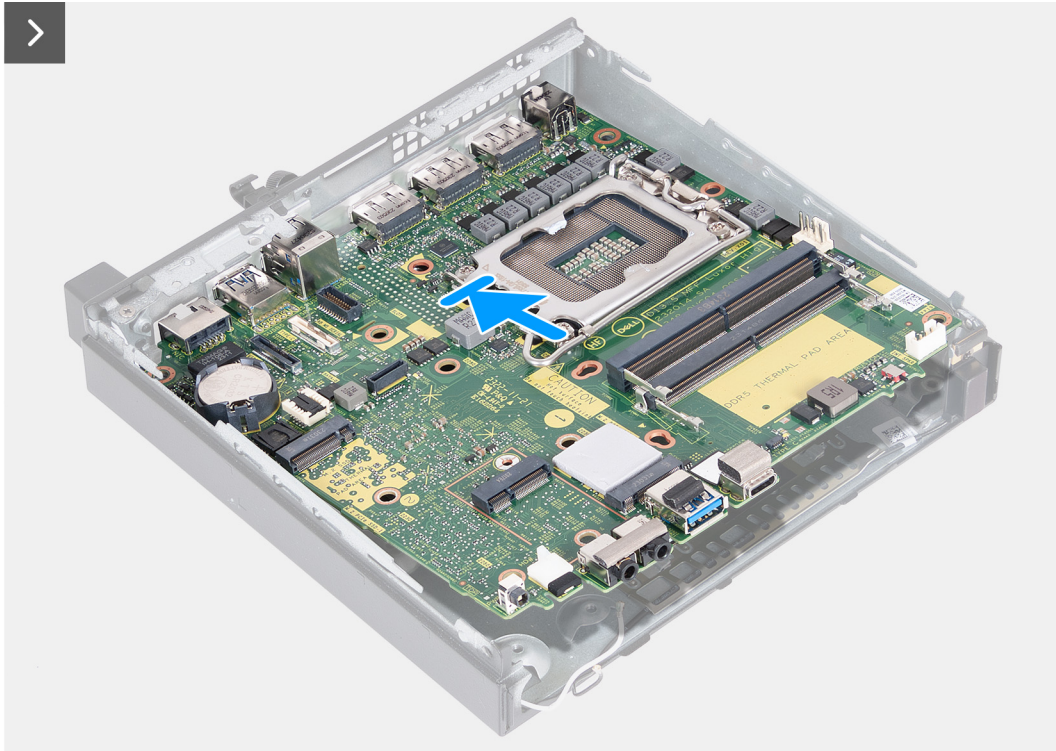

Figure 48. Installing the system board

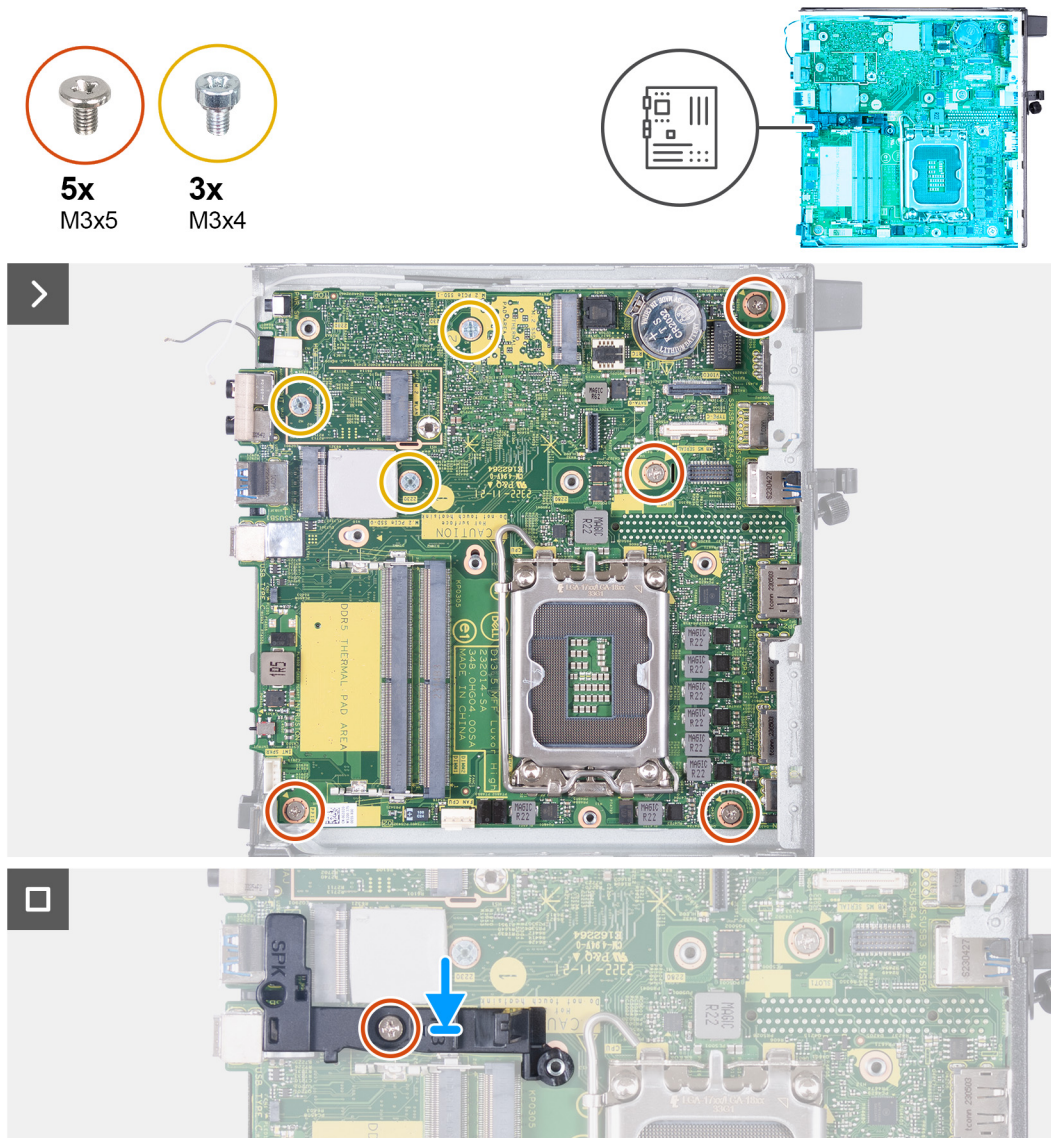

Figure 49. Installing the system board

Steps

1. At an angle, insert the front of the system board through the chassis.
2. Place the system board on the chassis.
3. Align the screw holes on the system board with the screw holes on the chassis.
4. Replace the four screws (M3x5) that secure the system board to the chassis.
5. Replace the three screws (M3x4) that secure the system board to the chassis.
6. Place the speaker-support bracket on the system board.
7. Align the screw hole on the speaker-support bracket with the screw hole on the system board.
8. Replace the screw (M3x5) that secures the speaker-support bracket to the system board.

Next steps

1. Install the [optional I/O module \(HDMI/VGA/DP/Serial/PS2\)](#) or the [optional Type-C module](#), whichever is applicable.
2. Install the [processor](#).
3. Install the [heat sink](#).
4. Install the [memory](#).
5. Install the [fan](#).
6. Install the [wireless card](#).

7. Install the [speaker](#).
8. Install the [M.2 2230 solid-state drive](#) or [M.2 2280 solid-state drive](#), whichever is applicable.
9. Install the [coin-cell battery](#).
10. Install the [side cover](#).
11. Follow the procedure in [After working inside your computer](#).

Internal antenna

Removing the antenna module (white cable)

 **CAUTION:** The information in this section is intended for authorized service technicians only.

Prerequisites

1. Follow the procedure in [Before working inside your computer](#).
2. Remove the [side cover](#).

About this task

The following image(s) indicate the location of the antenna module (white cable) and provides a visual representation of the removal procedure.

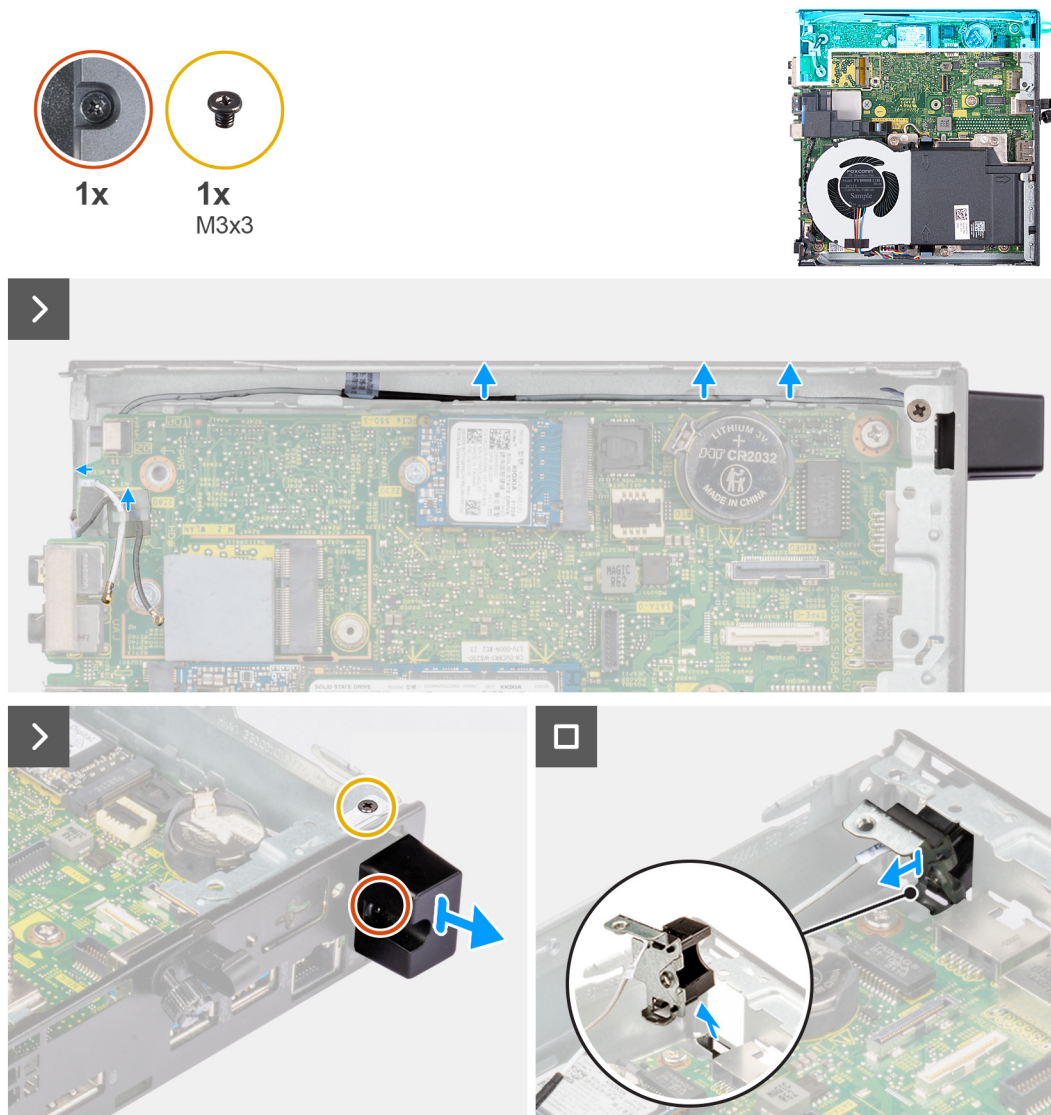

Figure 50. Removing the antenna module (white cable)

Steps

1. Remove the antenna cable from the routing guides on the chassis and system board.
2. Remove the screw (M3x3) that secures the antenna module (white cable) to the chassis.
3. Listen the captive screw that secures the antenna module (white cable) to the chassis.
4. Push the antenna module (white cable) through its slot on the back panel of the chassis.
5. Lift the antenna module (white cable) away from the back panel.

Installing the antenna module (white cable)

CAUTION: The information in this section is intended for authorized service technicians only.

Prerequisites

If you are replacing a component, remove the existing component before performing the installation process.

About this task

The following image(s) indicate the location of the antenna module (white cable) and provides a visual representation of the installation procedure.

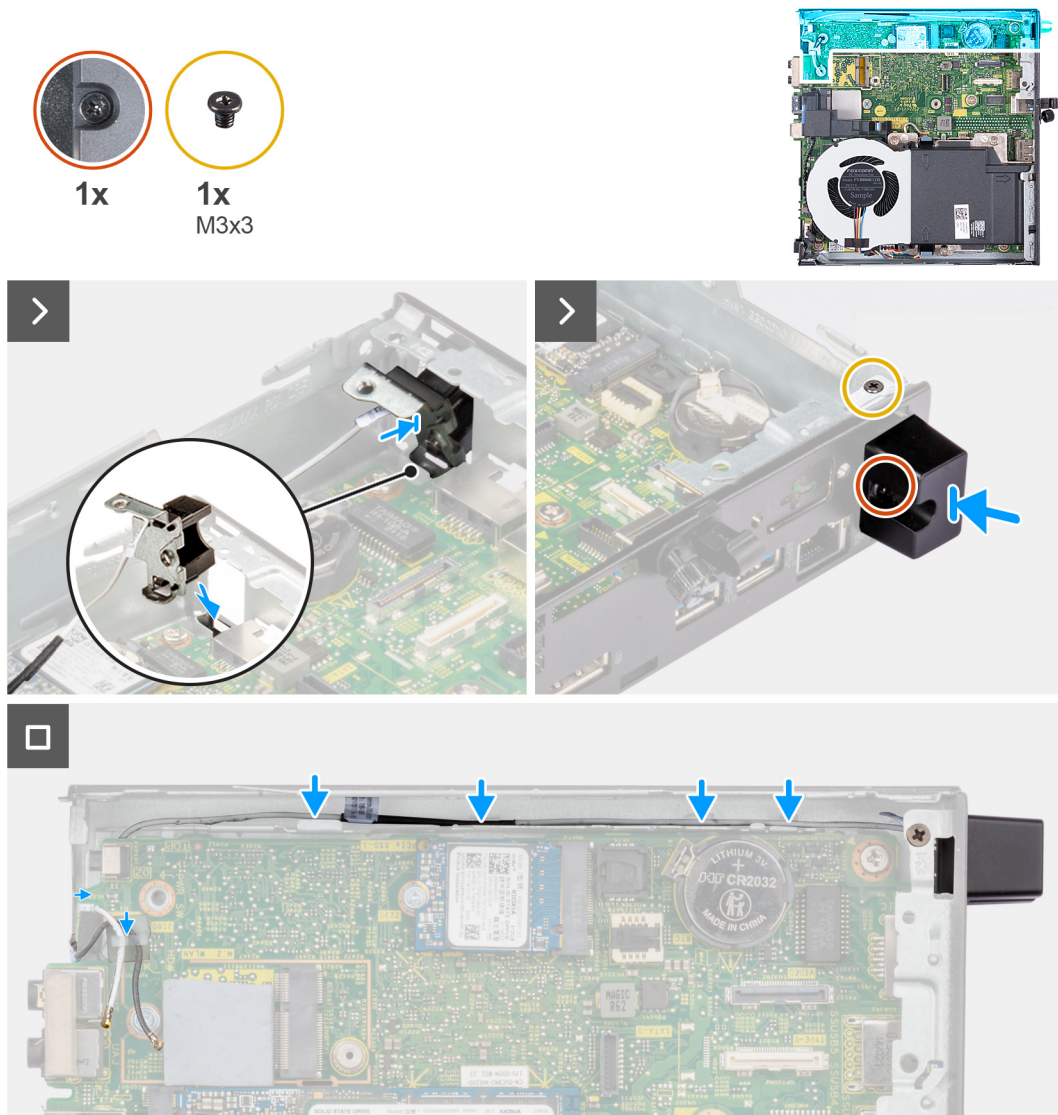

Figure 51. Installing the antenna module (white cable)

Steps

1. Push the antenna module (white cable) through the slot in the chassis.
2. Align the screw hole and captive screw on the antenna module (white cable) to the screw holes on the chassis.
3. Tighten the captive screw that secures the antenna module (white cable) to the back panel of the chassis.
4. Replace the screw (M3x3) that secures the antenna module (white cable) to the chassis.
5. Route the antenna cable through the routing guides on the chassis and system board.

Next steps

1. Install the [side cover](#).
2. Follow the procedure in [After working inside your computer](#).

Removing the antenna module (black cable)

CAUTION: The information in this section is intended for authorized service technicians only.

Prerequisites

1. Follow the procedure in [Before working inside your computer](#).

2. Remove the [side cover](#).
3. Remove the [M.2 2230 solid-state drive](#) or [M.2 2280 solid-state drive](#), whichever is applicable.
4. Remove the [wireless card](#).
5. Remove the [speaker](#).
6. Remove the [fan](#).
7. Remove the [heat sink](#).
8. Remove the [optional I/O module \(HDMI/VGA/DP/Serial/PS2\)](#) or the [optional Type-C module](#), whichever is applicable.
9. Remove the [system board](#).

NOTE: The system board can be removed with the memory, coin-cell battery, and processor attached.

About this task

The following image(s) indicate the location of the antenna module (black cable) and provides a visual representation of the removal procedure.

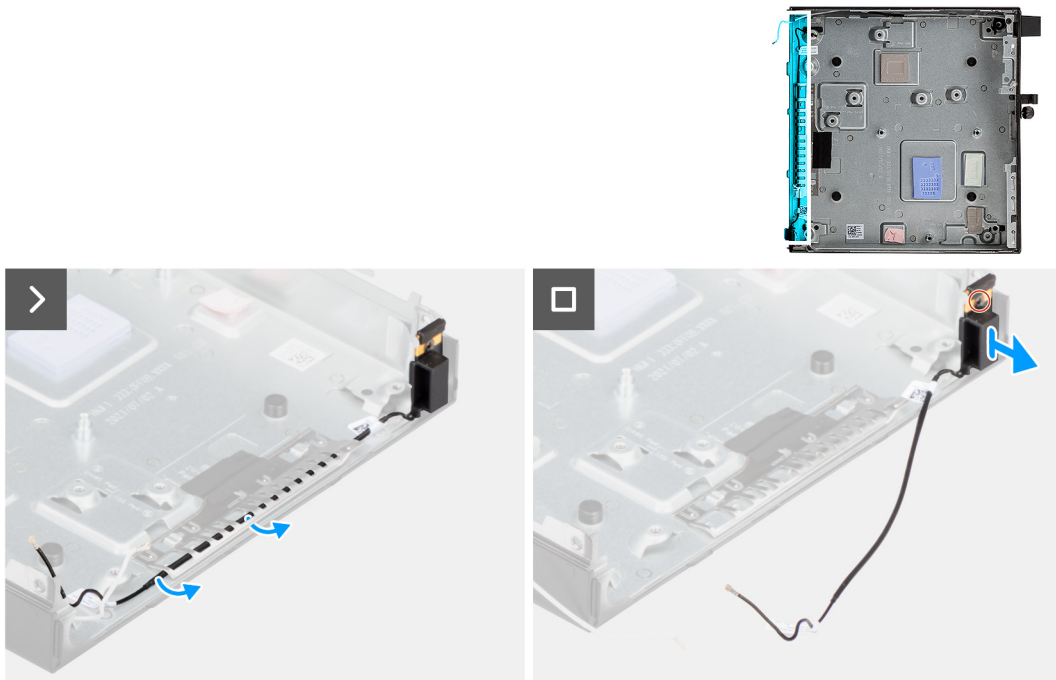

Figure 52. Removing the antenna module (black cable)

Steps

1. Remove the antenna cable from the routing guides on the chassis.
2. Loosen the captive screw that secures the antenna module (while cable) to the chassis.
3. Lift the antenna module (black cable) from the chassis.

Installing the antenna module (black cable)

CAUTION: The information in this section is intended for authorized service technicians only.

Prerequisites

If you are replacing a component, remove the existing component before performing the installation process.

About this task

The following image(s) indicate the location of the antenna module (black cable) and provides a visual representation of the installation procedure.

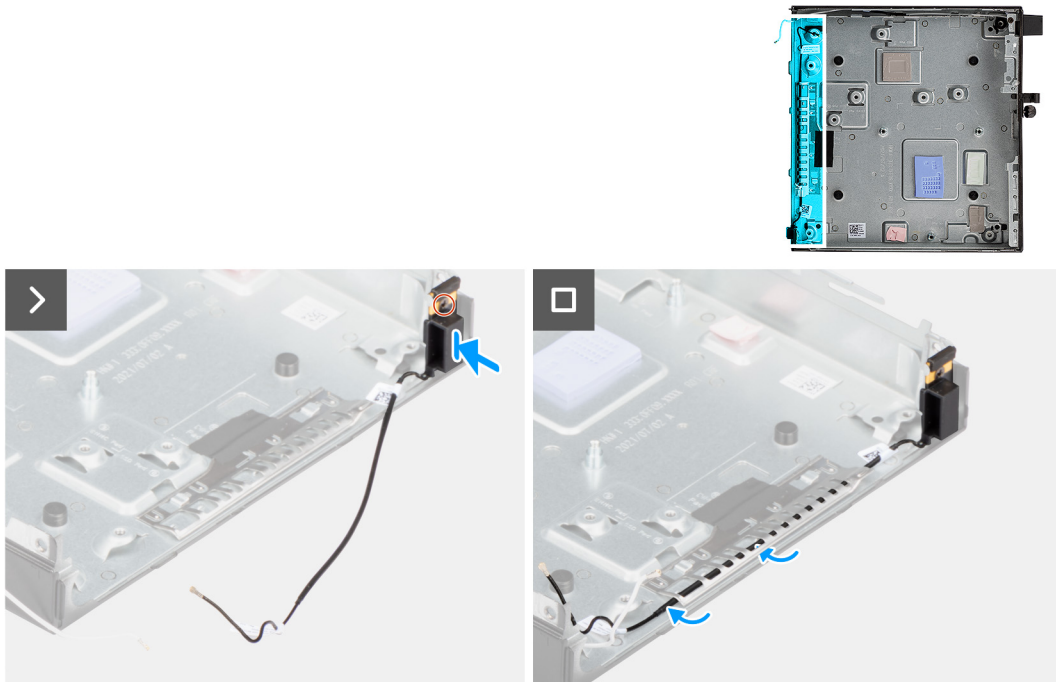

Figure 53. Installing the antenna module (black cable)

Steps

1. Place the antenna module (black cable) on the chassis.
2. Align the captive screw on the antenna module (black cable) to the screw hole on the chassis.
3. Tighten the captive screw that secures the antenna module (black cable) to the chassis.
4. Route the antenna cable through the routing guides on the chassis.

Next steps

1. Install the [system board](#).
 - i** **NOTE:** The system board can be installed with the memory, coin-cell battery, and processor preattached.
2. Install the [optional I/O module \(HDMI/VGA/DP/Serial/PS2\)](#) or the [optional Type-C module](#), whichever is applicable.
3. Install the [heat sink](#).
4. Install the [fan](#).
5. Install the [speaker](#).
6. Install the [wireless card](#).
7. Install the [M.2 2230 solid-state drive](#) or [M.2 2280 solid-state drive](#), whichever is applicable.
8. Install the [side cover](#).
9. Follow the procedure in [After working inside your computer](#).

Removing SMA antenna assembly

Prerequisites

1. Follow the procedure in [before working inside your computer](#).
2. Remove the [side cover](#).
3. Remove the [wireless card](#).

About this task

The following images indicate the location of SMA antenna assembly and provide a visual representation of the removal procedure.

i **NOTE:** To upgrade to an SMA antenna, the internal antenna (white cable) needs to be removed.



1x
M3x3

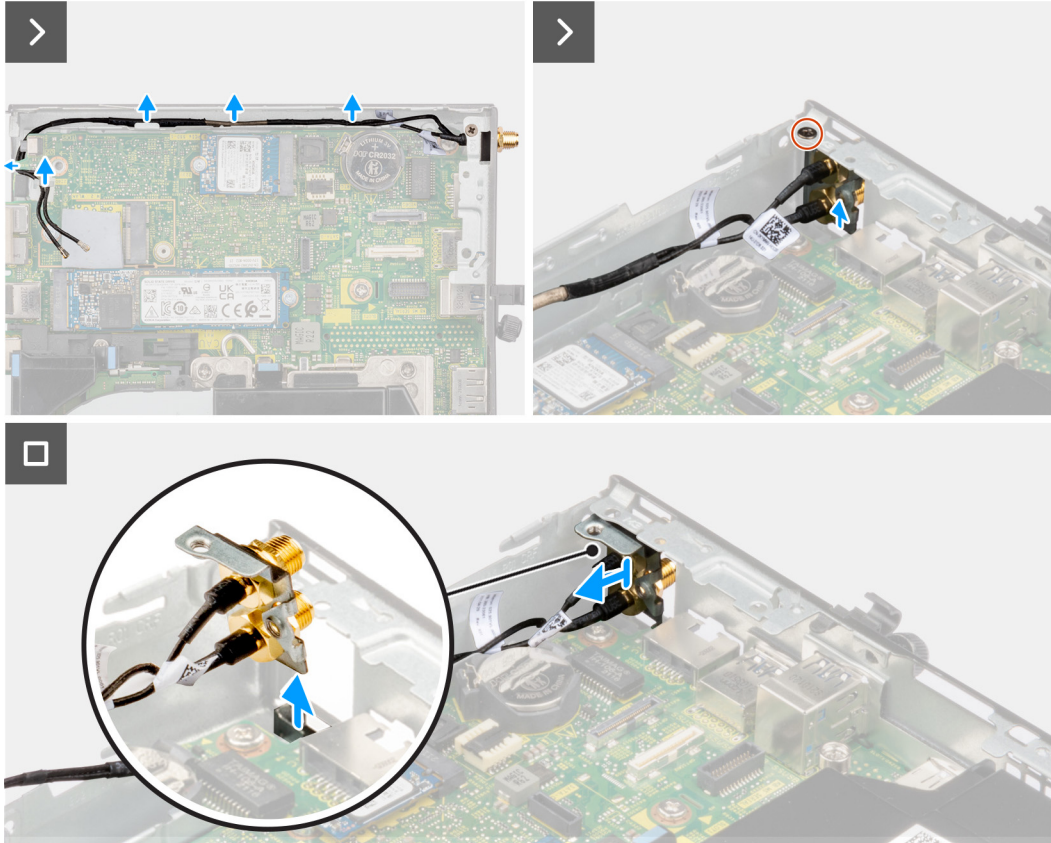
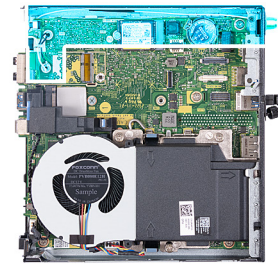

Figure 54. Removing SMA antenna

Steps

1. Remove the SMA antenna assembly cables from the routing guides on the chassis.
2. Remove the screw (M3x3) that secures the SMA antenna assembly to the chassis.
3. Push the SMA antenna assembly inside from the opening on the back and lift it away from the chassis.

Installing SMA antenna assembly

Prerequisites

If you are replacing a component, remove the existing component before performing the installation procedure.

About this task

The following images indicate the location of SMA antenna assembly and provide a visual representation of the removal procedure.

 **NOTE:** To upgrade to an SMA antenna, the internal antenna (white cable) must be removed.



1x
M3x3

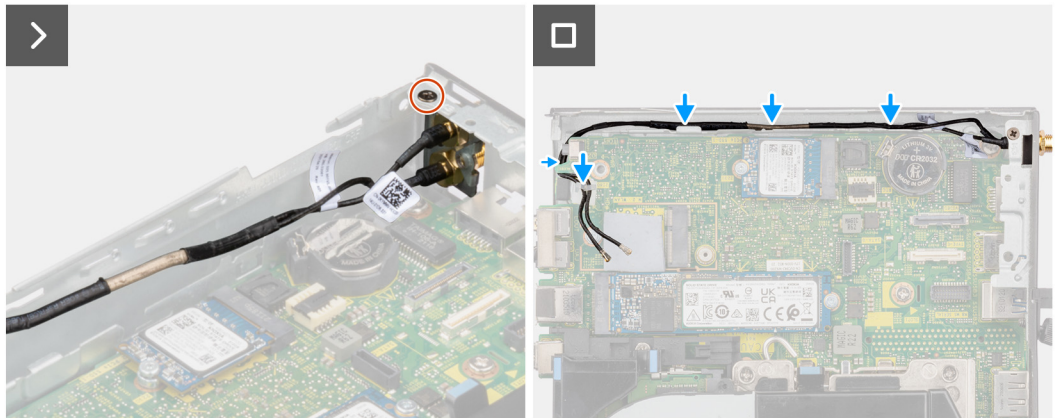
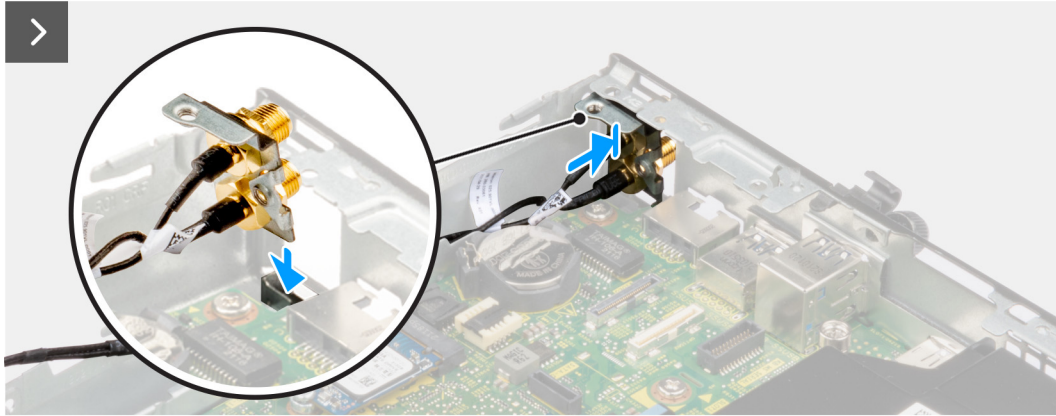
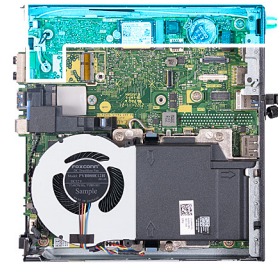

Figure 55. Installing SMA antenna (Location 3)

Steps

1. Remove the fillers on the side cover, if applicable.
2. Tilt the SMA antenna assembly.
3. Align and place the antenna bracket on the system board.
4. Insert the SMA antenna assembly through the opening at the back of the chassis.
5. Align the screw hole on the SMA antenna assembly with the screw hole.
6. Replace the screw (M3x3) that secures the SMA antenna assembly to the chassis.
7. Route the SMA antenna assembly cables through the routing guides on the chassis.

Next steps

1. Install the [wireless card](#).
2. Install the [side cover](#).
3. Follow the procedure in [after working inside your computer](#).

Software

This chapter details the supported operating systems along with instructions on how to install the drivers.

Operating system

Your OptiPlex Micro Plus 7020 supports the following operating systems:

- Windows 11 Home
- Windows 11 Pro
- Windows 11 Pro National Education
- Ubuntu Linux 22.04 LTS, 64-bit
- Windows 10 IoT Enterprise LTSC 2021

Drivers and downloads

When troubleshooting, downloading, or installing drivers, it is recommended that you read the Dell Knowledge Base article [Drivers and Downloads FAQs 000123347](#).

BIOS Setup

CAUTION: Unless you are an expert computer user, do not change the settings in the BIOS Setup. Certain changes can make your computer work incorrectly.

NOTE: Depending on the computer and the installed devices, the options that are listed in this section may or may not be displayed.

NOTE: Before you change the settings in BIOS Setup, it is recommended that you note down the original settings for future reference.

Use BIOS Setup for the following purposes:

- Get information about the hardware installed in your computer, such as the amount of RAM and the size of the storage device.
- Change the system configuration information.
- Set or change a user-selectable option, such as the user password, type of hard drive installed, and enable or disable base devices.

Entering BIOS Setup program

About this task

Turn on (or restart) your computer and press F2 immediately.

Navigation keys

NOTE: For most of the BIOS Setup options, changes that you make are recorded but do not take effect until you restart the computer.

Table 25. Navigation keys

Keys	Navigation
Up arrow	Moves to the previous field.
Down arrow	Moves to the next field.
Enter	Selects a value in the selected field (if applicable) or follows the link in the field.
Spacebar	Expands or collapses a drop-down list, if applicable.
Tab	Moves to the next focus area.
Esc	Moves to the previous page until you view the main screen. Pressing Esc in the main screen displays a message that prompts you to save any unsaved changes and restart the computer.

One time boot menu

To access the **one time boot menu**, turn on your computer, and then press F2 immediately.

NOTE: If your computer fails to enter the boot menu, restart the computer and press F2 immediately.

The one-time boot menu displays the devices that you can boot from, and also displays the option to start diagnostics. The boot menu options are:

- Removable Drive (if available)
- STXXXX Drive (if available)
- **i** **NOTE:** XXX denotes the SATA drive number.
- Optical Drive (if available)
- SATA Hard Drive (if available)
- Diagnostics
- **i** **NOTE:** Choosing **Diagnostics**, will display the **ePSA diagnostics** screen.

The **one time boot menu** also displays the option to access the System Setup screen.

F12 One Time Boot menu

To enter the One Time Boot menu, turn on your computer, and then press F12 immediately.

- **i** **NOTE:** If you are unable to enter the One Time Boot menu, repeat the above action.

The One Time Boot menu displays the devices that you can boot from and also display the options to start diagnostics. The boot menu options are:

- Removable Drive (if available)
- STXXXX Drive (if available)
- **i** **NOTE:** XXX denotes the SATA drive number.
- Optical Drive (if available)
- SATA Hard Drive (if available)
- Diagnostics

The One Time Boot menu screen also displays the option to access BIOS Setup.

System setup options

- **i** **NOTE:** Depending on your computer and its installed devices, the items that are listed in this section may or may not be displayed.

Table 26. System setup options—System information menu

Overview	
OptiPlex Micro Plus 7020	
BIOS Version	Displays the BIOS version number.
Service Tag	Displays the Service Tag of the computer.
Asset Tag	Displays the Asset Tag of the computer.
Manufacture Date	Displays the manufacture date of the computer.
Ownership Date	Displays the ownership date of the computer.
Express Service Code	Displays the express service code of the computer.
Ownership Tag	Displays the Ownership Tag of the computer.
Signed Firmware Update	Displays whether the Signed Firmware Update is enabled on your computer. By default, the Signed Firmware Update option is enabled.
PROCESSOR	
Processor Type	Displays the processor type.
Maximum Clock Speed	Displays the maximum processor clock speed.

Table 26. System setup options—System information menu (continued)

Overview	
Minimum Clock Speed	Displays the minimum processor clock speed.
Current Clock Speed	Displays the current processor clock speed.
Core Count	Displays the number of cores on the processor.
Processor ID	Displays the processor identification code.
Processor L2 Cache	Displays the processor L2 Cache size.
Processor L3 Cache	Displays the processor L3 Cache size.
Microcode Version	Displays the microcode version.
Intel Hyper-Threading Capable	Displays whether the processor is Hyper-Threading (HT) capable.
64-Bit Technology	Displays whether 64-bit technology is used.
MEMORY	
Memory Installed	Displays the total computer memory installed.
Memory Available	Displays the total computer memory available.
Memory Speed	Displays the memory speed.
Memory Channel Mode	Displays single or dual channel mode.
Memory Technology	Displays the technology that is used for the memory.
DIMM 1 Size	Displays the DIMM 1 memory size.
DIMM 2 Size	Displays the DIMM 2 memory size.
DEVICES	
Video Controller	Displays the video controller type of the computer.
Video Memory	Displays the video memory information of the computer.
Wi-Fi Device	Displays the wireless device information of the computer.
Native Resolution	Displays the native resolution of the computer.
Video BIOS Version	Displays the video BIOS version of the computer.
Audio Controller	Displays the audio controller information of the computer.
Bluetooth Device	Displays the Bluetooth device information of the computer.
LOM MAC Address	Displays the LAN On Motherboard (LOM) MAC address of the computer.

Table 27. System setup options—Boot Configuration menu

Boot Configuration	
Boot Sequence	
Boot Mode: UEFI only	Displays the boot mode.
Boot Sequence	Displays the boot sequence.
Enable PXE Boot Priority	Enables or disables the option to add a new PXE boot to the top of the Boot Sequence. By default, the OFF option is disabled.
Force PXE On Next Boot	Enables or disables the Force PXE feature on the next boot. By default, the Force PXE On Next Boot option is disabled.
Secure Boot	
Enable Secure Boot	Enable or disable the secure boot feature. By default, the OFF option is disabled.

Table 27. System setup options—Boot Configuration menu (continued)

Boot Configuration	
Enable Microsoft UEFI CA	<p>Enable or disable Microsoft UEFI Certificate Authority.</p> <p>By default, the ON option is enabled.</p> <p> CAUTION: Disabling Microsoft UEFI CA could render your system being unable to boot. System graphics may not function, some devices may not function properly. The system could become unrecoverable.</p>
Secure Boot Mode	<p>Change the secure boot mode options.</p> <p>By default, the Deployed Mode option is enabled.</p>
Expert Key Management	
Enable Custom Mode	<p>Enable or disable custom mode.</p> <p>By default, the OFF option is disabled.</p>
Custom Mode Key Management	<p>Select the custom values for expert key management.</p>

Table 28. System setup options—Integrated Devices menu

Integrated Devices	
Date/Time	<p>Displays the current date in MM/DD/YYYY format and current time in HH:MM:SS AM/PM format.</p>
Enable Audio	<p>Enable or disable the integrated audio controller.</p> <p>By default, all the options are enabled.</p>
Serial Port	
Serial Port Configuration	<p>Enable or disable the serial port address.</p> <p>By default, the COM1: Port is configured at 3F8h with IRQ4 option is selected.</p>
USB Configuration	<p>Enable or disable booting from USB mass storage devices through the boot sequence or boot menu.</p> <p>By default, all the options are enabled.</p>
Front USB Configuration	<p>Enable or disable the individual front USB ports.</p> <p>By default, all the options are enabled.</p>
Rear USB Configuration	<p>Enable or disable the individual rear USB ports.</p> <p>By default, all the options are enabled.</p>
Dust Filter Maintenance	<p>Enable or disable the dust filter maintenance.</p> <p>By default, the Disabled option is enabled.</p>

Table 29. System setup options—Storage menu

Storage	
SATA/NVMe Operation	<p>Enable or disable the operating mode of the integrated SATA hard drive controller.</p> <p>By default, the RAID On option is enabled.</p>
Storage Interface	
Port Enablement	<p>Enable or disable the onboard drives.</p> <p>By default, all the onboard drives are enabled.</p>

Table 29. System setup options—Storage menu (continued)

Storage	
M.2 PCIe SSD-0	Enable or disable the M.2 PCIe SSD-0 solid-state drive. By default, the ON option is enabled.
M.2 PCIe SSD-1	Enable or disable the M.2 PCIe SSD-1 solid-state drive. By default, the ON option is enabled.
SMART Reporting	
Enable SMART Reporting	Enable or disable Self-Monitoring, Analysis, and Reporting Technology (SMART) during computer startup. By default, the OFF option is disabled.
Drive Information	
M.2 PCIe SSD-0	
Type	Displays the M.2 PCIe SSD-0 type information of the computer.
Device	Displays the M.2 PCIe SSD-0 device information of the computer.
Drive Information	
M.2 PCIe SSD-1	
Type	Displays the M.2 PCIe SSD-1 type information of the computer.
Device	Displays the M.2 PCIe SSD-1 device information of the computer.

Table 30. System setup options—Display menu

Display	
Primary Display	Determines the primary display when multiple controllers are available on the computer. By default, the Auto option is enabled.
Full Screen Logo	Enable or disable full screen logo. By default, the OFF option is disabled.

Table 31. System setup options—Connection menu

Connection	
Network Controller Configuration	
Integrated NIC	Controls the on-board LAN controller. By default, the Enabled with PXE option is selected.
Wireless Device Enable	
WLAN	Enable or disable the internal WLAN device. By default, the WLAN option is selected.
Bluetooth	Enable or disable the internal Bluetooth device. By default, the Bluetooth option is selected.
Enable UEFI Network Stack	Enable or disable UEFI Network Stack and controls the on-board LAN Controller. By default, the Auto Enabled option is selected.
HTTP(s) Boot Feature	
HTTP(s) Boot	Enable or disable the HTTP(s) Boot feature.

Table 31. System setup options—Connection menu (continued)

Connection	
HTTP(s) Boot Mode	<p>By default, the ON option is enabled.</p> <p>With Auto Mode, the HTTP(s) Boot extracts Boot URL from the DHCP. With Manual Mode, the HTTP(s) Boot reads Boot URL from the user-provided data.</p> <p>By default, the Auto Mode option is selected.</p>

Table 32. System setup options—Power menu

Power	
<p>USB PowerShare</p> <p>Enable USB PowerShare</p>	<p>When enabled, USB devices connected to the designated USB PowerShare port on the computer are powered or charged using the stored system battery.</p> <p>By default, the OFF option is disabled.</p>
<p>Thermal Management</p>	<p>Select the heat management settings for the cooling fan and the processor, with respect to system performance, noise, and temperature.</p> <p>By default, the Optimized option is selected.</p>
<p>USB Wake Support</p> <p>Enable USB Wake Support</p>	<p>When enabled, you can use the USB devices like a mouse or keyboard to wake your computer from standby.</p> <p>By default, the ON option is enabled.</p>
<p>AC Behavior</p> <p>AC Recovery</p>	<p>Allows you to determine what happens when AC power is restored after an unexpected loss of AC power.</p> <p>By default, the Power Off option is selected.</p>
<p>Block Sleep</p>	<p>Enables or disables the computer from entering Sleep (S3) mode in the operating system.</p> <p>By default, the OFF option is disabled.</p> <p>NOTE: When enabled, the computer does not go to Sleep, Intel Rapid Start is disabled automatically, and the operating system power option is blank if it was set to Sleep.</p>
<p>Deep Sleep Control</p>	<p>Enable or disable the Deep Sleep mode support.</p> <p>By default, the Enabled in S4 and S5 option is selected.</p>
<p>Fan Control Override</p>	<p>Enable or disable the fan control override feature.</p> <p>By default, the OFF option is enabled.</p>
<p>Intel Speed Shift Technology</p>	<p>Enable or disable the Intel speed shift technology support.</p> <p>By default, the ON option is enabled.</p>

Table 33. System setup options—Security menu

Security	
<p>TPM 2.0 Security</p> <p>TPM 2.0 Security On</p>	<p>Enable or disable TPM 2.0 security options.</p> <p>By default, the ON option is enabled.</p>
<p>Attestation Enable</p>	<p>Enables to control whether the Trusted Platform Module (TPM) Endorsement Hierarchy is available to the operating system.</p>

Table 33. System setup options—Security menu (continued)



Security	
	By default, the ON option is enabled.
Key Storage Enable	Enables to control whether the Trusted Platform Module (TPM) Storage Hierarchy is available to the operating system. By default, the ON option is enabled.
SHA-256	BIOS and the TPM will use the SHA-256 hash algorithm to extend measurements into the TPM PCRs during BIOS boot. By default, the ON option is enabled.
Clear	Enables to clear the TPM owner information and returns the TPM to the default state. By default, the OFF option is enabled.
PPI ByPass for Clear Commands	Controls the TPM Physical Presence Interface (PPI). By default, the OFF option is enabled.
Chassis intrusion	Controls the chassis intrusion feature. By default, the Disabled option is enabled.
SMM Security Mitigation	Enables or disables additional UEFI SMM Security Mitigation protections. This option uses the Windows SMM Security Mitigations Table (WSMT) to confirm to the operating system that security best practices have been implemented by the UEFI firmware. By default, the ON option is enabled. For additional security, Dell Technologies recommends keeping the SMM Security Mitigation option enabled unless you have a specific application which is not compatible.  NOTE: This feature may cause compatibility issues or loss of functionality with some legacy tools and applications.
Data Wipe on Next Boot	
Start Data Wipe	Data Wipe is a secure wipe operation that deletes information from a storage device.  CAUTION: The secure Data Wipe operation deletes information in a way that it cannot be reconstructed. Commands such as delete and format in the operating system may remove files from showing up in the file system. However, they can be reconstructed through forensic means as they are still represented on the physical media. Data Wipe prevents this reconstruction and is not recoverable. When enabled, the data wipe option will prompt to wipe any storage devices that are connected to the computer on the next boot. By default, the OFF option is disabled.
Absolute®	
Absolute®	Absolute Software provides various cyber security solutions, some requiring software preloaded on Dell computers and integrated into the BIOS. To use these features, you must enable the Absolute BIOS setting and contact Absolute for configuration and activation. By default, the Enable Absolute option is enabled. For additional security, Dell Technologies recommends keeping the Absolute option enabled.

Table 33. System setup options—Security menu (continued)

Security	
	<p> NOTE: When the Absolute features are activated, the Absolute integration cannot be disabled from the BIOS setup screen.</p>
<p>UEFI Boot Path Security</p> <p>UEFI Boot Path Security</p>	<p>Enables or disables the computer to prompt the user to enter the Administrator password (if set) when booting to a UEFI boot path device from the F12 boot menu.</p> <p>By default, the Always Except Internal HDD option is selected.</p>

Table 34. System setup options—Passwords menu

Passwords	
Admin Password	Set, change, or delete the administrator password.
System Password	Set, change, or delete the computer password.
M.2 PCIe SSD-0	Set, change, or delete the M.2 PCIe SSD-0 password.
M.2 PCIe SSD-1	Set, change, or delete the M.2 PCIe SSD-1 password.
Password Configuration	<p>The Password configuration page includes several options for changing the requirements of BIOS passwords. You can modify the minimum and maximum length of the passwords and require passwords to contain certain character classes (upper case, lower case, digit, special character).</p> <p>Dell Technologies recommends setting the minimum password length to at least eight characters.</p>
Upper Case Letter	<p>Reinforces password must have at least one upper case letter.</p> <p>By default, the OFF option is enabled.</p>
Lower Case Letter	<p>Reinforces password must have at least one lower case letter.</p> <p>By default, the OFF option is enabled.</p>
Digit	<p>Reinforces password must have at least one digit.</p> <p>By default, the OFF option is enabled.</p>
Special Character	<p>Reinforces password must have at least one special character.</p> <p>By default, the OFF option is enabled.</p>
Minimum Characters	<p>Set the minimum characters allowed for password.</p> <p>By default, the Minimum Characters value is set to 4.</p>
Password Bypass	<p>When enabled, this always prompts for computer and internal hard drive passwords when powered on from the off state.</p> <p>By default, the Disabled option is enabled.</p>
Password Changes	
Enable Non-Admin Password Changes	<p>The Enable Non-Admin Password Changes option in BIOS setup allows an end user to set or change the computer or hard drive passwords without entering the administrator password. This gives an administrator control over the BIOS settings but enables an end user to provide their own password.</p> <p>By default, the ON option is enabled.</p> <p>For additional security, Dell Technologies recommends keeping the Enable Non-Admin Password Changes option disabled.</p>
Admin Setup Lockout	

Table 34. System setup options—Passwords menu (continued)

Passwords	
Enable Admin Setup Lockout	<p>The Enable Admin Setup Lockout option prevents an end user from even viewing the BIOS setup configuration without first entering the administrator password (if set).</p> <p>By default, the OFF option is disabled.</p> <p>For additional security, Dell Technologies recommends keeping the Enable Admin Setup Lockout option disabled.</p>
Master Password Lockout	
Enable Master Password Lockout	<p>The Master Password Lockout setting allows you to disable the Recovery Password feature. If the computer, administrator, or hard drive password is forgotten, the computer becomes unusable.</p> <p>i NOTE: When the owner password is set, the Master Password Lockout option is not available.</p> <p>i NOTE: When an internal hard drive password is set, it must first be cleared before Master Password Lockout can be changed.</p> <p>By default, the OFF option is disabled.</p> <p>Dell does not recommend enabling the Master Password Lockout unless you have implemented your own password recovery computer.</p>
Allow Non-Admin PSID Revert	
Enable Allow Non-Admin PSID Revert	<p>Controls access to the Physical Security ID (PSID) revert of NVMe hard-drives from the Dell Security Manager prompt.</p> <p>By default, the OFF option is disabled.</p>

Table 35. System setup options—Update, Recovery menu

Update, Recovery	
UEFI Capsule Firmware Updates	
Enable UEFI Capsule Firmware Updates	<p>Enables or disables BIOS updates through UEFI capsule update packages.</p> <p>i NOTE: Disabling this option blocks the BIOS updates from services such as Microsoft Windows Update and Linux Vendor Firmware Service (LVFS).</p> <p>By default, the Enable UEFI Capsule Firmware Updates option is enabled.</p>
BIOS Recovery from Hard Drive	<p>Enables or disables the user to recover from certain corrupted BIOS conditions from a recovery file on the user primary hard drive or an external USB key.</p> <p>By default, the ON option is enabled.</p> <p>i NOTE: BIOS Recovery from Hard Drive is not available for self-encrypting drives (SED).</p> <p>i NOTE: BIOS recovery is designed to fix the main BIOS block and cannot work if the Boot Block is damaged. In addition, this feature cannot work in the event of EC corruption, ME corruption, or a hardware issue. The recovery image must exist on an unencrypted partition on the drive.</p>
BIOS Downgrade	
Allow BIOS Downgrade	<p>Controls flashing of the computer firmware to previous revisions.</p> <p>By default, the ON option is enabled.</p>
SupportAssist OS Recovery	
	<p>Enables or disables the boot flow for SupportAssist OS Recovery tool in the event of certain computer errors.</p> <p>By default, the ON option is enabled.</p>

Table 35. System setup options—Update, Recovery menu (continued)

Update, Recovery	
BIOSConnect	<p>Enables or disables cloud Service operating system recovery if the main operating system fails to boot with the number of failures equal to or greater than the value specified by the Auto operating system Recovery Threshold setup option and local Service operating system does not boot or is not installed.</p> <p>By default, the ON option is enabled.</p>
Dell Auto OS Recovery Threshold	<p>Allows you to control the automatic boot flow for SupportAssist System Resolution Console and for Dell operating system Recovery Tool.</p> <p>By default, the value of 2 option is selected.</p>

Table 36. System setup options—System Management menu

System Management	
Service Tag	Display the Service Tag of the computer.
Asset Tag	<p>Creates a computer Asset Tag that can be used by an IT administrator to uniquely identify a particular computer.</p> <p>NOTE: Once set in BIOS, the Asset Tag cannot be changed.</p>
Wake on LAN/WLAN	<p>Enables or disables the computer to turn on by special LAN signals.</p> <p>By default, the Disabled option is selected.</p>
Auto On Time	<p>Enable to set the computer to turn on automatically every day or on a preselected date and time. This option can be configured only if the Auto On Time is set to Everyday, Weekdays, or Selected Days.</p> <p>By default, the Disabled option is selected.</p>
Intel AMT Capability	<p>Enable Intel AMT Capability</p> <p>Enable or disable the Intel AMT capability.</p> <p>By default, the Restrict Preboot Access option is selected.</p>
SERR Messages	<p>Enable SERR Messages</p> <p>Enable or disable SERR (system error) messages.</p> <p>By default, the ON option is enabled.</p>
First Power On Date	<p>Set Ownership Date</p> <p>Set ownership date</p> <p>By default, the OFF option is enabled.</p>
Diagnostics	<p>OS Agent Requests</p> <p>Enables OS agent request to schedule onboard diagnostics.</p> <p>By default, the ON option is enabled.</p>
Power-On-Self-Test Automatic Recovery	<p>Power-On-Self-Test Automatic Recovery</p> <p>Enables automatic recovery when the computer becomes unresponsive when performing a BIOS Power-On-Self-Test (POST). If the computer becomes unresponsive before POST is completed, the BIOS will automatically attempt to recover the computer. In some cases, this may include resetting the BIOS Setup configuration settings to BIOS default values, and unprovisioning the Intel AMT vPro feature, if applicable.</p> <p>By default, the ON option is enabled.</p>

Table 37. System setup options—Keyboard menu

Keyboard	
Keyboard Errors	
Enable Keyboard Error Detection	Enable or disable the keyboard error detection feature. By default, the ON option is enabled.
Numlock LED	
Enable Numlock LED	Enable or disable Numlock LED. By default, the ON option is enabled.
Device Configuration Hotkey Access	
Device Configuration Hotkey Access	Allows you to control whether you can access device configuration screens through hotkeys during computer startup. By default, the Enabled option is selected. i NOTE: This setting controls only the Intel RAID (CTRL+I), MEBX (CTRL+P), and LSI RAID (CTRL+C) Option ROMs. Other preboot Option ROMs, which support entry using a key sequence, are not affected by this setting.

Table 38. System setup options—Pre-boot Behavior menu

Pre-boot Behavior	
Adapter Warnings	
Enable Adapter Warnings	Enables the warning messages during boot when the adapters with less power capacity are detected. By default, the ON option is enabled.
Warning and Errors	Enables or disables the action to be taken when a warning or error is encountered. By default, the Prompt on Warnings and Errors option is selected. Stop, prompt, and wait for user input when warnings or errors are detected. i NOTE: Errors deemed critical to the operation of the computer hardware stop the functioning of the computer.
Extend BIOS POST Time	Sets the BIOS POST (Power-On Self-Test) load time. By default, the 0 seconds option is selected.

Table 39. System setup options—Virtualization menu

Virtualization	
Intel Virtualization Technology	
Enable Intel Virtualization Technology (VT)	When enabled, the computer can run a Virtual Machine Monitor (VMM). By default, the ON option is enabled.
VT for Direct I/O	
Enable Intel® VT for Direct I/O	When enabled, the computer can perform Virtualization Technology for Direct I/O (VT-d). VT-d is an Intel method that provides virtualization for memory map I/O. By default, the ON option is enabled.
Intel® Trusted Execution Technology (TXT)	Intel Trusted Execution Technology (TXT) is a set of hardware extensions to Intel processors and chipsets. It provides a hardware-based root of trust to ensure that a platform boots with a known good configuration of firmware, BIOS, virtual machine monitor, and operating system. The following must be enabled in order to enable Intel TXT -

Table 39. System setup options—Virtualization menu (continued)

Virtualization	
	<ul style="list-style-type: none"> • Intel Virtualization Technology - X • Intel Virtualization Technology - Direct
Enable Intel Trusted Execution Technology (TXT)	<p>By default, the OFF option is enabled.</p> <p>For additional security, Dell Technologies recommends enabling the Intel Trusted Execution Technology (TXT) feature.</p>
DMA Protection	
Enable Pre-Boot DMA support.	<p>Allows you to control the Pre-Boot DMA protection for both internal and external ports. This option does not directly enable DMA protection in the operating system.</p> <p>i NOTE: This option is not available when the virtualization setting for IOMMU is disabled (VT-d/AMD Vi).</p> <p>By default, the ON option is enabled.</p> <p>For additional security, Dell Technologies recommends keeping the Enable Pre-Boot DMA Support option enabled.</p> <p>i NOTE: This option is provided only for compatibility purposes, since some older hardware is not DMA capable.</p>
Enable OS Kernel DMA support	<p>Allows you to control the Kernel DMA protection for both internal and external ports. This option does not directly enable DMA protection in the operating system. For operating systems that support DMA protection, this setting indicates to the operating system that the BIOS supports the feature.</p> <p>i NOTE: This option is not available when the virtualization setting for IOMMU is disabled (VT-d/AMD Vi).</p> <p>By default, the ON option is enabled.</p> <p>i NOTE: This option is provided only for compatibility purposes, since some older hardware is not DMA capable.</p>

Table 40. System setup options—Performance menu

Performance	
Multi-Core Support	
Multiple Atom Cores	<p>Enables to change the number of Atom cores available to the operating system. The default value is set to the maximum number of cores.</p> <p>By default, the All Cores option is selected.</p>
Intel® SpeedStep	
Enable Intel® SpeedStep Technology	<p>Enables the computer to dynamically adjust processor voltage and core frequency, decreasing average power consumption and heat production.</p> <p>By default, the ON option is enabled.</p>
C-States Control	
Enable C-State Control	<p>Enables or disables the ability of the CPU to enter and exit low-power state. When disabled, it disables all C-states. When enabled, it enables all C-states that the chipset or platform allows.</p> <p>By default, the ON option is enabled.</p>
Intel® Turbo Boost Technology	
Enable Intel® Turbo Boost Technology	<p>Enables the Intel TurboBoost mode of the processor. When enabled, the Intel TurboBoost driver increases the performance of the CPU or graphics processor.</p> <p>By default, the ON option is enabled.</p>

Table 40. System setup options—Performance menu (continued)

Performance	
Intel® Hyper-Threading Technology	
Enable Intel® Hyper-Threading Technology	Enables the Intel Hyper-Threading mode of the processor. When enabled, the Intel Hyper-Threading increases the efficiency of the processor resources when multiple threads run on each core. By default, the ON option is enabled.
PCIe Resizable Base Address Register (BAR)	
Enable PCIe Resizable Base Address Register (BAR) support	Enable or disable PCIe Resizable BAR in the processor. By default, the OFF option is disabled.

Table 41. System setup options—System Logs menu

System Logs	
BIOS Event Log	
Clear Bios Event Log	Allows you to select option to keep or clear BIOS events logs. By default, the Keep Log option is selected.
Power Event Log	
Clear Power Event Log	Allows you to select option to keep or clear Power events logs. By default, the Keep Log option is selected.

Updating the BIOS

Updating the BIOS in Windows

About this task

CAUTION: If BitLocker is not suspended before updating the BIOS, the next time you reboot the computer it will not recognize the BitLocker key. You will then be prompted to enter the recovery key to progress, and the computer will ask for this on each reboot. If the recovery key is not known this can result in data loss or an unnecessary operating system reinstall. For more information about this subject, search in the Knowledge Base Resource at [Dell Support Site](#).

Steps

1. Go to [Dell Support Site](#).
2. Click **Product support**. In the **Search support** box, enter the Service Tag of your computer, and then click **Search**.
NOTE: If you do not have the Service Tag, use the SupportAssist to automatically identify your computer. You can also use the product ID or manually browse for your computer model.
3. Click **Drivers & Downloads**. Expand **Find drivers**.
4. Select the operating system installed on your computer.
5. In the **Category** drop-down list, select **BIOS**.
6. Select the latest version of BIOS, and click **Download** to download the BIOS file for your computer.
7. After the download is complete, browse the folder where you saved the BIOS update file.
8. Double-click the BIOS update file icon and follow the on-screen instructions.
 For more information, search in the Knowledge Base Resource at [Dell Support Site](#).

Updating the BIOS in Linux and Ubuntu

To update the system BIOS on a computer that is installed with Linux or Ubuntu, see the knowledge base article [000131486](#) at [Dell Support Site](#).

Updating the BIOS using the USB drive in Windows

About this task

 **CAUTION:** If BitLocker is not suspended before updating the BIOS, the next time you reboot the computer it will not recognize the BitLocker key. You will then be prompted to enter the recovery key to progress, and the computer will ask for this on each reboot. If the recovery key is not known this can result in data loss or an unnecessary operating system reinstall. For more information about this subject, search in the Knowledge Base Resource at [Dell Support Site](#).

Steps

1. Follow the procedure from step 1 to step 6 in [Updating the BIOS in Windows](#) to download the latest BIOS setup program file.
2. Create a bootable USB drive. For more information, search in the Knowledge Base Resource at [Dell Support Site](#).
3. Copy the BIOS setup program file to the bootable USB drive.
4. Connect the bootable USB drive to the computer that needs the BIOS update.
5. Restart the computer and press **F12**.
6. Select the USB drive from the **One Time Boot Menu**.
7. Type the BIOS setup program filename and press **Enter**.
The **BIOS Update Utility** appears.
8. Follow the on-screen instructions to complete the BIOS update.

Updating the BIOS from the One-Time boot menu

Update your computer BIOS using the BIOS XXXX.exe file that is copied to a FAT32 USB drive and booting from the One-Time boot menu.

About this task

 **CAUTION:** If BitLocker is not suspended before updating the BIOS, the next time you reboot the computer it will not recognize the BitLocker key. You will then be prompted to enter the recovery key to progress, and the computer will ask for this on each reboot. If the recovery key is not known this can result in data loss or an unnecessary operating system reinstall. For more information about this subject, search in the Knowledge Base Resource at [Dell Support Site](#).

BIOS Update

You can run the BIOS flash update file from Windows using a bootable USB drive or you can also update the BIOS from the One-Time boot menu on the computer.

You can confirm by booting your computer to the **One Time Boot Menu** to see if BIOS FLASH UPDATE is listed as a boot option. If the option is listed, then the BIOS can be updated using this method..

Updating from the One-Time boot menu

To update your BIOS from the One-Time boot menu, you need the following:

- USB drive formatted to the FAT32 file system (the drive does not have to be bootable)
- BIOS executable file that you downloaded from the Dell Support website and copied to the root of the USB drive
- AC power adapter must be connected to the computer
- Functional computer battery to flash the BIOS

Perform the following steps to perform the BIOS flash update process from the One-Time boot menu:

 **CAUTION:** Do not turn off the computer during the BIOS flash update process. The computer may not boot if you turn off your computer.

Steps

1. Turn off your computer, insert the USB drive where you copied the BIOS flash update file into a USB port of the computer.
2. Turn on the computer and press to access the **One Time Boot** Menu. Select BIOS Update using the mouse or arrow keys then press Enter.
The flash BIOS menu is displayed.
3. Click **Flash from file**.
4. Select the external USB device.
5. Select the file and double-click the flash target file, and then click **Submit**.
6. Click **Update BIOS**. The computer restarts to flash the BIOS.
7. The computer will restart after the BIOS flash update is completed.

System and setup password

Table 42. System and setup password

Password type	Description
System password	Password that you must enter to log in to your system.
Setup password	Password that you must enter to access and make changes to the BIOS settings of your computer.

You can create a system password and a setup password to secure your computer.

 **CAUTION:** The password features provide a basic level of security for the data on your computer.

 **CAUTION:** Anyone can access the data that is stored on your computer, when left unattended.

 **NOTE:** System and setup password feature is disabled.

Assigning a System Setup password

Prerequisites

You can assign a new System or Admin Password only when the status is in **Not Set**.

About this task

To enter BIOS System Setup, press F2 immediately after a power-on or reboot.

Steps

1. In the **System BIOS** or **System Setup** screen, select **Security** and press Enter.
The **Security** screen is displayed.
2. Select **System/Admin Password** and create a password in the **Enter the new password** field.
Use the following guidelines to assign the system password:
 - A password can have up to 32 characters.
 - At least one special character: "(! " # \$ % & ' * + , - . / : ; < = > ? @ [\] ^ _ ` { | })"
 - Numbers 0 to 9.
 - Upper case letters from A to Z.
 - Lower case letters from a to z.
3. **Confirm new password** type the system password that you entered earlier in the field and click **OK**.
4. Press Esc and save the changes as prompted by the message.
5. Press Y to save the changes.
The computer restarts.

Deleting or changing an existing system password or setup password

Prerequisites

Ensure that the **Password Status** is Unlocked (in the System Setup) before attempting to delete or change the existing system password and/or setup password. You cannot delete or change an existing system password or setup password if the **Password Status** is Locked.

About this task

To enter the System Setup, press F2 immediately after a power-on or reboot.

Steps

1. In the **System BIOS** or **System Setup** screen, select **System Security** and press Enter.
The **System Security** screen is displayed.
2. In the **System Security** screen, verify that the **Password Status** is Unlocked.
3. Select **System Password**. Update or delete the existing system password, and press Enter or Tab.
4. Select **Setup Password**. Update or delete the existing setup password, and press Enter or Tab.
 **NOTE:** If you change the system password and/or setup password, reenter the new password when prompted. If you delete the system password and/or setup password, confirm the deletion when prompted.
5. Press Esc. A message prompts you to save the changes.
6. Press Y to save the changes and exit from **System Setup**.
The computer restarts.

Clearing BIOS (System Setup) and System passwords

About this task

To clear the computer or BIOS passwords, contact Dell technical support as described at [Contact Support](#). For more information, go to [Dell Support Site](#).

-  **NOTE:** For information about how to reset Windows or application passwords, see the documentation accompanying Windows or your application.

Troubleshooting

Dell SupportAssist Pre-boot System Performance Check diagnostics

About this task

SupportAssist diagnostics (also known as system diagnostics) performs a complete check of your hardware. The Dell SupportAssist Pre-boot System Performance Check diagnostics is embedded with the BIOS and launched by the BIOS internally. The embedded system diagnostics provides options for particular devices or device groups allowing you to:

- Run tests automatically or in an interactive mode.
- Repeat the tests.
- Display or save test results.
- Run thorough tests to introduce additional test options to provide extra information about one or more failed devices.
- View status messages that inform you the tests are completed successfully.
- View error messages that inform you of problems encountered during testing.

 **NOTE:** Some tests for specific devices require user interaction. Always ensure that you are present at the computer when the diagnostic tests are performed.

For more information, see the knowledge base article [000180971](#).

Running the SupportAssist Pre-Boot System Performance Check

Steps

1. Turn on your computer.
2. As the computer boots, press the F12 key as the Dell logo appears.
3. On the boot menu screen, select the **Diagnostics** option.
4. Click the arrow at the bottom left corner.
Diagnostics page is displayed.
5. Click the arrow in the lower-right corner to go to the page listing.
The items that are detected are listed.
6. To run a diagnostic test on a specific device, press Esc and click **Yes** to stop the diagnostic test.
7. Select the device from the left pane and click **Run Tests**.
8. If there are any issues, error codes are displayed.
Note the error code and validation number and contact Dell.

Power-Supply Unit Built-in Self-Test

Built-in Self-Test (BIST) helps determine if the power-supply unit is working. To run self-test diagnostics on the power-supply unit of a desktop or all-in-one computer, search in the Knowledge Base Resource at [Dell Support Site](#).

System-diagnostic lights

Table 43. Diagnostic LED behavior

Blinking pattern		Problem description
Amber	White	
1	2	Unrecoverable SPI Flash Failure
2	1	CPU failure
2	2	System board failure (included BIOS corruption or ROM error)
2	3	No memory/RAM detected
2	4	Memory/RAM failure
2	5	Invalid memory installed
2	6	System board / Chipset Error / Clock failure / Gate A20 failure / Super I/O failure / Keyboard controller failure
3	1	CMOS battery failure
3	2	PCI or Video card/chip failure
3	3	BIOS Recovery image not found
3	4	BIOS Recovery image found but invalid
3	5	Power rail failure
3	6	SBIOS Flash corruption
3	7	Intel ME (Management Engine) Error
4	2	CPU Power Cable Connection Issue

Recovering the operating system

When your computer is unable to boot to the operating system even after repeated attempts, it automatically starts Dell SupportAssist OS Recovery.

Dell SupportAssist OS Recovery is a stand-alone tool that is preinstalled in Dell computers running Windows operating system. It consists of tools to diagnose and troubleshoot issues that may occur before your computer boots to the operating system. It enables you to diagnose hardware issues, repair your computer, back up your files, or restore your computer to its factory state.

You can also download it from the Dell Support website to troubleshoot and fix your computer when it fails to boot into the primary operating system due to software or hardware failures.

For more information about the Dell SupportAssist OS Recovery, see *Dell SupportAssist OS Recovery User's Guide* at [Serviceability Tools at the Dell Support Site](#). Click **SupportAssist** and then, click **SupportAssist OS Recovery**.

Real Time Clock—RTC reset

The Real Time Clock (RTC) reset function allows you or the service technician to recover the recently launched model Dell Latitude and Precision systems from **No POST/No Boot/No Power** situations. You can initiate the RTC reset on the system from a power-off state only if it is connected to AC power. Press and hold the power button for 25 seconds. The system RTC reset occurs after you release the power button.

NOTE: If AC power is disconnected from the system during the process or the power button is held longer than 40 seconds, the RTC reset process gets aborted.

The RTC reset will reset the BIOS to Defaults, un-provision Intel vPro and reset the system date and time. The following items are unaffected by the RTC reset:

- Service Tag
- Asset Tag
- Ownership Tag
- Admin Password
- System Password
- HDD Password
- Key Databases
- System Logs

 **NOTE:** The IT administrator's vPro account and password on the system will be un-provisioned. The system needs to go through the setup and configuration process again to reconnect it to the vPro server.

The below items may or may not reset based on your custom BIOS setting selections:

- Boot List
- Enable Legacy Option ROMs
- Secure Boot Enable
- Allow BIOS Downgrade

Backup media and recovery options

It is recommended to create a recovery drive to troubleshoot and fix problems that may occur with Windows. Dell provides multiple options for recovering the Windows operating system on your Dell computer. For more information, see [Dell Windows Backup Media and Recovery Options](#).

Wi-Fi power cycle

About this task

If your computer is unable to access the Internet due to Wi-Fi connectivity issues, reset your Wi-Fi device by performing the following steps:

Steps

1. Turn off the computer.
2. Turn off the modem.

 **NOTE:** Some Internet service providers (ISPs) provide a modem and router combo device.

3. Turn off the wireless router.
4. Wait for 30 seconds.
5. Turn on the wireless router.
6. Turn on the modem.
7. Turn on the computer.

Getting help and contacting Dell

Self-help resources

You can get information and help on Dell products and services using these self-help resources:

Table 44. Self-help resources

Self-help resources	Resource location
Information about Dell products and services	Dell Site
Tips	
Contact Support	In Windows search, type <code>Contact Support</code> , and press Enter.
Online help for operating system	Windows Support Site Linux Support Site
Access top solutions, diagnostics, drivers and downloads, and learn more about your computer through videos, manuals, and documents.	Your Dell computer is uniquely identified using a Service Tag or Express Service Code. To view relevant support resources for your Dell computer, enter the Service Tag or Express Service Code at Dell Support Site . For more information about how to find the Service Tag for your computer, see Locate the Service Tag on your computer .
Dell knowledge base articles	<ol style="list-style-type: none"> 1. Go to Dell Support Site. 2. On the menu bar at the top of the Support page, select Support > Support Library. 3. In the Search field on the Support Library page, type the keyword, topic, or model number, and then click or tap the search icon to view the related articles.

Contacting Dell

To contact Dell for sales, technical support, or customer service issues, see [Dell Support Site](#).

 **NOTE:** Availability of the services may vary depending on the country or region, and product.

 **NOTE:** If you do not have an active Internet connection, you can find contact information about your purchase invoice, packing slip, bill, or Dell product catalog.