

# Precision 5690

## Owner's Manual

## Notes, cautions, and warnings

 **NOTE:** A NOTE indicates important information that helps you make better use of your product.

 **CAUTION:** A CAUTION indicates either potential damage to hardware or loss of data and tells you how to avoid the problem.

 **WARNING:** A WARNING indicates a potential for property damage, personal injury, or death.

<b>Chapter 1: Views of Precision 5690</b>	<b>7</b>
Right	7
Left	7
Top	8
Front	10
Bottom	11
Service Tag	12
Battery charge and status light	12
<b>Chapter 2: Set up your Precision 5690</b>	<b>13</b>
<b>Chapter 3: Specifications of Precision 5690</b>	<b>15</b>
Dimensions and weight	15
Processor	15
Chipset	16
Operating system	16
Memory	16
External ports	17
Internal slots	17
Wireless module	17
Audio	18
Storage	19
Media-card reader	19
Keyboard	19
Camera	20
Haptics touchpad	20
Power adapter	21
Battery	21
Display	22
Fingerprint reader	23
Sensor	23
GPU—Integrated	24
GPU—Discrete	24
Multiple display support matrix	24
Hardware security	24
Smart-card reader	25
Contactless smart-card reader	25
Contacted smart-card reader	28
Operating and storage environment	28
Dell support policy	29
ComfortView Plus	29
Dell Optimizer	29
<b>Chapter 4: Working inside your computer</b>	<b>31</b>

Safety instructions.....	31
Before working inside your computer.....	31
Safety precautions.....	32
Electrostatic discharge—ESD protection.....	32
ESD Field Service kit .....	33
Transporting sensitive components.....	34
After working inside your computer.....	34
BitLocker.....	34
Recommended tools.....	34
Screw list.....	35
Major components of Precision 5690.....	36

**Chapter 5: Removing and installing Customer Replaceable Units (CRUs)..... 39**

Secure Digital (SD) Card.....	39
Removing the SD card.....	39
Installing the SD card.....	40

**Chapter 6: Removing and installing Field Replaceable Units (FRUs)..... 42**

Base cover.....	42
Removing the base cover.....	42
Installing the base cover.....	45
Solid state drive (SSD).....	47
Removing the M.2 2230 solid state drive.....	47
Installing the M.2 2230 solid state drive.....	48
Removing the M.2 2280 solid state drive.....	50
Installing the M.2 2280 solid state drive.....	50
Battery.....	51
Rechargeable Li-ion battery precautions.....	51
Removing the battery.....	52
Installing the battery.....	54
System fan.....	56
Removing the processor fan.....	56
Installing the processor fan.....	56
Removing the graphics-card fan.....	57
Installing the graphics-card fan.....	58
Heat sink.....	59
Removing the heat sink for integrated graphics.....	59
Installing the heat sink for integrated graphics.....	60
Removing the heat sink for discrete graphics.....	61
Installing the heat sink for discrete graphics.....	62
Display assembly.....	63
Removing the display assembly.....	63
Installing the display assembly.....	66
SD-card daughterboard.....	70
Removing the SD-card daughterboard.....	70
Installing the SD-card daughterboard.....	72
USH and SD-card daughterboard.....	73
Removing the USH and SD-card daughterboard.....	73
Installing the USH and SD-card daughterboard.....	74

Smart-card reader daughterboard.....	75
Removing the smart-card reader daughterboard.....	75
Installing the smart-card reader daughterboard.....	77
Graphics card.....	79
Removing the graphics card.....	79
Installing the graphics card.....	81
Dummy graphics card.....	84
Removing the dummy graphics card.....	84
Installing the dummy graphics card.....	85
System board.....	86
Removing the system board.....	86
Installing the system board.....	93
Speakers.....	100
Removing the speakers.....	100
Installing the speakers.....	101
Haptics touchpad FPC.....	102
Removing the Haptics touchpad FPC.....	102
Installing the Haptics touchpad FPC.....	103
SD-card daughterboard FPC.....	105
Removing the SD-card daughterboard FPC.....	105
Installing the SD-card daughterboard FPC.....	105
USH and SD-card daughterboard FPC.....	106
Removing the USH and SD-card daughterboard FPC.....	106
Installing the USH and SD-card daughterboard FPC.....	107
Wireless Local Area Network (WLAN) Antennas.....	108
Removing the WLAN-antenna module.....	108
Installing the WLAN-antenna module.....	110
Power button with fingerprint reader assembly.....	112
Removing the power button with fingerprint reader assembly .....	112
Installing the power button with fingerprint reader assembly .....	113
Palm-rest assembly.....	114
Removing the palm-rest assembly.....	114
Installing the palm-rest assembly.....	115
<b>Chapter 7: Software.....</b>	<b>117</b>
Operating system.....	117
Drivers and downloads.....	117
<b>Chapter 8: BIOS Setup.....</b>	<b>118</b>
Entering BIOS setup program.....	118
Navigation keys.....	118
F12 One Time Boot menu.....	118
View Advanced Setup options.....	119
View Service options.....	119
System Setup options.....	119
Updating the BIOS.....	140
Updating the BIOS in Windows.....	140
Updating the BIOS in Linux and Ubuntu.....	140
Updating the BIOS using the USB drive in Windows.....	140

Updating the BIOS from the F12 One-Time boot menu.....	141
System and setup password.....	142
Assigning a System Setup password.....	142
Deleting or changing an existing system setup password.....	142
Clearing BIOS (System Setup) and System passwords.....	143
Clearing chassis intrusion alerts.....	143
<b>Chapter 9: Troubleshooting.....</b>	<b>146</b>
Handling swollen rechargeable Li-ion batteries.....	146
Locate the Service Tag or Express Service Code of your Dell computer .....	146
Dell SupportAssist Pre-boot System Performance Check diagnostics.....	147
Running the SupportAssist Pre-Boot System Performance Check.....	147
Built-in self-test (BIST).....	147
M-BIST.....	147
LCD Power rail test (L-BIST).....	148
LCD Built-in Self-Test (BIST).....	148
System-diagnostic lights.....	149
Recovering the operating system.....	151
Real-Time Clock (RTC Reset).....	151
Backup media and recovery options.....	151
Wi-Fi power cycle.....	151
Drain residual flea power (perform hard reset).....	151
<b>Chapter 10: Getting help and contacting Dell.....</b>	<b>153</b>

# Views of Precision 5690

## Right



Figure 1. Right view

### 1. SD-card slot (optional)

Reads from and writes to the SD card. The computer supports the following card types:

- Secure Digital (SD)
- Secure Digital High Capacity (SDHC)
- Secure Digital Extended Capacity (SDXC)

### 2. USB 3.2 Gen 2 Type-C port with DisplayPort Alt Mode

Connect devices such as external storage devices, printers, and external displays. Provides data transfer rate of up to 10 Gbps.

Supports DisplayPort 1.4 and also enables you to connect an external display using a display adapter.

### 3. Wedge-shaped lock slot

Connect a security cable to prevent unauthorized movement of your computer.

## Left



Figure 2. Left view

### 1. HDMI 2.1 port

Connect to a TV, external display, or another HDMI-in enabled device. Provides video and audio output.

### 2. Universal audio jack

Connect headphones or a headset (headphone and microphone combo).

### 3. Thunderbolt 4.0 (40 Gbps) port with Power Delivery

Supports USB4, DisplayPort 1.4, Thunderbolt 4 and also enables you to connect to an external display using a display adapter. Provides data transfer rates of up to 40 Gbps for USB4 and Thunderbolt 4.

**NOTE:** You can connect a Dell Docking Station to the Thunderbolt 4 ports. For more information, see the knowledge base article [000124295](https://www.dell.com/support) at [www.dell.com/support](https://www.dell.com/support).

**NOTE:** A USB Type-C to DisplayPort adapter (sold separately) is required to connect a DisplayPort device.

**NOTE:** USB4 is backward compatible with USB 3.2, USB 2.0, and Thunderbolt 3.

**NOTE:** Thunderbolt 4 supports two 4K displays or one 8K display.

#### 4. Smart-card reader slot (optional)

Provides physical electronic authorization for access control to the resources.

Supports both Contactless and Contacted Smart Cards.

Provides personal identification, authentication, data storage, and application processing.

## Top



Figure 3. Top view

#### 1. Microphones

Provide digital sound input for audio recording, voice calls, and so on.

#### 2. Power button with fingerprint reader

Press to turn on the computer if it is turned off, in sleep state, or in hibernate state.

When the computer is turned on, press the power button to put the computer into sleep state; press and hold the power button for ten seconds to force shut-down the computer.

If the power button has a fingerprint reader, place your finger on the power button to log in.





**Figure 4. Active fingerprint reader area**

**NOTE:** The highlighted area indicates the actual active fingerprint reader area and the image is for illustration purposes only.

**NOTE:** You can customize power-button behavior in Windows. For more information, see [www.dell.com/support/manuals](http://www.dell.com/support/manuals).

### 3. Haptics touchpad

Move your finger on the Haptics touchpad to move the mouse pointer. Tap to left-click and two fingers tap to right-click.

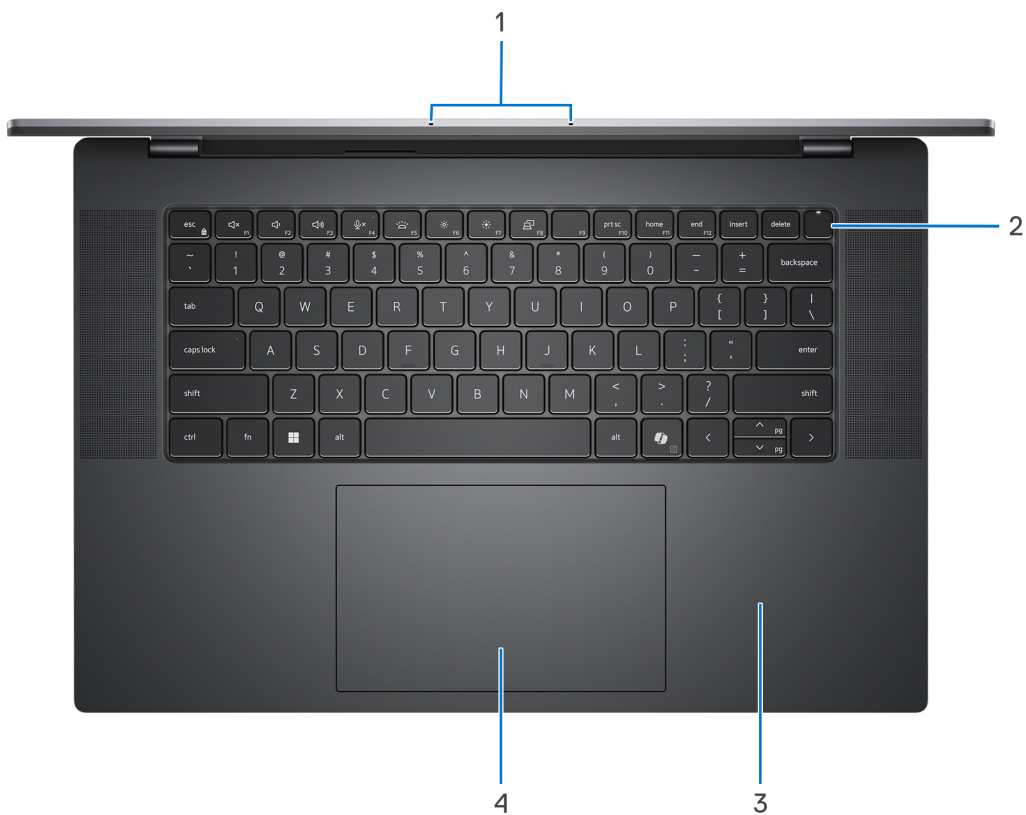

**Figure 5. Top view (computer shipped with optional NFC)**

#### 1. Microphones

Provide digital sound input for audio recording, voice calls, and so on.

#### 2. Power button with fingerprint reader

Press to turn on the computer if it is turned off, in sleep state, or in hibernate state.

When the computer is turned on, press the power button to put the computer into sleep state; press and hold the power button for ten seconds to force shut-down the computer.

If the power button has a fingerprint reader, place your finger on the power button to log in.

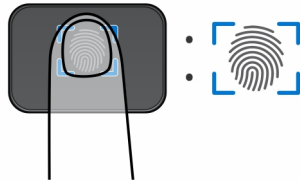

**Figure 6. Active fingerprint reader area**

**NOTE:** The highlighted area indicates the actual active fingerprint reader area and the image is for illustration purposes only.

**NOTE:** You can customize power-button behavior in Windows. For more information, see [www.dell.com/support/manuals](http://www.dell.com/support/manuals).

**3. NFC-sensor area**

Enables NFC-enabled devices to communicate with your computer.

**4. Haptics touchpad**

Move your finger on the Haptics touchpad to move the mouse pointer. Tap to left-click and two fingers tap to right-click.

## Front

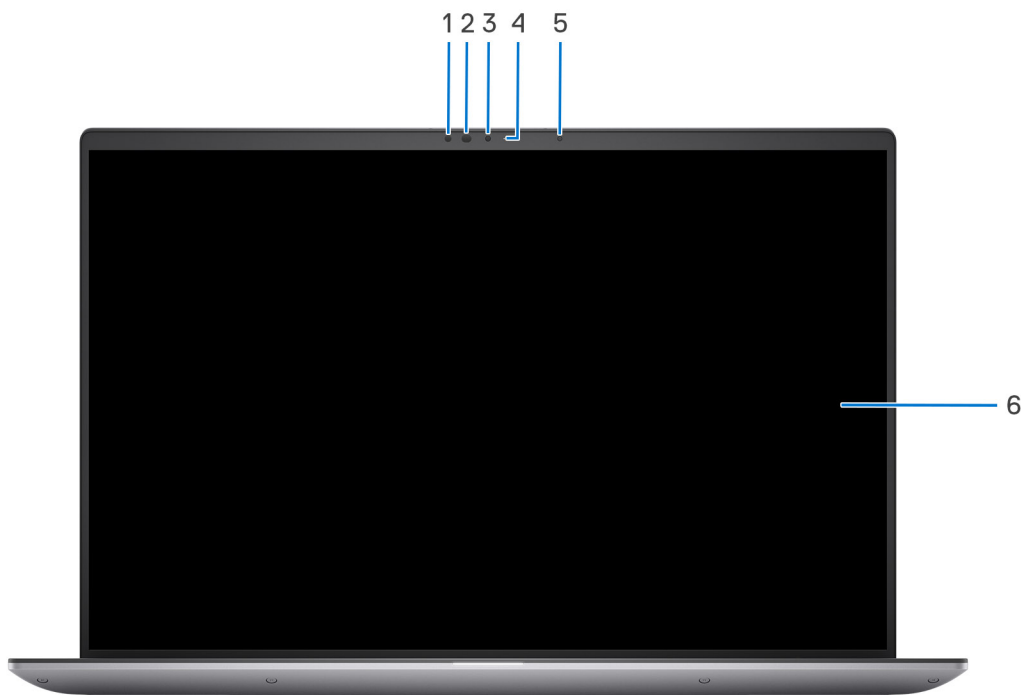

**Figure 7. Front view**

**1. IR sensor**

Provides digital sound input for audio recording and voice calls.

**2. Infrared LED**

Emits infrared light, which enables the infrared camera to sense and track motion.

### 3. Camera

Enables you to video chat, capture photos, and record videos.

### 4. Camera-status light

Turns on when the camera is in use.

### 5. Ambient-light sensor

The sensor detects the ambient light and automatically adjusts the keyboard backlight and display brightness.

### 6. Display

Provides visual output.

## Bottom

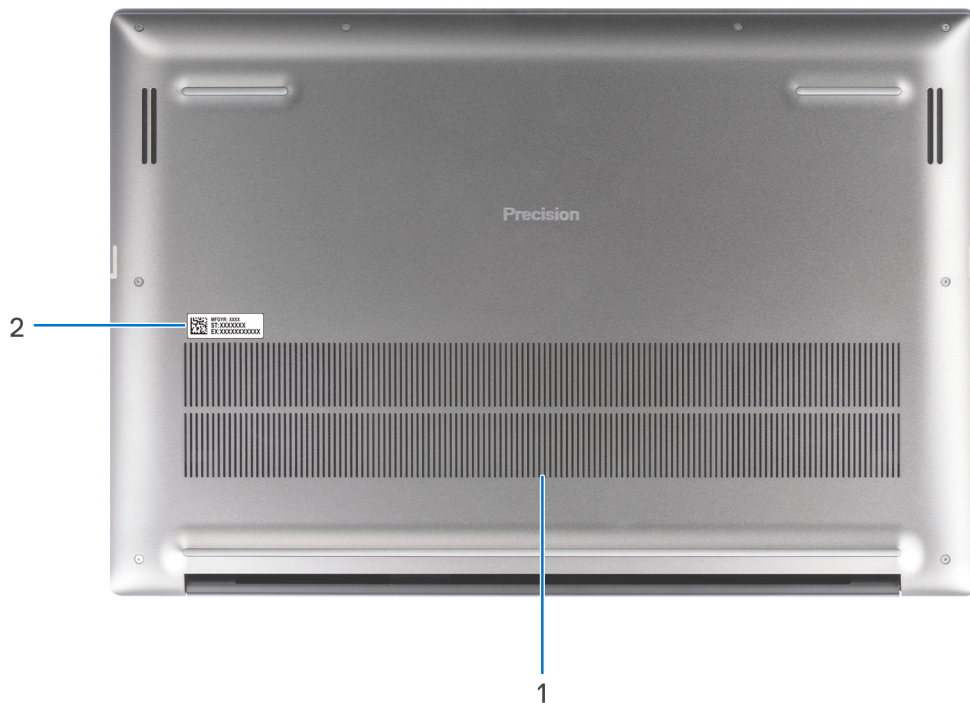

**Figure 8. Bottom view**

#### 1. Air vents

Air vents provide ventilation for your computer. Clogged air vents can cause overheating and can affect your computer performance and potentially cause hardware issues. Keep the air vents clear of obstructions and clean them regularly to prevent the build-up of dust and dirt. For more information about cleaning air vents, search for articles in the Knowledge Base Resource at [www.dell.com/support](http://www.dell.com/support).

#### 2. Service Tag label

The Service Tag is a unique alphanumeric identifier that enables Dell service technicians to identify the hardware components in your computer and access warranty information.

# Service Tag

The service tag is a unique alphanumeric identifier that allows Dell service technicians to identify the hardware components in your computer and access warranty information.



Figure 9. Service Tag

# Battery charge and status light

The following table lists the battery charge and status light behavior of your Precision 5690.

Table 1. Battery charge and status light behavior

Power Source	LED Behavior	System Power State	Battery Charge Level
AC Adapter	Off	S0 - S5	Fully Charged
AC Adapter	Solid White	S0 - S5	< Fully Charged
Battery	Off	S0 - S5	11-100%
Battery	Solid Amber (590+/-3 nm)	S0 - S5	< 10%

- S0 (ON) - System is turned on.
- S4 (Hibernate) - The system consumes the least power compared to all other sleep states. The system is almost at an OFF state, except for a trickle power. The context data is written to a hard drive.
- S5 (OFF) - The system is in a shutdown state.

# Set up your Precision 5690

## About this task

**NOTE:** The images in this document may differ from your computer depending on the configuration you ordered.

## Steps

1. Connect the power adapter and press the power button.



**Figure 10. Connecting the power adapter and press the power button.**

**NOTE:** The battery may go into power-saving mode during shipment to conserve charge on the battery. Ensure that the power adapter is connected to your computer when it is turned on for the first time.

2. Finish the operating system setup.

### For Ubuntu:

Follow the on-screen instructions to complete the setup. For more information about installing and configuring Ubuntu, search in the Knowledge Base Resource at [www.dell.com/support](http://www.dell.com/support).



### For Windows:

Follow the on-screen instructions to complete the setup. When setting up, Dell Technologies recommends that you:





- Connect to a network for Windows updates.
  - NOTE:** If connecting to a secured wireless network, enter the password for the wireless network access when prompted.
- If connected to the Internet, sign in with or create a Microsoft account. If not connected to the Internet, create an offline account.
- On the **Support and Protection** screen, enter your contact details.

3. Locate and use Dell apps from the Windows Start menu—Recommended.

**Table 2. Locate Dell apps in Windows in S-mode**

Resources	Description
	<p><b>Dell Product Registration</b></p> <p>Register your computer with Dell.</p>
	<p><b>Dell Help &amp; Support</b></p> <p>Access help and support for your computer.</p>
	<p><b>SupportAssist</b></p> <p>SupportAssist proactively and predictively identifies hardware and software issues on your computer and automates the engagement process with Dell Technical support. It addresses performance and stabilization issues, prevents security threats, monitors, and detects hardware failures. For more information, see <i>SupportAssist for Home PCs User's Guide</i> at <a href="http://www.dell.com/support/home/product-support/product/dell-supportassist-pcs-tablets/docs">www.dell.com/support/home/product-support/product/dell-supportassist-pcs-tablets/docs</a>.</p> <p><b>NOTE:</b> In SupportAssist, click the warranty expiry date to renew or upgrade your warranty.</p>

**Table 3. Locate Dell apps in Windows**

Resources	Description
	<p><b>My Dell</b></p> <p>MyDell is a software application that offers you a single streamlined engagement platform including account access, device information, and hardware settings. This software delivers intelligent features that automatically fine-tune your computer for the best possible audio, power, and performance. Get the most out of your Dell device with intelligent, personalized technology from MyDell. Following are the key features of MyDell:</p> <ul style="list-style-type: none"> <li>• Application</li> <li>• Audio</li> <li>• Power</li> <li>• Color and Display</li> <li>• Presence detection</li> </ul> <p>For more information about how to use MyDell, see product guides at <a href="http://www.dell.com/support">www.dell.com/support</a>.</p>
	<p><b>Dell Update</b></p> <p>Updates your computer with critical fixes and latest device drivers as they become available. For more information about using Dell Update, see the product guides and third-party license documents at <a href="http://www.dell.com/support">www.dell.com/support</a>.</p>
	<p><b>Dell Digital Delivery</b></p> <p>Download software applications, which are purchased but not preinstalled on your computer. For more information about using Dell Digital Delivery, search in the Knowledge Base Resource at <a href="http://www.dell.com/support">www.dell.com/support</a>.</p>
	<p><b>SupportAssist</b></p> <p>SupportAssist proactively and predictively identifies hardware and software issues on your computer and automates the engagement process with Dell Technical support. It addresses performance and stabilization issues, prevents security threats, monitors, and detects hardware failures. For more information, see <i>SupportAssist for Home PCs User's Guide</i> at <a href="http://www.dell.com/support/home/product-support/product/dell-supportassist-pcs-tablets/docs">www.dell.com/support/home/product-support/product/dell-supportassist-pcs-tablets/docs</a>.</p> <p><b>NOTE:</b> In SupportAssist, click the warranty expiry date to renew or upgrade your warranty.</p>

# Specifications of Precision 5690

## Dimensions and weight

The following table lists the height, width, depth, and weight of your Precision 5690.

**Table 4. Dimensions and weight**

Description	Values
Height:	
Front height	20.50 mm (0.80 in.)
Rear height	22.17 mm (0.87 in.)
Width	353.68 mm (13.92 in.)
Depth	240.33 mm (9.46 in.)
Weight  <b>NOTE:</b> The weight of your computer depends on the configuration that is ordered and manufacturing variability.	2.17 kg (4.80 lb)

## Processor

The following table lists the details of the processors that are supported for your Precision 5690.

**Table 5. Processor**

Description	Option one	Option two	Option three	Option four
Processor type	Intel Core Ultra 5 135H vPro	Intel Core Ultra 7 155H vPro Essentials	Intel Core Ultra 7 165H vPro	Intel Core Ultra 9 185H vPro
Processor wattage	45 W	45 W	45 W	45 W
Processor core count	14	16	16	16
Processor thread count	18	22	22	22
Processor speed	Up to 3.20 GHz	Up to 3.0 GHz	Up to 3.10 GHz	Up to 3.10 GHz
Processor cache	18 MB	24 MB	24 MB	24 MB
Integrated graphics	Intel Arc Graphics	Intel Arc Graphics	Intel Arc Graphics	Intel Arc Graphics

# Chipset

The following table lists the details of the chipset that is supported for your Precision 5690.

**Table 6. Chipset**

Description	Values
Chipset	Intel MTL-H
Processor	<ul style="list-style-type: none"><li>• Intel Core Ultra 5 135H vPro</li><li>• Intel Core Ultra 7 155H vPro Essentials</li><li>• Intel Core Ultra 7 165H vPro</li><li>• Intel Core Ultra 9 185H vPro</li></ul>
DRAM bus width	128-bit
Flash EPROM	64 MB
PCIe bus	Up to Gen 4.0

# Operating system

Your Precision 5690 supports the following operating systems:

- Windows 11 Home
- Windows 11 Pro
- Windows 11 Pro for Workstation
- Windows 11 Pro for Education
- Windows 11 Enterprise
- Ubuntu Linux 22.04 LTS, 64-bit
- Red Hat Linux 9.4

# Memory

The following table lists the memory specifications of your Precision 5690.

**Table 7. Memory specifications**

Description	Values
Memory slots	Integrated on system board  <b>NOTE:</b> The memory is not replaceable or upgradeable. If memory has error, the system board must be replaced.
Memory type	Dual-channel LPDDR5x
Memory speed	7467 MT/s
Maximum memory configuration	64 GB
Minimum memory configuration	16 GB
Memory size per slot	16 GB, 32 GB, 64 GB
Memory configurations supported	<ul style="list-style-type: none"><li>• 16 GB, LPDDR5x, 7467 MT/s, dual-channel (onboard)</li><li>• 32 GB, LPDDR5x, 7467 MT/s, dual-channel (onboard)</li></ul>



**Table 7. Memory specifications (continued)**

Description	Values
	<ul style="list-style-type: none"><li>64 GB, LPDDR5x, 7467 MT/s, dual-channel (onboard)</li></ul>

## External ports

The following table lists the external ports on your Precision 5690.

**Table 8. External ports**

Description	Values
USB ports	<ul style="list-style-type: none"><li>One USB 3.2 Gen 2 Type-C port with DisplayPort 1.4 Alt Mode</li><li>Two Thunderbolt 4 (40 Gbps) ports with Power Delivery</li></ul>
Audio port	One universal audio port
Video port/ports	<ul style="list-style-type: none"><li>One USB 3.2 Gen 2 Type-C port with DisplayPort 1.4 Alt Mode</li><li>Two Thunderbolt 4 (40 Gbps) ports with Power Delivery</li><li>One HDMI 2.1 port</li></ul>
Media-card reader	One SD-card slot (optional)
Power-adaptor port	Two Thunderbolt 4 (40 Gbps) port with Power Delivery
Security-cable slot	One wedge-shaped lock slot

## Internal slots

The following table lists the internal slots of your Precision 5690.

**Table 9. Internal slots**

Description	Values
M.2	<ul style="list-style-type: none"><li>Two M.2 2230/2280 for solid state drive</li></ul> <p> <b>NOTE:</b> To learn more about the features of different types of M.2 cards, search in the Knowledge Base Resource at <a href="http://www.dell.com/support">www.dell.com/support</a>.</p>

## Wireless module

The following table lists the Wireless Local Area Network (WLAN) module that is supported on your Precision 5690.

**Table 10. Wireless module specifications**

Description	Values
Model number	Intel BE200
Transfer rate	Up to 5760 Mbps
Frequency bands supported	2.4 GHz/5 GHz/6 GHz

**Table 10. Wireless module specifications (continued)**

Description	Values
Wireless standards	<ul style="list-style-type: none"> <li>• Wi-Fi 802.11a/b/g</li> <li>• Wi-Fi 4 (WiFi 802.11n)</li> <li>• Wi-Fi 5 (WiFi 802.11ac)</li> <li>• Wi-Fi 6E (WiFi 802.11ax)</li> <li>• Wi-Fi 7 (WiFi 802.11be)</li> </ul>
Encryption	<ul style="list-style-type: none"> <li>• 64-bit/128-bit WEP</li> <li>• AES-CCMP</li> <li>• TKIP</li> </ul>
Bluetooth wireless card	Bluetooth 5.4 wireless card
	<p><b>i</b> <b>NOTE:</b> The version of the Bluetooth wireless card may vary depending on the operating system that is installed on your computer.</p>

## Audio

The following table lists the audio specifications of your Precision 5690.

**Table 11. Audio specifications**

Description	Values
Audio controller	Waves MaxxAudio 13
Stereo conversion	Supported
Internal audio interface	High definition audio interface
External audio interface	One universal audio port
Number of speakers	<ul style="list-style-type: none"> <li>• 2 x Woofers</li> <li>• 2 x Tweeters</li> </ul>
Internal-speaker amplifier	Supported
External volume controls	Keyboard shortcut controls
Speaker output:	
	Average speaker output
	<ul style="list-style-type: none"> <li>• Woofer: 2 x 2 W</li> <li>• Tweeters: 2 x 2 W</li> </ul>
	Peak speaker output
	<ul style="list-style-type: none"> <li>• Woofer: 2 x 2.5 W</li> <li>• Tweeters: 2 x 2.5 W</li> </ul>
Subwoofer output	Supported
Microphone	Dual-array microphones in camera assembly

# Storage

This section lists the storage options on your Precision 5690.

Your Precision 5690 supports one of the following storage configurations:

**Table 12. Storage specifications**

Storage type	Interface type	Capacity
M.2 2230, Class 35 solid state drive	PCIe NVMe Gen 4	256 GB
M.2 2280, Class 40 solid state drive	PCIe NVMe Gen 4	512 GB/1 TB/2 TB/4 TB
M.2 2280, Class 40 Self-Encrypting Opal 2.0 solid state drive	PCIe NVMe Gen 4	512 GB/1 TB

# Media-card reader

The following table lists the media cards that are supported on your Precision 5690.

**Table 13. Media-card reader specifications**

Description	Values
Media-card type	One SD-card slot (optional)
Media-cards supported	<ul style="list-style-type: none"><li>Secure Digital (SD)</li><li>Secure Digital High Capacity (SDHC)</li><li>Secure Digital Extended Capacity (SDXC)</li></ul>
 <b>NOTE:</b> The maximum capacity supported by the media-card reader varies depending on the standard of the media card that is installed on your computer.	

# Keyboard

The following table lists the keyboard specifications of your Precision 5690.

**Table 14. Keyboard specifications**

Description	Values
Keyboard type	AI hotkey backlit keyboard
Keyboard layout	QWERTY
Number of keys	<ul style="list-style-type: none"><li>United States and Canada: 79 keys</li><li>United Kingdom: 80 keys</li><li>Japan: 83 keys</li></ul>
Keyboard size	19.05 mm 18.05 mm
Keyboard shortcuts	Some keys on your keyboard have two symbols on them. These keys can be used to type alternate characters or to perform secondary functions. To type the alternate character, press Shift and the desired key. To perform secondary functions, press Fn and the desired key.

**Table 14. Keyboard specifications (continued)**

Description	Values
	 <b>NOTE:</b> You can define the primary behavior of the function keys (F1–F12) changing <b>Function Key Behavior</b> in BIOS setup program.

## Camera

The following table lists the camera specifications of your Precision 5690.

**Table 15. Camera specifications**

Description	Values
Number of cameras	One
Camera type	FHD RGB + IR camera with HDR technology
Camera location	Front camera
Camera sensor type	CMOS sensor technology
Camera resolution:	
Still image	2.07 megapixel
Video	1920 x 1080 FHD at 30 fps
Infrared camera resolution:	
Still image	0.23 megapixel
Video	640 x 360 at 15 fps
Diagonal viewing angle:	
Camera	80 degrees
Infrared camera	80.6 degrees

## Haptics touchpad

The following table lists the touchpad specifications of your Precision 5690.

**Table 16. Touchpad specifications**

Description	Values
Touchpad resolution:	300 dpi
Touchpad dimensions:	
Horizontal	136 mm (5.35 inch)
Vertical	85 mm (3.34 inch)
Touchpad gestures	For more information about touchpad gestures available on Windows, see the Microsoft knowledge base article at <a href="https://support.microsoft.com">support.microsoft.com</a> .

# Power adapter

The following table lists the power adapter specifications of your Precision 5690.

**Table 17. Power adapter specifications**

Description	Option one	Option two
Type	100 W AC Adapter, USB Type-C	165 W AC adapter, USB Type-C
Input voltage	100 VAC - 240 VAC	100 VAC - 240 VAC
Input frequency	50 Hz - 60 Hz	50 Hz - 60 Hz
Input current (maximum)	1.70 A	2.20 A
Output current (continuous)	<ul style="list-style-type: none"> <li>• 20 V/5 A</li> <li>• 15 V/3 A</li> <li>• 9 V/3 A</li> <li>• 5 V/3 A</li> </ul>	<ul style="list-style-type: none"> <li>• 28 V/5.89 A</li> <li>• 20 V/6.50 A</li> <li>• 15 V/3 A</li> <li>• 9 V/3 A</li> <li>• 5 V/3 A</li> </ul>
Rated output voltage	5 VDC/9 VDC/15 VDC/20 VDC	5 VDC/9 VDC/15 VDC/20 VDC/28 VDC
Temperature range:		
Operating	0 °C to 40 °C (32 °F to 104 °F)	0 °C to 40 °C (32 °F to 104 °F)
Storage	-40 °C to 70 °C (-40 °F 158 °F)	-40 °C to 70 °C (-40 °F 158 °F)
 <b>CAUTION: Operating and storage temperature ranges may differ among components, so operating or storing the device outside these ranges may impact the performance of specific components.</b>		

# Battery

The following table lists the battery specifications of your Precision 5690.

**Table 18. Battery specifications**

Description	Option one	Option two
Battery type	6-cell 99.5 Whr lithium-ion battery	6-cell 99.5 Whr lithium-ion LcL battery
Battery voltage	11.55 VDC (Nominal)	11.55 VDC (Nominal)
Battery weight (maximum)	0.363 kg (0.8 lb)	0.363 kg (0.8 lb)
Battery dimensions:		
Height	7.66 mm (0.30 inch)	7.66 mm (0.30 inch)
Width	289 mm (11.38 inch)	289 mm (11.38 inch)
Depth	84.4 mm (3.32 inch)	85.4 mm (3.32 inch)
Temperature range:		
Operating	<ul style="list-style-type: none"> <li>• Charge: 0°C to 50°C (32°F to 122°F)</li> </ul>	<ul style="list-style-type: none"> <li>• Charge: 0°C to 50°C (32°F to 122°F)</li> <li>• Discharge: 0°C to 60°C (32°F to 140°F)</li> </ul>

**Table 18. Battery specifications (continued)**

Description		Option one	Option two
		<ul style="list-style-type: none"> <li>Discharge: 0°C to 60°C (32°F to 140°F)</li> </ul>	
	Storage	-20°C to 65°C (-4°F to 149°F)	-20°C to 65°C (-4°F to 149°F)
Battery operating time		Varies depending on operating conditions and can significantly reduce under certain power-intensive conditions.	Varies depending on operating conditions and can significantly reduce under certain power-intensive conditions.
Battery charging time (approximate) ⓘ <b>NOTE:</b> Control the charging time, duration, start and end time, and so on, using the Dell Power Manager application. For more information about Dell Power Manager, search in the Knowledge Base Resource at <a href="http://www.dell.com/support">www.dell.com/support</a> .		<ul style="list-style-type: none"> <li>2 hours (Express charge)</li> <li>3 hours (Standard charge)</li> </ul>	<ul style="list-style-type: none"> <li>2 hours (Express charge)</li> <li>3 hours (Standard charge)</li> </ul>
Coin-cell battery		No	No
<p>⚠ <b>CAUTION:</b> Operating and storage temperature ranges may differ among components, so operating or storing the device outside these ranges may impact the performance of specific components.</p> <p>⚠ <b>CAUTION:</b> Dell Technologies recommends that you charge the battery regularly for optimal power consumption. If your battery charge is depleted, connect the power adapter, turn on your computer, and then restart your computer to reduce the power consumption.</p>			

## Display

The following table lists the display specifications of your Precision 5690.

**Table 19. Display specifications**

Description		Option one	Option two
Display type		16" Full High-Definition Plus (FHD+)	16" Ultra High-Definition Plus (UHD+)
Touch options		No	Yes
Display-panel technology		IPS (In-plane switching)	OLED
Display-panel dimensions (active area):			
	Height	22.17 mm (0.87 in.)	22.17 mm (0.87 in.)
	Width	344.68 mm (13.57 in.)	344.45 mm (13.56 in.)
	Diagonal	406.40 mm (16 in.)	406.40 mm (16 in.)
Display-panel native resolution		1920 x 1200	3840 x 2400
Luminance (typical)		500 nits	400 nits
Megapixels		2.3	9.2
Color gamut		100% DCI-P3	100% DCI-P3

**Table 19. Display specifications (continued)**

Description	Option one	Option two
Pixels Per Inch (PPI)	142	283
Contrast ratio (minimum)	1300:1	100000:1
Response time (maximum)	30 ms	1 ms typical
Refresh rate	60 Hz	60 Hz
Horizontal view angle	+/- 85 degrees	+/- 85 degrees typical
Vertical view angle	+/- 85 degrees	+/- 85 degrees typical
Pixel pitch	0.18 mm	0.09 mm
Power consumption (maximum)	6.32 W	11.14 W
Anti-glare vs glossy finish	Anti-glare	Anti-smudge

## Fingerprint reader

The following table lists the fingerprint-reader specifications of your Precision 5690.

 **NOTE:** The fingerprint reader is on the power button.

**Table 20. Fingerprint reader specifications**

Description	Values
Fingerprint-reader sensor technology	Capacitive
Fingerprint-reader sensor resolution	500 dpi
Fingerprint-reader sensor pixel size	108 x 88

## Sensor

The following table lists the sensor of your Precision 5690.

**Table 21. Sensor**

Sensor support
Accelerometer for adaptive thermal
Ambient light sensor
Windows auto-brightness
IR proximity sensor
Gyro + Accelerometer
Hall effect sensor
Sensor hub

## GPU—Integrated

The following table lists the specifications of the integrated Graphics Processing Unit (GPU) supported by your Precision 5690.

**Table 22. GPU—Integrated**

Controller	Memory size	Processor
Intel Arc Graphics	Shared system memory	<ul style="list-style-type: none"> <li>• Intel Core Ultra 5 135H vPro</li> <li>• Intel Core Ultra 7 155H vPro Essentials</li> <li>• Intel Core Ultra 7 165H vPro</li> <li>• Intel Core Ultra 9 185H vPro</li> </ul>

## GPU—Discrete

The following table lists the specifications of the discrete Graphics Processing Unit (GPU) supported by your Precision 5690.

**Table 23. GPU—Discrete**

Controller	Memory size
NVIDIA RTX 1000 Ada Generation Laptop GPU	6 GB
NVIDIA RTX 2000 Ada Generation Laptop GPU	8 GB
NVIDIA RTX 3500 Ada Generation Laptop GPU	12 GB
NVIDIA RTX 4000 Ada Generation Laptop GPU	12 GB
NVIDIA RTX 5000 Ada Generation Laptop GPU	16 GB

## Multiple display support matrix

The following table lists the multiple display support matrix for your Precision 5690.

**Table 24. Multiple display support matrix**

Graphics Card	Supported external displays
Intel Arc Graphics	Yes, supported on USB Type-C, Thunderbolt, and HDMI port.
NVIDIA RTX 1000 Ada Generation Laptop GPU	Yes, supported on the right side USB Type-C port only.
NVIDIA RTX 2000 Ada Generation Laptop GPU	Yes, supported on the right side USB Type-C port only.
NVIDIA RTX 3500 Ada Generation Laptop GPU	Yes, supported on the right side USB Type-C port only.
NVIDIA RTX 4000 Ada Generation Laptop GPU	Yes, supported on the right side USB Type-C port only.
NVIDIA RTX 5000 Ada Generation Laptop GPU	Yes, supported on the right side USB Type-C port only.

## Hardware security

The following table lists the hardware security of your Precision 5690.

**Table 25. Hardware security**

Hardware security
Wedge-shaped lock slot
Chassis Intrusion Prevention Lock



**Table 25. Hardware security (continued)**

<b>Hardware security</b>
Hardware TPM 2.0 discrete
FIPS 140-2 certification for TPM
TCG Certification for TPM (Trusted Computing Group)
ControlVault 3+ Advanced Authentication with FIPS 140-2 Level 3 Certification
Fingerprint Reader
Contacted Smart Card and ControlVault 3 or 3+
Contactless Smart Card, NFC, and ControlVault 3 or 3+
SED SSD NVMe (Opal 2.0)
Statement of Non-Volatility
Chassis Intrusion Detection
Battery Removal Detection
RPMC (specify through SPI Flash or eRPMC)
SPI Flash Tamper Detection/Prevention Shunt Circuit
Board Level Shield Tamper Detection

## Smart-card reader

### Contactless smart-card reader

This section lists the contactless smart-card reader specifications of your Precision 5690. This module is only available in computers shipped with Smart-card readers.

**Table 26. Contactless smart-card reader specifications**

<b>Title</b>	<b>Description</b>	<b>Dell ControlVault 3 contactless smart-card reader with NFC</b>
Felica Card Support	Reader and software capable of supporting Felica contactless cards	Yes
Prox (Proximity) (125kHz) Card support	Reader and software capable of supporting Prox /Proximity/125kHz contactless cards	No
ISO 14443 Type A Card Support	Reader and software capable of supporting ISO 14443 Type A contactless cards	Yes
ISO 14443 Type B Card Support	Reader and software capable of supporting ISO 14443 Type B contactless cards	Yes
ISO/IEC 21481	Reader and software capable of supporting ISO/IEC 21481 compliant contactless cards and tokens	Yes
ISO/IEC 18092	Reader and software capable of supporting ISO/IEC 21481 compliant contactless cards and tokens	Yes
ISO 15693 Card Support	Reader and software capable of supporting ISO15693 contactless cards	Yes

**Table 26. Contactless smart-card reader specifications (continued)**

<b>Title</b>	<b>Description</b>	<b>Dell ControlVault 3 contactless smart-card reader with NFC</b>
NFC Tag Support	Supports reading and processing of NFC compliant tag information	Yes
NFC Reader Mode	Support for NFC Forum Defined Reader mode	Yes
NFC Writer Mode	Support for NFC Forum Defined Writer mode	Yes
NFC Peer-to-Peer Mode	Support for NFC Forum Defined Peer to Peer mode	Yes
NFC Proximity OS Interface	Enumerates NFP (Near Field Proximity) device for OS to utilize	Yes
PC/SC OS interface	Personal Computer/Smart Card specification for integration of hardware readers into personal computer environments	Yes
CCID driver compliance	Common driver support for Integrated Circuit Card Interface Device for OS level drivers	Yes
Dell ControlVault support	Device connects to Dell ControlVault for usage and processing	Yes

 **NOTE:** 125 Khz proximity cards are not supported.

**Table 27. Supported cards**

<b>Manufacturer</b>	<b>Card</b>
HID	jCOP readertest3 A card (14443a)
	1430 1L
	DESFire D8H
	DESFIRE 4K Standard - 1450NGGNN
	iClass 16K/16 - 2002PGGMN
	iClass SR 16K/16 - 2002HPGGMN
	iCLASS 2K tag
	iCLASS GP - 2003 PGGMN
	iClass Clamshell - 2080PMSMV
	iClass Prox 16K/16 - 2022BGGMNN
	Mifare M1P 1430 NGGNN
	iclass Prox 2020BGGMNM
	DesFire D8P 1456CSGMN
	iCLASS MIFARE Px GM49Y 2623BNPGBNAB
	iCLASS MIFARE Px 8M1L
	iClass SEOS JW 5006PGGMN
	Crescendo iCLASS Px G8H
iCLASS Seos IY	

**Table 27. Supported cards (continued)**

Manufacturer	Card
	SEOS JMC4 J1Y 5806VNG1NNN4
	SEOS Key FOB 5266PNNA
	SEOS Clamshell 5656PMSAV
	SEOS + Prox 5106RGGMNN
	SEOS + DESFire 5906PNG1ANN7
	SEOS iClass 5006PGGMN7
	Seos Essential + Prox 551PPGGANN
	iCLASS 2K 2000PGGMN
	iCLASS 2K 3000PGGMN
	MIFARE DESFire 3700CPGGAN
	iCLASS DP
	DESFire 1Y
	Mifare DESFire 8K White PVC Cards
	Mifare Classic 1K White PVC Cards
	Mifare Mifare S50 ISO Cards
	Mifare DESFire 2K
	Mifare Plus S 2K/4K
	Mifare Plus X 4K
	idOnDemand - SCE3.2 144K
	SCE6.0 FIPS 80K Dual+ 1 K Mifare
	SCE6.0 nonFIPS 80K Dual+ 1 K Mifare
	SCE6.0 FIPS 144K Dual + 1K Mifare
	SCE6.0 nonFIPS 144K Dual + 1 K Mifare
	SCE7.0 FIPS 144K
	idOnDemand - OCS5.2 80K
	ID-One Cosmo 64 RSA D V5.4 T=0 card
	ID-One Cosmo 128K V5.5 card
	TOP DL GX4 144K card
	Felica RC-S962
	Felica RC-S965
	Felica RC-S966
	C910 PKI
	PIV1
	PIV programmed cards
	uTrust
	Oyster (London) MIFARE DESFire
	T-Money (Korea)

**Table 27. Supported cards (continued)**

Manufacturer	Card
	Octopus Card (Hong Kong)
	SUICA (Japan)

## Contacted smart-card reader

The following table lists the contacted smart-card reader specifications of your Precision 5690.

**Table 28. Contacted smart-card reader specifications**

Title	Description	Dell ControlVault 3 smart-card reader
ISO 7816 -3 Class A Card Support	Reader capable of reading 5V powered smart mcard	Yes
ISO 7816 -3 Class B Card Support	Reader capable of reading 3V powered smart card	Yes
ISO 7816 -3 Class C Card support	Reader capable of reading 1.8V powered smart card	Yes
ISO 7816-1 Compliant	Specification for the reader	Yes
ISO 7816 -2 Compliant	Specification for smart card device physical characteristics (size, location of connection points, etc.)	Yes
ISO 7816-3 Compliant	Specification for electrical interface and transmission protocols	Yes
ISO 7816-4 Compliant	Specification for organization, security and commands for interchange	Yes
Dell ControlVault support	Device connects to Dell ControlVault for usage and processing	Yes
T=0 support	Cards support character level transmission	Yes
T=1 support	Cards support block level transmission	Yes
EMVCo Certified	Formally certified based on EMVCO smart card standards	Yes
PC/SC OS interface	Personal Computer/Smart Card specification for integration of hardware readers into personal computer environments	Yes
CCID driver compliance	Common driver support for Integrated Circuit Card Interface Device for OS level drivers.	Yes
Windows Certified	Device certified by WHCK	Yes
FIPS 201 (PIV/HSPD-12) Compliant via GSA	Device compliant with FIPS 201/PIV/HSPD-12 requirements	Yes

## Operating and storage environment

This table lists the operating and storage specifications of your Precision 5690.

**Airborne contaminant level:** G1 as defined by ISA-S71.04-1985

**Table 29. Computer environment**

Description	Operating	Storage
Temperature range	0°C to 35°C (32°F to 95°F)	-40°C to 65°C (-40°F to 149°F)
Relative humidity (maximum)	10% to 90% (non-condensing)	0% to 95% (non-condensing)
Vibration (maximum)*	0.66 GRMS	1.30 GRMS
Shock (maximum)	110 G†	160 G†
Altitude range	-15.2 m to 3048 m (-49.87 ft to 10000 ft)	-15.2 m to 10668 m (-49.87 ft to 35000 ft)
 <b>CAUTION: Operating and storage temperature ranges may differ among components, so operating or storing the device outside these ranges may impact the performance of specific components.</b>		

\* Measured using a random vibration spectrum that simulates the user environment.

† Measured using a 2 ms half-sine pulse.

## Dell support policy

For information about Dell support policy, search in the Knowledge Base Resource at [www.dell.com/support](http://www.dell.com/support).

## ComfortView Plus

 **WARNING: Prolonged exposure to blue light from the display may lead to long-term effects such as eye strain, eye fatigue, or damage to the eyes.**

Blue light is a color in the light spectrum which has a short wavelength and high energy. Chronic exposure to blue light, particularly from digital sources, may disrupt sleep patterns and cause long-term effects such as eye strain, eye fatigue, or damage to the eyes.

The display on this computer is designed to minimize blue light and complies with TÜV Rheinland's requirement for low blue light displays.

Low blue light mode is enabled at the factory, so no further configuration is necessary.

To reduce the risk of eye strain, it is also recommended that you:

- Position the display at a comfortable viewing distance between 20 and 28 inches (50 cm and 70 cm) from your eyes.
- Blink frequently to moisten your eyes, wet your eyes with water, or apply suitable eye drops.
- Look away from your display, and gaze at a distant object at 20 ft (609.60 cm) away for at least 20 seconds during each break.
- Take an extended break for 20 minutes every two hours.

## Dell Optimizer

This section details the Dell Optimizer specifications of your Precision 5690.

Dell Optimizer is a software application that intelligently optimizes the performance of your computer by using artificial intelligence and machine learning. Dell Optimizer dynamically configures your computer settings to optimize the performance of your applications. It improves the productivity, performance, and user experience through computer usage analysis and learning.

On Precision 5690 with Dell Optimizer, the following features are supported:

- Improves user experience through computer usage analysis and learning
- Faster application launch and seamless application transition
- Intelligent battery run-time extension











- Optimized Audio for best meeting experience
- Locks computer when walks away for enhanced security
- Faster computer wake-on-user approach
- Intelligently shows alerts
- Updates automatically to minimize disruption

For more information about configuring and using these features, search for the Dell Optimizer User Guide at [www.dell.com/support](http://www.dell.com/support).

# Working inside your computer



## Safety instructions

Use the following safety guidelines to protect your computer from potential damage and to ensure your personal safety. Unless otherwise noted, each procedure in this document assumes that you have read the safety information that shipped with your computer.

-  **WARNING:** Before working inside your computer, read the safety information that is shipped with your computer. For more safety best practices, see the Regulatory Compliance home page at [www.dell.com/regulatory\\_compliance](http://www.dell.com/regulatory_compliance).
-  **WARNING:** Disconnect your computer from all power sources before opening the computer cover or panels. After you finish working inside the computer, replace all covers, panels, and screws before connecting your computer to an electrical outlet.
-  **CAUTION:** To avoid damaging the computer, ensure that the work surface is flat, dry, and clean.
-  **CAUTION:** To avoid damaging the components and cards, handle them by their edges, and avoid touching the pins and the contacts.
-  **CAUTION:** You should only perform troubleshooting and repairs as authorized or directed by the Dell technical assistance team. Damage due to servicing that is not authorized by Dell is not covered by your warranty. See the safety instructions that is shipped with the product or at [www.dell.com/regulatory\\_compliance](http://www.dell.com/regulatory_compliance).
-  **CAUTION:** Before touching anything inside your computer, ground yourself by touching an unpainted metal surface, such as the metal at the back of the computer. While you work, periodically touch an unpainted metal surface to dissipate static electricity which could harm internal components.
-  **CAUTION:** When you disconnect a cable, pull it by its connector or its pull tab, not the cable itself. Some cables have connectors with locking tabs or thumbscrews that you must disengage before disconnecting the cable. When disconnecting cables, keep them evenly aligned to avoid bending the connector pins. When connecting cables, ensure that the ports and the connectors are correctly oriented and aligned.
-  **CAUTION:** Press and eject any installed card from the media-card reader.
-  **CAUTION:** Exercise caution when handling rechargeable Li-ion batteries in laptops. Swollen batteries should not be used and should be replaced and disposed properly.
-  **NOTE:** The color of your computer and certain components may differ from what is shown in this document.

## Before working inside your computer

### Steps

1. Save and close all open files and exit all open applications.
2. Shut down your computer. For Windows operating system, click **Start** >  **Power** > **Shut down**.
  -  **NOTE:** If you are using a different operating system, see the documentation of your operating system for shut-down instructions.
3. Disconnect your computer and all attached devices from their electrical outlets.
4. Disconnect all attached network devices and peripherals, such as keyboard, mouse, and monitor from your computer.

5. Remove any media card and optical disk from your computer, if applicable.
6. Enter the service mode, if you can turn on your computer.

### Service Mode

Service Mode is used to cut off power, without disconnecting the battery cable from the system board prior to conducting repairs in the computer.

 **CAUTION:** If you are unable to turn on the computer to put it into Service Mode, or the computer does not support Service Mode, proceed to disconnect the battery cable. To disconnect the battery cable, follow the steps in [Removing the battery](#).

 **NOTE:** Ensure that your computer is shut down and the AC adapter is disconnected.

- a. Hold the **<B>** key on the keyboard and press the power button for 3 seconds or until the Dell logo appears on the screen.
- b. Press any key to continue.
- c. If the AC adapter is not disconnected, a message prompting you to remove the AC adapter appears on the screen. Remove the AC adapter and then press any key to continue the **Service Mode** process. The **Service Mode** process automatically skips the following step if the **Owner Tag** of the computer is not set up in advance by the user.
- d. When the **ready-to-proceed** message appears on the screen, press any key to proceed. The computer emits three short beeps and shuts down immediately.
- e. Once the computer shuts down, it has successfully entered Service Mode.

 **NOTE:** If you are unable to turn on your computer or unable to enter Service Mode, skip this process.

## Safety precautions

The safety precautions chapter details the primary steps to be taken before performing any disassembly instructions.

Observe the following safety precautions before you perform any installation or break-fix procedures involving disassembly or reassembly:

- Turn off the computer and all attached peripherals.
- Disconnect the computer and all attached peripherals from AC power.
- Disconnect all network cables, telephone, and telecommunications lines from the computer.
- Use an ESD field service kit when working inside any notebook to avoid electrostatic discharge (ESD) damage.
- After removing any computer component, carefully place the removed component on an anti-static mat.
- Wear shoes with non-conductive rubber soles to reduce the chance of getting electrocuted.
- Unplugging, pressing, and holding the power button for 15 seconds should discharge residual power in the system board.

## Standby power

Dell products with standby power must be unplugged before you open the case. Systems that incorporate standby power are powered while turned off. The internal power enables the computer to be remotely turned on (Wake-on-LAN) and suspended into a sleep mode and has other advanced power management features.

## Bonding

Bonding is a method for connecting two or more grounding conductors to the same electrical potential. This is done by using a field service electrostatic discharge (ESD) kit. When connecting a bonding wire, ensure that it is connected to bare metal and never to a painted or nonmetal surface. The wrist strap should be secure and in full contact with your skin, and ensure that you remove all jewelry such as watches, bracelets, or rings prior to bonding yourself and the equipment.

## Electrostatic discharge—ESD protection

ESD is a major concern when you handle electronic components, especially sensitive components such as expansion cards, processors, memory modules, and system boards. Slight charges can damage circuits in ways that may not be obvious, such as intermittent problems or a shortened product life span. As the industry pushes for lower power requirements and increased density, ESD protection is an increasing concern.



Due to the increased density of semiconductors used in recent Dell products, the sensitivity to static damage is now higher than in previous Dell products. For this reason, some previously approved methods of handling parts are no longer applicable.

Two recognized types of ESD damage are catastrophic and intermittent failures.

- **Catastrophic** – Catastrophic failures represent approximately 20 percent of ESD-related failures. The damage causes an immediate and complete loss of device functionality. An example of catastrophic failure is a memory DIMM that has received a static shock and immediately generates a "No POST/No Video" symptom with a beep code that is emitted for missing or nonfunctional memory.
- **Intermittent** – Intermittent failures represent approximately 80 percent of ESD-related failures. The high rate of intermittent failures means that most of the time when damage occurs, it is not immediately recognizable. The DIMM receives a static shock, but the tracing is merely weakened and does not immediately produce outward symptoms that are related to the damage. The weakened trace may take weeks or months to melt, and in the meantime may cause degradation of memory integrity, intermittent memory errors, and so on.

The more difficult type of damage to recognize and troubleshoot is the intermittent (also called latent or "walking wounded") failure.

Perform the following steps to prevent ESD damage:

- Use a wired ESD wrist strap that is properly grounded. Wireless anti-static straps do not provide adequate protection. Touching the chassis before handling parts does not ensure adequate ESD protection on parts with increased sensitivity to ESD damage.
- Handle all static-sensitive components in a static-safe area. If possible, use anti-static floor pads and workbench pads.
- When unpacking a static-sensitive component from its shipping carton, do not remove the component from the anti-static packing material until you are ready to install the component. Before unwrapping the anti-static packaging, ensure that you discharge static electricity from your body.
- Before transporting a static-sensitive component, place it in an anti-static container or packaging.

## ESD Field Service kit

The unmonitored Field Service kit is the most commonly used service kit. Each Field Service kit includes three main components: anti-static mat, wrist strap, and bonding wire.

### Components of an ESD field service kit

The components of an ESD field service kit are:

- **Anti-Static Mat** – The anti-static mat is dissipative and parts can be placed on it during service procedures. When using an anti-static mat, your wrist strap should be snug and the bonding wire should be connected to the mat and to any bare metal on the computer being worked on. Once deployed properly, service parts can be removed from the ESD bag and placed directly on the mat. ESD-sensitive items are safe in your hand, on the ESD mat, in the computer, or inside an ESD bag.
- **Wrist Strap and Bonding Wire** – The wrist strap and bonding wire can be either directly connected between your wrist and bare metal on the hardware if the ESD mat is not required, or connected to the anti-static mat to protect hardware that is temporarily placed on the mat. The physical connection of the wrist strap and bonding wire between your skin, the ESD mat, and the hardware is known as bonding. Use only Field Service kits with a wrist strap, mat, and bonding wire. Never use wireless wrist straps. Always be aware that the internal wires of a wrist strap are prone to damage from normal wear and tear, and must be checked regularly with a wrist strap tester in order to avoid accidental ESD hardware damage. It is recommended to test the wrist strap and bonding wire at least once per week.
- **ESD Wrist Strap Tester** – The wires inside an ESD strap are prone to damage over time. When using an unmonitored kit, it is a best practice to regularly test the strap prior to each service call, and at a minimum, test once per week. A wrist strap tester is the best method for doing this test. If you do not have your own wrist strap tester, check with your regional office to find out if they have one. To perform the test, plug the bonding-wire of wrist-strap into the tester while it is strapped to your wrist and push the button to test. A green LED is lit if the test is successful; a red LED is lit and an alarm sounds if the test fails.
- **Insulator Elements** – It is critical to keep ESD sensitive devices, such as plastic heat sink casings, away from internal parts that are insulators and often highly charged.
- **Working Environment** – Before deploying the ESD Field Service kit, assess the situation at the customer location. For example, deploying the kit for a server environment is different than for a desktop or laptop environment. Servers are typically installed in a rack within a data center; desktops or laptops are typically placed on office desks or cubicles. Always look for a large open flat work area that is free of clutter and large enough to deploy the ESD kit with additional space to accommodate the type of computer that is being repaired. The workspace should also be free of insulators that can cause an ESD event. On the work area, insulators such as Styrofoam and other plastics should always be moved at least 12 inches or 30 centimeters away from sensitive parts before physically handling any hardware components.

- **ESD Packaging** – All ESD-sensitive devices must be shipped and received in static-safe packaging. Metal, static-shielded bags are preferred. However, you should always return the damaged part using the same ESD bag and packaging that the new part arrived in. The ESD bag should be folded over and taped shut and all the same foam packing material should be used in the original box that the new part arrived in. ESD-sensitive devices should be removed from packaging only at an ESD-protected work surface, and parts should never be placed on top of the ESD bag because only the inside of the bag is shielded. Always place parts in your hand, on the ESD mat, in the computer, or inside an anti-static bag.
- **Transporting Sensitive Components** – When transporting ESD sensitive components such as replacement parts or parts to be returned to Dell, it is critical to place these parts in anti-static bags for safe transport.

## ESD protection summary

It is recommended to always use the traditional wired ESD grounding wrist strap and protective anti-static mat when servicing Dell products. In addition, it is critical to keep sensitive parts separate from all insulator parts while performing service and use anti-static bags for transporting sensitive components.

## Transporting sensitive components

When transporting ESD sensitive components such as replacement parts or parts to be returned to Dell, it is critical to place these parts in anti-static bags for safe transport.

## After working inside your computer

### About this task

 **CAUTION:** Leaving stray or loose screws inside your computer may severely damage your computer.

### Steps

1. Replace all screws and ensure that no stray screws remain inside your computer.
2. Connect any external devices, peripherals, or cables you removed before working on your computer.
3. Replace any media cards, discs, or any other parts that you removed before working on your computer.
4. Connect your computer and all attached devices to their electrical outlets.
  -  **NOTE:** To exit service mode, ensure to connect the AC adapter to the power-adapter port on your computer.
5. Press the power button to turn on the computer. Your computer will automatically return to normal functioning mode.

## BitLocker

 **CAUTION:** If BitLocker is not suspended before updating the BIOS, the next time you reboot the system it will not recognize the BitLocker key. You will then be prompted to enter the recovery key to progress, and the system will ask for the recovery key on each reboot. If the recovery key is not known, this can result in data loss or an unnecessary operating system reinstall. For more information about this subject, see Knowledge Article: [updating the BIOS on Dell systems with BitLocker enabled](#).

The installation of the following components triggers BitLocker:

- Hard disk drive or solid-state drive
- System board

## Recommended tools

The procedures in this document may require the following tools:















- Phillips screwdriver #0
- Phillips screwdriver #1
- Torx #5 (T5) screwdriver

- Plastic scribe











## Screw list

- i** **NOTE:** When removing screws from a component, it is recommended to note the screw type, and the quantity of screws, and then place them in a screw storage box. This is to ensure that the correct number of screws and correct screw type is restored when the component is replaced.
- i** **NOTE:** Some computers have magnetic surfaces. Ensure that the screws are not left attached to such surfaces when replacing a component.
- i** **NOTE:** Screw color may vary with the configuration ordered.

**Table 30. Screw list**

Component	Screw type	Quantity	Screw image
Base cover	M2x3 (T5 Torx screw)	8	
M.2 2230 solid state drive	M2x2	2	
M.2 2280 solid state drive	M2x2	2	
Battery	M2x4	6	
Processor fan	M2x4	2	
Graphics-card fan	M2x4	2	
Heat sink (integrated graphics)	Captive screws	3	
Heat sink (discrete graphics)	Captive screws	7	
Display hinges	M2.5x5	8	
Display-FPC cable	M1.4x4 (T5 Torx screw)	2	
Display-FPC cover	M1.4x4 (T5 Torx screw)	2	
SD-card daughterboard	M2x1.5	3	
USH and SD-card daughterboard	M2x1.5	4	
Smart-card reader	M1.6x1.7	2	
Graphics-card FPC	M1.4x4 (T5 Torx screw)	4	

**Table 30. Screw list (continued)**

Component	Screw type	Quantity	Screw image
Graphics-card bridge	M1.6x4.5	4	
PC-bridge bracket	M2x4	2	
Graphics card	M2x4	2	
Dummy graphics card	M2x4	2	
System board	M2x4	9	
Speakers	M1.6x1.8	4	
Haptics touchpad FPC	M1.4x1.2	2	
SD-card daughterboard FPC/USH and SD-card daughterboard FPC	M1.4x1.2	2	
WLAN antennas	Captive screws	4	
Power button with fingerprint reader	M1.6x2	3	

## Major components of Precision 5690

The following image shows the major components of Precision 5690.

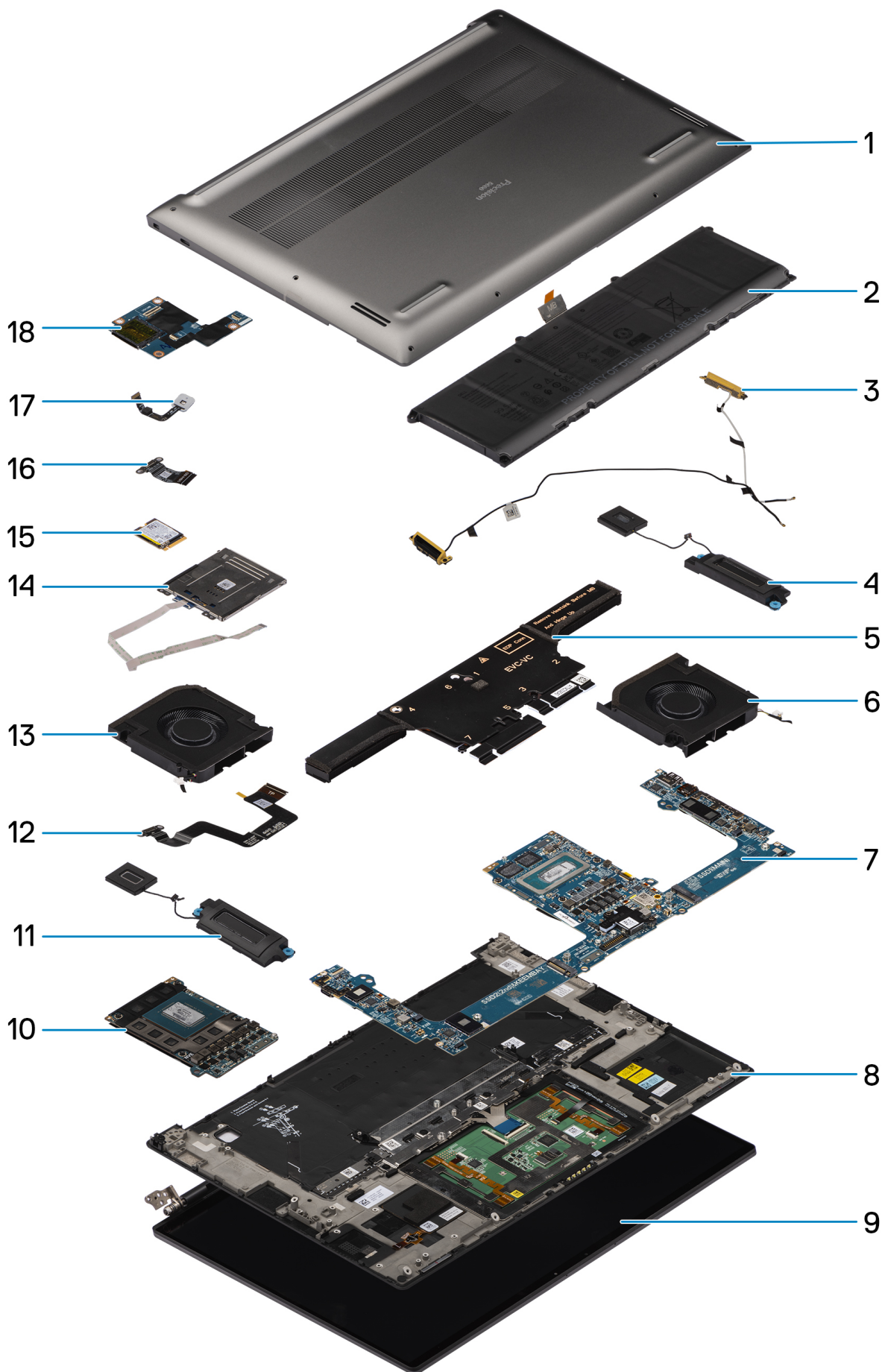

1. Base cover
2. Battery
3. WLAN antennas
4. Left speaker
5. Heatsink
6. Processor fan
7. System board
8. Palm-rest and keyboard assembly
9. Display assembly
10. Graphics card
11. Right speaker
12. Haptics touchpad FPC
13. Graphics-card fan
14. Smart-card reader
15. Solid state drive
16. USH and SD-card daughterboard FPC/SD-card daughterboard FPC
17. Power button with fingerprint reader
18. USH and SD-card daughterboard

**i** **NOTE:** Dell provides a list of components and their part numbers for the original system configuration purchased. These parts are available according to warranty coverages purchased by the customer. Contact your Dell sales representative for purchase options.

# Removing and installing Customer Replaceable Units (CRUs)

The replaceable components in this chapter are Customer Replaceable Units (CRUs).

**CAUTION:** Customers can replace only the Customer Replaceable Units (CRUs) following the safety precautions and replacement procedures.

**NOTE:** The images in this document may differ from your computer depending on the configuration you ordered.

## Secure Digital (SD) Card

### Removing the SD card

#### Prerequisites

Follow the procedure in [Before working inside your computer](#).

**NOTE:** Ensure that your computer is in Service Mode. For more information see, step 6 in [Before working inside your computer](#).

#### About this task

The following image indicates the location and provides a visual representation of the SD card removal procedure.



### Steps

1. Push the SD card to eject it from the slot.
2. Remove the SD card from the computer.

## Installing the SD card

### Prerequisites

If you are replacing a component, remove the existing component before performing the installation procedure.

### About this task

The following image provides a visual representation of the SD-card installation procedure.





**Steps**

Insert the SD card into its slot until it click into place.

**Next steps**

1. Follow the procedure in [After working inside your computer](#).

# Removing and installing Field Replaceable Units (FRUs)

The replaceable components in this chapter are Field Replaceable Units (FRUs).

**CAUTION:** The information in this removing and installing FRU's section is intended for authorized service technicians only.

**CAUTION:** To avoid any potential damage to the component or loss of data, ensure that an authorized service technician replaces the Field Replaceable Units (FRUs).

**CAUTION:** Dell Technologies recommends that this set of repairs, if needed, to be conducted by trained technical repair specialists.

**CAUTION:** As a reminder, your warranty does not cover damages that may occur during FRU repairs that are not authorized by Dell Technologies.

**NOTE:** The images in this document may differ from your computer depending on the configuration you ordered.

## Base cover

### Removing the base cover

**CAUTION:** The information in this removal section is intended for authorized service technicians only.

#### Prerequisites

1. Follow the procedure in [Before working inside your computer](#).

**NOTE:** Ensure that your computer is in Service Mode. For more information, see step 6 in [Before working inside your computer](#).

2. Remove the [SD card](#).

#### About this task

The following images indicate the location and provide a visual representation of the base cover removal procedure.



**8x**  
M2x3



**Figure 11. Removing the base cover**

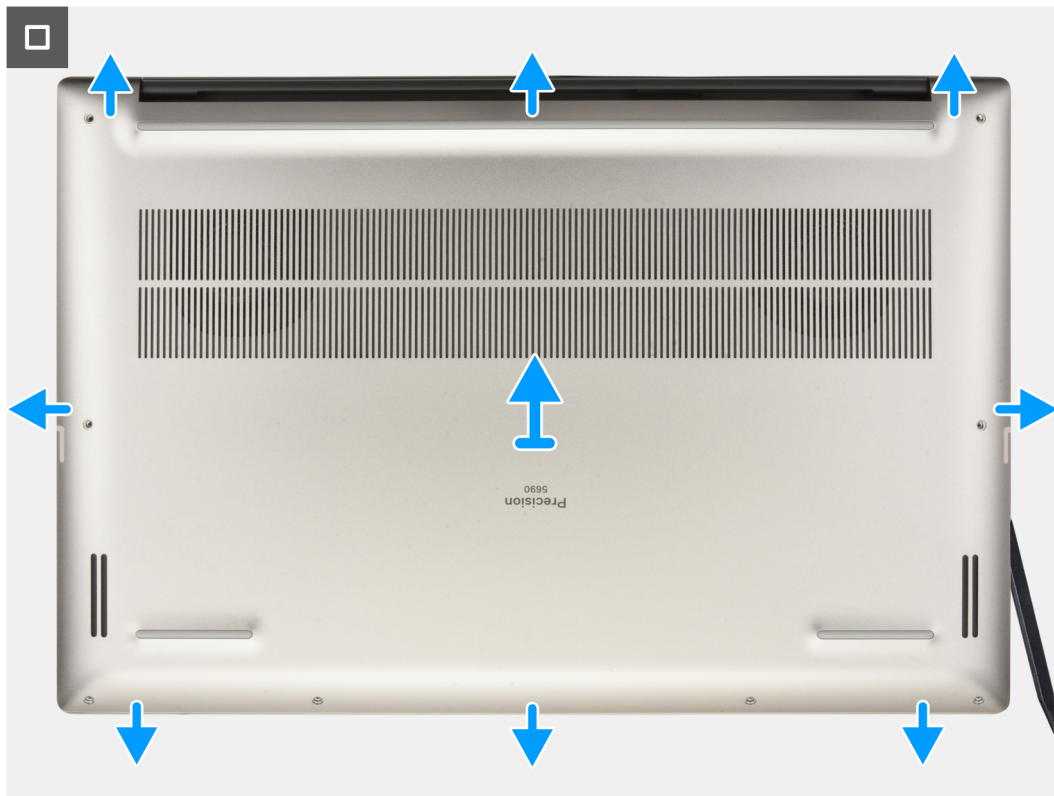

Figure 12. Removing the base cover

#### Steps

1. Remove the eight torx screws (T5, M2x3) that secure the base cover to the computer.
2. Using a plastic scribe, pry open the base cover starting from the SD-card slot on the base cover.
  - ⚠ **CAUTION:** Do not fully insert the plastic scribe into the SD-card slot before prying. Only pry the edge of the base cover nearest to the SD-card slot opening.
  - ⚠ **CAUTION:** Do not pry up from the top side (near the vents) of the base cover. It may damage the rear side of the cover.



**Figure 13. Removing the base cover**

3. Work your way around the bottom, left and right sides of the base cover.
4. Lift the bottom of the base cover and push it towards the rear of the computer to remove it from the computer.

**CAUTION:** Do not grasp from the rear vents and lift the base cover directly upwards to remove it. It may damage the rear side of the cover.

## Installing the base cover

**CAUTION:** The information in this installation section is intended for authorized service technicians only.

### Prerequisites

If you are replacing a component, remove the necessary component before the installation procedure.

### About this task

The following images indicate the location and provide a visual representation of the base cover installation procedure.

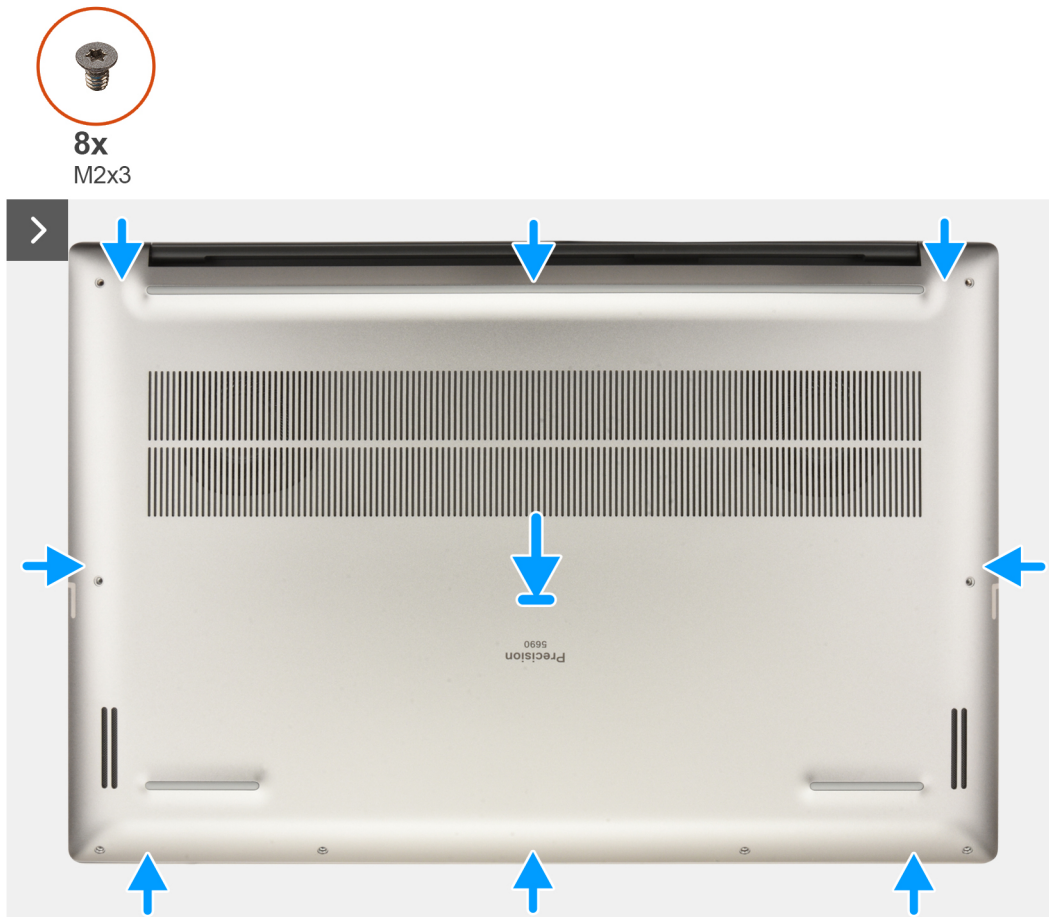

Figure 14. Installing the base cover



Figure 15. Installing the base cover

### Steps

1. Align and place the base cover on the palm-rest assembly, and snap the base cover into place.
2. Replace the eight torx screws (T5, M2x3) to secure the base cover to the computer.

### Next steps

1. Install the [SD card](#).
2. Follow the procedure in [After working inside your computer](#).

## Solid state drive (SSD)

### Removing the M.2 2230 solid state drive

 **CAUTION:** The information in this removal section is intended for authorized service technicians only.

#### Prerequisites

1. Follow the procedure in [Before working inside your computer](#).
2. Remove the [SD card](#).
3. Remove the [base cover](#).

#### About this task

The following images indicate the location of the SSD and provide a visual representation of the removal procedure.

 **NOTE:** The following procedure is applicable for models that are shipped with an M.2 2230 SSD in the SSD1 and/or SSD2 slot.

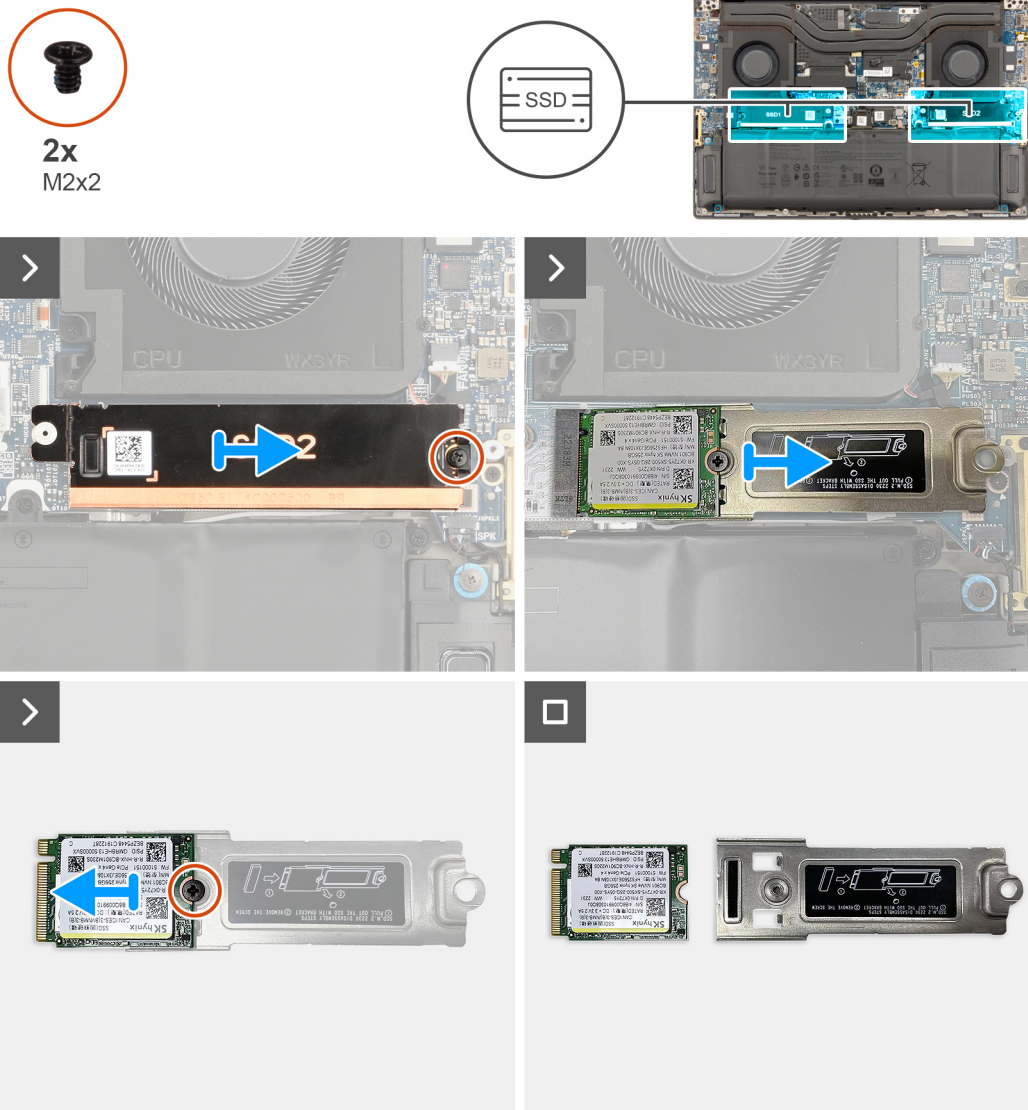

**Figure 16. Removing the M.2 2230 SSD**

### Steps

1. Remove the single screw (M2x2) that secures the SSD thermal plate in place.
2. Remove the SSD thermal plate from the system board.
3. Remove the M.2 2230 SSD with the SSD bracket from the system board.
4. Remove the single screw (M2x2) that secures the M.2 2230 SSD to the SSD bracket.
5. Remove the M.2 2230 SSD from the SSD bracket.

## Installing the M.2 2230 solid state drive

**⚠ CAUTION:** The information in this installation section is intended for authorized service technicians only.

### Prerequisites

If you are replacing a component, remove the existing component before performing the installation procedure.

### About this task

The following image indicates the location of the SSD and provides a visual representation of the installation procedure.



**NOTE:** The following procedure is applicable for models that are shipped with an M.2 2230 SSD in the SSD1 and/or SSD2 slot.

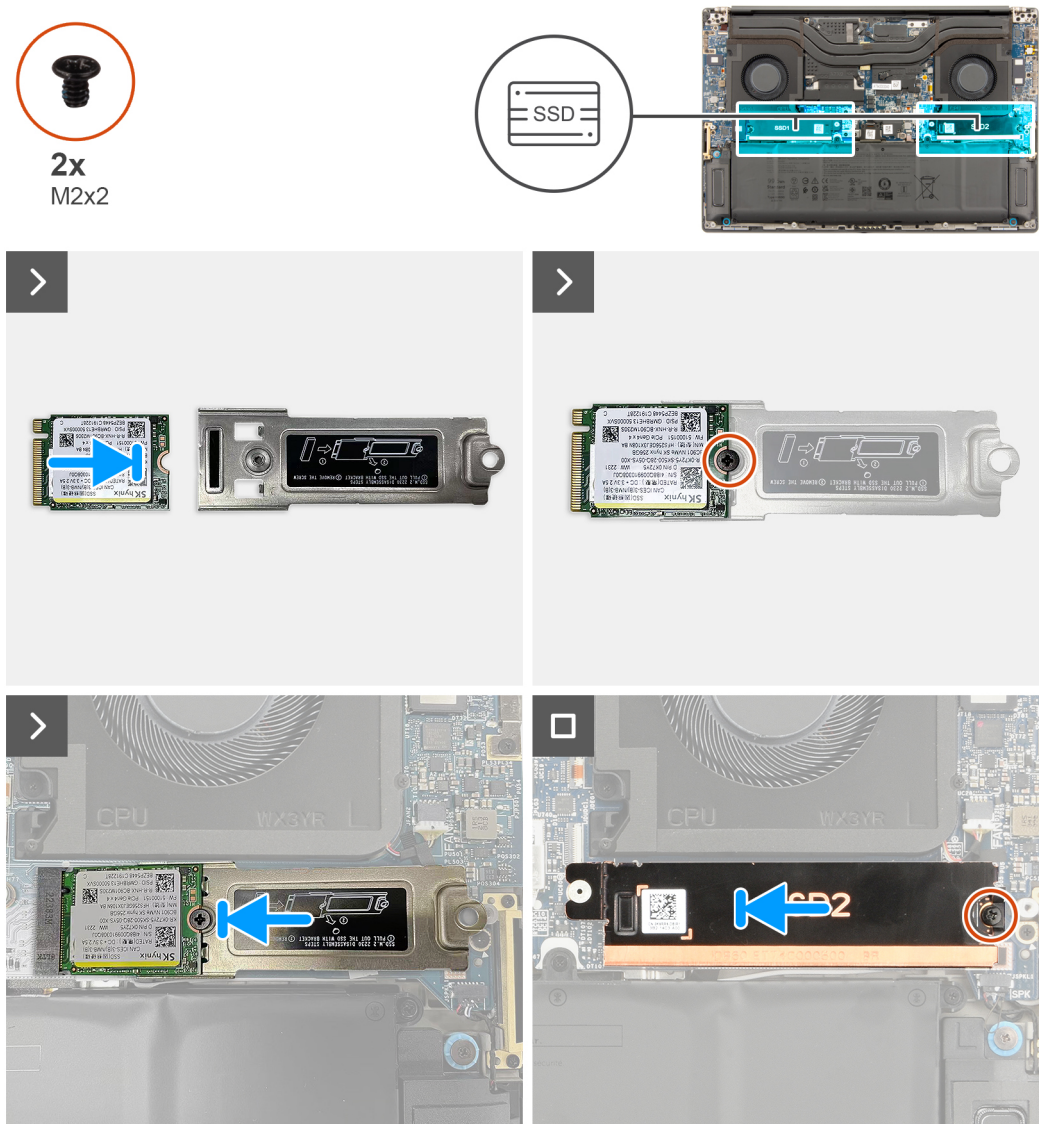

**Figure 17. Installing the M.2 2230 SSD**

**Steps**

1. Align the screw hole on the M.2 2230 SSD with the screw hole on the SSD bracket.
2. Replace the single screw (M2x2) to secure the M.2 2230 SSD to the SSD bracket.
3. Align the notch on the SSD with the tab on the M.2 card connector.
4. Slide the M.2 2230 SSD with the SSD bracket into the M.2 card connector on the system board.
5. Align and place the SSD thermal plate in place.
6. Replace the single screw (M2x2) to secure the SSD thermal plate to the system board.

**Next steps**

1. Install the [base cover](#).
2. Install the [SD card](#).
3. Follow the procedure in [After working inside your computer](#).

## Removing the M.2 2280 solid state drive

**CAUTION:** The information in this removal section is intended for authorized service technicians only.

### Prerequisites

1. Follow the procedure in [Before working inside your computer](#).
2. Remove the [SD card](#).
3. Remove the [base cover](#).

### About this task

The following images indicate the location of the SSD and provide a visual representation of the removal procedure.

**NOTE:** The following procedure is applicable for models that are shipped with an M.2 2280 SSD in the SSD1 and/or SSD2 slot.

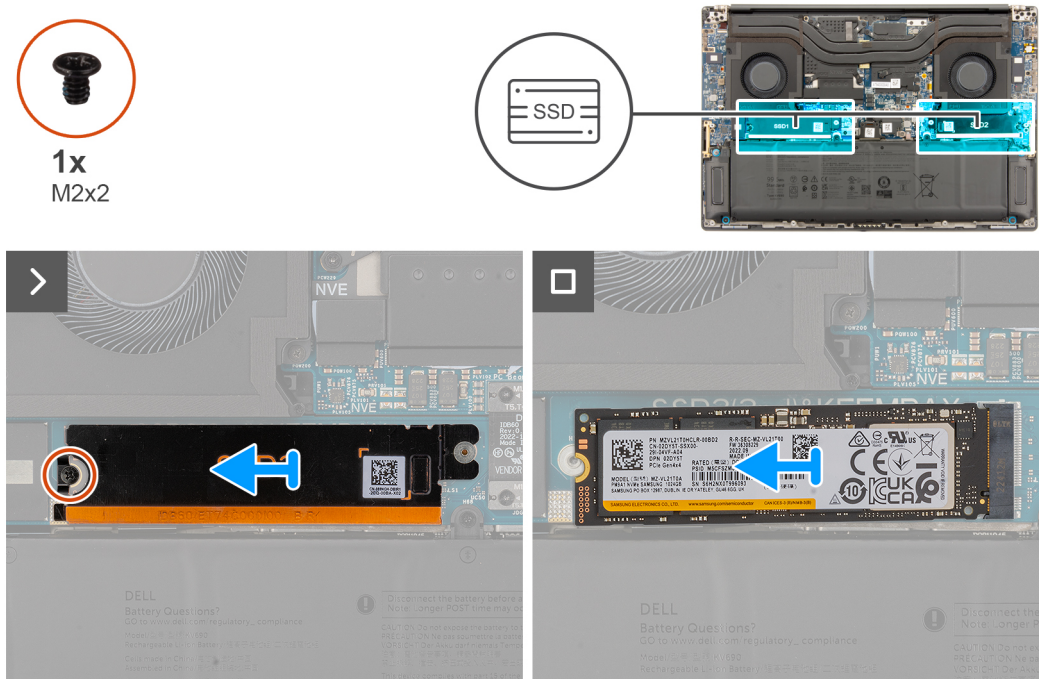

**Figure 18. Removing the M.2 2280 SSD**

### Steps

1. Remove the single screw (M2x2) that secures the SSD thermal plate in place.
2. Remove the SSD thermal plate from the system board.
3. Remove the M.2 2230 SSD from the system board.

## Installing the M.2 2280 solid state drive

### Prerequisites

If you are replacing a component, remove the existing component before performing the installation procedure.

### About this task

The following image indicates the location of the SSD and provides a visual representation of the installation procedure.

**NOTE:** The following procedure is applicable for models that are shipped with an M.2 2280 SSD in the SSD1 and/or SSD2 slot.

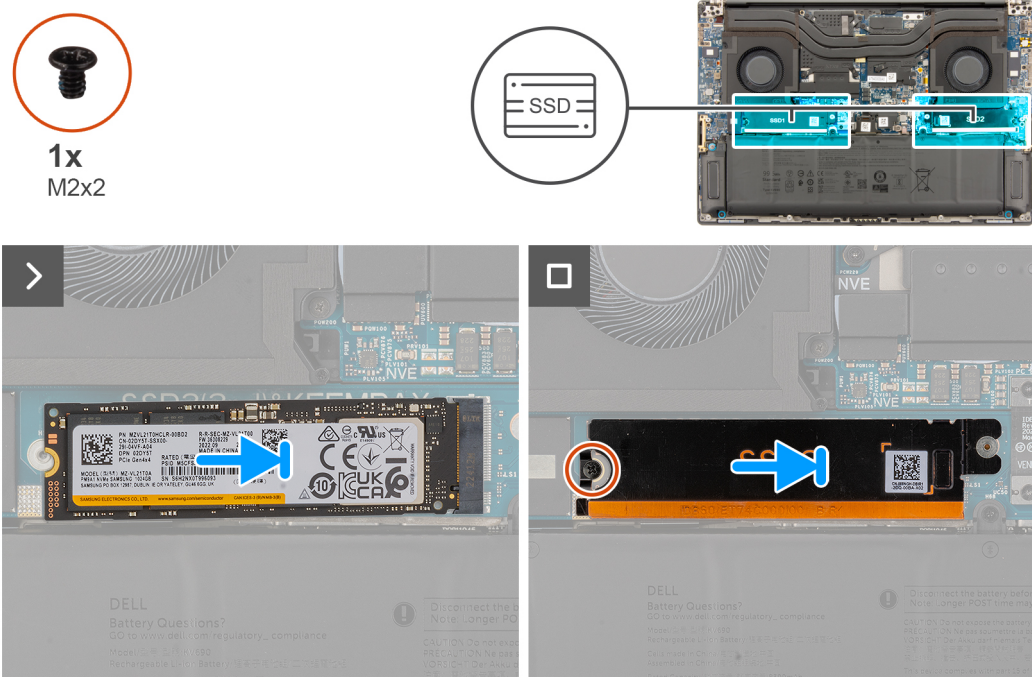

**Figure 19. Installing the M.2 2280 SSD**

#### Steps

1. Align the notch on the SSD with the tab on the M.2 card connector.
2. Slide the M.2 2280 SSD into the M.2 card connector on the system board.
3. Align and place the SSD thermal plate in place.
4. Replace the single screw (M2x2) to secure the SSD thermal plate to the system board.

#### Next steps

1. Install the [base cover](#).
2. Install the [SD card](#).
3. Follow the procedure in [After working inside your computer](#).

## Battery

### Rechargeable Li-ion battery precautions

#### ⚠ CAUTION:

- Exercise caution when handling rechargeable Li-ion batteries.
- Discharge the battery completely before removing it. Disconnect the AC power adapter from the computer and operate the computer solely on battery power—the battery is fully discharged when the computer no longer turns on when the power button is pressed.
- Do not crush, drop, mutilate, or penetrate the battery with foreign objects.
- Do not expose the battery to high temperatures, or disassemble battery packs and cells.
- Do not apply pressure to the surface of the battery.
- Do not bend the battery.
- Do not use tools of any kind to pry on or against the battery.

- Ensure any screws during the servicing of this product are not lost or misplaced, to prevent accidental puncture or damage to the battery and other computer components.
- If the battery gets stuck inside your computer as a result of swelling, do not try to release it as puncturing, bending, or crushing a rechargeable Li-ion battery can be dangerous. In such an instance, contact Dell technical support for assistance. See [www.dell.com/contactdell](http://www.dell.com/contactdell).
- Always purchase genuine batteries from [www.dell.com](http://www.dell.com) or authorized Dell partners and resellers.
- Swollen batteries should not be used and should be replaced and disposed properly. For guidelines on how to handle and replace swollen rechargeable Li-ion batteries, see [Handling swollen rechargeable Li-ion batteries](#).

## Removing the battery

 **CAUTION:** The information in this removal section is intended for authorized service technicians only.

### Prerequisites

1. Follow the procedure in [Before working inside your computer](#).
2. Remove the [SD card](#).
3. Remove the [base cover](#).

 **NOTE:** If the battery was disconnected from the system board for service, it delays the computer boot-up as the computer undergoes RTC battery reset.

### About this task

The following images indicate the location of the battery and provide a visual representation of the removal procedure.

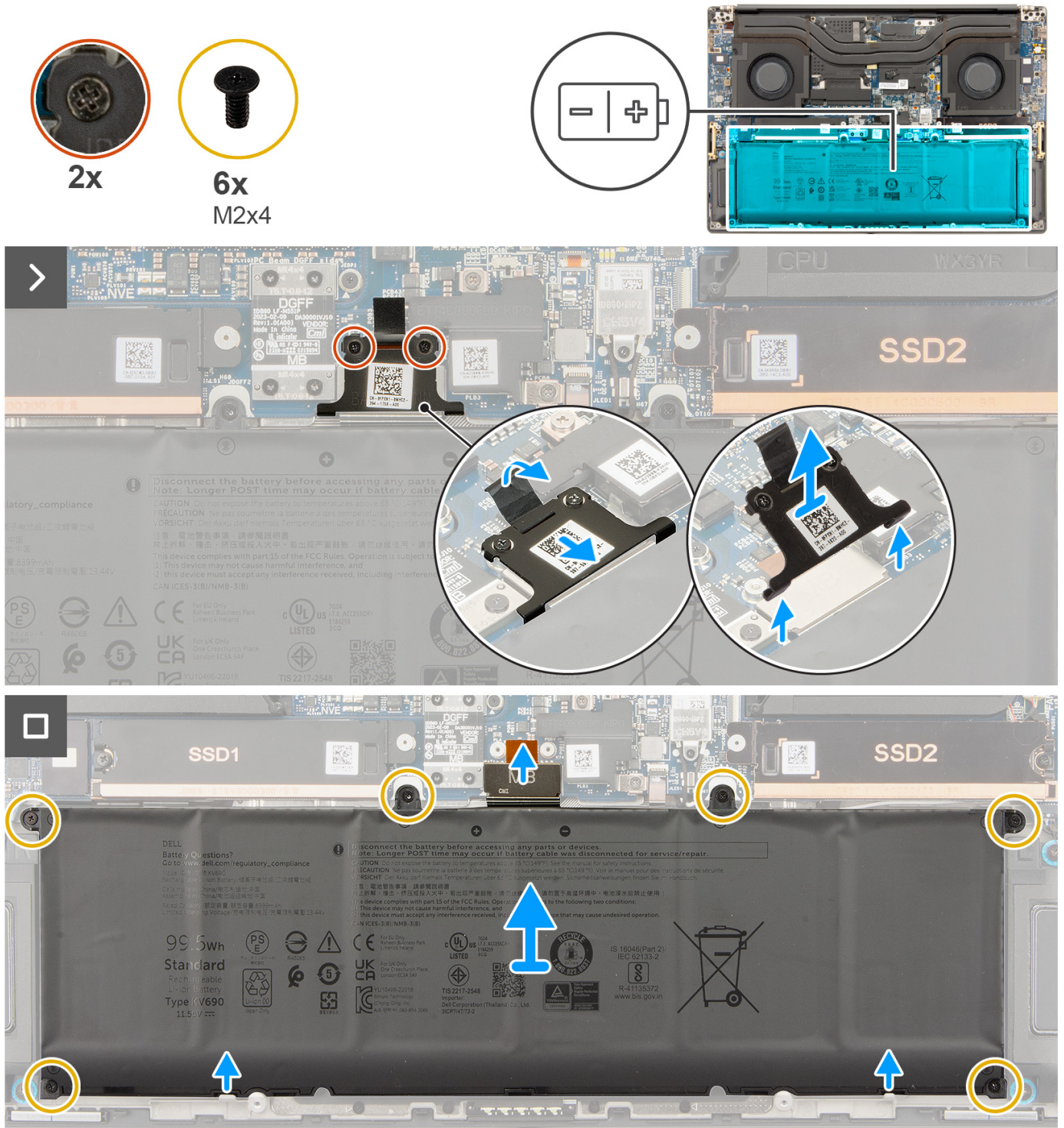

**Figure 20. Removing the battery**

**Steps**

1. Loosen the two captive screws that secure the battery-FPC bracket to the system board.
2. Slide the battery-FPC bracket towards the battery and lift it away from the computer.
3. Remove the six screws (M2x4) that secure the battery to the palm-rest assembly.
4. Lift the battery away from the computer.

**i** **NOTE:** Whenever the computer battery is disconnected or discharged, the date and time are reset. When you turn on the computer under such conditions, it takes more time for the Dell logo to be displayed with the Time-of-day not set message. Select BIOS-Setup in the caution screen to configure the date and time.

## Installing the battery

**△** **CAUTION:** The information in this installation section is intended for authorized service technicians only.

### Prerequisites

If you are replacing a component, remove the existing component before performing the installation procedure.

### About this task

The following image indicates the location of the battery and provides a visual representation of the installation procedure.

**i** **NOTE:** If the battery was disconnected from the system board for service, it delays the computer boot-up as the computer undergoes RTC battery reset.

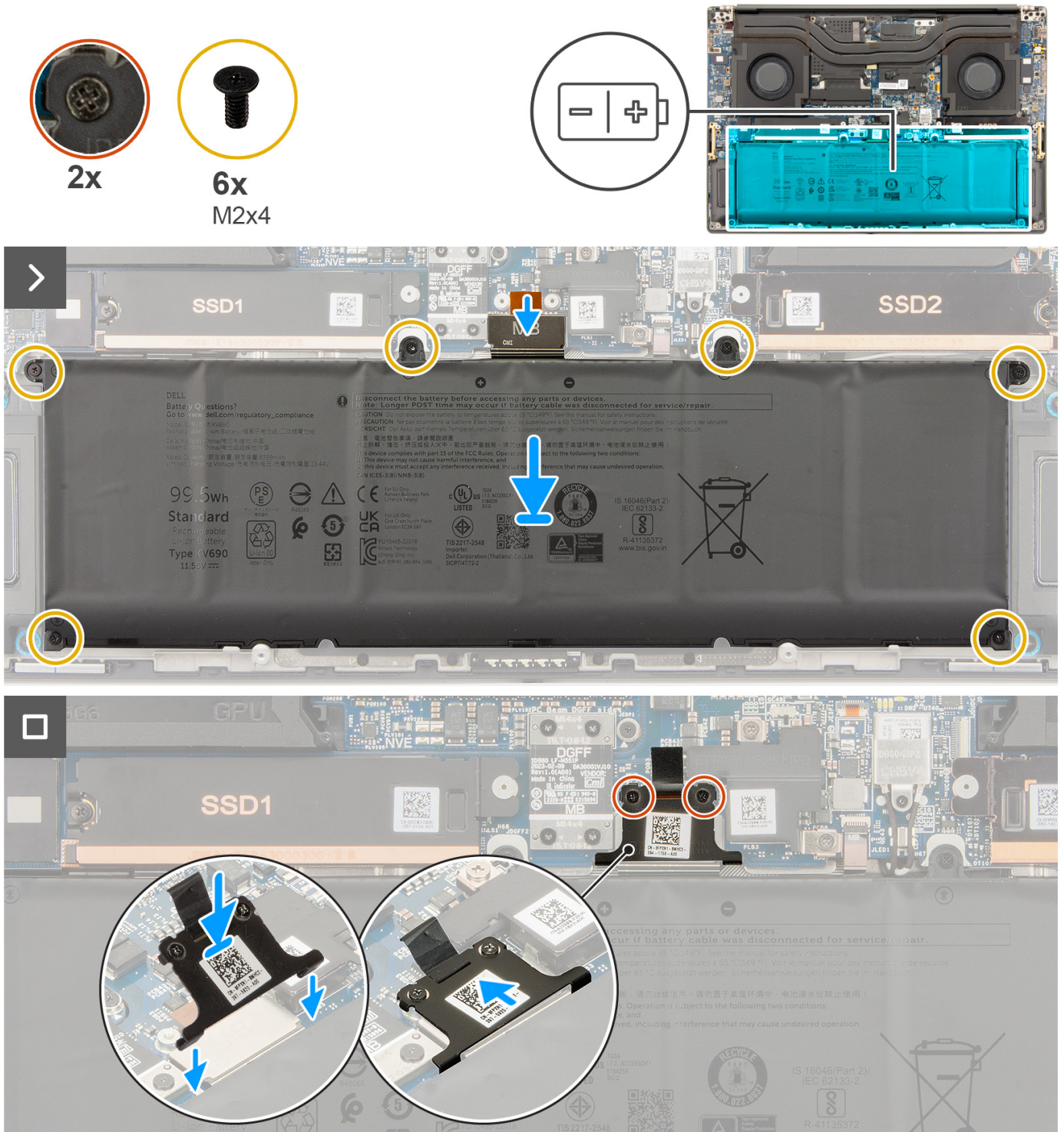

**Figure 21. Installing the battery**

**Steps**

1. Align and place the battery into the slot on the computer.
2. Replace the six screws (M2x4) to secure the battery to the palm-rest assembly.
3. Align the battery-FPC bracket and slide it upwards to secure to the system board.
4. Tighten the two captive screws to secure the battery-FPC bracket to the system board.

### Next steps

1. Install the [base cover](#).
2. Install the [SD card](#).
3. Follow the procedure in [After working inside your computer](#).

## System fan

### Removing the processor fan

**CAUTION:** The information in this removal section is intended for authorized service technicians only.

#### Prerequisites

1. Follow the procedure in [Before working inside your computer](#).
2. Remove the [SD card](#).
3. Remove the [base cover](#).

#### About this task

The following images indicate the location of the processor fan and provide a visual representation of the removal procedure.

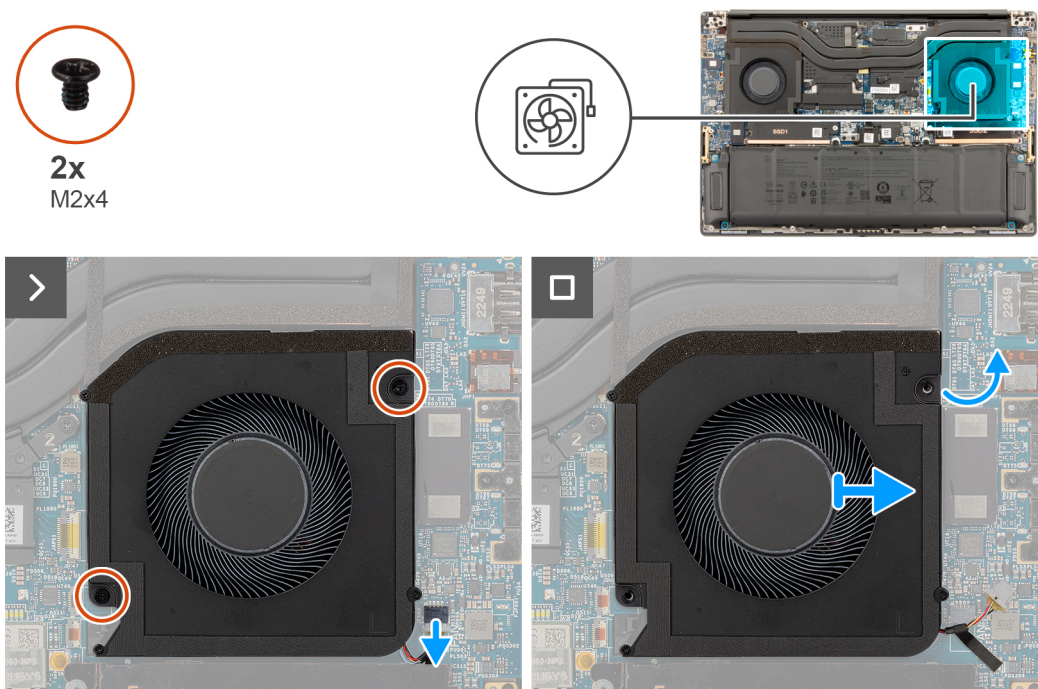

Figure 22. Removing the processor fan

#### Steps

1. Disconnect the processor-fan cable from the connector on the system board.
2. Remove the two screws (M2x4) that secure the processor fan to the palm-rest assembly.
3. Lift the processor fan from the outside and remove it from the palm-rest assembly.

### Installing the processor fan

**CAUTION:** The information in this installation section is intended for authorized service technicians only.



## Prerequisites

If you are replacing a component, remove the existing component before performing the installation procedure.

## About this task

The following image indicates the location of the processor fan and provides a visual representation of the installation procedure.

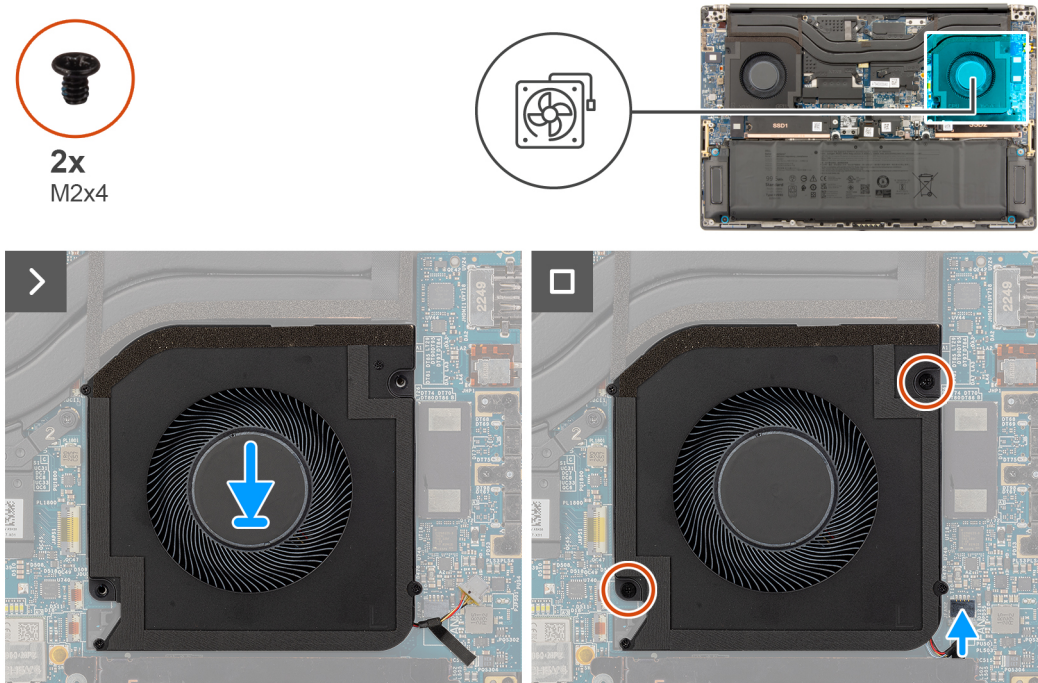

**Figure 23. Installing the processor fan**

## Steps

1. Align and place the processor fan onto the palm-rest assembly.
2. Replace the two screws (M2x4) to secure the processor fan to the palm-rest assembly.
3. Connect the processor-fan cable to the connector on the system board.

## Next steps

1. Install the [base cover](#).
2. Install the [SD card](#).
3. Follow the procedure in [After working inside your computer](#).

## Removing the graphics-card fan

**CAUTION:** The information in this removal section is intended for authorized service technicians only.

## Prerequisites

1. Follow the procedure in [Before working inside your computer](#).
2. Remove the [SD card](#).
3. Remove the [base cover](#).

## About this task

The following images indicate the location of the graphics-card fan and provide a visual representation of the removal procedure.

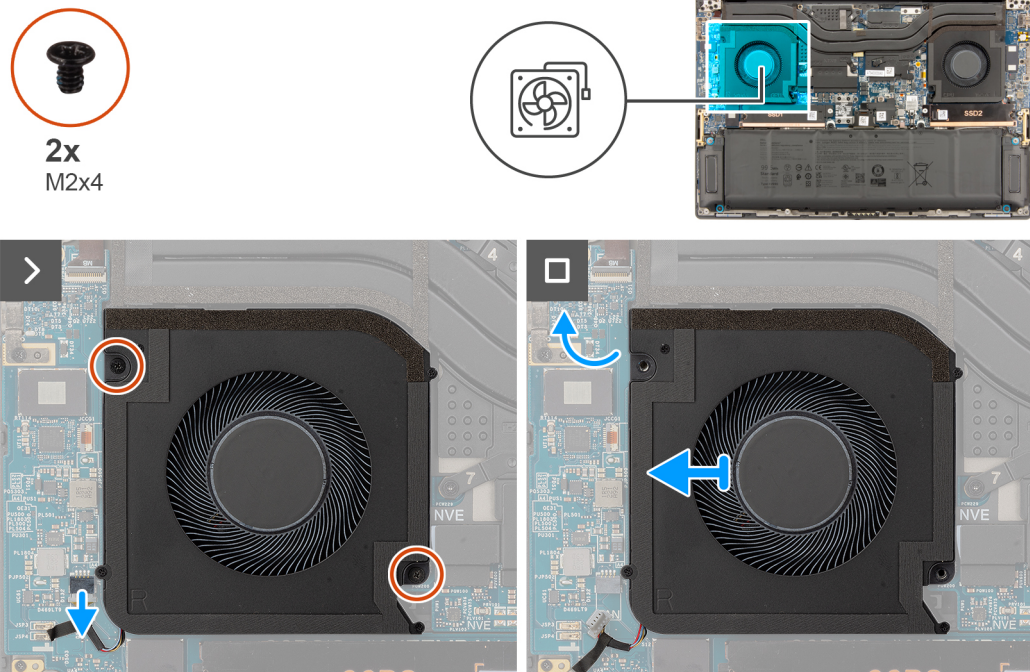

**Figure 24. Removing the graphics-card fan**

**Steps**

1. Disconnect the graphics-card fan cable from the connector on the system board.
2. Remove the two screws (M2x4) that secure the graphics-card fan to the palm-rest assembly.
3. Lift the graphics-card fan from the outside and remove it from the palm-rest assembly.

## Installing the graphics-card fan

**CAUTION:** The information in this installation section is intended for authorized service technicians only.

**Prerequisites**

If you are replacing a component, remove the existing component before performing the installation procedure.

**About this task**

The following image indicates the location of the graphics-card fan and provides a visual representation of the installation procedure.

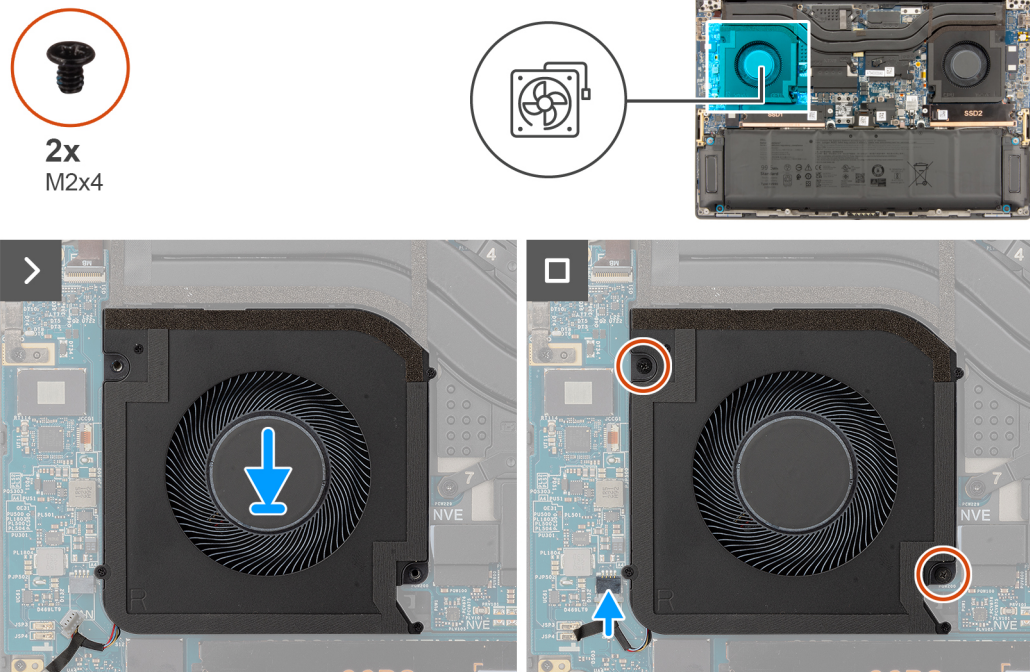

**Figure 25. Installing the graphics-card fan**

**Steps**

1. Align and place the graphics-card fan onto the palm-rest assembly.
2. Replace the two screws (M2x4) to secure the graphics-card fan to the palm-rest assembly.
3. Connect the graphics-card fan cable to the connector on the system board.

**Next steps**

1. Install the [base cover](#).
2. Install the [SD card](#).
3. Follow the procedure in [After working inside your computer](#).

## Heat sink

### Removing the heat sink for integrated graphics

**CAUTION:** The information in this removal section is intended for authorized service technicians only.

**Prerequisites**

1. Follow the procedure in [Before working inside your computer](#).
2. Remove the [SD card](#).
3. Remove the [base cover](#).

**About this task**

The following image indicates the location of the heat sink and provides a visual representation of the removal procedure.

**NOTE:** For computers that are shipped with a heat sink labeled “VC” (Vapor Chamber), the heat sink must be removed before the removal of the display assembly or system board.

**NOTE:** For computers that are shipped with a heat sink labeled “VC” (Vapor Chamber), the heat sink covers the display cable: .

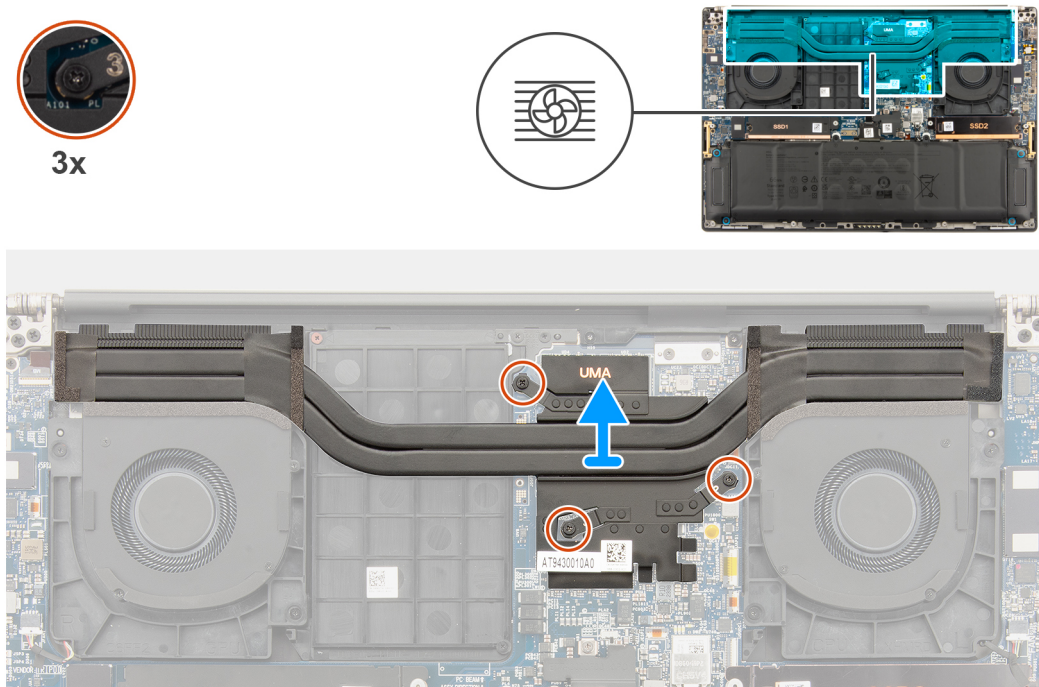

**Figure 26. Removing the heat sink for integrated graphics**

### Steps

1. Loosen the three captive screws in descending order (3>2>1) that secure the heat sink to the system board.
2. Lift the heat sink to remove it from the system board.

**NOTE:** Thermal pads (thermal conductors) are on the heat sink. If the heat sink is replaced, the new heat sink is shipped with thermal pads. Ensure that all thermal pads are in place between the heat sink and the system board.

## Installing the heat sink for integrated graphics

**CAUTION:** The information in this installation section is intended for authorized service technicians only.

### Prerequisites

If you are replacing a component, remove the existing component before performing the installation procedure.

### About this task

**NOTE:** For computers that are shipped with a heat sink labeled “VC” (Vapor Chamber), the heat sink covers the display cable: .

**NOTE:** Thermal pads (thermal conductors) are on the heat sink. If the heat sink is replaced, the new heat sink is shipped with thermal pads. Ensure that all thermal pads are in place between the heat sink and the system board.

The following image indicates the location of the heat sink and provides a visual representation of the installation procedure.

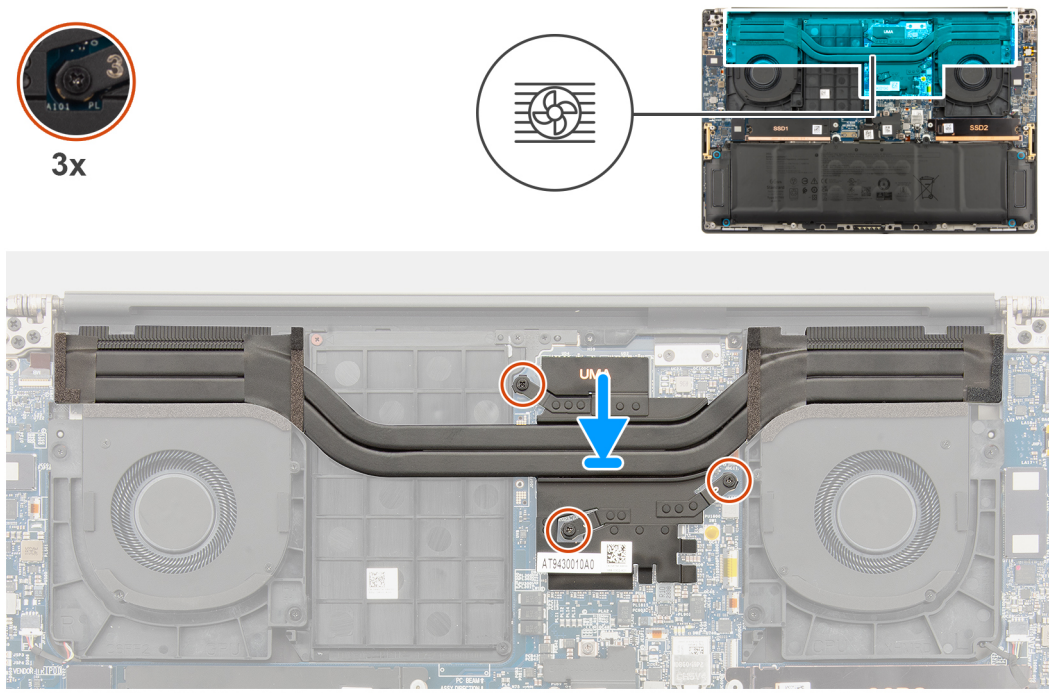

Figure 27. Installing the heat sink for integrated graphics

**Steps**

1. Align the screw holes on the heat sink with the screw holes on the system board.
2. Tighten the three captive screws in ascending order (1>2>3) to secure the heat sink to the system board.

**Next steps**

1. Install the [base cover](#).
2. Install the [SD card](#).
3. Follow the procedure in [After working inside your computer](#).

## Removing the heat sink for discrete graphics

**CAUTION:** The information in this removal section is intended for authorized service technicians only.

**Prerequisites**

1. Follow the procedure in [Before working inside your computer](#).
2. Remove the [SD card](#).
3. Remove the [base cover](#).

**About this task**

The following image indicates the location of the heat sink and provides a visual representation of the removal procedure.

**NOTE:** For computers that are shipped with a heat sink labeled “VC” (Vapor Chamber), the heat sink must be removed before the removal of the display assembly or system board.

**NOTE:** For computers that are shipped with a heat sink labeled “VC” (Vapor Chamber), the heat sink covers the display cable: .

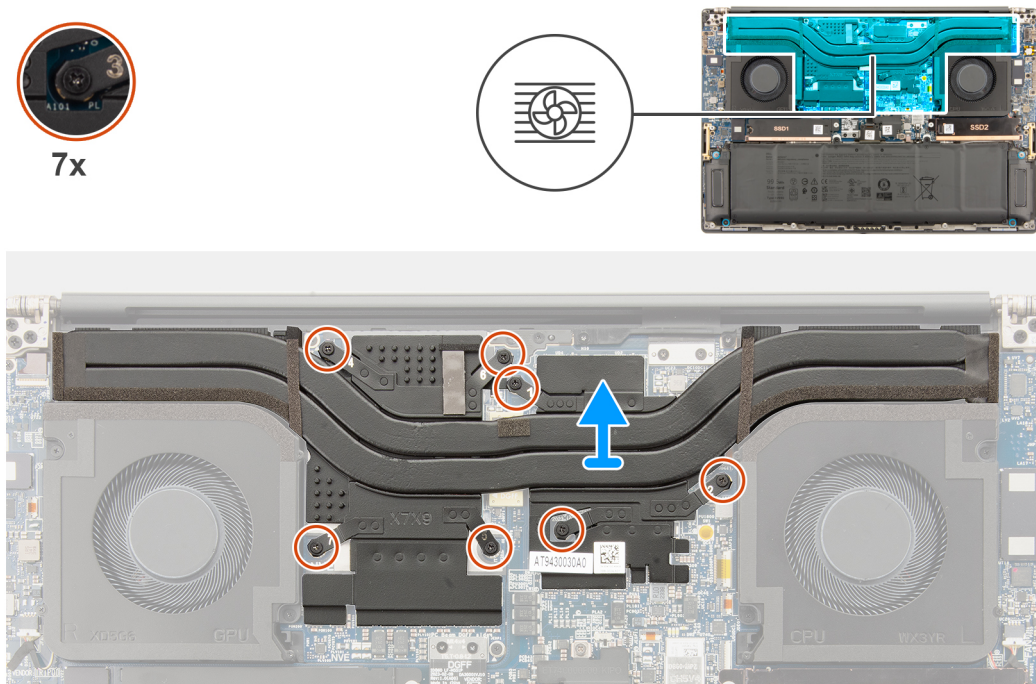

**Figure 28. Removing the heat sink for discrete graphics**

### Steps

1. Loosen the seven captive screws in descending order (7>6>5>4>3>2>1) that secure the heat sink to the system board.
2. Lift the heat sink to remove it from the system board.

**NOTE:** Thermal pads (thermal conductors) are on the heat sink. If the heat sink is replaced, the new heat sink is shipped with thermal pads. Ensure that all thermal pads are in place between the heat sink and the system board.

## Installing the heat sink for discrete graphics

**CAUTION:** The information in this installation section is intended for authorized service technicians only.

### Prerequisites

If you are replacing a component, remove the existing component before performing the installation procedure.

### About this task

**NOTE:** For computers that are shipped with a heat sink labeled "VC" (Vapor Chamber), the heat sink covers the display cable: .

**NOTE:** Thermal pads (thermal conductors) are on the heat sink. If the heat sink is replaced, the new heat sink is shipped with thermal pads. Ensure that all thermal pads are in place between the heat sink and the system board.

The following image indicates the location of the heat sink and provides a visual representation of the installation procedure.

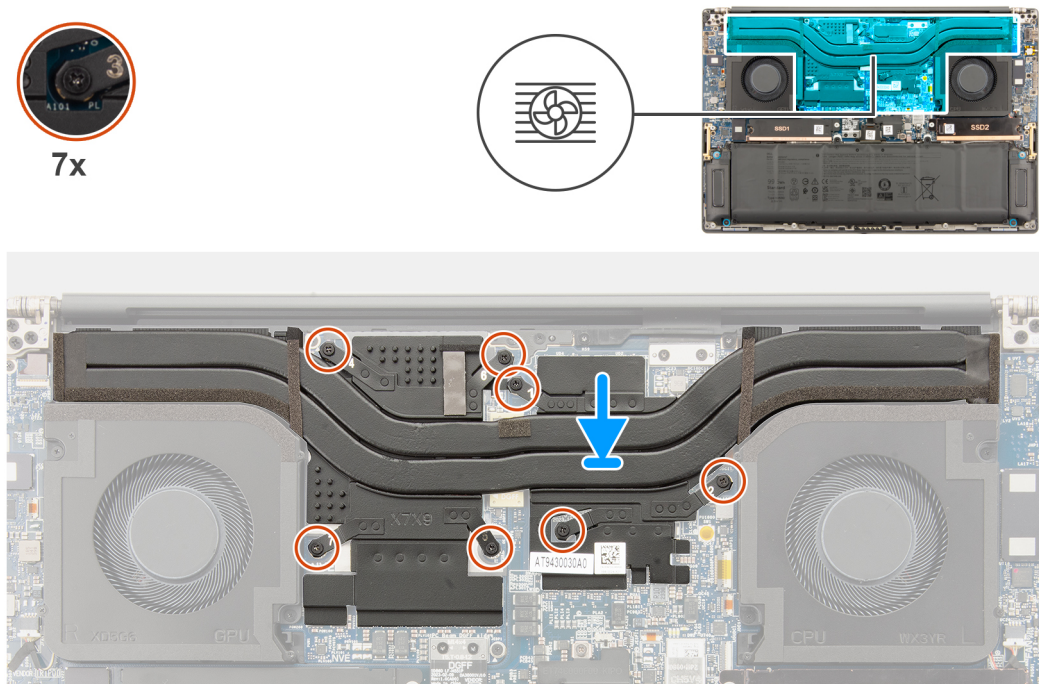

**Figure 29. Installing the heat sink for discrete graphics**

#### Steps

1. Align the screw holes on the heat sink with the screw holes on the system board.
2. Tighten the seven captive screws in ascending order (1>2>3>4>5>6>7) to secure the heat sink to the system board.

#### Next steps

1. Install the [base cover](#).
2. Install the [SD card](#).
3. Follow the procedure in [After working inside your computer](#).

## Display assembly

### Removing the display assembly

**CAUTION:** The information in this removal section is intended for authorized service technicians only.

#### Prerequisites

1. Follow the procedure in [Before working inside your computer](#).
2. Remove the [SD card](#).
3. Remove the [base cover](#).
4. Remove the [heat sink](#) for computers that are shipped with vapor chamber VC heat sink.

#### About this task

The following images indicate the location of the display assembly and provide a visual representation of the removal procedure.

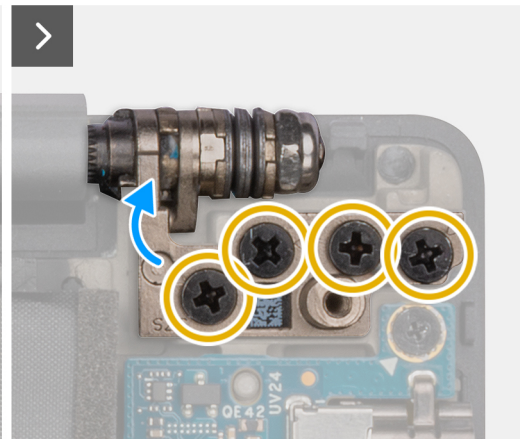
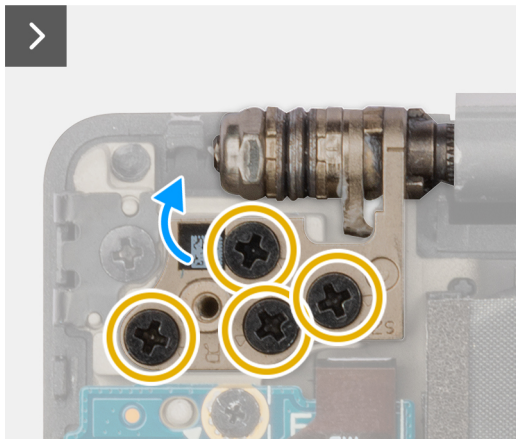
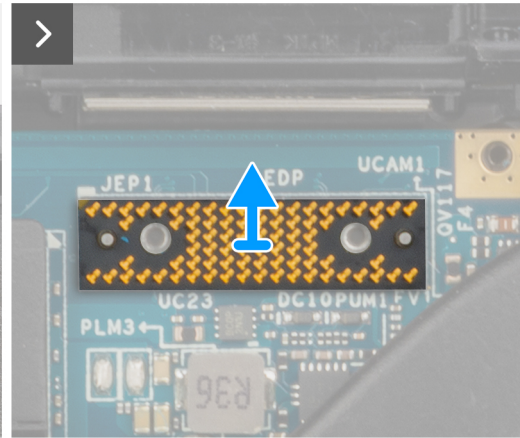
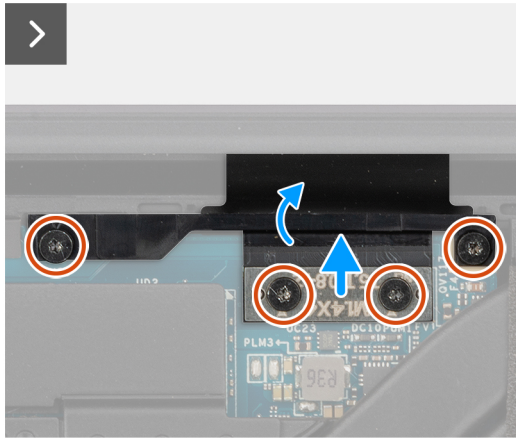
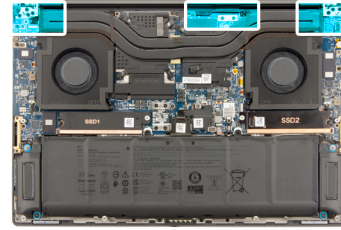
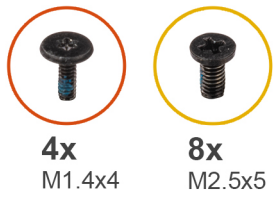
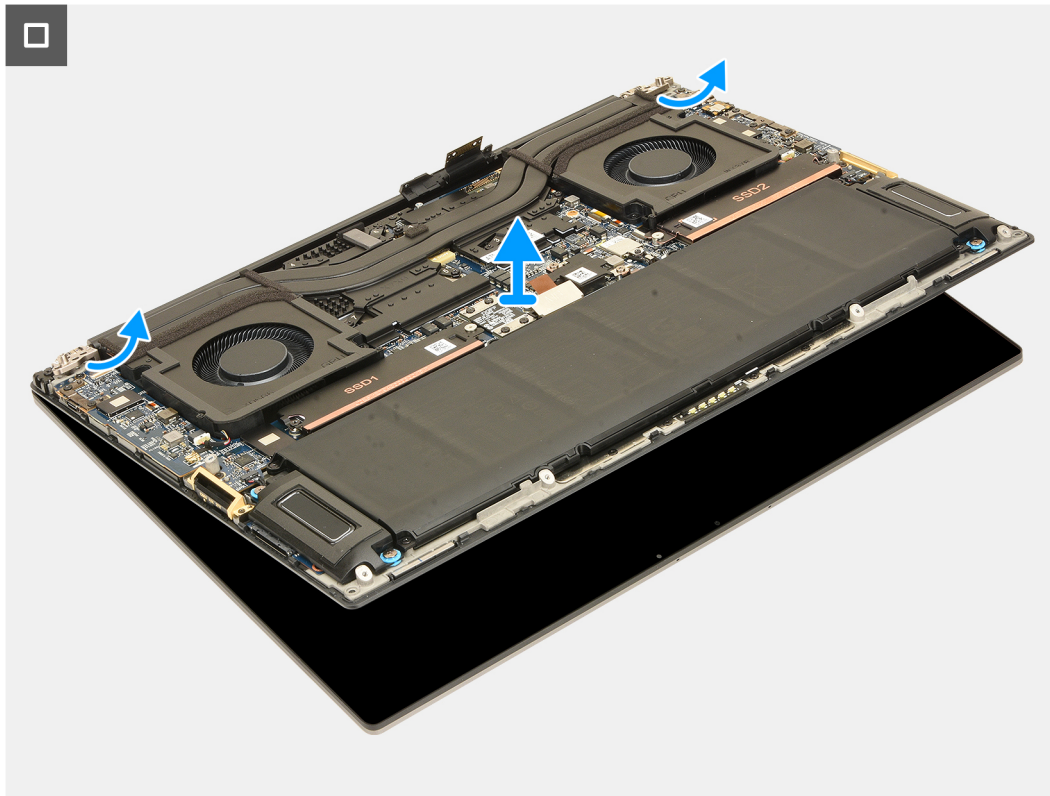

Figure 30. Removing the display assembly



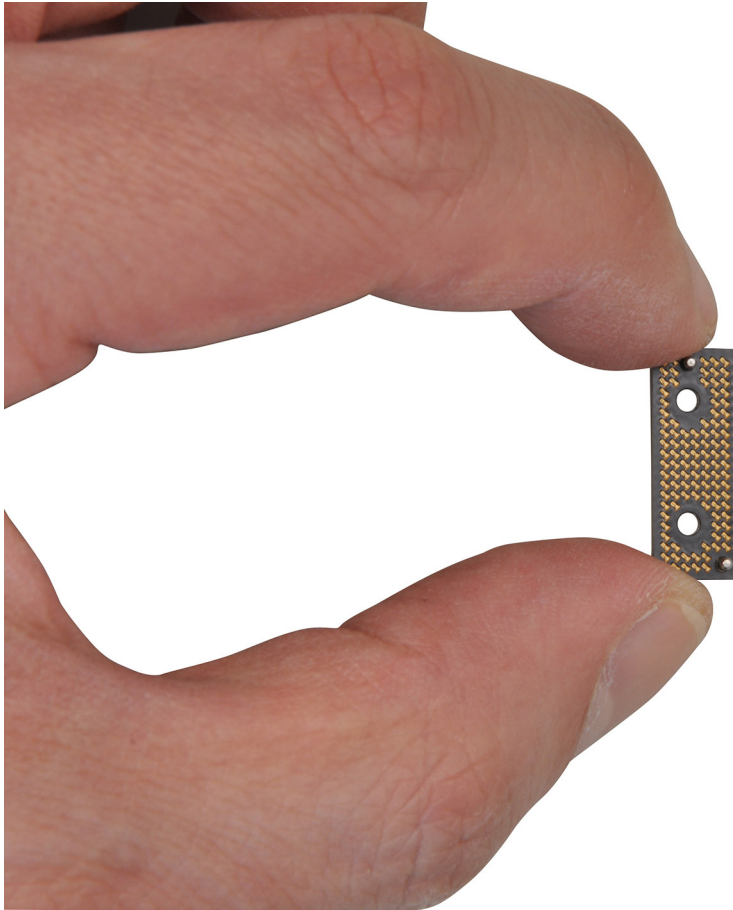

**Figure 31. Removing the display assembly**

#### **Steps**

1. Remove the two torx screws (T5, M1.4x4) that secure the display-FPC cover in place.
2. Flip open the display-FPC cover.
3. Remove the two torx screws (T5, M1.4x4) that secure the display-FPC cable in place.
4. Disconnect the display-FPC cable from the connector on the system board.
5. Remove the interposer board from the computer.

**CAUTION:** The pins on the interposer boards that connect the FPCs to the computer or daughter board are fragile. Technicians should avoid pushing or applying pressure to the pins on the interposer boards. Do not perform any action that may scratch the pins, such as rotating or turning the boards while they are in contact with any surface. When handling the interposer board, lift and hold the board from the edges or the sides.



**Figure 32. Interposer board**

6. Remove the eight (M2.5x5) screws that secure the display assembly to the computer.
  7. Slightly lift the bottom assembly and slide it to the left and away from the display assembly. Remove the display assembly from the computer.
- NOTE:** The display assembly is a hinge-up design (HUD) assembly and cannot be further disassembled once it is removed from the bottom chassis. If any components in the display assembly are malfunctioning and must be replaced, replace the entire display assembly.

## Installing the display assembly

**CAUTION:** The information in this installation section is intended for authorized service technicians only.

### Prerequisites

If you are replacing a component, remove the existing component before performing the installation procedure.

### About this task

The following image indicates the location of the display assembly and provides a visual representation of the installation procedure.

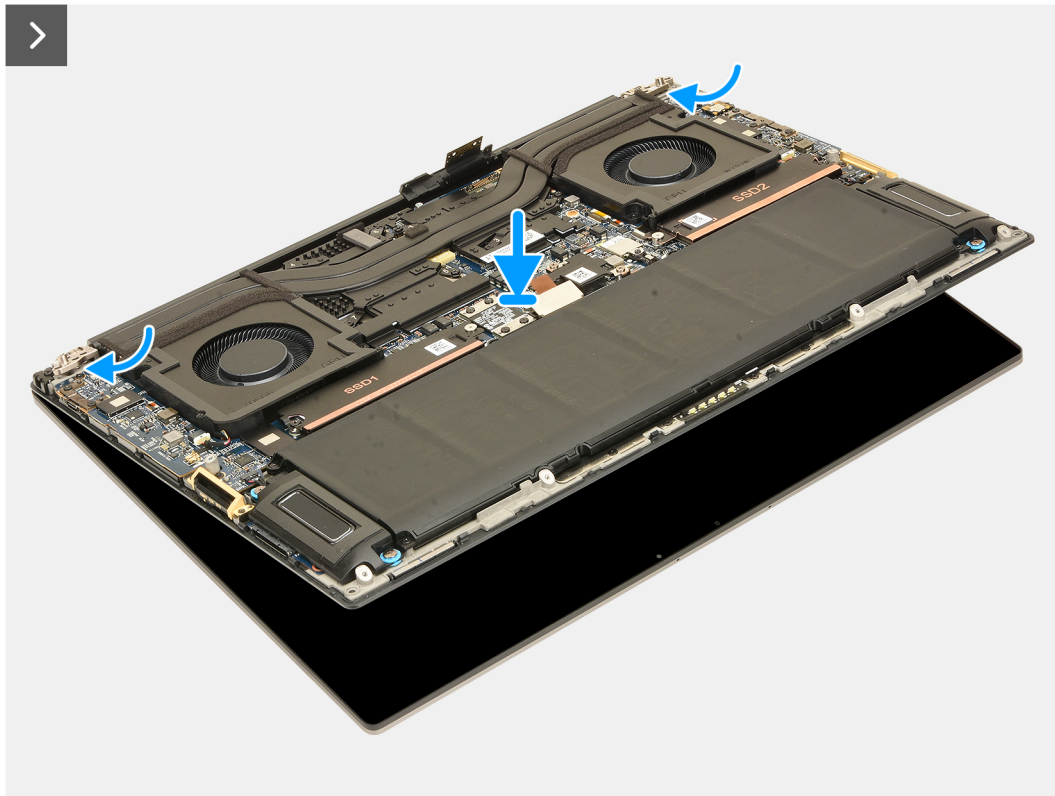
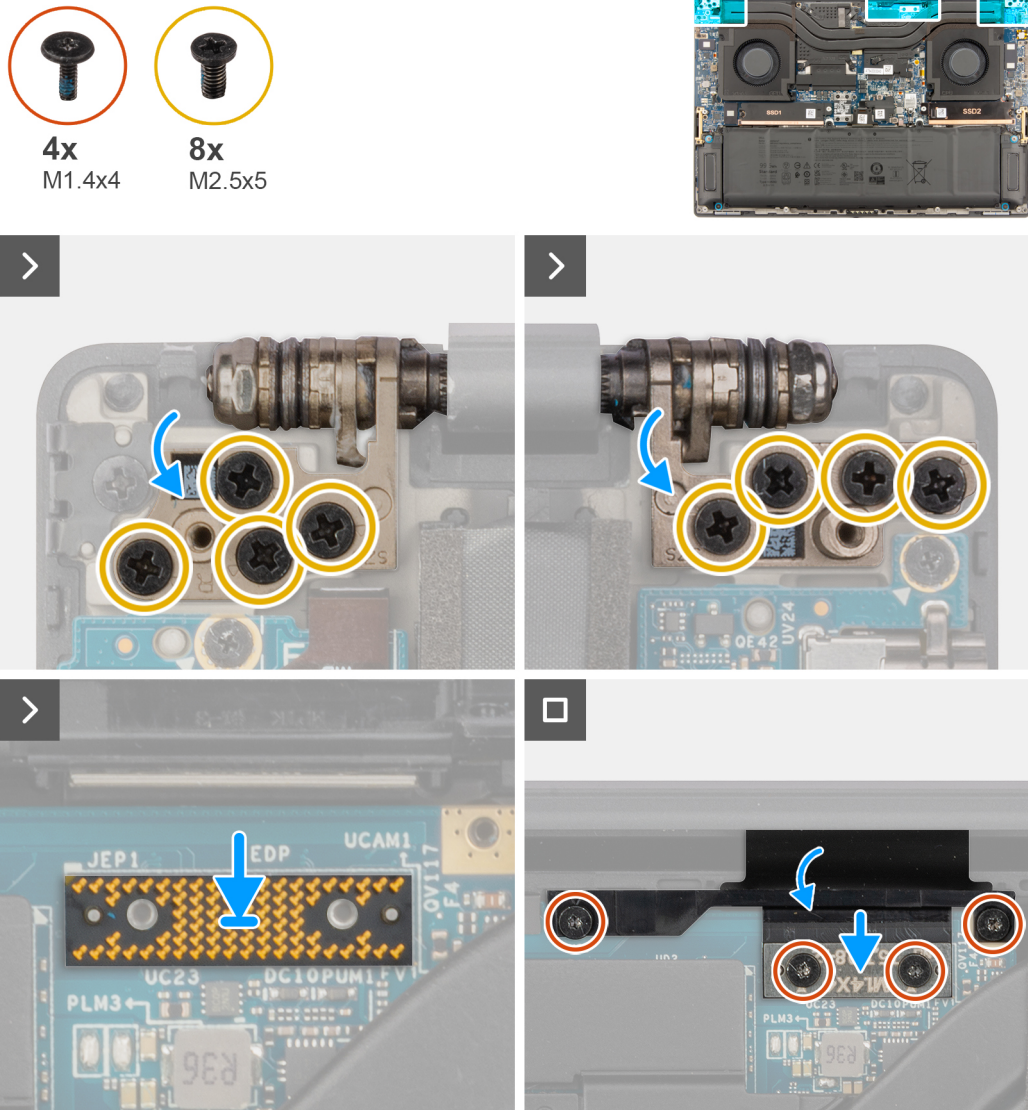

Figure 33. Installing the display assembly

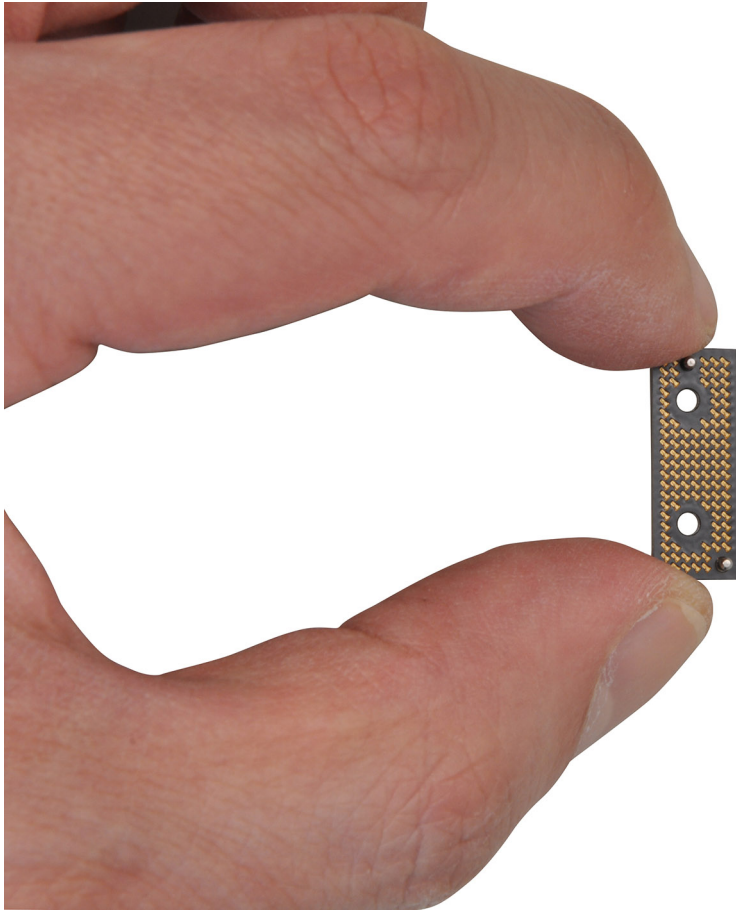

**Figure 34. Installing the display assembly**

**Steps**

1. Align and place the bottom assembly under the hinges of the display assembly.
2. Replace the eight screws (M2.5x5) to secure the display assembly to the computer.
3. Align and place the interposer board on the computer.

**CAUTION:** The pins on the interposer board are fragile. Avoid contact with the pins on the board. When handling the interposer board, lift and hold the board from the edges or the sides.



**Figure 35. Interposer board**

4. Connect the display-FPC cable to the connector on the system board.

**i** **NOTE:** Tuck the display FPC into the gap between the system board and the palm-rest before connecting the display FPC to the system board.

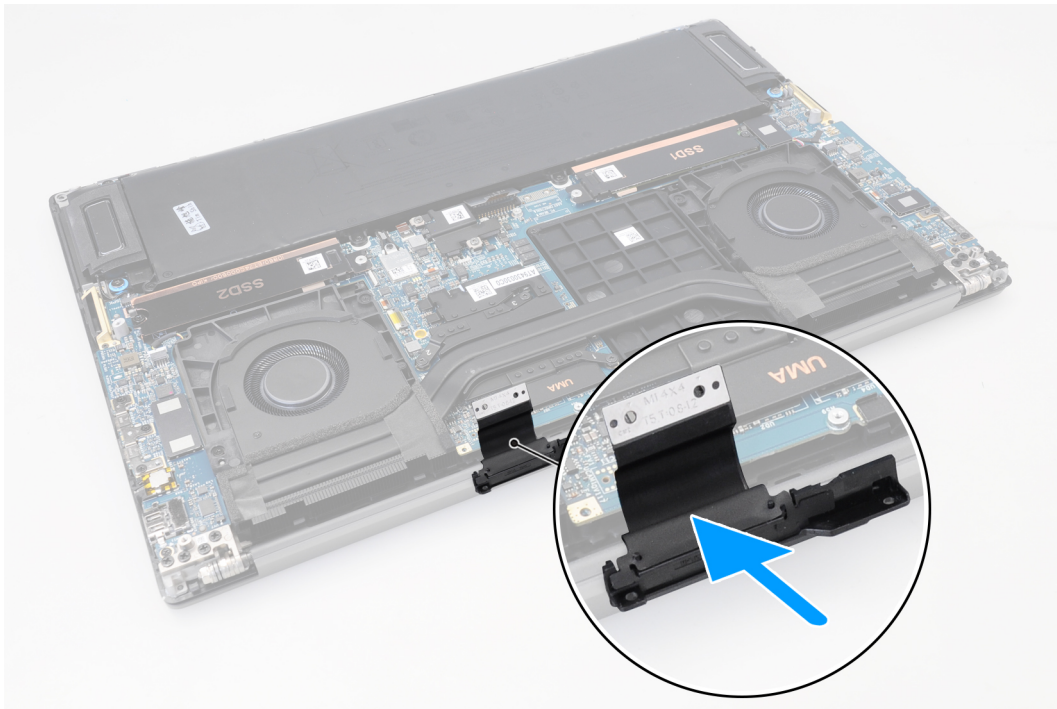

**Figure 36. Display FPC**

5. Replace the two torx screws (T5, M1.4x4) to secure the display-FPC cable in place.
6. Flip close the display-FPC cover.
7. Replace the two torx screws (T5, M1.4x4) to secure the display-FPC cover in place.

#### **Next steps**

1. Install the [heat sink](#) for computers that are shipped with a vapor chamber VC heat sink.
2. Install the [base cover](#).
3. Install the [SD card](#).
4. Follow the procedure in [After working inside your computer](#).

## **SD-card daughterboard**

### **Removing the SD-card daughterboard**

 **CAUTION:** The information in this removal section is intended for authorized service technicians only.

#### **Prerequisites**

1. Follow the procedure in [Before working inside your computer](#).
2. Remove the [SD card](#).
3. Remove the [base cover](#).
4. Remove the [battery](#).

#### **About this task**

 **NOTE:** The following procedure is applicable for computers that are shipped without a USH module only.

The following images indicate the location of the SD-card daughterboard and provide a visual representation of the removal procedure.

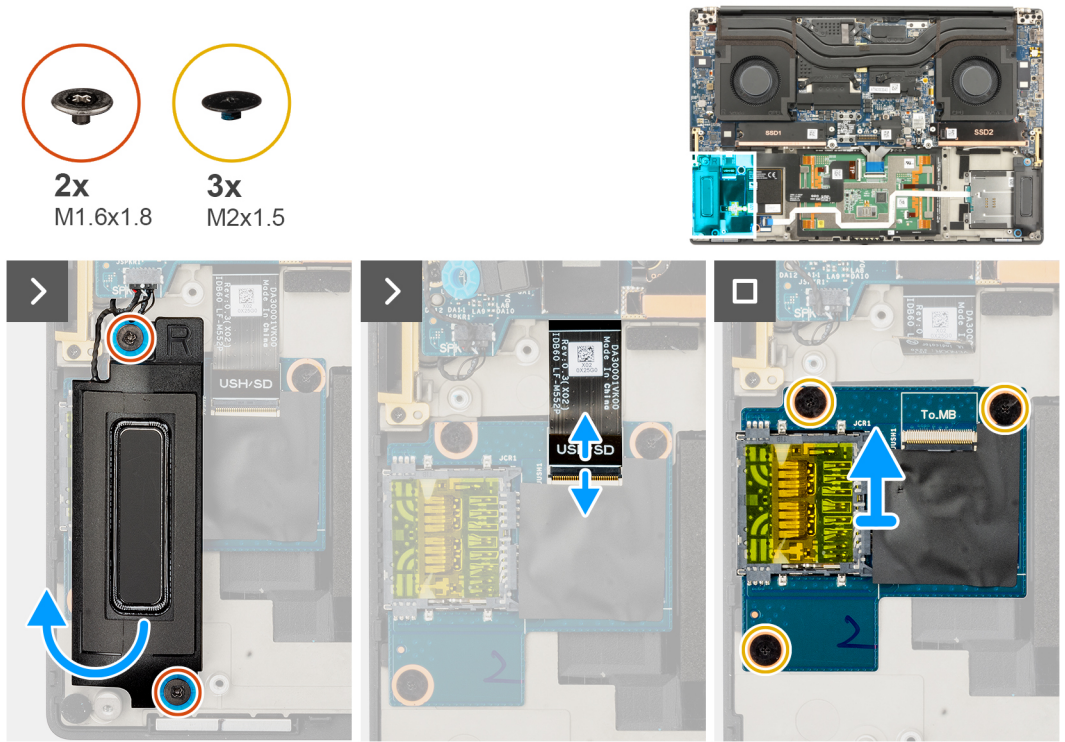

Figure 37. Removing the SD-card daughterboard

**Steps**

1. Remove the two screws (M1.6x1.8) that secure the right speaker in place.
2. Slightly lift the right speaker from the palm-rest assembly.

**CAUTION:** Do not remove the right speaker, as it is still attached to the tweeter underneath the system board.

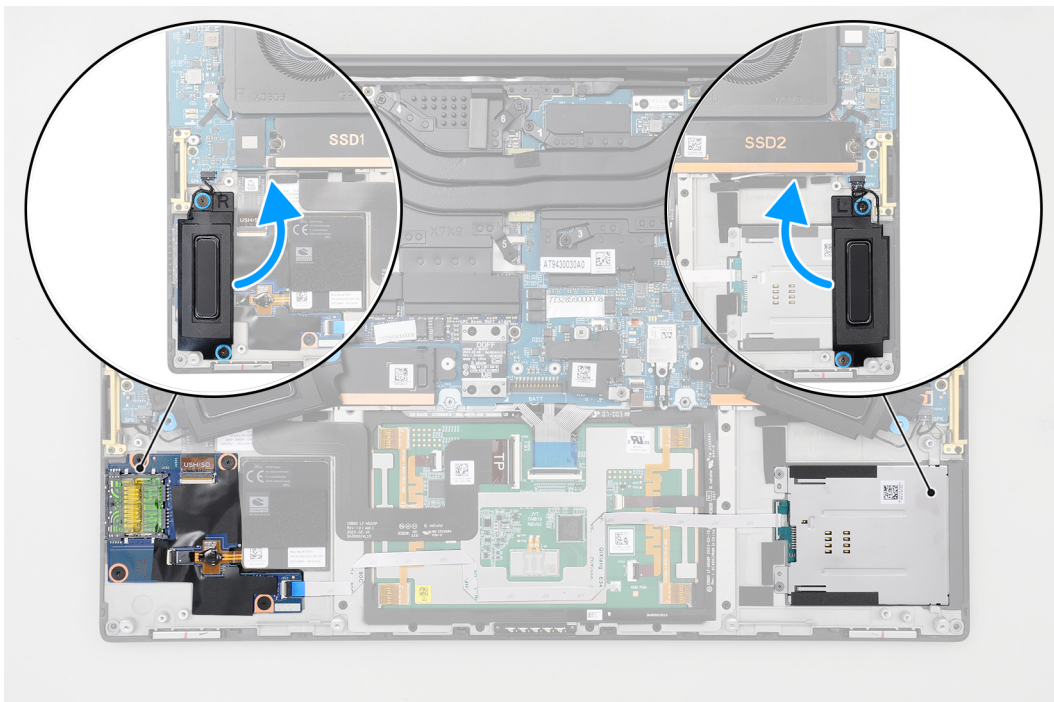

Figure 38. Speakers

3. Disconnect the SD-card daughterboard FPC from the connector on the SD-card daughterboard.
4. Remove the three screws (M2x1.5) that secure the SD-card daughterboard to the palm-rest assembly.
5. Lift and remove the SD-card daughterboard from the palm-rest assembly.

## Installing the SD-card daughterboard

**CAUTION:** The information in this installation section is intended for authorized service technicians only.

### Prerequisites

If you are replacing a component, remove the existing component before performing the installation procedure.

### About this task

**NOTE:** The following procedure is applicable for computers that are shipped without a USH module only.

The following image indicates the location of the SD-card daughterboard and provides a visual representation of the installation procedure.

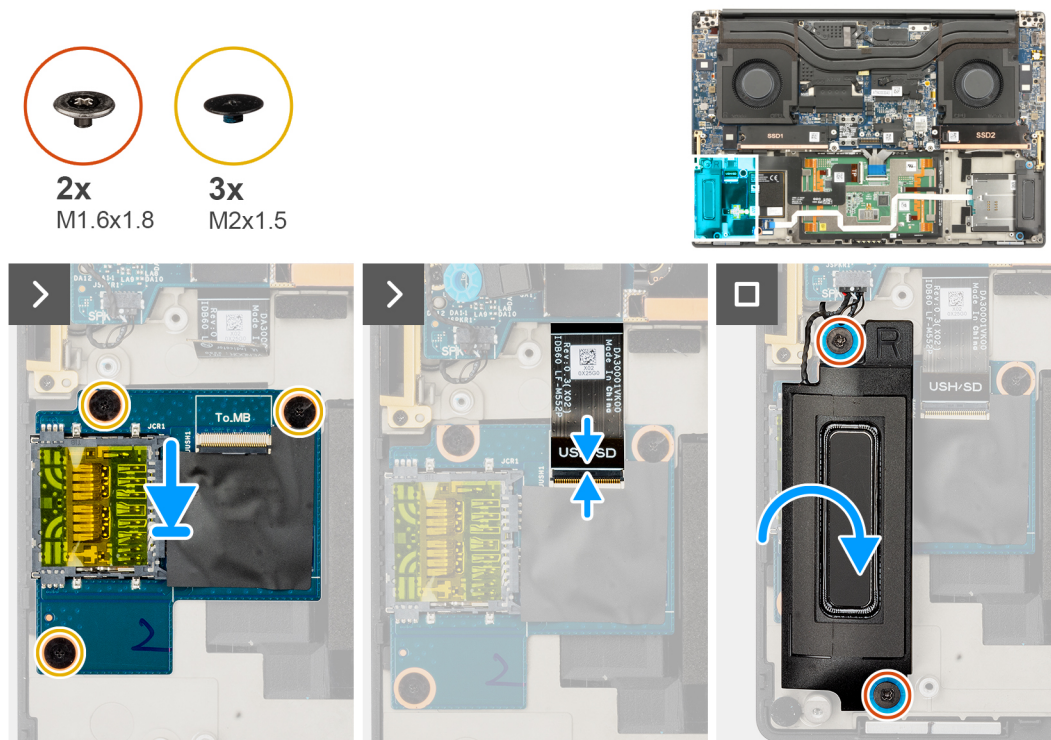

**Figure 39. Installing the SD-card daughterboard**

### Steps

1. Align and place the SD-card daughterboard into the slot on the palm-rest assembly.
2. Replace the three screws (M2x1.5) to secure the SD-card daughterboard to the palm-rest assembly.
3. Connect the SD-card daughterboard FPC cable to the connector on the SD card daughterboard.
4. Align and place the right speaker into the slot on the palm-rest assembly.
5. Replace the two screws (M1.6x1.8) to secure the right speaker in place.

### Next steps

1. Install the [battery](#).
2. Install the [base cover](#).
3. Install the [SD card](#).



4. Follow the procedure in [After working inside your computer](#).

# USH and SD-card daughterboard

## Removing the USH and SD-card daughterboard

**CAUTION:** The information in this removal section is intended for authorized service technicians only.

### Prerequisites

1. Follow the procedure in [Before working inside your computer](#).
2. Remove the [SD card](#).
3. Remove the [base cover](#).
4. Remove the [battery](#).

### About this task

**NOTE:** The following procedure is applicable for computers that are shipped with a USH module only.

The following images indicate the location of the USH and SD-card daughterboard and provide a visual representation of the removal procedure.

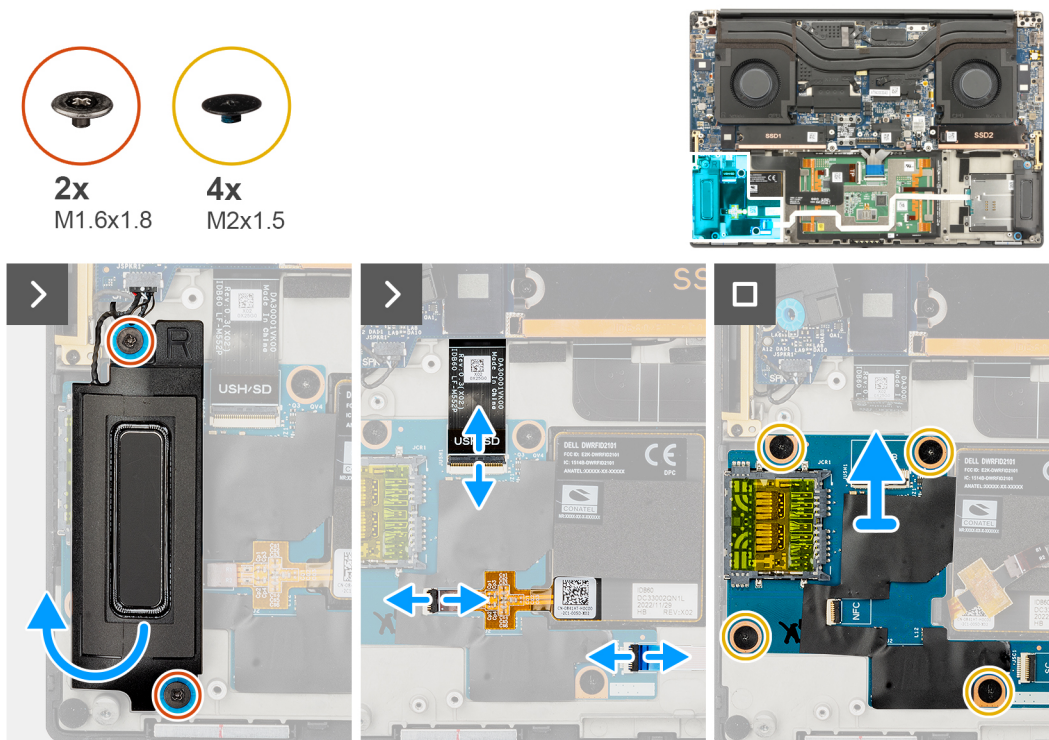
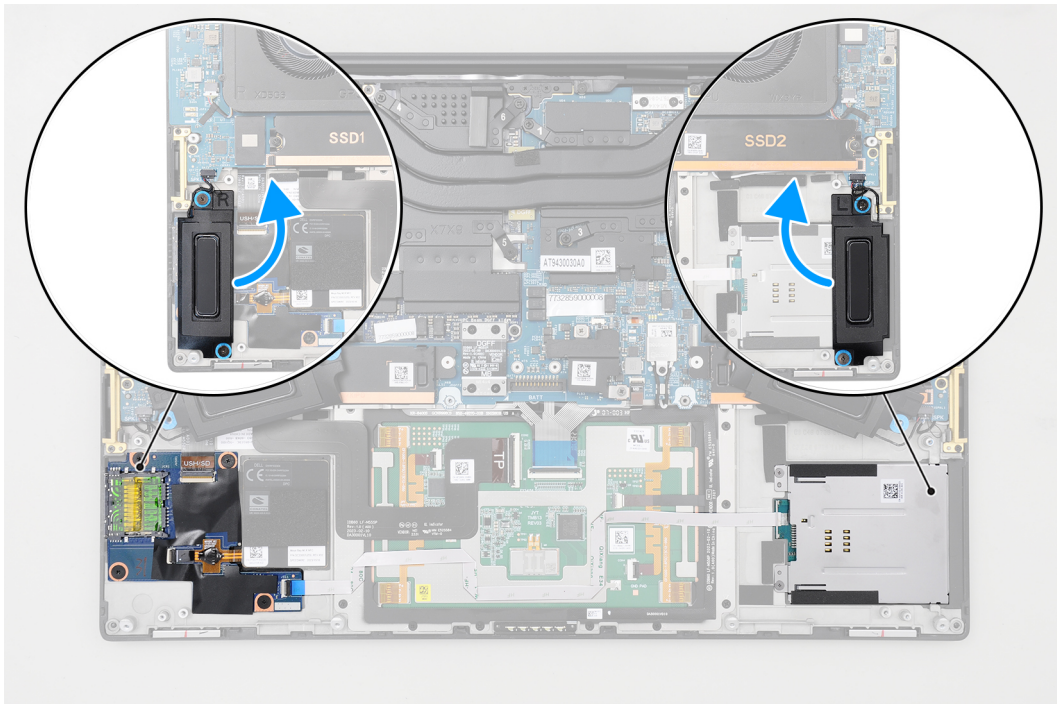

Figure 40. Removing the USH and SD-card daughterboard

### Steps

1. Remove the two screws (M1.6x1.8) that secure the right speaker in place.
2. Slightly lift the right speaker from the palm-rest assembly.

**CAUTION:** Do not remove the right speaker completely. It is still attached to the tweeter underneath the system board.



**Figure 41. Speakers**

3. Disconnect the USH and SD-card daughterboard FFC cable, smart-card reader FFC cable (for computers shipped with a smart card), and NFC module FFC cable from the connectors on the USH and SD-card daughterboard.
4. Peel back the NFC module FFC from the USH and SD-card daughterboard.
5. Remove the four (M2x1.5) screws that secure the USH and SD-card daughterboard to the palm-rest assembly.
6. Lift and remove the USH and SD-card daughterboard from the palm-rest assembly.

## Installing the USH and SD-card daughterboard

**CAUTION:** The information in this installation section is intended for authorized service technicians only.

### Prerequisites

If you are replacing a component, remove the existing component before performing the installation procedure.

### About this task

**NOTE:** The following procedure is applicable for computers that are shipped with a USH module only.

The following image indicates the location of the USH and SD-card daughterboard and provides a visual representation of the installation procedure.

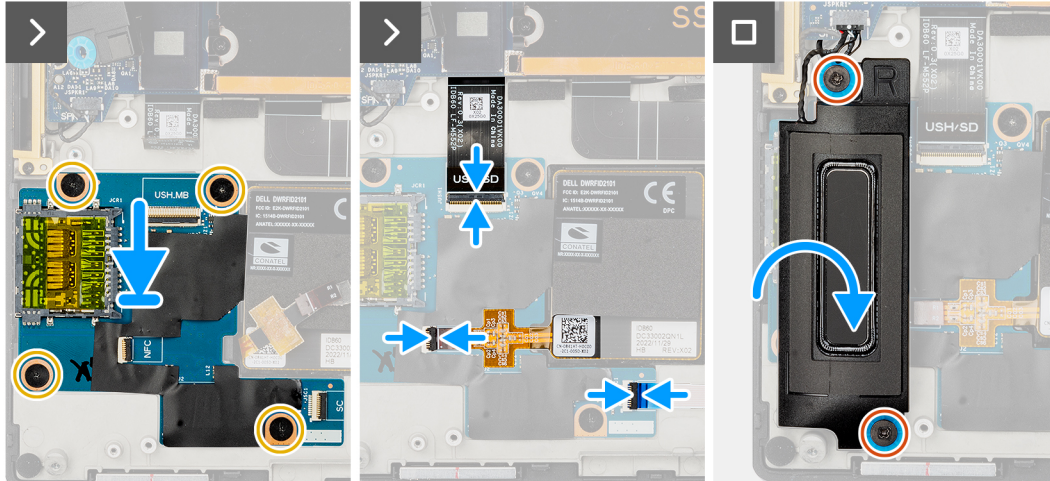
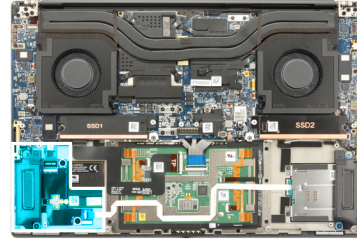
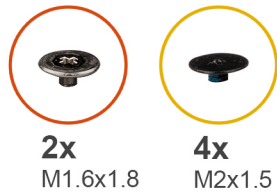

**Figure 42. Installing the USH and SD-card daughterboard**

### Steps

1. Align and place the USH and SD-card daughterboard into the slot on the palm-rest assembly.
2. Replace the four screws (M2x1.5) to secure the USH and SD-card daughterboard to the palm-rest assembly.
3. Adhere the NFC module FFC on the USH and SD-card daughterboard.
4. Connect the USH and SD-card daughterboard FFC cable, smart-card reader FFC cable (for computers shipped with a smart card), and NFC module FFC cable to the connector on the SD-card daughterboard.
5. Align and place the right speaker into the slot on the palm-rest assembly.
6. Replace the two screws (M1.6x1.8) to secure the right speaker in place.

### Next steps

1. Install the [battery](#).
2. Install the [base cover](#).
3. Install the [SD card](#).
4. Follow the procedure in [After working inside your computer](#).

## Smart-card reader daughterboard

### Removing the smart-card reader daughterboard

**CAUTION:** The information in this removal section is intended for authorized service technicians only.

### Prerequisites

1. Follow the procedure in [Before working inside your computer](#).
2. Remove the [SD card](#).
3. Remove the [base cover](#).
4. Remove the [battery](#).

## About this task

**NOTE:** The following procedure is applicable for computers that are shipped with a smart-card reader only.

The following images indicate the location of the smart-card reader and provide a visual representation of the removal procedure.

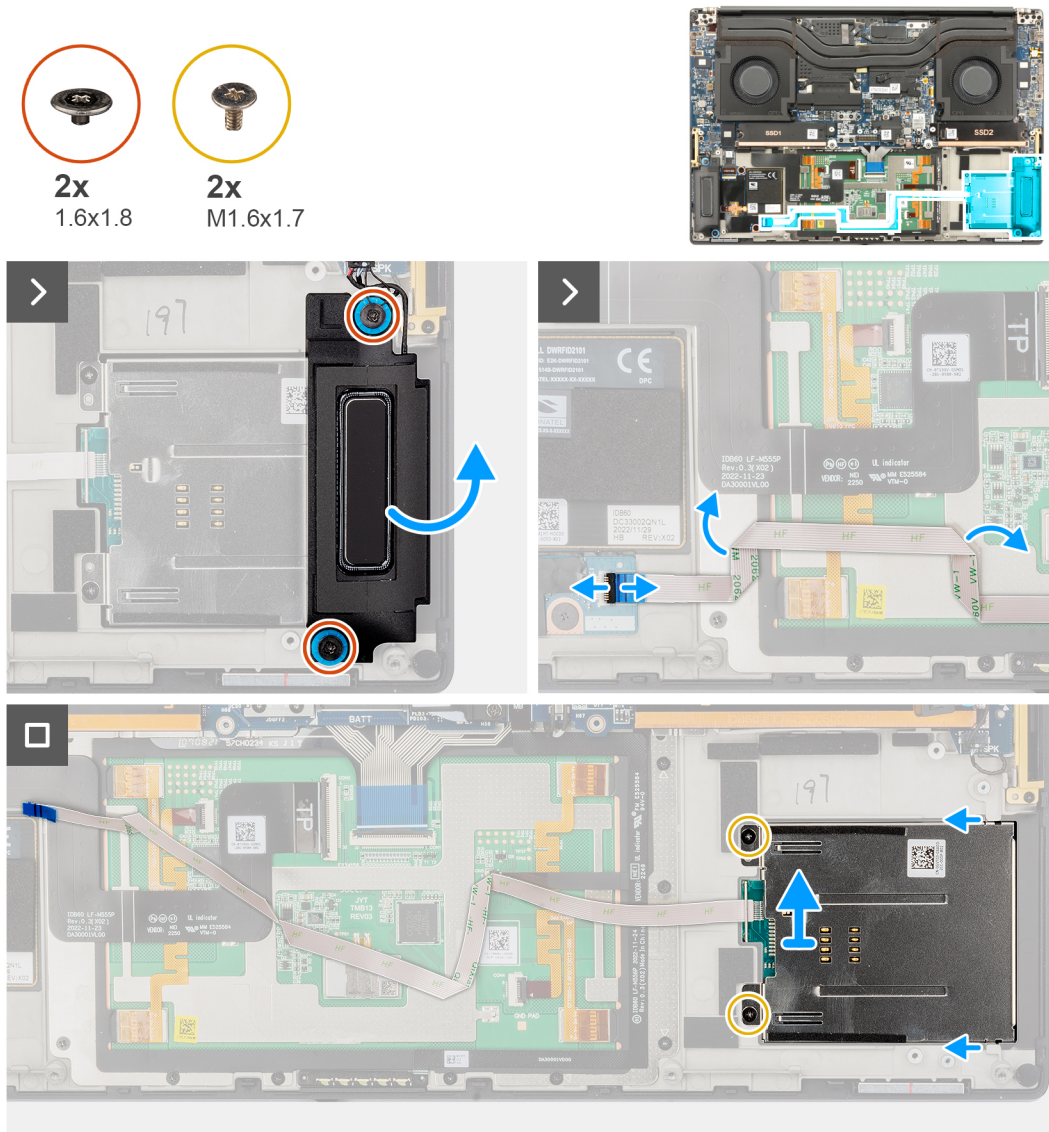
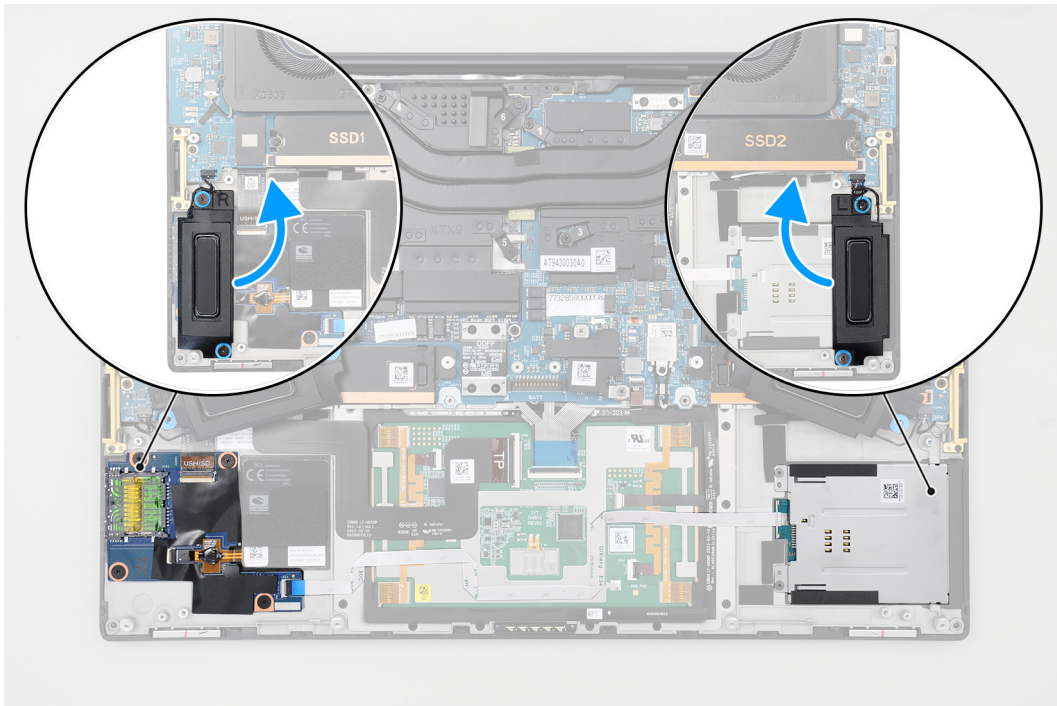

Figure 43. Removing the smart-card reader

## Steps

1. Remove the two screws (M1.6x1.8) that secure the left speaker in place.
2. Slightly lift the left speaker from the chassis.

**CAUTION:** Do not remove the left speaker completely. It is still attached to the tweeter underneath the system board.



**Figure 44. Speakers**

3. Disconnect the smart-card reader FFC cable from the connectors on the USH and SD-card daughterboard.
4. Peel back the smart-card reader FFC from the palm-rest assembly.
5. Remove the two screws (M1.6x1.7) that secure the smart-card reader in place.
6. Lift and remove the smart-card reader with the smart-card reader FFC from the chassis.

## Installing the smart-card reader daughterboard

**CAUTION:** The information in this installation section is intended for authorized service technicians only.

### Prerequisites

If you are replacing a component, remove the existing component before performing the installation procedure.

### About this task

**NOTE:** The following procedure is applicable for computers that are shipped with a smart-card reader only.

The following image indicates the location of the smart-card reader and provides a visual representation of the installation procedure.

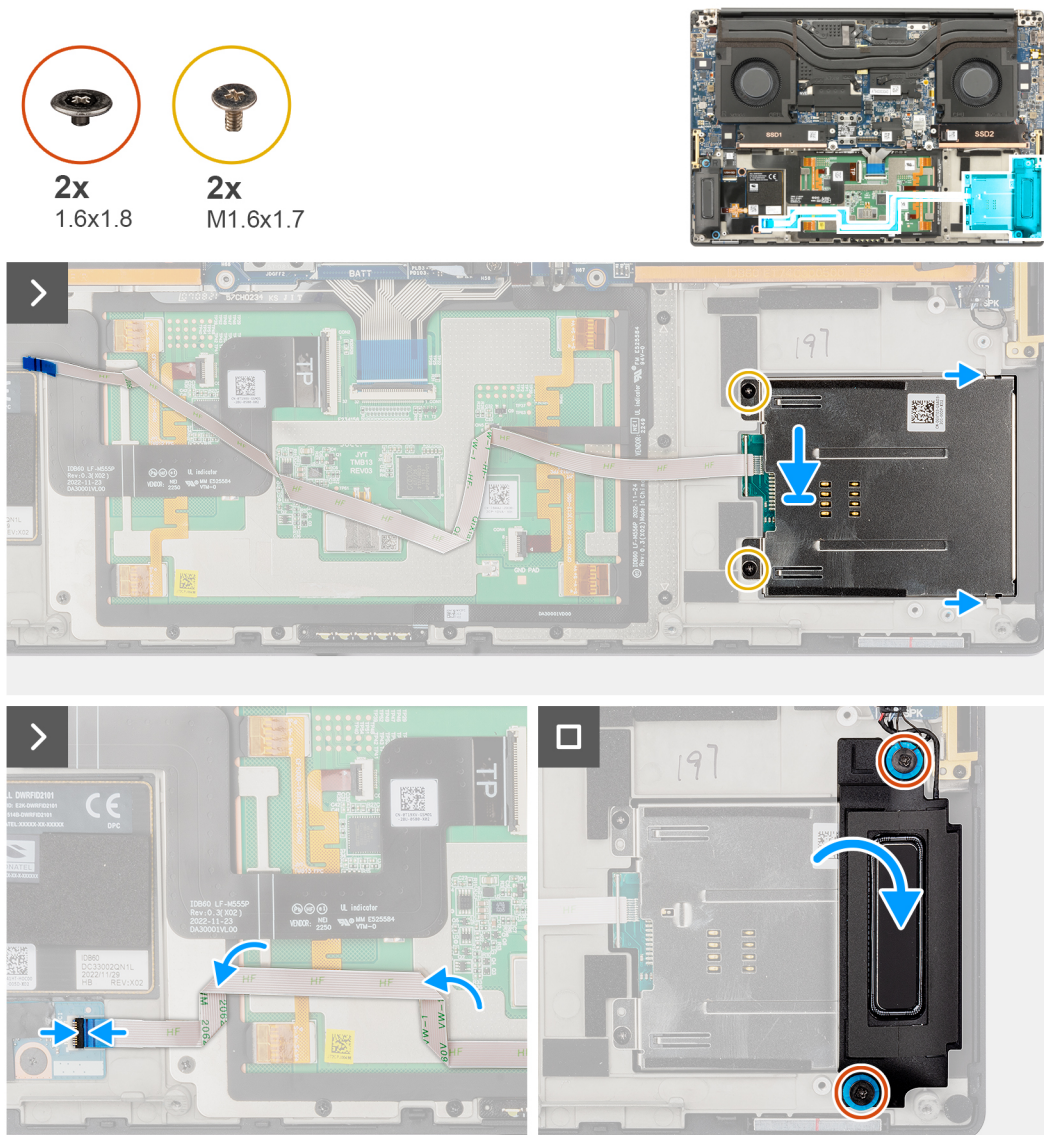

**Figure 45. Installing the smart-card reader**

**Steps**

1. Align and place the smart-card reader with the smart-card reader FFC into the slot on the chassis.
2. Replace the two screws (M1.6x1.7) to secure the smart-card reader to the chassis.
3. Adhere the smart-card reader FFC on the palm-rest assembly.
4. Connect the smart-card reader FFC cable to the connector on the USH and SD-card daughterboard.
5. Align and place the left speaker into the slot on the chassis.
6. Replace the two screws (M1.6x1.8) to secure the left speaker in place.

**Next steps**

1. Install the [battery](#).
2. Install the [base cover](#).
3. Install the [SD card](#).
4. Follow the procedure in [After working inside your computer](#).

# Graphics card

## Removing the graphics card

**CAUTION:** The information in this removal section is intended for authorized service technicians only.

### Prerequisites

1. Follow the procedure in [Before working inside your computer](#).
2. Remove the [SD card](#).
3. Remove the [base cover](#).
4. Remove the [battery](#).
5. Remove the [heat sink](#).

### About this task

**NOTE:** The following procedure is applicable for computers that are shipped with a graphics card only.

The following images indicate the location of the graphics card and provide a visual representation of the removal procedure.

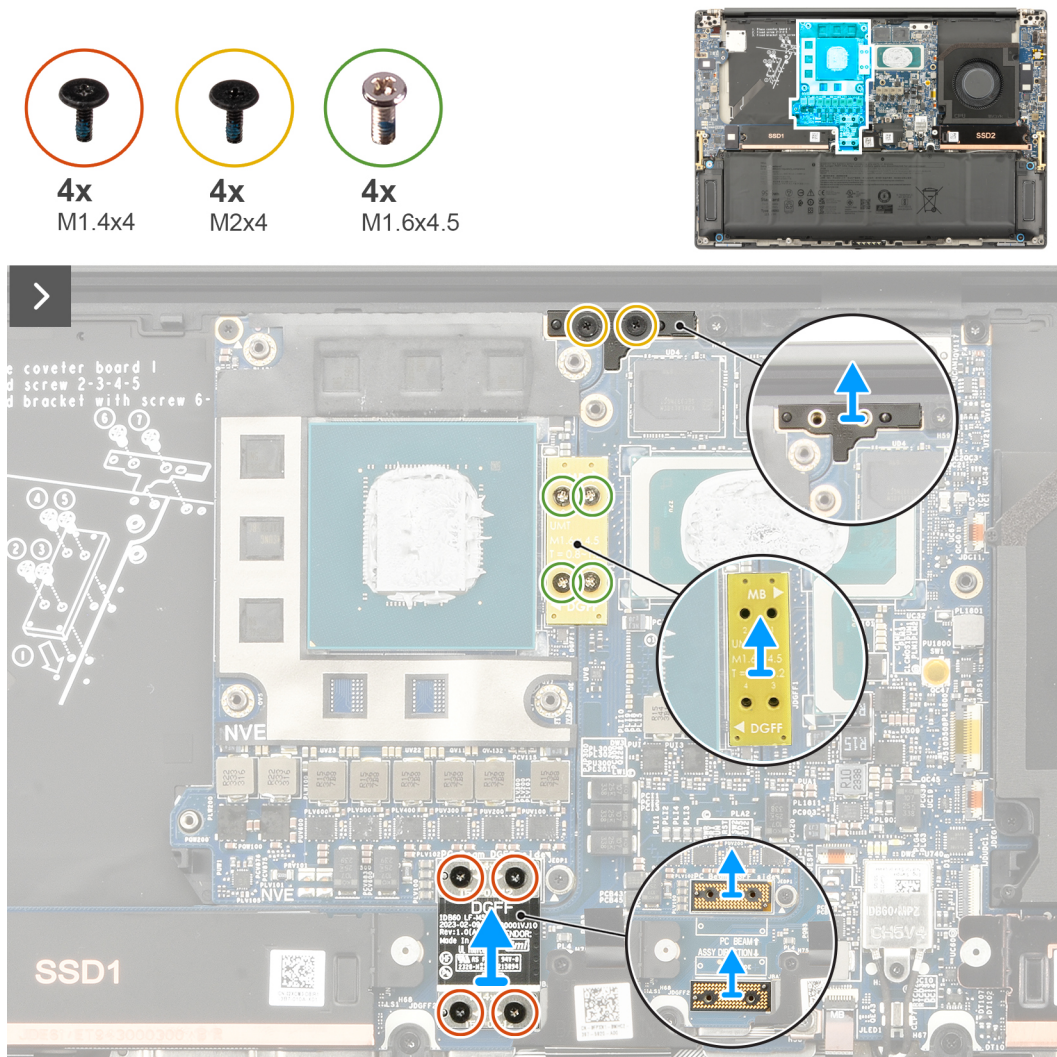
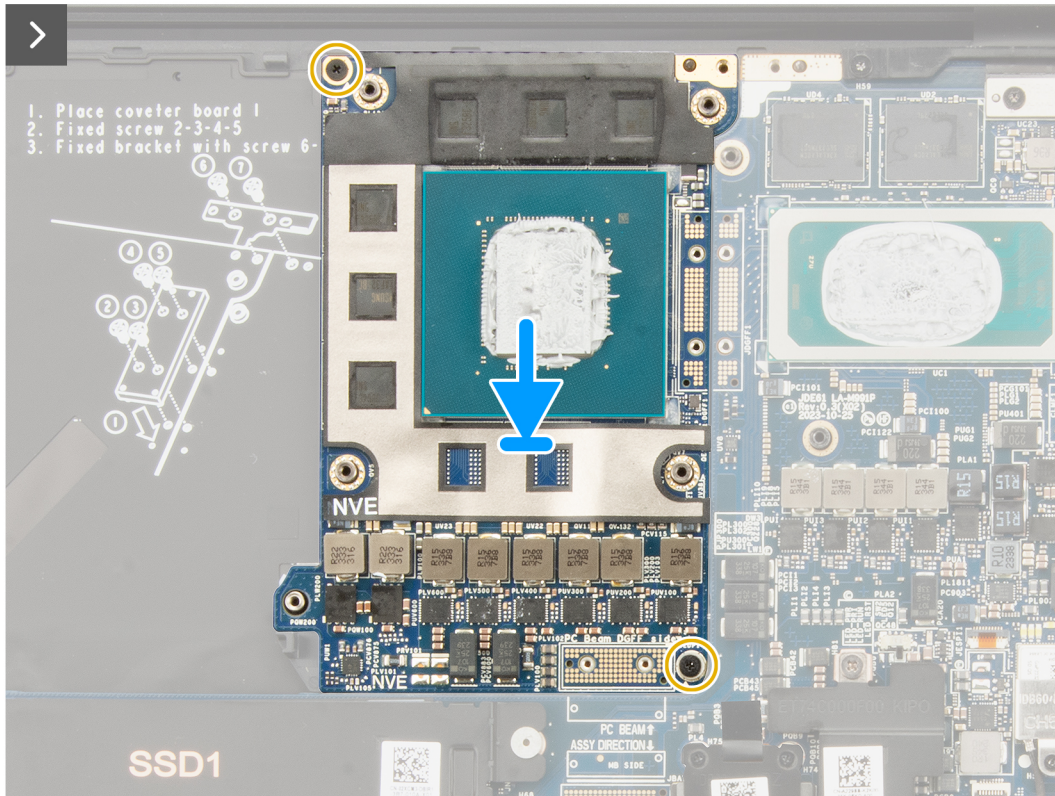
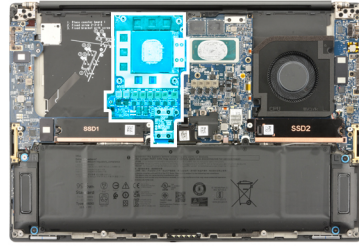

Figure 46. Removing the graphics card



**Figure 47. Removing the graphics card**

### Steps

1. Remove the four torx screws (T5, M1.4x4) sequentially as mentioned on the graphics-card FPC that secures the graphics-card FPC in place.
2. Remove the graphics-card FPC from the connector on the system board.
3. Remove the two graphics-card FPC interposer boards from the system board.

**NOTE:** The pins on the interposer board are fragile. Avoid contact with the pins on the board. When handling the interposer board, lift and hold the board from the edges or the sides.



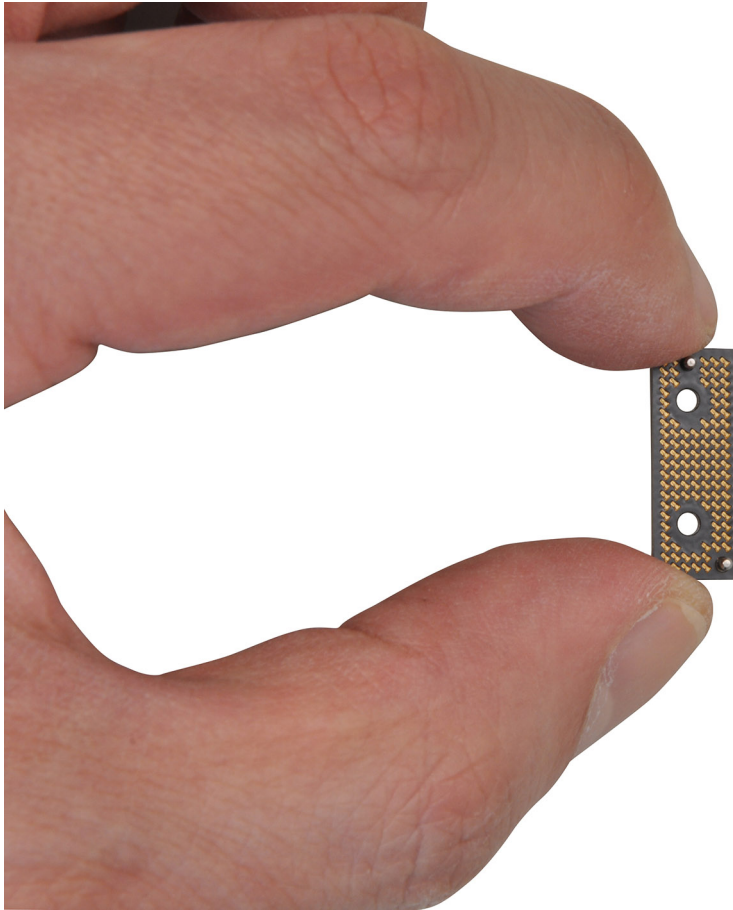

**Figure 48. Interposer board**

4. Remove the four screws (M1.6x4.5) that secure the graphics-card bridge in place.
5. Remove the graphics-card bridge from the system board.
6. Remove the two screws (M2x4) that secure the PC-bridge bracket in place.
7. Remove the PC-bridge bracket from the system board.
8. Remove the two screws (M2x4) that secure the graphics card in place.
9. Remove the graphics card from the system board.

## Installing the graphics card

**CAUTION:** The information in this installation section is intended for authorized service technicians only.

### Prerequisites

If you are replacing a component, remove the existing component before performing the installation procedure.

### About this task

**NOTE:** The following procedure is applicable for computers that are shipped with a graphics card only.

The following image indicates the location of the graphics card and provides a visual representation of the installation procedure.



4x  
M1.4x4



4x  
M2x4



4x  
M1.6x4.5

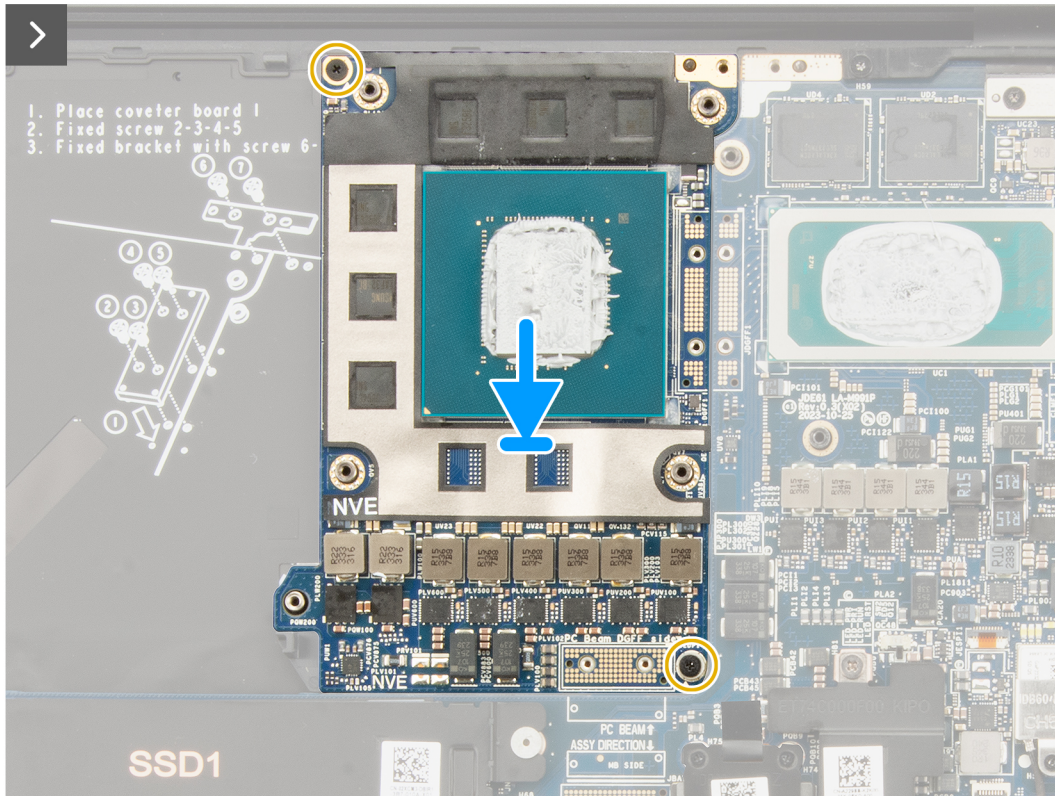
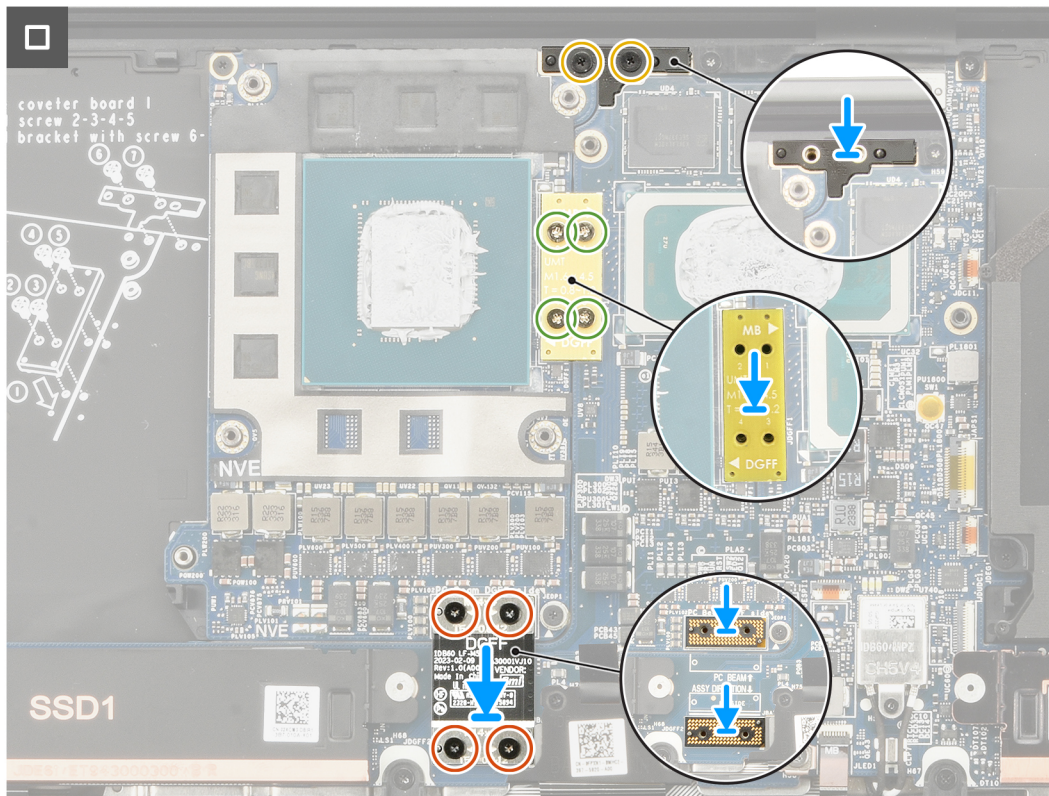

Figure 49. Installing the graphics card



**Figure 50. Installing the graphics card**

**Steps**

1. Align and place the graphics card into the slot on the system board.
2. Replace the two screws (M2x4) to secure the graphics card in place.
3. Align and place the PC-bridge bracket into the slot on the system board.
4. Replace the two screws (M2x4) to secure the PC-bridge bracket in place.
5. Align and place the graphics-card bridge into the slot on the system board.
6. Replace the four screws (M1.6x4.5) to secure the graphics-card bridge in place.

**NOTE:** Ensure that the graphics-card bridge is installed with the correct polarity as indicated by the labeling - distinguishing between DGFF (graphics side) and MB (Motherboard side).

7. Align and place the two graphics-card FPC interposer boards into the slot on the system board.
8. Align and place the graphics-card FPC into the slot on the system board.
9. Replace the four torx screws (T5, M1.4x4) sequentially as mentioned on the graphics-card FPC to secure the graphics-card FPC in place.

**Next steps**

1. Install the [heat sink](#).
2. Install the [battery](#).
3. Install the [base cover](#).
4. Install the [SD card](#).
5. Follow the procedure in [After working inside your computer](#).

# Dummy graphics card

## Removing the dummy graphics card

**CAUTION:** The information in this removal section is intended for authorized service technicians only.

### Prerequisites

1. Follow the procedure in [Before working inside your computer](#).
2. Remove the [SD card](#).
3. Remove the [base cover](#).
4. Remove the [battery](#).
5. Remove the [heat sink](#).

### About this task

**NOTE:** The following procedure is applicable for computers that are shipped with an integrated graphics only.

The following images indicate the location of the dummy graphics card and provide a visual representation of the removal procedure.

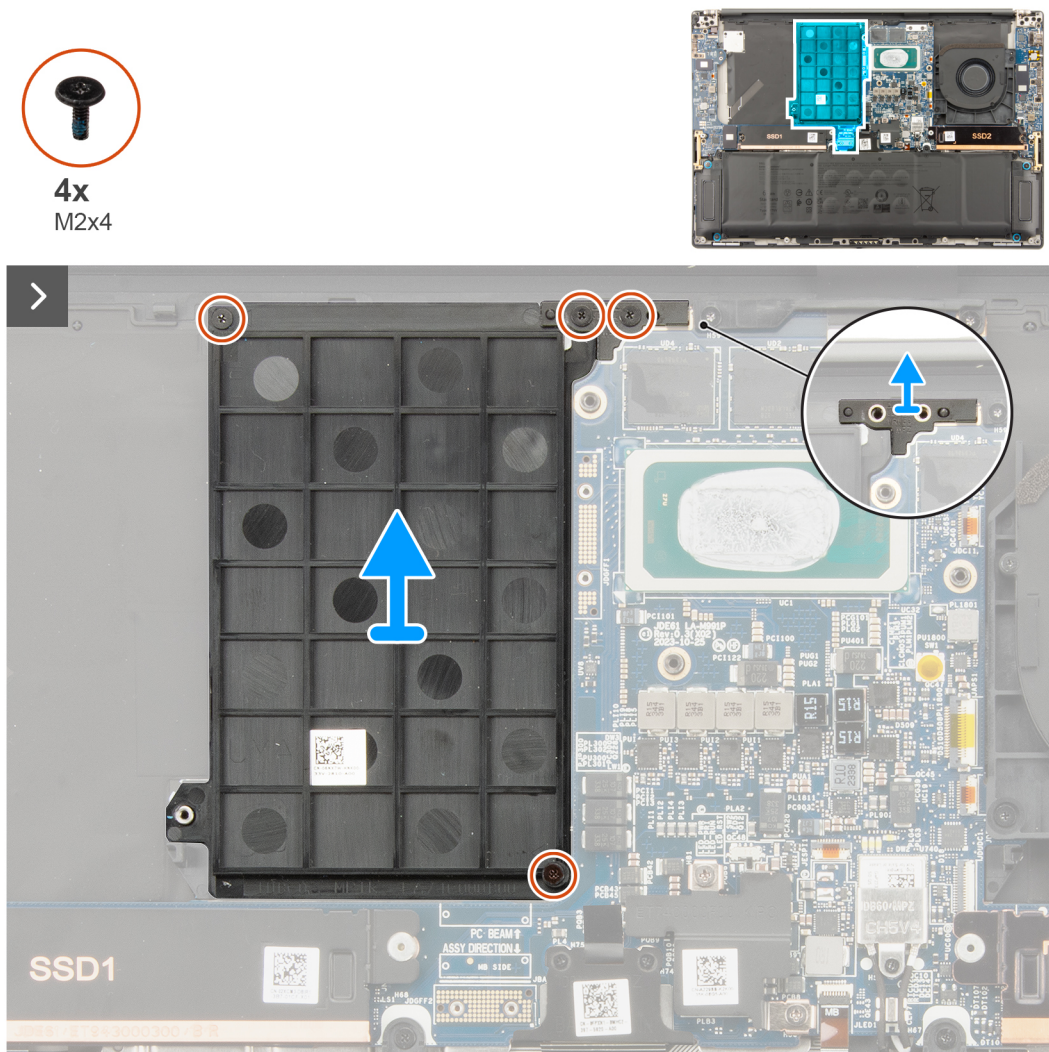

Figure 51. Removing the dummy graphics card

## Steps

1. Remove the two screws (M2x4) that secure the PC-bridge bracket in place.
2. Remove the PC-bridge bracket from the system board.
3. Remove the two screws (M2x4) that secure the dummy graphics card in place.
4. Remove the dummy graphics card from the system board.

## Installing the dummy graphics card

**CAUTION:** The information in this installation section is intended for authorized service technicians only.

### Prerequisites

If you are replacing a component, remove the existing component before performing the installation procedure.

### About this task

**NOTE:** The following procedure is applicable for computers that are shipped with an integrated graphics only.

The following image indicates the location of the dummy graphics card and provides a visual representation of the installation procedure.

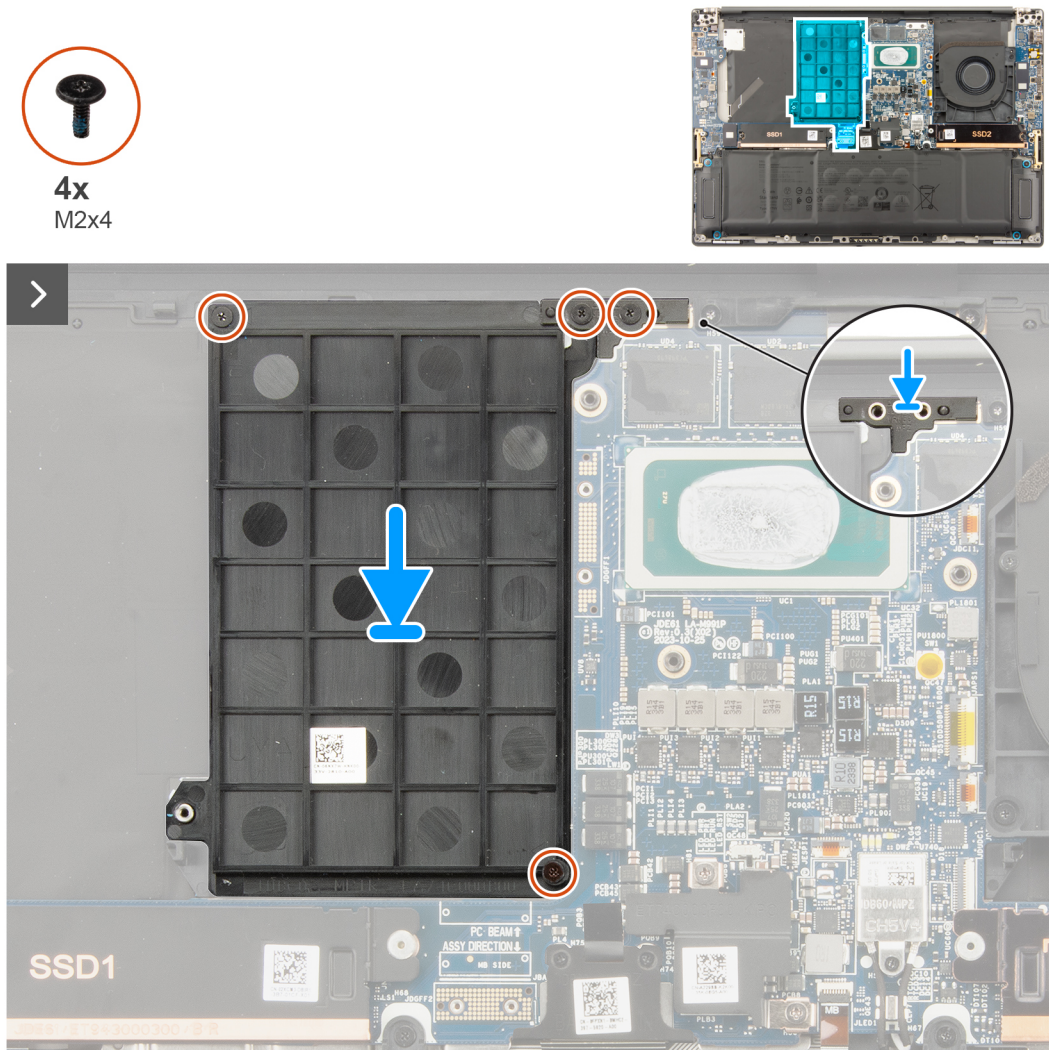

Figure 52. Installing the dummy graphics card

### Steps

1. Align and place the dummy graphics card into the slot on the system board.
2. Replace the two screws (M2x4) to secure the dummy graphics card in place.
3. Align and place the PC-bridge bracket into the slot on the system board.
4. Replace the two screws (M2x4) to secure the PC-bridge bracket in place.

### Next steps

1. Install the [heat sink](#).
2. Install the [battery](#).
3. Install the [base cover](#).
4. Install the [SD card](#).
5. Follow the procedure in [After working inside your computer](#).

## System board

### Removing the system board

 **CAUTION:** The information in this removal section is intended for authorized service technicians only.

#### Prerequisites

1. Follow the procedure in [Before working inside your computer](#).
2. Remove the [SD card](#).
3. Remove the [base cover](#).
4. Remove the [M.2 2230 solid state drive](#) or [M.2 2280 solid state drive](#).
5. Remove the [battery](#).
6. Remove the [processor fan](#).
7. Remove the [graphics-card fan](#).
8. Remove the [heat sink](#).

## About this task

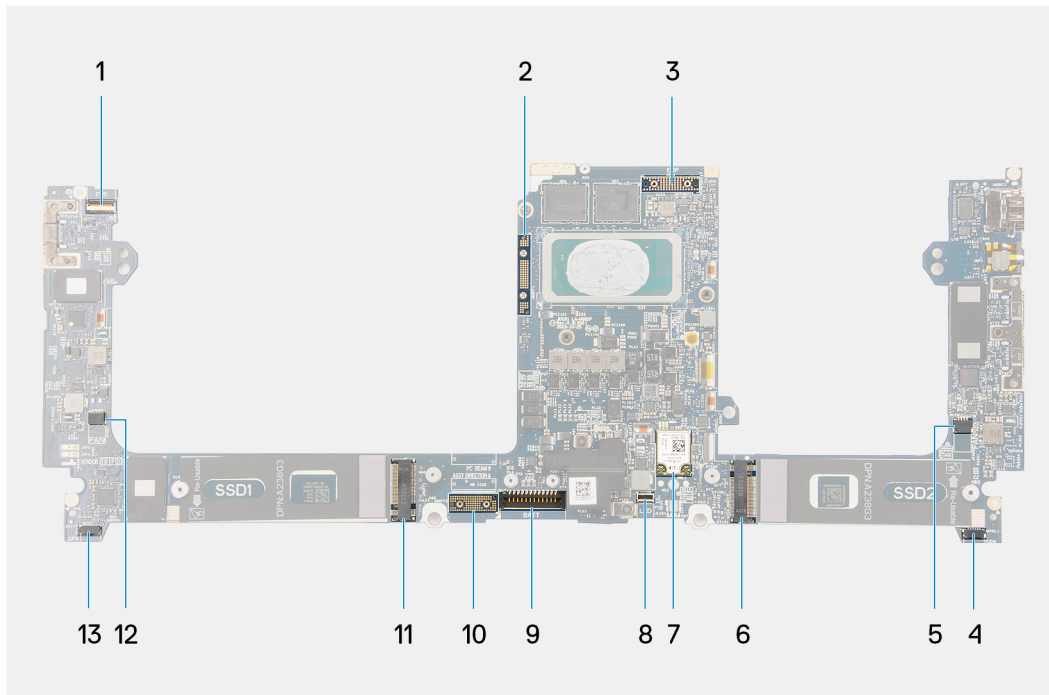

**Figure 53. Connectors on your system board**

1. Power button with fingerprint reader cable connector
2. Graphics-card bridge
3. Display-FPC cable
4. Left-speaker cable connector
5. Processor-fan cable connector
6. Solid state drive connector
7. WLAN-antenna connector
8. Keyboard backlit cable connector
9. Battery-cable connector
10. Graphics-card FPC interposer board
11. Solid state drive
12. Graphics-card fan cable connector
13. Right-speaker cable connector

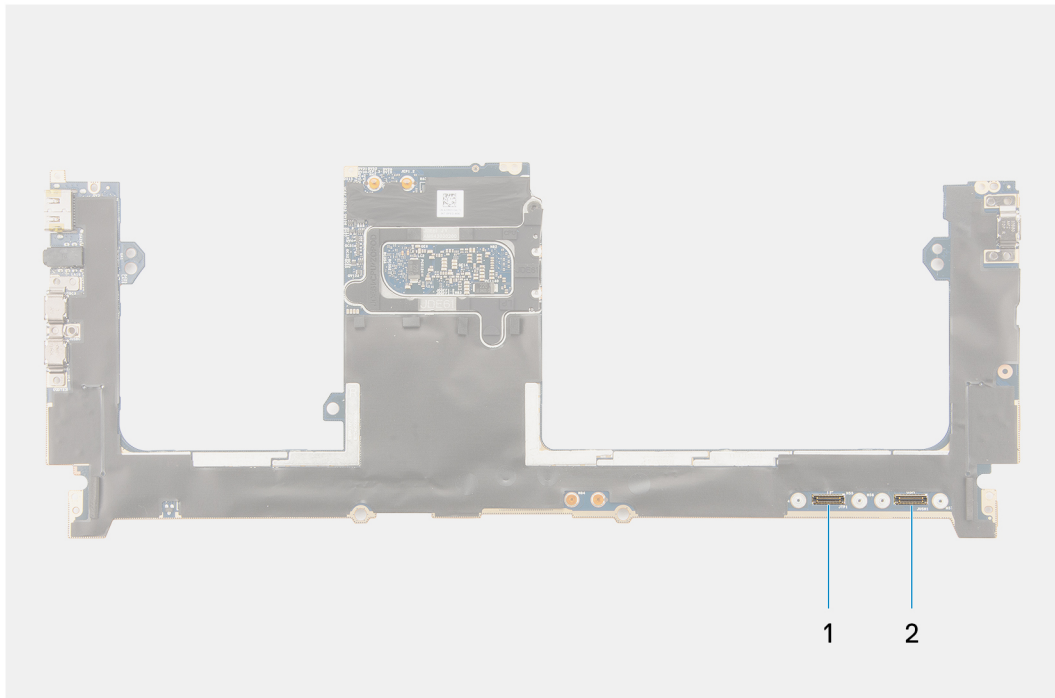

**Figure 54. Connectors on your system board**

1. Haptics touchpad cable connector
2. USH I/O board cable connector

The following images indicate the location of the system board assembly and provide a visual representation of the removal procedure.





Figure 55. Removing the system board

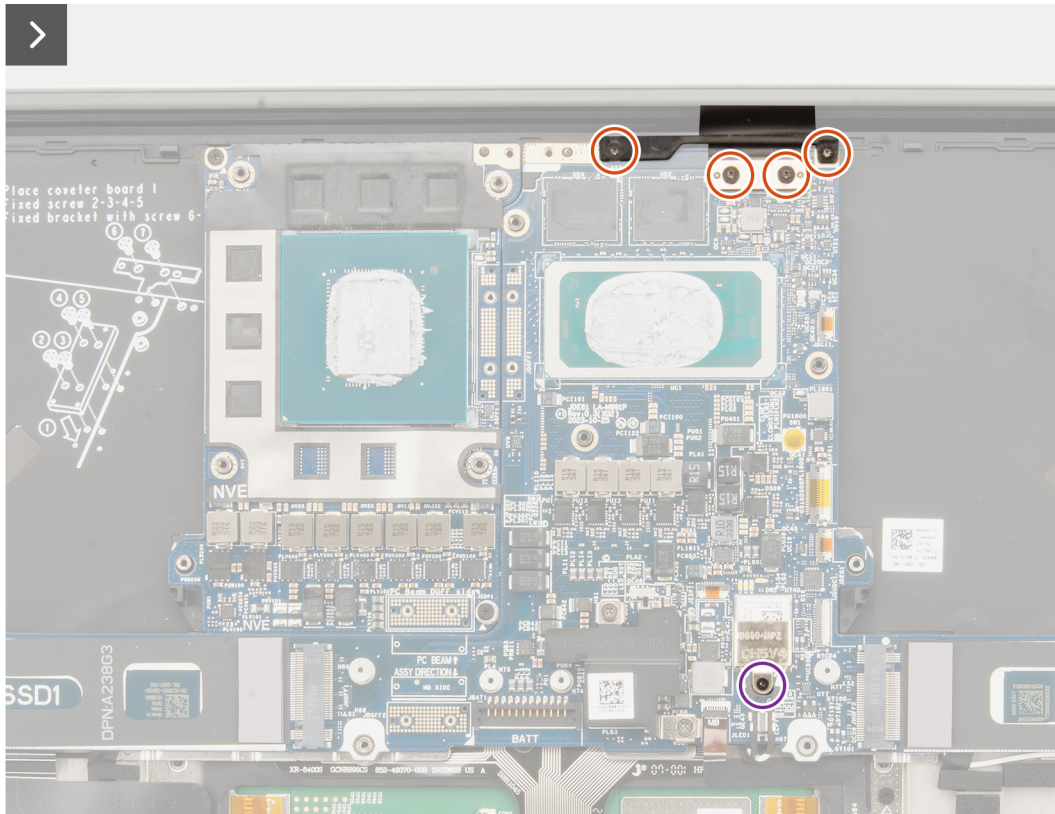

Figure 56. Removing the system board

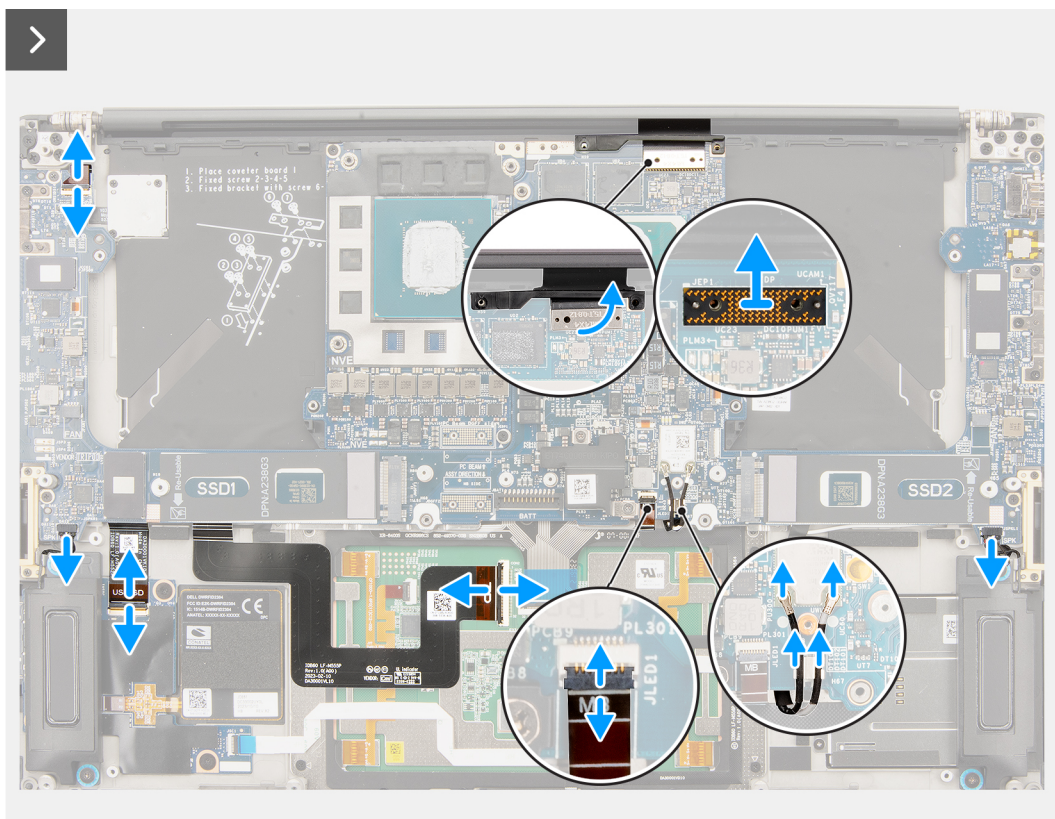
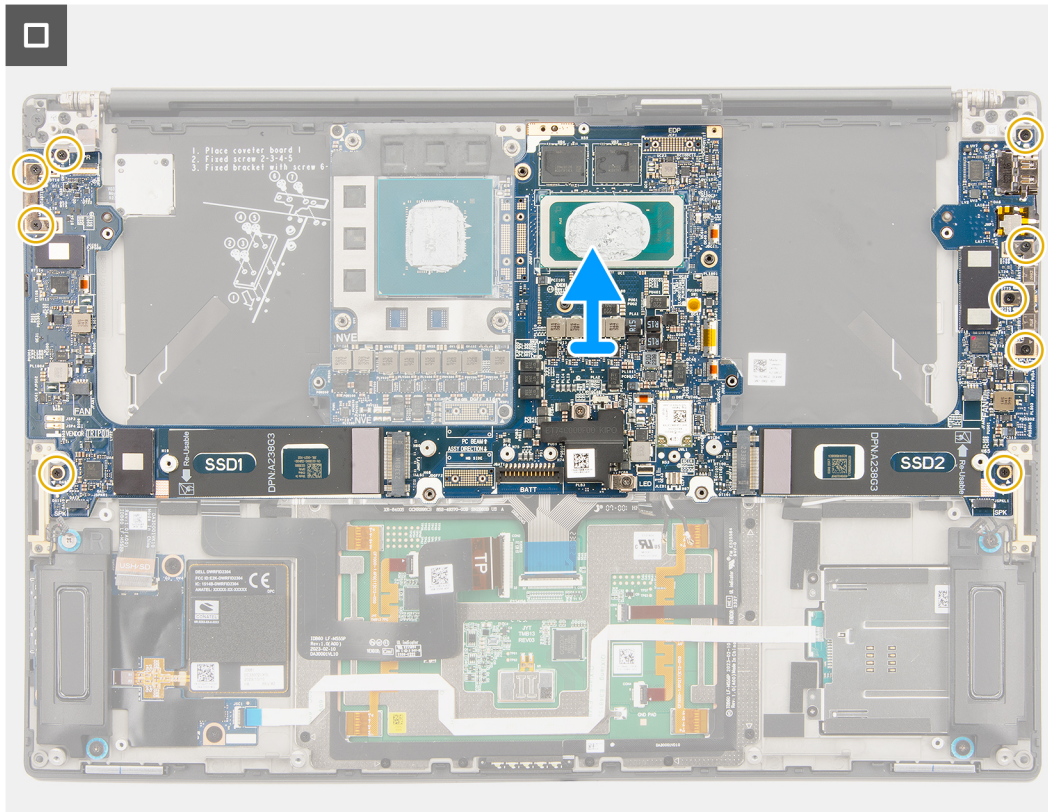

Figure 57. Removing the system board

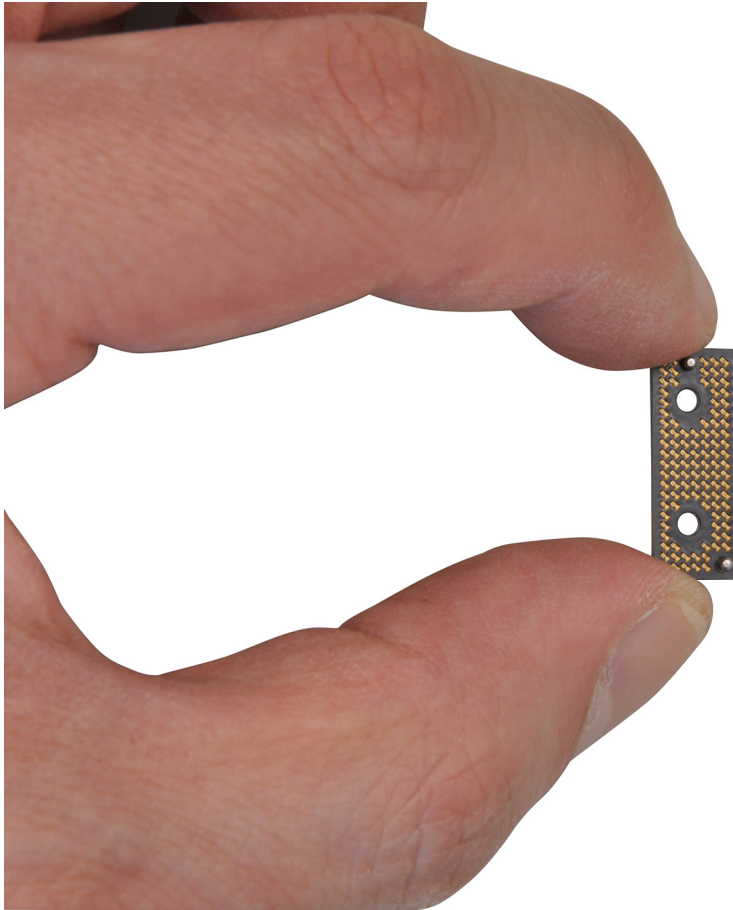

**Figure 58. Removing the system board**

**Steps**

1. For computers shipped with a graphics card, remove the four torx screws (T5, M1.4x4) that secure the graphics-card FPC in place.
2. For computers shipped with a graphics card, remove the graphics-card FPC from the system board.
3. For computers shipped with a graphics card, remove the two graphics-card FPC interposer boards from the system board.
4. For computers shipped with a graphics card, remove the four screws (M1.6x4.5) that secure the graphics-card bridge in place.
5. For computers shipped with a graphics card, remove the graphics-card bridge from the system board.
6. For computers shipped with a WLAN card, loosen the captive screw that secures the WLAN bracket in place.
7. For computers shipped with a WLAN card, remove the WLAN bracket from the system board.
8. For computers shipped with a WLAN card, disconnect the antenna cables from the connectors on the WLAN module.
9. For computers shipped with a WLAN card, remove the antenna cables from the metal clips on the system board.
10. Remove the two screws (M1.4x4) that secure the display-FPC cover in place.
11. Flip open the display-FPC cover.
12. Remove the two torx screws (T5, M1.4x4) that secure the display FPC in place.
13. Disconnect the display-FPC cable from the connector on the system board.
14. Remove the display-FPC interposer board from the system board.

**i NOTE:** The pins on the interposer boards that connect the FPCs to the computer or daughter board are fragile. Technicians should avoid pushing or applying pressure to the pins on the interposer boards. Refrain from performing any action that may scratch the pins, such as rotating or turning the boards while they are in contact with any surface. When handling the interposer board, lift and hold the board from the edges or the sides.



**Figure 59. Interposer board**

15. For computers shipped without a USH module, disconnect the SD-card daughterboard FPC cable from the connector on the SD-card reader daughterboard.
16. For computers shipped with a USH module, disconnect the USH and SD-card daughterboard FPC cable from the connector on the USH and SD-card daughterboard.
17. Disconnect the Haptics touchpad FPC cable from the connector on the Haptics touchpad module.
18. Peel the SD-card daughterboard FPC/USH and SD-card daughterboard FPC cable and Haptics touchpad FPC cable from the palm-rest assembly.
19. Disconnect the power button with fingerprint reader FPC cable, right speaker cable, front LED FPC cable, and left speaker cable from the connectors on the system board.
20. Remove the two screws (M2x4) that secure the PC-bridge bracket in place.
21. Remove the PC-bridge bracket from the system board.
22. Remove the nine screws (M2x4) that secure the system board to the palm-rest assembly.
23. Remove the system board off the chassis.

**i NOTE:** Replacement of the system board requires further removal of the Haptics touchpad FPC and USH board FPC. They must be transferred to the new replacement system board. See disassembly procedures of Haptics touchpad and SD-card daughterboard FPC/USH and SD-card daughterboard FPC for more information.

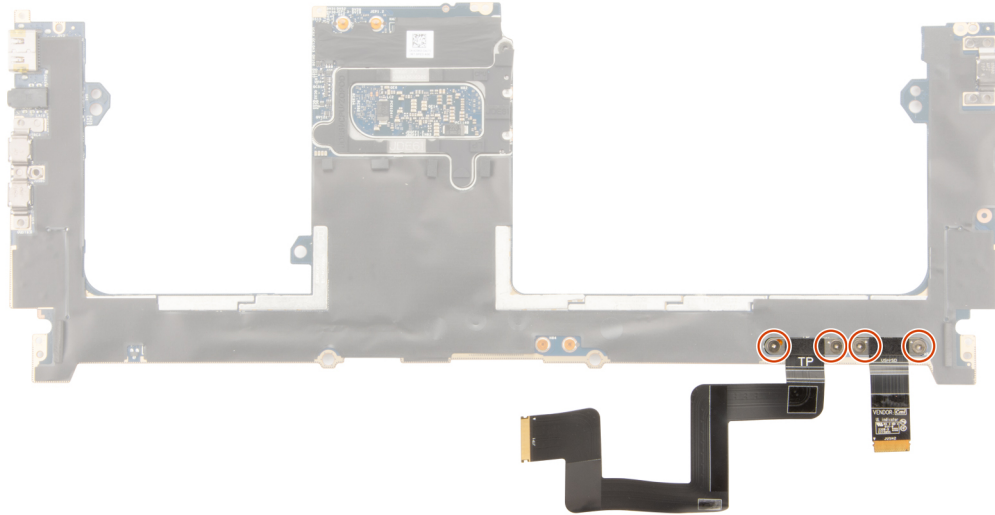

Figure 60. Touchpad FPC and USH board FPC

## Installing the system board

**CAUTION:** The information in this removal section is intended for authorized service technicians only.

### Prerequisites

If you are replacing a component, remove the existing component before performing the installation procedure.

### About this task

The following image indicates the location of the system board and provides a visual representation of the installation procedure.

**NOTE:** Replacement of the system board requires further removal of the Haptics touchpad FPC and SD-card daughterboard FPC/USH and SD-card daughterboard FPC. See disassembly procedures of Haptics touchpad and SD-card daughterboard FPC/USH and SD-card daughterboard FPC for more information.

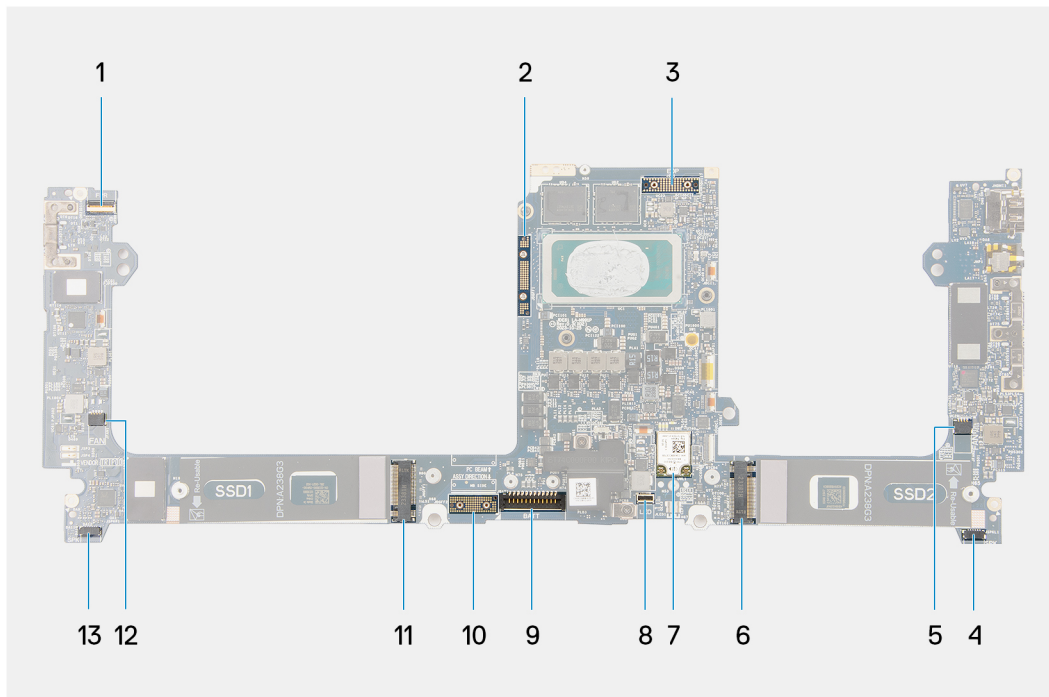

**Figure 61. Connectors on your system board**

1. Power button with fingerprint reader cable connector
2. Graphics-card bridge
3. Display-FPC cable
4. Left-speaker cable connector
5. Processor-fan cable connector
6. Solid state drive connector
7. WLAN-antenna connector
8. Keyboard backlit cable connector
9. Battery cable connector
10. Graphics-card FPC interposer board
11. Solid state drive
12. Graphics-fan cable connector
13. Right-speaker cable connector

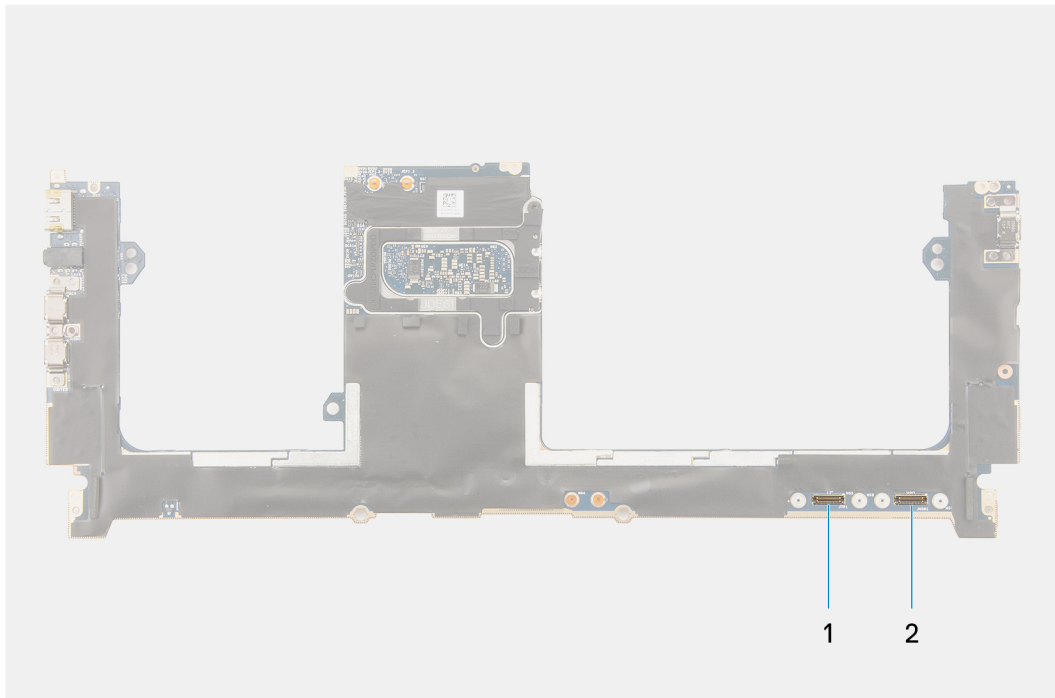

**Figure 62. Connectors on your system board**

1. Haptics touchpad cable connector
2. USB I/O board cable connector

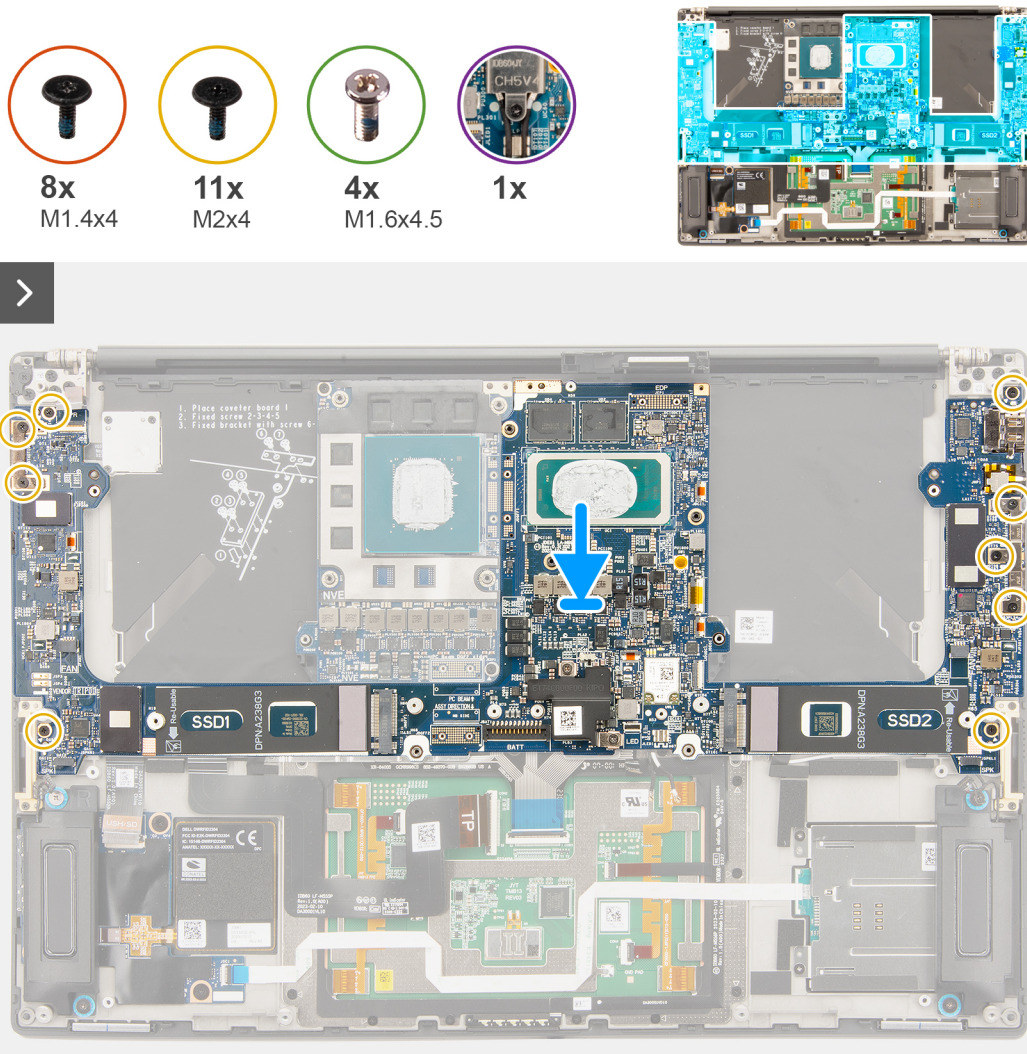

Figure 63. Installing the system board



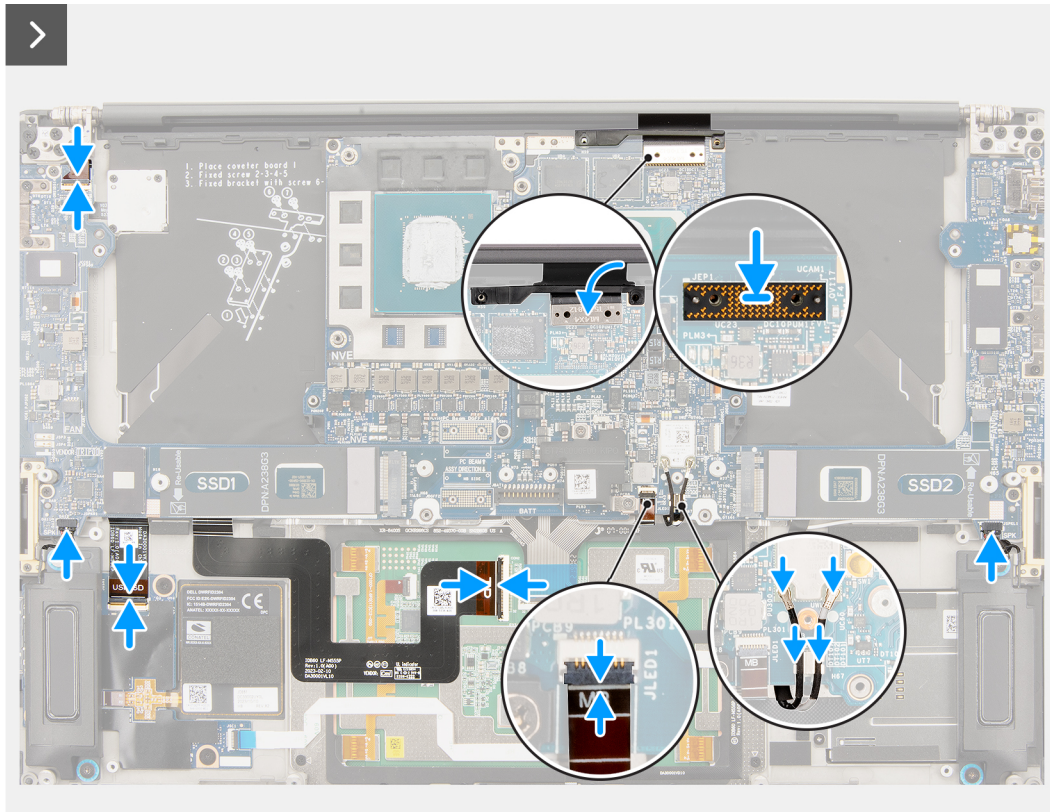

Figure 64. Installing the system board

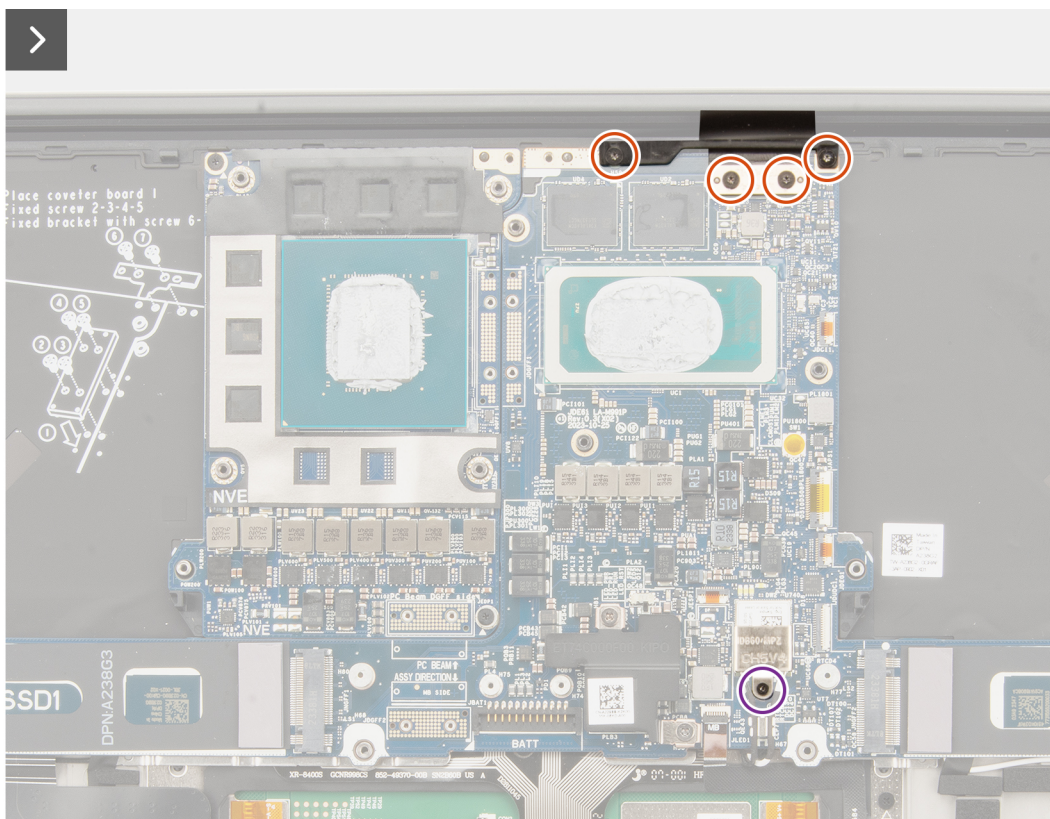
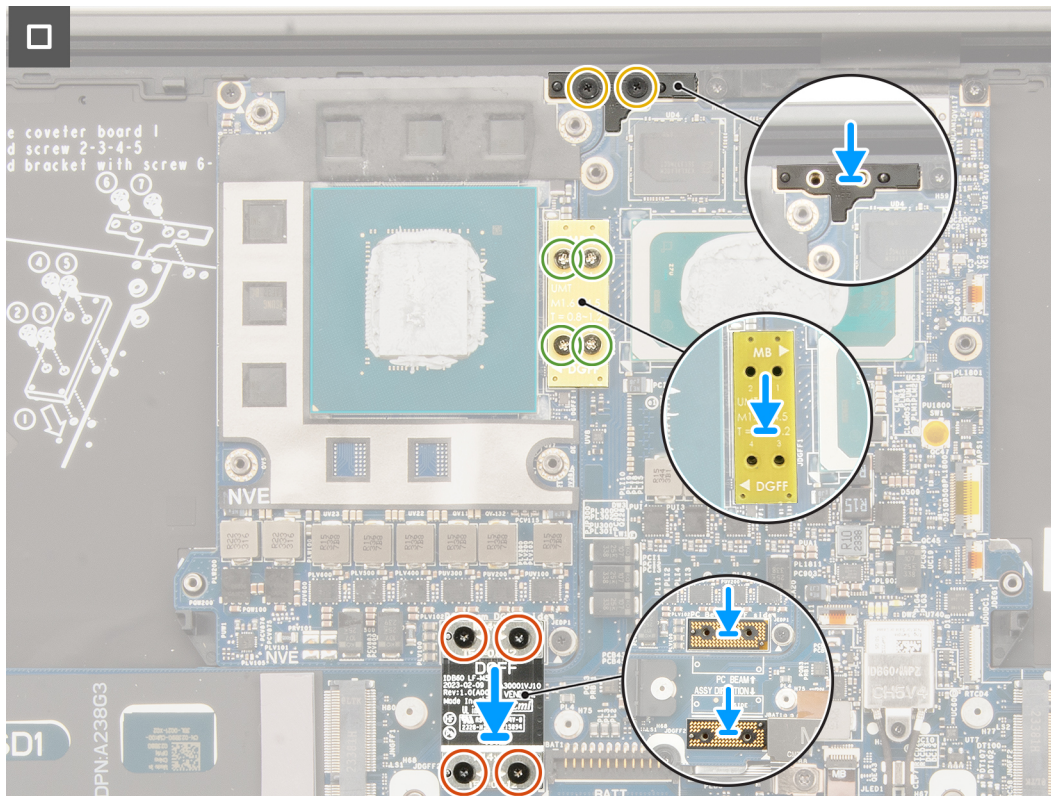

Figure 65. Installing the system board

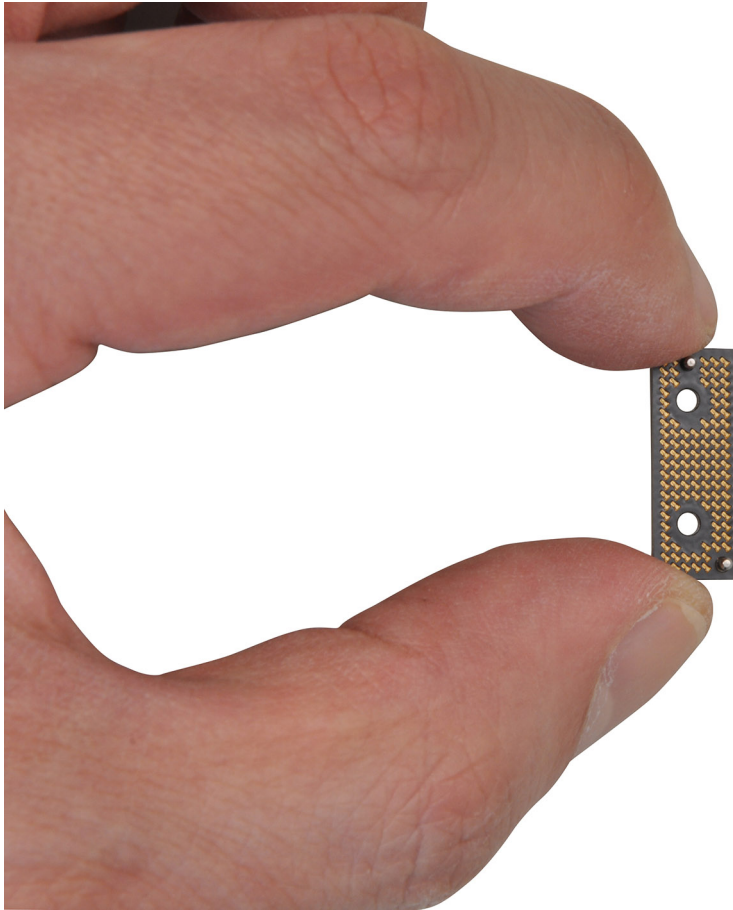

**Figure 66. Installing the system board**

**Steps**

1. Align and place the system board on the palm-rest assembly.
2. Replace the nine screws (M2x4) to secure the system board to the palm-rest assembly.
3. Align and place the PC-bridge bracket on the system board.
4. Replace the two screws (M2x4) to secure the PC-bridge bracket in place.
5. Connect the power button with fingerprint reader FPC cable, right speaker cable, front LED FPC cable, and left speaker cable to the connectors on the system board.
6. Adhere the SD-card daughterboard FPC/USH and SD-card daughterboard FPC cable and Haptics touchpad FPC cable on the palm-rest assembly.
7. Connect the Haptics touchpad FPC cable to the connector on the Haptics touchpad module.
8. For computers shipped with a USH module, connect the USH and SD-card daughterboard FPC cable to the connector on the USH and SD-card daughterboard.
9. For computers shipped without a USH module, connect the SD-card daughterboard FPC cable to the connector on the SD-card daughterboard.
10. Align and place the display-FPC interposer board on the system board.

**NOTE:** The pins on the interposer board are fragile. Avoid contact with the pins on the board. When handling the board, lift and hold the board from the edges or the sides.



**Figure 67. Interposer board**

11. Connect the display-FPC cable to the connector on the system board.
12. Replace the two torx screws (T5, M1.4x4) to secure the display FPC in place.
13. Flip close the display-FPC cover.
14. Replace the two screws (M1.4x4) to secure the display-FPC cover in place.
15. For computers shipped with a WLAN card, route the antenna cables through the metal clips on the system board.
16. For computers shipped with a WLAN card, connect the antenna cables to the connectors on the WLAN module.
17. For computers shipped with a WLAN card, align and place the WLAN bracket on the system board.
18. For computers shipped with a WLAN card, tighten the captive screw to secure the WLAN bracket in place.
19. For computers shipped with a graphics card, align and place the graphics-card bridge on the system board.
20. For computers shipped with a graphics card, replace the four screws (M1.6x4.5) to secure the graphics-card bridge in place.
21. For computers shipped with a graphics card, align and place the two graphics-card FPC interposer boards on the system board.
22. For computers shipped with a graphics card, align and place the graphics-card FPC from the system board.
23. For computers shipped with a graphics card, replace the four torx screws (T5, M1.4x4) to secure the graphics-card FPC in place.

#### **Next steps**

1. Install the [heat sink](#).
2. Install the [graphics-card fan](#).
3. Install the [processor fan](#).
4. Install the [Battery](#).
5. Install the [M.2 2230 solid state drive](#) or [M.2 2280 solid state drive](#).
6. Install the [base cover](#).
7. Install the [SD card](#).

8. Follow the procedure in [After working inside your computer](#).

# Speakers

## Removing the speakers

**CAUTION:** The information in this removal section is intended for authorized service technicians only.

### Prerequisites

1. Follow the procedure in [Before working inside your computer](#).
2. Remove the [SD card](#).
3. Remove the [base cover](#).
4. Remove the [M.2 2230 solid state drive](#) or [M.2 2280 solid state drive](#).
5. Remove the [battery](#).
6. Remove the [processor fan](#).
7. Remove the [graphics-card fan](#).
8. Remove the [heat sink](#).
9. Remove the [system board](#).

### About this task

The following images indicate the location of the speakers and provide a visual representation of the removal procedure.

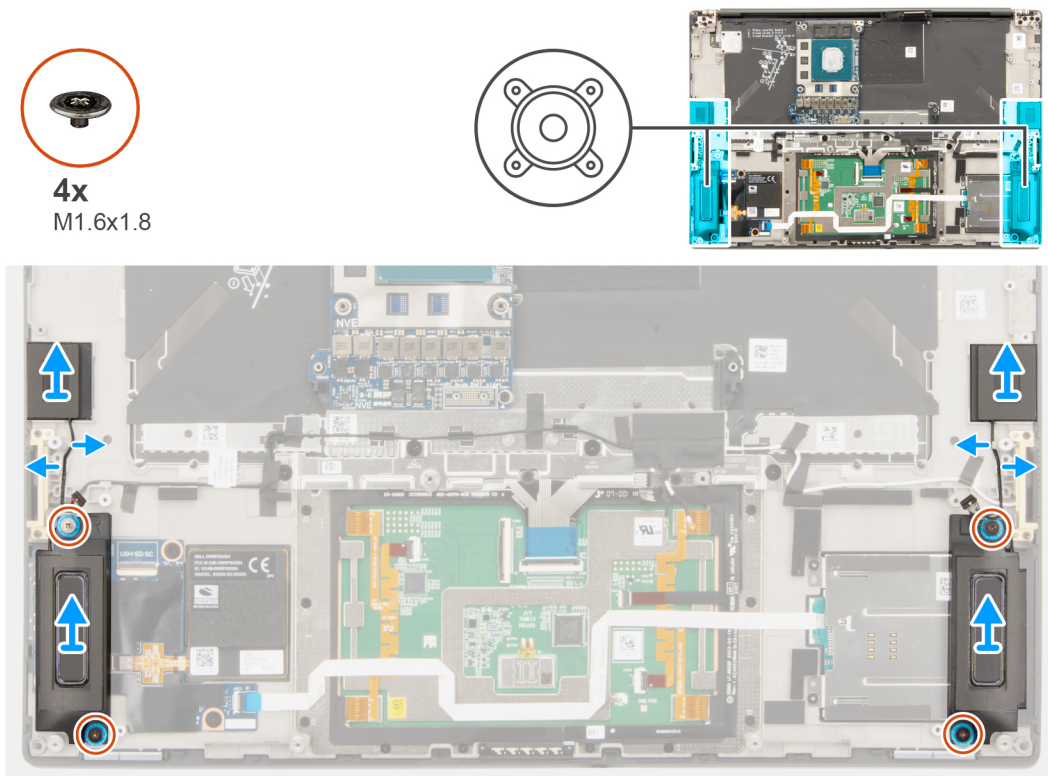

**Figure 68. Removing the speakers**

### Steps

1. Remove the left and right tweeter speakers from their slots on the computer.
2. Remove the left and right tweeter speaker cables from the routing guides on the system board.
3. Remove the four screws (M1.6x1.8) that secure the left and right speakers in place.

4. Lift the left and right speakers off the computer.

## Installing the speakers

**CAUTION:** The information in this installation section is intended for authorized service technicians only.

### Prerequisites

If you are replacing a component, remove the existing component before performing the installation procedure.

### About this task

The following image indicates the location of the speakers and provides a visual representation of the installation procedure.

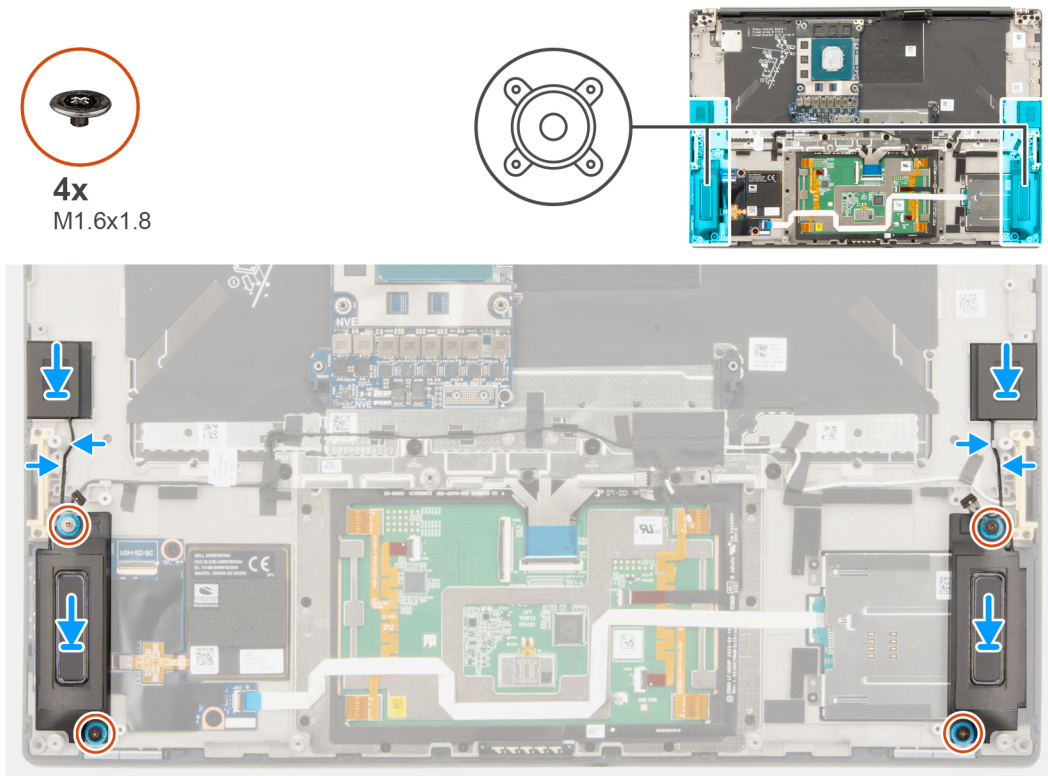
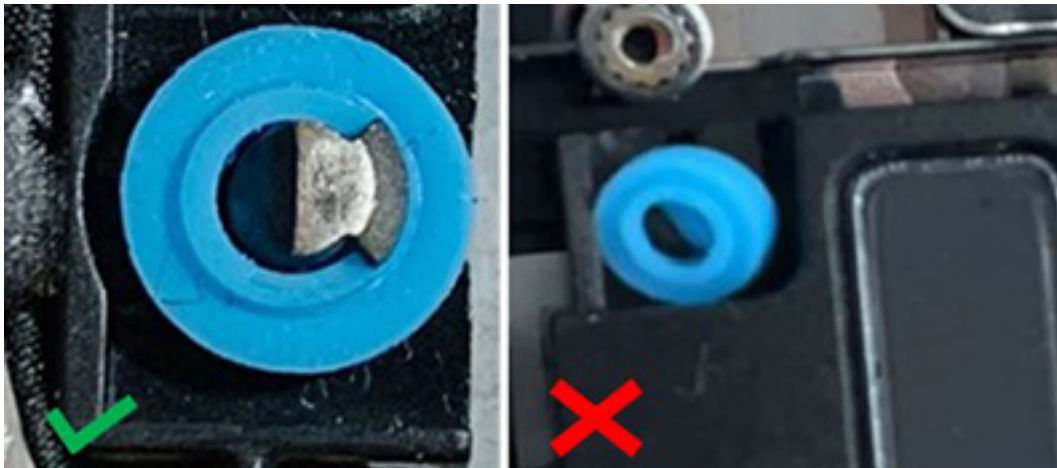

**Figure 69. Installing the speakers**

### Steps

1. Connect the left and right tweeter speaker cables through the routing guides on the system board.
2. Replace the four screws (M1.6x1.8) to secure the left and right speakers in place.

**NOTE:** Ensure that the four rubber grommets are seated into the slot and installed on the speakers properly. Ensure the wires of the speakers and wireless antennas are placed in their routing guides accordingly.



**Figure 70. Rubber grommets**

### Next steps

1. Install the [system board](#).
2. Install the [speaker](#).
3. Install the [heat sink](#).
4. Install the [graphics-card fan](#).
5. Install the [processor fan](#).
6. Install the [battery](#).
7. Install the [M.2 2230 solid state drive](#) or [M.2 2280 solid state drive](#).
8. Install the [base cover](#).
9. Install the [SD card](#).
10. Follow the procedure in [After working inside your computer](#).

## Haptics touchpad FPC

### Removing the Haptics touchpad FPC

**⚠ CAUTION:** The information in this removal section is intended for authorized service technicians only.

#### Prerequisites

1. Follow the procedure in [Before working inside your computer](#).
2. Remove the [SD card](#).
3. Remove the [base cover](#).
4. Remove the [M.2 2230 solid state drive](#) or [M.2 2280 solid state drive](#).
5. Remove the [battery](#).
6. Remove the [processor fan](#).
7. Remove the [graphics-card fan](#).
8. Remove the [heatsink](#).
9. Remove the [system board](#).

#### About this task

The following images indicate the location of the Haptics touchpad FPC and provide a visual representation of the removal procedure.



2x  
M1.4x1.2

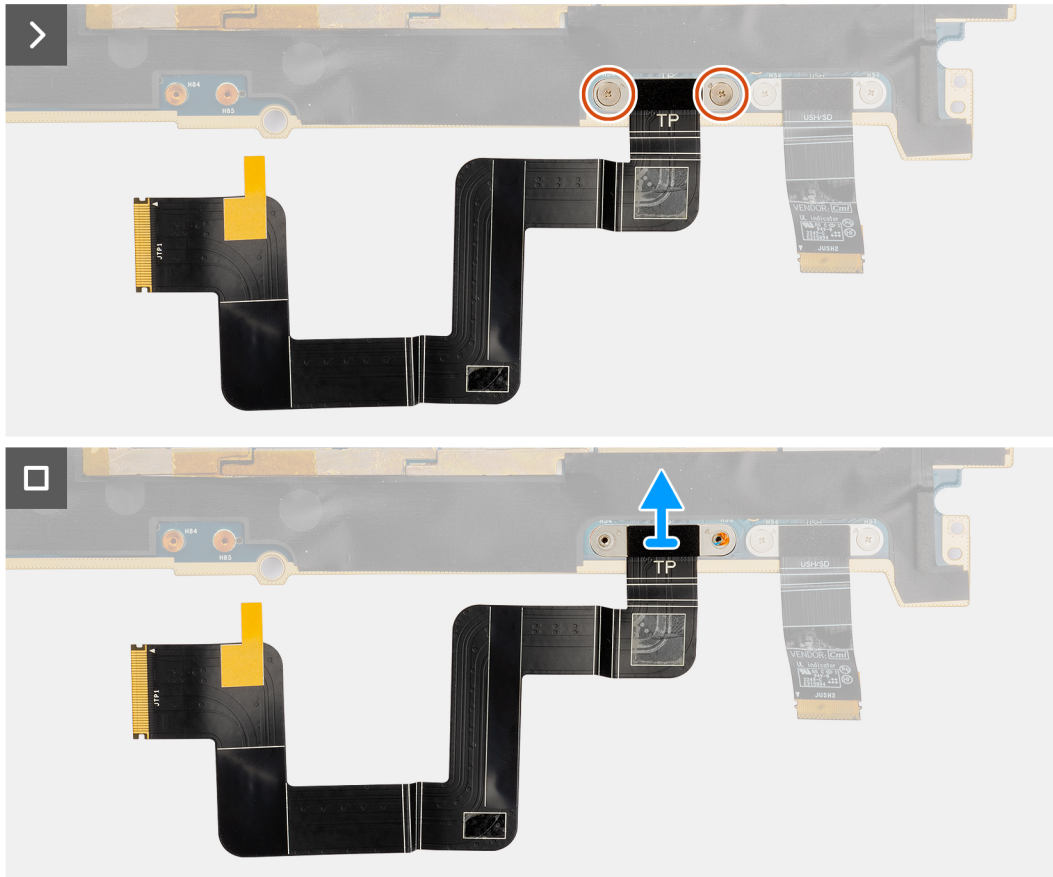
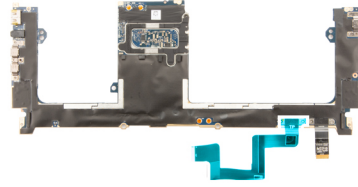

Figure 71. Removing the Haptics touchpad FPC

### Steps

1. Remove the two screws (M1.4x1.2) that secure the Haptics touchpad FPC to the system board.
2. Disconnect and remove the Haptics touchpad FPC from the system board.

## Installing the Haptics touchpad FPC

**CAUTION:** The information in this installation section is intended for authorized service technicians only.

### Prerequisites

If you are replacing a component, remove the existing component before performing the installation process.

### About this task

The following images indicate the location of the Haptics touchpad FPC and provide a visual representation of the installation procedure.



2x  
M1.4x1.2

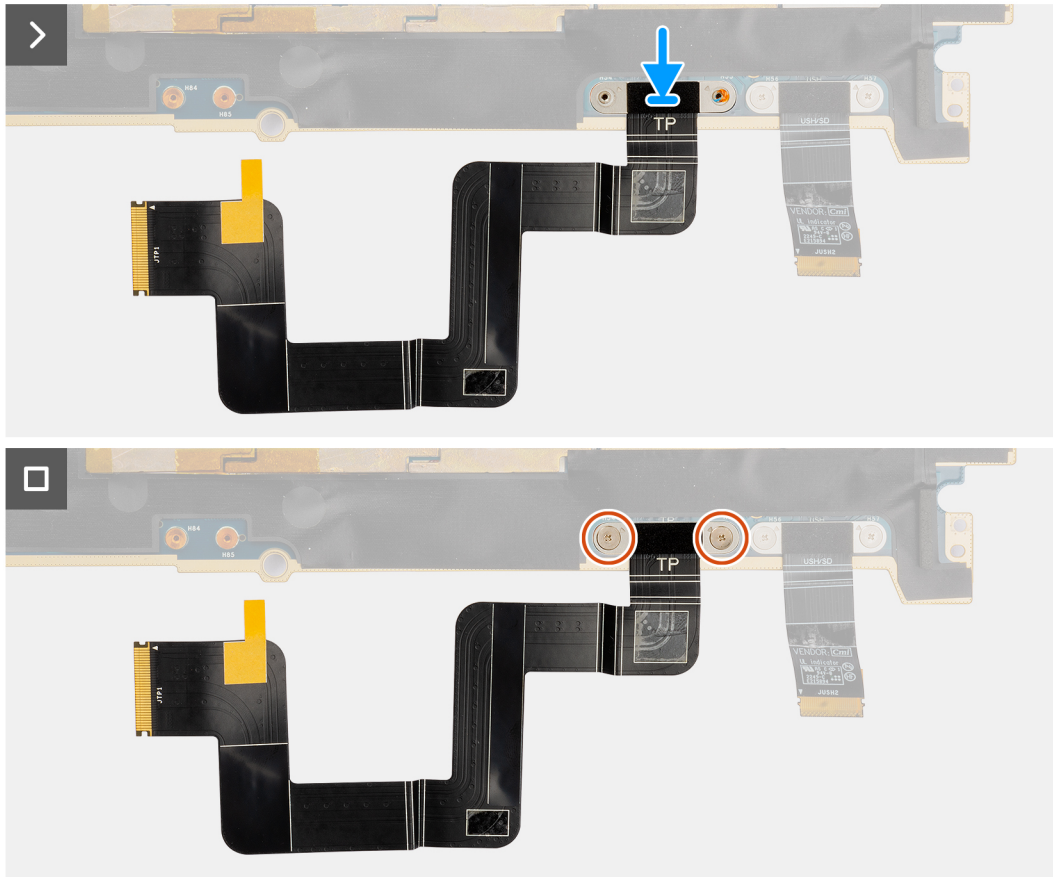
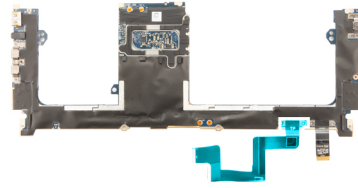

**Figure 72. Installing the Haptics touchpad FPC**

### Steps

1. Align and place the Haptics touchpad FPC into its slot on the system board.
2. Replace the two screws (M1.4x1.2) that secure the Haptics touchpad FPC to the system board.
3. Connect the Haptics touchpad FPC to the connector on the system board.

### Next steps

1. Install the [system board](#).
2. Install the [heat sink](#).
3. Install the [graphics-card fan](#).
4. Install the [processor fan](#).
5. Install the [battery](#).
6. Install the [M.2 2230 solid state drive](#) or [M.2 2280 solid state drive](#).
7. Install the [base cover](#).
8. Install the [SD card](#).
9. Follow the procedure in [After working inside your computer](#).



# SD-card daughterboard FPC

## Removing the SD-card daughterboard FPC

**CAUTION:** The information in this removal section is intended for authorized service technicians only.

### Prerequisites

1. Follow the procedure in [Before working inside your computer](#).
2. Remove the [SD card](#).
3. Remove the [base cover](#).
4. Remove the [M.2 2230 solid state drive](#) or [M.2 2280 solid state drive](#).
5. Remove the [battery](#).
6. Remove the [processor fan](#).
7. Remove the [graphics-card fan](#).
8. Remove the [heatsink](#).
9. Remove the [system board](#).

### About this task

The following images indicate the location of the SD-card daughterboard FPC and provide a visual representation of the removal procedure.

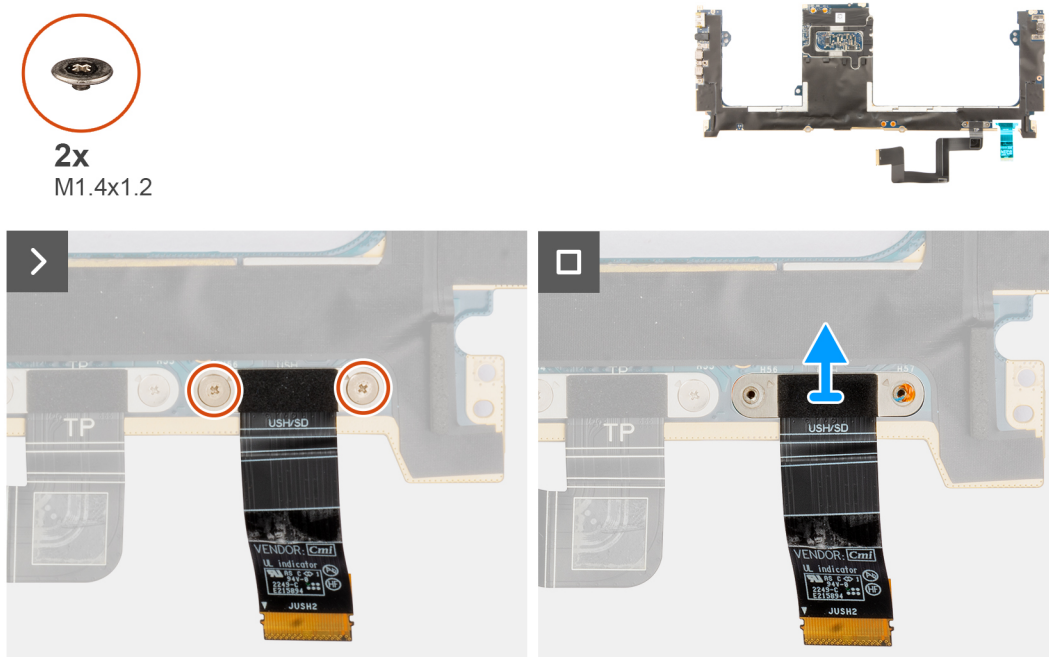

Figure 73. Removing the SD-card daughterboard FPC

### Steps

1. Remove the two screws (M1.4X1.2) that secure the SD-card daughterboard FPC in place.
2. Disconnect and remove the SD-card daughterboard FPC cable from the connector on the system board.

## Installing the SD-card daughterboard FPC

**CAUTION:** The information in this installation section is intended for authorized service technicians only.

## Prerequisites

If you are replacing a component, remove the existing component before performing the installation procedure.

## About this task

The following image indicates the location of the SD-card daughterboard FPC and provides a visual representation of the installation procedure.

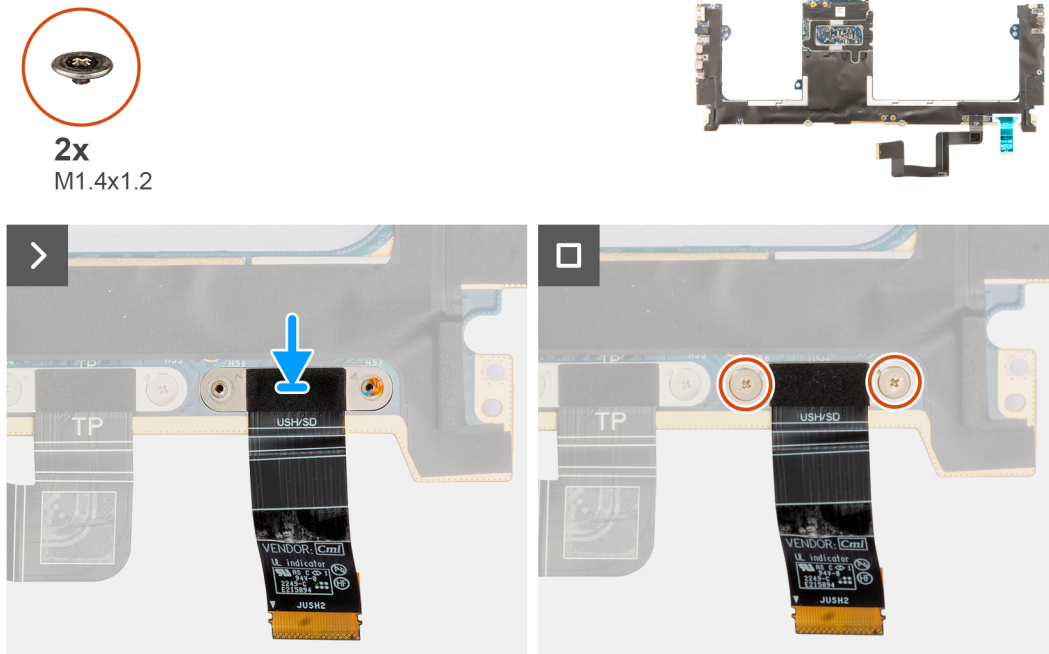

**Figure 74. Installing the SD-card daughterboard FPC**

## Steps

1. Align and place the SD-card daughterboard FPC in place.
2. Replace the two screws (M1.4x1.2) to secure the SD-card daughterboard FPC in place.
3. Connect the SD-card daughterboard FFC cable to the connector on the system board.

## Next steps

1. Install the [system board](#).
2. Install the [heat sink](#).
3. Install the [graphics-card fan](#).
4. Install the [processor fan](#).
5. Install the [battery](#).
6. Install the [M.2 2230 solid state drive](#) or [M.2 2280 solid state drive](#).
7. Install the [base cover](#).
8. Install the [SD card](#).
9. Follow the procedure in [After working inside your computer](#).

# USH and SD-card daughterboard FPC

## Removing the USH and SD-card daughterboard FPC

**CAUTION:** The information in this removal section is intended for authorized service technicians only.

## Prerequisites

1. Follow the procedure in [Before working inside your computer](#).
2. Remove the [SD card](#).
3. Remove the [base cover](#).
4. Remove the [M.2 2230 solid state drive](#) or [M.2 2280 solid state drive](#).
5. Remove the [battery](#).
6. Remove the [processor fan](#).
7. Remove the [graphics-card fan](#).
8. Remove the [heatsink](#).
9. Remove the [system board](#).

## About this task

**NOTE:** The following procedure is applicable for computers that are shipped with a USH and SD-card daughterboard FPC only.

The following images indicate the location of the USH and SD-card daughterboard FPC and provide a visual representation of the removal procedure.

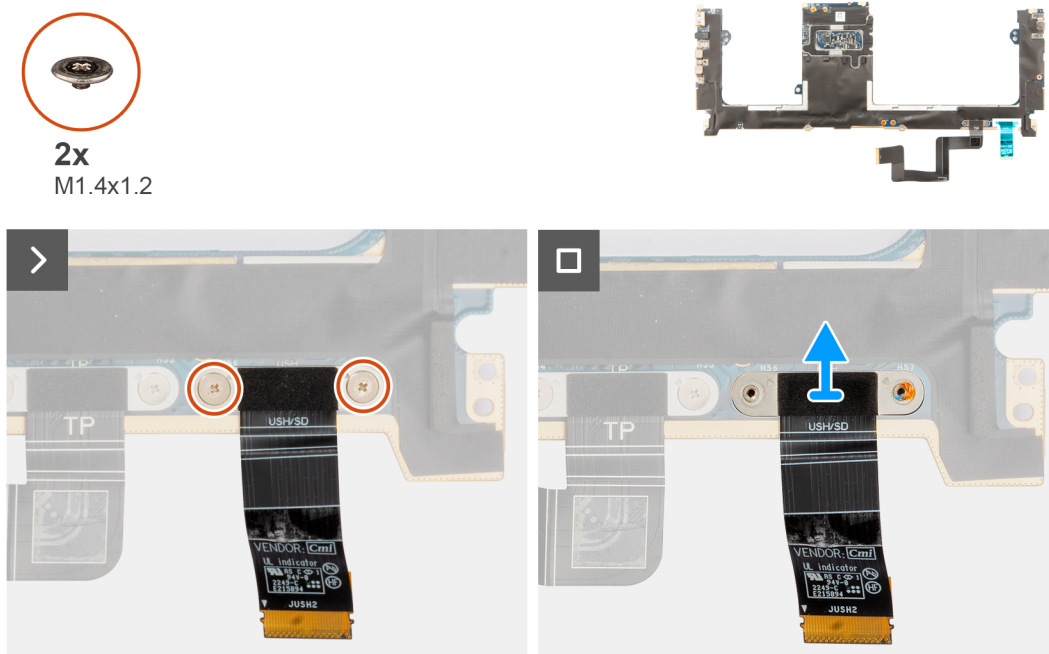

**Figure 75. Removing the USH and SD-card daughterboard FPC**

## Steps

1. Remove the two screws (M1.4X1.2) that secure the USH and SD-card daughterboard FPC in place.
2. Disconnect and remove the USH and SD-card daughterboard FPC cable from the connector on the system board.

## Installing the USH and SD-card daughterboard FPC

**CAUTION:** The information in this installation section is intended for authorized service technicians only.

## Prerequisites

If you are replacing a component, remove the existing component before performing the installation procedure.

### About this task

The following image indicates the location of the USH and SD-card daughterboard FPC and provides a visual representation of the installation procedure.

**NOTE:** The following procedure is applicable for computers that are shipped with a USH and SD-card daughterboard FPC only.

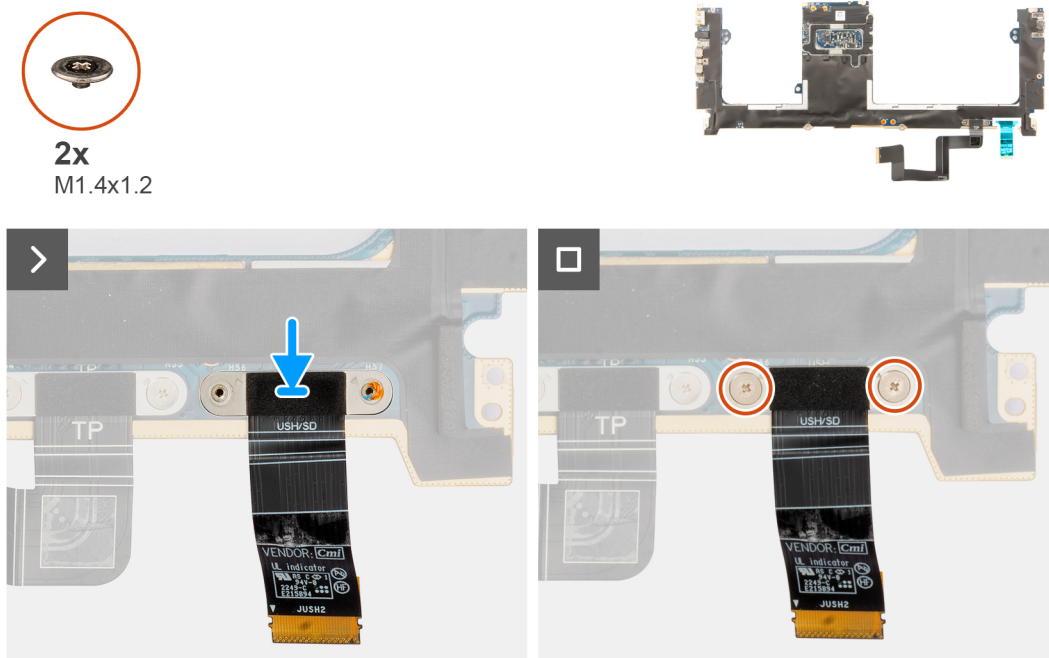

**Figure 76. Installing the USH and SD-card daughterboard FPC**

### Steps

1. Align and place the USH and SD-card daughterboard FPC in place.
2. Replace the two screws (M1.4x1.2) to secure the USH and SD-card daughterboard FPC in place.
3. Connect the USH and SD-card daughterboard FPC cable to the connector on the system board.

### Next steps

1. Install the [system board](#).
2. Install the [heat sink](#).
3. Install the [graphics-card fan](#).
4. Install the [processor fan](#).
5. Install the [battery](#).
6. Install the [M.2 2230 solid state drive](#) or [M.2 2280 solid state drive](#).
7. Install the [base cover](#).
8. Install the [SD card](#).
9. Follow the procedure in [After working inside your computer](#).

## Wireless Local Area Network (WLAN) Antennas

### Removing the WLAN-antenna module

**CAUTION:** The information in this removal section is intended for authorized service technicians only.

## Prerequisites

1. Follow the procedure in [Before working inside your computer](#).
2. Remove the [SD card](#).
3. Remove the [base cover](#).
4. Remove the [M.2 2230 solid state drive](#) or [M.2 2280 solid state drive](#).
5. Remove the [battery](#).
6. Remove the [processor fan](#).
7. Remove the [graphics-card fan](#).
8. Remove the [heatsink](#).
9. Remove the [speakers](#).
10. Remove the [system board](#).

## About this task

**NOTE:** The following procedure is applicable for computers that are shipped with WLAN antenna only.

The following images indicate the location of the WLAN-antenna module and provide a visual representation of the removal procedure.

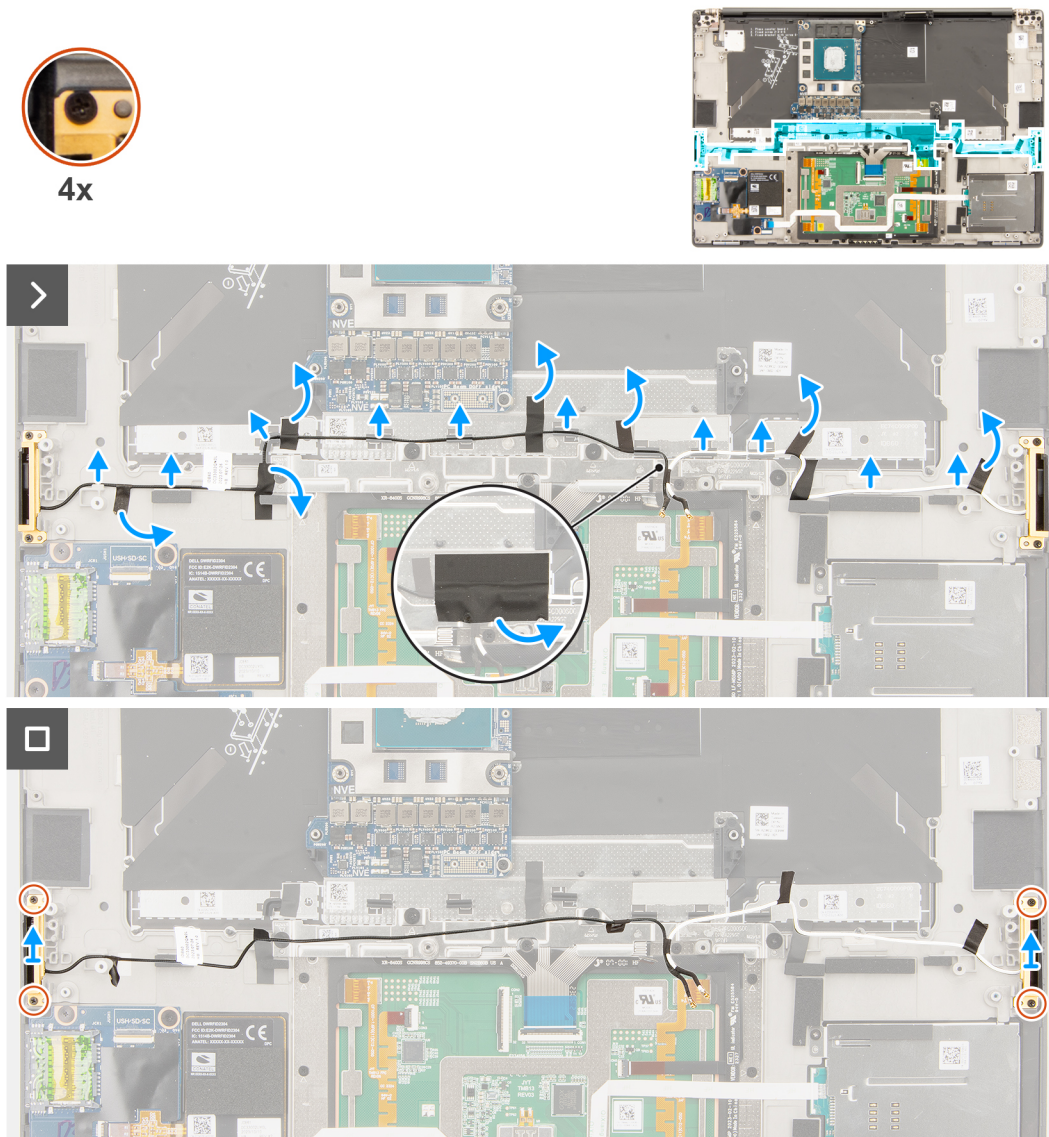

Figure 77. Removing the WLAN-antenna module

### Steps

1. Peel off the tape that secures the WLAN-antenna cables to the palm-rest assembly.
2. Remove the WLAN-antenna cables from the routing guides on the palm-rest assembly.
3. Loosen the four captive screws that secure the WLAN antennas in place.
4. Remove the WLAN antennas off the computer.

## Installing the WLAN-antenna module

 **CAUTION:** The information in this installation section is intended for authorized service technicians only.

### Prerequisites

If you are replacing a component, remove the existing component before performing the installation procedure.

### About this task

The following image indicates the location of the WLAN-antenna module and provides a visual representation of the installation procedure.

 **NOTE:** The following procedure is applicable for computers that are shipped with WLAN-antenna only.



4x

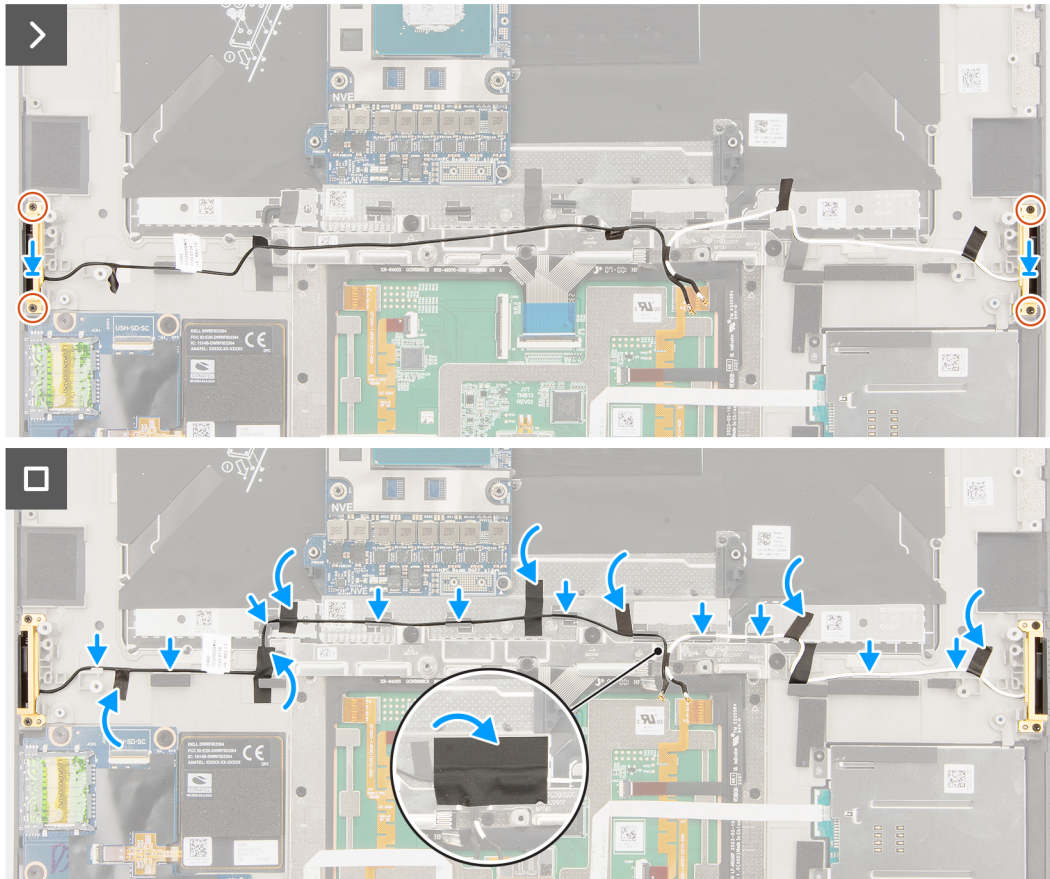
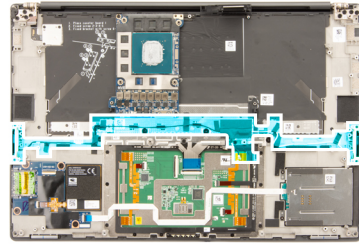

**Figure 78. Installing the WLAN-antenna module**

### Steps

1. Align and place the WLAN antenna in the slot on the computer.
2. Route the WLAN-antenna cables through the routing guides on the palm-rest assembly.
3. Replace the four captive screws to secure the WLAN-antenna cables to the palm-rest assembly.
4. Adhere the tape to secure the WLAN-antenna cables to the palm-rest assembly.
5. Align and place the left and right speakers into the slot on the chassis.

### Next steps

1. Install the [system board](#).
2. Install the [speakers](#).
3. Install the [heat sink](#).
4. Install the [graphics-card fan](#).
5. Install the [processor fan](#).
6. Install the [battery](#).
7. Install the [M.2 2230 solid state drive](#) or [M.2 2280 solid state drive](#).
8. Install the [base cover](#).
9. Install the [SD card](#).
10. Follow the procedure in [After working inside your computer](#).

# Power button with fingerprint reader assembly

## Removing the power button with fingerprint reader assembly

**CAUTION:** The information in this removal section is intended for authorized service technicians only.

### Prerequisites

1. Follow the procedure in [Before working inside your computer](#).
2. Remove the [SD card](#).
3. Remove the [base cover](#).
4. Remove the [M.2 2230 solid state drive](#) or [M.2 2280 solid state drive](#).
5. Remove the [battery](#).
6. Remove the [processor fan](#).
7. Remove the [graphics-card fan](#).
8. Remove the [heat sink](#).
9. Remove the [system board](#).

### About this task

The following images indicate the location of the power button with fingerprint reader and provide a visual representation of the removal procedure.

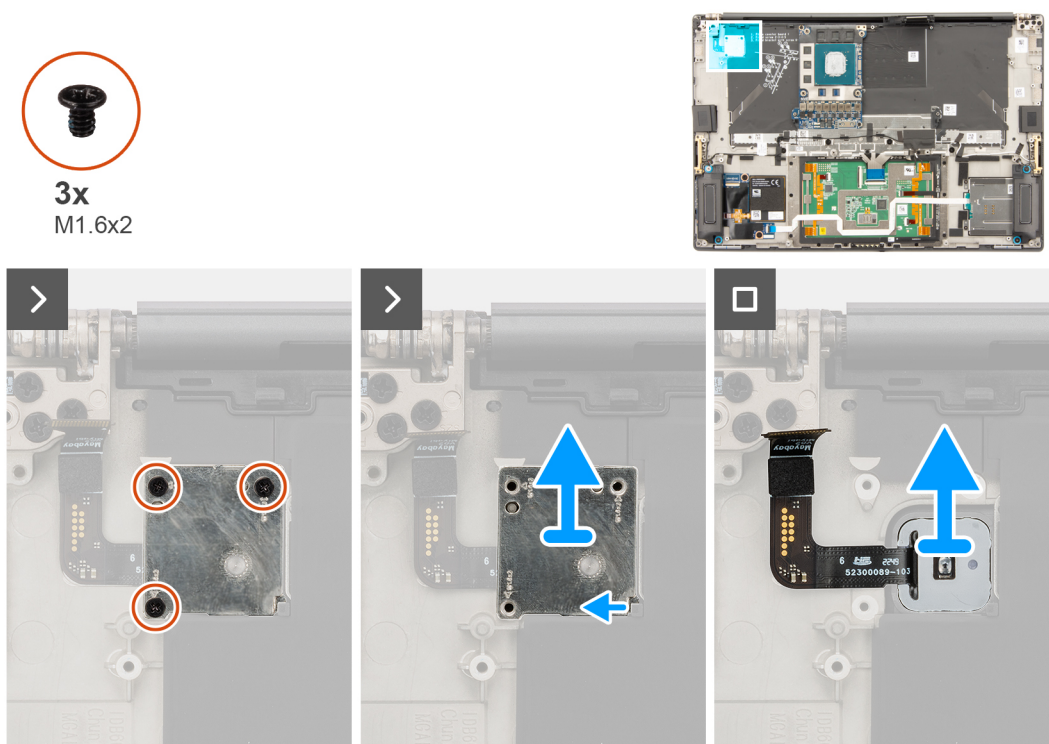

**Figure 79. Removing the power button with fingerprint reader assembly**

### Steps

1. Remove the three screws (M1.6x2) that secure the power button with the fingerprint reader bracket in place.
2. Lift the power button with the fingerprint reader bracket off the computer.
3. Peel off and remove the power button with fingerprint reader assembly from the palm-rest assembly.



## Installing the power button with fingerprint reader assembly

**CAUTION:** The information in this installation section is intended for authorized service technicians only.

### Prerequisites

If you are replacing a component, remove the existing component before performing the installation procedure.

### About this task

The following image indicates the location of the power button with fingerprint reader and provides a visual representation of the installation procedure.

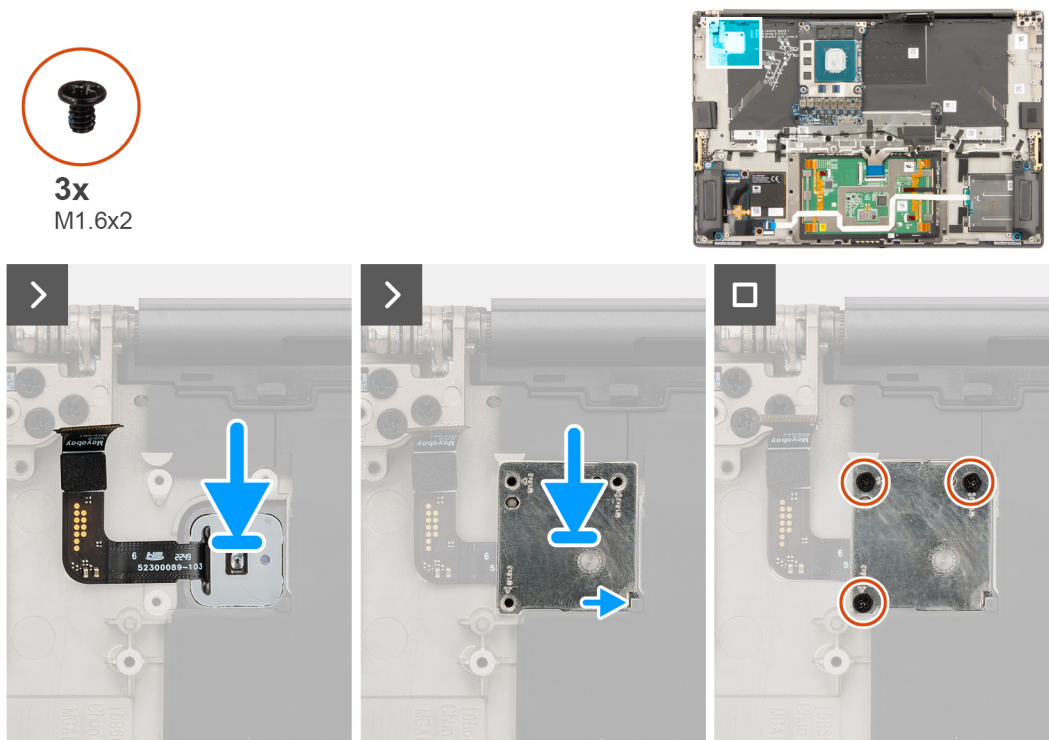

**Figure 80. Installing the power button with fingerprint reader assembly**

### Steps

1. Align, place, and adhere the power button with the fingerprint reader assembly on the palm-rest assembly.
2. Place the power button with the fingerprint reader bracket on the power button assembly.
3. Replace the three screws (M1.6x2) to secure the power button with fingerprint reader in place.

### Next steps

1. Install the [system board](#).
2. Install the [heat sink](#).
3. Install the [graphics-card fan](#).
4. Install the [processor fan](#).
5. Install the [battery](#).
6. Install the [M.2 2230 solid state drive](#) or [M.2 2280 solid state drive](#).
7. Install the [base cover](#).
8. Install the [SD card](#).
9. Follow the procedure in [After working inside your computer](#).

# Palm-rest assembly

## Removing the palm-rest assembly

 **CAUTION:** The information in this removal section is intended for authorized service technicians only.

### Prerequisites

1. Follow the procedure in [Before working inside your computer](#).

 **NOTE:** Ensure that your computer is in Service Mode. For more information see, step 6 in [Before working inside your computer](#).

2. Remove the [SD card](#).
3. Remove the [base cover](#).
4. Remove the [M.2 2230 solid state drive](#) or [M.2 2280 solid state drive](#).
5. Remove the [battery](#).
6. Remove the [display assembly](#).
7. Remove the [processor fan](#).
8. Remove the [graphics-card fan](#).
9. Remove the [heatsink](#).
10. Remove the [smart-card reader](#) for systems shipped with a smart-card reader.
11. Remove the [graphics card](#) or [dummy graphics card](#).
12. Remove the [system board](#).
13. Remove the [speakers](#).
14. Remove the [WLAN antennas](#).
15. Remove the [power button with fingerprint reader assembly](#).

### About this task

The following images indicate the location of the palm-rest assembly and provide a visual representation of the removal procedure.

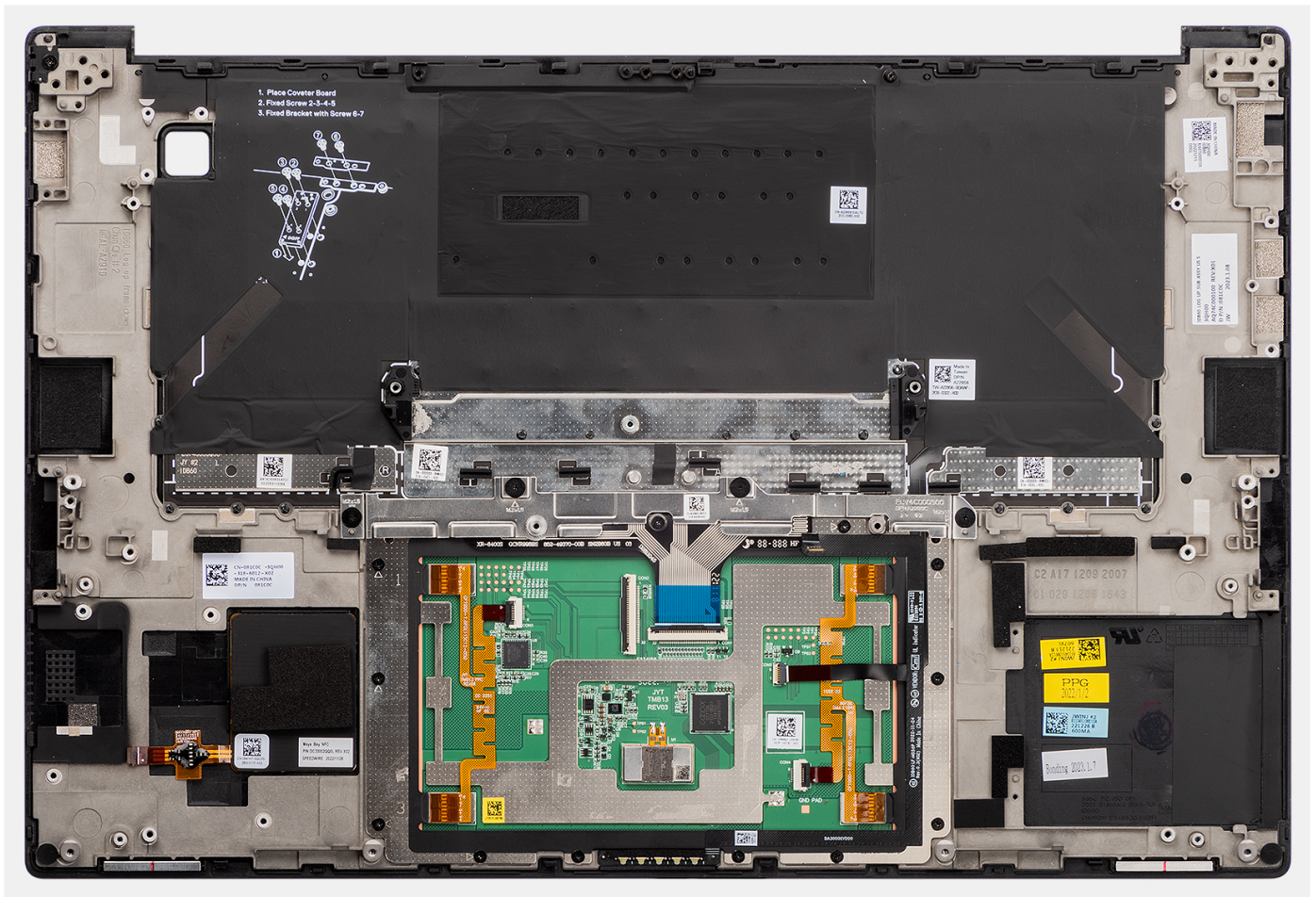

**Figure 81. Removing the palm-rest and keyboard assembly**

### Steps

After performing the steps in the pre-requisites, we are left with the palm-rest and keyboard assembly.

## Installing the palm-rest assembly

**CAUTION:** The information in this installation section is intended for authorized service technicians only.

### Prerequisites

#### About this task

The following images indicate the location of the palm-rest assembly and provide a visual representation of the removal procedure.

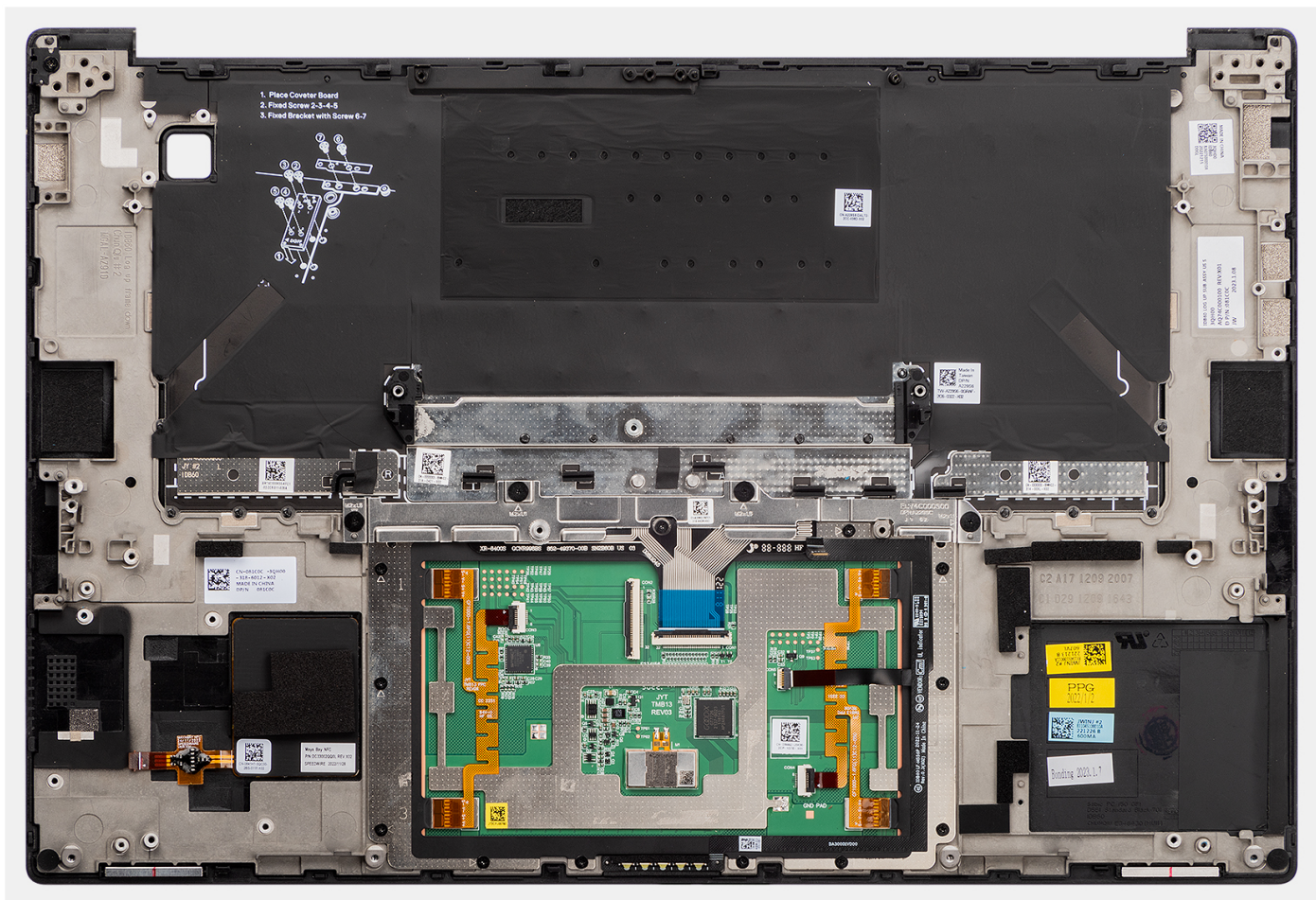

**Figure 82. Installing the palm-rest and keyboard assembly**

### Steps

1. Place the palm-rest assembly on a flat surface.
2. Perform the steps in the post-requisites.

### Next steps

1. Install the [power button with fingerprint reader](#).
2. Install the [WLAN antennas](#).
3. Install the [speakers](#).
4. Install the [system board](#).
5. Install the [graphics card](#) or [dummy graphics card](#).
6. Install the [smart-card reader](#) for systems shipped with a smart-card reader.
7. Install the [heat sink](#).
8. Install the [graphics-card fan](#).
9. Install the [processor fan](#).
10. Install the [display assembly](#).
11. Install the [battery](#).
12. Install the [M.2 2230 solid state drive](#) or [M.2 2280 solid state drive](#).
13. Install the [base cover](#).
14. Install the [SD card](#).
15. Follow the procedure in [After working inside your computer](#).

# Software

This chapter details the supported operating systems along with instructions on how to install the drivers.

## Operating system

Your Precision 5690 supports the following operating systems:

- Windows 11 Home
- Windows 11 Pro
- Windows 11 Pro for Workstation
- Windows 11 Pro for Education
- Windows 11 Enterprise
- Ubuntu Linux 22.04 LTS, 64-bit
- Red Hat Linux 9.4

## Drivers and downloads

When troubleshooting, downloading, or installing drivers, it is recommended that you read the Dell Knowledge Base article [Drivers and Downloads FAQs 000123347](#).

# BIOS Setup

**CAUTION:** Unless you are an expert computer user, do not change the settings in the BIOS Setup. Certain changes can make your computer work incorrectly.

**NOTE:** Depending on the computer and its installed devices, the items that are listed in this section may or may not be displayed.

**NOTE:** Before you change the settings in BIOS Setup, it is recommended that you note down the original settings for future reference.

Use BIOS Setup for the following purposes:

- Get information about the hardware installed in your computer, such as the amount of RAM and the size of the storage device.
- Change the system configuration information.
- Set or change a user-selectable option, such as the user password, type of hard drive installed, and enabling or disabling base devices.

## Entering BIOS setup program

### About this task

Turn on (or restart) your computer and press F2 immediately.

## Navigation keys

**NOTE:** For most of the System Setup options, changes that you make are recorded but do not take effect until you restart the computer.

**Table 31. Navigation keys**

Keys	Navigation
Up arrow	Moves to the previous field.
Down arrow	Moves to the next field.
Enter	Selects a value in the selected field (if applicable) or follows the link in the field.
Spacebar	Expands or collapses a drop-down list, if applicable.
Tab	Moves to the next focus area. <b>NOTE:</b> For the standard graphical user interface only.
Esc	Moves to the previous page until you view the main screen. Pressing Esc in the main screen displays a message that prompts you to save any unsaved changes and restart the computer.

## F12 One Time Boot menu

To enter the One Time Boot menu, turn on your computer, and then press F12 immediately.

 **NOTE:** It is recommended to shut down the computer, if it is on.

The F12 One Time Boot menu displays the devices that you can boot from including the diagnostic option. The boot menu options are:

- Removable Drive (if available)
- STXXXX Drive (if available)
  -  **NOTE:** XXX denotes the SATA drive number.
- Optical Drive (if available)
- SATA Hard Drive (if available)
- Diagnostics

The boot sequence screen also displays the option to access System Setup.

## View Advanced Setup options

### About this task

Some BIOS Setup options are only visible by enabling **Advanced Setup** mode, which is disabled by default.

 **NOTE:** BIOS Setup options, including **Advanced Setup** options, are described in [System setup options](#).

### To enable Advanced Setup

#### Steps

1. Enter BIOS Setup.  
The Overview menu appears.
2. Click the **Advanced Setup** option to move it to the **ON** mode.  
Advanced BIOS Setup options are visible.

## View Service options

### About this task

Service options are hidden by default and only visible by entering a hotkey command.

 **NOTE:** Service options are described in [System setup options](#).

### To view Service options:

#### Steps

1. Enter BIOS Setup.  
The Overview menu appears.
2. Enter the hotkey combination **Ctrl +Alt + s** to view the **Service** options.  
**Service** options are visible.

## System Setup options

 **NOTE:** For most of the System Setup options, changes that you make are recorded but do not take effect until you restart the computer.

 **NOTE:** Depending on your computer and its installed devices, the items that are listed in this section may differ.

**Table 32. System Setup options—Overview menu**





**Overview**

Precision 5690	
BIOS Version	Displays the BIOS version number.
Service Tag	Displays the Service Tag of the computer.
Asset Tag	Displays the Asset Tag of the computer.
Manufacture Date	Displays the manufacture date of the computer.
Ownership Date	Displays the ownership date of the computer.
Express Service Code	Displays the Express Service Code of the computer.
Ownership Tag	Displays the Ownership Tag of the computer.
Signed Firmware Update	Displays whether the Signed Firmware Update is enabled on your computer. By default, the <b>Signed Firmware Update</b> option is enabled.  <b>NOTE:</b> To view this option, enable <b>Service</b> options as described in <a href="#">View Service options</a> .

**BATTERY** Information

Primary	Displays the primary battery of the computer.
Battery Level	Displays the battery level of the computer.
Battery State	Displays the battery state of the computer.
Health	Displays the battery health of the computer.
AC Adapter	Displays whether an AC adapter is connected. If connected, displays the type of AC adapter that is connected.

**PROCESSOR** Information

Processor Type	Displays the processor type.
Maximum Clock Speed	Displays the maximum processor clock speed.  <b>NOTE:</b> To view this option, enable <b>Advanced Setup</b> mode as described in <a href="#">View Advanced Setup options</a> .
Minimum Clock Speed	Displays the minimum processor clock speed.  <b>NOTE:</b> To view this option, enable <b>Advanced Setup</b> mode as described in <a href="#">View Advanced Setup options</a> .
Current Clock Speed	Displays the current processor clock speed.  <b>NOTE:</b> To view this option, enable <b>Advanced Setup</b> mode as described in <a href="#">View Advanced Setup options</a> .
Core Count	Displays the number of cores on the processor.
Processor ID	Displays the processor identification code.
Processor L2 Cache	Displays the processor L2 cache.
Processor L3 Cache	Displays the processor L3 cache.
Microcode Version	Displays the microcode version.  <b>NOTE:</b> To view this option, enable <b>Advanced Setup</b> mode as described in <a href="#">View Advanced Setup options</a> .
Intel Hyper-Threading Capable	Displays whether the processor is Hyper-Threading (HT) capable.  <b>NOTE:</b> To view this option, enable <b>Advanced Setup</b> mode as described in <a href="#">View Advanced Setup options</a> .



**Table 32. System Setup options—Overview menu (continued)**

<b>Overview</b>	
64-Bit Technology	Displays 64-Bit technology support status.
<b>MEMORY</b> Information	
Memory Installed	Displays the total computer memory installed.
Memory Available	Displays the total computer memory available.
Memory Speed	Displays the memory speed. <b>i</b> <b>NOTE:</b> To view this option, enable <b>Advanced Setup</b> mode as described in <a href="#">View Advanced Setup options</a> .
Memory Channel Mode	Displays single or dual channel mode. <b>i</b> <b>NOTE:</b> To view this option, enable <b>Advanced Setup</b> mode as described in <a href="#">View Advanced Setup options</a> .
Memory Technology	Displays the technology that is used for the memory.
<b>DEVICES</b> Information	
Panel Type	Displays the panel type of the computer.
Panel Revision	Displays the panel revision of the computer.
Video Controller	Displays the video controller type of the computer.
Video Memory	Displays the video memory information of the computer.
Wi-Fi Device	Displays the wireless device information of the computer.
Native Resolution	Displays the native resolution of the computer.
Video BIOS Version	Displays the video BIOS version of the computer. <b>i</b> <b>NOTE:</b> To view this option, enable <b>Advanced Setup</b> mode as described in <a href="#">View Advanced Setup options</a> .
Audio Controller	Displays the audio controller information of the computer.
Bluetooth Device	Displays the Bluetooth device information of the computer.
Pass Through MAC Address	Displays the MAC address of the video pass-through.
dGPU Video Controller	Displays the name of the dGPU video controller installed in the computer.

**Table 33. System Setup options—Boot Configuration menu**

<b>Boot Configuration</b>	
<b>Boot Sequence</b>	
Boot Mode: UEFI only	Displays the boot mode of the computer. <b>i</b> <b>NOTE:</b> To view this option, enable <b>Service</b> options as described in <a href="#">View Service options</a> .
Boot Sequence	Displays the boot sequence.
Secure Digital (SD) Card Boot	Enables or disables read-only boot from Secure Digital (SD) card. By default, the <b>Secure Digital (SD) Card Boot</b> option is disabled. <b>i</b> <b>NOTE:</b> To view this option, enable <b>Advanced Setup</b> mode as described in <a href="#">View Advanced Setup options</a> .
<b>Secure Boot</b>	Secure Boot is a method of guaranteeing the integrity of the boot path by performing additional validation of the operating system and PCI add-in cards. The computer stops booting to the operating system when a component is not authenticated during the boot process. Secure Boot can be enabled in BIOS setup

**Table 33. System Setup options—Boot Configuration menu (continued)**

<b>Boot Configuration</b>	
	or using management interfaces like Dell Command Configure, but can only be disabled from BIOS setup.
Enable Secure Boot	<p>Enables the computer to boot using only validated boot software.</p> <p>By default, this <b>Enable Secure Boot</b> option is disabled. For additional security, Dell Technologies recommends keeping the <b>Secure Boot</b> option enabled to ensure that the UEFI firmware validates the operating system during the boot process.</p> <p><b>NOTE:</b> To view this option, enable <b>Advanced Setup</b> mode as described in <a href="#">View Advanced Setup options</a>.</p> <p><b>NOTE:</b> To enable Secure Boot, the computer is required to be in UEFI boot mode and the Enable Legacy Option ROMs option is required to be turned off.</p>
Enable Microsoft UEFI CA	<p>When disabled, the UEFI CA is removed from the BIOS UEFI Secure Boot database.</p> <p><b>NOTE:</b> When disabled, the Microsoft UEFI CA could render your computer unable to boot, computer graphics may not function, some devices may not function properly, and the computer could become unrecoverable.</p> <p>By default, the <b>Enable Microsoft UEFI CA</b> option is enabled.</p> <p>For additional security, Dell Technologies recommends keeping the <b>Microsoft UEFI CA</b> option enabled to ensure the broadest compatibility with devices and operating systems.</p>
Secure Boot Mode	<p>Enables or disables the Secure Boot operation mode.</p> <p>By default, the <b>Deployed Mode</b> is selected. <b>Deployed Mode</b> should be selected for normal operation of Secure Boot.</p> <p><b>NOTE:</b> To view this option, enable <b>Advanced Setup</b> mode as described in <a href="#">View Advanced Setup options</a>.</p>
<b>Expert Key Management</b>	
Enable Custom Mode	<p>Enables or disables the keys in the PK, KEK, db, and dbx security key databases to be modified.</p> <p>By default, the <b>Enable Custom Mode</b> option is disabled.</p> <p><b>NOTE:</b> To view this option, enable <b>Advanced Setup</b> mode as described in <a href="#">View Advanced Setup options</a>.</p>
Custom Mode Key Management	<p>Selects the custom values for expert key management.</p> <p>By default, the <b>PK</b> option is selected.</p> <p><b>NOTE:</b> To view this option, enable <b>Advanced Setup</b> mode as described in <a href="#">View Advanced Setup options</a>.</p>

**Table 34. System Setup options—Integrated Devices menu**

<b>Integrated Devices</b>	
<b>Date/Time</b>	
Date	Sets the computer date in MM/DD/YYYY format. Changes to the date format take effect immediately.
Time	Sets the computer time in HH/MM/SS 24-hour format. You can switch between a 12-hour or 24-hour clock. Changes to the time format take effect immediately.
<b>Camera</b>	

**Table 34. System Setup options—Integrated Devices menu (continued)**

<b>Integrated Devices</b>	
Enable Camera	<p>Enables the camera.</p> <p>By default, the <b>Enable Camera</b> option is enabled.</p> <p><b>i</b> <b>NOTE:</b> Depending on the configuration ordered, the camera setup option may not be available.</p>
<b>Audio</b>	
Enable Audio	<p>Enables all integrated audio controller.</p> <p>By default, all the options are enabled.</p>
Enable Microphone	<p>Enables the microphone.</p> <p>By default, the <b>Enable Microphone</b> option is enabled.</p> <p><b>i</b> <b>NOTE:</b> Depending on the configuration ordered, the microphone setup option may not be available.</p>
Enable Internal Speaker	<p>Enables the internal speaker.</p> <p>By default, the <b>Enable Internal Speaker</b> option is enabled.</p>
<b>USB/Thunderbolt Configuration</b>	
Enable USB Boot Support	<p>Enables booting from USB mass storage devices that are connected to external USB ports.</p> <p>By default, the <b>Enable USB Boot Support</b> option is enabled.</p> <p><b>i</b> <b>NOTE:</b> To view this option, enable <b>Advanced Setup</b> mode as described in <a href="#">View Advanced Setup options</a>.</p>
Enable External USB Ports	<p>Enables the external USB ports.</p> <p>By default, the <b>Enable External USB Ports</b> option is enabled.</p> <p><b>i</b> <b>NOTE:</b> To view this option, enable <b>Advanced Setup</b> mode as described in <a href="#">View Advanced Setup options</a>.</p>
<b>Enable Thunderbolt Technology Support</b>	
Enable Thunderbolt Technology Support	<p>Enables the associated ports and adapters for Thunderbolt Technology support.</p> <p>By default, the <b>Enable Thunderbolt Technology Support</b> option is enabled.</p> <p><b>i</b> <b>NOTE:</b> To view this option, enable <b>Advanced Setup</b> mode as described in <a href="#">View Advanced Setup options</a>.</p>
<b>Enable Thunderbolt Boot Support</b>	
Enable Thunderbolt Boot Support	<p>Enables the Thunderbolt adapter-peripheral device and USB devices that are connected to the Thunderbolt adapter to be used during BIOS Preboot.</p> <p>By default, the <b>Enable Thunderbolt Boot Support</b> option is disabled.</p> <p><b>i</b> <b>NOTE:</b> To view this option, enable <b>Advanced Setup</b> mode as described in <a href="#">View Advanced Setup options</a>.</p>
<b>Enable Thunderbolt (and PCIe behind TBT) pre-boot modules</b>	
Enable Thunderbolt (and PCIe behind TBT) pre-boot modules	<p>Enables the PCIe devices that are connected through a Thunderbolt adapter to run the PCIe devices UEFI Option ROM (if present) during preboot.</p> <p>By default, the <b>Enable Thunderbolt (and PCIe behind TBT) pre-boot modules</b> option is disabled.</p> <p><b>i</b> <b>NOTE:</b> To view this option, enable <b>Advanced Setup</b> mode as described in <a href="#">View Advanced Setup options</a>.</p>
Disable USB4 PCIE Tunneling	<p>Disables the USB4 PCIE Tunneling option.</p>

**Table 34. System Setup options—Integrated Devices menu (continued)**

<b>Integrated Devices</b>	
	<p>By default, the <b>Disable USB4 PCIE Tunneling</b> option is disabled.</p> <p><b>i</b> <b>NOTE:</b> To view this option, enable <b>Advanced Setup</b> mode as described in <a href="#">Entering BIOS Setup program</a>.</p>
<b>Video/Power only on Type-C Ports</b>	<p>Enables or disables the Type-C port functionality to video or only power.</p> <p>By default, the <b>Video/Power only on Type-C Ports</b> option is disabled.</p> <p><b>i</b> <b>NOTE:</b> To view this option, enable <b>Advanced Setup</b> mode as described in <a href="#">View Advanced Setup options</a>.</p>
<b>Type-C Dock Override</b>	<p>Enables or disables to use connected Type-C Dell Dock to provide data stream with external USB ports disabled. When Type-C Dock override is enabled, the Video/Audio/LAN submenu is activated.</p> <p>By default, the <b>Type-C Dock Override</b> option is enabled.</p> <p><b>i</b> <b>NOTE:</b> To view this option, enable <b>Advanced Setup</b> mode as described in <a href="#">Entering BIOS Setup program</a>.</p>
<b>Type-C Dock Audio</b>	<p>Enables or disables the usage of audio inputs and outputs from the connected Type-C Dell docking station.</p> <p>By default, the <b>Type-C Dock Audio</b> option is enabled.</p> <p><b>i</b> <b>NOTE:</b> To view this option, enable <b>Advanced Setup</b> mode as described in <a href="#">View Advanced Setup options</a>.</p>
<b>Type-C Dock LAN</b>	<p>Enables or disables the usage of LAN on the external ports of the connected Type-C Dell docking station.</p> <p>By default, the <b>Type-C Dock LAN</b> option is enabled.</p> <p><b>i</b> <b>NOTE:</b> To view this option, enable <b>Advanced Setup</b> mode as described in <a href="#">View Advanced Setup options</a>.</p>
<b>Miscellaneous Devices</b>	
Enable Fingerprint Reader Device	<p>Enables or disables the Fingerprint Reader Device option.</p> <p>By default, the <b>Enable Fingerprint Reader Device</b> option is enabled.</p> <p><b>i</b> <b>NOTE:</b> To view this option, enable <b>Advanced Setup</b> mode as described in <a href="#">View Advanced Setup options</a>.</p>
<b>Unobtrusive Mode</b>	
Enable Unobtrusive Mode	<p>Enables or disables the unobtrusive mode. When enabled, all system LEDs, LCD panel backlight and audio devices of the computer are turned off.</p> <p>By default, the <b>Enable Unobtrusive Mode</b> option is disabled.</p> <p><b>i</b> <b>NOTE:</b> On computers with collaboration touchpad, the Collaboration Touchpad is disabled when the <b>Enable Unobtrusive Mode</b> option is enabled.</p> <p><b>i</b> <b>NOTE:</b> To view this option, enable <b>Advanced Setup</b> mode as described in <a href="#">View Advanced Setup options</a>.</p>

**Table 35. System Setup options—Storage menu**

<b>Storage</b>	
<b>SATA/NVMe Operation</b>	
SATA/NVMe Operation	<p>Sets the operating mode of the integrated SATA hard drive controller.</p> <p>By default, the <b>Raid On</b> option is selected.</p>

**Table 35. System Setup options—Storage menu (continued)**

<b>Storage</b>	
<b>Storage Interface</b>	Displays the information of various onboard drives.
Port Enablement	Enables or disables the M.2 PCIe SSD option. By default, the <b>M.2 PCIe SSD</b> option is enabled.
Smart Reporting	Enables or disables the Smart reporting option. By default, the <b>Smart Reporting</b> option is disabled. <b>i</b> <b>NOTE:</b> To view this option, enable <b>Advanced Setup</b> mode as described in <a href="#">View Advanced Setup options</a> .
<b>Drive Information</b>	Displays the information of onboard drives.
<b>Enable MediaCard</b>	
Secure Digital (SD) Card	Enables or disables the SD card. By default, the <b>Secure Digital (SD) Card</b> option is enabled. <b>i</b> <b>NOTE:</b> To view this option, enable <b>Advanced Setup</b> mode as described in <a href="#">View Advanced Setup options</a> .
Secure Digital (SD) Card Read-Only Mode	Enables or disables the SD card read-only mode. <b>i</b> <b>NOTE:</b> To view this option, enable <b>Advanced Setup</b> mode as described in <a href="#">View Advanced Setup options</a> . By default, the <b>Secure Digital (SD) Card Read-Only Mode</b> option is disabled.

**Table 36. System Setup options—Display menu**

<b>Display</b>	
<b>Display Brightness</b>	
Brightness on battery power	Enables to set the screen brightness when the computer is running on battery power. By default, the screen brightness is set to 50 when the computer is running on battery power. <b>i</b> <b>NOTE:</b> To view this option, enable <b>Advanced Setup</b> mode as described in <a href="#">View Advanced Setup options</a> .
Brightness on AC power	Enables to set the screen brightness when the computer is running on AC power. By default, the screen brightness is set to 100 when the computer is running on AC power. <b>i</b> <b>NOTE:</b> To view this option, enable <b>Advanced Setup</b> mode as described in <a href="#">View Advanced Setup options</a> .
<b>Touchscreen</b>	Enables or disables the touch screen option. By default, the <b>Touchscreen</b> option is enabled. <b>i</b> <b>NOTE:</b> Only available on computers with touch screen displays. <b>i</b> <b>NOTE:</b> To view this option, enable <b>Advanced Setup</b> mode as described in <a href="#">View Advanced Setup options</a> .
<b>Full Screen Logo</b>	Enables or disables the computer to display full screen logo, if the image matches screen resolution. By default, the <b>Full Screen Logo</b> option is disabled.



**Table 36. System Setup options—Display menu (continued)**

Display	
	<p><b>i</b> <b>NOTE:</b> To view this option, enable <b>Advanced Setup</b> mode as described in <a href="#">View Advanced Setup options</a>.</p>
<b>Discrete Graphics Controller Direct Output Mode</b>	<p>Enables the display connected to the right side of the computer USB Type-C port to be managed by the discrete graphics controller.</p> <p>By default, the <b>Discrete Graphics Controller Direct Output Mode</b> option is enabled.</p> <p><b>i</b> <b>NOTE:</b> To view this option, enable <b>Advanced Setup</b> mode as described in <a href="#">View Advanced Setup options</a>.</p>



**Table 37. System Setup options—Connection menu**

Connection	
<b>Wireless Device Enable</b>	
WLAN	<p>Enables or disables the internal WLAN device.</p> <p>By default, the <b>WLAN</b> option is enabled.</p>
Bluetooth	<p>Enables or disables the internal Bluetooth device.</p> <p>By default, the <b>Bluetooth</b> option is enabled.</p>
Contactless Smartcard/NFC	<p>Enables or disables the smartcard device.</p> <p>By default, the <b>Contactless Smartcard/NFC</b> option is enabled.</p> <p><b>i</b> <b>NOTE:</b> To view this option, enable <b>Advanced Setup</b> mode as described in <a href="#">View Advanced Setup options</a>.</p>
<b>Enable UEFI Network Stack</b>	<p>Enables or disables the UEFI Network Stack and controls the onboard LAN Controller.</p> <p>By default, the <b>Enable UEFI Network Stack</b> option is enabled.</p> <p><b>i</b> <b>NOTE:</b> To view this option, enable <b>Advanced Setup</b> mode as described in <a href="#">View Advanced Setup options</a>.</p>
<b>Wireless Radio Control</b>	
Control WLAN Radio	<p>Enables to sense the connection of the computer to a wired network and then disables the selected WLAN radio. Upon disconnection from the wired network, the selected wireless radios are reenabled.</p> <p>By default, the <b>Control WLAN Radio</b> option is disabled.</p> <p><b>i</b> <b>NOTE:</b> To view this option, enable <b>Advanced Setup</b> mode as described in <a href="#">View Advanced Setup options</a>.</p>
<b>Enable UEFI Bluetooth Stack</b>	<p>Enables pre-OS Bluetooth HID features.</p> <p>By default, the <b>Enable UEFI Bluetooth Stack</b> option is enabled.</p> <p><b>i</b> <b>NOTE:</b> To view this option, enable <b>Advanced Setup</b> mode as described in <a href="#">View Advanced Setup options</a>.</p>
<b>HTTP(s) Boot Feature</b>	<p>When enabled, the computer increases the transmit power of the WLAN device to improve performance in certain computer configurations.</p> <p><b>i</b> <b>NOTE:</b> To view this option, enable <b>Advanced Setup</b> mode as described in <a href="#">View Advanced Setup options</a>.</p>
HTTP(s) Boot	<p>When enabled, supports HTTP(s) boot on the client BIOS, which offers wired or wireless and HTTP/HTTPS connection options.</p>





**Table 37. System Setup options—Connection menu (continued)**

Connection	
	<p> <b>NOTE:</b> To view this option, enable <b>Advanced Setup</b> mode as described in <a href="#">View Advanced Setup options</a>.</p>
HTTP(s) Boot Modes	<p>In Auto Mode, the boot URL is obtained from the DHCP response; the boot URL specifies the HTTP Boot Server and location of the Network Boot Program (NBP) file. In Manual mode, the user enters the URL in the text box, which must start with <code>http://</code> or <code>https://</code> and end with the NBP file name.</p> <p>By default, <b>Auto Mode</b> is selected.</p> <p> <b>NOTE:</b> To view this option, enable <b>Advanced Setup</b> mode as described in <a href="#">View Advanced Setup options</a>.</p>
CA Certificate	<p>Upload or delete the CA certificate.</p> <p> <b>NOTE:</b> To view this option, enable <b>Advanced Setup</b> mode as described in <a href="#">View Advanced Setup options</a>.</p>

**Table 38. System Setup options—Power menu**

Power	
<b>Battery Configuration</b>	<p>Enables or disables the computer to run on battery during peak power usage hours. Use the table <b>Custom Charge Start</b> and <b>Custom Charge Stop</b>, to prevent AC power usage between certain times of each day.</p> <p>By default, the <b>Adaptive</b> option is selected. Battery settings are adaptively optimized based on your typical battery usage pattern.</p>
<b>Advanced Configuration</b>	
Enable Advanced Battery Charge Configuration	<p>Enables Advanced Battery Charge Configuration from the beginning of the day to a specified work period. When enabled, Advanced Battery Charged maximizes battery health while still supporting heavy use during the work day.</p> <p>By default, the <b>Enable Advanced Battery Charge Configuration</b> option is disabled.</p> <p> <b>NOTE:</b> To view this option, enable <b>Advanced Setup</b> mode as described in <a href="#">View Advanced Setup options</a>.</p>
<b>Peak Shift</b>	
Enable Peak Shift	<p>Enables or disables the computer to run on battery during peak power usage hours.</p> <p>By default, the <b>Enable Peak Shift</b> option is disabled.</p> <p> <b>NOTE:</b> To view this option, enable <b>Advanced Setup</b> mode as described in <a href="#">View Advanced Setup options</a>.</p>
Enable USB PowerShare	<p>Enables or disables the USB PowerShare on the computer.</p> <p>By default, the <b>USB Powershare</b> option is disabled.</p>
<b>Thermal Management</b>	<p>Enables or disables cooling of the fan and manages the processor heat to adjust the system performance, noise, and temperature.</p> <p>By default, the <b>Optimized</b> option is selected. Standard settings for balanced performance, noise, and temperature.</p>
<b>USB Wake Support</b>	
Wake on Dell USB-C Dock	<p>When enabled, connecting a Dell USB-C Dock wakes the computer from Standby, Hibernate, and Power Off.</p> <p>By default, the <b>Wake on Dell USB-C Dock</b> option is enabled.</p>

**Table 38. System Setup options—Power menu (continued)**

Power	
	<p> <b>NOTE:</b> To view this option, enable <b>Advanced Setup</b> mode as described in <a href="#">View Advanced Setup options</a>.</p>
<b>Block Sleep</b>	<p>Enables or disables the computer from entering Sleep (S3) mode in the operating system.</p> <p>By default, the <b>Block Sleep</b> option is disabled.</p> <p> <b>NOTE:</b> When enabled, the computer does not go to Sleep, Intel Rapid Start is disabled automatically, and the operating system power option is blank if it was set to Sleep.</p> <p> <b>NOTE:</b> To view this option, enable <b>Advanced Setup</b> mode as described in <a href="#">View Advanced Setup options</a>.</p>
Lid Switch	
Enable Lid Switch	<p>Enables or disables the Lid Switch.</p> <p>By default, the <b>Enable Lid Switch</b> option is enabled.</p>
Power On Lid Open	<p>When enabled, allows the computer to turn on from the off state whenever the lid is opened.</p> <p>By default, the <b>Power On Lid Open</b> option is enabled.</p>
<b>Intel Speed Shift Technology</b>	<p>Enables or disables the Intel Speed Shift Technology support. When enabled, the operating system selects the appropriate processor performance automatically.</p> <p>By default, the <b>Intel Speed Shift Technology</b> option is enabled.</p> <p> <b>NOTE:</b> To view this option, enable <b>Service</b> options as described in <a href="#">View Service options</a>.</p>

**Table 39. System Setup options—Security menu**









Security	
<b>TPM 2.0 Security</b>	<p>Trusted Platform Module (TPM) is a security device that stores computer-generated keys for encryption and features such as BitLocker, Virtual Secure Mode, remote Attestation.</p> <p>By default, the <b>TPM 2.0 Security</b> option is enabled.</p> <p>For additional security, Dell Technologies recommends keeping the Trusted Platform Module (TPM) enabled to allow these security technologies to fully function.</p>
TPM 2.0 Security On	<p>Enables or disables the TPM.</p> <p>By default, the <b>TPM 2.0 Security On</b> option is enabled.</p> <p>For additional security, Dell Technologies recommends keeping TPM enabled to allow these security technologies to fully function.</p> <p> <b>NOTE:</b> To view this option, enable <b>Advanced Setup</b> mode as described in <a href="#">View Advanced Setup options</a>.</p>
Attestation Enable	<p>The <b>Attestation Enable</b> option controls the endorsement hierarchy of TPM. Disabling the <b>Attestation Enable</b> option prevents TPM from being used to digitally sign certificates.</p> <p>By default, the <b>Attestation Enable</b> option is enabled.</p> <p>For additional security, Dell Technologies recommends keeping the <b>Attestation Enable</b> option enabled.</p>







**Table 39. System Setup options—Security menu (continued)**

<b>Security</b>	
	<p><b>i</b> <b>NOTE:</b> When disabled, this feature may cause compatibility issues or loss of functionality in some operating systems.</p> <p><b>i</b> <b>NOTE:</b> To view this option, enable <b>Advanced Setup</b> mode as described in <a href="#">View Advanced Setup options</a>.</p>
Key Storage Enable	<p>The <b>Key Storage Enable</b> option controls the storage hierarchy of TPM, which is used to store digital keys. Disabling the <b>Key Storage Enable</b> option restricts the ability of TPM to store owner's data.</p> <p>By default, the <b>Key Storage Enable</b> option is enabled.</p> <p>For additional security, Dell Technologies recommends keeping the <b>Key Storage Enable</b> option enabled.</p> <p><b>i</b> <b>NOTE:</b> When disabled, this feature may cause compatibility issues or loss of functionality in some operating systems.</p> <p><b>i</b> <b>NOTE:</b> To view this option, enable <b>Service</b> options as described in <a href="#">View Service options</a>.</p>
Clear	<p>When enabled, the <b>Clear</b> option clears information that is stored in the TPM after exiting the system's BIOS. This option returns to the disabled state when the computer restarts.</p> <p>By default, the <b>Clear</b> option is disabled.</p> <p>Dell Technologies recommends enabling the <b>Clear</b> option only when TPM data is required to be cleared.</p> <p><b>i</b> <b>NOTE:</b> To view this option, enable <b>Advanced Setup</b> mode as described in <a href="#">View Advanced Setup options</a>.</p>
Physical Presence Interface (PPI) Bypass for Clear Commands	<p>The PPI Bypass for Clear Commands option allows the operating system to manage certain aspects of PTT. When enabled, you are not prompted to confirm changes to the PTT configuration.</p> <p>By default, the <b>PPI Bypass for Clear Commands</b> option is disabled.</p> <p>For additional security, Dell Technologies recommends keeping the <b>PPI Bypass for Clear Commands</b> option disabled.</p>
Intel Total Memory Encryption	<p>Enables or disables the processor's memory encryption feature.</p> <p>By default, the <b>Intel Total Memory Encryption</b> option is disabled.</p> <p><b>i</b> <b>NOTE:</b> To view this option, enable <b>Advanced Setup</b> mode as described in <a href="#">View Advanced Setup options</a>.</p>
<b>Chassis Intrusion</b>	
Chassis Intrusion	<p>Enables or disables the detection of chassis intrusion events. This feature notifies the user when the base cover has been removed from the computer.</p> <p>When set to <b>Enabled</b>, a notification is displayed on the next boot and the event is logged in the BIOS Events log.</p> <p>When set to <b>Disabled</b>, no notification is displayed and no event is logged in the BIOS Events log.</p> <p>When set to <b>On-Silent</b>, the event is logged in the BIOS Events log, but no notification is displayed.</p> <p>By default, the <b>Chassis Intrusion Detection</b> option is disabled.</p> <p>For additional security, Dell Technologies recommends keeping the <b>Chassis Intrusion</b> option enabled.</p>

**Table 39. System Setup options—Security menu (continued)**

Security	
	<p> <b>NOTE:</b> To view this option, enable <b>Advanced Setup</b> mode as described in <a href="#">View Advanced Setup options</a>.</p>
Block Boot Until Cleared	<p>The <b>Block Boot Until Clear</b> option is enabled when <b>Chassis Intrusion</b> is enabled. When enabled, the computer does not boot until the chassis intrusion is cleared.</p> <p> <b>NOTE:</b> To view this option, enable <b>Advanced Setup</b> mode as described in <a href="#">View Advanced Setup options</a>.</p>
<b>SMM Security Mitigation</b>	<p>Enables or disables additional UEFI SMM Security Mitigation protections. This option uses the Windows SMM Security Mitigations Table (WSMT) to confirm to the operating system that security best practices have been implemented by the UEFI firmware.</p> <p>By default, the <b>SMM Security Mitigation</b> option is enabled.</p> <p>For additional security, Dell Technologies recommends keeping the <b>SMM Security Mitigation</b> option enabled unless you have a specific application which is not compatible.</p> <p> <b>NOTE:</b> This feature may cause compatibility issues or loss of functionality with some legacy tools and applications.</p> <p> <b>NOTE:</b> To view this option, enable <b>Service</b> options as described in <a href="#">View Service options</a>.</p>
Data Wipe on Next Boot	
Start Data Wipe	<p>Data Wipe is a secure wipe operation that deletes information from a storage device.</p> <p> <b>CAUTION: The Secure Data Wipe operation erases information in a way that it cannot be reconstructed.</b></p> <p>Commands such as delete and format in the operating system may remove files from showing up in the file system, however they can be reconstructed through forensic means as they are still represented on the physical media. Data Wipe prevents this reconstruction and is not recoverable.</p> <p>When enabled, the BIOS will queue up a data wipe cycle for storage devices that are connected to the motherboard on the next reboot.</p> <p>By default, the <b>Start Data Wipe</b> option is disabled.</p> <p> <b>NOTE:</b> To view this option, enable <b>Advanced Setup</b> mode as described in <a href="#">View Advanced Setup options</a>.</p>
<b>Absolute</b>	<p>Absolute Software provides various cyber security solutions, some requiring software preloaded on Dell computers and integrated into the BIOS. To use these features, you must enable the Absolute BIOS setting and contact Absolute for configuration and activation.</p> <p>By default, the <b>Absolute</b> option is enabled.</p> <p>For additional security, Dell Technologies recommends keeping the <b>Absolute</b> option enabled.</p> <p> <b>WARNING: The Permanently Disabled option can only be selected once. When Permanently Disabled is selected, Absolute Persistence cannot be reenabled. No further changes to the Enable/Disable states are allowed.</b></p> <p> <b>NOTE:</b> The Enable/Disable options are unavailable while the computer is in the activated state.</p>

**Table 39. System Setup options—Security menu (continued)**

Security	
	<p> <b>NOTE:</b> When the Absolute features are activated, the Absolute integration cannot be disabled from the BIOS Setup screen.</p>
<b>UEFI Boot Path Security</b>	<p>Enables or disables the computer to prompt the user to enter the Administrator password (if set) when booting to a UEFI boot path device from the F12 boot menu.</p> <p>By default, the <b>Always Except Internal HDD</b> option is enabled.</p> <p> <b>NOTE:</b> To view this option, enable <b>Advanced Setup</b> mode as described in <a href="#">View Advanced Setup options</a>.</p>
<b>Firmware Device Tamper Detection</b>	<p>Allows you to control the firmware device tamper detection feature. This feature notifies the user when the firmware device is tampered. When enabled, a screen warning message is displayed on the computer and a tamper detection event is logged in the BIOS Events log. The computer fails to reboot until the event is cleared.</p> <p>By default, the <b>Firmware Device Tamper Detection</b> option is enabled.</p> <p>For additional security, Dell Technologies recommends keeping the <b>Firmware Device Tamper Detection</b> option enabled.</p> <p> <b>NOTE:</b> To view this option, enable <b>Advanced Setup</b> mode as described in <a href="#">View Advanced Setup options</a>.</p>
Clear Firmware Device Tamper Detection	<p>Allows you to clear the events that are logged when tampering of firmware device is detected.</p> <p>By default, the <b>Clear Firmware Device Tamper Detection</b> option is disabled.</p> <p> <b>NOTE:</b> To view this option, enable <b>Advanced Setup</b> mode as described in <a href="#">View Advanced Setup options</a>.</p>

**Table 40. System Setup options—Passwords menu**

Passwords	
<b>Administrator Password</b>	<p>The Administrator Password prevents unauthorized access to the BIOS Setup options. Once the administrator password is set, the BIOS Setup options can only be modified after providing the correct password.</p> <p>The following rules and dependencies apply to the Administrator Password -</p> <ul style="list-style-type: none"> <li>• The administrator password cannot be set if system and/or internal hard drive passwords are previously set.</li> <li>• The administrator password can be used in place of the system and/or internal hard drive passwords.</li> <li>• When set, the administrator password must be provided during a firmware update.</li> <li>• Clearing the administrator password also clears the system password (if set).</li> </ul> <p>Dell Technologies recommends using an administrator password to prevent unauthorized changes to BIOS Setup options.</p>
<b>System Password</b>	<p>The System Password prevents the computer from booting to an operating system without entering the correct password.</p> <p>The following rules and dependencies apply when the System Password is used -</p> <ul style="list-style-type: none"> <li>• The computer shuts down when idle for approximately 10 minutes at the system password prompt.</li> <li>• The computer shuts down after three incorrect attempts to enter the system password.</li> <li>• The computer shuts down when the <b>Esc</b> key is pressed at the <b>System Password</b> prompt.</li> </ul>

**Table 40. System Setup options—Passwords menu (continued)**

<p><b>Passwords</b></p>	<ul style="list-style-type: none"> <li>The system password is not prompted when the computer resumes from standby mode.</li> </ul> <p>Dell Technologies recommends using the system password in situations where it is likely that a computer may be lost or stolen.</p>
<p><b>Hard Drive Password</b></p> <p><b>NOTE:</b> On some computers, the <b>M.2 PCIe SSD-0 Password</b> option is shown.</p>	<p>The hard drive password can be set to prevent unauthorized access of the data stored on the solid state drive. The computer prompts for the hard drive password during boot in order to unlock the drive. A password-secured hard drive stays locked even when removed from the computer or placed into another computer. It prevents an attacker from accessing data on the drive without authorization.</p> <p>The following rules and dependencies apply when the <b>Hard Drive Password</b> or <b>M.2 PCIe SSD-0 Password</b> option is used.</p> <ul style="list-style-type: none"> <li>The hard drive password option cannot be accessed when the hard drive is disabled in the BIOS Setup.</li> <li>The computer shuts down when idle for approximately 10 minutes at the hard drive password prompt.</li> <li>The computer shuts down after three incorrect attempts to enter the hard drive password and treats the hard drive as not available.</li> <li>The hard drive does not accept password unlock attempts after five incorrect attempts to enter the hard drive password from the BIOS Setup. The hard drive password must be reset for the new password unlock attempts.</li> <li>The computer treats the hard drive as not available when the <b>Esc</b> key is pressed at the hard drive password prompt.</li> <li>The hard drive password is not prompted when the computer resumes from standby mode. When the hard drive is unlocked by the user before the computer goes into standby mode, it remains unlocked after the computer resumes from standby mode.</li> <li>If the system and hard drive passwords are set to the same value, the hard drive unlocks after the correct system password is entered.</li> </ul> <p>Dell Technologies recommends using a hard drive password to protect unauthorized data access.</p>
<p><b>Password Configuration</b></p>	<p>The Password configuration page includes several options for changing the requirements of BIOS passwords. You can modify the minimum and maximum length of the passwords as well as require passwords to contain certain character classes (upper case, lower case, digit, special character).</p> <p>When the <b>Lower Case Letter</b> option is enabled, the password requires at least one lower case letter.</p> <p>When the <b>Upper Case Letter</b> option is enabled, the password requires at least one upper case letter.</p> <p>When the <b>Digit</b> option is enabled, the password requires at least one numeric digit.</p> <p>When the <b>Special Character</b> option is enabled, the password requires at least one special character from the set: !"#%&amp;'()*+,-./:;&lt;=&gt;?@[\\]^_`{ }~.</p> <p>When setting <b>Minimum Characters</b> for password length, Dell Technologies recommends setting the minimum password length to at least eight characters.</p> <p><b>NOTE:</b> To view this option, enable <b>Advanced Setup</b> mode as described in <a href="#">View Advanced Setup options</a>.</p>
<p><b>Password Bypass</b></p>	<p>The <b>Password Bypass</b> option allows the computer to reboot from the operating system without entering the system or hard drive password. If the computer has already booted to the operating system, it is presumed that the user has already entered the correct system or hard drive password.</p>

**Table 40. System Setup options—Passwords menu (continued)**

<b>Passwords</b>	
	<p><b>NOTE:</b> This option does not remove the requirement to enter the password after shutting down.</p> <p>By default, the <b>Password Bypass</b> option is disabled.</p> <p>For additional security, Dell Technologies recommends keeping the <b>Password Bypass</b> option enabled.</p> <p><b>NOTE:</b> To view this option, enable <b>Advanced Setup</b> mode as described in <a href="#">View Advanced Setup options</a>.</p>
<b>Password Changes</b>	
<b>Allow Non-Admin Password Changes</b>	<p>The <b>Allow Non-Admin Password Changes</b> option in BIOS Setup allows an end user to set or change the system or hard drive passwords without entering the administrator password. This gives an administrator control over the BIOS settings but enables an end user to provide their own password.</p> <p>By default, the <b>Allow Non-Admin Password Changes</b> option is enabled.</p> <p>For additional security, Dell Technologies recommends keeping the <b>Allow Non-Admin Password Changes</b> option disabled.</p> <p><b>NOTE:</b> To view this option, enable <b>Advanced Setup</b> mode as described in <a href="#">View Advanced Setup options</a>.</p>
<b>Non-Admin Setup Changes</b>	<p>The <b>Non-Admin Setup Changes</b> option allows an end user to configure the wireless devices without requiring the administrator password.</p> <p>By default, the <b>Non-Admin Setup Changes</b> option is disabled.</p> <p>For additional security, Dell Technologies recommends keeping the <b>Non-Admin Setup Changes</b> option disabled.</p> <p><b>NOTE:</b> To view this option, enable <b>Advanced Setup</b> mode as described in <a href="#">View Advanced Setup options</a>.</p>
<b>Enable Admin Setup Lockout</b>	<p>The <b>Admin Setup Lockout</b> option prevents an end user from even viewing the BIOS Setup configuration without first entering the administrator password (if set).</p> <p>By default, the <b>Enable Admin Setup Lockout</b> option is disabled.</p> <p>For additional security, Dell Technologies recommends keeping the <b>Admin Setup Lockout</b> option disabled.</p> <p><b>NOTE:</b> To view this option, enable <b>Advanced Setup</b> mode as described in <a href="#">View Advanced Setup options</a>.</p>
<b>Enable Master Password Lockout</b>	<p>The <b>Master Password Lockout</b> option allows you to disable the Recovery Password feature. If the system, administrator, or hard drive password is forgotten, the computer becomes unusable.</p> <p><b>NOTE:</b> When the owner password is set, the Master Password Lockout option is not available.</p> <p><b>NOTE:</b> When an internal hard drive password is set, it must first be cleared before Master Password Lockout can be changed.</p> <p>By default, the <b>Enable Master Password Lockout</b> option is disabled.</p> <p>Dell Technologies does not recommend enabling the <b>Master Password Lockout</b> unless you have implemented your own password recovery system.</p> <p><b>NOTE:</b> To view this option, enable <b>Advanced Setup</b> mode as described in <a href="#">View Advanced Setup options</a>.</p>
<b>Enable Allow Non-Admin PSID Revert</b>	<p>The <b>Allow Non-Admin PSID Revert</b> option allows a user to clear the hard drive password without entering the BIOS Admin Password. When an Admin Password</p>

**Table 40. System Setup options—Passwords menu (continued)**

Passwords	
	<p>is set, the ability to enter the PSID is protected by requiring authentication with the Admin Password. If this option is enabled, any user can clear the drive without entering the Admin Password.</p> <p>By default, the <b>Enable Allow Non-Admin PSID Revert</b> option is disabled.</p> <p><b>i</b> <b>NOTE:</b> To view this option, enable <b>Advanced Setup</b> mode as described in <a href="#">View Advanced Setup options</a>.</p>

**Table 41. System Setup options—Update, Recovery menu**

Update, Recovery	
UEFI Capsule Firmware Updates	
Enable UEFI Capsule Firmware Updates	<p>Enables or disables BIOS updates through UEFI capsule update packages.</p> <p><b>i</b> <b>NOTE:</b> Disabling this option blocks the BIOS updates from services such as Microsoft Windows Update and Linux Vendor Firmware Service (LVFS).</p> <p>By default, the <b>Enable UEFI Capsule Firmware Updates</b> option is enabled.</p> <p><b>i</b> <b>NOTE:</b> To view this option, enable <b>Advanced Setup</b> mode as described in <a href="#">View Advanced Setup options</a>.</p>
BIOS Recovery from Hard Drive	
	<p>Enables or disables the user to recover from certain corrupted BIOS conditions from a recovery file on the user primary hard drive or an external USB drive.</p> <p>By default, the <b>BIOS Recovery from Hard Drive</b> option is enabled.</p> <p><b>i</b> <b>NOTE:</b> BIOS Recovery from Hard Drive is not available for self-encrypting drives (SED).</p> <p><b>i</b> <b>NOTE:</b> BIOS recovery is designed to fix the main BIOS block and cannot work if the Boot Block is damaged. In addition, this feature cannot work in the event of EC corruption, ME corruption, or a hardware issue. The recovery image must exist on an unencrypted partition on the drive.</p> <p><b>i</b> <b>NOTE:</b> To view this option, enable <b>Advanced Setup</b> mode as described in <a href="#">View Advanced Setup options</a>.</p>
BIOS Downgrade	
Allow BIOS Downgrade	<p>Allows downgrading of the system firmware to previous revisions.</p> <p>By default, the <b>Allow BIOS Downgrade</b> option is enabled.</p>
SupportAssist OS Recovery	
	<p>Enables or disables the boot flow for SupportAssist OS Recovery tool if certain system errors occur.</p> <p>By default, the <b>SupportAssist OS Recovery</b> option is enabled.</p>
BIOSConnect	
	<p>Enables or disables cloud service operating system recovery if the main operating system fails to boot with the number of failures equal to or greater than the value specified by the Auto operating system Recovery Threshold setup option and local service operating system does not boot or is not installed.</p> <p>By default, the <b>BIOSConnect</b> option is enabled.</p>
Dell Auto OS Recovery Threshold	
	<p>Allows the control of the automatic boot flow for the SupportAssist System Resolution Console and the Dell operating system Recovery Tool.</p> <p>By default, the <b>Dell Auto OS Recovery Threshold</b> value is set to <b>2</b>.</p> <p><b>i</b> <b>NOTE:</b> To view this option, enable <b>Advanced Setup</b> mode as described in <a href="#">View Advanced Setup options</a>.</p>

**Table 42. System Setup options—System Management menu**

System Management	
<b>Service Tag</b>	Displays the Service Tag of the computer.
<b>Asset Tag</b>	Creates a computer Asset Tag that an IT administrator can use to uniquely identify a particular computer. <b>i</b> <b>NOTE:</b> Once set in the BIOS, the Asset Tag cannot be changed.
<b>Wake on AC</b>	Enables or disables the computer to turn on and go to boot when AC power is supplied to the computer. By default, the <b>Wake on AC</b> option is disabled. <b>i</b> <b>NOTE:</b> To view this option, enable <b>Advanced Setup</b> mode as described in <a href="#">View Advanced Setup options</a> .
<b>Wake on LAN</b>	Enables or disables the computer to turn on by a special LAN signal. By default, the <b>Wake on LAN</b> option is disabled. <b>i</b> <b>NOTE:</b> To view this option, enable <b>Advanced Setup</b> mode as described in <a href="#">View Advanced Setup options</a> .
<b>Auto On Time</b>	Enable to set the computer to turn on automatically every day or on a preselected date and time. This option can be configured only if the Auto On Time is set to Everyday, Weekdays, or Selected Days. By default, the <b>Auto On Time</b> option is disabled. <b>i</b> <b>NOTE:</b> To view this option, enable <b>Advanced Setup</b> mode as described in <a href="#">View Advanced Setup options</a> .
<b>Intel AMT capability</b>	Configure Intel Active Management Technology (AMT) options, which can be enabled, disabled, or restricted. <b>i</b> <b>NOTE:</b> To view this option, enable <b>Advanced Setup</b> mode as described in <a href="#">View Advanced Setup options</a> .
<b>Diagnostics OS agent requests</b>	Enable or disable the option for applications running in the operating system to run with preboot diagnostics on subsequent boots. <b>i</b> <b>NOTE:</b> To view this option, enable <b>Advanced Setup</b> mode as described in <a href="#">View Advanced Setup options</a> .
<b>Power-On-Self-Test Automatic Recovery</b>	Enable or disable the automatic recovery of the computer from no power or no-POST failure by applying mitigation steps. By default, the <b>Power-On-Self-Test Automatic Recovery</b> option is enabled. <b>i</b> <b>NOTE:</b> To view this option, enable <b>Advanced Setup</b> mode as described in <a href="#">View Advanced Setup options</a> .

**Table 43. System Setup options—Keyboard menu**

Keyboard	
<b>Fn Lock Options</b>	Enables or disables the Fn Lock option. By default, the <b>Fn Lock</b> option is enabled.
<b>Lock Mode</b>	By default, the <b>Lock Mode Secondary</b> option is enabled. With this option, the F1-F12 keys scan the code for their secondary functions.
<b>Keyboard Illumination</b>	Configures the operating mode of the keyboard illumination feature. By default, the <b>Bright</b> option is selected. Enables the keyboard illumination feature at 100% brightness level.
<b>Keyboard Backlight Timeout on AC</b>	Sets the timeout value for the keyboard backlight when an AC adapter is connected to the computer.

**Table 43. System Setup options—Keyboard menu (continued)**

Keyboard	
	<p>By default, the <b>10 seconds</b> option is selected.</p> <p><b>i</b> <b>NOTE:</b> To view this option, enable <b>Advanced Setup</b> mode as described in <a href="#">View Advanced Setup options</a>.</p>
<b>Keyboard Backlight Timeout on Battery</b>	<p>Sets the timeout value for the keyboard backlight when the computer is running only on the battery power. The keyboard backlight timeout value is only effective when the backlight is enabled.</p> <p>By default, the <b>10 seconds</b> option is selected.</p> <p><b>i</b> <b>NOTE:</b> To view this option, enable <b>Advanced Setup</b> mode as described in <a href="#">View Advanced Setup options</a>.</p>
<b>Device Configuration HotKey Access</b>	<p>Allows you to control whether you can access device configuration screens through hotkeys during system startup.</p> <p>By default, the <b>Device Configuration HotKey Access</b> option is enabled.</p> <p><b>i</b> <b>NOTE:</b> This setting controls only the Intel RAID (CTRL+I), MEBX (CTRL+P), and LSI RAID (CTRL+C) Option ROMs. Other preboot Option ROMs, which support entry using a key sequence, are not affected by this setting.</p> <p><b>i</b> <b>NOTE:</b> To view this option, enable <b>Advanced Setup</b> mode as described in <a href="#">View Advanced Setup options</a>.</p>

**Table 44. System Setup options—Pre-boot Behavior menu**

Pre-boot Behavior	
<b>Adapter Warnings</b>	
Enable Dock Warning Messages	<p>Enables the warning messages during boot when the adapters with less power capacity are detected.</p> <p>By default, the <b>Enable Dock Warning Messages</b> option is enabled.</p> <p><b>i</b> <b>NOTE:</b> To view this option, enable <b>Advanced Setup</b> mode as described in <a href="#">View Advanced Setup options</a>.</p>
<b>Warnings and Errors</b>	<p>Enables or disables the action to be taken when a warning or error is encountered.</p> <p>By default, the <b>Prompt on Warnings and Errors</b> option is selected. Stop, prompt, and wait for user input when warnings or errors are detected.</p> <p><b>i</b> <b>NOTE:</b> Errors deemed critical to the operation of the computer hardware stop the functioning of the computer.</p> <p><b>i</b> <b>NOTE:</b> To view this option, enable <b>Advanced Setup</b> mode as described in <a href="#">View Advanced Setup options</a>.</p>
<b>USB-C Warnings</b>	
Enable Dock Warning Messages	<p>Enables the warning messages during boot when the USB-C adapters with less power capacity are detected.</p> <p>By default, the <b>Enable Dock Warning Messages</b> option is enabled.</p> <p><b>i</b> <b>NOTE:</b> To view this option, enable <b>Advanced Setup</b> mode as described in <a href="#">View Advanced Setup options</a>.</p>
<b>Fastboot</b>	<p>Configure the speed of the UEFI boot process.</p> <p>By default, the <b>Thorough</b> option is selected. Performs complete hardware and configuration initialization during boot.</p>



**Table 44. System Setup options—Pre-boot Behavior menu (continued)**

<b>Pre-boot Behavior</b>	
	<p><b>i</b> <b>NOTE:</b> To view this option, enable <b>Advanced Setup</b> mode as described in <a href="#">View Advanced Setup options</a>.</p>
<b>Extend BIOS POST Time</b>	<p>Sets the BIOS POST (Power-On Self-Test) load time.</p> <p>By default, the <b>0 seconds</b> option is selected.</p> <p><b>i</b> <b>NOTE:</b> To view this option, enable <b>Advanced Setup</b> mode as described in <a href="#">View Advanced Setup options</a>.</p>
<b>MAC Address Pass-Through</b>	<p>Replaces the external NIC MAC address (in a supported dock or dongle) with the selected MAC address from the computer.</p> <p>By default, the <b>System Unique MAC Address</b> option is selected.</p>
<b>Sign of Life</b>	
Early Keyboard Backlight	<p>Enables or disables the Keyboard Backlight Sign of Life.</p> <p>By default, the <b>Early Keyboard Backlight</b> option is enabled.</p> <p><b>i</b> <b>NOTE:</b> To view this option, enable <b>Advanced Setup</b> mode as described in <a href="#">View Advanced Setup options</a>.</p>

**Table 45. System Setup options—Virtualization menu**

<b>Virtualization Support</b>	
<b>Intel Virtualization Technology</b>	
Enable Intel Virtualization Technology (VT)	<p>When enabled, the computer can run a Virtual Machine Monitor (VMM).</p> <p>By default, the <b>Enable Intel Virtualization Technology (VT)</b> option is enabled.</p> <p><b>i</b> <b>NOTE:</b> To view this option, enable <b>Advanced Setup</b> mode as described in <a href="#">View Advanced Setup options</a>.</p>
<b>VT for Direct I/O</b>	
Enable Intel VT for Direct I/O	<p>When enabled, the computer can perform Virtualization Technology for Direct I/O (VT-d). VT-d is an Intel method that provides virtualization for memory map I/O.</p> <p>By default, the <b>Enable Intel VT for Direct I/O</b> option is enabled.</p> <p><b>i</b> <b>NOTE:</b> To view this option, enable <b>Advanced Setup</b> mode as described in <a href="#">View Advanced Setup options</a>.</p>
<b>Intel Trusted Execution Technology (TXT)</b>	<p>Specifies whether a measured Virtual Machine Monitor (MVMM) can use the additional hardware capabilities provided by Intel Trusted Execution Technology. The following must be enabled in order to enable Intel TXT -</p> <ul style="list-style-type: none"> <li>● Trusted Platform Module (TPM)</li> <li>● Intel Hyper-Threading</li> <li>● All CPU cores (Multi-Core Support)</li> <li>● Intel Virtualization Technology</li> <li>● Intel VT for Direct I/O</li> </ul> <p>By default, the <b>Intel Trusted Execution Technology (TXT)</b> option is disabled.</p> <p><b>i</b> <b>NOTE:</b> To view this option, enable <b>Advanced Setup</b> mode as described in <a href="#">View Advanced Setup options</a>.</p>
<b>DMA Protection</b>	
Enable Pre-Boot DMA Support	<p>Allows you to control the Pre-Boot DMA protection for both internal and external ports. This option does not directly enable DMA protection in the operating system.</p>





**Table 45. System Setup options—Virtualization menu (continued)**

Virtualization Support	
	<p><b>i</b> <b>NOTE:</b> This option is not available when the virtualization setting for IOMMU is disabled (VT-d/AMD Vi).</p> <p>By default, the <b>Enable Pre-Boot DMA Support</b> option is enabled.</p> <p>For additional security, Dell Technologies recommends keeping the <b>Enable Pre-Boot DMA Support</b> option enabled.</p> <p><b>i</b> <b>NOTE:</b> This option is provided only for compatibility purposes, since some older hardware is not DMA capable.</p> <p><b>i</b> <b>NOTE:</b> To view this option, enable <b>Advanced Setup</b> mode as described in <a href="#">View Advanced Setup options</a>.</p>
Enable OS Kernel DMA Support	<p>Allows you to control the Kernel DMA protection for both internal and external ports. This option does not directly enable DMA protection in the operating system. For operating systems that support DMA protection, this setting indicates to the operating system that the BIOS supports the feature.</p> <p><b>i</b> <b>NOTE:</b> This option is not available when the virtualization setting for IOMMU is disabled (VT-d/AMD Vi).</p> <p>By default, the <b>Enable OS Kernel DMA Support</b> option is enabled.</p> <p><b>i</b> <b>NOTE:</b> This option is provided only for compatibility purposes, since some older hardware is not DMA capable.</p> <p><b>i</b> <b>NOTE:</b> To view this option, enable <b>Advanced Setup</b> mode as described in <a href="#">View Advanced Setup options</a>.</p>



**Table 46. System Setup options—Performance menu**

Performance	
Multi-Core Support	
Active multiple Performance Cores (P-Cores) Select	<p>Change the number of performance cores available to the operating system. The default value is set to the maximum number of cores.</p> <p>By default, the <b>All Active</b> option is selected.</p> <p><b>i</b> <b>NOTE:</b> To view this option, enable <b>Advanced Setup</b> mode as described in <a href="#">View Advanced Setup options</a>.</p>
Active Efficient Cores (E-Cores) Select	<p>Change the number of efficient cores available to the operating system. The default value is set to the maximum number of cores.</p> <p>By default, the <b>All Active</b> option is selected.</p> <p><b>i</b> <b>NOTE:</b> To view this option, enable <b>Advanced Setup</b> mode as described in <a href="#">View Advanced Setup options</a>.</p>
Intel SpeedStep	
Enable Intel SpeedStep Technology	<p>Enables the computer to dynamically adjust processor voltage and core frequency, decreasing average power consumption and heat production.</p> <p>By default, the <b>Enable Intel SpeedStep Technology</b> option is enabled.</p> <p><b>i</b> <b>NOTE:</b> To view this option, enable <b>Service</b> options as described in <a href="#">View Service options</a>.</p>
C-State Control	
Enable C-State Control	<p>Enables or disables the ability of the CPU to enter and exit low-power state. When disabled, it disables all C-states. When enabled, it enables all C-states that the chipset or platform allows.</p> <p>By default, the <b>Enable C-State Control</b> option is enabled.</p>

**Table 46. System Setup options—Performance menu (continued)**

<b>Performance</b>	
	<p> <b>NOTE:</b> To view this option, enable <b>Advanced Setup</b> mode as described in <a href="#">View Advanced Setup options</a>.</p>
Enable Adaptive C-States For Discrete Graphics	<p>Enables the computer to detect high usage of a discrete graphics and adjust the computer parameters for higher performance during that time period.</p> <p>By default, the <b>Enable Adaptive C-States For Discrete Graphics</b> option is enabled.</p> <p> <b>NOTE:</b> To view this option, enable <b>Advanced Setup</b> mode as described in <a href="#">View Advanced Setup options</a>.</p>
<b>Intel Turbo Boost Technology</b>	
Enable Intel Turbo Boost Technology	<p>Enables or disables the Intel TurboBoost mode of the processor. When enabled, the Intel TurboBoost driver increases the performance of the CPU or graphics processor.</p> <p>By default, the <b>Enable Intel Turbo Boost Technology</b> option is enabled.</p> <p> <b>NOTE:</b> To view this option, enable <b>Advanced Setup</b> mode as described in <a href="#">View Advanced Setup options</a>.</p>
<b>Intel Hyper-Threading Technology</b>	
Enable Intel Hyper-Threading Technology	<p>Enables or disables the Intel Hyper-Threading mode of the processor. When enabled, the Intel Hyper-Threading increases the efficiency of the processor resources when multiple threads run on each core.</p> <p>By default, the <b>Intel Hyper-Threading Technology</b> option is enabled.</p> <p> <b>NOTE:</b> To view this option, enable <b>Advanced Setup</b> mode as described in <a href="#">View Advanced Setup options</a>.</p>
<b>Adaptive Optimization</b>	
Enable, Disable	<p>Enables or disables Presto 3 performance feature.</p> <p>By default, the <b>Adaptive Optimization</b> option is enabled.</p> <p> <b>NOTE:</b> To view this option, enable <b>Service</b> options as described in <a href="#">View Service options</a>.</p>

**Table 47. System Setup options—System Logs menu**

<b>System Logs</b>	
<b>BIOS Event Log</b>	
Clear BIOS Event Log	<p>Select the option to keep or clear BIOS events logs.</p> <p>By default, the <b>Keep Log</b> option is selected.</p> <p> <b>NOTE:</b> To view this option, enable <b>Advanced Setup</b> mode as described in <a href="#">View Advanced Setup options</a>.</p>
<b>Thermal Event Log</b>	
Clear Thermal Event Log	<p>Select the option to keep or clear Thermal events logs.</p> <p>By default, the <b>Keep Log</b> option is selected.</p> <p> <b>NOTE:</b> To view this option, enable <b>Advanced Setup</b> mode as described in <a href="#">View Advanced Setup options</a>.</p>
<b>Power Event Log</b>	
Clear Power Event Log	<p>Select the option to keep or clear Power events logs.</p>

**Table 47. System Setup options—System Logs menu (continued)**

System Logs
By default, the <b>Keep Log</b> option is selected.  <b>NOTE:</b> To view this option, enable <b>Advanced Setup</b> mode as described in <a href="#">View Advanced Setup options</a> .

## Updating the BIOS

### Updating the BIOS in Windows

#### About this task

 **CAUTION:** If BitLocker is not suspended before updating the BIOS, the next time you reboot the computer it will not recognize the BitLocker key. You will then be prompted to enter the recovery key to progress, and the computer will ask for this on each reboot. If the recovery key is not known this can result in data loss or an unnecessary operating system reinstall. For more information about this subject, search in the Knowledge Base Resource at [www.dell.com/support](http://www.dell.com/support).

#### Steps

1. Go to [www.dell.com/support](http://www.dell.com/support).
2. Click **Product support**. In the **Search support** box, enter the Service Tag of your computer, and then click **Search**.  
 **NOTE:** If you do not have the Service Tag, use the SupportAssist feature to automatically identify your computer. You can also use the product ID or manually browse for your computer model.
3. Click **Drivers & Downloads**. Expand **Find drivers**.
4. Select the operating system installed on your computer.
5. In the **Category** drop-down list, select **BIOS**.
6. Select the latest version of BIOS, and click **Download** to download the BIOS file for your computer.
7. After the download is complete, browse the folder where you saved the BIOS update file.
8. Double-click the BIOS update file icon and follow the on-screen instructions.  
For more information, search in the Knowledge Base Resource at [www.dell.com/support](http://www.dell.com/support).

### Updating the BIOS in Linux and Ubuntu

To update the system BIOS on a computer that is installed with Linux or Ubuntu, see the knowledge base article [000131486](https://www.dell.com/support) at [www.dell.com/support](http://www.dell.com/support).

### Updating the BIOS using the USB drive in Windows

#### About this task

 **CAUTION:** If BitLocker is not suspended before updating the BIOS, the next time you reboot the computer it will not recognize the BitLocker key. You will then be prompted to enter the recovery key to progress, and the computer will ask for this on each reboot. If the recovery key is not known this can result in data loss or an unnecessary operating system reinstall. For more information about this subject, search in the Knowledge Base Resource at [www.dell.com/support](http://www.dell.com/support).

#### Steps

1. Follow the procedure from step 1 to step 6 in [Updating the BIOS in Windows](#) to download the latest BIOS setup program file.

2. Create a bootable USB drive. For more information, search in the Knowledge Base Resource at [www.dell.com/support](http://www.dell.com/support).
3. Copy the BIOS setup program file to the bootable USB drive.
4. Connect the bootable USB drive to the computer that needs the BIOS update.
5. Restart the computer and press **F12**.
6. Select the USB drive from the **One Time Boot Menu**.
7. Type the BIOS setup program filename and press **Enter**.  
The **BIOS Update Utility** appears.
8. Follow the on-screen instructions to complete the BIOS update.

## Updating the BIOS from the F12 One-Time boot menu

Update your computer BIOS using the BIOS update.exe file that is copied to a FAT32 USB drive and booting from the F12 One-Time boot menu.

### About this task

 **CAUTION:** If BitLocker is not suspended before updating the BIOS, the next time you reboot the computer it will not recognize the BitLocker key. You will then be prompted to enter the recovery key to progress, and the computer will ask for this on each reboot. If the recovery key is not known this can result in data loss or an unnecessary operating system reinstall. For more information about this subject, search in the Knowledge Base Resource at [www.dell.com/support](http://www.dell.com/support).

### BIOS Update

You can run the BIOS update file from Windows using a bootable USB drive or you can also update the BIOS from the F12 One-Time boot menu on the computer.

Most of the Dell computers built after 2012 have this capability, and you can confirm by booting your computer to the F12 One-Time Boot Menu to see if BIOS FLASH UPDATE is listed as a boot option for your computer. If the option is listed, then the BIOS supports this BIOS update option.

 **NOTE:** Only computers with the BIOS Flash Update option in the F12 One-Time boot menu can use this function.

### Updating from the One-Time boot menu

To update your BIOS from the F12 One-Time boot menu, you need the following:

- USB drive formatted to the FAT32 file system (key does not have to be bootable)
- BIOS executable file that you downloaded from the Dell Support website and copied to the root of the USB drive
- AC power adapter that is connected to the computer
- Functional computer battery to flash the BIOS

Perform the following steps to perform the BIOS update flash process from the F12 menu:

 **CAUTION:** Do not turn off the computer during the BIOS update process. The computer may not boot if you turn off your computer.

### Steps

1. From a turn off state, insert the USB drive where you copied the flash into a USB port of the computer.
2. Turn on the computer and press F12 to access the One-Time Boot Menu, select BIOS Update using the mouse or arrow keys then press Enter.  
The flash BIOS menu is displayed.
3. Click **Flash from file**.
4. Select an external USB device.
5. Select the file and double-click the flash target file, and then click **Submit**.
6. Click **Update BIOS**. The computer restarts to flash the BIOS.
7. The computer will restart after the BIOS update is completed.

# System and setup password

Table 48. System and setup password

Password type	Description
System password	Password that you must enter to log in to your system.
Setup password	Password that you must enter to access and make changes to the BIOS settings of your computer.

You can create a system password and a setup password to secure your computer.

 **CAUTION:** The password features provide a basic level of security for the data on your computer.

 **CAUTION:** Anyone can access the data that is stored on your computer, when not locked and left unattended.

 **NOTE:** System and setup password feature is disabled.

## Assigning a System Setup password

### Prerequisites

You can assign a new System or Admin Password only when the status is in **Not Set**.

### About this task

To enter BIOS System Setup, press F2 immediately after a power-on or reboot.

### Steps

1. In the **System BIOS** or **System Setup** screen, select **Security** and press Enter.  
The **Security** screen is visible.
2. Select **System/Admin Password** and create a password in the **Enter the new password** field.  
Use the following guidelines to assign the system password:
  - A password can have up to 32 characters.
  - At least one special character: "( ! " # \$ % & ' \* + , - . / : ; < = > ? @ [ \ ] ^ \_ ` { | } )"
  - Numbers 0 to 9.
  - Upper case letters from A to Z.
  - Lower case letters from a to z.
3. Type the system password that you entered earlier in the **Confirm new password** field and click **OK**.
4. Press Esc and save the changes as prompted by the message.
5. Press Y to save the changes.  
The computer restarts.

## Deleting or changing an existing system setup password

### Prerequisites

Ensure that the **Password Status** is Unlocked (in the System Setup) before attempting to delete or change the existing System and/or Setup password. You cannot delete or change an existing System or Setup password, if the **Password Status** is Locked.

### About this task

To enter the System Setup, press F2 immediately after a power-on or reboot.

## Steps

1. In the **System BIOS** or **System Setup** screen, select **System Security** and press Enter. The **System Security** screen is displayed.
2. In the **System Security** screen, verify that the Password Status is **Unlocked**.
3. Select **System Password**, update, or delete the existing system password, and press Enter or Tab.
4. Select **Setup Password**, update, or delete the existing setup password, and press Enter or Tab.  
**NOTE:** If you change the System and/or Setup password, reenter the new password when prompted. If you delete the System and/or Setup password, confirm the deletion when prompted.
5. Press Esc. A message prompts you to save the changes.
6. Press Y to save the changes and exit from System Setup. The computer restarts.

# Clearing BIOS (System Setup) and System passwords

## About this task

To clear the system or BIOS passwords, contact Dell technical support as described at [www.dell.com/contactdell](http://www.dell.com/contactdell).

**NOTE:** For information about how to reset Windows or application passwords, see the documentation accompanying Windows or your application.

# Clearing chassis intrusion alerts

The computer features a chassis intrusion switch which can detect anytime the base cover is removed from the computer.

Alerts to notify you of any intrusions can be enabled through the **Chassis Intrusion** field in the **Security** sub-menu of the BIOS setup menu.

When enabled, the **Block Boot Until Cleared** field allows you to choose whether to prevent normal boot-up of the computer until the intrusion alert is cleared.

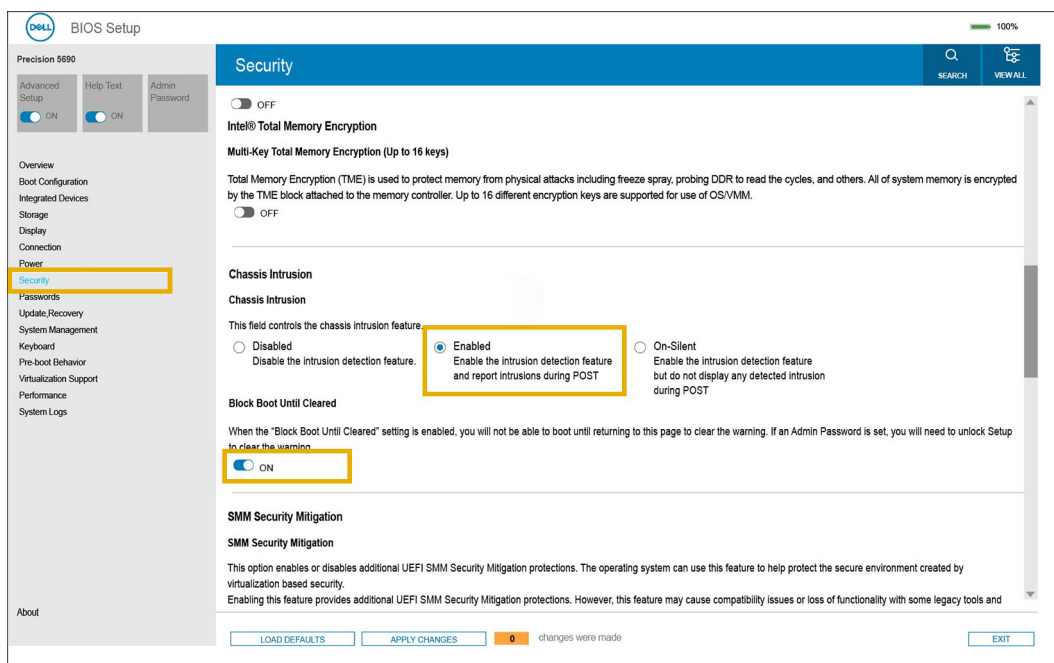
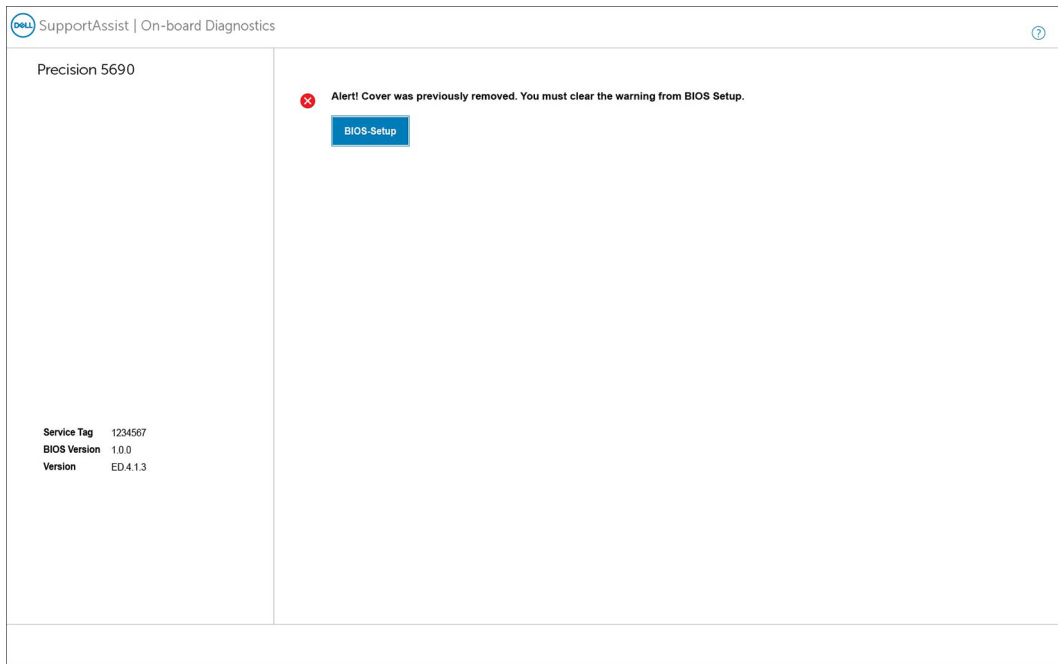

Figure 83. Clearing chassis intrusion alerts

If **Block Boot Until Cleared** is set to **ON**, you must select **BIOS-Setup** and clear the intrusion alert to enable a normal boot-up.



**Figure 84. Clearing chassis intrusion alerts**

If **Block Boot Until Cleared** is set to **OFF**, select **Continue** to enable a normal boot-up or **BIOS-Setup** to clear the alert.

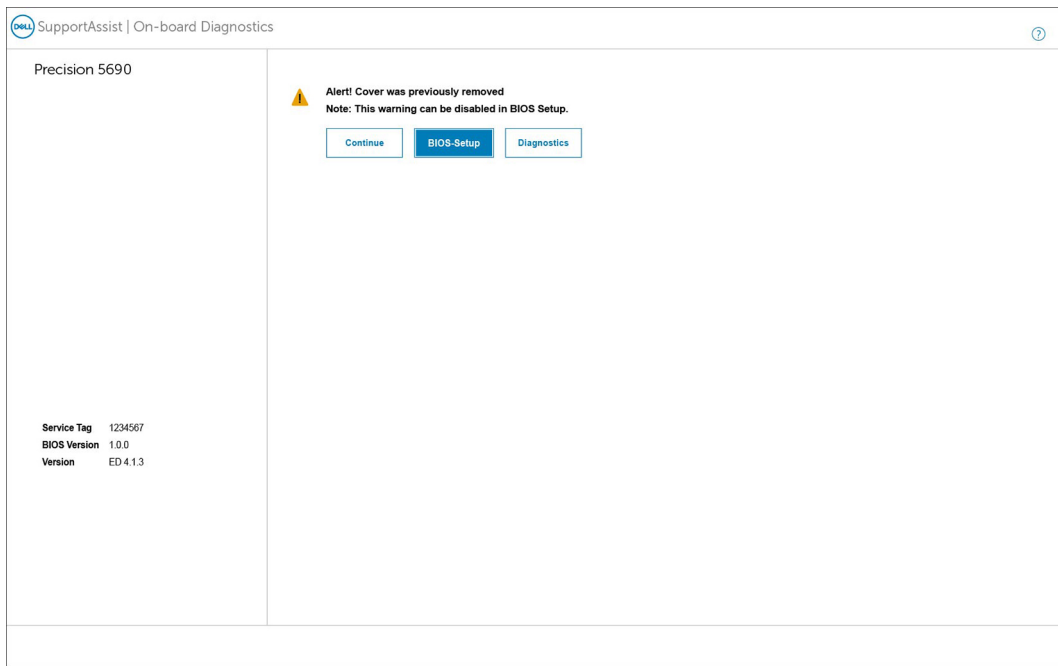

**Figure 85. Clearing chassis intrusion alerts**

**NOTE:** If **Continue** is selected, you continue to see the alert each time the computer is turned on until the alert is cleared.

To clear the alert, select **ON** in the **Clear Intrusion Warning** field in the **Security** sub-menu of the BIOS setup menu.



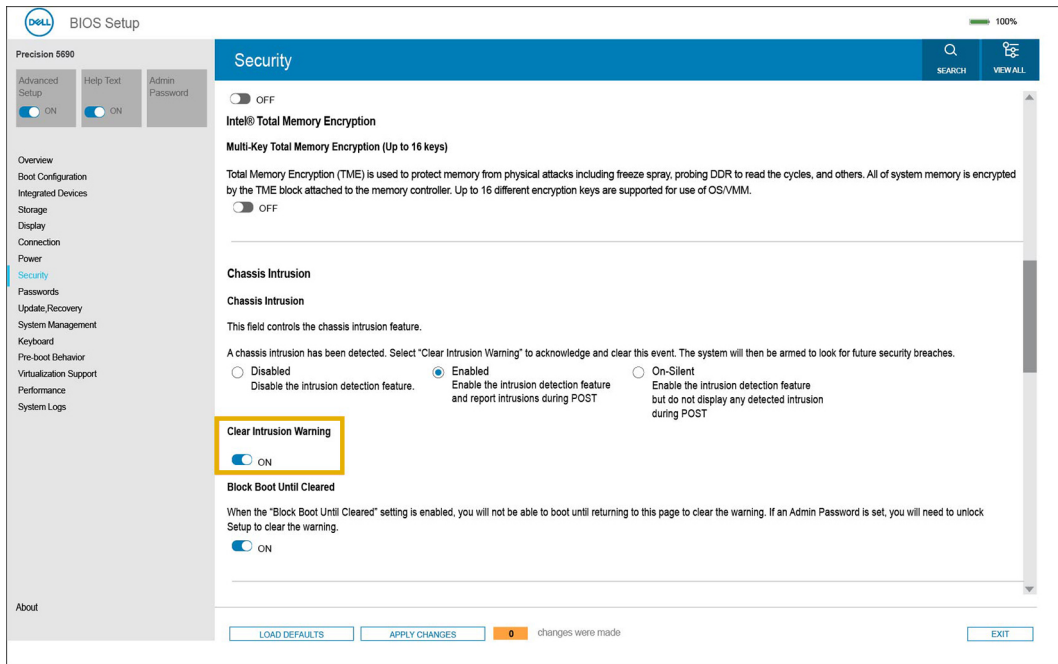

Figure 86. Clearing chassis intrusion alerts

# Troubleshooting

## Handling swollen rechargeable Li-ion batteries

Like most laptops, Dell laptops use Lithium-ion batteries. One type of Lithium-ion battery is the rechargeable Li-ion battery. Rechargeable Li-ion batteries have increased in popularity in recent years and have become standard in the electronics industry due to customer preferences for a slim form factor (especially with newer ultra-thin laptops) and long battery life. Inherent to rechargeable Li-ion battery technology is the potential for swelling of the battery cells.

A swollen battery may impact the performance of the laptop. To prevent possible further damage to the device enclosure or internal components leading to malfunction, discontinue the use of the laptop and discharge it by disconnecting the AC adapter and letting the battery drain.

Swollen batteries should not be used and should be replaced and disposed of properly. We recommend contacting Dell product support for options to replace a swollen battery under the terms of the applicable warranty or service contract, including options for replacement by a Dell authorized service technician.

The guidelines for handling and replacing rechargeable Li-ion batteries are as follows:

- Exercise caution when handling rechargeable Li-ion batteries.
- Discharge the battery before removing it from the system. To discharge the battery, unplug the AC adapter from the system and operate the system only on battery power. When the system will no longer turn on when the power button is pressed, the battery is fully discharged.
- Do not crush, drop, mutilate, or penetrate the battery with foreign objects.
- Do not expose the battery to high temperatures, or disassemble battery packs and cells.
- Do not apply pressure to the surface of the battery.
- Do not bend the battery.
- Do not use tools of any type to pry on or against the battery.
- If a battery gets stuck in a device as a result of swelling, do not try to free it as puncturing, bending, or crushing a battery can be dangerous.
- Do not attempt to reassemble a damaged or swollen battery into a laptop.
- Swollen batteries that are covered under warranty should be returned to Dell in an approved shipping container (provided by Dell)—this is to comply with transportation regulations. Swollen batteries that are not covered under warranty should be disposed of at an approved recycling center. Contact Dell product support at <https://www.dell.com/support> for assistance and further instructions.
- Using a non-Dell or incompatible battery may increase the risk of fire or explosion. Replace the battery only with a compatible battery purchased from Dell that is designed to work with your Dell computer. Do not use a battery from other computers with your computer. Always purchase genuine batteries from <https://www.dell.com> or otherwise directly from Dell.

Rechargeable Li-ion batteries can swell for various reasons such as age, number of charge cycles, or exposure to high heat. For more information about how to improve the performance and lifespan of the laptop battery and to minimize the possibility of occurrence of the issue, search Dell Laptop Battery in the Knowledge Base Resource at [www.dell.com/support](http://www.dell.com/support).

## Locate the Service Tag or Express Service Code of your Dell computer

Your Dell computer is uniquely identified with a Service Tag or Express Service Code. To view relevant support resources for your Dell computer, we recommend entering the Service Tag or Express Service Code at [www.dell.com/support](http://www.dell.com/support).

For more information about how to find the Service Tag for your computer, see [Locate the Service Tag on your computer](#).

# Dell SupportAssist Pre-boot System Performance Check diagnostics

## About this task

SupportAssist diagnostics (also known as system diagnostics) performs a complete check of your hardware. The Dell SupportAssist Pre-boot System Performance Check diagnostics is embedded with the BIOS and launched by the BIOS internally. The embedded system diagnostics provides options for particular devices or device groups allowing you to:

- Run tests automatically or in an interactive mode.
- Repeat the tests.
- Display or save test results.
- Run thorough tests to introduce additional test options to provide extra information about one or more failed devices.
- View status messages that inform you the tests are completed successfully.
- View error messages that inform you of problems encountered during testing.

 **NOTE:** Some tests for specific devices require user interaction. Always ensure that you are present at the computer terminal when the diagnostic tests are performed.

For more information, see the knowledge base article [000180971](#).

## Running the SupportAssist Pre-Boot System Performance Check

### Steps

1. Turn on your computer.
2. As the computer boots, press the F12 key as the Dell logo appears.
3. On the boot menu screen, select the **Diagnostics** option.
4. Click the arrow at the bottom left corner.  
Diagnostics front page is displayed.
5. Click the arrow in the lower-right corner to go to the page listing.  
The items that are detected are listed.
6. To run a diagnostic test on a specific device, press Esc and click **Yes** to stop the diagnostic test.
7. Select the device from the left pane and click **Run Tests**.
8. If there are any issues, error codes are displayed.  
Note the error code and validation number and contact Dell.

## Built-in self-test (BIST)

### M-BIST

M-BIST (Built In Self-Test) is the system board built-in self-test diagnostics tool that improves the diagnostics accuracy of system board Embedded Controller (EC) failures.

 **NOTE:** M-BIST can be manually initiated before Power On Self-Test (POST).

### How to run M-BIST

 **NOTE:** M-BIST must be initiated on the computer from a power-off state that is either connected to AC power or with a battery only.

1. Press and hold both the **M** key on the keyboard and the **power button** to initiate M-BIST.
2. The battery indicator LED may exhibit two states:
  - a. OFF: No fault was detected with the system board.
  - b. AMBER: Amber indicates a problem with the system board.

- If there is a failure with the system board, the battery status LED flashes one of the following error codes for 30 seconds:

**Table 49. LED error codes**

Blinking Pattern		Possible Problem
Amber	White	
2	1	CPU Failure
2	8	LCD Power Rail Failure
1	1	TPM Detection Failure
2	4	Memory/RAM failure

- If there is no failure with the system board, the LCD cycles through the solid color screens that are described in the LCD-BIST section for 30 seconds and then turn off.

## LCD Power rail test (L-BIST)

L-BIST is an enhancement to the single LED error code diagnostics and is automatically initiated during POST. L-BIST will check the LCD power rail. If there is no power being supplied to the LCD (that is if the L-BIST circuit fails), the battery status LED flashes either an error code [2,8] or an error code [2,7].

**i** **NOTE:** If L-BIST fails, LCD-BIST cannot function as no power will be supplied to the LCD.

### How to invoke the L-BIST Test:

- Press the power button to start the computer.
- If the computer does not start up normally, look at the battery status LED:
  - If the battery status LED flashes an error code [2,7], the display cable may not be connected properly.
  - If the battery status LED flashes an error code [2,8], there is a failure on the LCD power rail of the system board, hence there is no power that is supplied to the LCD.
- For cases, when a [2,7] error code is shown, check to see if the display cable is properly connected.
- For cases when a [2,8] error code is shown, replace the system board.

## LCD Built-in Self-Test (BIST)

Dell laptops have a built-in diagnostic tool that helps you determine if the screen abnormality you are experiencing is an inherent problem with the LCD (screen) of the Dell laptop or with the video card (GPU) and computer settings.

When you notice screen abnormalities like flickering, distortion, clarity issues, fuzzy or blurry image, horizontal or vertical lines, color fade and so on, it is always a good practice to isolate the LCD (screen) by running the Built-In Self-Test (BIST).

### How to invoke the LCD BIST Test

- Power off the Dell laptop.
- Disconnect any peripherals that are connected to the laptop. Connect only the AC adapter (charger) to the laptop.
- Ensure that the LCD (screen) is clean (no dust particles on the surface of the screen).
- Press and hold the **D** key and **Power on** the laptop to enter LCD built-in self-test (BIST) mode. Continue to hold the D key until the computer boots up.
- The screen displays solid colors and change colors on the entire screen to white, black, red, green, and blue twice.
- Then it displays the colors white, black, and red.
- Carefully inspect the screen for abnormalities (any lines, fuzzy color, or distortion on the screen).
- At the end of the last solid color (red), the computer shuts down.

**i** **NOTE:** Dell SupportAssist Preboot diagnostics upon launch initiates an LCD BIST first, expecting a user intervention to confirm functionality of the LCD.

# System-diagnostic lights

This section lists the system-diagnostic lights of your Precision 5690.

**Table 50. System-diagnostic lights**

Blinking pattern		Problem description	Suggested resolution
Amber	White		
1	1	TPM detection failure	Replace the system board.
1	2	Unrecoverable SPI Flash Failure	Replace the system board.
1	3	Short in hinge cable tripped OCP1	Check if the display cable (EDP) is seated properly or pinched at the hinges. If problem persists, replace either display cable (EDP) or display assembly (LCD).
1	4	Short in hinge cable tripped OCP2	Check if the display cable (EDP) is seated properly or pinched at the hinges. If problem persists, replace either display cable (EDP) or display assembly (LCD).
1	5	EC unable to program i-Fuse	Replace the system board.
1	6	Generic catch-all for ungraceful EC code flow errors	Disconnect all power source (AC, battery, coin cell) and drain flea power by pressing and holding down the power button for 3~5 seconds.
1	7	Unsupported SPI Flash	Replace the system board.
2	1	CPU failure	<ul style="list-style-type: none"> <li>Run the Dell SupportAssist or Dell Diagnostics tool.</li> <li>If the problem persists, replace the system board.</li> </ul>
2	2	System board failure (included BIOS corruption or ROM error)	<ul style="list-style-type: none"> <li>Flash latest BIOS version</li> <li>If the problem persists, replace the system board.</li> </ul>
2	3	No memory or RAM detected	<ul style="list-style-type: none"> <li>Confirm that the memory module is installed properly.</li> <li>If the problem persists, replace the memory module.</li> </ul>
2	4	Memory or RAM failure	<ul style="list-style-type: none"> <li>Reset and swap memory modules among the slots.</li> <li>If the problem persists, replace the memory module.</li> </ul>
2	5	Invalid memory installed	<ul style="list-style-type: none"> <li>Reset and swap memory modules among the slots.</li> </ul>

**Table 50. System-diagnostic lights (continued)**

Blinking pattern		Problem description	Suggested resolution
Amber	White		
			<ul style="list-style-type: none"> <li>If the problem persists, replace the memory module.</li> </ul>
2	6	System board or Chipset Error	Replace the system board.
2	7	LCD failure (SBIOS message)	Replace the LCD module.
2	8	LCD failure (EC detection of power rail failure)	Replace the system board.
3	1	CMOS battery failure	<ul style="list-style-type: none"> <li>Reset the main battery connection.</li> <li>If the problem persists, replace the main battery.</li> </ul>
3	2	PCI or Video card or chip failure	Replace the system board.
3	3	BIOS Recovery image not found	<ul style="list-style-type: none"> <li>Flash latest BIOS version</li> <li>If the problem persists, replace the system board.</li> </ul>
3	4	BIOS Recovery image found but invalid	<ul style="list-style-type: none"> <li>Flash latest BIOS version</li> <li>If the problem persists, replace the system board.</li> </ul>
3	5	Power rail failure	Replace the system board.
3	6	Flash corruption is detected by SBIOS.	<ul style="list-style-type: none"> <li>Press the power button for over 25 seconds to do RTC reset. If the problem persists, replace the system board.</li> <li>Disconnect all power source (AC, battery, coin cell) and drain flea power by pressing and holding down the power button 3~5 seconds to ensure all power are drained.</li> <li>Run "BIOS recovery from USB", and the instructions are in the website <a href="#">Dell support</a>.</li> <li>If the problem persists, replace the system board.</li> </ul>
3	7	Timeout waiting on ME to reply to HECI message.	Replace the system board.

**NOTE:** Blinking 3-3-3 LEDs on Lock LED (Caps-Lock or Num-Lock), Power button LED (without Fingerprint reader), and Diagnostic LED indicates failure to provide input during LCD panel test on Dell SupportAssist Pre-boot System Performance Check diagnostics.

# Recovering the operating system

When your computer is unable to boot to the operating system even after repeated attempts, it automatically starts Dell SupportAssist OS Recovery.

Dell SupportAssist OS Recovery is a stand-alone tool that is preinstalled in all Dell computers that are installed with the Windows operating system. It consists of tools to diagnose and troubleshoot issues that may occur before your computer boots to the operating system. It enables you to diagnose hardware issues, repair your computer, back up your files, or restore your computer to its factory state.

You can also download it from the Dell Support website to troubleshoot and fix your computer when it fails to boot into their primary operating system due to software or hardware failures.

For more information about the Dell SupportAssist OS Recovery, see *Dell SupportAssist OS Recovery User's Guide* at [www.dell.com/serviceabilitytools](http://www.dell.com/serviceabilitytools). Click **SupportAssist** and then, click **SupportAssist OS Recovery**.

## Real-Time Clock (RTC Reset)

The Real Time Clock (RTC) reset function allows you or the service technician to recover Dell computers from No POST/No Power/No Boot situations. The legacy jumper enabled RTC reset has been retired on these models.

Start the RTC reset with the computer powered off and connected to AC power. Press and hold the power button for thirty (30) seconds. The computer RTC Reset occurs after you release the power button.

## Backup media and recovery options

It is recommended to create a recovery drive to troubleshoot and fix problems that may occur with Windows. Dell proposes multiple options for recovering the Windows operating system on your Dell computer. For more information, see [Dell Windows Backup Media and Recovery Options](#).

## Wi-Fi power cycle

### About this task

If your computer is unable to access the Internet due to Wi-Fi connectivity issues a Wi-Fi power cycle procedure may be performed. The following procedure provides the instructions on how to conduct a Wi-Fi power cycle:

 **NOTE:** Some Internet Service Providers (ISPs) provide a modem or router combo device.

### Steps

1. Turn off your computer.
2. Turn off the modem.
3. Turn off the wireless router.
4. Wait for 30 seconds.
5. Turn on the wireless router.
6. Turn on the modem.
7. Turn on your computer.

## Drain residual flea power (perform hard reset)

### About this task

Flea power is the residual static electricity that remains in the computer even after it has been powered off and the battery is removed.

For your safety, and to protect the sensitive electronic components in your computer, you are requested to drain residual flea power before removing or replacing any components in your computer.

Draining residual flea power, also known as a performing a "hard reset", is also a common troubleshooting step if your computer does not turn on or boot into the operating system.

### **Procedure to drain residual flea power (perform a hard reset)**

#### **Steps**

1. Turn off your computer.
2. Disconnect the power adapter from your computer.
3. Remove the base cover.
4. Remove the battery.
5. Press and hold the power button for 20 seconds to drain the flea power.
6. Install the battery.
7. Install the base cover.
8. Connect the power adapter to your computer.
9. Turn on your computer.

 **NOTE:** For more information about performing a hard reset, search in the Knowledge Base Resource at [www.dell.com/support](http://www.dell.com/support).



# Getting help and contacting Dell

## Self-help resources

You can get information and help on Dell products and services using these self-help resources:

**Table 51. Self-help resources**

Self-help resources	Resource location
Information about Dell products and services	<a href="http://www.dell.com">www.dell.com</a>
Tips	
Contact Support	In Windows search, type <code>Contact Support</code> , and press Enter.
Online help for operating system	<a href="http://www.dell.com/support/windows">www.dell.com/support/windows</a> <a href="http://www.dell.com/support/linux">www.dell.com/support/linux</a>
Access top solutions, diagnostics, drivers and downloads, and learn more about your computer through videos, manuals, and documents.	Your Dell computer is uniquely identified by a Service Tag or Express Service Code. To view relevant support resources for your Dell computer, enter the Service Tag or Express Service Code at <a href="http://www.dell.com/support">www.dell.com/support</a> .  For more information about how to find the Service Tag for your computer, see <a href="#">Locate the Service Tag on your computer</a> .
Dell knowledge base articles	<ol style="list-style-type: none"> <li>1. Go to <a href="http://www.dell.com/support">www.dell.com/support</a>.</li> <li>2. On the menu bar at the top of the Support page, select <b>Support &gt; Knowledge Base</b>.</li> <li>3. In the Search field on the Knowledge Base page, type the keyword, topic, or model number, and then click or tap the search icon to view the related articles.</li> </ol>

## Contacting Dell

To contact Dell for sales, technical support, or customer service issues, see [www.dell.com/contactdell](http://www.dell.com/contactdell).

 **NOTE:** Availability varies by country/region and product, and some services may not be available in your country/region.

 **NOTE:** If you do not have an active Internet connection, you can find contact information about your purchase invoice, packing slip, bill, or Dell product catalog.