

S14NA-U12

ASUS

Motherboard

Copyright © 2023 ASUSTeK COMPUTER INC. All Rights Reserved.

No part of this manual, including the products and software described in it, may be reproduced, transmitted, transcribed, stored in a retrieval system, or translated into any language in any form or by any means, except documentation kept by the purchaser for backup purposes, without the express written permission of ASUSTeK COMPUTER INC. ("ASUS").

Product warranty or service will not be extended if: (1) the product is repaired, modified or altered, unless such repair, modification of alteration is authorized in writing by ASUS; or (2) the serial number of the product is defaced or missing.

ASUS PROVIDES THIS MANUAL "AS IS" WITHOUT WARRANTY OF ANY KIND, EITHER EXPRESS OR IMPLIED, INCLUDING BUT NOT LIMITED TO THE IMPLIED WARRANTIES OR CONDITIONS OF MERCHANTABILITY OR FITNESS FOR A PARTICULAR PURPOSE. IN NO EVENT SHALL ASUS, ITS DIRECTORS, OFFICERS, EMPLOYEES OR AGENTS BE LIABLE FOR ANY INDIRECT, SPECIAL, INCIDENTAL, OR CONSEQUENTIAL DAMAGES (INCLUDING DAMAGES FOR LOSS OF PROFITS, LOSS OF BUSINESS, LOSS OF USE OR DATA, INTERRUPTION OF BUSINESS AND THE LIKE), EVEN IF ASUS HAS BEEN ADVISED OF THE POSSIBILITY OF SUCH DAMAGES ARISING FROM ANY DEFECT OR ERROR IN THIS MANUAL OR PRODUCT.

SPECIFICATIONS AND INFORMATION CONTAINED IN THIS MANUAL ARE FURNISHED FOR INFORMATIONAL USE ONLY, AND ARE SUBJECT TO CHANGE AT ANY TIME WITHOUT NOTICE, AND SHOULD NOT BE CONSTRUED AS A COMMITMENT BY ASUS. ASUS ASSUMES NO RESPONSIBILITY OR LIABILITY FOR ANY ERRORS OR INACCURACIES THAT MAY APPEAR IN THIS MANUAL, INCLUDING THE PRODUCTS AND SOFTWARE DESCRIBED IN IT.

Products and corporate names appearing in this manual may or may not be registered trademarks or copyrights of their respective companies, and are used only for identification or explanation and to the owners' benefit, without intent to infringe.

Contents

Safety information.....	vi
Specifications summary.....	viii
Chapter 1: Product Introduction	
1.1 Welcome!	1-2
1.2 Package contents	1-2
1.3 Serial number label.....	1-2
Chapter 2: Hardware Information	
2.1 Before you proceed	2-2
2.2 Motherboard overview.....	2-3
2.2.1 Installing the motherboard.....	2-3
2.2.2 Motherboard layout.....	2-5
2.2.3 Layout contents.....	2-6
2.3 Central Processing Unit (CPU)	2-8
2.3.1 Installing the CPU and heatsink.....	2-8
2.4 System memory	2-13
2.4.1 Overview	2-13
2.4.2 Memory configurations.....	2-13
2.4.3 Installing a DIMM	2-14
2.4.4 Removing a DIMM	2-14
2.5 Expansion slots.....	2-15
2.5.1 Installing an expansion card.....	2-15
2.5.2 Configuring an expansion card	2-15
2.5.3 Interrupt assignments.....	2-16
2.5.4 PCI Express slots.....	2-17
2.5.5 Installing an M.2 module	2-18
2.6 Jumpers	2-19
2.7 Connectors	2-23
2.7.1 Rear panel connectors	2-23
2.7.2 Internal connectors.....	2-24
2.8 Onboard LEDs.....	2-30

Contents

Chapter 3: Powering Up

3.1	Starting up for the first time	3-2
3.2	Powering off the computer	3-3
3.2.1	Using the OS shut down function.....	3-3
3.2.2	Using the dual function power switch.....	3-3

Chapter 4: BIOS Setup

4.1	Managing and updating your BIOS	4-2
4.1.1	ASUS CrashFree BIOS 3 Utility.....	4-2
4.1.2	ASUS EZ Flash Utility.....	4-3
4.2	BIOS setup program	4-4
4.2.1	BIOS menu screen.....	4-5
4.2.2	Menu bar.....	4-5
4.3	Main menu	4-7
4.4	Advanced menu	4-8
4.4.1	Trusted Computing.....	4-8
4.4.2	Redfish Host Interface Settings.....	4-9
4.4.3	AMD CBS.....	4-10
4.4.4	Onboard LAN Configuration.....	4-18
4.4.5	UEFI Variables Protection.....	4-19
4.4.6	Serial Port Console Redirection.....	4-19
4.4.7	CPU Configuration.....	4-22
4.4.8	PCI Subsystem Settings.....	4-23
4.4.9	USB Configuration.....	4-24
4.4.10	Network Stack Configuration.....	4-25
4.4.11	NVMe Configuration.....	4-26
4.4.12	SATA Configuration.....	4-26
4.4.13	APM Configuration.....	4-27
4.4.14	AMD Mem Configuration Status.....	4-29
4.4.15	T1s Auth.....	4-29
4.4.16	Third-party UEFI driver configurations.....	4-30
4.4.17	Driver Health.....	4-30
4.5	Chipset menu	4-31
4.6	Security menu	4-32
4.7	Boot menu	4-34

Contents

4.8	Tool menu	4-35
4.9	Event Logs menu	4-36
4.9.1	Change Smbios Event Log Settings	4-36
4.9.2	View Smbios Event Log	4-36
4.10	Server Mgmt menu	4-37
4.10.1	System Event Log	4-38
4.10.2	View FRU Information	4-39
4.10.3	BMC self test log	4-39
4.10.4	BMC network configuration	4-40
4.10.5	BMC User Settings	4-41
4.10.6	View System Event Log	4-41
4.11	Exit menu	4-42

Chapter 5: Driver Installation

5.1	Running the Support DVD	5-2
------------	--------------------------------------	------------

Appendix

Block diagram	A-2
Q-Code table	A-3
Notices	A-11
Service and Support	A-15

Safety information

Electrical safety

- To prevent electrical shock hazard, disconnect the power cable from the electrical outlet before relocating the system.
- When adding or removing devices to or from the system, ensure that the power cables for the devices are unplugged before the signal cables are connected. If possible, disconnect all power cables from the existing system before you add a device.
- Before connecting or removing signal cables from the motherboard, ensure that all power cables are unplugged.
- Seek professional assistance before using an adapter or extension cord. These devices could interrupt the grounding circuit.
- Make sure that your power supply is set to the correct voltage in your area. If you are not sure about the voltage of the electrical outlet you are using, contact your local power company.
- If the power supply is broken, do not try to fix it by yourself. Contact a qualified service technician or your retailer.

Operation safety

- Before installing the motherboard and adding devices on it, carefully read all the manuals that came with the package.
- Before using the product, make sure all cables are correctly connected and the power cables are not damaged. If you detect any damage, contact your dealer immediately.
- To avoid short circuits, keep paper clips, screws, and staples away from connectors, slots, sockets and circuitry.
- Avoid dust, humidity, and temperature extremes. Do not place the product in any area where it may become wet.
- Place the product on a stable surface.
- If you encounter technical problems with the product, contact a qualified service technician or your retailer.

Conventions used in this guide

To ensure that you perform certain tasks properly, take note of the following symbols used throughout this manual.



DANGER/WARNING: Information to prevent injury to yourself when trying to complete a task.



CAUTION: Information to prevent damage to the components when trying to complete a task.



IMPORTANT: Instructions that you **MUST** follow to complete a task.



NOTE: Tips and additional information to help you complete a task.

Typography

Bold text

Indicates a menu or an item to select.

Italics

Used to emphasize a word or a phrase.

<Key>

Keys enclosed in the less-than and greater-than sign means that you must press the enclosed key.

Example: <Enter> means that you must press the Enter or Return key.

<Key1> + <Key2> + <Key3>

If you must press two or more keys simultaneously, the key names are linked with a plus sign (+).

Example: <Ctrl> + <Alt> +

Command

Means that you must type the command exactly as shown, then supply the required item or value enclosed in brackets.

Example: At the command prompt, type the command line:

format A: /S

Specifications summary

		S14NA-U12
Processor Support / System Bus		1 x Socket SP6 (LGA 4844) AMD EPYC™ 8004 Series (up to 225W)
Form Factor		CEB, 12" x 10.5"
Memory	Total Slots	12 (6 channels, 2 DIMM per channel)
	Capacity	Maximum up to 1152GB
	Memory Type	DDR5 4800/4000/3600 RDIMM * Refer to ASUS server AVL for the latest update
	Memory Size	96GB, 64GB, 48GB, 32GB, 24GB, 16GB * Refer to ASUS server AVL for the latest update
Expansion Slots (SSI location numbers)	Total PCI/PCI-E Slots	3
	Slot Location 1	PCIe x16 slot (Gen5 x16 link, FL) * Supports x16 to x4x4x4x4 (BIOS setting)
	Slot Location 2	-
	Slot Location 3	PCIe x16 slot (Gen5 x16 link, FL) * Supports x16 to x4x4x4x4 (BIOS setting)
	Slot Location 4	PCIe x8 slot (Gen5 x8 link, FL)
	Slot Location 5	-
	Slot Location 6	-
	Slot Location 7	-
Disk Controller	SATA/NVMe Controller	CPU integrated
Storage	M.2	1 x M.2 socket (Gen5x4, supports 22110, supports SATA mode)
		1 x M.2 socket (Gen5x4, supports 2280, supports SATA mode)
	MCIO	4 x MCIO connector (Gen5x8, supports 8 x NVMe drives) 1 x MCIO connector (Gen5x8, supports 8 x SATA drives or 2 x NVMe drives)
Networking	LAN	2 x SFP28 25Gb/s (Broadcom BCM57414B1KFSBG) 1 x 1GbE management LAN port
Graphic	VGA	Aspeed AST2600 64MB

(continued on the next page)

		S14NA-U12
Onboard I/O Connectors		1 x USB 3.2 Gen1 header (2 ports for front panel) 1 x USB 3.2 Gen1 port (1 port Type-A vertical) 1 x Serial port header 6 x Fan headers (4-pin) 1 x TPM header 1 x Chassis intrusion header (2-pin)
Rear I/O Connectors		2 x USB 3.2 Gen1 ports 1 x VGA port 2 x SFP28 25Gb/s ports 1 x RJ-45 1GbE management LAN port
Management Solution	Software	ASUS Control Center
	Out of Band Remote Management	ASMB11-iKVM module for KVM-over-IP
Environment		Operating temperature: 10°C ~ 35°C Non-operating temperature: -40°C ~ 70°C Non-operating humidity: 20% ~ 90% (Non-condensing)



Specifications are subject to change without notice.

Product Introduction

1

This chapter describes the motherboard features and the new technologies it supports.

1.1 Welcome!

Thank you for buying an ASUS® S14NA-U12 motherboard!

The motherboard delivers a host of new features and latest technologies, making it another standout in the long line of quality ASUS motherboards!

Before you start installing the motherboard and hardware devices on it, check the items in your package with the list below.

1.2 Package contents

Check your motherboard package for the following items.

Items		Standard Gift Box Pack	Standard Bulk Pack
I/O shield		1	1
Cables	COM port cable	1	-
Accessories	M.2 screw	1	1
Packaging Qty.		1 pc per carton	10 pcs per carton



If any of the above items is damaged or missing, contact your retailer.

1.3 Serial number label

Before requesting support from the ASUS Technical Support team, you must take note of the motherboard's serial number containing 12 characters **xxSxxxxxxxxx** shown as the figure below. With the correct serial number of the product, ASUS Technical Support team members can then offer a quicker and satisfying solution to your problems.



Hardware Information

2

This chapter lists the hardware setup procedures that you have to perform when installing system components. It includes description of the jumpers and connectors on the motherboard.

2.1 Before you proceed

Take note of the following precautions before you install motherboard components or change any motherboard settings.



- Unplug the power cord from the wall socket before touching any component.
 - Use a grounded wrist strap or touch a safely grounded object or a metal object, such as the power supply case, before handling components to avoid damaging them due to static electricity.
 - Hold components by the edges to avoid touching the ICs on them.
 - Whenever you uninstall any component, place it on a grounded antistatic pad or in the bag that came with the component.
 - Before you install or remove any component, ensure that the power supply is switched off or the power cord is detached from the power supply. Failure to do so may cause severe damage to the motherboard, peripherals, and/or components.
-

2.2 Motherboard overview

Before you install the motherboard, study the configuration of your chassis to ensure that the motherboard fits into it.

To optimize the motherboard features, we highly recommend that you install it in a CEB compliant chassis.



Ensure to unplug the chassis power cord before installing or removing the motherboard. Failure to do so can cause you physical injury and damage motherboard components!

2.2.1 Installing the motherboard

1. Before installing the motherboard, ensure that standoff screws of at least 6 mm are installed on the chassis.
2. Affix the rubber spacers to the rear side of the motherboard as shown below:



The rubber spacers are included in the accessory box.

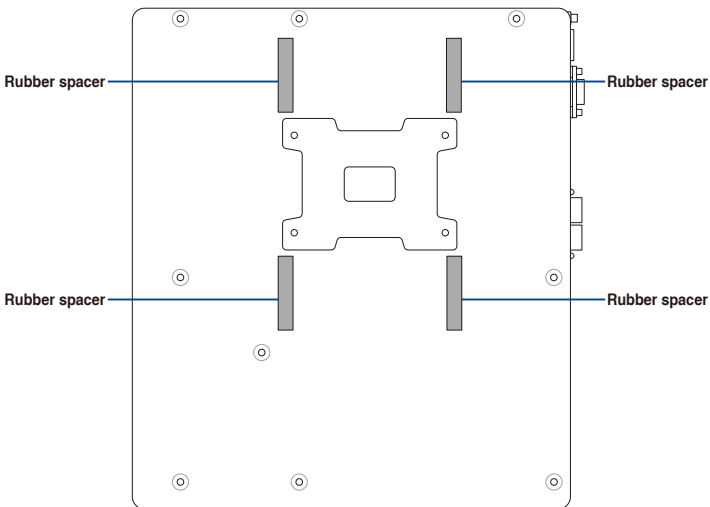

3. Place the motherboard into the chassis with the external ports facing the rear of the chassis, then secure the motherboard using the indicated screw holes.



DO NOT overtighten the screws! Doing so can damage the motherboard.

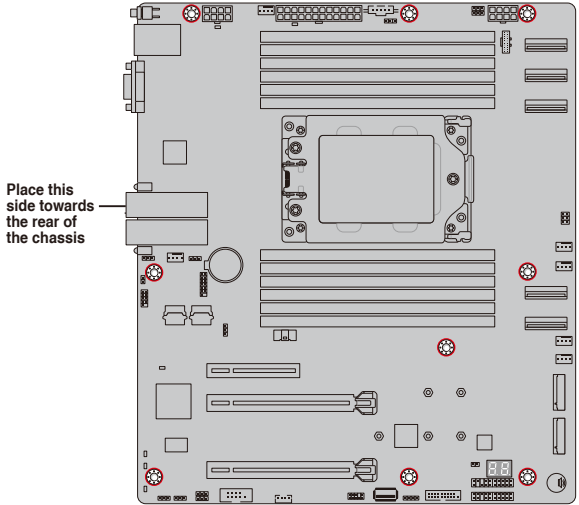

2.2.2 Motherboard layout

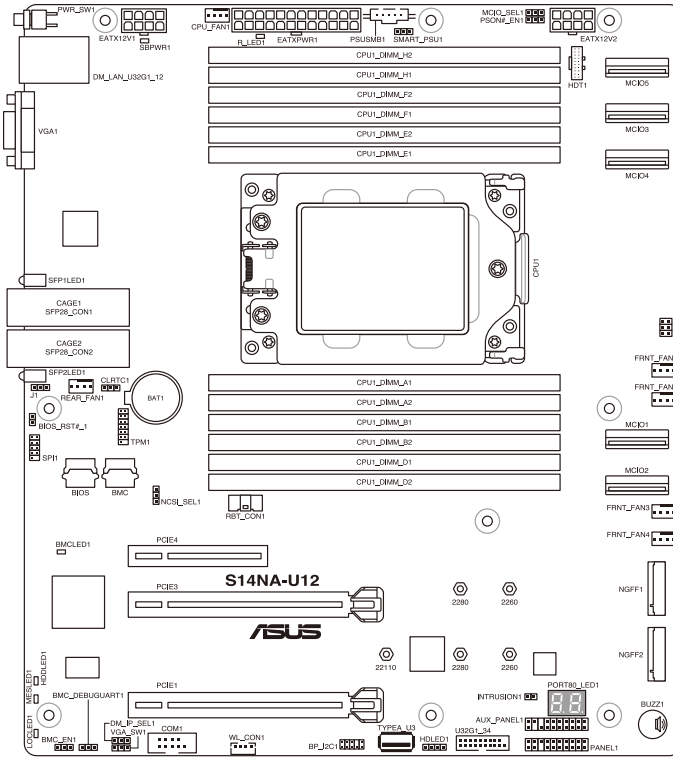

2.2.3 Layout contents

Slots/Sockets		Page
1.	CPU socket	2-8
2.	DIMM sockets	2-13
3.	PCIe slots	2-17
4.	M.2 connectors	2-18

Jumpers		Page
1.	Clear RTC RAM (3-pin CLRTC1)	2-19
2.	VGA controller setting (3-pin VGA_SW1)	2-20
3.	Baseboard Management Controller setting (3-pin BMC_EN1)	2-20
4.	DMLAN setting (3-pin DM_IP_SEL1)	2-21
5.	Smart Ride Through (SmaRT) setting (3-pin SMART_PSU1)	2-21
6.	NCSI setting (3-pin NCSI_SEL1)	2-22
7.	MCIO setting (3-pin MCIO_SEL1)	2-22

Rear panel connectors		Page
1.	Power button	2-23
2.	Dedicated Management LAN port (DM_LAN1)	2-23
3.	VGA port	2-23
4.	SFP28 ports	2-23
5.	USB 3.2 Gen 1 ports	2-23

Internal connectors		Page
1.	MCIO connectors (MCIO1-5)	2-24
2.	Hard disk activity LED connector (4-pin HDLED1)	2-24
3.	Serial port connector (10-1 pin COM1)	2-25
4.	Chassis intrusion connector (2-pin INTRUSION)	2-25
5.	Fan connectors (4-pin CPU_FAN1, FRNT_FAN1-4, REAR_FAN1)	2-26
6.	USB 3.2 Gen 2 connector (20-1 pin USB3_34)	2-26
7.	ATX power connectors (24-pin EATXPWR1, 8-pin EATX12V1-2)	2-27
8.	System panel connector (20-1 pin PANEL1)	2-28
9.	Auxiliary panel connector (20-2 pin AUX_PANEL1)	2-29

Onboard LEDs		Page
1.	Standby Power LED (SBPWR1)	2-30
2.	Baseboard Management Controller LED (BMCLED1)	2-30
3.	ATX power missing LED (R_LED1)	2-31
4.	Message LED (MESLED1)	2-31
5.	Location LED (LOCLED1)	2-32
6.	Hard disk activity LED (HDDLED1)	2-32
7.	Q-Code LED (PORT80_LED1)	2-33

2.3 Central Processing Unit (CPU)

The motherboard comes with a surface mount SP6 LGA4844 socket designed for the AMD EPYC™ 8004 series processors (up to 225W).



- Upon purchase of the motherboard, ensure that the PnP cap is on the socket and the socket contacts are not bent. Contact your retailer immediately if the PnP cap is missing, or if you see any damage to the PnP cap/socket contacts/motherboard components. ASUS will bear the cost of repair only if the damage is shipment/transit-related.
- Keep the cap after installing the motherboard. ASUS will process Return Merchandise Authorization (RMA) requests only if the motherboard comes with the PnP cap on the socket.
- The product warranty does not cover damage to the socket contacts resulting from incorrect CPU installation/removal, or misplacement/loss/incorrect removal of the PnP cap.

2.3.1 Installing the CPU and heatsink

To install the CPU:

1. Locate the CPU socket on the motherboard.

S14NA-U12 CPU SP6 Socket

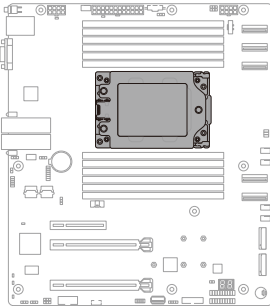

CPU1

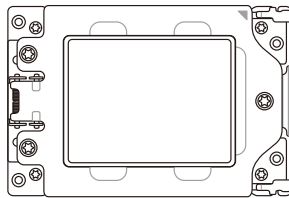

- Loosen the screws in the order shown below, then lift the load plate.



A T20 screwdriver with a torque value of 13.8 ± 1.3 kgf-cm (12.0 ± 1.2 lbf-in) is recommended.

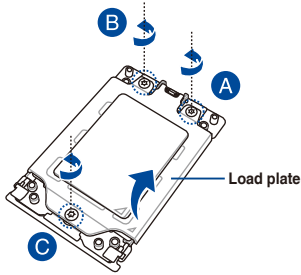

- Pull the tabs on both sides of the rail frame to release the rail frame.

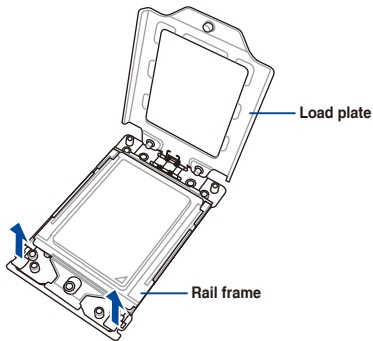

- Slide the external cap out of the rail frame.

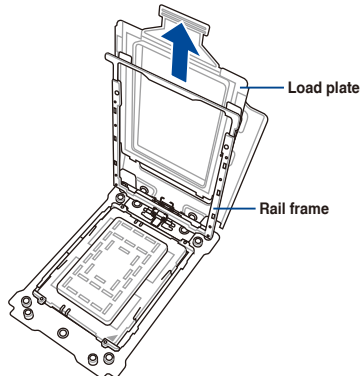

5. Slide the carrier frame with CPU into the rail frame, then remove the PnP cap.



The carrier frame with CPU fits in only one correct orientation. DO NOT force the carrier frame with CPU into the rail frame.

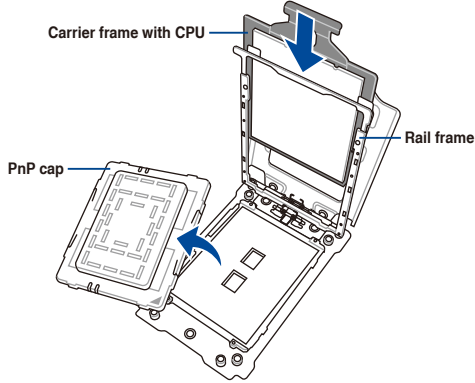

6. Gently press down on the rail frame until it latches to the socket housing, then press down on the load plate.

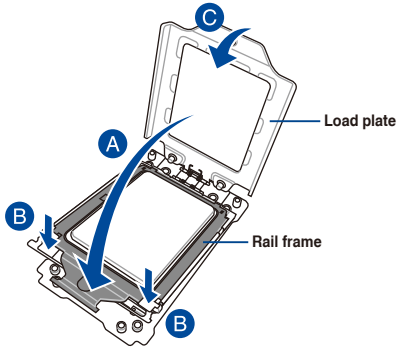

- Partially tighten the screws in the order shown below just enough to close the load plate. When all the screws are partially tightened, fully tighten the screws one by one in the same order to fully secure the load plate. When the load plate is secured, apply the thermal interface material to the CPU.



A T20 screwdriver with a torque value of 13.8 ± 1.3 kgf-cm (12.0 ± 1.2 lbf-in) is recommended.

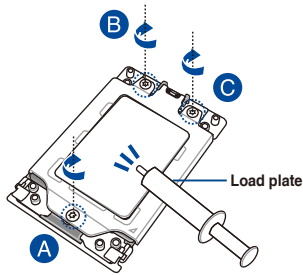

- Place the heatsink on the CPU socket and make sure the heatsink screws are aligned with the CPU socket.

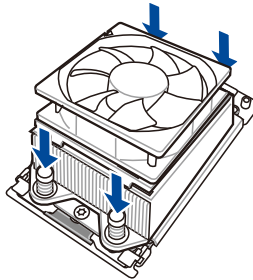

9. Partially tighten the screws in the order shown below just enough to attach the heatsink to the motherboard. When all the screws are partially tightened, tighten them one by one in the same order to completely secure the heatsink.



- A T20 screwdriver with a torque value of 13.8 ± 1.3 kgf-cm (12.0 ± 1.2 lbf-in) is recommended.
- To remove the heatsink, loosen the screws in the reverse order.

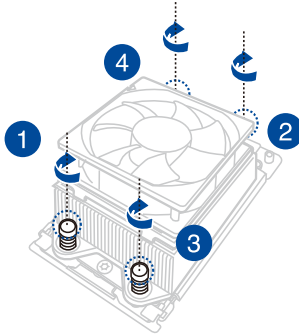

10. Connect the CPU fan cable to the connector on the motherboard labeled CPU_FAN1.

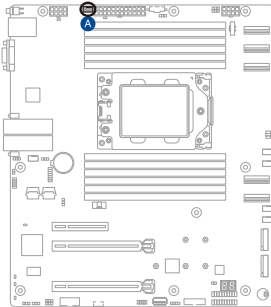

A CPU_FAN1

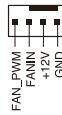

2.4 System memory

2.4.1 Overview

The motherboard comes with twelve Double Data Rate 5 (DDR5) Dual Inline Memory Modules (DIMM) sockets.

The figure illustrates the location of the DDR5 DIMM sockets:

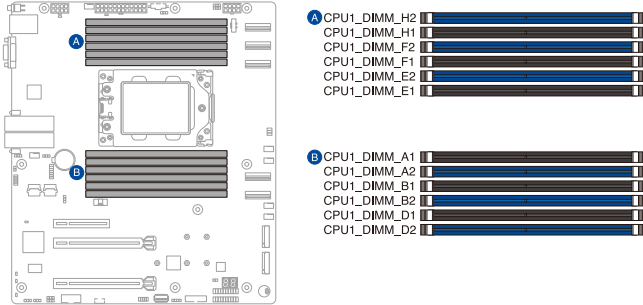

2.4.2 Memory configurations

This section provides recommended memory configurations for reference when installing DIMMs.



- Refer to ASUS Server AVL for the updated list of compatible DIMMs.
- Always install DIMMs with the same CAS latency. For optimum compatibility, it is recommended that you obtain memory modules from the same vendor.

Recommended configuration													
	A1	A2	B1	B2	D1	D2	E1	E2	F1	F2	H1	H2	NUMA support
1 channel/1 DIMM		•											NPS1
1 channel/2 DIMMs	•	•											NPS1
2 channels/2 DIMMs		•						•					NPS1/2
2 channels/4 DIMMs	•	•					•	•					NPS1/2
4 channels/4 DIMMs		•				•		•				•	NPS1/2/4
4 channels/8 DIMMs	•	•			•	•	•	•			•	•	NPS1/2/4
6 channels/6 DIMMs		•		•		•		•		•		•	NPS1/2
6 channels/12 DIMMs	•	•	•	•	•	•	•	•	•	•	•	•	NPS1/2

2.4.3 Installing a DIMM



Ensure to unplug the power supply before adding or removing DIMMs or other system components. Failure to do so may cause severe damage to both the motherboard and the components.

1. Unlock a DIMM socket by pressing the retaining clips outward.
2. Align a DIMM on the socket such that the notch on the DIMM matches the DIMM slot key on the socket.

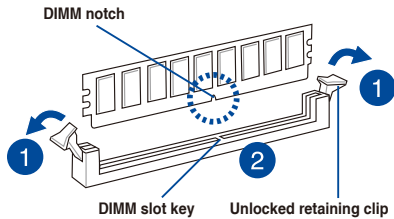

A DIMM is keyed with a notch so that it fits in only one direction. **DO NOT** force a DIMM into a socket in the wrong direction to avoid damaging the DIMM.

3. Hold the DIMM by both of its ends then insert the DIMM vertically into the socket. Apply force to both ends of the DIMM simultaneously until the retaining clips snaps back into place.

Ensure that the DIMM is sitting firmly on the DIMM slot.

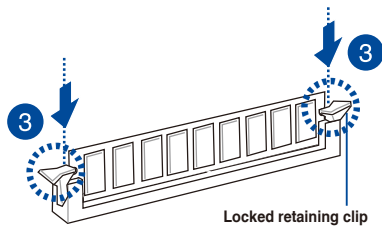

Always insert the DIMM into the socket **VERTICALLY** to prevent DIMM notch damage.

2.4.4 Removing a DIMM

1. Simultaneously press the retaining clips outward to unlock the DIMM.
2. Remove the DIMM from the socket.

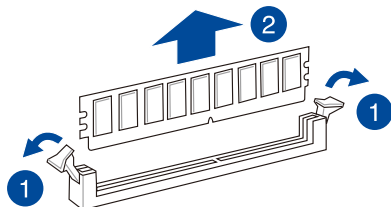

Support the DIMM lightly with your fingers when pressing the retaining clips. The DIMM might get damaged when it flips out with extra force.

2.5 Expansion slots

The following subsections describe the slots and the expansion cards that they support.



Ensure to unplug the power cord before adding or removing expansion cards. Failure to do so may cause you physical injury and damage motherboard components.

2.5.1 Installing an expansion card

To install an expansion card:

1. Before installing the expansion card, read the documentation that came with it and make the necessary hardware settings for the card.
2. Remove the bracket opposite the slot that you intend to use. Keep the screw for later use.
3. Align the card connector with the slot and press firmly until the card is completely seated on the slot.
4. Secure the card to the chassis with the screw you removed earlier.

2.5.2 Configuring an expansion card

After installing the expansion card, configure it by adjusting the software settings.

1. Turn on the system and change the necessary BIOS settings, if any. Refer to the **BIOS Setup** chapter for information on BIOS setup.
2. Assign an IRQ to the card. Refer to the tables on the next page.
3. Install the software drivers for the expansion card.



When using PCI cards on shared slots, ensure that the drivers support “Share IRQ” or that the cards do not need IRQ assignments. Otherwise, conflicts will arise between the two PCI groups, making the system unstable and the card inoperable.

2.5.3 Interrupt assignments

Standard Interrupt assignments

IRQ	Priority	Standard function
0	1	System Timer
1	2	Keyboard Controller
2	-	Programmable Interrupt
3*	11	Communications Port (COM2)
4*	12	Communications Port (COM1)
5*	13	--
6	14	Floppy Disk Controller
7*	15	--
8	3	System CMOS/Real Time Clock
9*	4	ACPI Mode when used
10*	5	IRQ Holder for PCI Steering
11*	6	IRQ Holder for PCI Steering
12*	7	PS/2 Compatible Mouse Port
13	8	Numeric Data Processor
14*	9	Primary IDE Channel
15*	10	Secondary IDE Channel

* These IRQs are usually available for ISA or PCI devices.

2.5.4 PCI Express slots

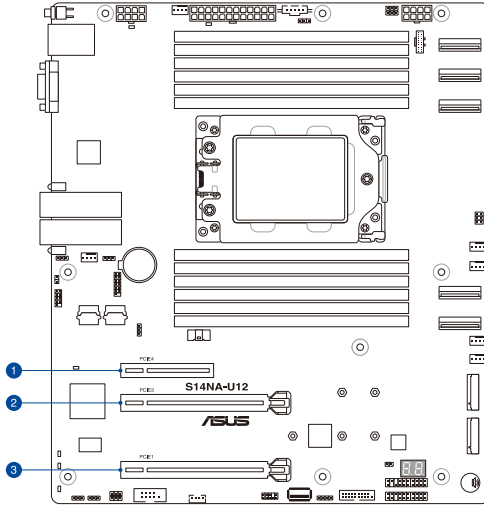

No. (Slot Location)	Short Description	
1 (Slot 4)	PCIe4	PCIe x8 slot (Gen5 x8 link, FL)
2 (Slot 3)	PCIe3	PCIe x16 slot (Gen5 x16 link, FL)
3 (Slot 1)	PCIe1	PCIe x16 slot (Gen5 x16 link, FL)

2.5.5 Installing an M.2 module



- M.2 socket 1 (NGFF1) supports M.2 modules up to 2280 and M.2 socket 2 (NGFF2) supports M.2 modules up to 22110.
- M.2 modules are sold separately.
- The motherboard illustration is for reference only. The motherboard layout and appearance may vary depending on the model, but the installation steps remain the same.

1. Locate the M.2 sockets (NGFF1-2) on the motherboard.

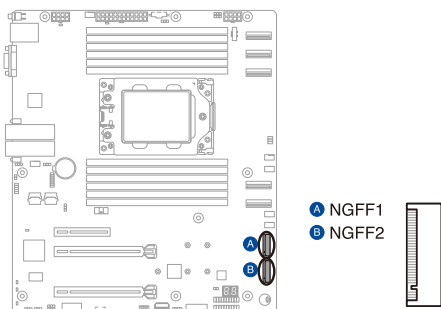

2. Install the stand screw into the hole corresponding to the M.2 module.
3. Align and insert the M.2 module into the M.2 socket.
4. Secure the M.2 module with the bundled M.2 screw.

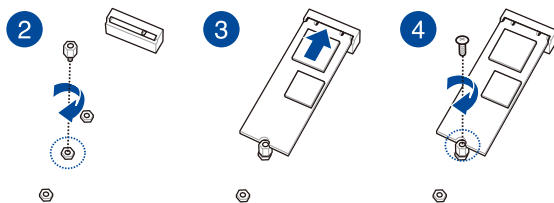

2.6 Jumpers



The motherboard illustration is for reference only. The motherboard layout and appearance may vary depending on the model, but the locations for these jumpers/LEDs/connectors remain the same.

1. Clear RTC RAM (3-pin CLRRTC1)

This jumper allows you to clear the Real Time Clock (RTC) RAM in CMOS. You can clear the CMOS memory of date, time, and system setup parameters by erasing the CMOS RTC RAM data. The onboard button cell battery powers the RAM data in CMOS, which include system setup information such as system passwords.

To erase the RTC RAM:

1. Turn OFF the computer and unplug the power cord.
2. Move the jumper cap from pins 1–2 (default) to pins 2–3. Keep the cap on pins 2–3 for about 5–10 seconds, then move the cap back to pins 1–2.
3. Plug in the power cord and turn ON the computer.
4. Hold down the key during the boot process and enter BIOS setup to re-enter data.



Except when clearing the RTC RAM, never remove the cap on CLRRTC jumper default position. Removing the cap will cause system boot failure!



If the steps above do not help, remove the onboard battery and move the jumper again to clear the CMOS RTC RAM data. After the CMOS clearance, reinstall the battery.

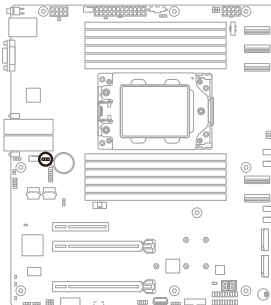

CLRRTC1

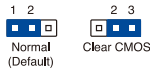

2. VGA controller setting (3-pin VGA_SW1)

This jumper allows you to enable or disable the onboard VGA controller. Set to pins 1-2 to activate the VGA feature.

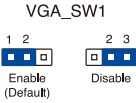
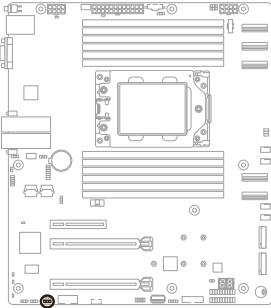

3. Baseboard Management Controller setting (3-pin BMC_EN1)

This jumper allows you to enable (default) or disable on-board BMC. Ensure to set this BMC jumper to enabled to avoid system fan control and hardware monitor error.

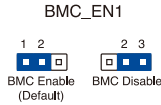
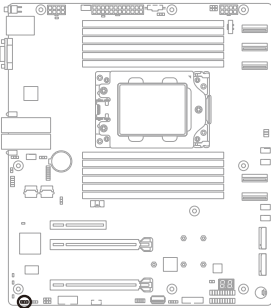

4. DMLAN setting (3-pin DM_IP_SEL1)

This jumper allows you to select the DMLAN setting. Set to pins 2-3 to force the DMLAN IP to static mode (IP=10.10.10.10, submask=255.255.255.0).

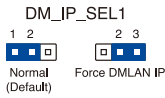
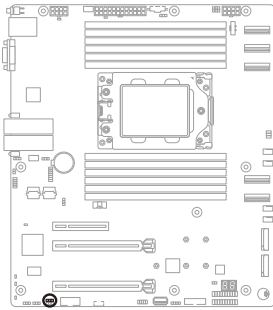

5. Smart Ride Through (SmaRT) setting (3-pin SMART_PSU1)

This jumper allows you to enable or disable the Smart Ride Through (SmaRT) function. This feature is enabled by default. Set to pins 2-3 to disable it. When enabled, SmaRT allows uninterrupted operation of the system during an AC loss event.

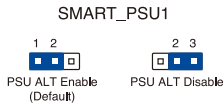
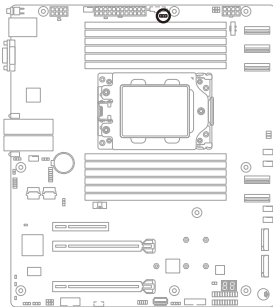

6. NCSI setting (3-pin NCSI_SEL1)

This jumper allows you to select the NCSI device. Set to pins 1-2 for BMC WebUI Control or pins 2-3 for RBT.



BMC shared LAN is disabled by default.

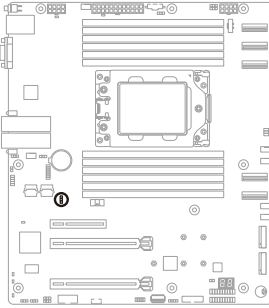

7. MCIO setting (3-pin MCIO_SEL1)

This jumper allows you to select the mode for MCIO5. Set to pins 1-2 for auto mode (default), or 2-3 for SATA mode.

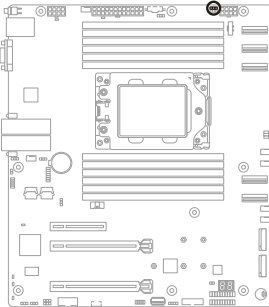

2.7 Connectors

2.7.1 Rear panel connectors

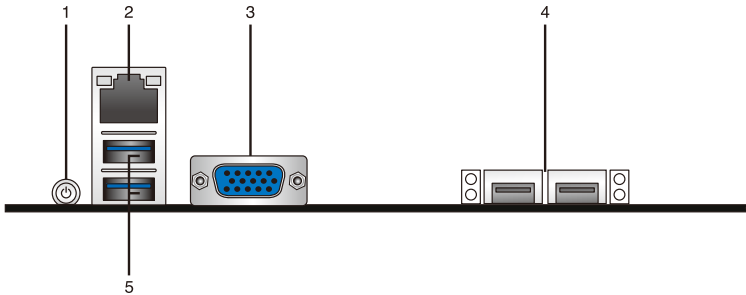

1. **Power Button:** Press this button to turn the system on or off.
2. **Dedicated Management LAN port (DM_LAN1):** This RJ-45 port functions only when you enable the ASMB11 Management card.
3. **VGA port:** This port is for a VGA monitor or other VGA-compatible devices.
4. **SFP28 ports:** These ports allow gigabit connections to a Local Area Network (LAN) through a network hub.
5. **USB 3.2 Gen 1 ports:** These two USB ports are available for connecting USB devices.

Dedicated Management LAN port (DM_LAN1) LED indications

Activity/Link LED		Speed LED	
Status	Description	Status	Description
OFF	No link	OFF	10 Mbps connection
YELLOW	Linked	ORANGE	100 Mbps connection
BLINKING	Data activity	GREEN	1 Gbps connection

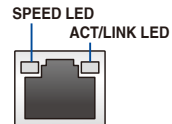

SFP28 25Gb/s port LED indications

Activity/Link LED		Speed LED	
Status	Description	Status	Description
OFF	No link	OFF	<1 Gbps connection
GREEN	Linked	ORANGE	10 Gbps connection
BLINKING	Data activity	GREEN	25 Gbps connection

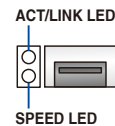

2.7.2 Internal connectors

1. MCIO connectors (MCIO1-5)

Connects the PCIe signal to MCIO ports.

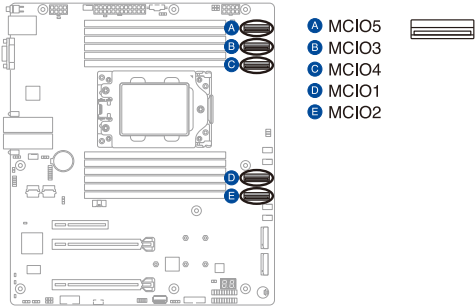

2. Hard disk activity LED connector (4-pin HDLED1)

This LED connector is for the storage add-on card cable connected to the SATA/SAS add-on card. The connected LED will light up during read or write activities of any storage device connected to the SATA/SAS add-on card.

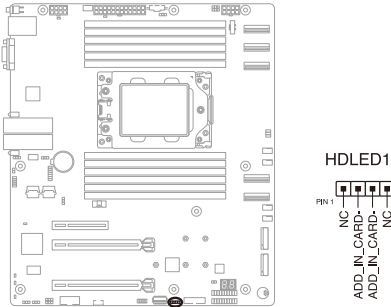

3. Serial port connector (10-1 pin COM1)

These connectors are for the serial (COM) ports. Connect the serial port module cable to the connector, then install the module to a slot opening at the back of the system chassis.

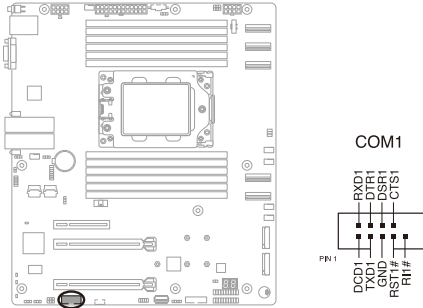

4. Chassis intrusion connector (2-pin INTRUSION)

This connector is for a chassis-mounted intrusion detection sensor or switch. Connect one end of the chassis intrusion sensor or switch cable to this connector. The chassis intrusion sensor or switch sends a high-level signal to this connector when a chassis component is removed or replaced. The signal is then generated as a chassis intrusion event.

By default, the pin labeled “Chassis Signal” and “Ground” are shorted with a jumper cap. Remove the jumper caps only when you intend to use the chassis intrusion detection feature.

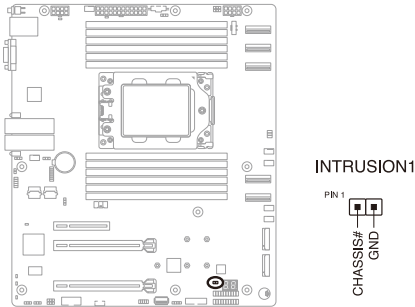

5. Fan connectors (4-pin CPU_FAN1, FRNT_FAN1-4, REAR_FAN1)

The fan connectors support cooling fans. Connect the fan cables to the fan connectors on the motherboard, ensuring that the black wire of each cable matches the ground pin of the connector.



- DO NOT forget to connect the fan cables to the fan connectors. Insufficient air flow inside the system may damage the motherboard components.
- These are not jumpers! DO NOT place jumper caps on the fan connectors!
- All fans feature the ASUS Smart Fan technology.

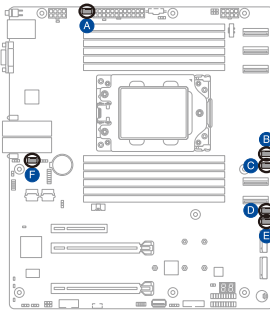

- A CPU_FAN1
- B FRNT_FAN1
- C FRNT_FAN2
- D FRNT_FAN3
- E FRNT_FAN4
- F REAR_FAN1



6. USB 3.2 Gen 2 connector (20-pin USB3_34)

This connector allows you to connect a USB 3.2 Gen 2 module for additional USB 3.2 Gen 2 front or rear panel ports. The USB 3.2 Gen 2 connector provides data transfer speeds of up to 10 Gb/s.

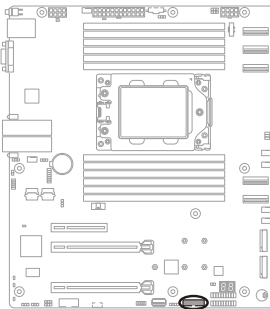

U32G1_34

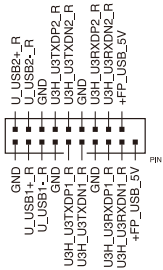

7. ATX power connectors (24-pin EATXPWR1, 8-pin EATX12V1-2)

These connectors are for the ATX power supply plugs. The power supply plugs are designed to fit these connectors in only one orientation. Find the proper orientation and push down firmly until the connectors completely fit.



- DO NOT forget to connect the 24-pin and the 8-pin power plugs; otherwise, the system will not boot up.
- Use of a power supply unit (PSU) with a higher power output is recommended when configuring a system with more power-consuming devices. The system may become unstable or may not boot up if the power is inadequate.
- This motherboard supports ATX2.0 PSU or later version.
- Ensure that your PSU can provide at least the minimum power required by your system.

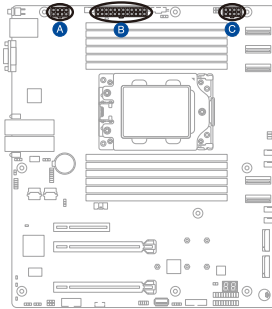

A EATX12V1

C EATX12V2

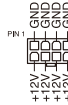

B EATXPWR1

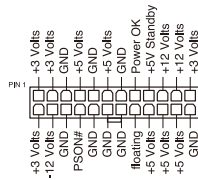

8. System panel connector (20-1 pin PANEL1)

This connector supports several chassis-mounted functions.

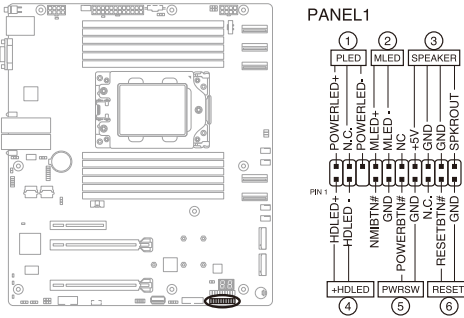

- **System power LED (3-pin PLED)**

This 3-pin connector is for the system power LED. Connect the chassis power LED cable to this connector. The system power LED lights up when you turn on the system power, and blinks when the system is in sleep mode.

- **Message LED (2-pin MLED)**

This 2-pin connector is for the message LED cable that connects to the front message LED. The message LED is controlled by Hardware monitor to indicate an abnormal event occurrence.

- **System warning speaker (4-pin SPEAKER)**

This 4-pin connector is for the chassis-mounted system warning speaker. The speaker allows you to hear system beeps and warnings.

- **Hard disk drive activity LED (2-pin +HLED)**

This 2-pin connector is for the HDD Activity LED. Connect the HDD Activity LED cable to this connector. The IDE LED lights up or flashes when data is read from or written to the HDD.

- **Power button/soft-off button (2-pin PWRSW)**

This connector is for the system power button. Pressing the power button turns the system on or puts the system in sleep or soft-off mode depending on the BIOS settings. Pressing the power switch for more than four (4) seconds while the system is ON turns the system OFF.

- **Reset button (2-pin RESET)**

This 2-pin connector is for the chassis-mounted reset button for system reboot without turning off the system power.

9. Auxiliary panel connector (20-2 pin AUX_PANEL1)

These connectors are for additional front panel features.

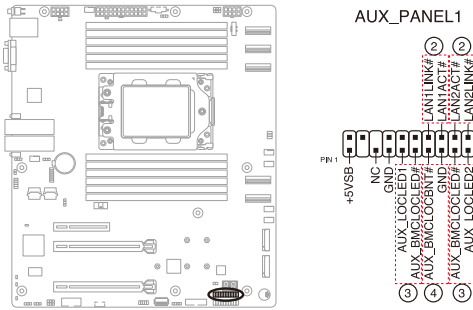

- **LAN activity LED (2-pin LAN1LINK, LAN1ACT, LAN2LINK, LAN2ACT)**

These 2-pin connectors are for the Gigabit LAN activity LEDs on the front panel.

- **Locator LED (2-pin AUX_LOCLEED1-2)**

These 2-pin connectors are for the locator LEDs on the front panel. Connect the Locator LED cables to these 2-pin connector. The LEDs will light up when the Locator button is pressed.

- **Locator Button/Switch (2-pin AUX_BMCCLOBNT)**

This 2-pin connector is for the locator button on the front panel. This button queries the state of the system locator.

2.8 Onboard LEDs



The motherboard illustration is for reference only. The motherboard layout and appearance may vary depending on the model, but the locations for these jumpers/LEDs/connectors remain the same.

1. Standby Power LED (SBPWR1)

The motherboard comes with a standby power LED. The green LED lights up to indicate that the system is ON, in sleep mode, or in soft-off mode. This is a reminder that you should shut down the system and unplug the power cable before removing or plugging in any motherboard components. The illustration below shows the location of the onboard LED.

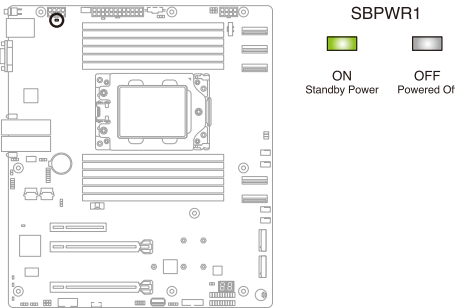

2. Baseboard Management Controller LED (BMCLED1)

The BMC LED will blink continuously when the BMC is operating normally.

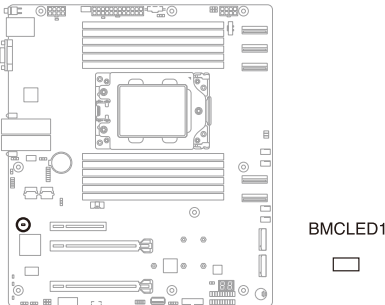

3. ATX power missing LED (R_LED1)

The ATX power missing LED will light up if an ATX power connector is not connected.

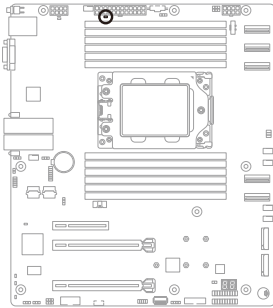

R_LED1



4. Message LED (MESLED1)

This message LED will light up when there is a temperature warning or when a BMC event log is generated.

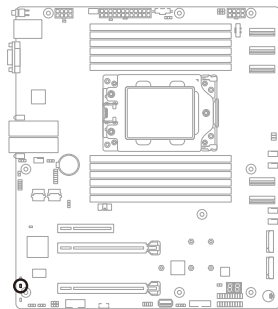

MESLED1



5. Location LED (LOCLED1)

This onboard LED lights up when the Location button on the server is pressed or when triggered by a system management software. The Location LED helps visually locate and quickly identify the server on a server rack.

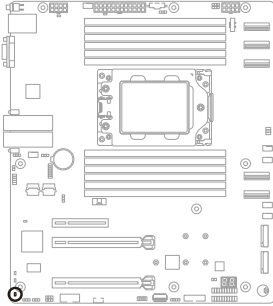

LOCLED1

6. Hard Disk Activity LED (HDDLED1)

This LED will light up during read or write activities of any storage device.

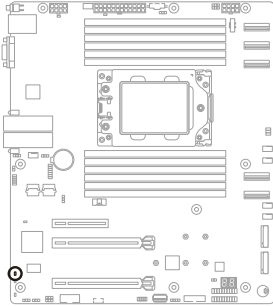

HDDLED1

7. Q-Code LEDs (PORT80_LED1)

The Q-Code LED provides you with a 2-digit error code that displays the system status.



Refer to the **Q-Code Table** section of the appendix for a list of Q-Code error codes.

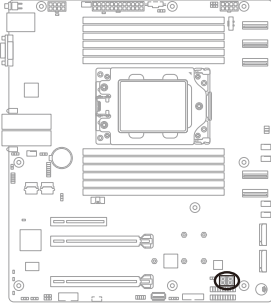

PORT80_LED1



Powering Up

3

This chapter describes the power up sequence, and ways of shutting down the system.

3.1 Starting up for the first time

1. After making all the connections, replace the system case cover.
2. Make sure that all switches are off.
3. Connect the power cord to the power connector at the back of the system chassis.
4. Connect the power cord to a power outlet that is equipped with a surge protector.
5. Turn on the devices in the following order:
 - a. Monitor
 - b. External storage devices (starting with the last device on the chain)
 - c. System power
6. After applying power, the system power LED on the system front panel case lights up. For systems with ATX power supplies, the system LED lights up when you press the ATX power button. If your monitor complies with “green” standards or if it has a “power standby” feature, the monitor LED may light up or switch between orange and green after the system LED turns on.

The system then runs the power-on self-test or POST. While the tests are running, the BIOS beeps or additional messages appear on the screen. If you do not see anything within 30 seconds from the time you turned on the power, the system may have failed a power-on test. Check the jumper settings and connections or call your retailer for assistance.

The following shows the possible beep codes and its corresponding error condition

BIOS Beep codes	
Beep	Error condition
1 short	No Keyboard Detected.
1 short, 8 short	No VGA Detected.
2 long	Chassis Intrusion.
2 long	BIOS-image Crash Detected.

7. At power on, hold down the key to enter the BIOS Setup. Refer to the **BIOS Setup** chapter for more information.

3.2 Powering off the computer

3.2.1 Using the OS shut down function

Using Windows® Server 2019:

1. Press <Ctrl>+<Alt>+.
2. Click on the Power icon on the lower right side of the screen.
3. Select **Shut down**.
4. In the Shutdown Event Tracker, select the **Other (Planned)** option in the selection lists. Otherwise, select the option that best describes why you want to shut down the computer.
5. Click **Continue**.

3.2.2 Using the dual function power switch

While the system is ON, press the power switch for less than four seconds to put the system to sleep mode or to soft-off mode, depending on the BIOS setting.



Pressing the power switch for more than four seconds lets the system enter the soft-off mode regardless of the BIOS setting.

BIOS Setup

4

This chapter tells how to change the system settings through the BIOS Setup menus. Detailed descriptions of the BIOS parameters are also provided.

4.1 Managing and updating your BIOS

The following utilities allow you to manage and update the motherboard Basic Input/Output System (BIOS) setup:

1. **ASUS CrashFree BIOS 3**

To recover the BIOS using a bootable USB flash disk drive if the BIOS file fails or gets corrupted.

2. **ASUS EzFlash**

Updates the BIOS using a USB flash disk.

Refer to the corresponding sections for details on these utilities.

4.1.1 **ASUS CrashFree BIOS 3 Utility**

The ASUS CrashFree BIOS 3 is an auto recovery tool that allows you to restore the BIOS file if it fails or gets corrupted during the updating process. You can update a corrupted BIOS file using a USB flash drive that contains the updated BIOS file.



Prepare a USB flash drive containing the updated motherboard BIOS before using this utility.

Recovering the BIOS from a USB flash drive

To recover the BIOS from a USB flash drive:

1. Insert the USB flash drive with the original or updated BIOS file to one USB port on the system.
2. The utility will automatically recover the BIOS. It resets the system when the BIOS recovery finished.



DO NOT shut down or reset the system while recovering the BIOS! Doing so would cause system boot failure!



The recovered BIOS may not be the latest BIOS version for this motherboard. Visit the ASUS website at www.asus.com to download the latest BIOS file.

4.1.2 ASUS EZ Flash Utility

The ASUS EZ Flash Utility feature allows you to update the BIOS without having to use a DOS-based utility.



Before you start using this utility, download the latest BIOS from the ASUS website at www.asus.com.

To update the BIOS using EZ Flash Utility:

1. Insert the USB flash disk that contains the latest BIOS file into the USB port.
2. Enter the BIOS setup program. Go to the **Tool** menu, then select **Start ASUS EZ Flash**. Press <Enter>.

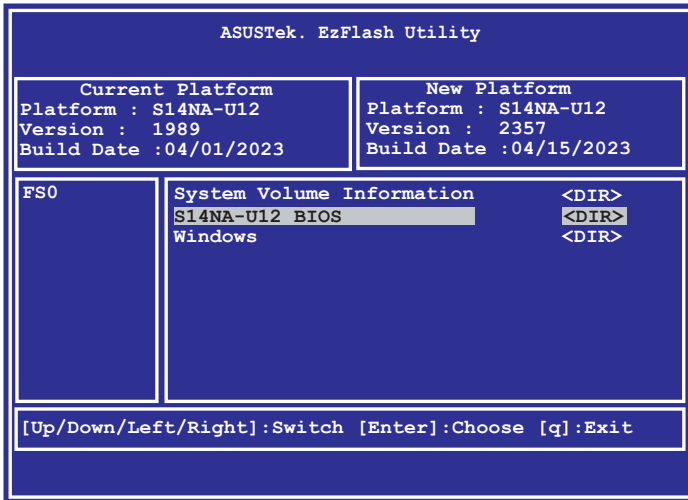

3. Press the Left/Right arrow keys to switch to the **Drive** field.
4. Press the Up/Down arrow keys to find the USB flash disk that contains the latest BIOS, then press <Enter>.
5. Press Left/Right arrow keys to switch to the **Folder Info** field.
6. Press the Up/Down arrow keys to find the BIOS file, then press <Enter> to perform the BIOS update process. Reboot the system when the update process is done.



- This function can support devices such as a USB flash disk with FAT 32/16 format and single partition only.
- DO NOT shut down or reset the system while updating the BIOS to prevent system boot failure!



Ensure to load the BIOS default settings to ensure system compatibility and stability. Press <F5> and select **Yes** to load the BIOS default settings.

4.2 BIOS setup program

This motherboard supports a programmable firmware chip that you can update using the provided utility described in the **Managing and updating your BIOS** section.

Use the BIOS Setup program when you are installing a motherboard, reconfiguring your system, or prompted to “Run Setup.” This section explains how to configure your system using this utility.

Even if you are not prompted to use the Setup program, you can change the configuration of your computer in the future. For example, you can enable the security password feature or change the power management settings. This requires you to reconfigure your system using the BIOS Setup program so that the computer can recognize these changes and record them in the CMOS RAM of the firmware chip.

The firmware chip on the motherboard stores the Setup utility. When you start up the computer, the system provides you with the opportunity to run this program. Press during the Power-On Self-Test (POST) to enter the Setup utility; otherwise, POST continues with its test routines.

If you wish to enter Setup after POST, restart the system by pressing <Ctrl>+<Alt>+<Delete>, or by pressing the reset button on the system chassis. You can also restart by turning the system off and then back on. Do this last option only if the first two failed.

The Setup program is designed to make it as easy to use as possible. Being a menu-driven program, it lets you scroll through the various sub-menus and make your selections from the available options using the navigation keys.



-
- The default BIOS settings for this motherboard apply for most conditions to ensure optimum performance. If the system becomes unstable after changing any BIOS settings, load the default settings to ensure system compatibility and stability. Press <F5> and select **Yes** to load the BIOS default settings.
 - The BIOS setup screens shown in this section are for reference purposes only, and may not exactly match what you see on your screen.
 - Visit the ASUS website (www.asus.com) to download the latest BIOS file for this motherboard.
-

4.2.1 BIOS menu screen

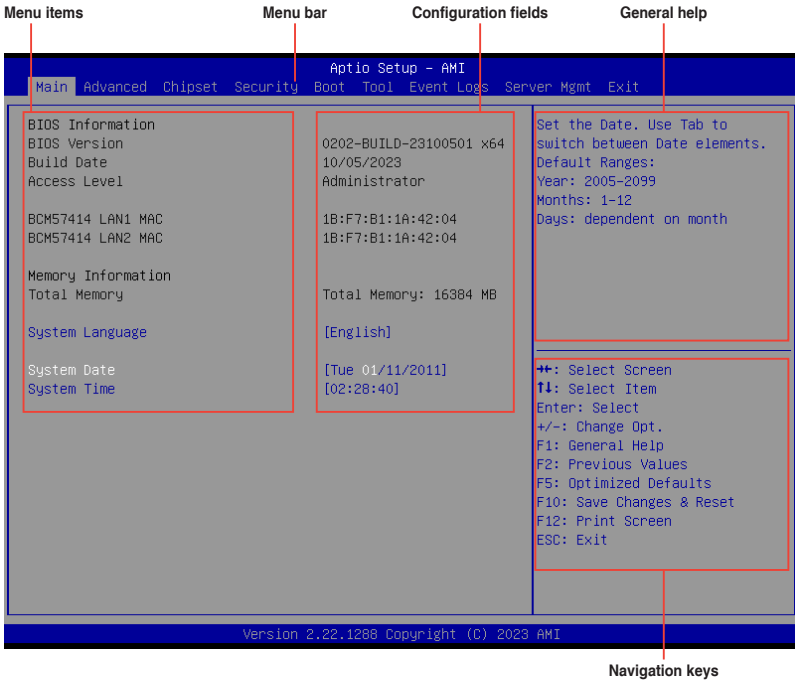

4.2.2 Menu bar

The menu bar on top of the screen has the following main items:

- Main** For changing the basic system configuration
- Advanced** For changing the advanced system settings
- Chipset** For changing the chipset settings
- Security** For changing the security settings
- Boot** For changing the system boot configuration
- Tool** For configuring options for special functions
- Event Logs** For changing the event log settings
- Server Mgmt** For changing the Server Mgmt settings
- Exit** For selecting the exit options

To select an item on the menu bar, press the right or left arrow key on the keyboard until the desired item is highlighted.

Menu items

The highlighted item on the menu bar displays the specific items for that menu. For example, selecting **Main** shows the Main menu items.

The other items (such as **Advanced**) on the menu bar have their respective menu items.

Submenu items

A solid triangle before each item on any menu screen means that the item has a submenu. To display the submenu, select the item then press <Enter>.

Navigation keys

At the bottom right corner of a menu screen are the navigation keys for the BIOS setup program. Use the navigation keys to select items in the menu and change the settings.

General help

At the top right corner of the menu screen is a brief description of the selected item.

Configuration fields

These fields show the values for the menu items. If an item is user-configurable, you can change the value of the field opposite the item. You cannot select an item that is not user-configurable.

A configurable field is enclosed in brackets, and is highlighted when selected. To change the value of a field, select it and press <Enter> to display a list of options.

Pop-up window

Select a menu item and press <Enter> to display a pop-up window with the configuration options for that item.

Scroll bar

A scroll bar appears on the right side of a menu screen when there are items that do not fit on the screen. Press the Up/Down arrow keys or <Page Up> / <Page Down> keys to display the other items on the screen.

4.3 Main menu

When you enter the BIOS Setup program, the Main menu screen appears. The Main menu provides you an overview of the basic system information, and allows you to set the system date, time, and language settings.

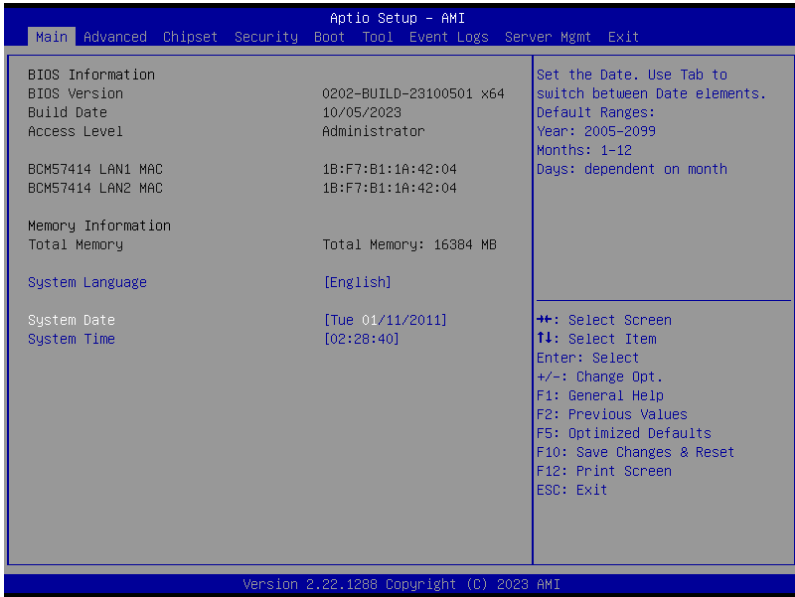

System Language

Allows you to set the system language.

System Date [MM/DD/YYYY]

Allows you to set the system date.

System Time [HH:MM:SS]

Allows you to set the system time.

4.4 Advanced menu

The Advanced menu items allow you to change the settings for the CPU and other system devices.



Take caution when changing the settings of the Advanced menu items. Incorrect field values can cause the system to malfunction.

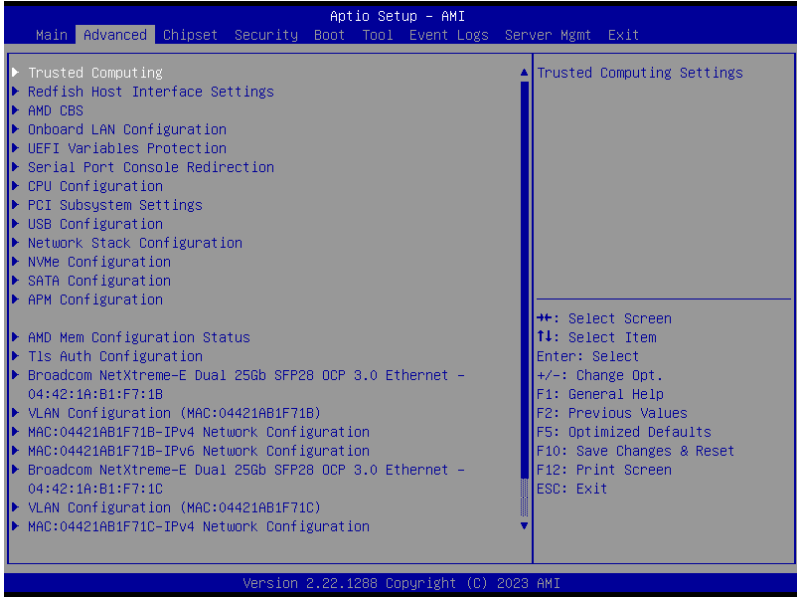

4.4.1 Trusted Computing



Security Device Support [Disabled]

Allows you to enable or disable the BIOS support for security device.
Configuration options: [Disabled] [Enabled]

4.4.2 Redfish Host Interface Settings

Advanced		Aptio Setup - AMI	
Redfish Host Interface Settings		Enable/Disable AMI Redfish	
Redfish	[Enabled]		
BMC Redfish Version	1.11.0		
BIOS Redfish Version	1.11.0		

Redfish [Enabled]

Allows you to enable or disable AMI Redfish.

Configuration options: [Disabled] [Enabled]



The following items appear only when **Redfish** is set to **[Enabled]**.

Authentication Mode [Basic Authentication]

Configuration options: [Basic Authentication] [Session Authentication]

IP Address

Allows you to set the IP address

IP Mask Address

Allows you to set the IP mask address

IP Port

Allows you to set the IP port

4.4.3 AMD CBS

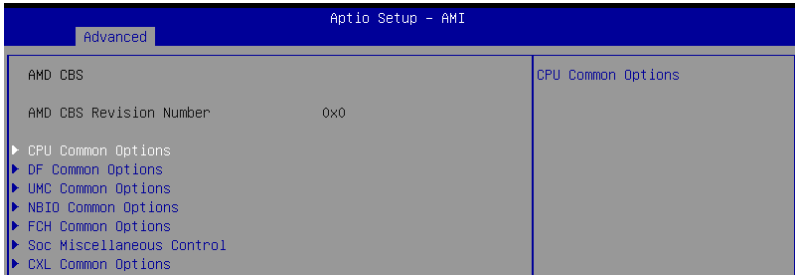

CPU Common Options

Performance

Allows you to configure performance options.

REP-MOV/STOS Streaming [Enabled]

Allows you to enable or disable the use of non-caching streaming stores for large sizes.

Configuration options: [Disabled] [Enabled]

Prefetcher Settings

Allows you to configure prefetcher options.

Core Watchdog

Allows you to configure core watchdog options.

RedirectForReturnDis [Auto]

Allows you to set RedirectForReturnDis to 0, 1, or Auto as a workaround for GCC/C000005 issue for XV Core on CZ A0.

Configuration options: [Auto] [1] [0]

Platform First Error Handling [Auto]

Allows you to enable or disable PFEH, cloak individual banks, and mask deferred error interrupts from each bank.

Configuration options: [Disabled] [Enabled] [Auto]

Core Performance Boost [Auto]

Configuration options: [Disabled] [Auto]

Global C-State Control [Auto]

Configuration options: [Disabled] [Enabled] [Auto]

Power Supply Idle Control [Auto]

Configuration options: [Low Current Idle] [Typical Current Idle] [Auto]

SEV-ES ASID Space Limit [1]

Allows you to set the SEV-ES ASID Space Limit.

SEV Control [Enabled]

Configuration options: [Disabled] [Enabled]

Streaming Stores Control [Auto]

Configuration options: [Disabled] [Enabled] [Auto]

Local APIC Mode [Auto]

Configuration options: [Compatibility] [xAPIC] [x2APIC] [Auto]

ACPI _CST C1 Declaration [Auto]

Configuration options: [Disabled] [Enabled] [Auto]

ACPI CST C2 Latency [800]

Allows you to set the C2 latency value in microseconds.

MCA Error Threshold Enable [Auto]

Configuration options: [False] [True] [Auto]

MCA FruText [True]

Configuration options: [False] [True]

SMU and PSP Debug Mode [Auto]

If this option is enabled, uncorrected errors detected by the PSP FW or SMU FW will hang and not reset the system instead of causing a cold reset.

Configuration options: [Disabled] [Enabled] [Auto]

PPIN Opt-in [Auto]

Configuration options: [Disabled] [Enabled] [Auto]

SNP Memory (RMP Table) Coverage [Auto]

Configuration options: [Disabled] [Enabled] [Custom] [Auto]



The following item appears only when **SNP Memory (RMP Table) Coverage** is set to **[Custom]**.

Amount of Memory to Cover [2000]

Allows you to set the amount of system memory (MB) to be covered in hex.

SMEE [Auto]

Configuration options: [Disabled] [Enabled] [Auto]

Action on BIST Failure [Auto]

Allows you to configure what action is taken when a CCD BIST failure is detected.

Configuration options: [Do nothing] [Down-CCD] [Auto]

Fast Short REP MOVSB (FSRM) [Auto]

Configuration options: [Disabled] [Enabled] [Auto]

Enhanced Short REP MOVSB/STOSB (ESRM) [Auto]

Configuration options: [Disabled] [Enabled] [Auto]

Log Transparent Errors [Auto]

Configuration options: [Disabled] [Enabled] [Auto]

AVX512 [Auto]

Configuration options: [Disabled] [Enabled] [Auto]

MONITOR and MWAIT Disable [Auto]

When this option is enabled, MONITOR, MWAIT, MONITORX, and MWAITX opcodes become invalid.

Configuration options: [Disabled] [Enabled] [Auto]

Small Hammer Configuration [Auto]

Configuration options: [Disabled] [Enabled] [Auto]

Corrector Branch Predictor [Disabled]

Configuration options: [Disabled] [Enabled]

PAUSE Delay [Auto]

Configuration options: [Auto] [Disabled] [16 cycles] [32 cycles] [64 cycles] [128 cycles]

CPU Speculative Store Modes [Auto]

Configuration options: [Balanced] [More Speculative] [Less Speculative] [Auto]

Prefetch/Request Throttle [Auto]

Configuration options: [Disabled] [Enabled] [Auto]

DF Common Options

Memory Addressing

Allows you to configure memory addressing options.

ACPI

Allows you to configure ACPI options.

Link

Allows you to configure Link options.

SDCI

Allows you to configure SDCI options.

Probe Filter

Allows you to configure Probe Filter options.

DF Watchdog Timer Interval [Auto]

Configuration options: [Auto] [41ms] [166ms] [334ms] [669ms] [1.34 seconds] [2.68 seconds] [5.36 seconds]

Disable DF to external IP Sync Flood Propagation [Auto]

Configuration options: [Sync flood disabled] [Sync flood enabled] [Auto]

Sync Flood Propagation to DF Components [Auto]

Configuration options: [Sync flood disabled] [Sync flood enabled] [Auto]

Freeze DF Module Queues on Error [Auto]

Configuration options: [Disabled] [Enabled] [Auto]

CC6 Memory Region Encryption [Auto]

Configuration options: [Disabled] [Enabled] [Auto]

CCD B/W Balance Throttle Level [Auto]

Configuration options: [Auto] [Level 0] [Level 1] [Level 2] [Level 3] [Level 4]

Number of PCI Segments [Auto]

Configuration options: [Auto] [1 Segment] [2 Segments] [4 Segments]

UMC Common Options

DDR Addressing Options

Allows you to configure DDR addressing options.

DDR Controller Configuration

Allows you to configure DDR controller options.

DDR MBIST Options

Allows you to configure DDR MBIST options.

DDR RAS

Allows you to configure DDR RAS options.

DDR Bus Configuration

Allows you to configure DDR Bus options.

DDR Timing Configuration

Allows you to configure DDR Timing options.

DDR Training Options

Allows you to configure DDR Training options.

DDR Security

Allows you to configure DDR Security options.

DDR PMIC Configuration

Allows you to configure DDR PMIC options.

DDR Miscellaneous

Allows you to configure DDR Miscellaneous options.

DDR PHY (CMN)

Allows you to configure DDR PHY (CMN) options.

NBIO Common Options

IOMMU [Auto]

Configuration options: [Disabled] [Enabled] [Auto]

DMAr Support [Auto]

Configuration options: [Disabled] [Enabled] [Auto]

DMA Protection [Auto]

Configuration options: [Disabled] [Enabled] [Auto]

DRTM Virtual Device Support [Auto]

Configuration options: [Disabled] [Enabled] [Auto]

DRTM Memory Reservation [Auto]

Allows you to enable or disable reservation of 128MB memory below Bottom IO for DRTM. This option is required for Secured-Core Server functionality.

Configuration options: [Disabled] [Enabled] [Auto]

ACS Enable [Auto]

Configuration options: [Disabled] [Enabled] [Auto]

PCIe ARI Support [Auto]

Configuration options: [Disabled] [Enabled] [Auto]

PCIe ARI Enumeration [Auto]

Configuration options: [Disabled] [Enabled] [Auto]

PCIe Ten Bit Tag Support [Auto]

Allows you to enable PCIe ten bit tags for supported devices. Support is disabled if this option is enabled.

Configuration options: [Disabled] [Enabled] [Auto]

SMU Common Options

Allows you to configure SMU Common options.

NBIO RAS Common Options

Allows you to configure NBIO RAS Common options.

Enable AER Cap [Auto]

Configuration options: [Disabled] [Enabled] [Auto]

Early Link Speed [Auto]

Configuration options: [Gen1] [Gen2] [Auto]

Hot Plug Handling Mode [Auto]

Configuration options: [OS First] [Firmware First/EDR If OS Supports] [Firmware First But Allow OS First] [System Firmware Intermediary] [Auto]

Hot Plug Allow FF in Synchronous [Disabled]

Configuration options: [Disabled] [Enabled]

Presence Detect Select Mode [Auto]

Configuration options: [OR] [AND] [In-Band Only] [Out-Of-Band Only] [Auto]

Data Link Feature Cap [Auto]

Configuration options: [Disabled] [Enabled] [Auto]

CV Test [Auto]

Allows you to enable or disable support for PCIECV tool. Hardware defaults are preserved if this option is set to Auto.

Configuration options: [Disabled] [Enabled] [Auto]

SEV-SNP Support [Disabled]

Configuration options: [Disabled] [Enabled] [Auto]

Allow Compliance [Auto]

Allows you to enable or disable PCIe RP entering the polling compliance state.

Configuration options: [Disabled] [Enabled] [Auto]

SRIS [Auto]

Configuration options: [Disabled] [Enabled] [Auto]

Multi Upstream Auto Speed Change [Auto]

Configuration options: [Disabled] [Enabled] [Auto]

Multi Auto Speed Change on Last Rate [Auto]

Configuration options: [Disabled] [Enabled] [Auto]

PCIe Link Speed Capability [Gen5]

Configuration options: [Maximum speed] [Gen1] [Gen2] [Gen3] [Gen4] [Gen5] [Auto]

RTM Margining Support [Auto]

Configuration options: [Disabled] [Enabled] [Auto]

EQ Bypass To Highest Rate [Auto]

Configuration options: [Disabled] [Enabled] [Auto]

Non-PCIe Compliant Support [Auto]

Configuration options: [Disabled] [Enabled] [Auto]

PCIe Idle Power Setting [Optimize for Perf/Power]

Configuration options: [Optimize for Latency] [Optimize for Perf/Power]

nBif Common Options

Allows you to configure nBif Common options.

Link EQ Preset Options

Allows you to configure Link EQ Preset options.

Enable 2 SPC (Gen 4) [Auto]

Configuration options: [Auto] [Enable]

FCH Common Options**I3C/I2C Configuration Options**

Allows you to configure I3C/I2C options.

SATA Configuration Options

Allows you to configure SATA options.

USB Configuration Options

Allows you to configure USB options.

AC Power Loss Options

Allows you to configure AC power loss options.

UART Configuration Options

Allows you to configure UART options.

ESPI Configuration Options

Allows you to configure ESPI options.

FCH RAS Options

Allows you to configure FCH RAS options.

Miscellaneous Options

Allows you to configure miscellaneous options.

SOC Miscellaneous Control

ABL Console Out Control [Auto]

Configuration options: [Disabled] [Enabled] [Auto]



The following items appear only when **ABL Console Out Control** is set to **[Enabled]**.

ABL Console Out Serial Port [Auto]

Configuration options: [eSPI UART] [SOC UART0] [SOC UART1] [Auto]



The following item is only available when **ABL Console Out Serial Port** is set to **[eSPI UART]**.

ABL Console Out Serial Port IO [Auto]

Configuration options: [0x3F8] [0x2F8] [0x3E8] [0x2E8] [Auto]

ABL Basic Console Out Control [Auto]

Configuration options: [Disabled] [Enabled] [Auto]

ABL PMU Message Control [Auto]

Allows you to control the number of PMU debug messages.

Configuration options: [Detailed debug messages] [Coarse debug messages] [Stage completion] [Assertion messages] [Firmware completion messages only] [Auto]

ABL Memory Population Message Control [Warning Message]

Configuration options: [Warning Message] [Fatal Error]

PSP Error Injection Support [False]

Configuration options: [False] [True]

Firmware Anti-rollback (FAR)

Allows you to configure Firmware Anti-Rollback (FAR) options.

CXL Common Options

CXL Control [Auto]

Configuration options: [Disabled] [Enabled] [Auto]

CXL SPM [Auto]

Configuration options: [Disabled] [Enabled] [Auto]

CXL Encryption [Disabled]

Configuration options: [Disabled] [Enabled]

CXL DVSEC Lock [Auto]

Configuration options: [Disabled] [Enabled] [Auto]

Temp Gen5 Advertisement [Auto]

Configuration options: [Disabled] [Enabled] [Auto]

Sync Header Bypass [Auto]

Configuration options: [Disabled] [Enabled] [Auto]

CXL RAS

Allows you to configure CXL RAS options.

4.4.4 Onboard LAN Configuration

Advanced		Aptio Setup - AMI	
Onboard BCM57414 LAN Configuration		Onboard LAN Enable/Disable	
BCM57414 LAN1			
LAN Enable	[Enabled]		
LAN MAC	1B:F7:B1:1A:42:04		
BCM57414 LAN2			
LAN Enable	[Enabled]		
LAN MAC	1B:F7:B1:1A:42:04		

Onboard BCM57414 LAN Configuration

BCM57414 LAN1/LAN2

LAN Enable [Enabled]

Configuration options: [Disabled] [Enabled]

4.4.5 UEFI Variables Protection

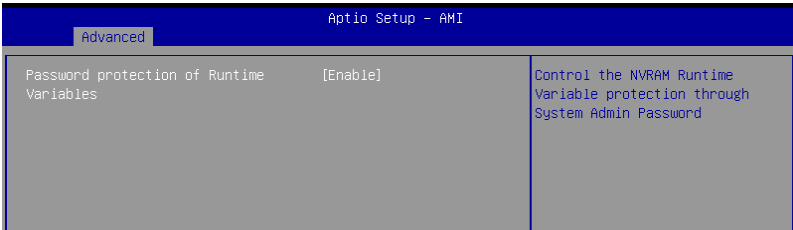

Password protection of Runtime Variables [Enabled]

This item allows you enable or disable NVRAM Runtime Variable Protection.
Configuration options: [Disabled] [Enable]

4.4.6 Serial Port Console Redirection

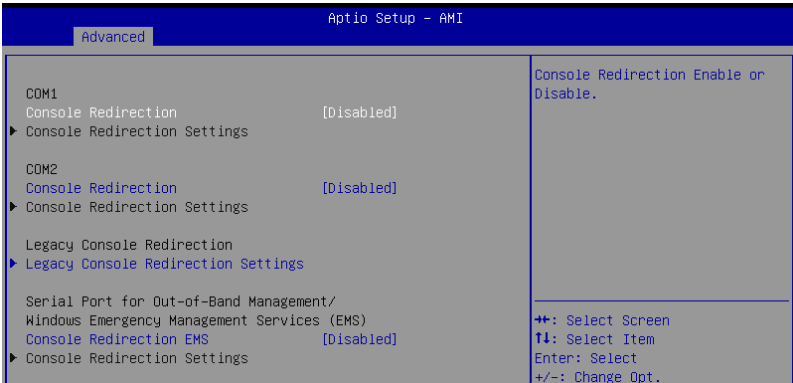

COM1/COM2

Console Redirection [Disabled]

Allows you to enable or disable the console redirection feature.
Configuration options: [Disabled] [Enabled]



The following items appear only when **Console Redirection** is set to **[Enabled]**.

Terminal Type [ANSI]

Allows you to set the terminal type.

[VT100] ASCII char set.

[VT100Plus] Extends VT100 to support color, function keys, etc.

[VT-UTF8] Uses UTF8 encoding to map Unicode chars onto 1 or more bytes.

[ANSI] Extended ASCII char set.

Bits per second [115200]

Selects serial port transmission speed. The speed must be matched on the other side. Long or noisy lines may require lower speeds.

Configuration options: [9600] [19200] [38400] [57600] [115200]

Data Bits [8]

Configuration options: [7] [8]

Parity [None]

A parity bit can be sent with the data bits to detect some transmission errors. [Mark] and [Space] parity do not allow for error detection.

[None] None

[Even] parity bit is 0 if the num of 1's in the data bits is even

[Odd] parity bit is 0 if num of 1's in the data bits is odd

[Mark] parity bit is always 1

[Space] parity bit is always 0

Stop Bits [1]

Stop bits indicate the end of a serial data packet. (A start bit indicates the beginning.) The standard setting is 1 stop bit. Communication with slow devices may require more than 1 stop bit.

Configuration options: [1] [2]

Flow Control [None]

Flow control can prevent data loss from buffer overflow. When sending data, if the receiving buffers are full, a "stop" signal can be sent to stop the data flow. Once the buffers are empty, a "start" signal can be sent to re-start the flow. Hardware flow control uses two wires to send start/stop signals.

Configuration options: [None] [Hardware RTS/CTS]

VT-UTF8 Combo Key Support [Enabled]

This allows you to enable the VT-UTF8 Combination Key Support for ANSI/VT100 terminals.

Configuration options: [Disabled] [Enabled]

Recorder Mode [Disabled]

With this mode enabled only text will be sent. This is to capture Terminal data.

Configuration options: [Disabled] [Enabled]

Resolution 100x31 [Enabled]

This allows you to set the number of rows and columns supported on the Legacy OS.

Configuration options: [Disabled] [Enabled]

Putty Keypad [VT100]

This allows you to select the FunctionKey and Keypad on Putty.

Configuration options: [VT100] [LINUX] [XTERMR6] [SCO] [ESCN] [VT400]

Legacy Console Redirection Settings

Redirection COM Port [COM1]

Configuration options: [COM1] [COM2]

Resolution [80x24]

Configuration options: [80x24] [80x25]

Redirect After POST [Always Enable]

Configuration options: [Always Enable] [BootLoader]

Serial Port for Out-of-Band Management/Windows Emergency Management Services (EMS)

Console Redirection EMS [Disabled]

Allows you to enable or disable the console redirection feature.

Configuration options: [Disabled] [Enabled]



The following items appear only when **Console Redirection EMS** is set to **[Enabled]**.

Console Redirection Settings

Out-of-Band Mgmt Port [COM1]

Microsoft Windows Emergency Management Services (EMS) allow for remote management of a Windows Server OS through a serial port.

Configuration options: [COM1] [COM2]

Terminal Type EMS [VT-UTF8]

Microsoft Windows Emergency Management Services (EMS) allow for remote management of a Windows Server OS through a serial port.

Configuration options: [VT100] [VT100Plus] [VT-UTF8] [ANSI]

Bits per second EMS [115200]

Microsoft Windows Emergency Management Services (EMS) allow for remote management of a Windows Server OS through a serial port.

Configuration options: [9600] [19200] [57600] [115200]

Flow Control EMS [None]

Microsoft Windows Emergency Management Services (EMS) allow for remote management of a Windows Server OS through a serial port.

Configuration options: [None] [Hardware RTS/CTS] [Software Xon/Xoff]

4.4.7 CPU Configuration

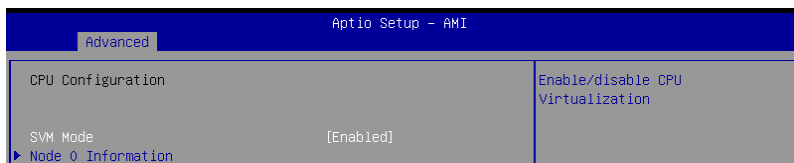

SVM Mode [Enabled]

This item allows you enable or disable CPU Virtualization.

Configuration options: [Disabled] [Enabled]

Node Information

This item allows you to view memory information related to the selected node.

4.4.8 PCI Subsystem Settings

Allows you to configure PCI, PCI-X, and PCI Express Settings.

Advanced		Aptio Setup - AMI	
AMI PCI Driver Version : A5.01.30		Globally Enables or Disables 64bit capable Devices to be Decoded in Above 4G Address Space (Only if System Supports 64 bit PCI Decoding).	
PCI Settings Common for all Devices:			
Above 4G Decoding	[Enabled]		
SR-IOV Support	[Disabled]		
BME DMA Mitigation	[Disabled]		
Hot-Plug Support	[Enabled]		

Above 4G Decoding [Enabled]

Allows you to enable or disable 64-bit capable devices to be decoded in above 4G address space. It only works if the system supports 64-bit PCI decoding.

Configuration options: [Disabled] [Enabled]

SR-IOV Support [Disabled]

Allows you to enable or disable Single Root IO Virtualization Support if the system has SR-IOV capable PCIe devices.

Configuration options: [Disabled] [Enabled]

BME DMA Mitigation [Disabled]

Allows you to re-enable the Bus Master Attribute disabled during PCI enumeration for PCI bridges after SMM lock.

Configuration options: [Disabled] [Enabled]

Hot-Plug Support [Enabled]

Globally enables or disables hot-plug support for the entire system. If the system has hot-plug capable slots, this provides a setup screen for selecting PCI resource padding.

Configuration options: [Disabled] [Enabled]

PCI Device Settings

Allows you to configure options for the selected PCI device.

4.4.9 USB Configuration

Advanced		Aptio Setup - AMI	
USB Configuration		[Enabled]: Enables the Legacy USB support.	
USB Module Version	33	[Auto]: Automatically disables the Legacy USB support if USB devices are not connected.	
USB Controllers: 2 XHCIs		[Disabled]: USB devices are available only for EFI applications.	
USB Devices: 3 Drives, 3 Keyboards, 2 Mice, 3 Hubs			
Legacy USB Support	[Enabled]		
XHCI Hand-off	[Enabled]		
USB Mass Storage Driver Support	[Enabled]		
USB Keyboard and Mouse Simulator	[Enabled]		
USB hardware delays and time-outs:		++: Select Screen	
USB transfer time-out	[20 sec]	↑↓: Select Item	
Device reset time-out	[20 sec]	Enter: Select	
Device power-up delay	[Auto]	+/-: Change Opt.	
Mass Storage Devices:		F1: General Help	
AMI Virtual CDROM 1.00	[Auto]	F2: Previous Values	
AMI Virtual HDisk 1.00	[Auto]	F5: Optimized Defaults	
JetFlashTranscend 4GB 8.07	[Auto]	F10: Save Changes & Reset	
		F12: Print Screen	
		ESC: Exit	

Legacy USB Support [Enabled]

Configuration options: [Enabled] [Disabled] [Auto]

XHCI Hand-off [Enabled]

Configuration options: [Enabled] [Disabled]

USB Mass Storage Driver Support [Enabled]

Configuration options: [Disabled] [Enabled]

USB Keyboard and Mouse Simulator [Enabled]

Configuration options: [Disabled] [Enabled]

USB Transfer Time-out [20 sec]

Configuration options: [1 sec] [5 sec] [10 sec] [20 sec]

Device Reset Time-out [20 sec]

Configuration options: [10 sec] [20 sec] [30 sec] [40 sec]

Device Power-up Delay [Auto]

Configuration options: [Auto] [Manual]

Mass Storage Devices

Allows you to select the mass storage device emulation type for devices connected.

Configuration options: [Auto] [Floppy] [Forced FDD] [Hard Disk] [CD-ROM]

4.4.10 Network Stack Configuration

Aptio Setup - AMI		
Advanced		
Network Stack	[Enabled]	Enable/Disable UEFI Network Stack
IPv4 PXE Support	[Disabled]	
IPv4 HTTP Support	[Disabled]	
IPv6 PXE Support	[Disabled]	
IPv6 HTTP Support	[Disabled]	
PXE boot wait time	0	
Media detect count	1	

Network Stack [Enabled]

Configuration options: [Disabled] [Enabled]



The following items appear only when **Network Stack** is set to **[Enabled]**.

IPv4 PXE Support [Disabled]

Configuration options: [Disabled] [Enabled]

IPv4 HTTP Support [Disabled]

Configuration options: [Disabled] [Enabled]

IPv6 PXE Support [Disabled]

Configuration options: [Disabled] [Enabled]

IPv6 HTTP Support [Disabled]

Configuration options: [Disabled] [Enabled]

PXE boot wait time [0]

Wait time to press ESC key to abort the PXE boot.

Media detect count [1]

Wait time (in seconds) to detect media.

4.4.11 NVMe Configuration

This page will display the NVMe controller and drive information.

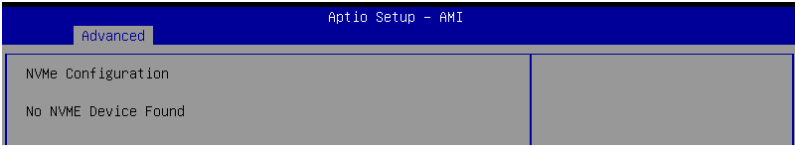

4.4.12 SATA Configuration

This page will display the SATA controller and drive information.

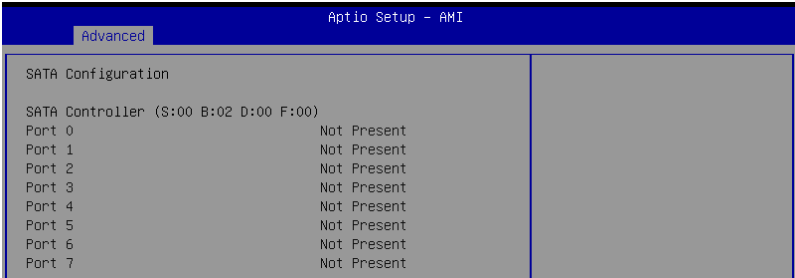

4.4.13 APM Configuration

Allows you to configure the Advanced Power Management (APM) settings.

Aptio Setup - AMI		
Advanced		
Restore AC Power Loss	[Power Off]	Select AC power state when power is re-applied after a power failure.
ErP Ready	[Disabled]	
CEC Ready	[Disabled]	
Power On By PS/2 Keyboard	[Disabled]	

Restore AC Power Loss [Power Off]

When set to [Power Off], the system goes into off state after an AC power loss. When set to [Power On], the system will reboot after an AC power loss. When set to [Last State], the system goes into either off or on state, whatever the system state was before the AC power loss.

Configuration options: [Power On] [Power Off] [Last State]

ErP Ready [Disabled]

Configuration options: [Disabled] [Enabled (S4+S5)] [Enabled (S5)]

CEC Ready [Disabled]

Configuration options: [Disabled] [Enabled]

Power On By PS/2 Keyboard [Disabled]

[Disabled] Disables wake events from PS/2 keyboards.

[Enabled] Enables wake events from PS/2 keyboards.

Power On By PS/2 Mouse [Disabled]

[Disabled] Disables wake events from PS/2 mice.

[Enabled] Enables wake events from PS/2 mice.

Power On By PCI-E [Disabled]

[Disabled] Disables wake events from PCIe devices.

[Enabled] Enables wake events from PCIe devices.

Power On By Ring [Disabled]

[Disabled] Disables wake events from Ring.

[Enabled] Enables wake events from Ring.

Power On By RTC [Disabled]

[Disabled] Disables wake events from RTC.

[Enabled] When set to [Enabled], the items **RTC Alarm Date (Days)** and **Hour/Minute/Second** will become user-configurable.

USB S5 Wakeup Support [Disabled]

Configuration options: [Disabled] [Enabled]

4.4.14 AMD Mem Configuration Status

The items in this menu display the memory configuration (initialized by ABL) status.

Aptio Setup - AMI		
Advanced		
▶ Socket 0		Socket-specific memory configuration status
Mbist Test Enable	Disabled, 0xC000	
Mbist Aggressor Enable	Disabled, 0xC000	
Mbist Per Bit Slave Die Report	0x00FF, 0xC000	
Dram Temp Controlled Refresh Enable	Disabled, 0xC001	
User Timing Mode	Disabled, 0x0000	
User Timing Value	Disabled, 0x0000	
Mem Bus Freq Limit	Disabled, 0x0000	
Enable Power Down	Disabled, 0xC000	
Dram Double Refresh Rate	Disabled, 0x0000	
Pmu Train Mode	0x0000, 0xC000	

4.4.15 T1s Auth

Allows you to configure the Server Certificate Authority (CA).

Aptio Setup - AMI	
Advanced	
▶ Server CA Configuration	Press <Enter> to configure Server CA.
▶ Client Cert Configuration	

Server / Client CA Configuration

Enroll Cert

Allows you to enroll a certificate using a certificate file or manually input a certificate GUID.

Enroll Cert Using File

Allows you to enroll a certificate using a certificate file. You will be prompted to select a storage device and navigate to the location of the certificate file.

Cert GUID

Allows you to enroll a certificate by manually inputting the certificate GUID.

Commit Changes and Exit

Exit Server CA configuration after saving the changes.

Discard Changes and Exit

Exit Server CA configuration without saving any changes.

Delete Cert

Allows you to delete the certificate.

4.4.16 Third-party UEFI driver configurations

Additional configuration options for third-party UEFI drivers installed to the system will appear in the section marked in red in the screenshot below.

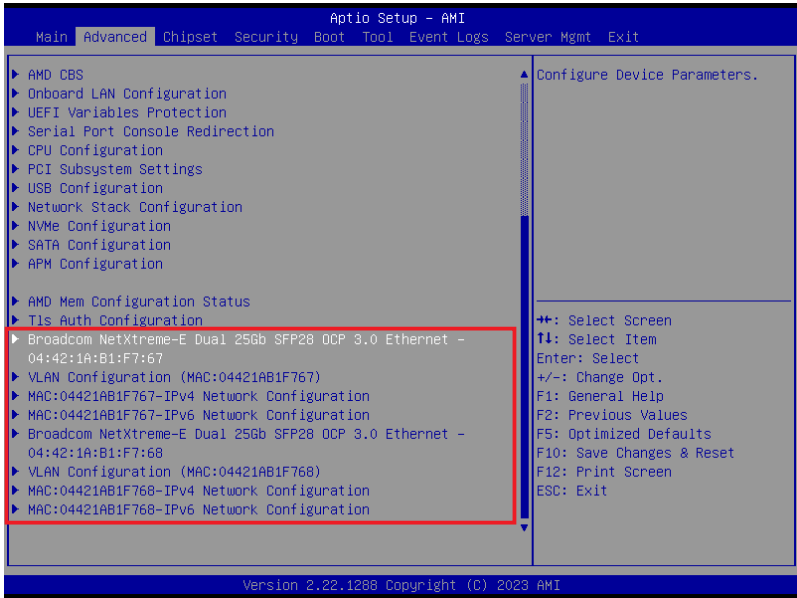

4.4.17 Driver Health

This page will display the driver and controller health status.

Aptio Setup - AMI		
Advanced		
▶ Broadcom NXE Gigabit Ethernet Driver	Healthy	Provides Health Status for the Drivers/Controllers
▶ Broadcom NXE Gigabit Ethernet Driver	Healthy	

4.5 Chipset menu

The Chipset menu items allow you to change the Chipset settings.

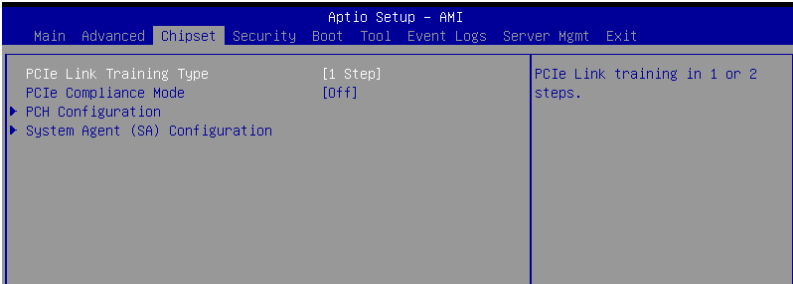

PCIe Link Training Type [1 Step]

This item allows you to select PCIe Link Training in 1 or 2 steps.

Configuration options: [1 Step] [2 Step]

PCIe Compliance Mode [Off]

This item allows you to turn the PCIe Compliance Mode on or off.

Configuration options: [Off] [On]

PCH Configuration

Allows you to configure PCH options.

System Agent (SA) Configuration

Allows you to configure System Agent options

4.6 Security menu

This menu allows a new password to be created or a current password to be changed. The menu also enables or disables the Secure Boot state and lets the user configure the System Mode state.

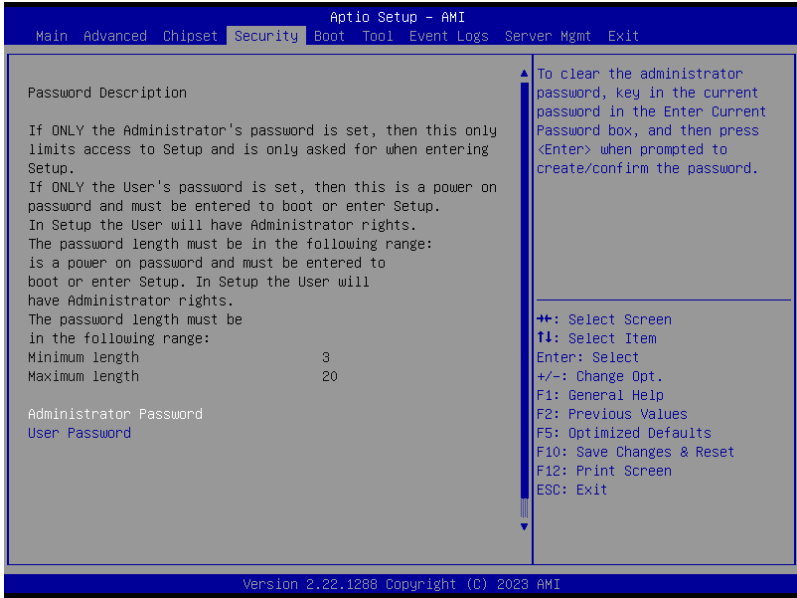

Administrator Password

To set an administrator password:

1. Select the Administrator Password item and press <Enter>.
2. From the Create New Password box, key in a password, then press <Enter>.
3. Confirm the password when prompted.

To change an administrator password:

1. Select the Administrator Password item and press <Enter>.
2. From the Enter Current Password box, key in the current password, then press <Enter>.
3. From the Create New Password box, key in a new password, then press <Enter>.
4. Confirm the password when prompted.



To clear the administrator password, follow the same steps as in changing an administrator password, but press <Enter> when prompted to create/confirm the password.

User Password

To set a user password:

1. Select the User Password item and press <Enter>.
2. From the Create New Password box, key in a password, then press <Enter>.
3. Confirm the password when prompted.

To change a user password:

1. Select the User Password item and press <Enter>.
2. From the Enter Current Password box, key in the current password, then press <Enter>.
3. From the Create New Password box, key in a new password, then press <Enter>.
4. Confirm the password when prompted.



To clear the user password, follow the same steps as in changing a user password, but press <Enter> when prompted to create/confirm the password.

4.7 Boot menu

The Boot menu items allow you to change the system boot options.

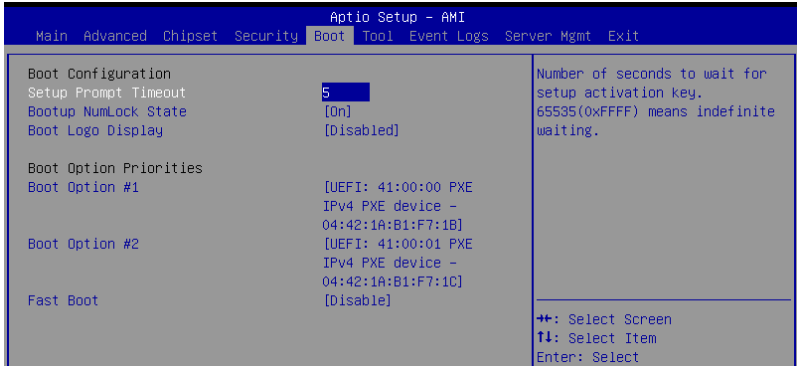

Setup Prompt Timeout [5]

Allows you to set the number of seconds that the firmware waits before initiating the original default boot selection. 65535 (0xFFFF) means indefinite waiting. Use the <+> or <-> to adjust the value.

Bootup NumLock State [On]

Allows you to select the power-on state for the NumLock.
Configuration options: [On] [Off]

Boot Logo Display [Disabled]

Allows you to enable or disable Quiet Boot option.
Configuration options: [Disabled] [Enabled]

Boot Option Priorities

These items specify the boot device priority sequence from the available devices. The number of device items that appears on the screen depends on the number of devices installed in the system.



- To select the boot device during system startup, press <F8> when ASUS Logo appears.
- To access Windows OS in Safe Mode, please press <F8> after POST.

Fast Boot [Disabled]

Configuration options: [Disabled] [Enabled]

4.8 Tool menu

The Tool menu items allow you to configure options for special functions. Select an item and press <Enter> to display the submenu.

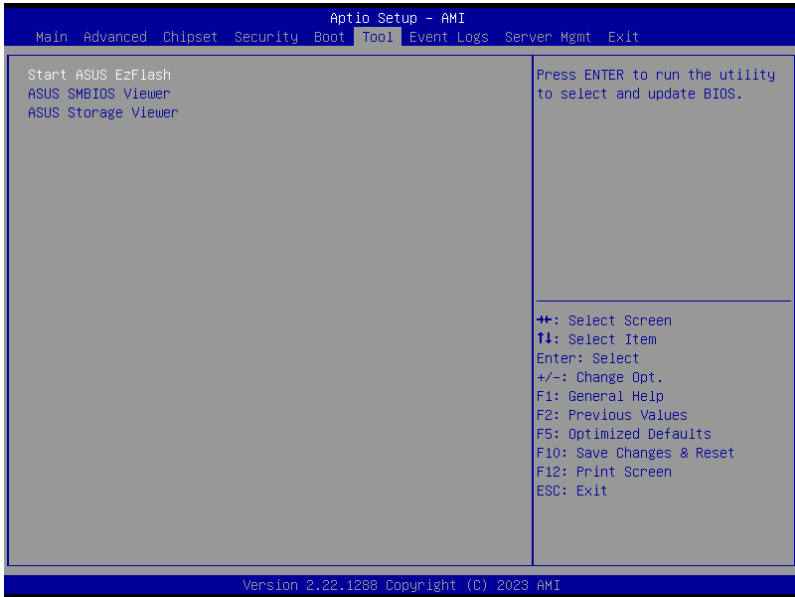

Start ASUS EzFlash

Allows you to run ASUS EZ Flash BIOS ROM Utility. Refer to the ASUS EZ Flash Utility section for details.

ASUS SMBIOS Viewer

Allows you to run ASUS SMBIOS Viewer.

ASUS Storage Viewer

Allows you to run ASUS Storage Viewer.

4.9 Event Logs menu

The Event Logs menu items allow you to change the event log settings and view the system event logs.

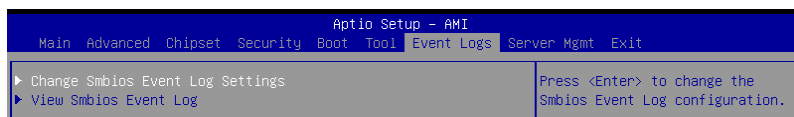

4.9.1 Change Smbios Event Log Settings

Press <Enter> to change the Smbios Event Log configuration.



All values changed here do not take effect until computer is restarted.

Smbios Event Log [Enabled]

Change this to enable or disable all features of Smbios Event Logging during boot.

Configuration options: [Disabled] [Enabled]



The following item appears only when **Smbios Event Log** is set to **[Enabled]**.

Erase Event Log [No]

Choose options for erasing Smbios Event Log. Erasing is done prior to any logging activation during reset.

Configuration options: [No] [Yes, Next reset] [Yes, Every reset]

When Log is Full [Do Nothing]

Choose options for reactions to a full Smbios Event Log.

Configuration options: [Do Nothing] [Erase Immediately]

Log System Boot Event [Enabled]

Configuration options: [Disabled] [Enabled]

MECI [1]

Allows you to set the Multiple Event Count Increment.

MECI [60]

Allows you to set the Multiple Event Time Window.

Log EFI Status Code [Enabled]

Configuration options: [Disabled] [Enabled]

Convert EFI Status Codes to Standard Smbios Type [Disabled]

Configuration options: [Disabled] [Enabled]

4.9.2 View Smbios Event Log

Press <Enter> to view all Smbios event logs.

4.10 Server Mgmt menu

The Server Management menu displays the server management status and allows you to change the settings.

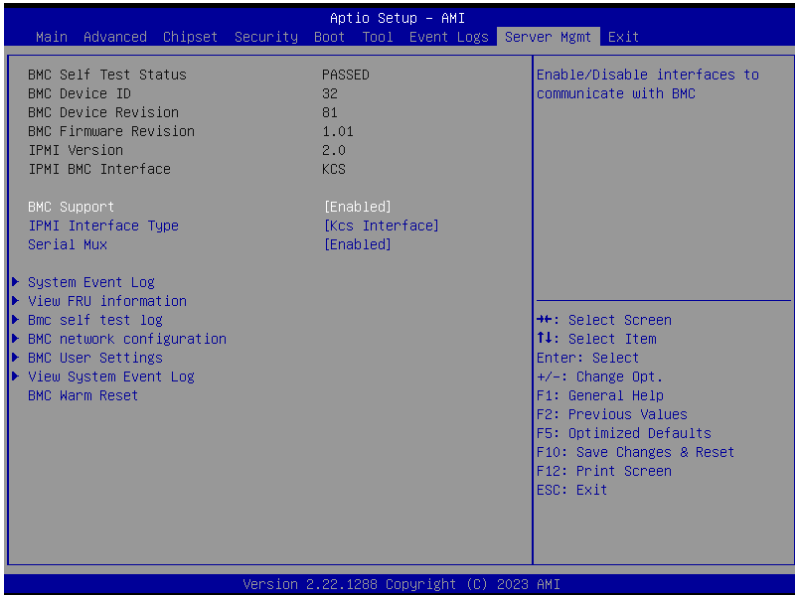

BMC Support [Enabled]

Allows you to enable or disable interfaces to communicate with BMC.

Configuration options: [Disabled] [Enabled]



The following items are available only when **BMC Support** is set to **[Enabled]**.

IPMI Interface Type [Kcs Interface]

Configuration options: [Kcs Interface]

Serial Mux [Enabled]

Configuration options: [Disabled] [Enabled]

BMC Warm Reset [Enabled]

Allows you to warm reset the BMC.

4.10.1 System Event Log

Allows you to change the SEL event log configuration.



All values changed here do not take effect until computer is restarted.

Aptio Setup - AMI		Server Mgmt
Enabling/Disabling Options		
SEL Components	[Enabled]	Change this to enable or disable event logging for error/progress codes during boot.
Erasing Settings		
Erase SEL	[No]	
When SEL is Full	[Do Nothing]	
Custom EFI Logging Options		
Log EFI Status Codes	[Error code]	

SEL Components [Enabled]

Allows you to enable or disable event logging for error/progress codes during boot.
Configuration options: [Disabled] [Enabled]



The following item is available only when **SEL Components** is set to **[Enabled]**.

Erase SEL [No]

Configuration options: [No] [Yes, On next reset] [Yes, On every reset]

When SEL is Full [Do Nothing]

Configuration options: [Do Nothing] [Erase Immediately] [Delete Oldest Record]

Log EFI Status Codes [Error Code]

Configuration options: [Disabled] [Both] [Error code] [Progress code]

4.10.2 View FRU Information

Allows you to view FRU information.

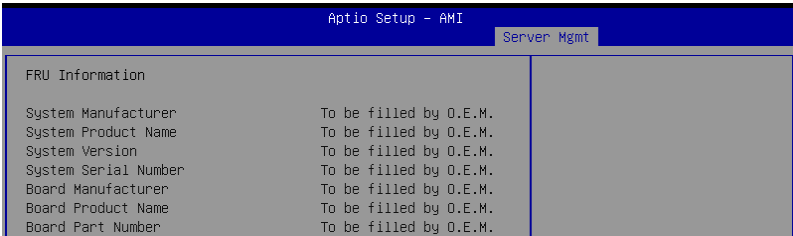

4.10.3 BMC self test log

Allows you to change the BMC log configuration.

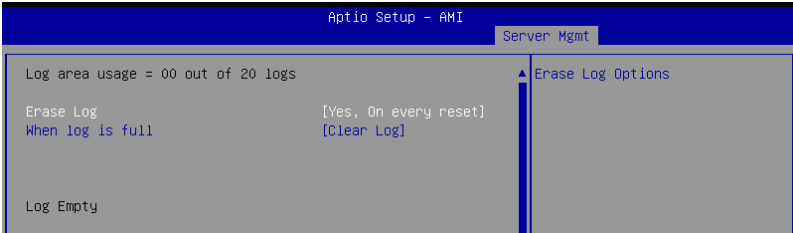

Erase Log [Yes, On every reset]

Allows you to choose options for erasing log.

Configuration options: [Yes, On every reset] [No]

When log is full [Clear Log]

Select the action to be taken when log is full.

Configuration options: [Clear Log] [Do not log any more]

4.10.4 BMC network configuration

The sub-items in this configuration allow you to configure the BMC network parameters.

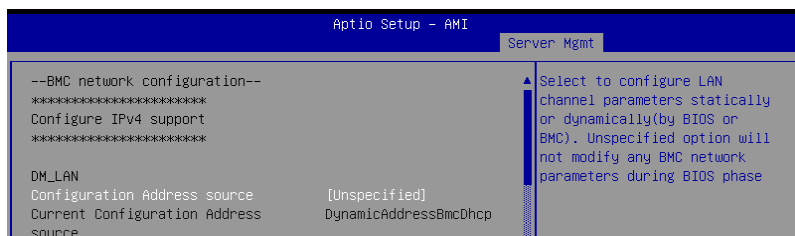

DM_LAN/Shared LAN

Configuration Address source [Unspecified]

Configuration options: [Unspecified] [Static] [DynamicBmcDhcp] [DynamicBmcNonDhcp]



The following items are available only when **Configuration Address source** is set to **[Static]**.

Station IP address

Allows you to set the station IP address.

Subnet mask

Allows you to set the subnet mask. We recommend that you use the same Subnet Mask you have specified on the operating system network for the used network card.

Router IP Address

Allows you to set the router IP address.

Router MAC Address

Allows you to set the router MAC address.

IPv6 Support [Enabled]

Configuration options: [Enabled] [Disabled]



The following items appear only when **IPv6 Support** is set to **[Enabled]**.

Configuration Address source [Unspecified]

Configuration options: [Unspecified] [Static] [DynamicBmcDhcp]



The following items are available only when **Configuration Address source** is set to **[Static]**.

Station IPv6 address

Allows you to set the station IPv6 address.

Prefix Length

Allows you to set the prefix length.

VLAN Support [Unspecified]

Configuration options: [Unspecified] [Enabled] [Disabled]



The following items are available only when **VLAN Support** is set to **[Enabled]**.

VLAN ID

Allows you to set the VLAN ID.

VLAN Priority

Allows you to set the VLAN Priority.

4.10.5 BMC User Settings

Allows you to add, delete, or change BMC users.

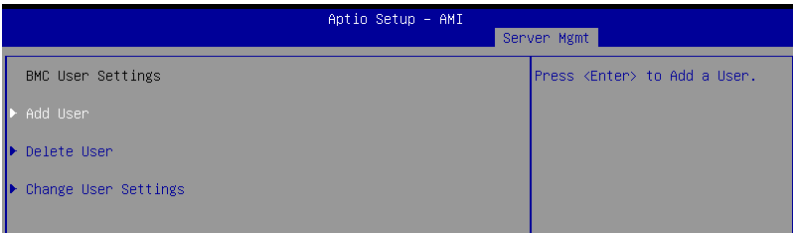

4.10.6 View System Event Log

This item allows you to view the system event log records.

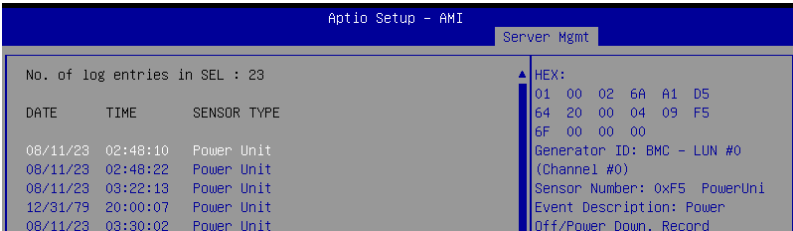

4.11 Exit menu

The Exit menu items allow you to save or discard your changes to the BIOS items.

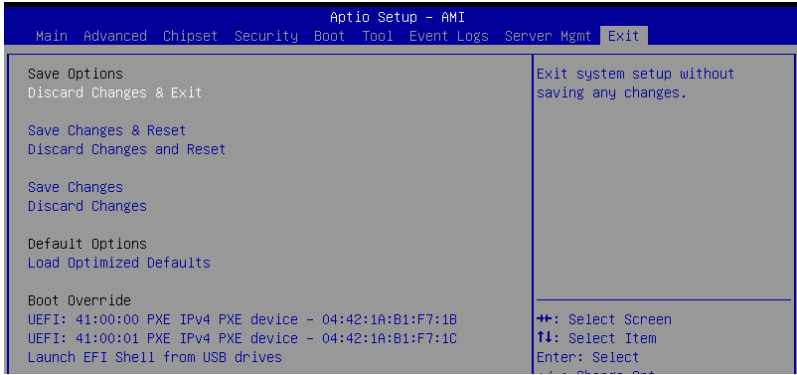

Discard Changes and Exit

Exit system setup without saving any changes.

Save Changes and Reset

Reset the system after saving the changes.

Discard Changes and Reset

Reset system setup without saving any changes.

Save Changes

Save changes done so far to any of the setup options.

Discard Changes

Discard changes done so far to any of the setup options.

Load Optimized Defaults

Restore/load default values for all the setup options.

Boot Override

These items displays the available devices. The device items that appears on the screen depends on the number of devices installed in the system. Click an item to start booting from the selected device.

Launch EFI Shell from filesystem device

This item allows you to attempt to launch the EFI Shell application (shellx64.efi) from one of the available filesystem devices.

Driver Installation

5

This chapter provides the instructions for installing the necessary drivers for different system components in both Linux[®] and Windows[®] Operating Systems.

5.1 Running the Support DVD

The support DVD that is bundled with your motherboard contains drivers, management applications, and utilities that you can install to maximize the features of your motherboard.



The contents of the support DVD are subject to change at any time without notice. Visit the ASUS website (www.asus.com) for the latest updates on software and utilities.

The main screen of the Support DVD contains the following tabs:

1. Drivers - Shows the available device drivers that the system detects.
2. Utilities - Displays the software applications and utilities that the motherboard supports.
3. Manual - Provides the link to the user guide(s).



You need an internet browser installed in your OS to view the User Guide.

4. Contact - Displays the ASUS contact information, e-mail addresses, and useful links if you need more information or technical support for your motherboard.

Appendix

This appendix includes additional information that you may refer to when configuring the motherboard.

Block diagram

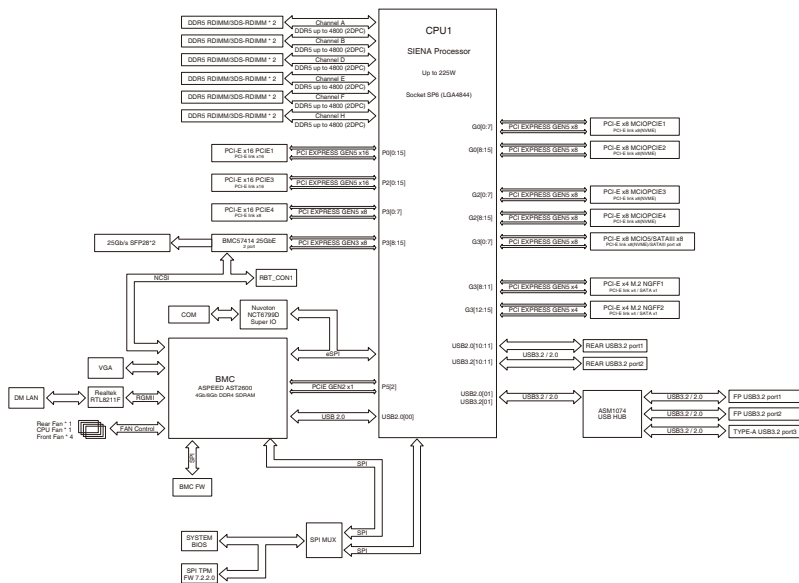

Q-Code table

ACTION	PHASE	POST CODE	TYPE	DESCRIPTION
SEC Start up	Security Phase	0x01	Progress	First post code
		0x02	Progress	Load BSP microcode
		0x03	Progress	Perform early platform Initialization
		0x04	Progress	Set cache as ram for PEI phase
		0x05	Progress	Establish Stack
		0x06	Progress	CPU Early Initialization
PSP Boot	PSP Boot Loader phase (Error Post Codes)	0x00	error	General - Success
		0x01	error	Generic Error Code
		0x02	error	Generic Memory Error
		0x03	error	Buffer Overflow
		0x04	error	Invalid Parameter(s)
		0x05	error	Invalid Data Length
		0x06	error	Data Alignment Error
		0x07	error	Null Pointer Error
		0x08	error	Unsupported Function
		0x09	error	Invalid Service ID
		0x0A	error	Invalid Address
		0x0B	error	Out of Resource Error
		0x0C	error	Timeout
		0x0D	error	Data abort exception
		0x0E	error	Prefetch abort exception
		0x0F	error	Out of Boundary Condition Reached
		0x10	error	Data corruption
		0x11	error	Invalid command
		0x12	error	The package type provided by BR is incorrect
		0x13	error	Failed to retrieve FW header during FW validation
		0x14	error	Key size not supported
		0x15	error	Agesa0 verification error
		0x16	error	SMU FW verification error
		0x17	error	OEM SINGING KEY verification error
		0x18	error	Generic FW Validation error
		0x19	error	RSA operation fail - bootloader
		0x1A	error	CCP Passthrough operation failed - internal status
		0x1B	error	AES operation fail
		0x1C	error	CCP state save failed
0x1D	error	CCP state restore failed		
0x1E	error	SHA256/384 operation fail - internal status		
0x1F	error	ZLib Decompression operation fail		
0x20	error	HMAC-SHA256/384 operation fail - internal status		
0x21	error	Booted from boot source not recognized by PSP		
0x22	error	PSP directory entry not found		
0x23	error	PSP failed to set the write enable latch		
0x24	error	PSP timed out because spirom took too long		
0x25	error	Cannot find BIOS directory		
0x26	error	SpiRom is not valid		
0x27	error	Slave die has different security state from master		
0x28	error	SMI interface init failure		
0x29	error	SMI interface generic error		

(continued on the next page)

ACTION	PHASE	POST CODE	TYPE	DESCRIPTION
		0x2A	error	Invalid die ID executes MCM related function
		0x2B	error	Invalid MCM configuration table read from bootrom
		0x2C	error	Valid boot mode wasn't detected
		0x2D	error	NVStorage init failure
		0x2E	error	NVStorage generic error
		0x2F	error	MCM 'error' to indicate slave has more data to send
		0x30	error	MCM error if data size exceeds 32B
		0x31	error	Invalid client id for SVC MCM call
		0x32	error	MCM slave status register contains bad bits
		0x33	error	MCM call was made in a single die environment
		0x34	error	PSP secure mapped to invalid segment (should be 0x400_0000)
		0x35	error	No physical x86 cores were found on die
		0x36	error	Insufficient space for secure OS (range of free SRAM to SVC stack base)
		0x37	error	SYSHUB mapping memory target type is not supported
		0x38	error	Attempt to unmap permanently mapped TLB to PSP secure region
		0x39	error	Unable to map an SMN address to AXI space
		0x3A	error	Unable to map a SYSHUB address to AXI space
		0x3B	error	The count of CCXs or cores provided by bootrom is not consistent
		0x3C	error	Uncompressed image size doesn't match value in compressed header
		0x3D	error	Compressed option used in case where not supported
		0x3E	error	Fuse info on all dies don't match
		0x3F	error	PSP sent message to SMU; SMU reported an error
		0x40	error	Function RunPostX86ReleaseUnitTests failed in memcmp()
PSP Boot	PSP Boot Loader phase (Error Post Codes)	0x41	error	Interface between PSP to SMU not available.
		0x42	error	Timer wait parameter too large
		0x43	error	Test harness module reported an error
		0x44	error	x86 wrote C2PMSG_0 interrupting PSP, but the command has an invalid format
		0x45	error	Failed to read from SPI the Bios Directory or Bios Combo Directory
		0x46	error	Failed to find FW entry in SPL Table
		0x47	error	Failed to read the combo bios header
		0x48	error	SPL version mismatch
		0x49	error	Error in Validate and Loading AGESA APOB SVC call
		0x4A	error	Correct fuse bits for DIAG_BL loading not set
		0x4B	error	The UmcProgramKeys() function was not called by AGESA
		0x4C	error	Unconditional Unlock based on serial numbers failure
		0x4D	error	Syshub register programming mismatch during readback
		0x4E	error	Family ID in MP0_SFUSE_SEC[7:3] not correct
		0x4F	error	An operation was invoked that can only be performed by the GM
		0x50	error	Failed to acquire host controller semaphore to claim ownership of SMB
		0x51	error	Timed out waiting for host to complete pending transactions
		0x52	error	Timed out waiting for slave to complete pending transactions
		0x53	error	Unable to kill current transaction on host, to force idle
		0x54	error	One of: Illegal command, Unclaimed cycle, or Host time out
		0x55	error	An smbus transaction collision detected, operation restarted
		0x56	error	Transaction failed to be started or processed by host, or not completed
		0x57	error	An unsolicited smbus interrupt was received
		0x58	error	An attempt to send an unsupported PSP-SMU message was made

(continued on the next page)

ACTION	PHASE	POST CODE	TYPE	DESCRIPTION
PSP Boot	PSP Boot Loader phase (Error Post Codes)	0x59	error	An error/data corruption detected on response from SMU for sent msg
		0x5A	error	MCM Steady-state unit test failed
		0x5B	error	S3 Enter failed
		0x5C	error	AGESA BL did not set PSP SMU reserved addresses via SVC call
		0x5D	error	Reserved PSP/SMU memory region is invalid
		0x5E	error	CcxSecBisIE n not set in fuse RAM
		0x5F	error	Received an unexpected result
		0x60	error	VMG Storage Init failed
		0x61	error	Failure in mbedTLS user app
		0x62	error	An error occurred whilst attempting to SMN map a fuse register
		0x63	error	Fuse burn sequence/operation failed due to internal SOC error
		0x64	error	Fuse sense operation timed out
		0x65	error	Fuse burn sequence/operation timed out waiting for burn done
		0x66	error	The PMU FW Public key certificate loading or authentication fails
		0x67	error	This PSP FW was revoked
		0x68	error	The platform model/vendor id fuse is not matching the BIOS public key token
		0x69	error	The BIOS OEM public key of the BIOS was revoked for this platform
		0x6A	error	PSP level 2 directory not match expected value.
		0x6B	error	BIOS level 2 directory not match expected value.
		0x6C	error	Reset image not found
		0x6D	error	Generic error indicating the CCP HAL initialization failed
		0x6E	error	Failure to copy NVRAM to DRAM.
		0x6F	error	Invalid key usage flag
		0x70	error	Unexpected fuse set
		0x71	error	RSMU signaled a security violation
		0x72	error	Error programming the WAFL PCS registers
		0x73	error	Error setting wafl PCS threshold value
		0x74	error	Error loading OEM trustlets
		0x75	error	Recovery mode across all dies is not sync'd
		0x76	error	Uncorrectable WAFL error detected
		0x77	error	Fatal MP1 error detected
		0x78	error	Bootloader failed to find OEM signature
		0x79	error	Error copying BIOS to DRAM
		0x7A	error	Error validating BIOS image signature
		0x7B	error	OEM Key validation failed
0x7C	error	Platform Vendor ID and/or Model ID binding violation		

(continued on the next page)

ACTION	PHASE	POST CODE	TYPE	DESCRIPTION
PSP Boot	PSP Boot Loader phase (Status Post Codes)	0x7D	error	Bootloader detects BIOS request boot from SPI-ROM, which is unsupported for PSB.
		0x7E	error	Requested fuse is already blown, reblow will cause ASIC malfunction
		0x7F	error	Error with actual fusing operation
		0x80	error	(Local Master PSP on P1 socket) Error reading fuse info
		0x81	error	(Local Master PSP on P1 socket) Platform Vendor ID and/or Model ID binding violation
		0x82	error	(Local Master PSP on P1 socket) Requested fuse is already blown, reblow will cause ASIC malfunction
		0x83	error	(Local Master PSP on P1 socket) Error with actual fusing operation
		0x84	error	SEV FW Rollback attempt is detected
		0x85	error	SEV download FW command fail to broadcast and clear the IsInSRAM field on slave dies
		0x86	error	Agesa error injection failure
		0x87	error	Uncorrectable TWIX error detected
		0x88	error	Error programming the TWIX PCS registers
		0x89	error	Error setting TWIX PCS threshold value
		0x8A	error	SW CCP queue is full, cannot add more entries
		0x8B	error	CCP command description syntax error detected from input
		0x8C	error	Return value stating that the command has not yet be scheduled
		0x8D	error	The command is scheduled and being worked on
		0x8E	error	The DXIO PHY SRAM Public key certificate loading or authentication fails
		0x8F	error	fTPM binary size exceeds limit allocated in Private DRAM, need to increase the limit
		0x90	error	The TWIX link for a particular CCD is not trained Fatal error
		0x91	error	Security check failed (not all dies are in same security state)
		0x92	error	FW type mismatch between the requested FW type and the FW type embedded in the FW binary header
		0x93	error	SVC call input parameter address violation
		0x94	error	Firmware Compatibility Level mismatch
		0x95	error	Bad status returned by I2CKnollCheck
		0x96	error	NACK to general call (no device on Knoll I2C bus)
		0x97	error	Null pointer passed to I2CKnollCheck
		0x98	error	Invalid device-ID found during Knoll authentication
		0x99	error	Error during Knoll/Prom key derivation
		0x9A	error	Null pointer passed to Crypto function
0x9B	error	Error in checksum from wrapped Knoll/Prom keys		
0x9C	error	Knoll returned an invalid response to a command		
0x9D	error	Bootloader failed in Knoll Send Command function		
0x9E	error	No Knoll device found by verifying MAC		
0x9F	error	The maximum allowable error post code		

(continued on the next page)

ACTION	PHASE	POST CODE	TYPE	DESCRIPTION
PSP Boot	PSP Boot Loader phase (Status Post Codes)	0xA0	error	Bootloader successfully entered C Main
		0xA1	error	Master initialized C2P / slave waited for master to init C2P
		0xA2	error	HMAC key successfully derived
		0xA3	error	Master got Boot Mode and sent boot mode to all slaves
		0xA4	error	SpiRom successfully initialized
		0xA5	error	BIOS Directory successfully read from SPI to SRAM
		0xA6	error	Early unlock check
		0xA7	error	Inline Aes key successfully derived
		0xA8	error	Inline-AES key programming is done
		0xA9	error	Inline-AES key wrapper derivation is done
		0xAA	error	Bootloader successfully loaded HW IP configuration values
		0xAB	error	Bootloader successfully programmed MBAT table
		0xAC	error	Bootloader successfully loaded SMU FW
		0xAD	error	Progress code is available
		0xAE	error	User mode test Uapp completed successfully
		0xAF	error	Bootloader loaded Agesa0 from SpiRom
		0xB0	error	AGESA phase has completed
		0xB1	error	RunPostDramTrainingTests() completed successfully
		0xB2	error	SMU FW Successfully loaded to SMU Secure DRAM
		0xB3	error	Sent all required boot time messages to SMU
		0xB4	error	Validated and ran Security Gasket binary
		0xB5	error	UMC Keys generated and programmed
		0xB6	error	Inline AES key wrapper stored in DRAM
		0xB7	error	Completed FW Validation step
		0xB8	error	Completed FW Validation step
		0xB9	error	BIOS copy from SPI to DRAM complete
0xBA	error	Completed FW Validation step		

(continued on the next page)

ACTION	PHASE	POST CODE	TYPE	DESCRIPTION
PSP Boot	PSP Boot Loader phase (Status Post Codes)	0xBB	error	BIOS load process fully complete
		0xBC	error	Bootloader successfully release x86
		0xBD	error	Early Secure Debug completed
		0xBE	error	GetFWVersion command received from BIOS is completed
		0xBF	error	SMInfo command received from BIOS is completed
		0xC0	error	Successfully entered WarmBootResume()
		0xC1	error	Successfully copied SecureOS image to SRAM
		0xC2	error	Successfully copied trustlets to PSP Secure Memory
		0xC3	error	About to jump to Secure OS (SBL about to copy and jump)
		0xC4	error	Successfully restored CCP and UMC state on S3 resume
		0xC5	error	PSP SRAM HMAC validated by Mini BL
		0xC6	error	About to jump to <t-base in Mini BL
		0xC7	error	VMG ECDH unit test started
		0xC8	error	VMG ECDH unit test passed
		0xC9	error	VMG ECC CDH primitive unit test started
		0xCA	error	VMG ECC CDH primitive unit test passed
		0xCB	error	VMG SP800-108 KDF-CTR HMAC unit test started
		0xCC	error	VMG SP800-108 KDF-CTR HMAC unit test passed
		0xCD	error	VMG LAUNCH_ " test started
		0xCE	error	VMG LAUNCH_ " test passed
		0xCF	error	MP1 has been taken out of reset, and executing SMUFW
		0xD0	error	PSP and SMU Reserved Addresses correct
		0xD1	error	Reached Naples steady-state WFI loop
		0xD2	error	Knoll device successfully initialized
		0xD3	error	32-byte RandOut successfully returned from Knoll
		0xD4	error	32-byte MAC successfully received from Knoll.
		0xD5	error	Knoll device verified successfully
		0xD6	error	CNLI Keys generated and programmed
		0xD7	error	Enter recovery mode due to trustlet validation fail.
		0xD8	error	Enter recovery mode due to OS validation fail.
		0xD9	error	Enter recovery mode due to OEM public key not found.
		0xDA	error	Enter recovery mode with header corruption
		0xDB	error	We should not treat this error as blocking
		0xDC	error	When same fw image type is already loaded in SRAM
0xDD	error	0xE2 progress codes are available		
0xE0	error	Unlock return		
0xE2	error	Token expiration reset triggered		
0xE3	error	Completed DXIO PHY SRAM FW key Validation step		
0xE4	error	MP1 firmware load to SRAM success		

(continued on the next page)

ACTION	PHASE	POST CODE	TYPE	DESCRIPTION
PSP Boot	PSP Boot Loader phase (Status Post Codes)	0xE5	error	Bootloader read the MP1 SRAM successfully
		0xE6	error	Bootloader successfully reset MP1
		0xE7	error	DF init successfully done (in absence of AGESA)
		0xE8	error	UMC init successfully done (in absence of AGESA)
		0xE9	error	LX6 Boot ROM code ready
		0xEA	error	Bootloader successfully asserted LX6 reset
		0xEB	error	LX6 load to SRAM success
		0xEC	error	Bootloader successfully set LX6 reset vector to SRAM
		0xED	error	Bootloader successfully de-asserted LX6 reset
		0xEE	error	LX6 firmware is running and ready
		0xEF	error	Loading of S3 image done successfully
		0xF0	error	Bootloader successfully verify signed image using 4K/2K key
		0xF1	error	Bootloader identified as running on SP32P or multi-socket boot
		0xF2	error	Security Policy check successful (only in secure boot)
		0xF3	error	Bootloader successfully loaded SS3
		0xF4	error	Bootloader successfully load fTPM Driver
		0xF5	error	Bootloader successfully loaded sys_drv
0xF6	error	Bootloader successfully loaded secure OS		
0xF7	error	Bootloader about to transfer control to secureOS		
0xFF	error	Bootloader sequence finished		
Quick VGA	PEI(Pre-EFI Initialization) phase	0x10	Progress	PEI Core Entry
		0x11	Progress	PEI cache as ram CPU initial
		0x15	Progress	NB Initialization before installed memory
		0x19	Progress	SB Initialization before installed memory

(continued on the next page)

ACTION	PHASE	POST CODE	TYPE	DESCRIPTION	
Quick VGA	D X E (D r i v e r E x e c u t i o n E n v i r o n m e n t) phase	0x32	Progress	CPU POST-Memory Initialization	
		0x33	Progress	CPU Cache Initialization	
		0x34	Progress	Application Processor(s) (AP) Initialization	
		0x35	Progress	BSP Selection	
		0x36	Progress	CPU Initialization	
		0x37	Progress	Pre-memory NB Initialization	
		0x3B	Progress	Pre-memory SB Initialization	
		0x4F	Progress	DXE Initial Program Load(IPL)	
		0x60	Progress	DXE Core Started	
		0x61	Progress	DXE NVRAM Initialization	
		0x62	Progress	SB run-time Initialization	
		0x63	Progress	CPU DXE Initialization	
		0x68	Progress	PCI HB Initialization	
		0x69	Progress	NB DXE Initialization	
		0x6A	Progress	NB DXE SMM Initialization	
		0x70	Progress	SB DXE Initialization	
		0x71	Progress	SB DXE SMM Initialization	
		0x72	Progress	SB DEVICES Initialization	
		0x78	Progress	ACPI Module Initialization	
		0xD0	Progress	CPU PM Structure Initialization	
Normal boot	BDS(Boot Device Selection) phase	0x90	Progress	BDS started	
		0x91	Progress	Connect device event	
		0x92	Progress	PCI Bus Enumeration	
		0x93	Progress	PCI Bus Enumeration	
		0x94	Progress	PCI Bus Enumeration	
		0x95	Progress	PCI Bus Enumeration	
		0x96	Progress	PCI Bus Enumeration	
		0x97	Progress	Console output connect event	
		0x98	Progress	Console input connect event	
		0x99	Progress	AMI Super IO start	
		0x9A	Progress	AMI USB Driver Initialization	
		0x9B	Progress	AMI USB Driver Initialization	
		0x9C	Progress	AMI USB Driver Initialization	
		0x9D	Progress	AMI USB Driver Initialization	
		0xb3	Progress	Reset system	
		0xb4	Progress	USB hotplug	
		0xb6	Progress	NVRAM clean up	
		0xb7	Progress	NVRAM configuration reset	
		0xA0	Progress	IDE, AHCI Initialization	
		0xA1	Progress	IDE, AHCI Initialization	
		0xA2	Progress	IDE, AHCI Initialization	
		0xA3	Progress	IDE, AHCI Initialization	
		0x00-0xFF	Progress	Wait BMC ready	
		0xA8	Progress	BIOS Setup Utility password verify	
		0xA9	Progress	BIOS Setup Utility start	
		0xAB	Progress	BIOS Setup Utility input wait	
		0xAD	Progress	Ready to boot event	
		Operating system phase	0xAA	Progress	APIC mode
			0xAC	Progress	PIC mode

Notices

Federal Communications Commission Statement

This device complies with Part 15 of the FCC Rules. Operation is subject to the following two conditions:

- This device may not cause harmful interference, and
- This device must accept any interference received including interference that may cause undesired operation.

This equipment has been tested and found to comply with the limits for a Class B digital device, pursuant to Part 15 of the FCC Rules. These limits are designed to provide reasonable protection against harmful interference in a residential installation. This equipment generates, uses and can radiate radio frequency energy and, if not installed and used in accordance with manufacturer's instructions, may cause harmful interference to radio communications. However, there is no guarantee that interference will not occur in a particular installation. If this equipment does cause harmful interference to radio or television reception, which can be determined by turning the equipment off and on, the user is encouraged to try to correct the interference by one or more of the following measures:

- Reorient or relocate the receiving antenna.
- Increase the separation between the equipment and receiver.
- Connect the equipment to an outlet on a circuit different from that to which the receiver is connected.
- Consult the dealer or an experienced radio/TV technician for help.



The use of shielded cables for connection of the monitor to the graphics card is required to assure compliance with FCC regulations. Changes or modifications to this unit not expressly approved by the party responsible for compliance could void the user's authority to operate this equipment.

Compliance Statement of Innovation, Science and Economic Development Canada (ISED)

This device complies with Innovation, Science and Economic Development Canada licence exempt RSS standard(s). Operation is subject to the following two conditions: (1) this device may not cause interference, and (2) this device must accept any interference, including interference that may cause undesired operation of the device.

CAN ICES-003(B)/NMB-003(B)

Déclaration de conformité de Innovation, Sciences et Développement économique Canada (ISED)

Le présent appareil est conforme aux CNR d'Innovation, Sciences et Développement économique Canada applicables aux appareils radio exempts de licence. L'exploitation est autorisée aux deux conditions suivantes : (1) l'appareil ne doit pas produire de brouillage, et (2) l'utilisateur de l'appareil doit accepter tout brouillage radioélectrique subi, même si le brouillage est susceptible d'en compromettre le fonctionnement.

CAN ICES-003(B)/NMB-003(B)

Australia statement notice

From 1 January 2012 updated warranties apply to all ASUS products, consistent with the Australian Consumer Law. For the latest product warranty details please visit <https://www.asus.com/support>. Our goods come with guarantees that cannot be excluded under the Australian Consumer Law. You are entitled to a replacement or refund for a major failure and compensation for any other reasonably foreseeable loss or damage. You are also entitled to have the goods repaired or replaced if the goods fail to be of acceptable quality and the failure does not amount to a major failure.

If you require assistance please call ASUS Customer Service 1300 2787 88 or visit us at <https://www.asus.com/support>

Declaration of compliance for product environmental regulation

ASUS follows the green design concept to design and manufacture our products, and makes sure that each stage of the product life cycle of ASUS product is in line with global environmental regulations. In addition, ASUS disclose the relevant information based on regulation requirements.

Please refer to <https://csr.asus.com/Compliance.htm> for information disclosure based on regulation requirements ASUS is complied with:

EU REACH and Article 33

Complying with the REACH (Registration, Evaluation, Authorization, and Restriction of Chemicals) regulatory framework, we publish the chemical substances in our products at ASUS REACH website at <https://csr.asus.com/english/REACH.htm>.

EU RoHS

This product complies with the EU RoHS Directive. For more details, see <https://csr.asus.com/english/article.aspx?id=35>

India RoHS

This product complies with the "India E-Waste (Management) Rules, 2016" and prohibits use of lead, mercury, hexavalent chromium, polybrominated biphenyls (PBBs) and polybrominated diphenyl ethers (PBDEs) in concentrations exceeding 0.1% by weight in homogenous materials and 0.01% by weight in homogenous materials for cadmium, except for the exemptions listed in Schedule II of the Rule.

Vietnam RoHS

ASUS products sold in Vietnam, on or after September 23, 2011, meet the requirements of the Vietnam Circular 30/2011/TT-BCT.

Các sản phẩm ASUS bán tại Việt Nam, vào ngày 23 tháng 9 năm 2011 trở về sau, đều phải đáp ứng các yêu cầu của Thông tư 30/2011/TT-BCT của Việt Nam.

Türkiye RoHS

AEEEE Yönetmeliğine Uygundur

ASUS Recycling/Takeback Services

ASUS recycling and takeback programs come from our commitment to the highest standards for protecting our environment. We believe in providing solutions for you to be able to responsibly recycle our products, batteries, other components as well as the packaging materials. Please go to <https://csr.asus.com/english/Takeback.htm> for detailed recycling information in different regions.



DO NOT throw the motherboard in municipal waste. This product has been designed to enable proper reuse of parts and recycling. This symbol of the crossed out wheeled bin indicates that the product (electrical and electronic equipment) should not be placed in municipal waste. Check local regulations for disposal of electronic products.



DO NOT throw the mercury-containing button cell battery in municipal waste. This symbol of the crossed out wheeled bin indicates that the battery should not be placed in municipal waste.

Japan statement notice

This product cannot be directly connected to the Internet (including public wireless LAN) of a telecom carrier (mobile network companies, landline network companies, Internet providers, etc.). When connecting this product to the Internet, be sure to connect it through a router or switch.

Japan JATE

本製品は電気通信事業者（移動通信会社、固定通信会社、インターネットプロバイダ等）の通信回線（公衆無線LANを含む）に直接接続することができません。本製品をインターネットに接続する場合は、必ずルーター等を経由し接続してください。

Simplified UKCA Declaration of Conformity

ASUSTeK Computer Inc. hereby declares that this device is in compliance with the essential requirements and other relevant provisions of related Regulations. Full text of UKCA declaration of conformity is available at: www.asus.com/support

Simplified EU Declaration of Conformity

English ASUSTeK Computer Inc. hereby declares that this device is in compliance with the essential requirements and other relevant provisions of related Directives. Full text of EU declaration of conformity is available at: www.asus.com/support

Français ASUSTeK Computer Inc. déclare par la présente que cet appareil est conforme aux critères essentiels et autres clauses pertinentes des directives concernées. La déclaration de conformité de l'UE peut être téléchargée à partir du site Internet suivant : www.asus.com/support

Deutsch ASUSTeK Computer Inc. erklärt hiermit, dass dieses Gerät mit den wesentlichen Anforderungen und anderen relevanten Bestimmungen der zugehörigen Richtlinien übereinstimmt. Der gesamte Text der EU-Konformitätserklärung ist verfügbar unter: www.asus.com/support

Italiano ASUSTeK Computer Inc. con la presente dichiara che questo dispositivo è conforme ai requisiti essenziali e alle altre disposizioni pertinenti con le direttive correlate. Il testo completo della dichiarazione di conformità UE è disponibile all'indirizzo: www.asus.com/support

Русский Компания ASUS заявляет, что это устройство соответствует основным требованиям и другим соответствующим условиям соответствующих директив. Подробную информацию, пожалуйста, смотрите на www.asus.com/support

Български С настоящото ASUSTeK Computer Inc. декларира, че това устройство е в съответствие със съществените изисквания и другите приложими постановления на свързаните директиви. Пълният текст на декларацията за съответствие на ЕС е достъпна на адрес: www.asus.com/support

Hrvatski ASUSTeK Computer Inc. ovim izjavljuje da je ovaj uređaj sukladan s bitnim zahtjevima i ostalim odgovarajućim odredbama vezanih direktiva. Cijeli tekst EU izjave o sukladnosti dostupan je na: www.asus.com/support

Čeština Společnost ASUSTeK Computer Inc. tímto prohlašuje, že toto zařízení splňuje základní požadavky a další příslušná ustanovení souvisejících směrnic. Plné znění prohlášení o shodě EU je k dispozici na adrese: www.asus.com/support

Dansk ASUSTeK Computer Inc. erklærer hermed, at denne enhed er i overensstemmelse med hovedkravene og andre relevante bestemmelser i de relaterede direktiver. Hele EU-overensstemmelseserklæringen kan findes på: www.asus.com/support

Nederlands ASUSTeK Computer Inc. verklaart hierbij dat dit apparaat voldoet aan de essentiële vereisten en andere relevante bepalingen van de verwante richtlijnen. De volledige tekst van de EU-verklaring van conformiteit is beschikbaar op: www.asus.com/support

Eesti Käesolevaga kinnitab ASUSTeK Computer Inc, et see seade vastab asjakohaste direktiivide oluliste nõuetele ja teistele asjassepuutuvatele sätetele. EL vastavusdeklaratsiooni täielik tekst on saadaval järgmisel aadressil: www.asus.com/support

Suomi ASUSTeK Computer Inc. ilmoittaa täten, että tämä laite on asiaankuuluvien direktiivien olennaisten vaatimusten ja muiden tätä koskevien säädösten mukainen. EU-yhdenmukaisuusilmoituksen koko teksti on luettavissa osoitteessa: www.asus.com/support

Ελληνικά Με το παρόν, η AsusTek Computer Inc. δηλώνει ότι αυτή η συσκευή συμμορφώνεται με τις θεμελιώδεις απαιτήσεις και άλλες σχετικές διατάξεις των Οδηγίων της ΕΕ. Το πλήρες κείμενο της δηλώσης συμβατότητας είναι διαθέσιμο στη διεύθυνση: www.asus.com/support

Magyar Az ASUSTeK Computer Inc. ezennel kijelenti, hogy ez az eszköz megfelel a kapcsolódó Irányelvek lényeges követelményeinek és egyéb vonatkozó rendelkezéseinek. Az EU megfeleléségi nyilatkozat teljes szövege innen letölthető: www.asus.com/support

Latviski ASUSTeK Computer Inc. ar šo paziņo, ka šī ierīce atbilst saistīto Direktīvu būtiskajām prasībām un citiem citiem saistošajiem nosacījumiem. Pilns ES atbilstības paziņojuma teksts pieejams šeit: www.asus.com/support

Lietuvių „ASUSTeK Computer Inc.“ šiuo tvirtina, kad šis įrenginys atitinka pagrindinius reikalavimus ir kitas svarbias susijusių direktyvų nuostatas. Visą ES atitikties deklaracijos tekstą galima rasti: www.asus.com/support

Norsk ASUSTeK Computer Inc. erklærer herved at denne enheten er i samsvar med hovedsaklige krav og andre relevante forskrifter i relaterte direktiver. Fullstendig tekst for EU-samsvarserklæringen finnes på: www.asus.com/support

Polski Firma ASUSTeK Computer Inc. niniejszym oświadcza, że urządzenie to jest zgodne z zasadniczymi wymogami i innymi właściwymi postanowieniami powiązanych dyrektyw. Pełny tekst deklaracji zgodności UE jest dostępny pod adresem: www.asus.com/support

Português A ASUSTeK Computer Inc. declara que este dispositivo está em conformidade com os requisitos essenciais e outras disposições relevantes das Diretivas relacionadas. Texto integral da declaração da UE disponível em: www.asus.com/support

Română ASUSTeK Computer Inc. declară că acest dispozitiv se conformează cerințelor esențiale și altor prevederi relevante ale directivei conexe. Textul complet al declarației de conformitate a Uniunii Europene se găsește la: www.asus.com/support

Srpski ASUSTeK Computer Inc. ovim izjavljuje da je ovaj uređaj u saglasnosti sa osnovnim zahtevima i drugim relevantnim odredbama povezanih Direktiva. Pun tekst EU deklaracije o usaglašenosti je dostupan da adresi: www.asus.com/support

Slovensky Spoločnosť ASUSTeK Computer Inc. týmto vyhlasuje, že toto zariadenie vyhovuje základným požiadavkám a ostatým príslušným ustanoveniam príslušných smerníc. Celý text vyhlásenia o zhode pre štáty EÚ je dostupný na adrese: www.asus.com/support

Slovenščina ASUSTeK Computer Inc. izjavlja, da je ta naprava skladna z bistvenimi zahtevami in drugimi ustreznimi določbami povezanih direktiv. Celotno besedilo EU-izjave o skladnosti je na voljo na spletnem mestu: www.asus.com/support

Español Por la presente, ASUSTeK Computer Inc. declara que este dispositivo cumple los requisitos básicos y otras disposiciones pertinentes de las directivas relacionadas. El texto completo de la declaración de la UE de conformidad está disponible en: www.asus.com/support

Svenska ASUSTeK Computer Inc. förklarar härmed att denna enhet överensstämmer med de grundläggande kraven och andra relevanta föreskrifter i relaterade direktiv. Fulltext av EU-försäkran om överensstämmelse finns på: www.asus.com/support

Українська ASUSTeK Computer Inc. заявляє, що цей пристрій відповідає основним вимогам та іншим відповідним положенням відповідних Директив. Повний текст декларації відповідності стандартам ЄС доступний на: www.asus.com/support

Türkçe AsusTek Computer Inc., bu aygıtın temel gereksinimlerle ve ilişkili Yönergelerin diğer ilgili koşullarıyla uyumlu olduğunu beyan eder. AB uygunluk bildiriminin tam metni şu adreste bulunabilir: www.asus.com/support

Bosanski ASUSTeK Computer Inc. ovim izjavljuje da je ovaj uređaj usklađen sa bitnim zahtjevima i ostalim odgovarajućim odredbama vezanih direktiva. Cijeli tekst EU izjave o usklađenosti dostupan je na: www.asus.com/support

Service and Support

Visit our multi-language website at <https://www.asus.com/support>.



