

TeamJoin TRS10 for Microsoft Teams Rooms MPC310-W31-TU

Conferencing PC

MRC1010-TN

Touch Console

User Guide

IMPORTANT: Please read this User Guide to obtain important information on installing and using your product in a safe manner, as well as registering your product for future service. Warranty information contained in this User Guide will describe your limited coverage from ViewSonic® Corporation, which is also found on our web site at <http://www.viewsonic.com> in English, or in specific languages using the Regional selection box of our website.

Model No. VS19796 | VS19799

P/N: MPC310-W31-TU | MPC510-W53-TU | MPC710-W75-TU | MRC1010-TN

Thank you for choosing ViewSonic®

As a world-leading provider of visual solutions, ViewSonic® is dedicated to exceeding the world's expectations for technological evolution, innovation, and simplicity. At ViewSonic®, we believe that our products have the potential to make a positive impact in the world, and we are confident that the ViewSonic® product you have chosen will serve you well.

Once again, thank you for choosing ViewSonic®!

Contents







Introduction	5
Package Contents	5
Conferencing PC.....	5
Touch Console	6
Product Overview	7
Conferencing PC.....	7
Touch Console	8
Initial Setup.....	9
Installing the Conferencing PC.....	9
Making Connections	11
Connecting to the Conferencing PC.....	11
Cable Management.....	11
Connecting to the Touch Console.....	12
Cable Management	12
Getting Started.....	13
Prerequisites.....	13
Required License for Microsoft Teams Room	13
Required Resource Account for Microsoft Teams Rooms.....	13
Microsoft Teams Rooms (MTR) Setup Wizard.....	14
Microsoft Teams Rooms (MTR) Account Setup	17
Touch Console	19
Home Screen	19
PIR Sensor Setup	20
“Wake on Active IFP Display” Settings	22
IFP33 Series - IFP62 Series - IFP105	23
CDE30 Series.....	23
IFPG1 Series.....	24
Calibrate the Display for Pen or Touch.....	25

SKU Overview.....	28
Conference Room Type	29
Appendix.....	31
Specifications.....	31
MPC310-W31-TU	31
MRC1010-TN	33
Troubleshooting	34
Regulatory and Service Information	37
Compliance Information.....	37
FCC Compliance Statement.....	37
FCC Radiation Exposure Statement.....	38
Industry Canada Statement.....	38
Country Code Statement.....	38
IC Radiation Exposure Statement.....	39
CE Conformity for European Countries	40
BSMI /NCC Statement	41
Declaration of RoHS2 Compliance.....	42
Indian Restriction of Hazardous Substances	43
Product Disposal at End of Product Life	43
Copyright Information	44
Customer Service	45

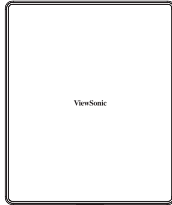
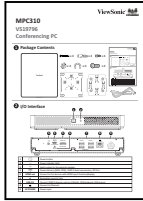
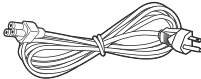
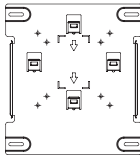
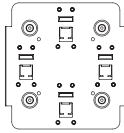
Introduction



Package Contents

Conferencing PC

	Item	Quantity
Conferencing PC (MPC310-W31-TU)		1
Quick Start Guide		1
Power Cord (1.8 m)		1
VESA Mounting Bracket (PC side)		1
VESA Mounting Bracket (Wall/Table/Trolley side)		1
Anchor Screw T4 x 20 mm		4
Anchor Ø6.0 x 25 mm (for Wall/Table)		4
Bracket Screw M3 x 6 mm		4
E-type Circlip Ø8		4
Hex Nuts M4 x 4 mm		4
Screw M4 x 6 mm		4

NOTE: If anything is missing or damaged, please contact your local reseller for more information.

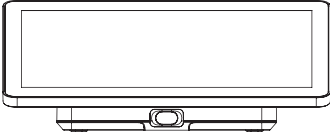
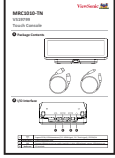
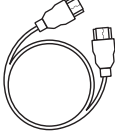
Touch Console





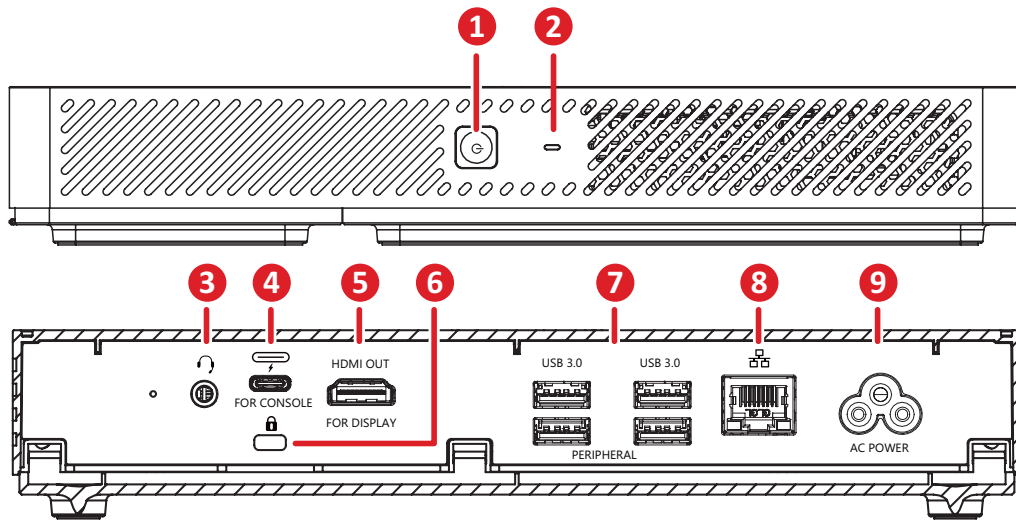

	Item	Quantity
Touch Console (MRC1010-TN)		1
Quick Start Guide		1
HDMI Cable (1.5 m)		1
USB Type C Cable (5 m)		1

NOTE: If anything is missing or damaged, please contact your local reseller for more information.

Product Overview

Conferencing PC



Item		Description
1		Power button.
2		Power indicator light.
3		Audio output to an external audio device.
4		<ul style="list-style-type: none"> • DP Out • USB 3.0 data transmission • Power delivery (Maximum: 20W)
5	HDMI OUT	Connection port for displays with HDMI input support.
6		Security lock.
7	USB 3.0	Connection for USB peripheral device(s) (e.g., storage device, keyboard, mouse, etc.).
8		Ethernet connection.
9	AC POWER	Power input socket.

Touch Console

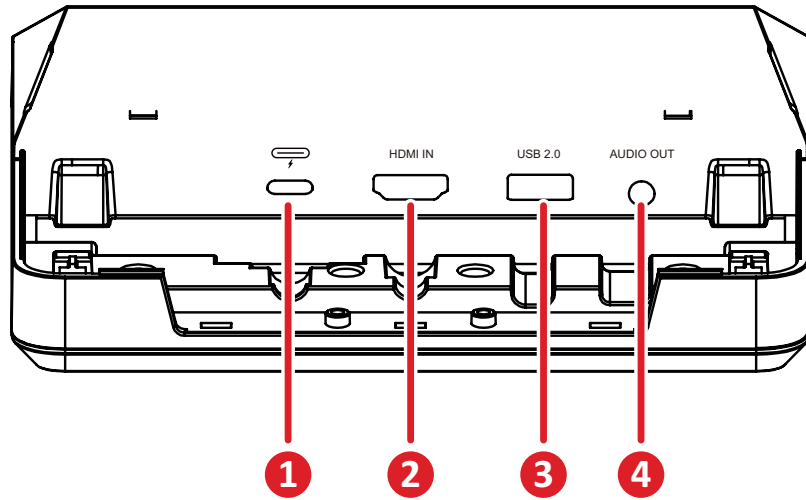

Item		Description
1		<ul style="list-style-type: none">• DP In• USB downstream (3.0: HDMI signal; 2.0: Touch signal)• Power delivery 20V/1A
2	HDMI IN	Supports 4K @ 30 Hz input.
3	USB 2.0	Connection for USB peripheral device(s) (e.g., storage device, keyboard, mouse, etc.).
4	AUDIO OUT	Audio output to an external audio device.

Initial Setup

Installing the Conferencing PC

With the included VESA Mounting Bracket set, the Conferencing PC can be attached to a wall, table, or trolley.

Installing the VESA Mounting Bracket (PC Side) onto the Conferencing PC

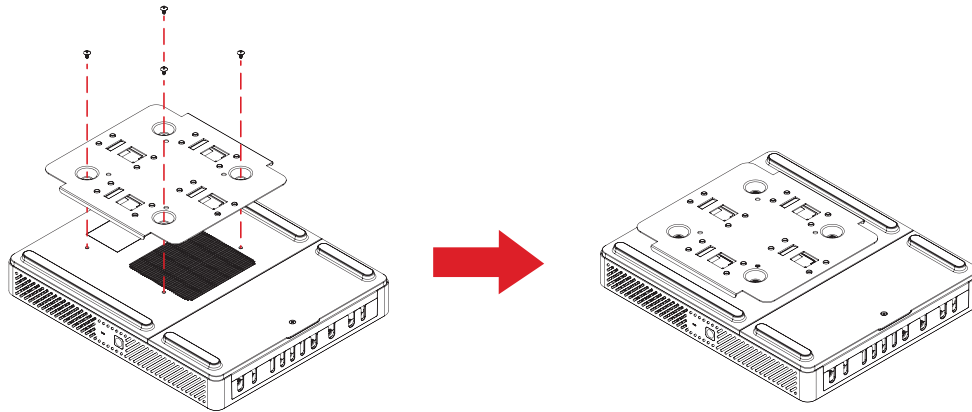

Attach the VESA Mounting Bracket (PC Side) to the Conferencing PC with four Bracket Screws (M3 x 6 mm).

Installing the VESA Mounting Bracket (Wall/Table/Trolley Side) and Conferencing PC

Wall Mounting

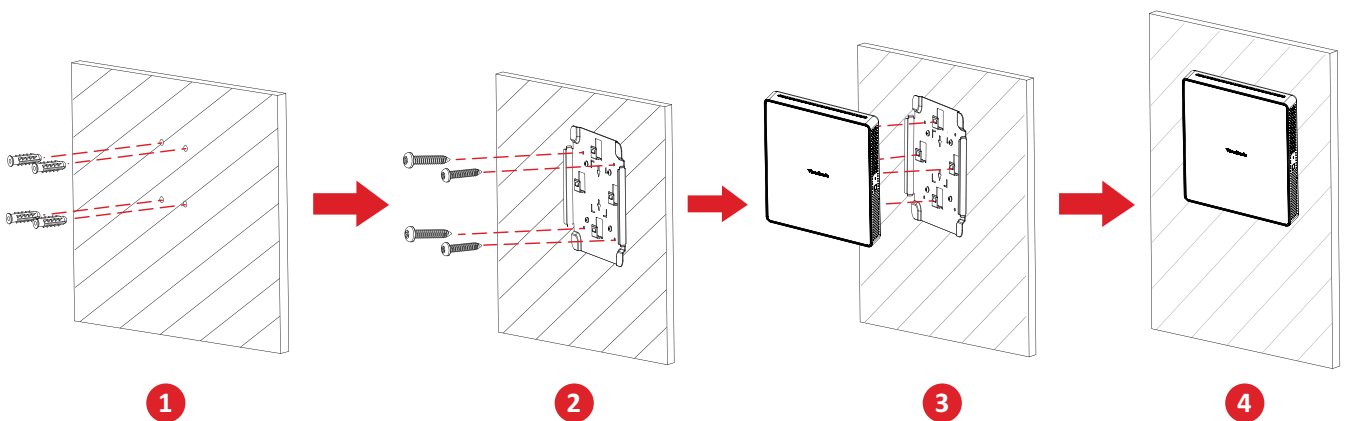

1. Pre-drill four holes into the wall and install four Anchors ($\text{Ø}6.0 \times 25 \text{ mm}$).
2. Align the VESA Mounting Bracket (Wall/Table/Trolley Side) with the four Anchors, then secure the VESA Mounting Bracket with four Anchor Screws (T4 x 20 mm).
3. Attach the Conferencing PC to the VESA Mounting Bracket.

Table Mounting

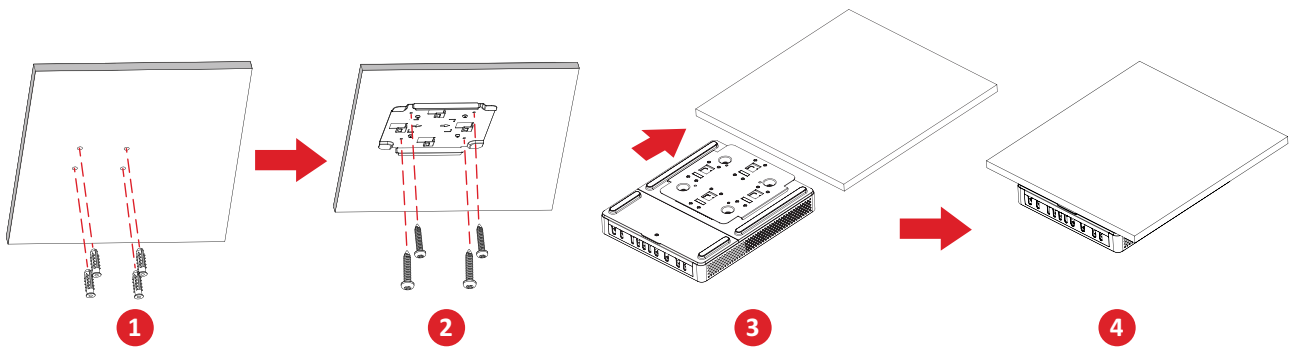

1. Pre-drill four holes into the table and install four Anchors ($\varnothing 6.0 \times 25$ mm).
2. Align the VESA Mounting Bracket (Wall/Table/Trolley Side) with the four Anchors, then secure the VESA Mounting Bracket with four Anchor Screws (T4 x 20 mm).
3. Attach the Conferencing PC to the VESA Mounting Bracket.

Trolley Mounting

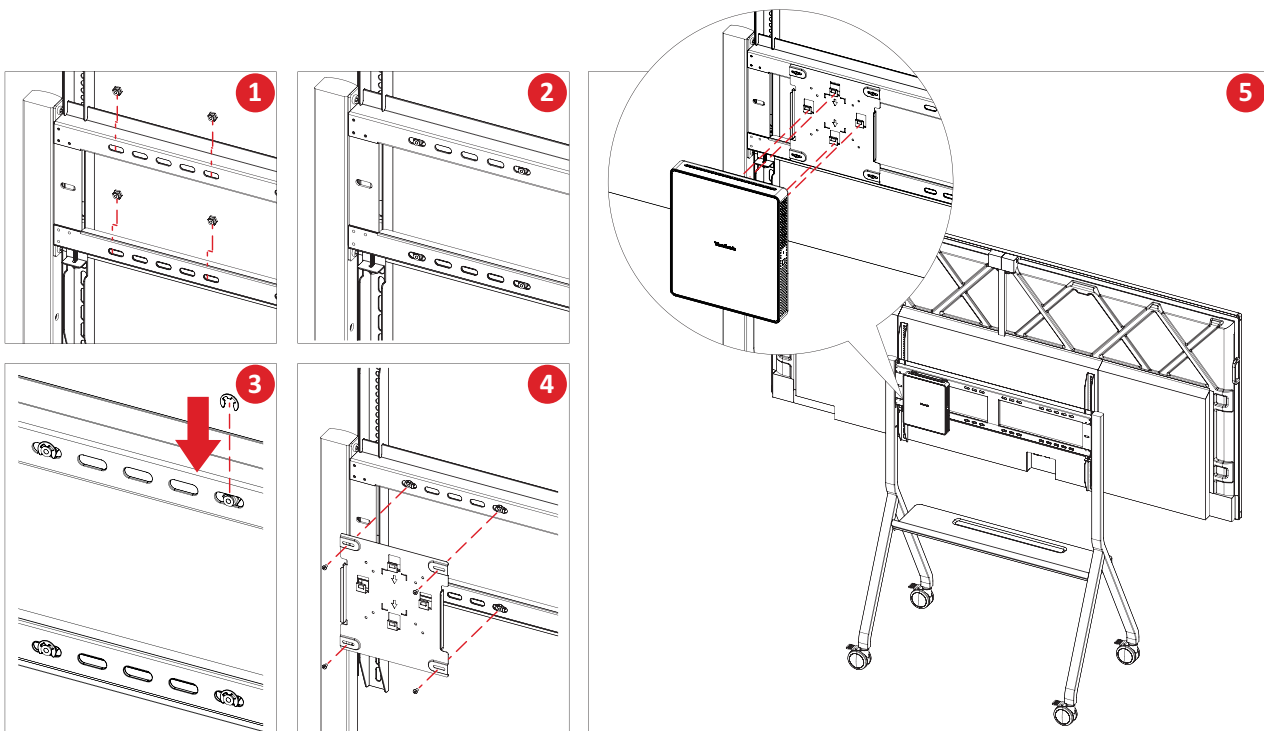

1. Select the installation location on the trolley and make sure the space is appropriate for the Conferencing PC.
2. Install four Hex Nuts into the oval holes of the trolley.
3. Secure the Hex Nuts with four E-type Circlips ($\varnothing 8$).
4. Align the VESA Mounting Bracket (Wall/Table/Trolley Side) with the four Hex Nuts, then secure the VESA Mounting Bracket with four Screws (M4 x 6 mm).
5. Attach the Conferencing PC to the VESA Mounting Bracket.

Making Connections

Connecting to the Conferencing PC

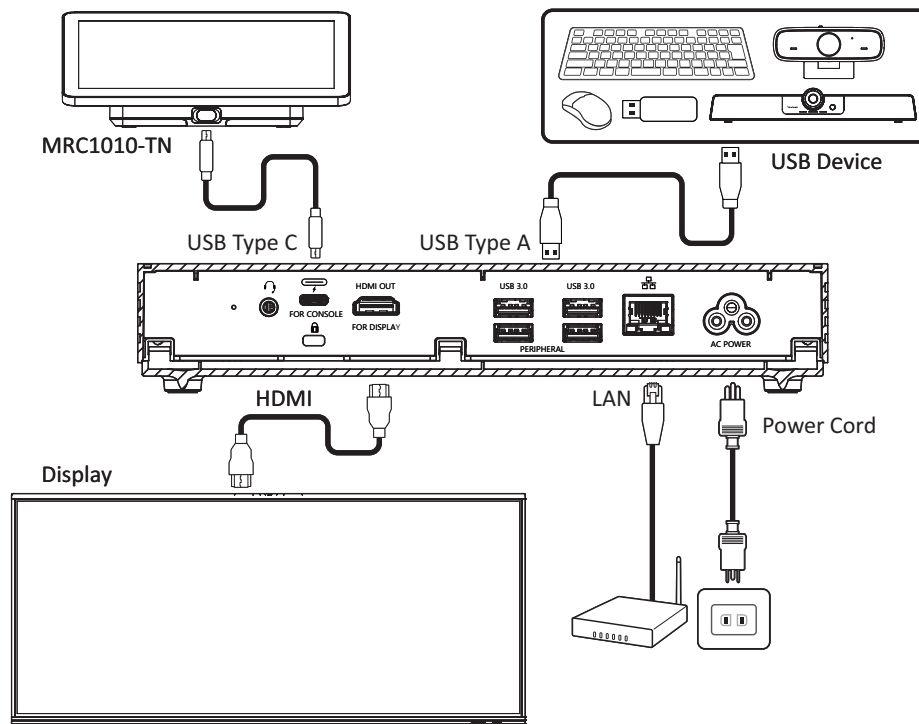

Cable Management

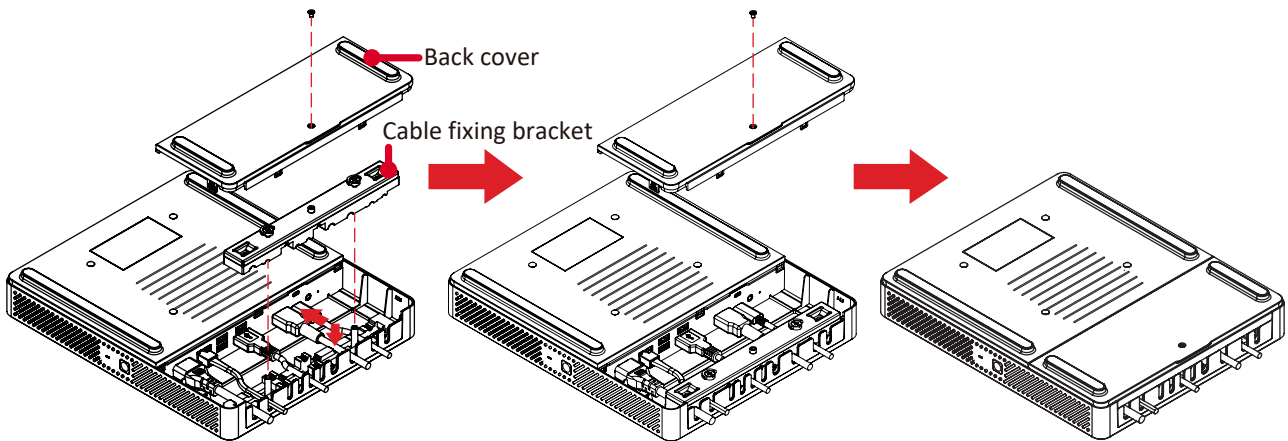

1. Remove the back cover of the Conferencing PC and cable fixing bracket by removing the screws.
2. Connect any necessary cables to the I/O ports of the Conferencing PC and direct the cables through the cable channels.
3. Replace the cable fixing bracket and back cover of the Conferencing PC with the previously removed screws.

Connecting to the Touch Console

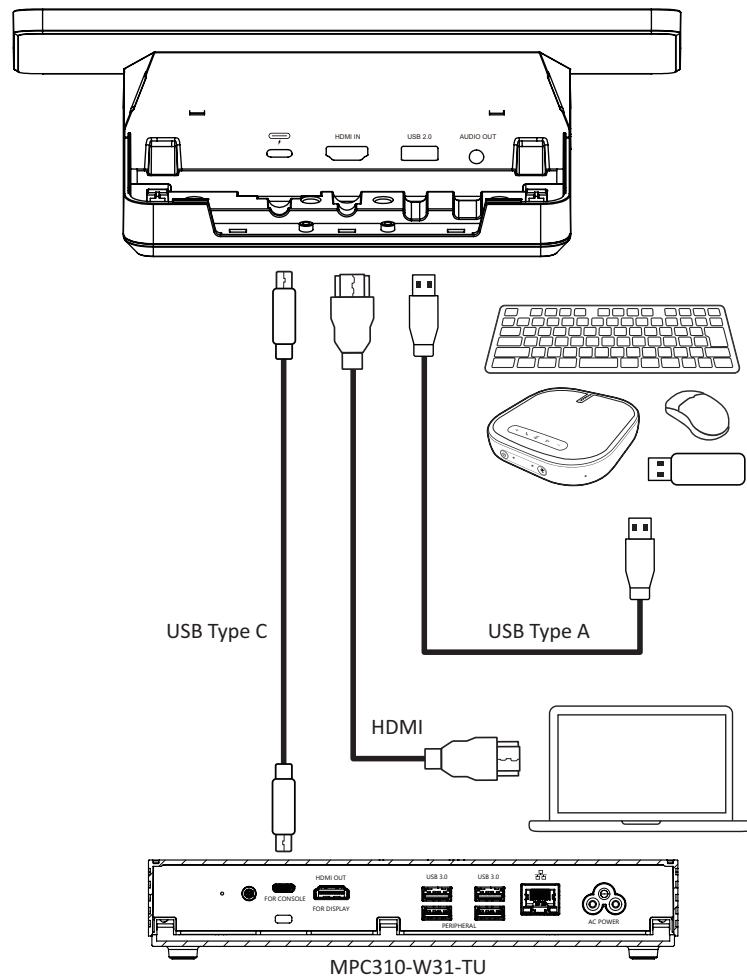

Cable Management

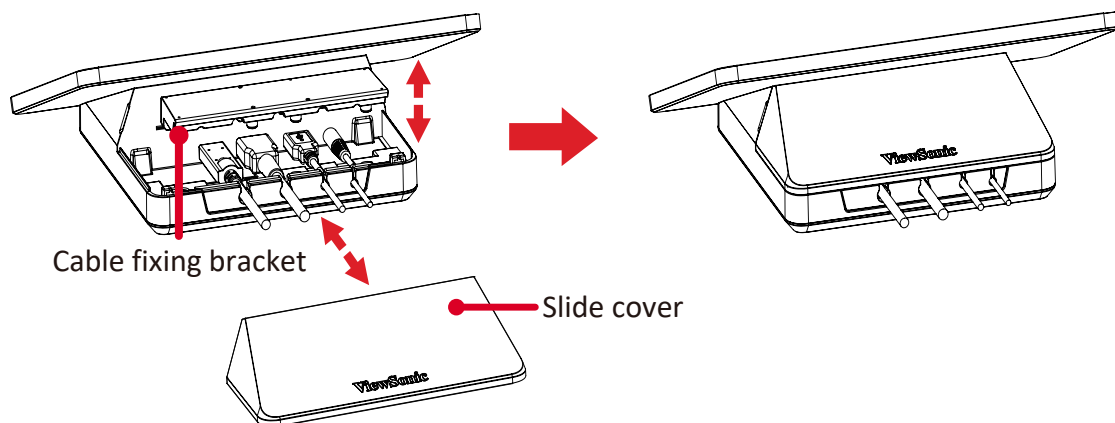

1. Remove the slide cover and of the Touch Console and cable fixing bracket.
2. Connect any necessary cables to the I/O ports of the Touch Console and direct the cables through the cable channels.
3. Replace the cable fixing bracket and slide cover of the Touch Console.

Getting Started

Prerequisites

Required License for Microsoft Teams Room

You will need a Microsoft Teams Rooms license to set up your MTR Room System. To learn more about the required licenses, refer to the Microsoft Teams documentation: [Microsoft Teams Rooms licenses](#)

Required Resource Account for Microsoft Teams Rooms

To set up your Microsoft Teams Rooms system, you will also need a Microsoft Teams Rooms account. For information on setting up this account, refer to the Microsoft Teams documentation: [Create and configure resource accounts for rooms and shared Teams devices](#)

Microsoft Teams Rooms (MTR) Setup Wizard

1. Select language.

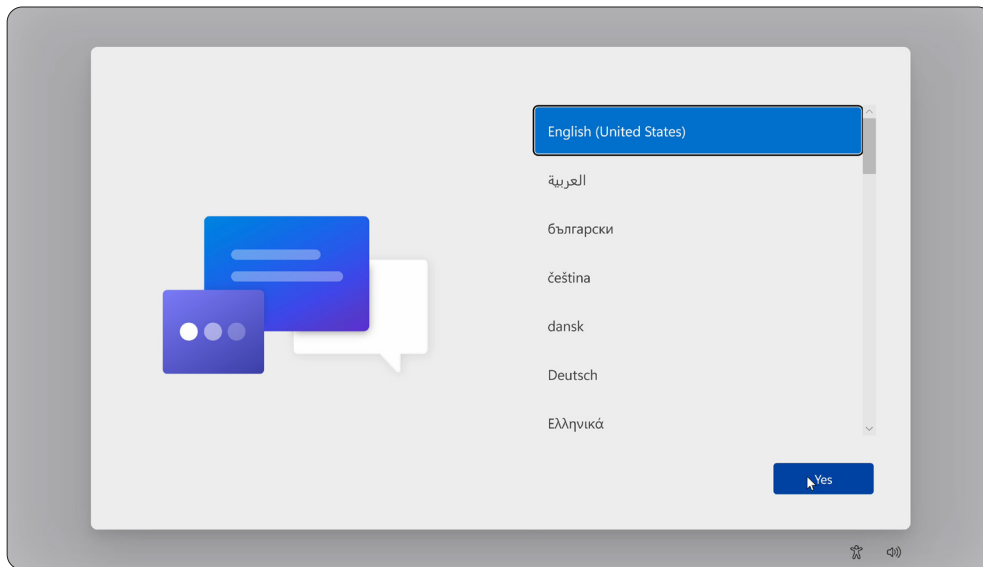

2. Select country or region.

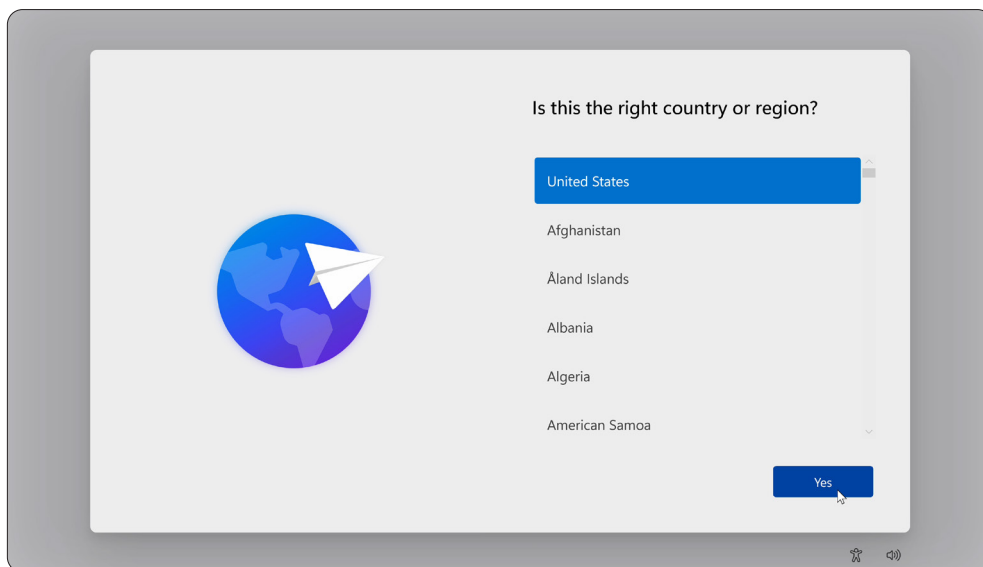

3. Select keyboard layout.

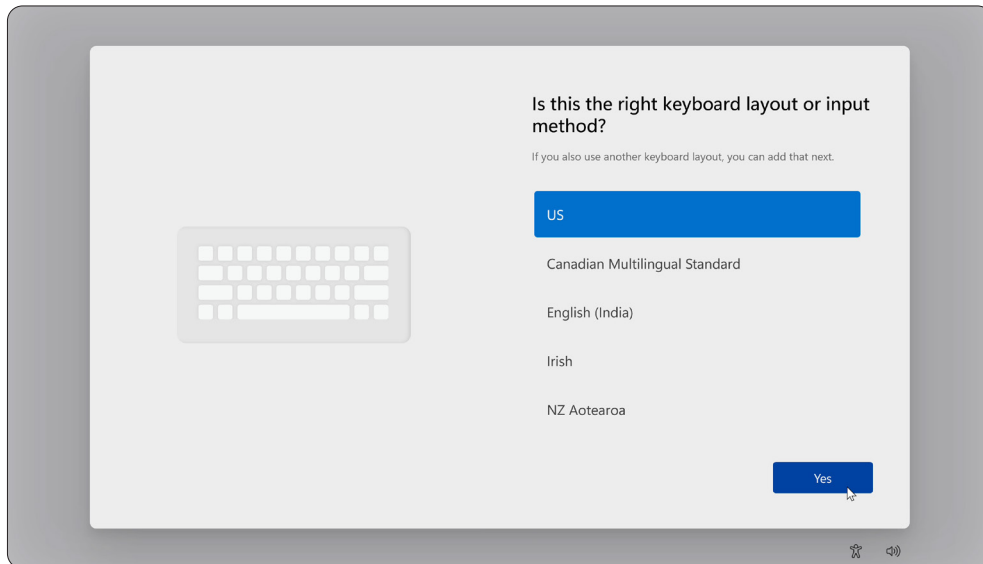

4. Add a second keyboard layout.

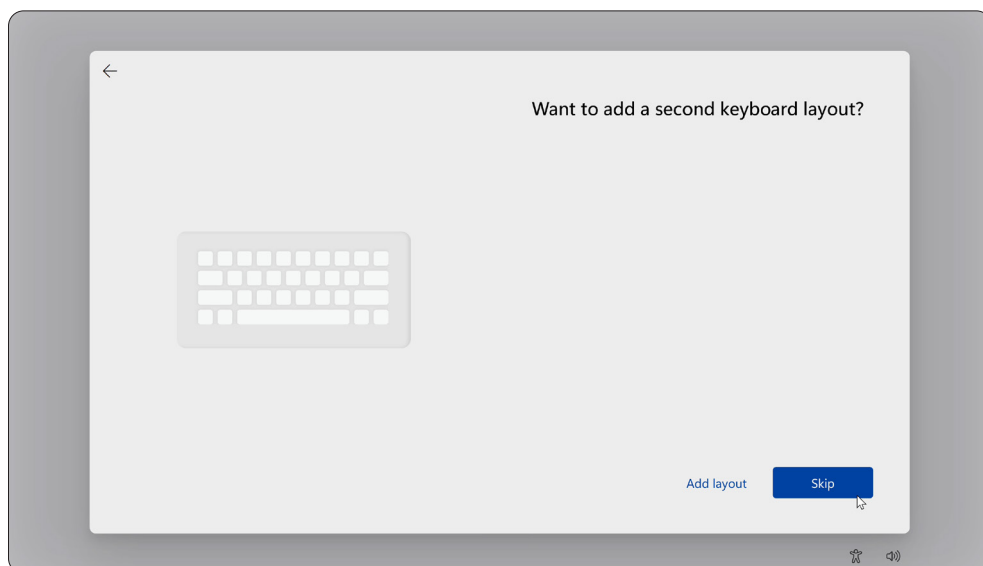

5. Connect to a network.

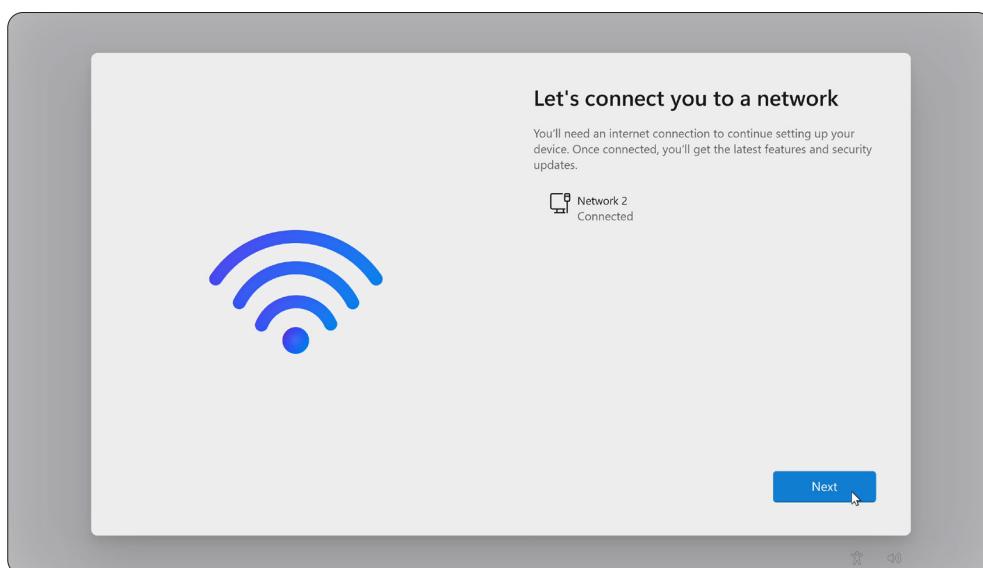

6. Check for any updates and finish setting up.

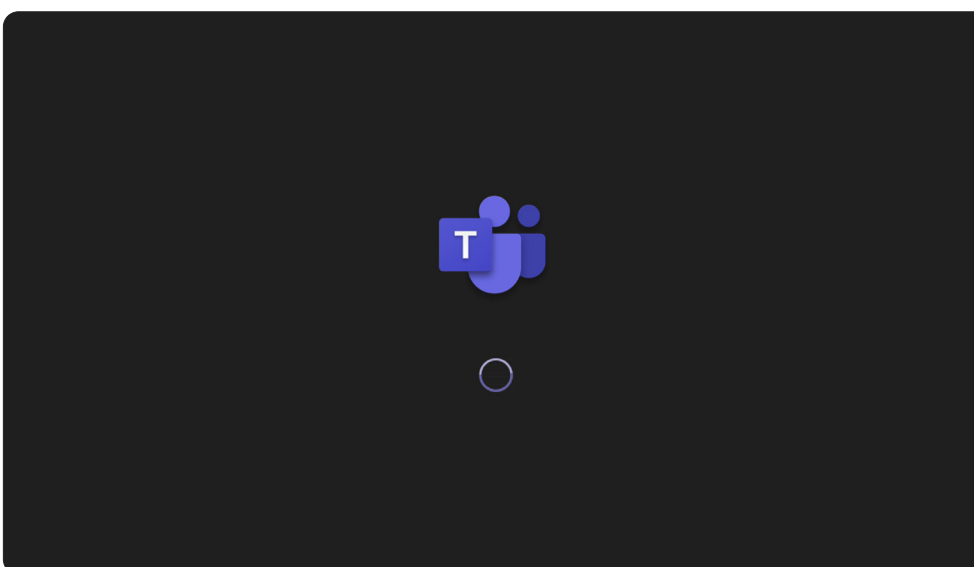
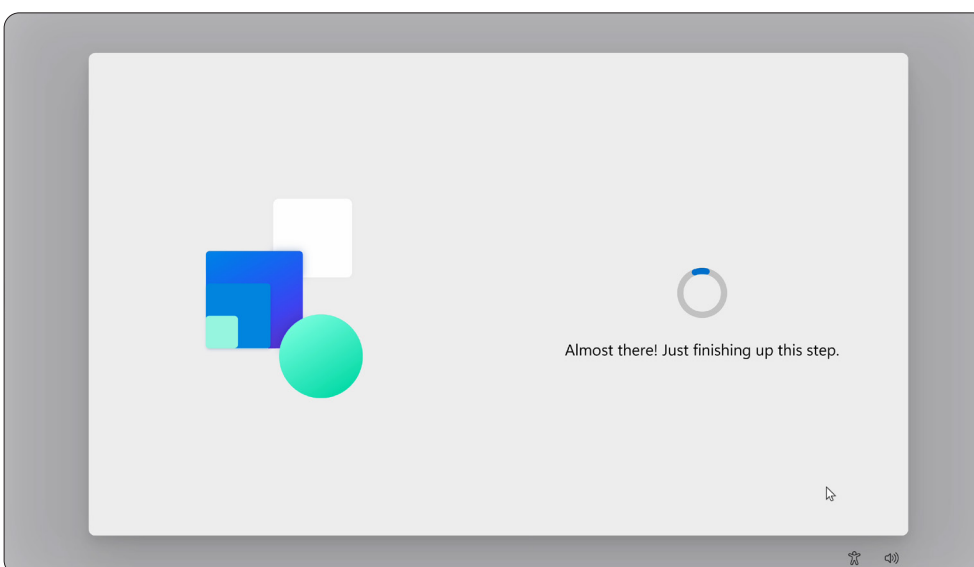
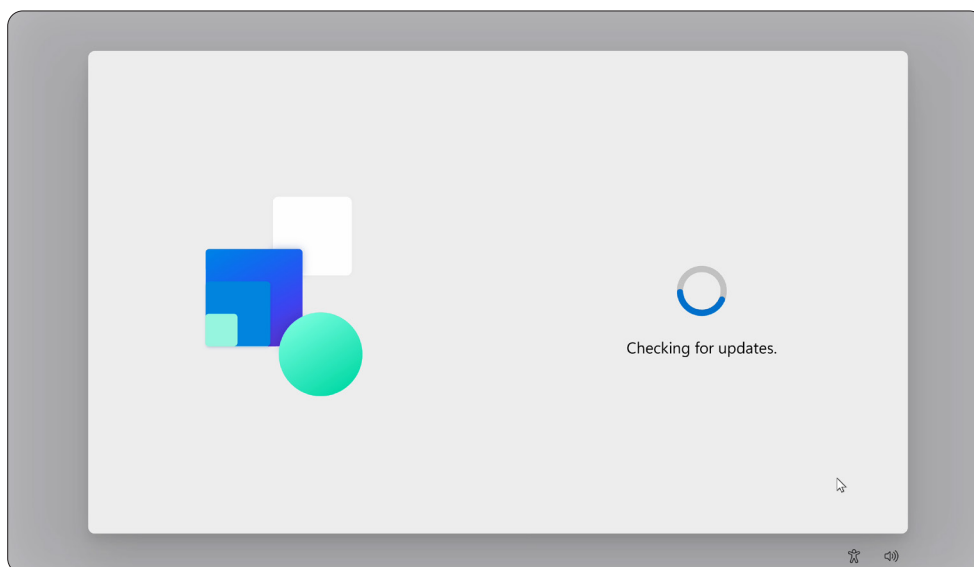

Microsoft Teams Rooms (MTR) Account Setup

1. To setup a Microsoft Teams Rooms account, review the End user agreement and select **Accept**.

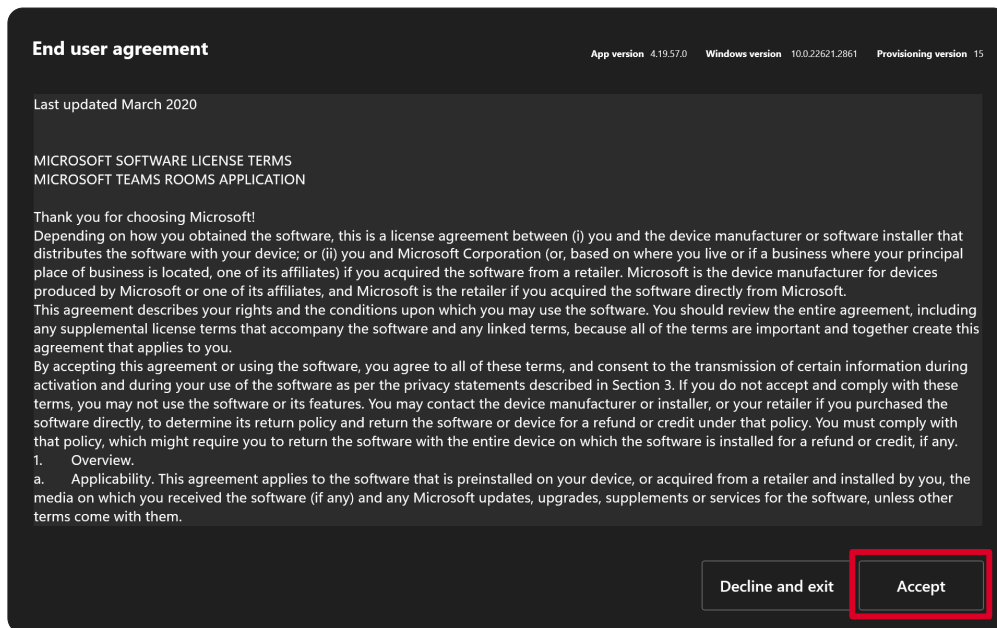

2. Select **Manual setup**.

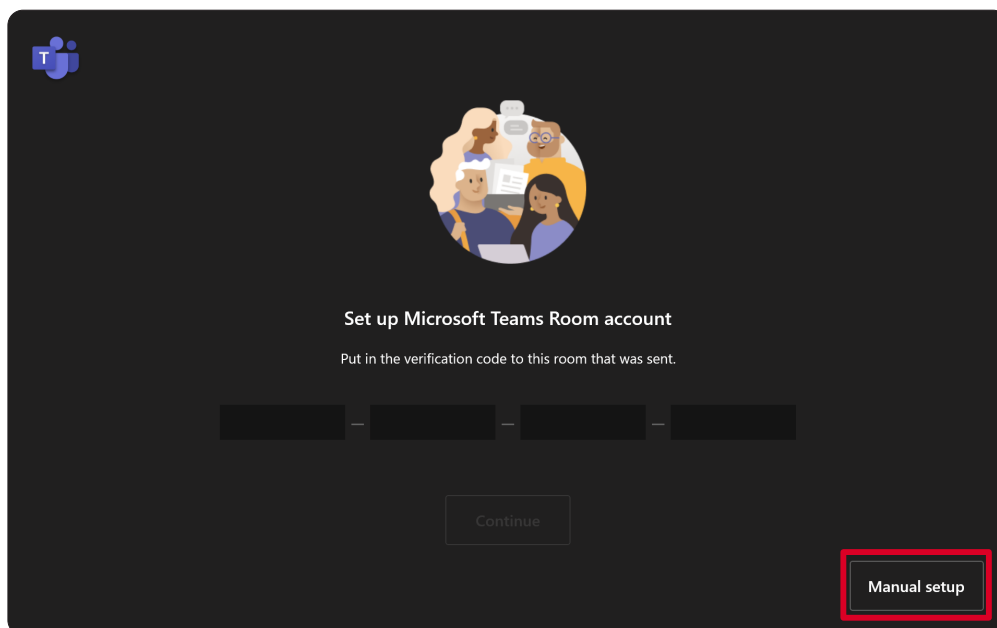

3. Enter the account email and password, then select **Finish**.

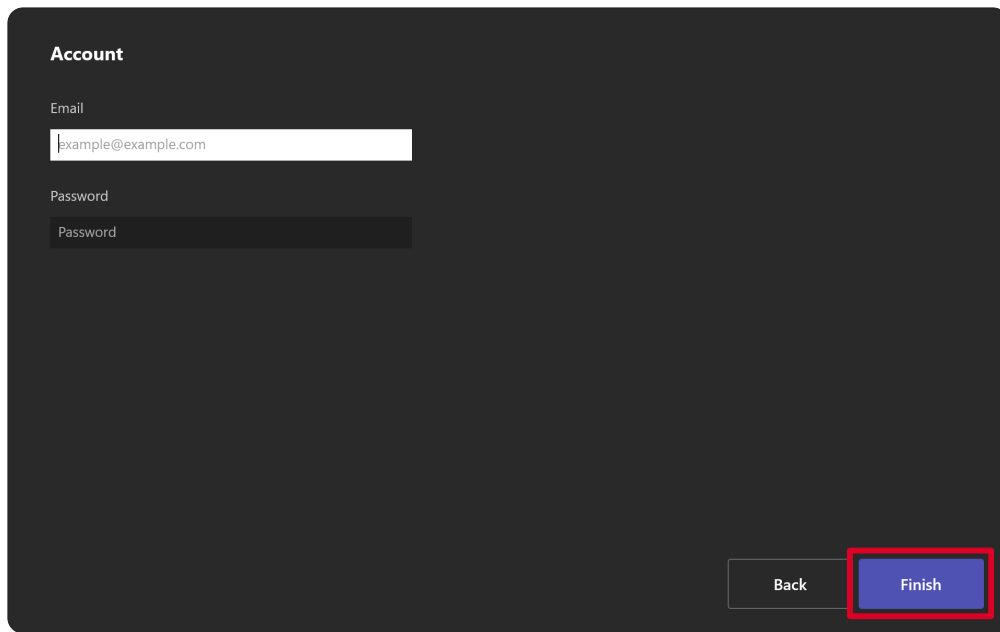







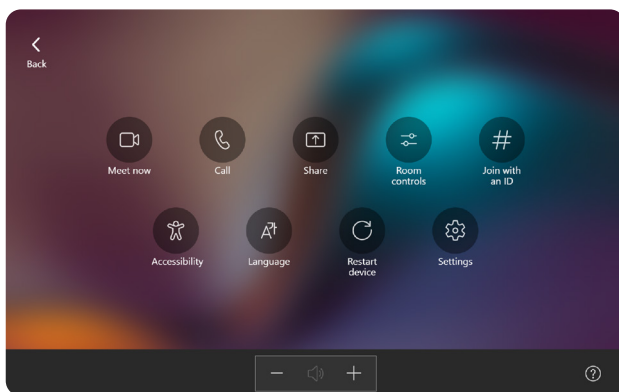
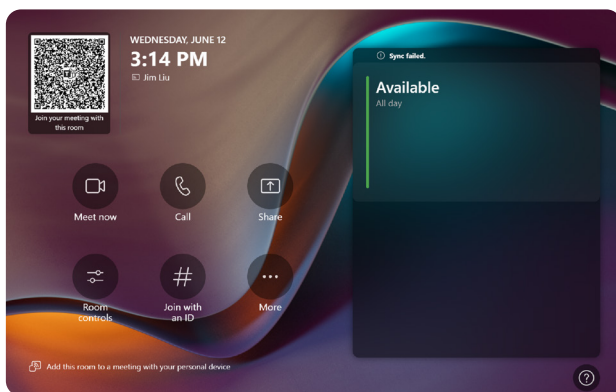

The image shows a dark-themed 'Account' login form. At the top left, the word 'Account' is written in white. Below it, there are two input fields: 'Email' containing 'example@example.com' and 'Password' which is currently empty. At the bottom right, there are two buttons: a light gray 'Back' button and a blue 'Finish' button. The 'Finish' button is highlighted with a red rectangular border.

Touch Console

Home Screen



Icon	Description
	<u>Meet now</u> Start a new meeting.
	<u>Call</u> Make a phone call.
	<u>Share</u> Project your laptop by plugging in the cable connected to the console. Depending on the room settings, it may be projected to the room automatically, or you may have to select Share on the Touch Console. You can also cast content onto the room display from your desktop or mobile device .
	<u>Join with an ID</u> Join a meeting that is not on the calendar.
	<u>More</u> View more options like adding a room, setting adjustment, etc.
	<u>Accessibility</u> See accessibility options.
	<u>Restart device</u> Restart the Touch Console.
	<u>Settings</u> Change the Touch Console settings.
	<u>Room controls</u> Switch to an OEM-provided application for in-room media or room lighting and/or blind controls. This option is available when configured by your administration.

NOTE: For more information on features see [Microsoft Teams Rooms \(Windows\)](#) and [Get Started with Chat in Microsoft Teams](#).

PIR Sensor Setup

1. On the Touch Console, select **More** and then **Settings**.

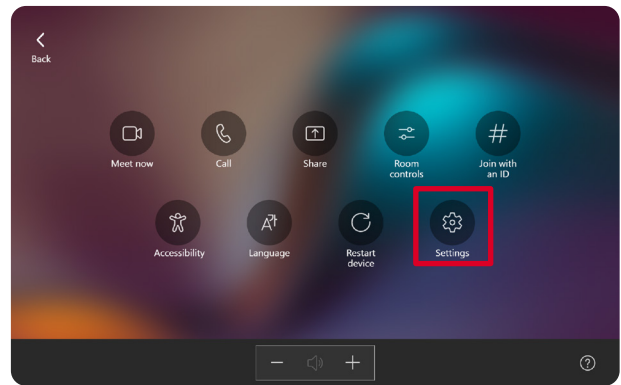
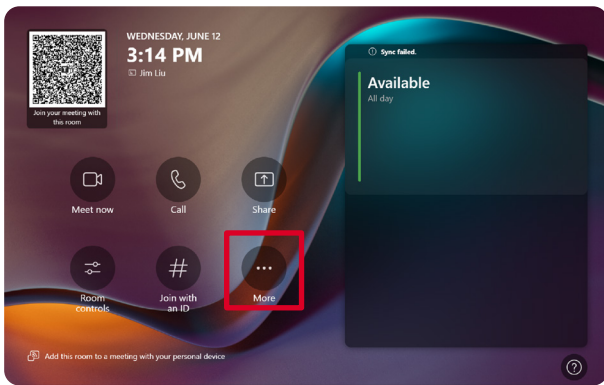

2. Enter the Administrator password “sfb” and select **Windows Settings** and **Go to Admin Sign-in**.

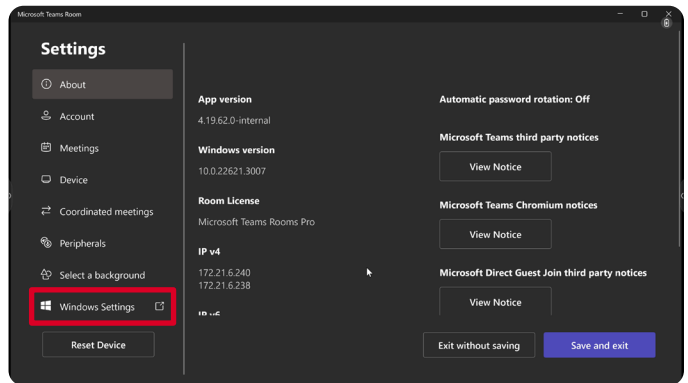
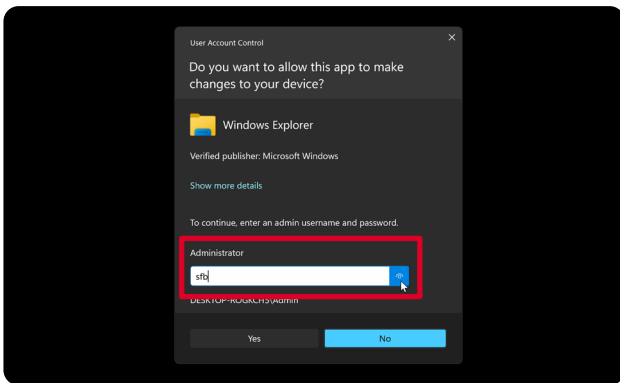

3. The MTR computer will log out of MTR and the Windows 11 login screen will be presented. Select the Administrator account and enter the password “sfb”.

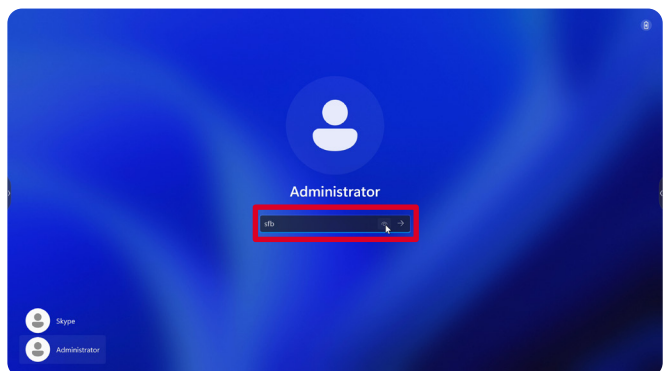
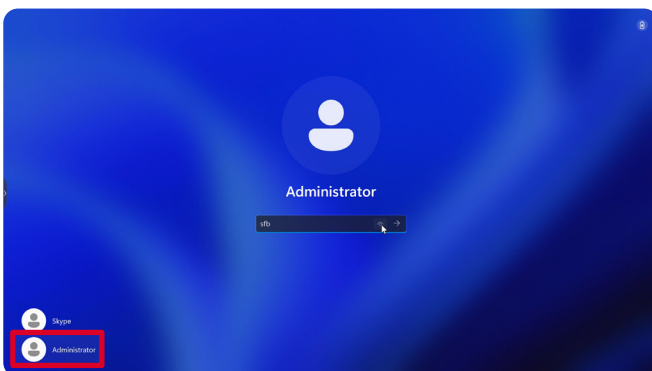

4. In the Search Box on the Windows Task Bar, search for and open Device Manager.

5. In Device Manager, select: **Sensors > HID Human Presence Sensor Properties > Power Management**.

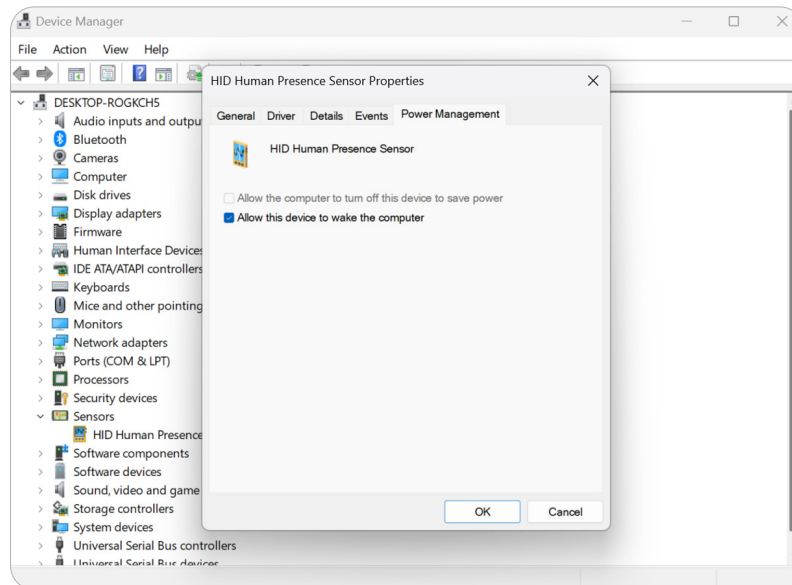

6. Select the checkbox next to **Allow this device to wake the computer**.

“Wake on Active IFP Display” Settings

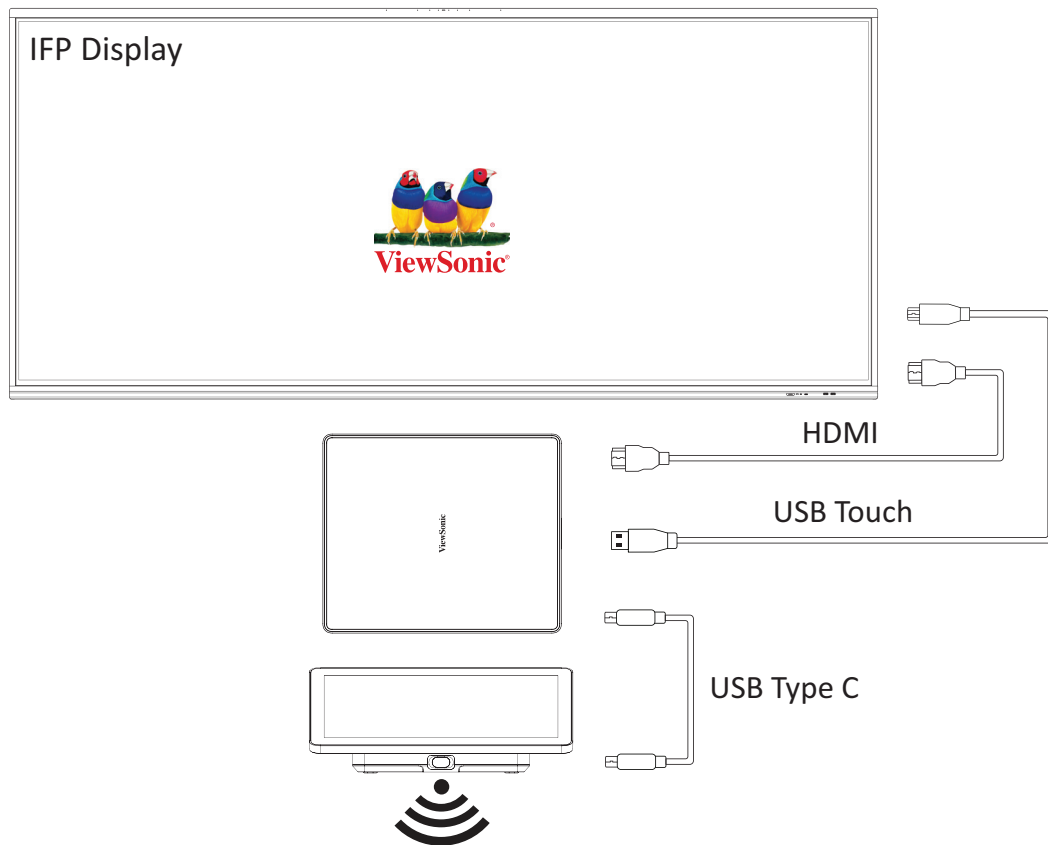

Please follow the guidelines below to wake up the IFP display from standby mode to active mode when the MTR PIR sensor makes a detection:

- Before adjusting the IFP display settings, make sure the [PIR Sensor Setup](#) is complete as this allows the device to wake the computer.
- Refer to the following examples of Startup & Shutdown/Power Save settings of the IFP /CDE series.

IFP33 Series - IFP62 Series - IFP105

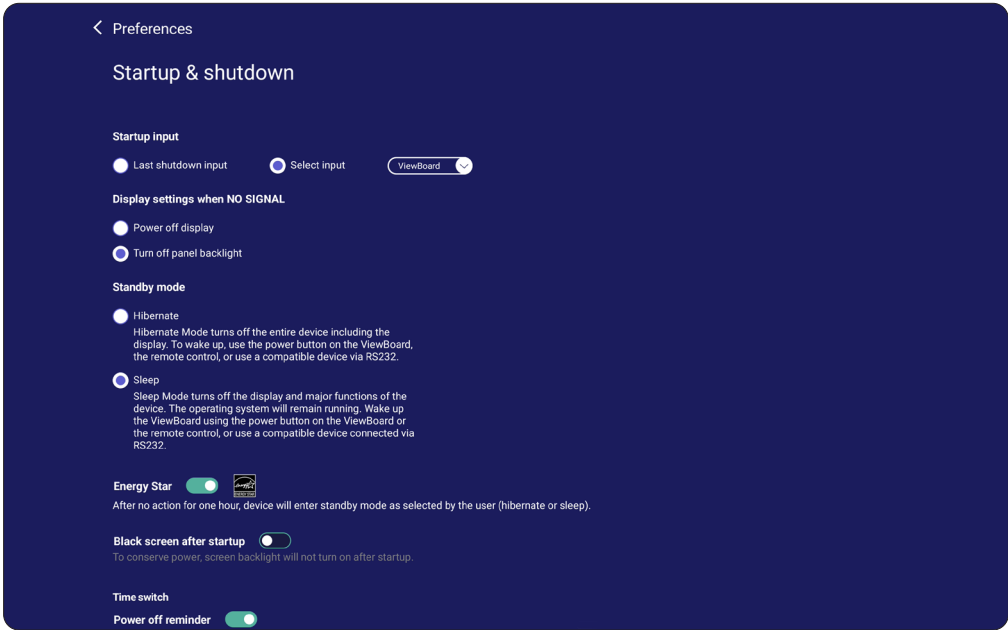

CDE30 Series

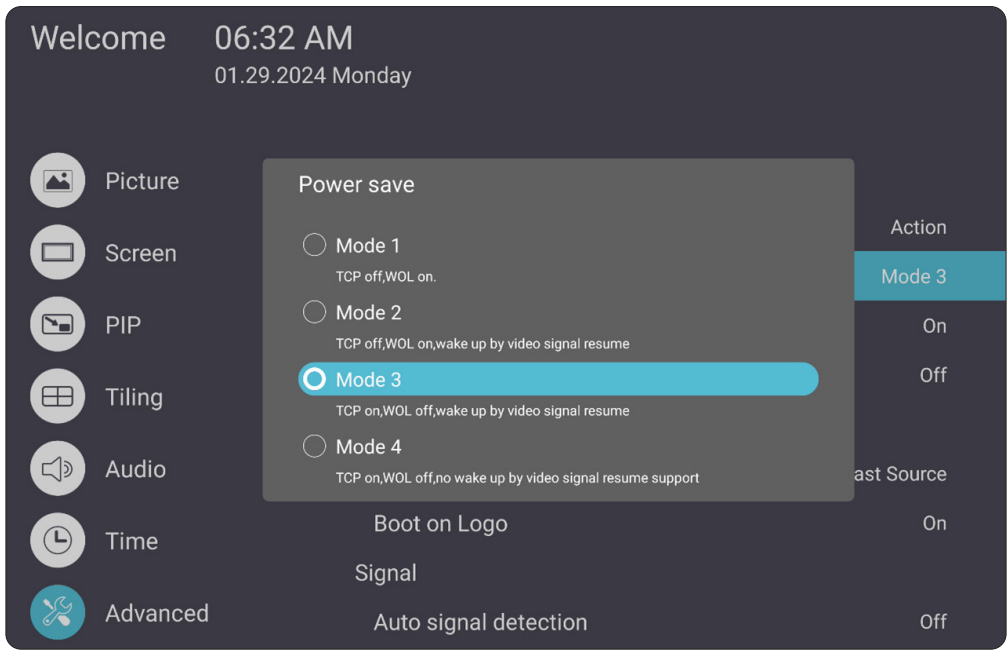

IFPG1 Series

Power Save: Mode3 TCP on, WOL off, wake up by video signal resume.



NOTE: MTR sleep mode time settings.

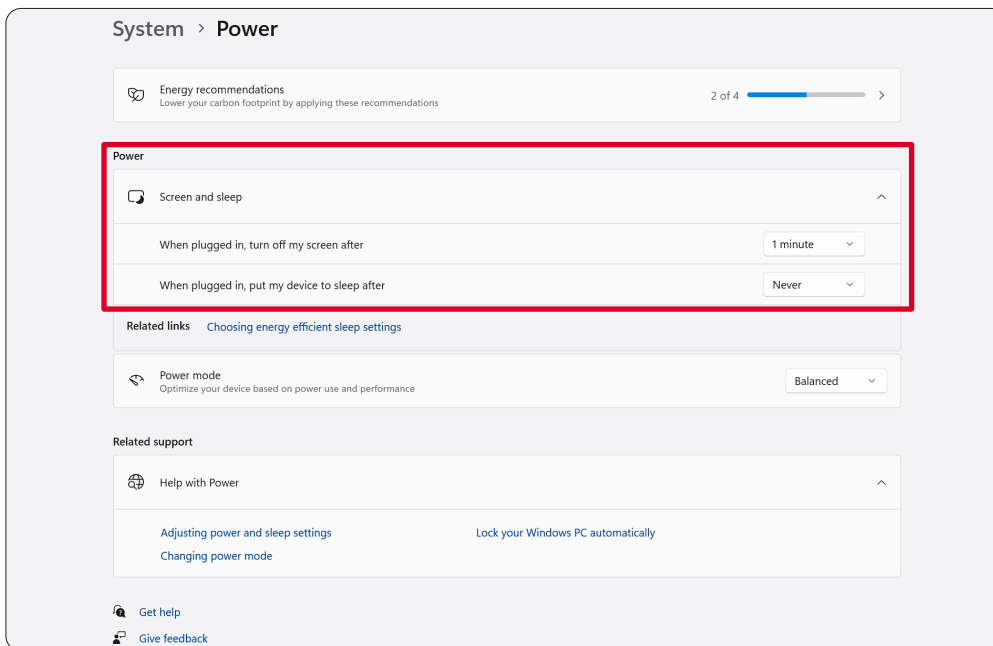

Calibrate the Display for Pen or Touch

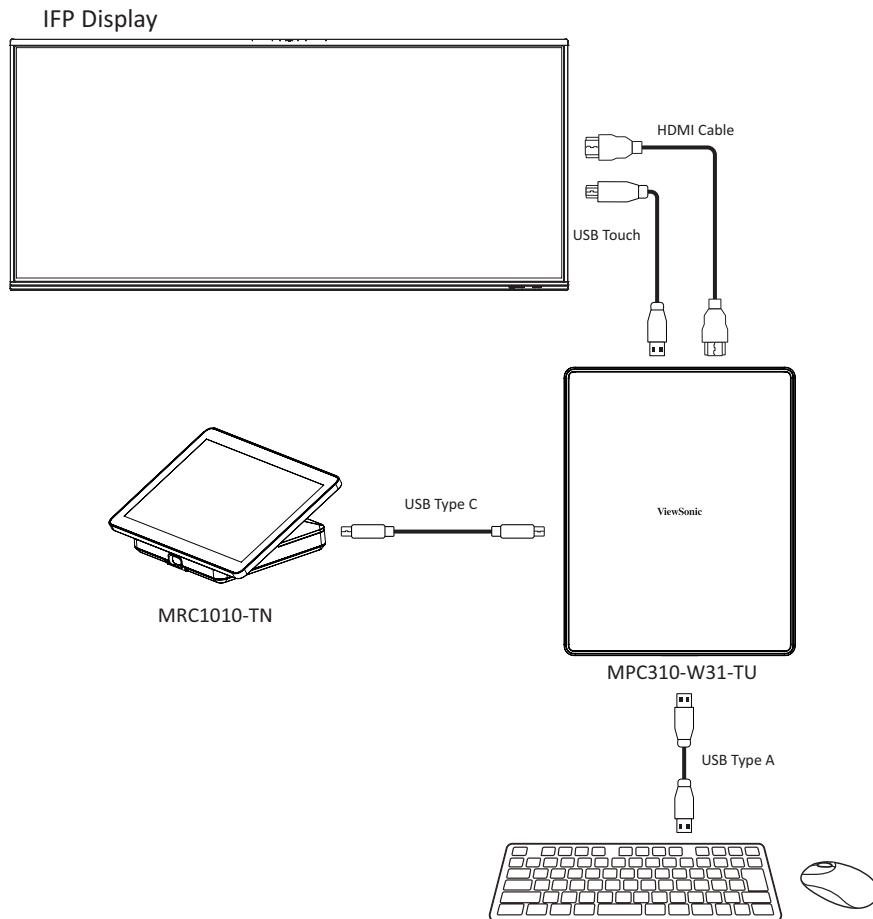

NOTE: Before starting, make sure a keyboard is connected to the Conference PC.

1. On the Touch Console, select **More and then **Settings**.**

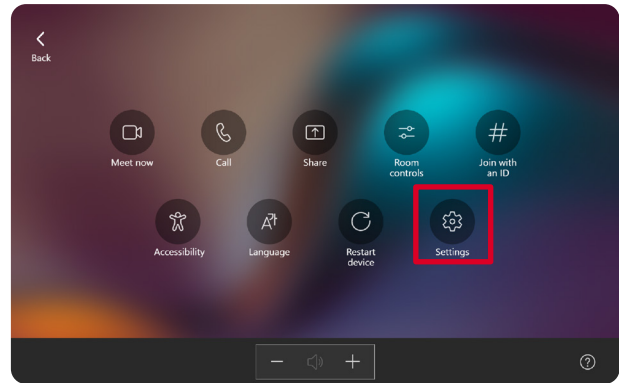
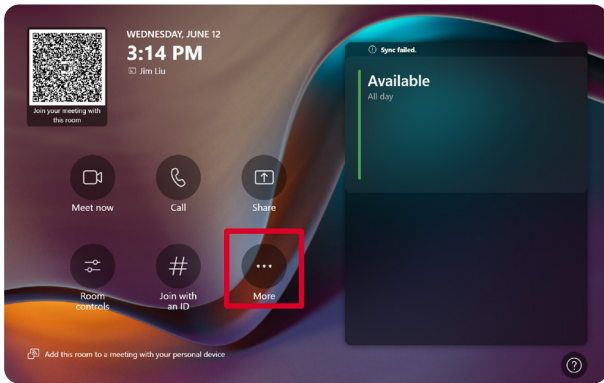

2. Enter the Administrator password “sfb” and select **Windows Settings** and **Go to Admin Sign-in**.

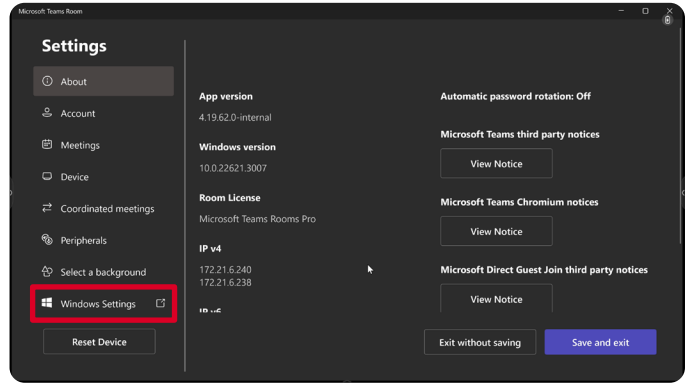
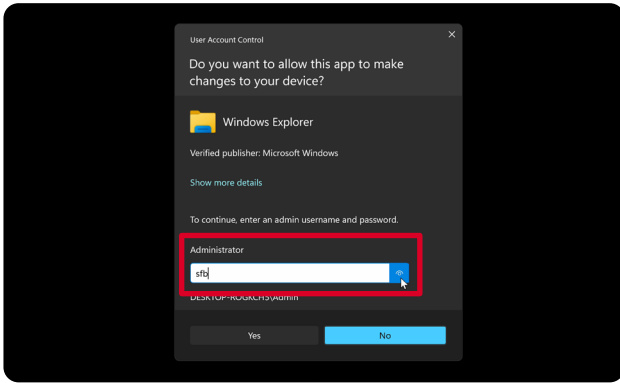

3. The MTR computer will log out of MTR and the Windows 11 login screen will be presented. Select the Administrator account and enter the password “sfb”.

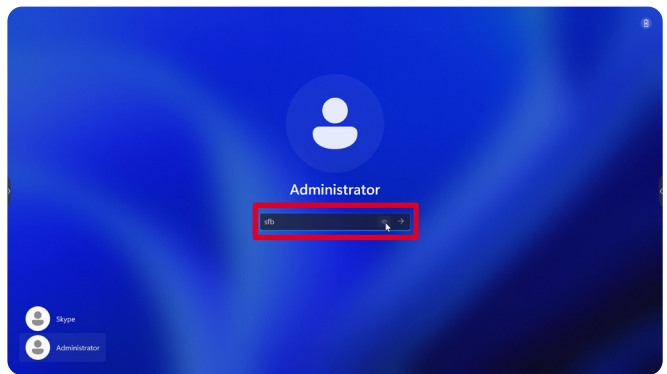
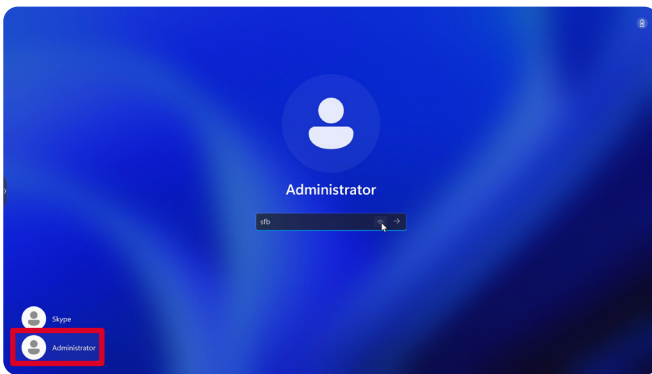

4. In the Search Box on the Windows Task Bar, search for and open “Calibrate the screen for pen or touch input”.

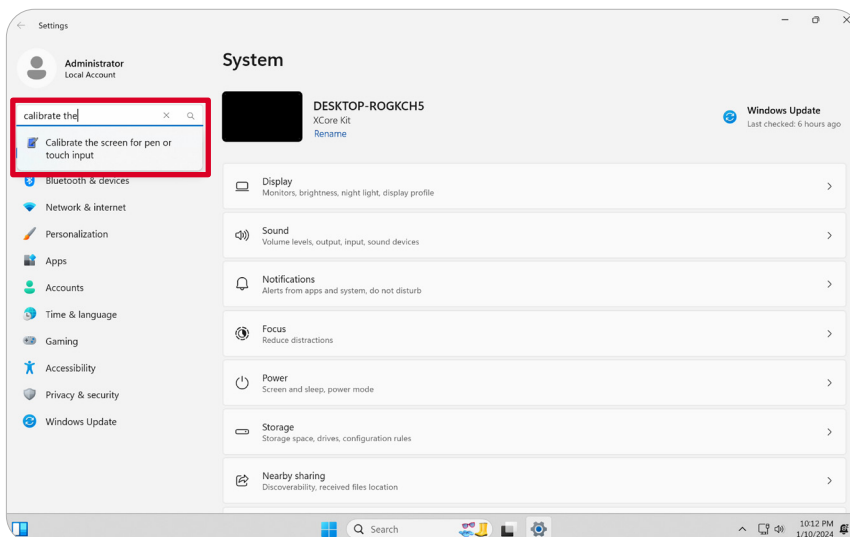

5. In Tablet PC Settings under Display Options select the connected display. Then, under Configure, click **Setup** and select **Touch Input** in the pop-up window.

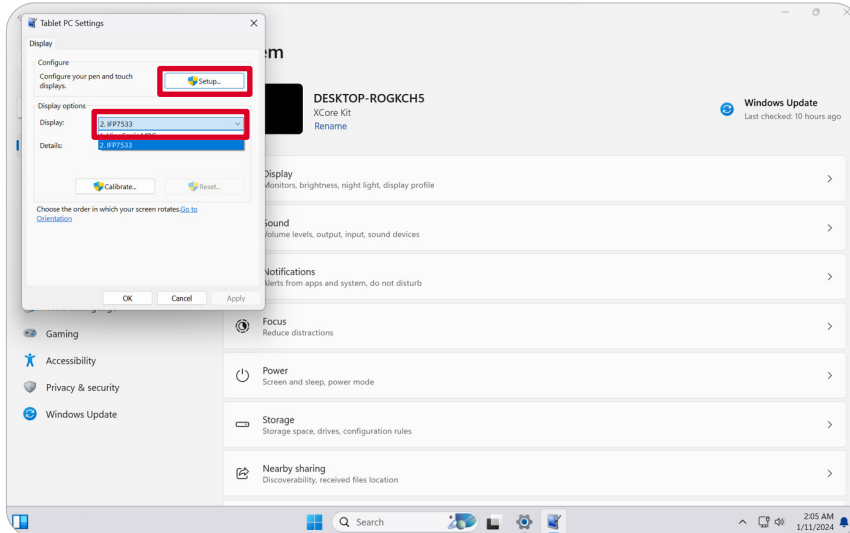

6. A message will appear on each display's screen (e.g., IFP display and MRC1010-TN) one at a time instructing you to tap the screen with a single finger to identify it as the touchscreen. Tap the screen displaying this message with your finger as instructed, and press Enter on the connected keyboard to proceed.

NOTE: This step will first set up the IFP display side and then set up the MRC1010-TN side, refer to the same setting screen as below.

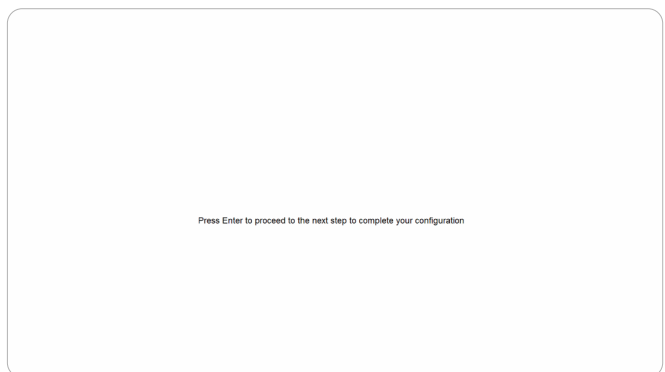
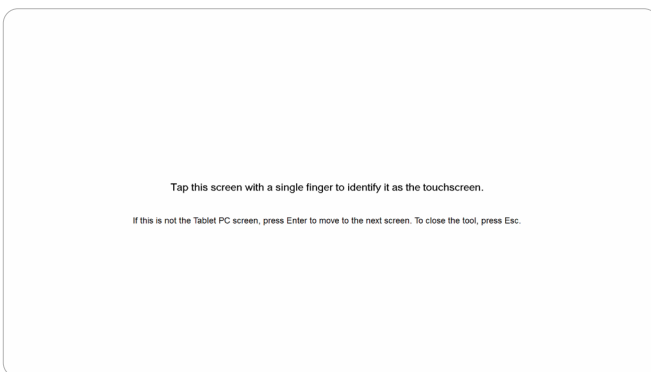

7. Repeat this for all interactive displays, including the IFP display and the MRC1010-TN Touch console.

NOTE: If any non-interactive displays are being used, press Enter on the connected keyboard to skip.

SKU Overview

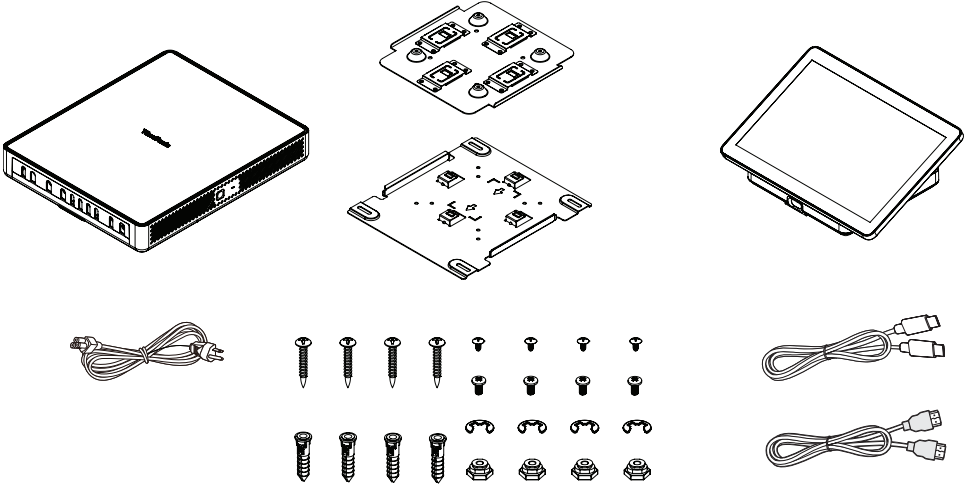
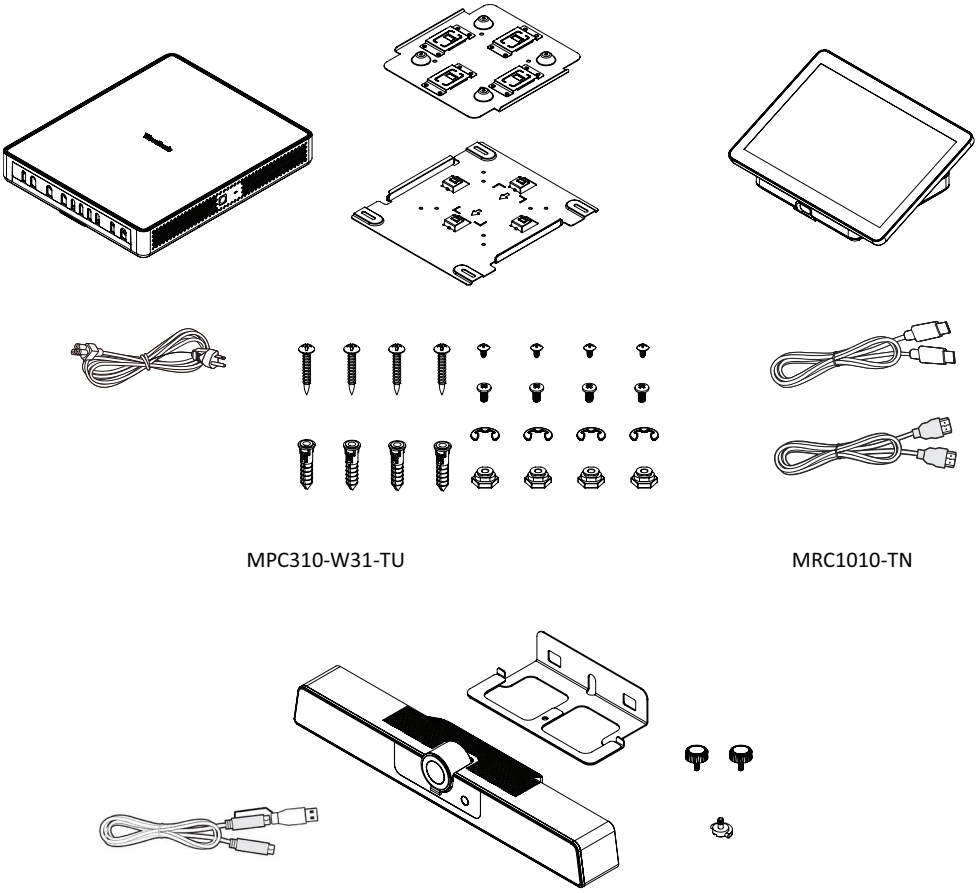
SKU	Items
<p><u>TRS10 (2 in 1)</u></p> <ul style="list-style-type: none"> • MPC310-W31-TU • MRC1010-TN 	 <p>MPC310-W31-TU</p> <p>MRC1010-TN</p>
<p><u>TRS10-UB (3 in 1)</u></p> <ul style="list-style-type: none"> • MPC310-W31-TU • MRC1010-TN • UMB202 	 <p>MPC310-W31-TU</p> <p>MRC1010-TN</p> <p>UMB202</p>

Conference Room Type

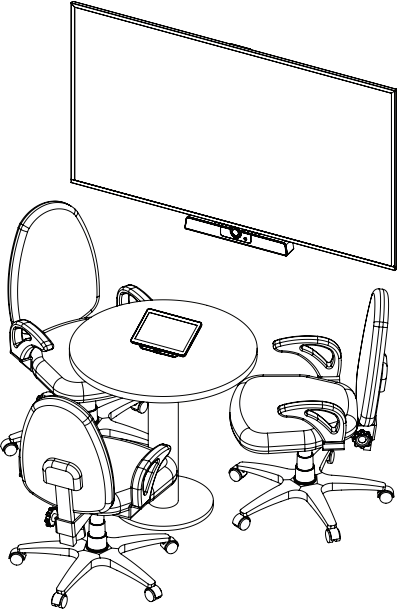
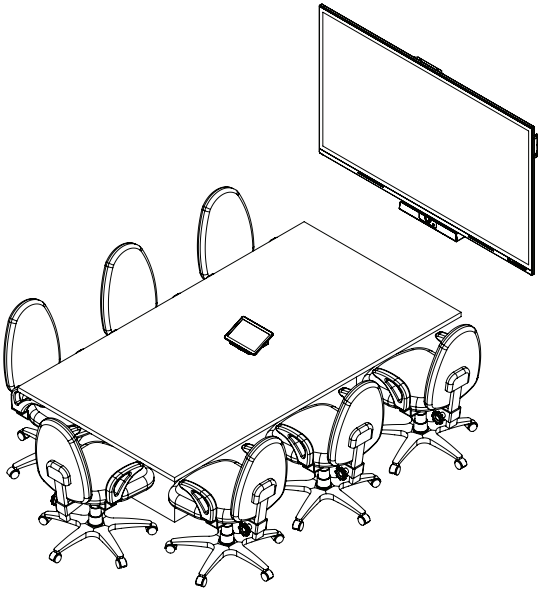
Room Type	Scenario
<p><u>Focus Room</u></p> <ul style="list-style-type: none">• CDE30 Series• MPC310-W31-TU• MRC1010-TN• UMB202	
<p><u>Small Room</u></p> <ul style="list-style-type: none">• IFP62 Series• MPC310-W31-TU• MRC1010-TN• UMB202	

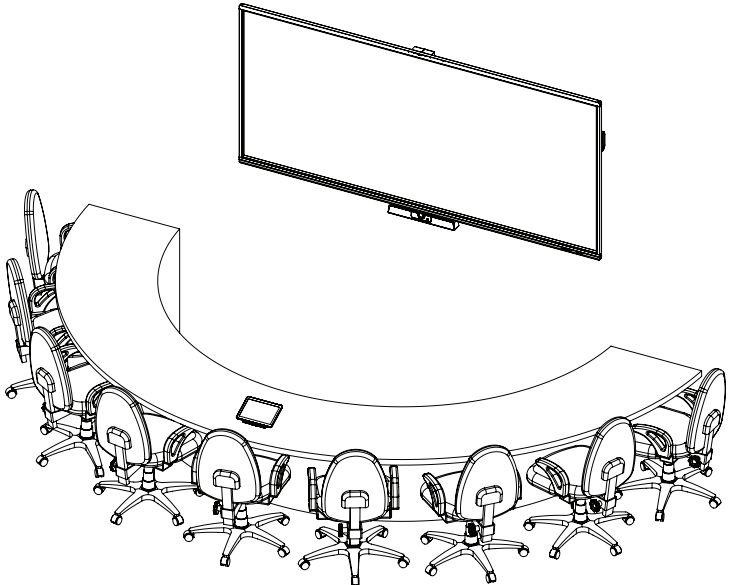
Room Type	Scenario
<p><u>Signature Room</u></p> <ul style="list-style-type: none">• 21:9 UltraWide series• MPC310-W31-TU• MRC1010-TN• UMB202	 A line drawing of a curved conference table with several office chairs around it, and a large whiteboard mounted on the wall above the table.

Appendix

Specifications

MPC310-W31-TU

Category	Item	Specifications
Core	CPU	Intel® Core™ i3-1220P 1.5 GHz Turbo boost 4.4 GHz
Graphic	Chipset	Integrated Intel® UHD Graphics Total Available Graphics Memory: 32 GB Max Resolution: up to 3840 x 2160 @ 30 Hz (DP)
Memory	Slot Type Size	260-pin DDR4 SO-DIMM x 2 (8 GB)
	Memory	4GB: Major Brand Kingston, DDR4 4GB CBD32D4S2S1KC-4 3200M SAMSUNG, DDR4 4GB M471A5244CB0-CWE 3200M
I/O	Ports	4 x USB 3.0 Type A
		1 x USB Type C (DP Out, 4K @ 30 Hz; USB 3.0, USB 2.0; 20V/1A PD)
		1 x RJ45 (10 M/100 M/1000 M)
		1 x Audio Combo Jack
		1 x HDMI Out (supports multiple displays; CEC control - screen power on/off) Maximum output resolution: 16:9: 3840 x 2160 @ 60 Hz 21:9: 3440 x 1440 @ 30 Hz
Acoustic	System Acoustic	≤ 35 db
Compatibility	Picture (Paint)	JPG, JPEG, JPE, JFIF, BMP, DIB, PNG, GIF, TIF, TIFF
	Video (Windows Media Player)	ASF, WMA, WMV, WM, ASX, WAX, WVX, WMX, WPL, WMD, AVI, MPG, MPEG, M1V, MP2, MP3, MPA, MPE, M3U
	Audio (Windows Media Player)	MID, MIDI, RMI, AIF, AIFC, AIFF, WAV, CDA
Software	Bundled Software	Microsoft Teams Rooms
Physical	Dimensions (mm)	275.5 x 230 x 43 mm
	Dimensions (in.)	10.85" x 9.06" x 1.69"
	Weight (kg)	1.86 kg
	Weight (lbs)	4.10 lbs

Category	Item	Specifications
Operating Conditions	Altitude	0~3,048 m
		10,000 ft
	Relative Humidity	10%~90% (non-condensing)
	Temperature	-10°C~40°C
(14°F~104°F)		
Storage Conditions	Altitude	0~12,192 m
		40,000 ft
	Relative Humidity	10%~90% (non-condensing)
	Temperature	-20°C~60°C
(-4°F~140°F)		
Power	Input Voltage	AC 100-240V, 1.5A, 50/60Hz
	Rating Consumption	Min 15.6W (start device) Max 90W (full loading)
	Standby Consumption	1.5W
Antenna	Antenna Type	Dipole
	Manufacturer	Guangzhou ShiHan
	Model Name	004.032.0052699
	Antenna Gain	3.28 dbi
	EIRP Max Power	8.79 mW (module with antenna)
	Connector Type	I-PEX

MRC1010-TN

Category	Item	Specifications
Panel	Type	10.1" ELED display LCD panel: LLZZN101111810
	Resolution	1920 x 1200
	Color Depth	8-bit color depth
	Brightness	with glass(typical): 250 cd/m ² ~300 cd/m ²
	Contrast	Minimum: 800:1 Typical: 1000:1
	Touch Panel	PCT10 points touch supported
	Surface Treatment	AG + AF
	Accuracy	Middle: ± 1 mm Edge: ≤ 2.5 mm
	Viewing Angle	Minimum: 75° Typical: 85° (CR ≥ 10)
	Response Time (GTG)	< 25 ms
Sensor	Motion Sensor	1 x PIR (Supports 24/7 continuous working when screen is off)
I/O	Ports	1 x USB 2.0 Type A
		1 x USB Type C (DP In 1.2 RX, USB 3.0: HDMI signal, USB 2.0: Touch signal)
		1 x HDMI Ingest
		1 x 3.5 mm interface (speakers that support LINE IN)
Physical	Dimensions (mm)	245 x 160 x 98 mm
	Dimensions (in.)	9.65" x 6.3" x 3.85"
	Weight (kg)	0.93 kg
	Weight (lbs)	2.05 lbs
Operating Conditions	Relative Humidity	10%~90% (non-condensing)
	Temperature	0°C~40°C 32°F~104°F
Storage Conditions	Relative Humidity	10%~90% (non-condensing)
	Temperature	-20°C~60°C -4°F~140°F
Power	Input Voltage	20Vdc/1.0A (via USB Type C)
	Power Consumption	20W (via USB Type C)

Troubleshooting

This section describes some common problems that you may experience when using the Microsoft Teams Rooms solution (MPC310-W31-TU/MRC1010-TN). If a problem persists, please contact your reseller.

Problem or Issue	Possible Solutions
The Teams rooms solution(MPC310-W31-TU/ MRC1010-TN) won't start.	<ul style="list-style-type: none">• If the MPC310-W31-TU Conferencing PC LED does not light blue during boot up, please verify that the AC power cord is properly plugged into the AC IN port of the MPC310-W31-TU Conferencing PC and to the power outlet.• Verify that the AC power cord is fully inserted into the correct socket on the front of the Conferencing PC side.• Check the power outlet with another device (e.g., a table lamp).• If there is still no power, contact ViewSonic support or the reseller from whom the device was purchased.
Unable to access the Local Area Network (LAN).	<ul style="list-style-type: none">• Verify that the RJ-45 cable is connected properly:<ul style="list-style-type: none">» One end to the LAN port of the MPC310-W31-TU Conferencing PC.» The other end to a network connected device or a network wall connector.• Make sure you have configured the LAN settings correctly.
No video output to the IFP display.	Verify that the HDMI cable has been plugged in properly into the IFP display's HDMI outlet.
Unable to display to the MRC1010-TN Touch console.	Verify that the USB Type C cable (Power delivery) has been plugged in properly into the MPC310-W31-TU Conferencing PC and MRC1010-TN Touch console USB Type C outlet.

Problem or Issue	Possible Solutions
<p>How to Switch between the MTR account and the administrator account.</p>	<p>To switch from the MTR account to the administrator account:</p> <ol style="list-style-type: none"> 1. Go to the MTR settings page. 2. Select Windows Settings. 3. Select Administrator and enter the administrator password, "sfb". <p>To switch from the administrator account to the MTR account:</p> <ol style="list-style-type: none"> 1. Open the Start menu. 2. Select Administrator > Sign out. 3. Select Skype > Sign in.
<p>How to set HDMI out resolution and refresh rate settings for 16:9 & 21:9 displays.</p>	<p>Switch from the MTR account to the administrator account:</p> <ol style="list-style-type: none"> 1. Go to the MTR settings page. 2. Select Windows Settings. 3. Select Administrator and enter the administrator password, "sfb". <p><u>IFP62 Series: 16:9, 3840 x 2160 @ 60 Hz</u></p> <ol style="list-style-type: none"> 1. Go to: System > Display > Scale & layout > Display Resolution > 3840 x 2160 2. Go to: System > Display > Related settings > Advanced display > Choose a refresh rate > 60 Hz <p><u>IFP105: 21:9, 3440 x 1440 @ 30 Hz</u></p> <ol style="list-style-type: none"> 1. Go to: System > Display > Scale & layout > Display Resolution > 3440 x 1440. 2. Go to: System > Display > Related settings > Advanced display > Choose a refresh rate > 29.97 Hz

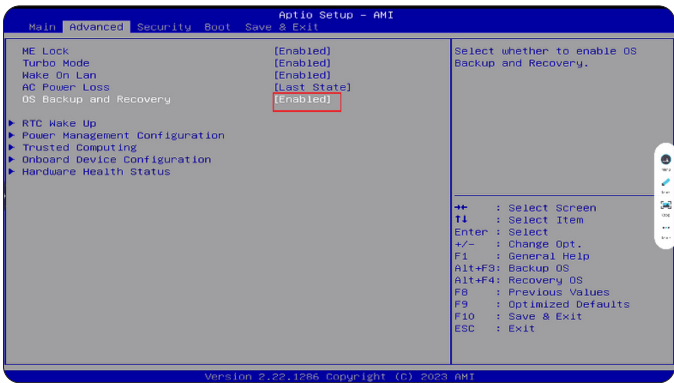
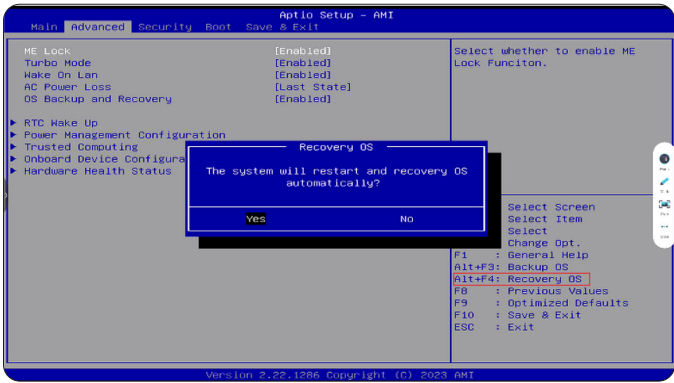
Problem or Issue	Possible Solutions
<p>MRC1010-TN Touch console built-in PIR sensor wake-up setting.</p>	<p>Switch from the MTR account to the administrator account:</p> <ol style="list-style-type: none"> 1. Go to the MTR settings page. 2. Select Windows Settings. 3. Select Administrator and enter the administrator password, "sfb". 4. In the Search Box on the Windows Task Bar, search for and open Device Manager. 5. In Device Manager, select: Sensors > HID Human Presence Sensor Properties > Power Management. 6. Select the checkbox next to "Allow this device to wake the computer".
<p>How to restore the MTR system to original factory settings.</p>	<ol style="list-style-type: none"> 1. Connect a keyboard to the MPC310-W31-TU and power it on. 2. Press F2 on the keyboard to enter the BIOS. 3. Go to: Advanced > OS Backup and Recovery > select [Enabled]  <ol style="list-style-type: none"> 4. Press Alt + F4 on the keyboard. In the Recovery OS dialogue box select Yes. 

Regulatory and Service Information

Compliance Information

This section addresses all connected requirements and statements regarding regulations. Confirmed corresponding applications shall refer to nameplate labels and relevant markings on the unit.

FCC Compliance Statement

Contains FCC ID: TX2-RTL8852BE

This device complies with part 15 of FCC Rules. Operation is subject to the following two conditions: (1) this device may not cause harmful interference, and (2) this device must accept any interference received, including interference that may cause undesired operation. This equipment has been tested and found to comply with the limits for a Class B digital device, pursuant to part 15 of the FCC Rules.

These limits are designed to provide reasonable protection against harmful interference in a residential installation. This equipment generates, uses, and can radiate radio frequency energy, and if not installed and used in accordance with the instructions, may cause harmful interference to radio communications. However, there is no guarantee that interference will not occur in a particular installation. If this equipment does cause harmful interference to radio or television reception, which can be determined by turning the equipment off and on, the user is encouraged to try to correct the interference by one or more of the following measures:

- Reorient or relocate the receiving antenna.
- Increase the separation between the equipment and receiver.
- Connect the equipment into an outlet on a circuit different from that to which the receiver is connected.
- Consult the dealer or an experienced radio/TV technician for help.

FCC Radiation Exposure Statement

This device complies with FCC: radiation exposure limits set forth for an uncontrolled environment. End users must follow the specific operating instructions for satisfying RF exposure compliance.

This transmitter must not be co-located or operating in conjunction with any other antenna or transmitter. This device should be installed and operated with a minimum distance of 20 centimeters between the radiator and your body.

The user manual or instruction manual for an intentional or unintentional radiator shall caution the user that changes or modifications not expressly approved by the Party responsible for compliance could void the user's authority to operate the equipment.

Industry Canada Statement

Contains IC ID: 6317A-RTL8852BE

CAN ICES (B) / NMB (B)

This Class B digital apparatus complies with Canadian ICES-003.

Cet appareil numérique de la classe B est conforme à la norme NMB-003 du Canada.

This device complies with Industry Canada license-exempt RSS standard(s): Operation is subject to the following Two conditions:(1) this device may not cause interference, and (2) this device must accept any interference, including interference that may cause undesired operation of the device.

Le présent appareil est conforme aux CNR d'Industrie Canada applicables aux appareils radio exempts de licence. L'exploitation est autorisée aux deux conditions suivantes : (1) l'appareil ne doit pas produire de brouillage, et (2) l'utilisateur de l'appareil doit accepter tout brouillage radioélectrique subi, même si le brouillage est susceptible d'en compromettre le fonctionnement.

Country Code Statement

For product available in the USA/Canada market, only channel 1~11 can be operated. Selection of other channels is not possible.

Pour les produits disponibles aux États-Unis/Canada du marché, seul le canal 1 à 11 peuvent être exploités. Sélection d'autres canaux n'est pas possible.

IC Radiation Exposure Statement

This device complied with IC RSS-102 radiation exposure limits set forth for an uncontrolled environment. This device should be installed and operated with minimum distance 20 cm between the radiator & your body.

Cet équipement est conforme aux limites d'exposition aux rayonnements IC établies pour un environnement non contrôlé. Cet équipement doit être installé et utilisé avec un minimum de 20cm de distance entre la source de rayonnement et votre corps.

Caution:

- (i) The device for operation in the band 5150-5250 MHz is only for indoor use to reduce the potential for harmful interference to co-channel mobile satellite systems;
- (ii) for devices with detachable antenna(s), the maximum antenna gain permitted for devices in the bands 5250-5350 MHz and 5470-5725 MHz shall be such that the equipment still complies with the e.i.r.p. limit;
- (iii) for devices with detachable antenna(s), the maximum antenna gain permitted for devices in the band 5725-5850 MHz shall be such that the equipment still complies with the e.i.r.p. limits as appropriate

CE Conformity for European Countries



The device complies with the EMC Directive 2014/30/EU, Low Voltage Directive 2014/35/EU and Radio Equipment Directive 2014/53/EU.

https://www.viewsonicglobal.com/public/products_download/safety_compliance/acc/VS19796_CE_DoC.pdf

The following information is only for EU-member states:

The mark shown to the right is in compliance with the Waste Electrical and Electronic Equipment Directive 2012/19/EU (WEEE). The mark indicates the requirement NOT to dispose of the equipment as unsorted municipal waste, but use the return and collection systems according to local law.



Batteries may not be disposed in trash or household recycling collection bins intended to receive other non-hazardous waste and/or recyclable materials. Please use the public collection system to return, recycle, or treat them in compliance with the local regulations. This product may contain button batteries, please keep it away from children.

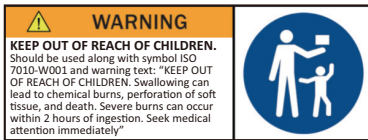

BSMI /NCC Statement

限用物質含有情況標示

依檢驗標準CNS15663之規定將限用物質含有情況標示於商品之本體、包裝、標貼、或說明書。

限用物質含有情況標示請參考下列網址:

VS19796(MPC310-W31-TU,MPC510-W53-TU,MPC710-W75-TU)

https://www.viewsonicglobal.com/public/products_download/safety_compliance/acc/VS19796_BSMI_RoHS.pdf

VS19799(MRC1010-TN)

https://www.viewsonicglobal.com/public/products_download/safety_compliance/acc/VS19799_BSMI_RoHS.pdf

NCC聲明

1. 取得審驗證明之低功率射頻器材, 非經核准, 公司、商號或使用者均不得擅自變更頻率、加大功率或變更原設計之特性及功能。低功率射頻器材之使用不得影響飛航安全及干擾合法通信; 經發現有干擾現象時, 應立即停用, 並改善至無干擾時方得繼續使用。前述合法通信, 指依電信管理法規定作業之無線電通信。低功率射頻器材須忍受合法通信或工業、科學及醫療用電波輻射性電機設備之干擾。
2. 應避免影響附近雷達系統之操作。
3. 高增益指向性天線只得用於固定式點對點系統。

內含發射器模組: RTL8852BE, NCC number: XXXXXXXXXXXXXXXX



廢電池請回收

警告

如果更換不正確之電池型式會有爆炸的風險
請依製造商說明書處理用過之電池

電池不得丟棄在垃圾箱或用於接收其他無害廢物和/或可回收材料的家庭回收收集箱中。請使用公共收集系統返回、回收或依照當地法規處理。

Declaration of RoHS2 Compliance

This product has been designed and manufactured in compliance with Directive 2011/65/EU of the European Parliament and the Council on restriction of the use of certain hazardous substances in electrical and electronic equipment (RoHS2 Directive) and is deemed to comply with the maximum concentration values issued by the European Technical Adaptation Committee (TAC) as shown below:

Substance	Proposed Maximum Concentration	Actual Concentration
Lead (Pb)	0.1%	< 0.1%
Mercury (Hg)	0.1%	< 0.1%
Cadmium (Cd)	0.01%	< 0.01%
Hexavalent Chromium (Cr6 ⁺)	0.1%	< 0.1%
Polybrominated biphenyls (PBB)	0.1%	< 0.1%
Polybrominated diphenyl ethers (PBDE)	0.1%	< 0.1%
Bis(2-ethylhexyl) phthalate (DEHP)	0.1%	< 0.1%
Butyl benzyl phthalate (BBP)	0.1%	< 0.1%
Dibutyl phthalate (DBP)	0.1%	< 0.1%
Diisobutyl phthalate (DIBP)	0.1%	< 0.1%

Certain components of products as stated above are exempted under the Annex III of the RoHS2 Directives as noted below:

- Copper alloy containing up to 4% lead by weight.
- Lead in high melting temperature type solders (i.e. lead-based alloys containing 85% by weight or more lead).
- Electrical and electronic components containing lead in a glass or ceramic other than dielectric ceramic in capacitors, e.g. piezoelectronic devices, or in a glass or ceramic matrix compound.
- Lead in dielectric ceramic in capacitors for a rated voltage of 125V AC or 250V DC or higher.

Indian Restriction of Hazardous Substances

Restriction on Hazardous Substances statement (India). This product complies with the “India E-waste Rule 2011” and prohibits use of lead, mercury, hexavalent chromium, polybrominated biphenyls or polybrominated diphenyl ethers in concentrations exceeding 0.1 weight % and 0.01 weight % for cadmium, except for the exemptions set in Schedule 2 of the Rule.

Product Disposal at End of Product Life

ViewSonic® respects the environment and is committed to working and living green. Thank you for being part of Smarter, Greener Computing. Please visit the ViewSonic® website to learn more.

USA & Canada:

<https://www.viewsonic.com/us/go-green-with-viewsonic>

Europe:

<https://www.viewsonic.com/eu/environmental-social-governance/recycle>

Taiwan:

<https://recycle.moenv.gov.tw/>

For EU users, please contact us for any safety/accident issue experienced with this product:

ViewSonic Europe Limited



Haaksbergweg 75
1101 BR Amsterdam
Netherlands



+31 (0) 650608655



EPREL@viewsoniceurope.com



<https://www.viewsonic.com/eu/>

Copyright Information

Copyright© ViewSonic® Corporation, 2024. All rights reserved.

Macintosh and Power Macintosh are registered trademarks of Apple Inc.

Microsoft, Windows, and the Windows logo are registered trademarks of Microsoft Corporation in the United States and other countries.

ViewSonic® and the three birds logo are registered trademarks of ViewSonic® Corporation.

VESA is a registered trademark of the Video Electronics Standards Association. DPMS, DisplayPort, and DDC are trademarks of VESA.

Disclaimer: ViewSonic® Corporation shall not be liable for technical or editorial errors or omissions contained herein; nor for incidental or consequential damages resulting from furnishing this material, or the performance or use of this product.

In the interest of continuing product improvement, ViewSonic® Corporation reserves the right to change product specifications without notice. Information in this document may change without notice.

No part of this document may be copied, reproduced, or transmitted by any means, for any purpose without prior written permission from ViewSonic® Corporation.

Customer Service

For technical support or product service, see the table below or contact your reseller.

NOTE: You will need the product's serial number.

Country/ Region	Website	Country/ Region	Website
Asia Pacific & Africa			
Australia	www.viewsonic.com/au/	Bangladesh	www.viewsonic.com/bd/
中国 (China)	www.viewsonic.com.cn	香港 (繁體中文)	www.viewsonic.com/hk/
Hong Kong (English)	www.viewsonic.com/hk-en/	India	www.viewsonic.com/in/
Indonesia	www.viewsonic.com/id/	Israel	www.viewsonic.com/il/
日本 (Japan)	www.viewsonic.com/jp/	Korea	www.viewsonic.com/kr/
Malaysia	www.viewsonic.com/my/	Middle East	www.viewsonic.com/me/
Myanmar	www.viewsonic.com/mm/	Nepal	www.viewsonic.com/np/
New Zealand	www.viewsonic.com/nz/	Pakistan	www.viewsonic.com/pk/
Philippines	www.viewsonic.com/ph/	Singapore	www.viewsonic.com/sg/
臺灣 (Taiwan)	www.viewsonic.com/tw/	ประเทศไทย	www.viewsonic.com/th/
Việt Nam	www.viewsonic.com/vn/	South Africa & Mauritius	www.viewsonic.com/za/
Americas			
United States	www.viewsonic.com/us	Canada	www.viewsonic.com/us
Latin America	www.viewsonic.com/la		
Europe			
Europe	www.viewsonic.com/eu/	France	www.viewsonic.com/fr/
Deutschland	www.viewsonic.com/de/	Қазақстан	www.viewsonic.com/kz/
Россия	www.viewsonic.com/ru/	España	www.viewsonic.com/es/
Türkiye	www.viewsonic.com/tr/	Україна	www.viewsonic.com/ua/
United Kingdom	www.viewsonic.com/uk/		



ViewSonic®